

THE
ENCYCLOPÆDIA BRITANNICA

ELEVENTH EDITION

FIRST	edition, published in three	volumes,	1768—1771.
SECOND	” ” ten	”	1777—1784.
THIRD	” ” eighteen	”	1788—1797.
FOURTH	” ” twenty	”	1801—1810.
FIFTH	” ” twenty	”	1815—1817.
SIXTH	” ” twenty	”	1823—1824.
SEVENTH	” ” twenty-one	”	1830—1842.
EIGHTH	” ” twenty-two	”	1853—1860.
NINTH	” ” twenty-five	”	1875—1889.
TENTH	” ninth edition and eleven supplementary volumes,		1902—1903.
ELEVENTH	” published in twenty-nine volumes,		1910—1911.

COPYRIGHT
in all countries subscribing to the
Bern Convention
by
THE CHANCELLOR, MASTERS AND SCHOLARS
of the
UNIVERSITY OF CAMBRIDGE

All rights reserved

THE
ENCYCLOPÆDIA BRITANNICA

A

DICTIONARY

OF

ARTS, SCIENCES, LITERATURE AND GENERAL
INFORMATION

ELEVENTH EDITION

VOLUME III

AUSTRIA LOWER to BISECTRIX

New York

Encyclopædia Britannica, Inc.

342 Madison Avenue

Copyright, in the United States of America, 1910,

by

The Encyclopædia Britannica Company.

INITIALS USED IN VOLUME III. TO IDENTIFY INDIVIDUAL
CONTRIBUTORS,¹ WITH THE HEADINGS OF THE
ARTICLES IN THIS VOLUME SO SIGNED.

A. C. P.	ANNA C. PAUES, PH.D. Lecturer in Germanic Philology at Newnham College, Cambridge. Formerly Fellow of Newnham College. Author of <i>A Fourteenth Century Biblical Version</i> ; &c.	Bible, English.
A. C. S.	ALGERNON CHARLES SWINBURNE. See biographical article: SWINBURNE, ALGERNON C.	Beaumont and Melville.
A. F. P.	ALBERT FREDERICK POLLARD, M.A., F.R.HIST.SOC. Professor of English History in the University of London. Fellow of All Souls' College, Oxford. Assistant Editor of the <i>Dictionary of National Biography</i> , 1893-1901. Lothian prizeman (Oxford), 1892; Arnold prizeman, 1898. Author of <i>England under the Protector Somerset</i> ; <i>Henry VIII.</i> ; <i>Life of Thomas Cranmer</i> ; &c.	Balnaves; Barnes, Robert; Bilney.
A. G.*	REV. ALEXANDER GORDON, M.A. Lecturer on Church History in the University of Manchester.	Beza.
A. G. G.	SIR ALFRED GEORGE GREENHILL, M.A., F.R.S. Formerly Professor of Mathematics in the Ordnance College, Woolwich. Author of <i>Differential and Integral Calculus with Applications</i> ; <i>Hydrostatics</i> ; <i>Notes on Dynamics</i> ; &c.	Ballistics.
A. HI.	ARTHUR HASSALL, M. A. Student and Tutor of Christ Church, Oxford. Author of <i>A Handbook of European History</i> ; <i>The Balance of Power</i> ; &c. Editor of the 3rd edition of T. H. Dyer's <i>History of Modern Europe</i> .	Austria-Hungary: <i>History (in part)</i> .
A. H. N.	ALBERT HENRY NEWMAN, LL.D., D.D. Professor of Church History, Baylor University, Texas. Professor at McMaster University, Toronto, 1881-1901. Author of <i>The Baptist Churches in the United States</i> ; <i>Manual of Church History</i> ; <i>A Century of Baptist Achievement</i> .	Baptists: <i>American</i> .
A. H.-S.	SIR A. HOUTUM-SCHINDLER, C.I.E. General in the Persian Army. Author of <i>Eastern Persian Irak</i> .	Azerbāijān; Bakhtiari; Bander Abbās; Barfurush.
A. H. S.	REV. ARCHIBALD HENRY SAYCE, D.LITT., LL.D. See the biographical article: SAYCE, A. H.	Babylon; Babylonia and Assyria; Belshazzar; Berossus.
A. J. L.	ANDREW JACKSON LAMOUREUX. Librarian, College of Agriculture, Cornell University. Editor of the <i>Rio News</i> (Rio de Janeiro), 1879-1901.	Bahia: <i>State</i> ; Bahia: <i>City</i> .
A. L.	ANDREW LANG. See the biographical article: LANG, ANDREW.	Ballads.
A. N.	ALFRED NEWTON, F.R.S. See the biographical article: NEWTON, ALFRED.	Birds of Paradise.
A. P. H.	ALFRED PETER HILLIER, M.D., M.P. President, South African Medical Congress, 1893. Author of <i>South African Studies</i> ; &c. Served in Kaffir War, 1878-1879. Partner with Dr L. S. Jameson in medical practice in South Africa till 1896. Member of Reform Committee, Johannesburg, and Political Prisoner at Pretoria, 1895-1896. M.P. for Hitchin division of Herts, 1910.	Basutoland: <i>History (in part)</i> ; Bechuanaland (<i>in part</i>).
A. Sp.	ARCHIBALD SHARP. Consulting Engineer and Chartered Patent Agent.	Bicycle.
A. St H. G.	ALFRED ST HILL GIBBONS. Major, East Yorkshire Regiment. Explorer in South Central Africa. Author of <i>Africa from South to North through Marotseland</i> .	Barotse, Barotseland.
A. W.*	ARTHUR WILLEY, F.R.S., D.S.C. Director of Colombo Museum, Ceylon.	Balanoglossus.
A. W. H.*	ARTHUR WILLIAM HOLLAND. Formerly Scholar of St John's College, Oxford. Bacon Scholar of Gray's Inn, 1900.	Austria-Hungary: <i>History (in part)</i> ; Bavaria: <i>History (in part)</i> .

¹ A complete list, showing all individual contributors, appears in the final volume.

- A. W. Po.** ALFRED WILLIAM POLLARD, M.A.
Assistant Keeper of Printed Books, British Museum. Fellow of King's College, London. Hon. Secretary Bibliographical Society. Editor of *Books about Books*; and *Bibliographica*. Joint-editor of the *Library*. Chief Editor of the "Globe" *Chaucer*. { Bibliography and Bibliology.
- B. K.** PRINCE BOJDAR KARAGEORGEVITCH (d. 1908).
Artist, art critic, designer and goldsmith. Contributor to the Paris *Figaro*, the *Magazine of Art*, &c. Author of *Enchanted India*. Translator of the works of Tolstoy and Jokai, &c. { Bashkirtseff.
- C.** THE EARL OF CREWE, K.G., F.S.A.
See the biographical article: CREWE, 1ST EARL OF. { Banville.
- C. A. C.** CHARLES ARTHUR CONANT.
Member of Commission on International Exchange of U.S., 1903. Treasurer, MORTON TRUST Co., New York, 1902-1906. Author of *History of Modern Banks of Issue*; *The Principles of Money and Banking*; &c. { Banks and Banking: American.
- C. B.*** CHARLES BÉMONT, D. ÈS L., LITT.D. (OXON).
See the biographical article: BÉMONT, C. { Baluze; Béarn.
- C. F. A.** CHARLES FRANCIS ATKINSON.
Formerly Scholar of Queen's College, Oxford. Captain, 1st City of London (Royal Fusiliers). Author of *The Wilderness and Cold Harbour*. { Austrian Succession War: Military.
- C. F. B.** CHARLES FRANCIS BASTABLE, M.A., LL.D.
Regius Professor of Laws and Professor of Political Economy in the University of Dublin. Author of *Public Finance*; *Commerce of Nations*; *Theory of International Trade*; &c. { Bimetallism.
- C. H. T.** CUTHBERT HAMILTON TURNER, M.A.
Fellow of Magdalen College, Oxford; Fellow of the British Academy. Speaker's Lecturer in Biblical Studies in the University of Oxford, 1906-1909. First Editor of the *Journal of Theological Studies*, 1899-1902. Author of "Chronology of the New Testament," and "Greek Patristic Commentaries on the Pauline Epistles" in *Hastings' Dictionary of the Bible*, &c. { Bible: New Testament Chronology.
- C. H. W. J.** REV. CLAUDE HERMANN WALTER JOHNS, M.A., LITT.D.
Master of St Catharine's College, Cambridge. Lecturer in Assyriology, Queens' College, Cambridge, and King's College, London. Author of *Assyrian Deeds and Documents of the 7th Century B.C.*; *The Oldest Code of Laws*; *Babylonian and Assyrian Laws*; *Contracts and Letters*; &c. { Babylonian Law.
- C. J. L.** SIR CHARLES JAMES LYALL, K.C.S.I., C.I.E., LL.D. (Edin.).
Secretary, Judicial and Public Department, India Office. Fellow of King's College, London. Secretary to Government of India in Home Department, 1889-1894. Chief Commissioner, Central Provinces, India, 1895-1898. Author of *Translations of Ancient Arabic Poetry*; &c. { Bihārī Lāl.
- C. MI.** CHEDOMILLE MIJATOVICH.
Senator of the Kingdom of Servia. Envoy Extraordinary and Minister Plenipotentiary of the King of Servia to the Court of St James's, 1895-1900, and 1902-1903. { Belgrade.
- C. PL.** REV. CHARLES PLUMMER, M.A.
Fellow and Chaplain of Corpus Christi College, Oxford. Ford's Lecturer, 1901. Author of *Life and Times of Alfred the Great*; &c. { Bede.
- C. R. B.** CHARLES RAYMOND BEAZLEY, M.A., D.LITT., F.R.G.S., F.R.HIST.S.
Professor of Modern History in the University of Birmingham. Formerly Fellow of Merton College, Oxford, and University Lecturer in the History of Geography. Lothian prizeman (Oxford), 1889. Lowell Lecturer, Boston, 1908. Author of *Henry the Navigator*; *The Dawn of Modern Geography*; &c. { Beatus; Behaim.
- C. W. W.** SIR CHARLES WILLIAM WILSON, K.C.B., K.C.M.G., F.R.S. (1836-1907).
Major-General, Royal Engineers. Secretary to the North American Boundary Commission, 1858-1862. British Commissioner on the Servian Boundary Commission. Director-General of the Ordnance Survey, 1886-1894. Director-General of Military Education, 1895-1898. Author of *From Kortli to Khartoum*; *Life of Lord Clive*; &c. { Beirut (in part).
- D. B. Ma.** DUNCAN BLACK MACDONALD, D.D.
Professor of Semitic Languages, Hartford Theological Seminary, U.S.A. { Balram.
- D. C. B.** DEMETRIUS CHARLES BOULGER.
Author of *England and Russia in Central Asia*; *History of China*; *Life of Gordon*; *India in the 19th Century*; *History of Belgium*; *Belgian Life in Town and Country*; &c. { Belgium: Geography and Statistics.
- D. F. T.** DONALD FRANCIS TOVEY.
Balliol College, Oxford. Author of *Essays in Musical Analysis*—comprising *The Classical Concerto*, *The Goldberg Variations*, and analyses of many other classical works. { Bach, J. S.; Beethoven.
- D. G. H.** DAVID GEORGE HOGARTH, M.A.
Keeper of the Ashmolean Museum, Oxford. Fellow of Magdalen College, Oxford. Fellow of the British Academy. Excavated at Paphos, 1888; Naukratis, 1890 and 1903; Ephesus, 1904-1905; Assiut, 1906-1907. Director, British School at Athens, 1897-1900; Director, Cretan Exploration Fund, 1899. { Baalbek; Barea; Beirut (in part); Bengazi.
- D. H.** DAVID HANNAY.
Formerly British Vice-Consul at Barcelona. Author of *Short History of Royal Navy, 1217-1688*; *Life of Emilio Castelar*; &c. { Austrian Succession War: Naval; Avilés; Bainbridge, William; Barbary Pirates.

INITIALS AND HEADINGS OF ARTICLES

vii

- D. Mn.** REV. DUGALD MACFADYEN, M.A.
Minister of South Grove Congregational Church, Highgate. Director of the London Missionary Society. } **Berry, Charles Albert.**
- D. S. M.*** DAVID SAMUEL MARGOLIOUTH, M.A., D.LITT.
Laudian Professor of Arabic, Oxford; Fellow of New College. Author of *Arabic Papyri of the Bodleian Library; Mohammed and the Rise of Islam; Cairo, Jerusalem and Damascus.* } **Axum.**
- D. S.-S.** DAVID SETH-SMITH, F.Z.S.
Curator of Birds to the Zoological Society of London. Formerly President of the Avicultural Society. Author of *Parrakeets; a Practical Handbook to those Species kept in Captivity.* } **Aviary.**
- E. B.** EDWARD BRECK, PH.D.
Formerly Foreign Correspondent of the *New York Herald* and the *New York Times.* Author of *Wilderness Pets.* } **Base-Ball.**
- E. Br.** ERNEST BARKER, M.A.
Fellow and Lecturer of St John's College, Oxford. Formerly Fellow and Tutor of Merton College. Craven Scholar (Oxford), 1895. } **Baldwin I. to IV. of Jerusalem.**
- E. Cl.** EDWARD CLODD.
Vice-President of the Folk-Lore Society. Author of *Story of Primitive Man; Primer of Evolution; Tom Tù Tot; Animism; Pioneers of Evolution* } **Baer.**
- E. C. B.** RIGHT REV. EDWARD CUTHBERT BUTLER, O.S.B., D.LITT. (Dubl).
Abbot of Downside Abbey, Bath. } **Basilian Monks;
Benedict of Nursia;
Benedictines;
St Bernardin of Siena.**
- E. F. S.** EDWARD FAIRBROTHER STRANGE.
Assistant-Keeper, Victoria and Albert Museum, South Kensington. Member of Council, Japan Society. Author of numerous works on art subjects; Joint-editor of Bell's "Cathedral" Series. } **Beardsley, Aubrey Vincent.**
- E. G.** EDMUND GOSSE, LL.D.
See the biographical article: GOSSE, EDMUND. } **Baggesen; Ballade;
Barnfield;
Beaumont, Sir John;
Belgium; Literature;
Biography.**
- E. G. B.** EDWARD GRANVILLE BROWNE, M.A., M.R.C.S., M.R.A.S.
Sir Thomas Adams's Professor of Arabic and Fellow of Pembroke College, Cambridge. Fellow of the British Academy. Author of *A Traveller's Narrative, written to Illustrate the Episode of the Báb; The New History of Mirzá Ali Muhammed the Báb; Literary History of Persia; &c.* } **Babism.**
- E. H. M.** ELLIS HOVELL MINNS, M.A.
Lecturer and Assistant Librarian, and formerly Fellow of Pembroke College, Cambridge. University Lecturer in Palaeography. } **Bastarnae.**
- Ed. M.** EDUARD MEYER, D.LITT. (Oxon.), LL.D., PH.D.
Professor of Ancient History in the University of Berlin. Author of *Geschichte des Alterthums; Geschichte des alten Aegyptens; Die Israeliten und ihre Nachbarstämme; &c.* } **Bactria; Bagoas;
Bahram; Balash;
Behistun.**
- E. Ma.** EDWARD MANSON.
Barrister-at-Law. Joint-editor of *Journal of Comparative Legislation*, Author of *Short View of the Law of Bankruptcy; &c.* } **Bankruptcy: Comparative Law.**
- E. M. T.** SIR EDWARD MAUNDE THOMPSON, G.C.B., D.C.L., LL.D., LITT.D.
Director and Principal Librarian, British Museum, 1888-1909. Fellow of the British Academy. Corresponding Member of the Institute of France and of the Royal Prussian Academy of Sciences. Author of *Handbook of Greek and Latin Palaeography.* Editor of the *Chronicon Angliae, &c.* Joint-editor of *Publications of the Palaeographical Society.* } **Autographs.**
- E. N. S.** E. N. STOCKLEY.
Captain, Royal Engineers. Instructor in Construction at the School of Military Engineering, Chatham. For some time in charge of the Barracks Design Branch of the War Office. } **Barracks.**
- E. Pr.** EDGAR PRESTAGE.
Special Lecturer in Portuguese Literature in the University of Manchester. Comendador, Portuguese Order of S. Thiago. Corresponding Member of Lisbon Royal Academy of Sciences and Lisbon Geographical Society. } **Azurara;
Barros.**
- E. Tn.** REV. ETHELRED LEONARD TAUNTON (d 1907).
Author of *The English Black Monks of St Benedict; History of the Jesuits in England.* } **Baronlus.**
- E. V.** REV. EDMUND VENABLES, M.A., D.D. (1819-1895).
Canon and Precentor of Lincoln. Author of *Episcopal Palaces of England.* } **Basilica (in part).**
- F. C. B.** FRANCIS CRAWFORD BURKITT, M.A., D.D.
Notidian Professor of Divinity, Cambridge. Fellow of the British Academy. Part-editor of *The Four Gospels in Syriac transcribed from the Sinaitic Palimpsest.* Author of *The Gospel History and its Transmission; Early Eastern Christianity; &c.* } **Bible: New Testament, Higher Criticism.**
- F. C. C.** FREDERICK CORNWALLIS CONYBEARE, M.A., D.TH. (Giessen).
Fellow of the British Academy. Formerly Fellow of University College, Oxford. Author of *The Ancient Armenian Texts of Aristotle; Myth, Magic and Morals; &c.* } **Baptism.**

- F. G.** **FREDERICK GREENWOOD.**
See the biographical article: GREENWOOD, FREDERICK. { Beaconsfield, Earl of.
- F. G. M. B.** **FREDERICK GEORGE MEESON BECK, M.A.**
Fellow and Lecturer of Clare College, Cambridge. { Bernicia.
- F. LL. G.** **FRANCIS LLEWELYN GRIFFITH, M.A., PH.D., F.S.A.**
Reader in Egyptology, Oxford. Editor of the *Archaeological Survey* and *Archaeological Reports* of the Egypt Exploration Fund. Fellow of the Imperial German Archaeological Institute. { Bes.
- F. L. L.** **LADY LUGARD.**
See the biographical article: LUGARD, SIR F. J. D. { Bauchi.
- F. P.** **FRANK PODMORE, M.A. (d. 1910).**
Pembroke College, Oxford. Author of *Studies in Psychological Research; Modern Spiritualism; &c.* { Automatic Writing.
- F. R. C.** **FRANK R. CANA.**
Author of *South Africa from the Great Trek to the Union.* { Basutoland (*in part*);
Bahr-el-Ghazal (*in part*);
Bechuanaland (*in part*).
- F. R. M.** **FRANCIS RICHARD MAUNSELL, C.M.G.**
Lieut.-Col., Royal Artillery. Military Vice-Consul, Sivas, Trebizond, Van (Kurdistan), 1897-1898. Military Attaché, British Embassy, Constantinople, 1901-1905. Author of *Central Kurdistan; &c.* { Baiburt;
Bashkala.
- F. W. R.*** **FREDERICK WILLIAM RUDLER, I.S.O., F.G.S.**
Curator and Librarian of the Museum of Practical Geology, London, 1879-1902. President of the Geologists' Association, 1887-1889. { Aventurine;
Beryl.
- G. A. B.** **GEORGE A. BOULENGER, F.R.S., D.Sc., PH.D.**
In charge of the Collections of Reptiles and Fishes, Department of Zoology, British Museum. Vice-President of the Zoological Society of London. { Axoloti;
Batrachia.
- G. A. GR.** **GEORGE ABRAHAM GRIERSON, C.I.E., PH.D. D.LITT. (Dublin).**
Member of the Indian Civil Service, 1873-1903. In charge of Linguistic Survey of India, 1898-1902. Gold Medallist, Asiatic Society, 1909. Vice-President of the Royal Asiatic Society. Formerly Fellow of Calcutta University. Author of *The Languages of India; &c.* { Bengali;
Bihari.
- G. B. B.** **GERARD BALDWIN BROWN, M.A.**
Professor of Fine Arts, University of Edinburgh. Formerly Fellow of Brasenose College, Oxford. Author of *From Schola to Cathedral; The Fine Arts; &c.* { Basilica (*in part*).
- G. B. G.*** **GEORGE BUCHANAN GRAY, M.A., D.D., D.LITT. (Oxon.)**
Professor of Hebrew and Old Testament Exegesis, Mansfield College, Oxford. Examiner in Hebrew, University of Wales. Author of *The Divine Discipline of Israel; &c.* { Bible: Old Testament,
Textual Criticism, and
Higher Criticism.
- G. E.** **REV. GEORGE EDMUNDSON, M.A., F.R.HIST.S.**
Formerly Fellow and Tutor of Brasenose College, Oxford. Ford's Lecturer, 1909. Hon. Member Dutch Historical Society, and Foreign Member, Netherlands Association of Literature. { Belgium: History.
- G. F. Z.** **G. F. ZIMMER, A.M.Inst.C.E.**
Author of *Mechanical Handling of Material.* { Biscuit.
- G. G. S.** **GEORGE GREGORY SMITH, M.A.**
Professor of English Literature, Queen's University, Belfast. Author of *The Days of James IV.; The Transition Period; Specimens of Middle Scots; &c.* { Barbour, John.
- G. H. C.** **GEORGE HERBERT CARPENTER, B.Sc.**
Professor of Zoology in the Royal College of Science, Dublin. President of the Association of Economic Biologists. Member of the Royal Irish Academy. Author of *Insects: their Structure and Life; &c.* { Bee.
- G. Sa.** **GEORGE EDWARD BATEMAN SAINTSBURY, LL.D., D.Litt.**
See the biographical article: SAINTSBURY, G. E. B. { Balzac, H. de.
- G. W. T.** **REV. GRIFFITHS WHEELER THATCHER, M.A., B.D.**
Warden of Camden College, Sydney, N.S.W. Formerly Tutor in Hebrew and Old Testament History at Mansfield College, Oxford. { Avempace; Averroes;
Avicenna; Balāwī;
Balādhuri; Behā ud-Dīn;
Behā ud-Dīn Zuhair;
Bīrūnī.
- H. Br.** **HENRY BRADLEY, M.A., PH.D.**
Joint-editor of the *New English Dictionary* (Oxford). Fellow of the British Academy. Author of *The Story of the Goths; The Making of English; &c.* { Beowulf.
- H. Ch.** **HUGH CHISHOLM, M.A.**
Formerly Scholar of Corpus Christi College, Oxford. Editor of the 11th edition of the *Encyclopaedia Britannica*. Co-editor of the 10th edition. { Balfour, A. J.
- H. C. R.** **SIR HENRY CRESWICKE RAWLINSON, BART., K.C.B.**
See the biographical article: RAWLINSON, SIR H. C. { Bagdad: City.
- H. Fr.** **HENRI FRANTZ.**
Art Critic, *Gazette des Beaux Arts* (Paris). { Barye; Bastien-Lepage;
Baudry, P. J. A.
- H. F. G.** **HANS FRIEDRICH GADOW, F.R.S., PH.D.**
Strickland Curator and Lecturer on Zoology in the University of Cambridge. Author of "Amphibia and Reptiles" in the *Cambridge Natural History*. { Bird.

A. H. H.*	HERBERT HENSLEY HENSON, M.A., D.D. Canon of Westminster Abbey and Rector of St Margaret's, Westminster. Proctor in Convocation since 1902. Formerly Fellow of All Souls' College, Oxford. Select Preacher (Oxford), 1895-1896; (Cambridge), 1901. Author of <i>Apostolic Christianity; Moral Discipline in the Christian Church; The National Church; Christ and the Nation</i> ; &c.	Bible, English: Revised Version.
H. H. J.	SIR HARRY HAMILTON JOHNSTON, D.Sc., G.C.M.G., K.C.B. See the biographical article: JOHNSTON, SIR H. H.	Bantu Languages.
H. M. R.	HUGH MUNRO ROSS. Formerly Exhibitioner of Lincoln College, Oxford. Editor of <i>The Times Engineering Supplement</i> . Author of <i>British Railways</i> .	Bell: House Bell.
H. M. W.	H. MARSHALL WARD, M.A., F.R.S., D.Sc. (d. 1905). Formerly Professor of Botany, Cambridge. President of the British Mycological Society. Author of <i>Timber and some of its Diseases; The Oak; Sach's Lectures on the Physiology of Plants; Grasses; Disease in Plants</i> ; &c.	Bacteriology (in part); Berkeley, Miles Joseph.
H. N. D.	HENRY NEWTON DICKSON, M.A., D.Sc., F.R.G.S. Professor of Geography, University College, Reading. Author of <i>Elementary Meteorology; Papers on Oceanography</i> ; &c.	Baltic Sea.
H. W. C. D.	HENRY WILLIAM CARLESS DAVIS, M.A. Fellow and Tutor of Balliol College, Oxford. Fellow of All Souls', Oxford, 1895-1902. Author of <i>Charlemagne; England under the Normans and Angevins, 1066-1272</i> .	Becket; Benedictus Abbas.
H. W. S.	H. WICKHAM STEED. Correspondent of <i>The Times</i> at Rome (1897-1902) and Vienna.	Austria-Hungary: History (in part); Bertani.
I. A.	ISRAEL ABRAHAMS, M.A. Reader in Talmudic and Rabbinic Literature, University of Cambridge. President, Jewish Historical Society of England. Author of <i>A Short History of Jewish Literature; Jewish Life in the Middle Ages</i> ; &c.	Bahya.
J. AN.	JOSEPH ANDERSON, LL.D. Keeper of the National Museum of Antiquities, Edinburgh, and Assistant Secretary of the Society of Antiquaries of Scotland. Honorary Professor of Antiquities to the Royal Scottish Academy. Author of <i>Scotland in Early Christian and Pagan Times</i> .	Barrow.
J. A. H.	JOHN ALLEN HOWE, B.Sc. Curator and Librarian at the Museum of Practical Geology, London.	Avonian; Bajeolian; Barton Beds; Bathonian Series; Bed: Geology.
J. B. B.	JOHN BAGNELL BURY, LL.D., LITT.D. See the biographical article: BURY, J. B.	Baldwin I. and II.: of Romania; Basil I. and II.: Emperors; Belsarius.
J. D. B.	JAMES DAVID BOURCHIER, M.A., F.R.G.S. King's College, Cambridge. Correspondent of <i>The Times</i> in South-Eastern Europe. Commander of the Orders of Prince Danilo of Montenegro and of the Saviour of Greece, and Officer of the Order of St Alexander of Bulgaria.	Balkan Peninsula.
J. F.-K.	JAMES FITZMAURICE-KELLY, LITT.D., F.R.HIST.S. Gilmour Professor of Spanish Language and Literature, Liverpool University. Norman McColl Lecturer, Cambridge University. Fellow of the British Academy. Member of the Council of the Hispanic Society of America. Knight Commander of the Order of Alphonso XII. Author of <i>A History of Spanish Literature</i> .	Ayala y Herrera; Bello.
J. F. St.	JOHN FREDERICK STENNING, M.A. Dean and Fellow of Wadham College, Oxford. University Lecturer in Aramaic. Lecturer in Divinity and Hebrew at Wadham College.	Bible: Old Testament: Texts and Versions.
J. H. R.	JOHN HORACE ROUND, M.A., LL.D. (Edin.). Author of <i>Feudal England; Studies in Peerage and Family History; Peerage and Pedigree</i> ; &c.	Baron; Baronet; Battle Abbey Roll; Bayeux Tapestry; Beauchamp.
J. Hl. R.	JOHN HOLLAND ROSE, M.A., LITT.D. Christ's College, Cambridge. Lecturer on Modern History to the Cambridge University Local Lectures Syndicate. Author of <i>Life of Napoleon I.; Napoleonic Studies; The Development of the European Nations; The Life of Pitt</i> ; &c.	Barras; Beauharnais, Eugène de.
J. M. M.	JOHN MALCOLM MITCHELL. Sometime Scholar of Queen's College, Oxford. Lecturer in Classics, East London College (University of London). Joint editor of Grote's <i>History of Greece</i> .	Bacon, Francis (in part); Berkeley, George (in part).
J. P.-B.	JAMES GEORGE JOSEPH PENDEREL-BRODHURST. Editor of the <i>Guardian</i> (London).	Bed: Furniture; Bérain.
J. G. Se.	SIR JAMES GEORGE SCOTT, K.C.I.E. Superintendent and Political Officer, Southern Shan States. Author of <i>Burma, a Handbook; The Upper Burma Gazetteer</i> , &c.	Bhamo.
J. P. E.	JEAN PAUL HIPPOLYTE EMMANUEL ADHÉMAR ESMÉIN. Professor of Law in the University of Paris. Officer of the Legion of Honour. Member of the Institute of France. Author of <i>Cours élémentaire d'histoire du droit français</i> ; &c.	Baillif; Bailli; Basoche.

- J. P. Pe.** REV. JOHN PUNNETT PETERS, PH.D., D.D.
Canon Residentiary, Cathedral of New York. Formerly Professor of Hebrew, University of Pennsylvania. In charge of Expedition of University of Pennsylvania conducting excavations at Nippur, 1888-1895. Author of *Scriptures, Hebrew and Christian; Nippur, or Explorations and Adventures on the Euphrates; &c.*
- J. R. P.** SIR JOHN RAHERE PAGET, BART., K.C.
Bencher of the Inner Temple. Formerly Gilbert Lecturer on Banking. Author of *The Law of Banking; &c.*
- J. Sm.*** JOHN SMITH, C.B.
Formerly Inspector-General in Companies' Liquidation, 1890-1904, and Inspector-General in Bankruptcy.
- J. S. F.** JOHN SMITH FLETT, D.Sc., F.G.S.
Petriographer to the Geological Survey. Formerly Lecturer on Petrology in Edinburgh University. Neill Medallist of the Royal Society of Edinburgh. Bigsby Medallist of the Geological Society of London.
- J. T. Be.** JOHN T. BEALBY.
Joint author of Stanford's *Europe*. Formerly Editor of the *Scottish Geographical Magazine*. Translator of Sven Hedin's *Through Asia, Central Asia and Tibet, &c.*
- J. Vn.** JULIEN VINSON.
Formerly Professor of Hindustani and Tamil at the École des Langues Orientales, Paris. Author of *Le Basque et les langues mexicaines; &c.*
- J. V. B.** JAMES VERNON BARTLET, M.A., D.D. (St Andrews).
Professor of Church History, Mansfield College, Oxford. Author of *The Apostolic Age; &c.*
- J. W. He.** JAMES WYCLIFFE HEADLAM, M.A.
Staff Inspector of Secondary Schools under the Board of Education. Formerly Fellow of King's College, Cambridge. Professor of Greek and Ancient History at Queen's College, London. Author of *Bismarck and the Foundation of the German Empire; &c.*
- K. L.** REV. KIRSOPP LAKE, M.A.
Lincoln College, Oxford. Professor of Early Christian Literature and New Testament Exegesis in the University of Leiden. Author of *The Text of the New Testament; The Historical Evidence for the Resurrection of Jesus Christ; &c.*
- K. S.** KATHLEEN SCHLESINGER.
Author of *The Instruments of the Orchestra*.
- L. A.** LYMAN ABBOTT, D.D.
See the biographical article: ABBOTT, L.
- L. D.*** LOUIS MARIE OLIVIER DUCHESNE.
See the biographical article: DUCHESNE, L. M. O.
- L. J. S.** LEONARD JAMES SPENCER, M.A., F.G.S.
Assistant, Department of Mineralogy, Natural History Museum, South Kensington. Formerly Scholar of Sidney Sussex College, Cambridge, and Harkness Scholar. Editor of the *Mineralogical Magazine*.
- L. V.*** LUIGI VILLARI.
Italian Foreign Office (Emigration Dept.). Formerly Newspaper Correspondent in East of Europe. Author of *Italian Life in Town and Country; &c.*
- L. W. K.** LEONARD WILLIAM KING, M.A., F.S.A.
Assistant to the Keeper of Egyptian and Assyrian Antiquities, British Museum. Lecturer in Assyrian at King's College, London. Conducted Excavations at Kuyunjik (Nineveh) for British Museum. Author of *Assyrian Chrestomathy; Annals of the Kings of Assyria; Studies in Eastern History; Babylonian Magic and Sorcery; &c.*
- M. A. C.** MAURICE A. CANNEY, M.A.
Assistant Lecturer in Semitic Languages in the University of Manchester. Formerly Exhibitor of St John's College, Oxford. Pusey and Ellerton Hebrew Scholar (Oxford), 1892; Kennicott Hebrew Scholar, 1895; Houghton Syriac Prize, 1896.
- M. Br.** MARGARET BRYANT.
- M. D. Ch.** SIR MACKENZIE DALZELL CHALMERS, K.C.B., C.S.I., M.A.
Trinity College, Oxford. Barrister-at-Law. Formerly Permanent Under-Secretary of State for Home Department. Author of *Digest of the Law of Bills of Exchange; &c.*
- M. G.** MOSES GASTER, PH.D. (Leipzig).
Chief Rabbi of the Sephardic Communities of England. Vice-President, Zionist Congress, 1898, 1899, 1900. Ilchester Lecturer at Oxford on Slavonic and Byzantine Literature, 1886 and 1891. Author of *A New Hebrew Fragment of Ben-Sira; The Hebrew Version of the Secretum Secretorum of Aristotle*.
- M. H. C.** MONTAGUE HUGHES CRACKANTHORPE, K.C., D.C.L.
Honorary Fellow, St John's College, Oxford. Bencher of Lincoln's Inn. President of the Eugenics Education Society. Formerly Member of the General Council of the Bar and of the Council of Legal Education, and Standing Counsel to the University of Oxford.
- Bagdad; Vilayet; Bagdad; City; Basra.**
- Banks and Banking; English Law.**
- Bankruptcy.**
- Basalt; Batholite.**
- Baikal; Bessarabia (in part).**
- Basques (in part).**
- Barnabas.**
- Austria-Hungary; History; Bamberger; Bebel; Benedetti; Beust.**
- Bible; New Testament; Texts and Versions and Textual Criticism.**
- Bagpipe; Banjo; Barbiton; Barrel-organ; Bass Clarinet; Basset Horn; Bassoon; Batyphone.**
- Beecher, Henry Ward.**
- Benedict (I-X.)**
- Autunite; Axinite; Azurite; Barytes; Barytoceleite; Bauxite; Biotite.**
- Azeglio; Bandiera, A. and E.; Bassi, Ugo; Bentivoglio, Giovanni.**
- Babylonia and Assyria; Chronology.**
- Baur.**
- Beaumont and Fletcher; Appendix.**
- Bill of Exchange.**
- Bassarab.**
- Bering Sea Arbitration.**

- M. Ja.** MORRIS JASTROW, PH.D.
Professor of Semitic Languages, University of Pennsylvania. Author of *Religion of the Babylonians and Assyrians*; &c.
- M. P.*** LÉON JACQUES MAXIME PRINET.
Auxiliary of the Institute of France (Academy of Moral and Political Sciences). Author of *L'Industrie du sel en Franche-Comté*.
- N. B. W.** N. B. WAGLE.
Formerly Lecturer on Sanskrit at the Robert Money Institution, Bombay. Vice-President of the London Indian Society. Author of *Industrial Development of India*; &c.
- N. H. M.** REV. NEWTON HERBERT MARSHALL, M.A., PH.D. (Halle).
Minister of Heath Street Baptist Church, Hampstead, London. Author of *Gegenwärtige Richtungen der Religionsphilosophie in England*; *Theology and Truth*.
- N. M.** NORMAN McLEAN, M.A.
Fellow, Lecturer and Librarian of Christ's College, Cambridge. University Lecturer in Aramaic. Examiner for the Oriental Languages Tripos and the Theological Tripos at Cambridge.
- N. V.** JOSEPH MARIE NOEL VALOIS.
Member of the Académie des Inscriptions et Belles-Lettres. Honorary Archivist at the Archives Nationales. Formerly President of the Société de l'Histoire de France and of the Société de l'École de Chartes.
- N. W. T.** NORTHCOTE WHITBRIDGE THOMAS, M.A.
Government Anthropologist to Southern Nigeria. Corresponding Member of the Société d'Anthropologie de Paris. Author of *Thought Transference*; *Kinship and Marriage in Australia*; &c.
- O. Ba.** OSWALD BARRON, F.S.A.
Editor of *The Ancestor*, 1902-1905.
- O. Br.** OSCAR BRILLANT.
- O. Hr.** OTTO HENKER, PH.D.
On the Staff of the Carl Zeiss Factory, Jena, Germany.
- P. A.** PAUL DANIEL ALPHANDÉRY.
Professor of the History of Dogma, École Pratique des Hautes Études, Sorbonne, Paris. Author of *Les Idées morales chez les hétérodoxes latines au début du XIII^e siècle*.
- P. A. A.** PHILIP A. ASHWORTH, M.A., DOC. JURIS.
New College, Oxford. Barrister-at-Law. Translator of H. R. von Gneist's *History of the English Constitution*.
- P. A. K.** PRINCE PETER ALEXEIVITCH KROPOTKIN.
See the biographical article: KROPOTKIN, P. A.
- P. C. M.** PETER CHALMERS MITCHELL, M.A., F.R.S., F.Z.S., D.Sc., LL.D.
Secretary to the Zoological Society of London. University Demonstrator in Comparative Anatomy and Assistant to Linacre Professor at Oxford, 1888-1891. Examiner in Zoology to the University of London, 1903. Author of *Outlines of Biology*; &c.
- P. C. Y.** PHILIP CHESNEY YORKE, M.A.
Magdalen College, Oxford.
- P. Gi.** PETER GILES, M.A., LITT.D., LL.D.
Fellow and Classical Lecturer of Emmanuel College, Cambridge. University Reader in Comparative Philology. Formerly Secretary of the Cambridge Philological Society. Author of *Manual of Comparative Philology*; &c.
- P. S.** PHILIP SCHIDROWITZ, PH.D., F.C.S.
Member of Council, Institute of Brewing; Member of Committee of Society of Chemical Industry. Author of numerous articles on the Chemistry and Technology of Brewing, Distilling, &c.
- R. A.*** ROBERT ANCHEL.
Archivist of the Département de l'Eure.
- R. Ad.** ROBERT ADAMSON, M.A., LL.D.
See the biographical article: ADAMSON, ROBERT.
- R. A. S. M.** ROBERT ALEXANDER STEWART MACALISTER, M.A., F.S.A.
St John's College, Cambridge. Director of Excavations for the Palestine Exploration Fund. Joint author of *Excavations in Palestine, 1898-1900*.
- R. C. J.** SIR RICHARD CLAVERHOUSE JEBB, LL.D., D.C.L., LITT.D.
See the biographical article: JEBB, SIR RICHARD C.
- R. Gn.** SIR ROBERT GIFFEN, F.R.S.
See the biographical article: GIFFEN, SIR R.
- R. H. C.** REV. ROBERT HENRY CHARLES, M.A., D.D., LITT.D. (Oxon).
Grinfield Lecturer and Lecturer in Biblical Studies, Oxford. Fellow of the British Academy. Formerly Senior Moderator of Trinity College, Dublin. Author and Editor of *Book of Enoch*; *Book of Jubilees*; *Apocalypse of Baruch*; *Assumption of Moses*; *Ascension of Isaiah*; *Testaments of XII. Patriarchs*; &c.
- Babylonia and Assyria:
Proper Names;
Babylonian and Assyrian
Religion; Bel; Belit.
- Avaray; Bar-le-Duc;
Batarnay; Bauffremont;
Beauharnais; Beaujeu;
Beauvillier;
Bellegarde: *Family*.
- Bhav Daji.
- Baptists.
- Bardaisān;
Bar-Hebraeus;
Bar-Salibi.
- Basel, Council of;
Benedict XIII. (*anti-pope*).
- Automatism.
- Beard; Berkeley (*Family*);
Bill (*Weapon*).
- Austria-Hungary: *Statistics*.
- Binocular Instrument.
- Auto-à-Fé.
- Bavaria: *Statistics*;
Berlin.
- Baikal; Baku;
Bessarabia (*in part*).
- Biogenesis;
Biology.
- Balfour, Sir James.
- B.
- Beer.
- Billaud-Varenne.
- Bacon, Francis;
Bacon, Roger; Beneke;
Berkeley, Bishop.
- Bashan;
Bethlehem.
- Bacchylides.
- Bagehot;
Balance of Trade.
- Baruch.

- R. H. I. P.** SIR ROBERT HARRY INGLIS PALGRAVE, F.R.S.
Director of Barclay & Co., Ltd., Bankers. Editor of the *Economist*, 1871-1883. Author of *Notes on Banking in Great Britain and Ireland, Sweden, Denmark and Hamburg*; &c. Editor of *Dictionary of Political Economy*. } Banks and Banking: General.
- R. J. M.** RONALD JOHN MCNEILL, M.A.
Christ Church, Oxford. Barrister-at-Law. Formerly Editor of the *St James's Gazette* (London). } Beresford, John.
- R. L.*** RICHARD LYDEKKEER, F.R.S., F.G.S., F.Z.S.
Trinity College, Cambridge. Member of the Staff of the Geological Survey of India, 1874-1882. Author of *Catalogues of Fossil Mammals, Reptiles and Birds in British Museum; The Deer of all Lands*; &c. } Avahi; Aye-Aye; Babirusa; Baboon; Beaver.
- R. L. S.** ROBERT LOUIS STEVENSON.
See the biographical article: STEVENSON, R. L. B. } Béranger.
- R. M.*** ROBERT MUIR, M.A., M.D., F.R.C.P. (Edin.).
Professor of Pathology, University of Glasgow. Professor of Pathology at St Andrews, 1898-1899. Author of *Manual of Bacteriology*; &c. } Bacteriology: Pathological Aspects.
- R. N. B.** ROBERT NISBET BAIN (d. 1909).
Assistant Librarian. British Museum, 1883-1909. Author of *Scandinavia: the Political History of Denmark, Norway and Sweden, 1513-1900; The First Romanovs, 1613-1725; Slavonic Europe: the Political History of Poland and Russia from 1409 to 1796; Charles XII. and the Collapse of the Swedish Empire; Gustavus III. and his Contemporaries; The Pupils of Peter the Great*; &c. } Bakócz; Balassa; Bánffy; Bar, Confederation of; Baross; Basil; Báthory; Bathyanay; Bela III. and IV.; Bem; Beöthy; Bernstorff; Bestuzhev-Ryumin; Bethlen; Bezborodko; Biren.
- S. A. C.** STANLEY ARTHUR COOK, M.A.
Editor for Palestine Exploration Fund. Lecturer and formerly Fellow, Gonville and Caius College. Author of *Glossary of Aramaic Inscriptions; The Laws of Moses and Code of Hammurabi; Critical Notes on Old Testament History*; &c. } Baal; Benjamin.
- S. C.** SIDNEY COLVIN, M.A., LITT.D.
See the biographical article: COLVIN, SIDNEY. } Baldovinctti; Bellini.
- S. R. D.** SAMUEL ROLLES DRIVER, D.D., LITT.D.
See the biographical article: DRIVER, S. R. } Bible: Old Testament: Canon and Chronology.
- T. A. J.** THOMAS ATHOL JOYCE, M.A.
Assistant in Department of Ethnography, British Museum. Hon. Sec., Royal Anthropological Institute. } Bechuana.
- T. AS.** THOMAS ASHEY, M.A., D.LITT. (Oxon.), F.S.A.
Director of British School of Archaeology at Rome. Formerly Scholar of Christ Church, Oxford. Craven Fellow (Oxford). Corresponding Member of the Imperial German Archaeological Institute. Author of the *Classical Topography of the Roman Campagna*; &c. } Auximum; Avella; Avellino; Avernus; Balap; Bari; Barletta; Bassano; Belluno; Benevento; Bergamo; Bertinoro.
- T. A. I.** THOMAS ALLAN INGRAM, M.A., LL.D.
Trinity College, Dublin. } Balliff; Bill (*law*); Bill of Sale.
- T. Ba.** SIR THOMAS BARCLAY, M.P.
Member of the Institute of International Law. Member of the Supreme Council of the Congo Free State. Officer of the Legion of Honour. Author of *Problems of International Practice and Diplomacy*; &c. M.P. for Blackburn, 1910. } Belligerency.
- T. E. H.** THOMAS ERSKINE HOLLAND, K.C., D.C.L., LL.D.
Fellow of the British Academy. Fellow of All Souls' College, Oxford. Formerly Professor of International Law in the University of Oxford. Bencher of Lincoln's Inn. Author of *Studies in International Law; The Elements of Jurisprudence; Alberici Gentili de jure belli; The Laws of War on Land; Neutral Duties in a Maritime War*; &c. } Bentham, Jeremy.
- T. G. C.** THOMAS G. CARVER, M.A., K.C. (d. 1906).
Formerly Scholar of St John's College, Cambridge. 8th Wrangler, 1871. Author of *On the Law Relating to the Carriage of Goods by Sea*. } Average.
- T. H. D.** REV. THOMAS HERBERT DARLOW, M.A.
Literary Superintendent of the British and Foreign Bible Society. Sometime Scholar of Clare College, Cambridge. Author of *Historical Catalogue of Printed Editions of Holy Scriptures* (vol. i. with H. G. Moule); &c. } Bible Societies.
- T. H. H.** THOMAS HENRY HUXLEY, F.R.S.
See the biographical article: HUXLEY, THOMAS H. } Biology (*in part*).
- T. H. H.*** SIR THOMAS HUNGERFORD HOLDICH, K.C.M.G., K.C.I.E., D.Sc., F.R.G.S.
Colonel in the Royal Engineers. Superintendent, Frontier Surveys, India, 1892-1898. Gold Medallist, R.G.S. (London), 1887. H. M. Commissioner for the Persia-Beluch Boundary, 1896. Author of *The Indian Borderland; The Gates of India*; &c. } Badakshan; Bahrein Islands; Bajour; Balkh; Baluohistan; Bamian; Bela; Bhutan.
- T. L. P.** REV. THOMAS LESLIE PAPILLON, M.A.
Hon. Canon of St Albans. Formerly Fellow, Dean and Tutor of New College, Oxford. Fellow of Merton College. Author of *Manual of Comparative Philology*; &c. } Bell.
- T. O.** THOMAS OKEY.
Examiner in Basket Work for the City of London Guilds and Institute. } Basket.

- T. W. R. D.** T. W. RHYS DAVIDS, M.A., LL.D., PH.D.
Professor of Comparative Religion in the University of Manchester. Formerly Professor of Pali and Buddhist Literature, University College, London. Fellow of the British Academy. Secretary and Librarian of the Royal Asiatic Society, 1885-1902. Author of *Early Buddhism*; *Buddhist India*; &c.
- V. H. B.** VERNON HERBERT BLACKMAN, M.A., D.Sc.
Professor of Botany in the University of Leeds. Formerly Fellow of St John's College, Cambridge.
- W. A. B. C.** REV. WILLIAM AUGUSTUS BREVOORT COOLIDGE, M.A., F.R.G.S., PH.D.
Fellow of Magdalen College, Oxford. Professor of English History, St David's College, Lampeter, 1880-1881. Author of *Guide to Switzerland*; *The Alps in Nature and in History*; &c. Editor of the *Alpine Journal*, 1880-1889.
- W. A. G.** WALTER ARMSTRONG GRAHAM.
His Siamese Majesty's Resident Commissioner for the Siamese Malay State of Kelantan. Commander, Order of the White Elephant. Member of the Burma Civil Service, 1889-1903. Author of *The French Roman Catholic Mission in Siam; Kelantan, a Handbook*; &c.
- W. A. P.** WALTER ALISON PHILLIPS, M.A.
Formerly Exhibitor of Merton College and Senior Scholar of St John's College, Oxford. Author of *Modern Europe*; *The War of Greek Independence*; &c.
- W. Bo.** WILHELM BOUSSET, D.TH.
Professor of New Testament Exegesis in the University of Göttingen. Author of *Das Wesen der Religion*; *The Antichrist Legend*; &c.
- W. B. Ca.** W. BROUGHTON CARR.
Formerly Editor of the *British Bee Journal* and the *Bee-Keepers' Record*.
- W. C. P.** WILLIAM CHARLES POWNLEWELL, M.Sc., A.M.I.C.E.
Lecturer in Engineering in Manchester School of Technology (University of Manchester). Author of *Compressed Air*; *Heat Engines*; &c.
- W. E. D.** WILLIAM ERNEST DALBY, M.A., M.INST.C.E., M.I.M.E.
Professor of Civil and Mechanical Engineering at the City and Guilds of London Institute Central Technical College, South Kensington. Associate Member of the Institute of Naval Architects. Author of *The Balancing of Engines*; *Valves and Valve Gear Mechanisms*; &c.
- W. E. G.** SIR WILLIAM EDMUND GARSTIN, G.C.M.G.
Governing Director, Suez Canal Co. Formerly Inspector-General of Irrigation, Egypt. Adviser to the Ministry of Public Works in Egypt, 1904-1908.
- W. H. Be.** WILLIAM HENRY BENNETT, M.A., D.D., D.LITT. (Cantab.).
Professor of Old Testament Exegesis in New and Hackney Colleges, London. Formerly Fellow of St John's College, Cambridge. Lecturer in Hebrew at Firth College, Sheffield. Author of *Religion of the Post-Exilic Prophets*; &c.
- W. H. Ha.** WILLIAM HENRY HADOW, M.A., MUS.DOC.
Principal, Armstrong College, Newcastle-on-Tyne. Formerly Fellow and Tutor of Worcester College, Oxford. Member of Council, Royal College of Music. Editor *Oxford History of Music*. Author of *Studies in Modern Music*; &c.
- W. J. H.*** WILLIAM JAMES HUGHAN.
Past Senior Grand Deacon of Freemasons of England, 1874. Hon. Senior Warden of Grand Lodges of Egypt, Quebec and Iona, &c.
- W. L. D.** WILLIAM LESLIE DAVIDSON, LL.D.
Professor of Logic and Metaphysics, Aberdeen University. Author of *The Logic of Definition*; *Christian Ethics*; &c. Editor of Alexander Bain's *Autobiography*.
- W. M. S.** WILLIAM MILLIGAN SLOANE, PH.D., LL.D.
Professor of History, Columbia University, New York. Secretary to George Bancroft while American Ambassador in Berlin, 1872-1873. Author of *Life of Napoleon Bonaparte*.
- W. P. C.** WILLIAM PRIDEAUX COURTNEY.
See the article: COURTNEY, L. H., BARON.
- W. P. J.** WILLIAM PRICE JAMES.
University College, Oxford. Barrister-at-Law. High Bailiff of County Courts, Cardiff. Author of *Romantic Professions*; &c.
- W. P. R.** HON. WILLIAM PEMBER REEVES.
Director of London School of Economics. Agent-General and High Commissioner for New Zealand, 1896-1909. Minister of Education, Labour and Justice, New Zealand, 1891-1896. Author of *The Long White Cloud, a History of New Zealand*; &c.
- W. R. L.** W. R. LETHABY, F.S.A.
Principal of the Central School of Arts and Crafts under the London County Council. Author of *Architecture, Mysticism and Myth*; &c.
- W. Sa.** WILLIAM SANDAY, D.D., LL.D., LITT.D.
Lady Margaret Professor of Divinity, and Canon of Christ Church, Oxford. Chaplain in Ordinary to His Majesty the King. Hon. Fellow of Exeter College, Oxford. Fellow of the British Academy. Author of *Inspiration* (Bampton Lecture, 1893); *Commentary on the Epistle to the Romans*; &c.
- Bharahat.**
- Bacteriology: Botany.**
- Baden: Switzerland;**
Barcelonnette; Basel;
Basses-Alpes; Beaulieu;
Bellinzona; Bern; Biennet.
- Bangkok.**
- Austria-Hungary: History**
(in part);
Babeuf; Balance of Power;
Baron; Bates;
Bavaria: History; Béguines;
Berlin: Congress and Treaty of;
Bernard, St; Biretta.
- Basilides.**
- Bee: Bee-keeping.**
- Bellows and Blowing Machines.**
- Bearings.**
- Bahr-el-Ghazal (in part).**
- Balaam;**
Beelzebub.
- Bach, K. P. E.**
- Banker-Marks.**
- Bain, Alexander.**
- Bancroft, George.**
- Bath, William Pulteney,**
Marquess of.
- Barrie, J. M.**
- Ballance, John.**
- Baptistry.**
- Bible: New Testament: Canon.**

W. T. Ca.	WILLIAM THOMAS CALMAN, D.Sc., F.Z.S. Assistant in charge of Crustacea, Natural History Museum, South Kensington. Author of "Crustacea" in Lankester's <i>Treatise on Zoology</i> .	} Barnacle.
W. T. T.-D.	SIR WILLIAM TURNER THISELTON-DYER, F.R.S., K.C.M.G., C.I.E., D.Sc. LL.D., Ph.D., F.L.S. Hon. Student of Christ Church, Oxford. Director, Royal Botanic Gardens, Kew, 1885-1905. Botanical Adviser to Secretary of State for Colonies, 1902-1906. Joint-author of <i>Flora of Middlesex</i> . Editor of <i>Flora Capenses</i> and <i>Flora of Tropical Africa</i> .	
W. W.	WILLIAM WALLACE, M.A. See the biographical article: WALLACE, WILLIAM (1844-1897).	} Averroes; } Avicenna.
W. We.	REV. WENTWORTH WEBSTER (d. 1906). Author of <i>Basque Legends</i> ; &c.	
W. Wr.	WILLISTON WALKER, Ph.D., D.D. Professor of Church History, Yale University. Author of <i>History of the Congregational Churches in the Principal States</i> ; <i>The Reformation</i> ; <i>John Calvin</i> ; &c.	} Bacon, Leonard.
W. R. S.	W. ROBERTSON SMITH, LL.D. See the biographical article: SMITH, WILLIAM ROBERTSON.	
W. W. R.*	WILLIAM WALKER ROCKWELL, LIC.THEOL. Assistant Professor of Church History, Union Theological Seminary, New York. Author of <i>Die Doppelteke des Landgrafen Philipp von Hessen</i> .	} Benedict XI., XII., XIII., XIV

PRINCIPAL UNSIGNED ARTICLES

Azo Compounds.	Barnes, William.	Belfort: Town.	Bermudas.
Azolmide.	Barometer.	Bell, Sir Charles.	Bernhardt, Sarah.
Azores.	Barrister.	Belladonna.	Bernoulli.
Baader, F. X.	Barrow, Isaac.	Bellarmine.	Berthelot.
Baber.	Bastiat, F.	Bellary.	Berwick (Duke of).
Baby-Farming.	Bastille.	Belle-Isle, C. L. A. F., Duc de.	Berwickshire.
Bachelor.	Baths.	Benares.	Berwick-upon-Tweed.
Backgammon.	Battery.	Benedek.	Beryllium.
Baden: Grand Duchy.	Baudelaire.	Benediction.	Besaçon.
Badger.	Bautzen.	Benefice.	Essemer, Sir Henry.
Badminton.	Baxter, Richard.	Benevolence.	Bet and Betting.
Bagatelle.	Bayard, P. T.	Bengal.	Betrothal.
Bahamas.	Bazaine.	Bengel.	Beyle.
Balaklava.	Bean.	Benin.	Bézioue.
Bale, John.	Bear.	Benjamin (Judah Philip).	Bhagalpur.
Ballet.	Bear - Baiting and Bull-baiting.	Benson (Archbishop of Canterbury).	Bible Christians.
Ballet.	Beaton.	Bentley, Richard.	Bichromates and Chromates.
Ballot.	Beaufort: Family.	Benton.	Bidder.
Ballot.	Beaufort, Henry.	Benzaldehyde.	Bigamy.
Balneotheapeutics.	Beaumarchais.	Benzene.	Bijapur.
Bamboo.	Beaumont: Family.	Benzoic Acid.	Bikanir.
Ban.	Becher.	Berar.	Bilaspur.
Banana.	Beddoes, Thomas Lovell.	Berbers.	Bilbao.
Bank-notes.	Bedford, Earls and Dukes of.	Berengarius.	Billiards.
Barbados.	Bedfordshire.	Beresford, Lord Charles.	Binomial.
Barbarossa.	Bedouins.	Beresford, Viscount.	Birch.
Barbed Wire.	Beecher, Lyman.	Bergen.	Birkenhead.
Barcelona.	Behar.	Beri-Beri.	Birmingham.
Barclay, Alexander.	Behaving.	Berkshire.	Birney, James G.
Barère de Vieuzac.	Béjart.	Berlioz.	Biron, Armand de Gontaut.
Barium.	Belfast: Ireland.	Bermondsey.	Birth.
Barlaam and Josaphat.			Biscay (Vizcaya).
Barley.			

ENCYCLOPÆDIA BRITANNICA

ELEVENTH EDITION

VOLUME III

AUSTRIA, LOWER (Ger. *Niederösterreich* or *Österreich unter der Enns*, "Austria below the river Enns"), an archduchy and crownland of Austria, bounded E. by Hungary, N. by Bohemia and Moravia, W. by Bohemia and Upper Austria, and S. by Styria. It has an area of 7654 sq. m. and is divided into two parts by the Danube, which enters at its most westerly point, and leaves it at its eastern extremity, near Pressburg. North of this line is the low hilly country, known as the *Waldviertel*, which lies at the foot and forms the continuation of the Bohemian and Moravian plateau. Towards the W. it attains in the Weinsberger Wald, of which the highest point is the Peilstein, an altitude of 3478 ft., and descends towards the valley of the Danube through the Gföhler Wald (2368 ft.) and the Manhartsgebirge (1758 ft.). Its most south-easterly offshoots are formed by the Bisamberg (1180 ft.), near Vienna, just opposite the Kahlenberg. The southern division of the province is, in the main, mountainous and hilly, and is occupied by the Lower Austrian Alps and their offshoots. The principal groups are: the Voralpe (5802 ft.), the Dürrenstein (6156 ft.), the Ötsocher (6205 ft.), the Raxalpe (6589 ft.) and the Schneeberg (6806 ft.), which is the highest summit in the whole province. To the E. of the famous ridge of Semmering are the groups of the Wechsel (5700 ft.) and the Leithagebirge (1674 ft.). The offshoots of the Alpine group are formed by the Wiener Wald, which attains an altitude of 2920 ft. in the Schöpfl and ends N.W. of Vienna in the Kahlenberg (1404 ft.) and Leopoldsberg (1380 ft.).

Lower Austria belongs to the watershed of the Danube, which with the exception of the Lainsitz, which is a tributary of the Moldau, receives all the other rivers of the province. Its principal affluents on the right are: the Enns, Ybbs, Erlauf, Pielach, Traisen, Wien, Schwechat, Fischa and Leitha; on the left the Isper, Krens, Kamp, Göllersau and the March. Besides the

Danube, only the Enns and the March are navigable rivers. Amongst the small Alpine lakes, the Erlaufsee and the Lunzer See are worth mentioning. Of its mineral springs, the best known are the sulphur springs of Baden, the iodine springs of Deutsch-Altenburg, the iron springs of Pyrawarth, and the thermal springs of Vöslau. In general the climate, which varies with the configuration of the surface, is moderate and healthy, although subject to rapid changes of temperature. Although 43.4% of the total area is arable land, the soil is only of moderate fertility and does not satisfy the wants of this thickly-populated province. Woods occupy 34.2%, gardens and meadows 13.1% and pastures 3.2%. Vineyards occupy 2% of the total area and produce a good wine, specially those on the sunny slopes of the Wiener Wald. Cattle-rearing is not well developed, but game and fish are plentiful. Mining is only of slight importance, small quantities of coal and iron-ore being extracted in the Alpine foothill region; graphite is found near Mühlendorf. From an industrial point of view, Lower Austria stands, together with Bohemia and Moravia, in the front rank amongst the Austrian provinces. The centre of its great industrial activity is the capital, Vienna (*q.v.*); but in the region of the Wiener Wald up to the Semmering, owing to its many waters, which can be transformed into motive power, many factories are spread. The principal industries are, the metallurgic and textile industries in all their branches, milling, brewing and chemicals; paper, leather and silk; cloth, *objets de luxe* and millinery; physical and musical instruments; sugar, tobacco factories and food-stuffs. The very extensive commerce of the province has also its centre in Vienna. The population of Lower Austria in 1900 was 3,100,493, which corresponds to 405 inhabitants per sq. m. It is, therefore, the most densely populated province of Austria. According to the language in common use, 95% of the population

was German, 4.66% was Czech, and the remainder was composed of Poles, Slovaks, Ruthenians, Croats and Italians. According to religion 92.47% of the inhabitants were Roman Catholics; 5.07% were Jews; 2.11% were Protestants and the remainder belonged to the Greek church. In the matter of education, Lower Austria is one of the most advanced provinces of Austria, and 99.8% of the children of school-going age attended school regularly in 1900. The local diet is composed of 78 members, of which the archbishop of Vienna, the bishop of St Pölten and the rector of the Vienna University are members *ex officio*. Lower Austria sends 64 members to the Imperial Reichsrat at Vienna. For administrative purposes, the province is divided into 22 districts and three towns with autonomous municipalities: Vienna (1,662,269), the capital (since 1905 including Floridsdorf, 36,599), Wiener-Neustadt (28,438) and Waidhofen on the Ybbs (4447). Other principal towns are: Baden (12,447), Bruck on the Leitha (5134), Schwechat (8241), Korneuburg (8298), Stokerau (10,213), Krems (12,657), Mödling (15,304), Reichenau (7457), Neunkirchen (10,831), St Pölten (14,510) and Klosterneuburg (11,595).

The original archduchy, which included Upper Austria, is the nucleus of the Austrian empire, and the oldest possession of the house of Habsburg in its present dominions.

See F. Umlauf, *Das Erbschaftsrecht Österreich unter der Enns*, vol. i. of the collection *Die Länder Österreich-Ungarns in Wort und Bild* (Vienna, 1881-1889, 15 vols.); *Die österreichisch-ungarische Monarchie in Wort und Bild*, vol. 4 (Vienna, 1886-1902, 24 vols.); M. Vansca, *Gesch. Nieder- u. Ober-Österreichs* (in Heeren's *Staaten-gesch.*, Götting, 1905).

AUSTRIA, UPPER (Ger. *Oberösterreich* or *Österreich ob der Enns*, "Austria above the river Enns"), an archduchy and crown-land of Austria, bounded N. by Bohemia, W. by Bavaria, S. by Salzburg and Styria, and E. by Lower Austria. It has an area of 4631 sq. m. Upper Austria is divided by the Danube into two unequal parts. Its smaller northern part is a prolongation of the southern angle of the Bohemian forest and contains as culminating points the Plöckstein (4510 ft.) and the Sternstein (3690 ft.). The southern part belongs to the region of the Eastern Alps, containing the Salzkammergut and Upper Austrian Alps, which are found principally in the district of Salzkammergut (*q.v.*). To the north of these mountains, stretching towards the Danube, is the Alpine foothill region, composed partly of terraces and partly of swelling undulations, of which the most important is the Hausruckwald. This is a wooded chain of mountains, with many branches, rich in brown coal and culminating in the Göblberg (2950 ft.). Upper Austria belongs to the watershed of the Danube, which flows through it from west to east, and receives here on the right the Inn with the Salzach, the Traun, the Enns with the Steyr and on its left the Great and Little Mühl rivers. The Schwarzenberg canal between the Great Mühl and the Moldau establishes a direct navigable route between the Danube and the Elbe. The climate of Upper Austria, which varies according to the altitude, is on the whole moderate; it is somewhat severe in the north, but mild in Salzkammergut. The population of the duchy in 1900 was 809,918, which is equivalent to 174.8 inhabitants per sq. m. It has the greatest density of population of any of the Alpine provinces. The inhabitants are almost exclusively of German stock and Roman Catholics. For administrative purposes, Linz (58,778) the capital, and Steyr (17,592) and 12 districts. Other principal towns are Wels (12,187), Ischl (9646) and Gmunden (7126). The local diet, of which the bishop of Linz is a member *ex officio*, is composed of 50 members and the duchy sends 22 members to the Reichsrat at Vienna. The soil in the valleys and on the lower slopes of the hills is fertile, indeed 35.08% of the whole area is arable. Agriculture is well developed and relatively large quantities of the principal cereals are produced. Upper Austria has the largest proportion of meadows in all Austria, 18.54%, while 2.49% is lowland and Alpine pasturage. Of the remainder, woods occupy 34.02%, gardens 1.99% and 4.93% is unproductive. Cattle-breeding is also in a very advanced stage and together with the timber-trade forms a considerable resource

of the province. The principal mineral wealth of Upper Austria is salt, of which it extracts nearly 50% of the total Austrian production. Other important products are lignite, gypsum and a variety of valuable stones and clays. There are about thirty mineral springs, the best known being the salt baths of Ischl and the iodine waters at Hall. The principal industries are the iron and metal manufactures, chiefly centred at Steyr. Next in importance are the machine, linen, cotton and paper manufactures, the milling, brewing and distilling industries and shipbuilding. The principal articles of export are salt, stone, timber, live-stock, woollen and iron wares and paper.

See Edlbacher, *Landeskunde von Oberösterreich* (Linz, 2nd ed., 1883); Vansca, *op. cit.* in the preceding article.

AUSTRIA-HUNGARY, or the **AUSTRO-HUNGARIAN MONARCHY** (Ger. *Österreichisch-ungarische Monarchie* or *Österreichisch-ungarisches Reich*), the official name of a country situated in central Europe, bounded E. by Russia and Rumania, S. by Rumania, Servia, Turkey and Montenegro, W. by the Adriatic Sea, Italy, Switzerland, Liechtenstein, and the German Empire, and N. by the German Empire and Russia. It occupies about the sixteenth part of the total area of Europe, with an area (1905) of 239,977 sq. m. The monarchy consists of two independent states: the kingdoms and lands represented in the council of the empire (*Reichsrat*), unofficially called Austria (*q.v.*) or Cisleithania; and the "lands of St Stephen's Crown," unofficially called Hungary (*q.v.*) or Transleithania. It received its actual name by the diploma of the emperor Francis Joseph I. of the 14th of November 1868, replacing the name of the Austrian Empire under which the dominions under his sceptre were formerly known. The Austro-Hungarian monarchy is very often called unofficially the Dual Monarchy. It had in 1901 a population of 45,405,267 inhabitants, comprising therefore within its borders, about one-eighth of the total population of Europe. By the Berlin Treaty of 1878 the principalities of Bosnia and Herzegovina with an area of 19,702 sq. m., and a population (1895) of 1,591,036 inhabitants, owning Turkey as suzerain, were placed under the administration of Austria-Hungary, and their annexation in 1908 was recognized by the Powers in 1909, so that they became part of the dominions of the monarchy.

Government.—The present constitution of the Austro-Hungarian monarchy (see **AUSTRIA**) is based on the Pragmatic Sanction of the emperor Charles VI., first promulgated on the 10th of April 1713, whereby the succession to the throne is settled in the dynasty of Habsburg-Lorraine, descending by right of primogeniture and lineal succession to male heirs, and, in case of their extinction, to the female line, and whereby the indissolubility and indivisibility of the monarchy are determined; is based, further, on the diploma of the emperor Francis Joseph I. of the 20th of October 1860, whereby the constitutional form of government is introduced; and, lastly, on the so-called *Ausgleich* or "Compromise," concluded on the 8th of February 1867, whereby the relations between Austria and Hungary were regulated.

The two separate states—Austria and Hungary—are completely independent of each other, and each has its own parliament and its own government. The unity of the monarchy is expressed in the common head of the state, who bears the title Emperor of Austria and Apostolic King of Hungary, and in the common administration of a series of affairs, which affect both halves of the Dual Monarchy. These are: (1) foreign affairs, including diplomatic and consular representation abroad; (2) the army, including the navy, but excluding the annual voting of recruits, and the special army of each state; (3) finance in so far as it concerns joint expenditure.

For the administration of these common affairs there are three joint ministries: the ministry of foreign affairs and of the imperial and royal house, the ministry of war, and the ministry of finance. It must be noted that the authority of the joint ministers is restricted to common affairs, and that they are not allowed to direct or exercise any influence on affairs of government affecting separately one of the halves of the monarchy.

The minister of foreign affairs conducts the international relations of the Dual Monarchy, and can conclude international treaties. But commercial treaties, and such state treaties as impose burdens on the state, or parts of the state, or involve a change of territory, require the parliamentary assent of both states. The minister of war is the head for the administration of all military affairs, except those of the Austrian *Landwehr* and of the Hungarian *Honveds*, which are committed to the ministries for national defence of the two respective states. But the supreme command of the army is vested in the monarch, who has the power to take all measures regarding the whole army. It follows, therefore, that the total armed power of the Dual Monarchy forms a whole under the supreme command of the sovereign. The minister of finance has charge of the finances of common affairs, prepares the joint budget, and administers the joint state debt. (Till 1909 the provinces of Bosnia and Herzegovina were also administered by the joint minister of finance, excepting matters exclusively dependent on the minister of war.) For the control of the common finances, there is appointed a joint supreme court of accounts, which audits the accounts of the joint ministries.

Budget.—Side by side with the budget of each state of the Dual Monarchy, there is a common budget, which comprises the expenditure necessary for the common affairs, namely for the conduct of foreign affairs, for the army, and for the ministry of finance. The revenues of the joint budget consist of the revenues of the joint ministries, the net proceeds of the customs, and the quota, or the proportional contributions of the two states. This quota is fixed for a period of years, and generally coincides with the duration of the customs and commercial treaty. Until 1897 Austria contributed 70% and Hungary 30% of the joint expenditure, remaining after deduction of the common revenue. It was then decided that from 1897 to July 1907 the quota should be 66½% for Austria, and 33½% for Hungary. In 1907 Hungary's contribution was raised to 36.4%. Of the total charges 2% is first of all debited to Hungary on account of the incorporation with this state of the former military frontier.

The Budget estimates for the common administration were as follows in 1905:—

Revenue—		
Ministry of Foreign Affairs		£21,167
Ministry of War		305,907
Ministry of Finance		4,870
Board of Control		18
The Customs		4,780,000
Proportional contributions		15,650,448
	Total	£20,762,410
Expenditure—		
Ministry of Foreign Affairs		£485,480
Ministry of War:—		
Army		12,679,160
Navy		2,306,100
Ministry of Finance		177,000
Board of Control		13,250
Extraordinary Military Expenditure		4,785,500
Extraordinary Military Expenditure in Bosnia		315,920
	Total	£20,762,410

The following table gives in thousands sterling the joint budget for the years 1875-1905:—

	Expenditure.				
	1875.	1885.	1895.	1900.	1905.
Ministry of Foreign Affairs	396	368.7	333	433.4	493.8
Ministry of War (Army and Navy)	9005.4	10,085	12,530	13,887.5	18,087.7
Ministry of Finance	154.2	167.2	170.4	175	177.1
Supreme Court of Accounts	10.5	10.6	10.7	12.5	13.3
Total	9566.1	10,631.5	13,053.1	14,508.4	20,430.3
	Revenue.				
	1875.	1885.	1895.	1900.	1905.
For the above Departments	432	258.2	260.7	260.3	331.9
Customs	997.4	402.2	447.6	520.3	4799.7
Proportional Contributions	8136.7	9971.1	8316.4	9045.8	15,650.4
Total	9566.1	10,631.5	13,053.1	14,508.4	20,430.3

Debt.—Besides the debts of each state of the Dual Monarchy, there is a general debt, which is borne jointly by Austria and Hungary. The following table gives in millions sterling the amount of the general debt for the years 1875-1905:—

1875.	1885.	1895.	1900.	1905.
232.41	231.02	229.67	226.81	224.31

Delegations.—The constitutional right of voting money applicable to the common affairs and of its political control is exercised by the Delegations, which consist each of sixty members, chosen for one year, one-third of them by the Austrian Herrenhaus (Upper House) and the Hungarian Table of Magnates (Upper House), and two-thirds of them by the Austrian and the Hungarian Houses of Representatives. The delegations are annually summoned by the monarch alternately to Vienna and to Budapest. Each delegation has its separate sittings, both alike public. Their decisions are reciprocally communicated in writing, and, in case of non-agreement, their deliberations are renewed. Should three such interchanges be made without agreement, a common plenary sitting is held of an equal number of both delegations; and these collectively, without discussion, decide the question by common vote. The common decisions of both houses require for their validity the sanction of the monarch. Each delegation has the right to formulate resolutions independently, and to call to account and arraign the common ministers. In the exercise of their office the members of both delegations are irresponsible, enjoying constitutional immunity.

Army.—The military system of the Austro-Hungarian monarchy is similar in both states, and rests since 1868 upon the principle of the universal and personal obligation of the citizen to bear arms. Its military force is composed of the common army (*K. and K.*); the special armies, namely the Austrian (*K.K.*) *Landwehr*, and the Hungarian *Honveds*, which are separate national institutions, and the *Landsturm* or levy-in-mass. As stated above, the common army stands under the administration of the joint minister of war, while the special armies are under the administration of the respective ministries of national defence. The yearly contingent of recruits for the army is fixed by the military bills voted by the Austrian and Hungarian parliaments, and is generally determined on the basis of the population, according to the last census returns. It amounted in 1905 to 103,100 men, of which Austria furnished 59,211 men, and Hungary 43,889. Besides 10,000 men are annually allotted to the Austrian *Landwehr*, and 12,500 to the Hungarian *Honveds*. The term of service is 2 years (3 years in the cavalry) with the colours, 7 or 8 in the reserve and 2 in the *Landwehr*; in the case of men not drafted to the active army the same total period of service is spent in various special reserves.

For the military and administrative service of the army the Dual Monarchy is divided into 16 military territorial districts (15 of which correspond to the 15 army corps) and 108 supplementary districts (105 for the army, and 3 for the navy). In 1902, since which year no material change was made in the formal organization of the army, there were 5 cavalry divisions and 31 infantry divisions, formed in 15 army corps, which are located as follows:—I. Cracow, II. Vienna, III. Graz, IV. Budapest, V. Pressburg, VI. Kaschau, VII. Temesvár, VIII. Prague, IX. Josefstadt, X. Przemysl, XI. Lemberg, XII. Hermannstadt, XIII. Agram, XIV. Innsbruck, XV. Serajewo. In addition there is the military district of Zara. The usual strength of the corps is, 2 infantry divisions (4 brigades, 8 or 9 regiments, 32 or 36 battalions), 1 cavalry brigade (18 squadrons), and 1 artillery brigade (16-18 batteries or 128-144 field-guns), besides technical and departmental units and in some cases fortress artillery regiments. The infantry is organized into line regiments, Jäger and Tirolese regiments, the cavalry into dragoons, lancers, Uhans and Hussars, the artillery into regiments. The Austrian *Landwehr* (which retains the old designation *K.K.*, formerly

applied to the Austrian regular army) is organized in 8 divisions of varying strength, the "Royal Hungarian" Landwehr or Honveds in 7 divisions, both Austrian and Hungarian Landwehr having in addition cavalry (Uhlands and hussars) and artillery. It is probable that a Landwehr or Honveds division will, in war, form part of each army corps except in the case of the Vienna corps, which has 3 divisions in peace. The remaining men of military age (up to 42) as usual form the *Landsturm*. It is to be noted that this *Landsturm* comprises many men who would elsewhere be classed as Landwehr.

The strength of the Austro-Hungarian army on a peace footing was as follows in 1905:—

	Officers.	Men.	Horses.	Guns.
Infantry—				
Common Army	10,801	187,604	1,152	..
Austrian Landwehr	1,883	23,905	174	..
Hungarian Honveds	2,258	21,149	262	..
Cavalry—				
Common Army	1,890	45,486	40,740	..
Austrian Landwehr	170	1,861	1,282	..
Hungarian Honveds	390	4,170	3,510	..
Field Artillery	1,630	27,612	14,520	1048
Fortress Artillery	408	7,722	131	..
Technical troops	588	9,935	19	..
(Pioneers, and Railway and Telegraph Regiment)				
Transport Service	461	4,312	3,997	..
Sanitary Service	85	3,062
Total	20,564	336,818	64,887	1048
Belonging to the				
Common Army	15,863	285,733	59,650	1048
Austrian Landwehr	2,053	25,766	1,456	..
Hungarian Honveds	2,648	25,319	3,772	..

The troops stationed in Bosnia and Herzegovina in 1905 (376 officers and 6372 men) are included in the total for the common army.

The peace strength of the active army in combatants is thus about 350,000 officers and men, inclusive of the two Landwehrs and of the Austrian, "K.K." guards, the Hungarian crown guards, the gendarmes, &c. The numbers of the *Landsturm* and the war strength of the whole armed forces are not published. It is estimated that the first line army in war would consist of 460,000 infantry, 49,000 cavalry, 78,000 artillery, 21,000 engineers, &c., beside train and non-combatant soldiers. The Landwehr and Honved would yield 219,000 infantry and 18,000 cavalry, and other reserves 223,000 men. These figures give an approximate total strength of 1,147,000, not inclusive of *Landsturm*.

Fortifications.—The principal fortifications in Austria-Hungary are: Cracow and Przemyśl in Galicia; Komárom, the centre of the inland fortifications, Pétervárad, Ó-Árad and Temesvár in Hungary; Scerajewo, Mostar and Bilek in Bosnia-Herzegovina. The Alpine frontiers, especially those in Tirol, have numerous fortifications, whose centre is formed by Trent and Franzensfeste; while all the military roads leading into Carinthia have been provided with strong defensive works, as at Malborghet, Predil Pass, &c. The two capitals, Vienna and Budapest, are not fortified. On the Adriatic coast, the main harbour of Pola is strongly fortified with sea and land defences; then come Trieste, and several places in Dalmatia, notably Zara and Cattaro.

Navy.—The Austro-Hungarian navy is mainly a coast defence force, and includes also a flotilla of monitors for the Danube. It is administered by the naval department of the ministry of war. It consisted in 1905 of 9 modern battleships, 3 armoured cruisers, 5 cruisers, 4 torpedo gunboats, 20 destroyers and 26 torpedo boats. There was in hand at the same time a naval programme to build 12 armouredclads, 5 second-class cruisers, 6 third-class cruisers, and a number of torpedo boats. The headquarters of the fleet are at Pola, which is the principal naval arsenal and harbour of Austria; while another great naval station is Trieste.

Trade.—On the basis of the customs and commercial agreement between Austria and Hungary, concluded in 1867 and renewable every ten years, the following affairs, in addition to the common affairs of the monarchy, are in both states treated according to the same principles:—Commercial affairs, including customs legislation; legislation on the duties closely connected with industrial production—on beer, brandy, sugar and mineral oils; determination of legal tender and coinage, as also of the principles regulating the Austro-Hungarian Bank; ordinances in respect of such railways as affect the interests of both states. In conformity with the customs and commercial compact between the two states, renewed in 1899, the monarchy constitutes one identical customs and commercial territory, inclusive of Bosnia and Herzegovina and the principality of Liechtenstein.

The foreign trade of the Austro-Hungarian monarchy is shown in the following table:—

Year.	Imports.	Exports.
1900	£70,666,000	£80,916,000
1901	68,833,000	78,541,000
1902	71,666,000	79,708,000
1903	78,200,000	88,600,000
1904	85,200,000	86,200,000
1905	89,430,000	93,500,000

The following tables give the foreign trade of the Austro-Hungarian monarchy as regards raw material and manufactured goods:—

Imports.

Articles.	Value in Millions Sterling.				
	1900.	1901.	1902.	1903.	1904.
Raw material (including articles of food; raw material for agriculture and industry; and mining and smelting products)	41·5	40·5	41·8	45·9	51·9
Semi-manufactured goods	9·6	9·6	10·3	10·6	10·8
Manufactured goods	19·5	18·7	19·5	21·6	22·5

Exports.

Articles.	Value in Millions Sterling.				
	1900.	1901.	1902.	1903.	1904.
Raw material (as above)	34·1	34·1	35·8	39	35·3
Semi-manufactured goods	12·6	11·1	11·1	12·4	12·6
Manufactured goods	34·2	33·3	32·8	37·2	38·3

The most important place of derivation and of destination for the Austro-Hungarian trade is the German empire with about 40% of the imports, and about 60% of the exports. Next in importance comes Great Britain, afterwards India, Italy, the United States of America, Russia, France, Switzerland, Rumania, the Balkan states and South America in about the order named. The principal articles of import are cotton and cotton goods, wool and woollen goods, silk and silk goods, coffee, tobacco and metals. The principal articles of export are wool, sugar, cattle, glass and glassware, iron and iron-ware, eggs, cereals, millinery, fancy goods, earthenware and pottery, and leather goods.

The Austro-Hungarian Bank.—Common to the two states of the monarchy is the "Austro-Hungarian Bank," which possesses a legal exclusive right to the issue of bank-notes. It was founded in 1816, and had the title of the Austrian National Bank until 1878, when it received its actual name. In virtue of the new bank statute of the year 1899 the bank is a joint-stock company, with a stock of £8,780,000. The bank's notes of issue must be covered to the extent of two-fifths by legal specie (gold and current silver) in reserve; the rest of the paper circulation, according to bank usage. The state, under certain conditions, takes a portion of the clear profits of the bank. The management of the bank and the supervision exercised over it by the state are established on a footing of equality, both states having each the same influence. The accounts of the bank at the end of 1900 were as follows: capital, £8,750,000; reserve fund, £428,250; note circulation, £62,251,000; cash, £50,754,000. In 1907 the reserve fund was £548,041; note circulation, £84,501,000; cash, £50,036,625. The charter of the bank, which expired in 1897, was renewed until the end of 1910. In the Hungarian ministerial crisis of 1909 the question of the renewal of the charter played a conspicuous part, the more extreme members of the Independence party demanding the establishment of separate banks for Austria and Hungary with, at most, common superintendence (see *HISTORY*, below). (O. B.R.)

HISTORY

I. *The Whole Monarchy.*

The empire of Austria, as the official designation of the territories ruled by the Habsburg monarchy, dates back only to 1804, when Francis II., the last of the Holy Roman ^{The title} emperors, proclaimed himself emperor of Austria as "Emperor of Austria." Francis I. His motive in doing so was to guard ^{of} against the great house of Habsburg being relegated ^{Austria.} to a position inferior to the *parvenus* Bonapartes, in the event of the final collapse of the Holy Roman Empire, or of the possible election of Napoleon as his own successor on the throne of Charlemagne. The title emperor of Austria, then, replaced that of "Imperator Romanorum semper Augustus" when the Holy Empire came to an end in 1806. From the first, however, it was no more than a title, which represented but all the actual relation of the Habsburg sovereigns to their several states.

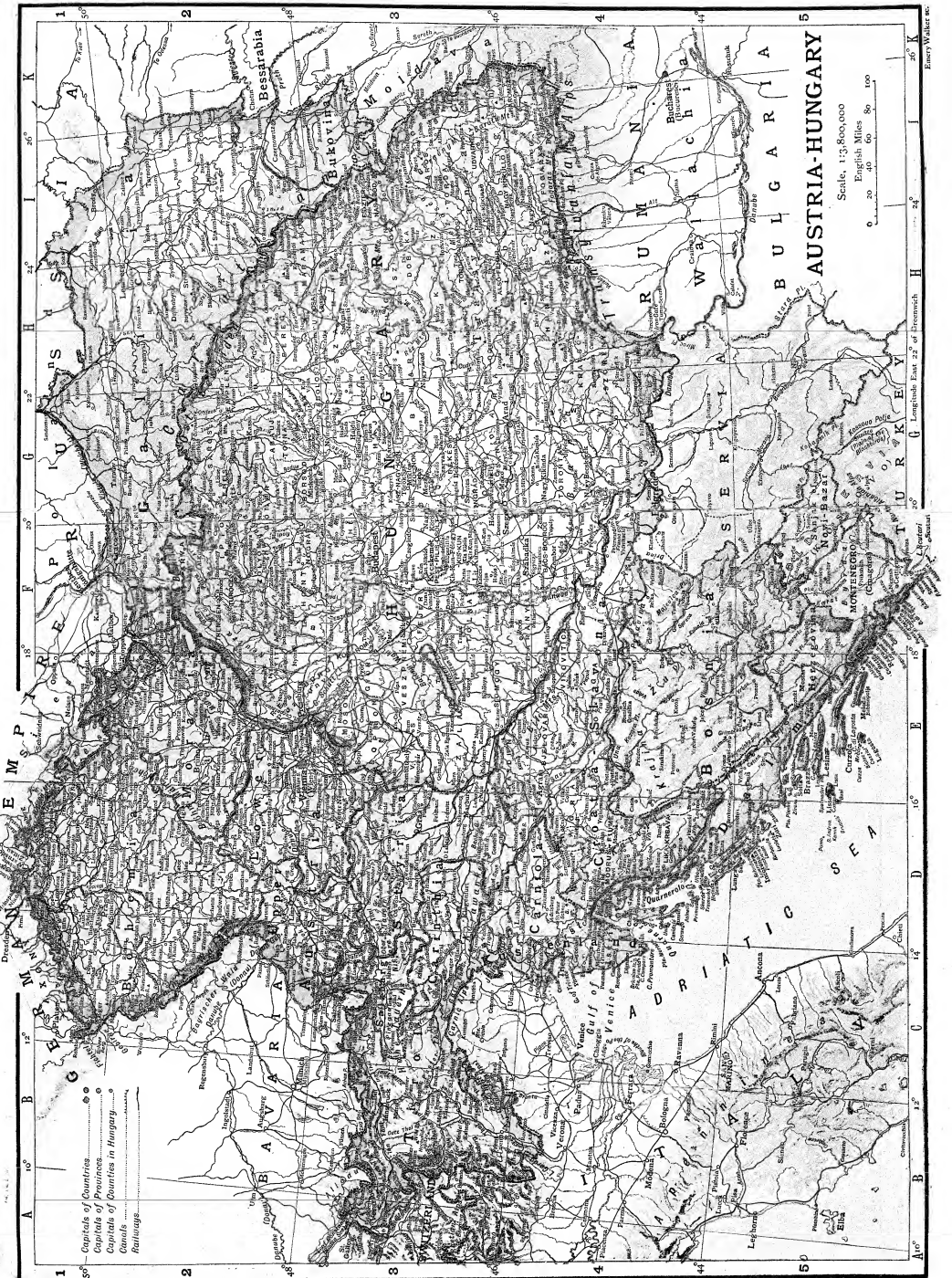

Capitals of Countries ●
 Capitals of Provinces ○
 Capitals of Counties in Hungary ⊙
 Railways ————

Scale, 1:3,800,000

English Miles 0 20 40 60 80 100

10° 12° 14° 16° 18° 20° 22° 24° 26° 28° 30°
 48° 46° 44° 42° 40° 38° 36° 34° 32° 30°
 Longitude East 27° of Greenwich
 H I J K
 A B C D E F G H I J K
 1 2 3 4 5

AUSTRIA-HUNGARY

Bessarabia

Balkan

Adriatic

Black Sea

Constantinople

Serbia

Bulgaria

Ernest W. Weller, Inc.

king of Bohemia. The interests of the Austrian margraves and dukes were not confined to the acquisition of wealth either in land or chattels. Vienna became a centre of culture and learning, and many religious houses were founded and endowed. The acme of the early prosperity of Austria was reached under Duke Leopold II., surnamed the Glorious, who reigned from 1194 to 1230. He gave a code of municipal law to Vienna, and rights to other towns, welcomed the Minnesingers to his brilliant court, and left to his subjects an enduring memory of valour and wisdom. Leopold and his predecessors were enabled, owing to the special position of Austria, to act practically as independent rulers. Cherishing the privilege of 1156, they made treaties with foreign kings, and arranged marriages with the great families of Europe. With full control of jurisdiction and of commerce, no great bishopric nor imperial city impeded the course of their authority, and the emperor interfered only to settle boundary disputes.

The main lines of Austrian policy under the Babenbergs were warfare with the Hungarians and other eastern neighbours, and a general attitude of loyalty towards the emperors. The story of the Hungarian wars is a monotonous record of forays, of assistance given at times to the Babenbergs by the forces of the Empire, and ending in the gradual eastward advance of Austria. The traditional loyalty to the emperors, which was cemented by several marriages between the imperial house and the Babenbergs, was, however, departed from by the margrave Leopold II., and by Duke Frederick II. During the investiture struggle Leopold deserted the emperor Henry IV., who deprived him of Austria and conferred it upon Vratislav II., duke of the Bohemians. Unable to maintain his position, Vratislav was soon driven out, and in 1083 Leopold again obtained possession of the mark, and was soon reconciled with Henry. Very similar

was the result of the conflict between the emperor Frederick II. and Duke Frederick II. Ignoring the privilege of 1156, the emperor claimed certain rights in Austria, and summoned the duke to his Italian diets.

Frederick, who was called the Quarrelsome, had irritated both his neighbours and his subjects, and complaints of his exactions and confiscations reached the ears of the emperor. After the duke had three times refused to appear before the princes, Frederick placed him under the ban, declared the duchies of Austria and Styria to be vacant, and, aided by the king of Bohemia, the duke of Bavaria and other princes, invaded the country in 1236. He met with very slight opposition, declared the duchies to be immediately dependent upon the Empire, made Vienna an imperial city, and imposed other changes upon

the constitution of Austria. After his departure, however, the duke returned, and in 1239 was in possession of his former power, while the changes made by the emperor were ignored. Continuing his career of violence and oppression, Duke Frederick was killed in battle by the Hungarians in June 1246, when the family of Babenberg became extinct.

The duchies of Austria and Styria were now claimed by the emperor Frederick II. as vacant fiefs of the Empire, and their government was entrusted to Otto II., duke of Bavaria. Frederick, however, who was in Italy, harassed and afflicted, could do little to assert the imperial authority, and his enemy, Pope Innocent IV., bestowed the two duchies upon Hermann VI., margrave of Baden, whose wife, Gertrude, was a niece of the last of the Babenbergs. Hermann was invested by the German king, William, count of Holland, but he was unable to establish his position, and law and order were quickly disappearing from the duchies. The deaths of Hermann and of the emperor in 1250, however, paved the way for a settlement. Weary of struggle and disorder, and despairing of any help from the central authority, the estates of Austria met at Trübensee in 1251, and chose Ottakar, son of Wenceslaus I., king of Bohemia, as their duke. This step was favoured by the pope, and Ottakar, eagerly accepting the offer, strengthened his position by marrying Margaret, a sister of Duke Frederick II., and in return for his investiture promised

his assistance to William of Holland. Styria appears at this time to have shared the fortunes of Austria, but it was claimed by Bela IV., king of Hungary, who conquered the land, and made a treaty with Ottakar in 1254 which confirmed him in its possession. The Hungarian rule was soon resented by the Styrians, and Ottakar, who had become king of Bohemia in 1253, took advantage of this resentment, and interfered in the affairs of the duchy. A war with Hungary was the result, but on this occasion victory rested with Ottakar, and by a treaty made with Bela, in March 1261, he was recognized as duke of Styria. In 1269 Ottakar inherited the duchy of Carinthia on the death of Duke Ulrich III., and, his power having now become very great, he began to aspire to the German throne. He did something to improve the condition of the duchies by restoring order, introducing German colonists into the eastern districts, and seeking to benefit the inhabitants of the towns.

In 1273 Rudolph, count of Habsburg, became German king, and his attention soon turned to Ottakar, whose power menaced the occupant of the German throne. Finding some support in Austria, Rudolph questioned the title of the Bohemian king to the three duchies, and sought to recover the imperial lands which had been in the possession of the emperor Frederick II. Ottakar was summoned twice before the diet, the imperial court declared against him, and in July 1275 he was placed under the ban. War was the result, and in November 1276 Ottakar submitted to Rudolph, and renounced the duchies of Austria, Styria and Carinthia. For some time the three duchies were administered by Rudolph in his capacity as head of the Empire, of which they formed part. Not content with this tie, however, which was personal to himself alone, the king planned to make them hereditary possessions of his family, and to transfer the headquarters of the Habsburgs from the Rhine to the Danube. Some opposition was offered to this scheme; but the perseverance of the king overcame all difficulties, and one of the most important events in European history took place on the 27th of December 1282, when Rudolph invested his sons, Rudolph and Albert, with the duchies of Austria and Styria. He retained Carinthia in his own hands until 1286, when, in return for valuable services, he bestowed it upon Meinhard IV., count of Tirol. The younger Rudolph

took no part in the government of Austria and Styria, which was undertaken by Albert, until his election as German king in 1298. Albert appears to have been rather an arbitrary ruler. In 1288 he suppressed a rising of the people of Vienna, and he made the fullest use of the ducal power in asserting his real or supposed rights. At this time the principle of primogeniture was unknown in the house of Habsburg, and for many years the duchies were ruled in common by two, or even three, members of the family. After Albert became German king, his two elder sons, Rudolph and Frederick, were successively associated with him in the government, and after his death in 1308, his four younger sons shared at one time or another in the administration of Austria and Styria. In 1314 Albert's son, Frederick, was chosen German king in opposition to Louis IV., duke of Upper Bavaria, afterwards the emperor Louis IV., and Austria was weakened by the efforts of the Habsburgs to sustain Frederick in his contest with Louis, and also by the struggle carried on between another brother, Leopold, and the Swiss. A series of deaths among the Habsburgs during the first half of the 14th century left Duke Albert II. and his four sons as the only representatives of the family. Albert ruled the duchies alone from 1344 to 1356, and after this date his sons began to take part in the government. The most noteworthy of these was Duke Rudolph IV.,

a son-in-law of the emperor Charles IV., who showed his interest in learning by founding the university of Vienna in 1365. Rudolph's chief aim was to make Austria into an independent state, and he forged a series of privileges the purport of which was to free the duchy from all its duties towards the Empire. A sharp contest with the emperor followed this proceeding, and the Austrian duke, annoyed that

Ottakar of Bohemia, duke.

Rudolph of Habsburg.

The Habsburgs established in Austria, 1282.

Duke Rudolph IV.

Magyars and Slavs never willingly recognized a style which ignored their national rights and implied the superiority of the German elements of the monarchy; to the Germans it was a poor substitute for a title which had represented the political unity of the German race under the Holy Empire. For long after the Vienna Congress of 1814-1815 the "Kaiser" as such exercised a powerful influence over the imaginations of the German people outside the Habsburg dominions; but this was because the title was still surrounded with its ancient halo and the essential change was not at once recognized. The outcome of the long struggle with Prussia, which in 1866 finally broke the spell, and the proclamation of the German empire in 1871 left the title of emperor of Austria stripped of everything but a purely territorial significance. It had, moreover, by the compact with Hungary of 1867, ceased even fully to represent the relation of the emperor to all his dominions; and the title which had been devised to cover the whole of the Habsburg monarchy sank into the official style of the sovereign of but a half; while even within the Austrian empire proper it is resented by those peoples which, like the Bohemians, wish to obtain the same recognition of their national independence as was conceded to Hungary. In placing the account of the origin and development of the Habsburg monarchy under this heading, it is merely for the sake of convenience.

The first nucleus round which the present dominions of the house of Austria gradually accumulated was the mark which lay along the south bank of the Danube, east of the river Enns, founded about A.D. 800 as a defence for the Frankish kingdom against the Slavs. Although its total length from east to west was only about 60 m., it was associated in the popular mind with a large and almost unbroken tract of land in the east of Europe. This fact, together with the position of the mark with regard to Germany in general and to Bavaria in particular, accounts for the name *Österreich* (Austria), i.e. east empire or realm, a word first used in a charter of 906, where the phrase *in regione vulgaris nomine Ostarrichi* occurs. The development of this small mark into the Austro-Hungarian monarchy was a slow and gradual process, and falls into two main divisions, which almost coincide with the periods during which the dynasties of Babenberg and Habsburg have respectively ruled the land. The energies of the house of Babenberg were chiefly spent in enlarging the area and strengthening the position of the mark itself, and when this was done the house of Habsburg set itself with remarkable perseverance and marvellous success to extend its rule over neighbouring territories. The many vicissitudes which have attended this development have not, however, altered the European position of Austria, which has remained the same for over a thousand years. Standing sentinel over the valley of the middle Danube, and barring the advance of the Slavs on Germany, Austria, whether mark, duchy or empire, has always been the meeting-place of the Teuton and the Slav. It is this fact which gives it a unique interest and importance in the history of Europe, and which unites the ideas of the Germans to-day with those of Charlemagne and Otto the Great.

The southern part of the country now called Austria was inhabited before the opening of the Christian era by the Taurisci, a Celtic tribe, who were subsequently called the Norici, and who were conquered by the Romans about 14 B.C.

Their land was afterwards included in the provinces of Pannonia and Noricum, and under Roman rule, Vindobona, the modern Vienna, became a place of some importance. The part of the country north of the Danube was peopled by the Marcomanni and the Quadi, and both of these tribes were frequently at war with the Romans, especially during the reign of the emperor Marcus Aurelius, who died at Vindobona in A.D. 180 when campaigning against them. Christianity and civilization obtained entrance into the land, but the increasing weakness of the Roman empire opened the country to the inroads of the barbarians, and during the period of the great migrations it was ravaged in quick succession by a number of these tribes, prominent among whom were the Huns. The lands on both banks of the

river shared the same fate, due probably to the fact to which Gibbon has drawn attention, that at this period the Danube was frequently frozen over. About 590 the district was settled by the Slovenes, or Corutanes, a Slavonic people, who formed part of the kingdom of Samo, and were afterwards included in the extensive kingdom of the Avars. The Franks claimed some authority over this people, and probably some of the princes of the Slovenes had recognized this claim, but it could not be regarded as serious while the Avars were in possession of the land. In 791 Charlemagne, after he had established his authority over the *Bajuvarii* or Bavarians, crossed the river Enns, and moved against the Avars. This attack was followed by campaigns on the part of his lieutenants, and in 805 the Avars were finally subdued, and their land incorporated with the Frankish empire. This step brought the later Austria definitely under the rule of the Franks, and during the struggle Charlemagne erected a mark, called the East Mark, to defend the eastern border of his empire. A series of margraves ruled this small district from 799 to 907, but as the Frankish empire grew weaker, the mark suffered more and more from the ravages of its eastern neighbours. During the 9th century the Frankish supremacy vanished, and the mark was overrun by the Moravians, and then by the Magyars, or Hungarians, who destroyed the few remaining traces of Frankish influence.

A new era dawned after Otto the Great was elected German king in 936, and it is Otto rather than Charlemagne who must be regarded as the real founder of Austria. In August 955 he gained a great victory over the Magyars on the Lechfeld, freed Bavaria from their presence, and re-founded the East Mark for the defence of his kingdom.

In 976 his son, the emperor Otto II, entrusted the government of this mark, soon to be known as Austria, to Leopold, a member of the family of Babenberg (*q.v.*), and its administration was conducted with vigour and success. Leopold and his descendants ruled Austria until the extinction of the family in 1246, and by their skill and foresight raised the mark to an important place among the German states. Their first care was to push its eastern frontier down the Danube valley, by colonizing the lands on either side of the river, and the success of this work may be seen in the removal of their capital from Pöchlarn to Melk, then to Tulln, and finally about 1140 to Vienna. The country as far as the Leitha was subsequently incorporated with Austria, and in the other direction the district between the Enns and the Inn was added to the mark in 1156, an important date in Austrian history. Anxious to restore peace to Germany in this year, the new king, Frederick I., raised Austria to the rank of a duchy, and conferred upon it exceptional privileges. The investiture was bestowed not only upon Duke Henry but upon his second wife, Theodora; in case of a failure of male heirs the duchy was to descend to females; and if the duke had no children he could nominate his successor. Controlling all the jurisdiction of the land, the duke's only duties towards the Empire were to appear at any diet held in Bavaria, and to send a contingent to the imperial army for any campaigns in the countries bordering upon Austria. In 1186 Duke Leopold I. made a treaty with Ottakar IV., duke of Styria, an arrangement which brought Styria and upper Austria to the Babenbergs in 1192, and in 1229 Duke Leopold II. purchased some lands from the bishop of Freising, and took the title of lord of Carniola. When the house of Babenberg became extinct in 1246, Austria, stretching from Passau almost to Pressburg, had the frontiers which it retains to-day, and this increase of territory had been accompanied by a corresponding increase in wealth and general prosperity. The chief reason for this prosperity was the growth of trade along the Danube, which stimulated the foundation, or the growth, of towns, and brought considerable riches to the ruler. Under the later Babenbergs Vienna was regarded as one of the most important of German cities, and it was computed that the duke was as rich as the archbishop of Cologne, or the margrave of Brandenburg, and was surpassed in this respect by only one German prince, the

Establishment of the East Mark.

The house of Babenberg.

Duchy of Austria created, 1156.

Origin of the name Austria.

Early inhabitants.

Austria was not raised to the dignity of an electorate by the Golden Bull of 1356, did not shrink from a contest with Charles. In 1361, however, he abandoned his pretensions, but claimed the title of archduke (*g.v.*) and in 1364 declared that the possessions of the Habsburgs were indivisible. Meanwhile the acquisition of neighbouring territories had been steadily pressed on. In 1335 the duchy of Carinthia, and a part of Carniola, were inherited by Dukes Albert II. and Otto, and in 1363 Rudolph IV. obtained the county of Tirol. In 1364 Carniola was made into an hereditary duchy; in 1374 part of Istria came under the rule of the Habsburgs; in 1382 Trieste submitted voluntarily to Austria, and at various times during the century, other smaller districts were added to the lands of the Habsburgs.

Rudolph IV. died childless in 1365, and in 1379 his two remaining brothers, Leopold III. and Albert III., made a division of their lands, by which Albert retained Austria proper and Carniola, and Leopold got Styria, Carinthia and Tirol. Leopold was killed in 1386 at the battle of Sempach, and Albert became guardian for his four nephews, who subsequently ruled their lands in common. The senior line which ruled in Austria was represented after the death of Duke Albert III. in 1305 by his son, Duke Albert IV., and then by his grandson, Duke Albert V., who became German king as Albert II. in 1438. Albert married Elizabeth, daughter of Sigismund, king of Hungary and Bohemia, and on the death of his father-in-law assumed these two crowns. He died in 1439, and just after his death a son was born to him, who was called Ladislaus

Minority of Ladislaus.

Posthumus, and succeeded to the duchy of Austria and to the kingdoms of Hungary and Bohemia. William and Leopold, the two eldest sons of Duke Leopold III., and, with their younger brothers Ernest and Frederick, the joint rulers of Styria, Carinthia and Tirol, died early in the 15th century, and in 1406 Ernest and Frederick made a division of their lands. Ernest became duke of Styria and Carinthia, and Frederick, count of Tirol. Ernest was succeeded in 1424 by his sons, Frederick and Albert, and Frederick in 1439 by his son, Sigismund, and these three princes were reigning when King Albert II. died in 1439. Frederick, who succeeded Albert as German king, and was soon crowned emperor as Frederick III., acted as guardian for Sigismund of Tirol, who was a minor, and also became regent of Austria in consequence of the infancy of Ladislaus. His rule was a period of struggle and disorder, owing partly to the feebleness of his own character, partly to the wish of his brother, Albert, to share his dignities. The Tirolese soon grew weary of his government, and, in 1446, Sigismund was declared of age. The estates of Austria were equally discontented and headed an open revolt, the object of which was to remove Ladislaus from Frederick's charge and deprive the latter of the regency. The

leading spirit in this movement was Ulrich Eiczing (Eitzing or von Eiczinger, d. before 1463), a low-born adventurer, ennobled by Albert II., in whose service he had accumulated vast wealth and power. In 1457 he organized an armed league, and in December, with the aid of the populace, made himself master of Vienna, whither he had summoned the estates. In March 1452 he was joined by Count Ulrich of Cilli, while the Hungarians and the powerful party of the great house of Rosenberg in Bohemia attached themselves to the league. Frederick, who had hurried back from Italy, was besieged in August in the Vienna Neustadt, and was forced to deliver Ladislaus to Count Ulrich, whose influence had meanwhile eclipsed that of Eiczing. Ladislaus now ruled nominally himself, under the tutelage of Count Ulrich. The country was, however, distracted by quarrels between the party of the high aristocracy, which recognized the count of Cilli as its chief, and that of the lesser nobles, citizens and populace, who followed Eiczing. In September 1453 the latter, by a successful *émeute*, succeeded in ousting Count Ulrich, and remained in power till February 1455, when the count once more entered Vienna in triumph. Ulrich of Cilli was killed before Belgrade in November 1456; a year later Ladislaus himself died (November 1457). Meanwhile Styria and Carinthia

were equally unfortunate under the rule of Frederick and Albert; and the death of Ladislaus led to still further complications. Austria, which had been solemnly created an archduchy by the emperor Frederick in 1453, was claimed by the three remaining Habsburg princes, and lower Austria was secured by Frederick, while Albert obtained upper Austria. Both princes were unpopular, and in 1462 Frederick was attacked by the inhabitants of Vienna; and was forced to surrender lower Austria to Albert, whose spendthrift habits soon made his rule disliked. A further struggle between the brothers was prevented by Albert's death in 1463, when the estates did homage to Frederick. The emperor was soon again at issue with the Austrian nobles, and was attacked by Matthias Corvinus, king of Hungary, who drove him from Vienna in 1485. Although hampered by the inroads of the Turks, Matthias pressed on, and by 1487 was firmly in possession of Austria, Styria and Carinthia, which seemed quite lost to the Habsburgs.

Austria created an archduchy.

Hungarian conquest of Austria.

The decline in the fortunes of the family, however, was to be arrested by Frederick's son, Maximilian, afterwards the emperor Maximilian I., who was the second founder of the greatness of the house of Habsburg. Like his ancestor, Rudolph, he had to conquer the lands over which his descendants were destined to rule, and by arranging a treaty of succession to the kingdoms of Hungary and Bohemia, he pointed the way to power and empire in eastern Europe. Soon after his election as king of the Romans in 1486, Maximilian attacked the Hungarians, and in 1490 he had driven them from Austria, and recovered his hereditary lands. In the same year he made an arrangement with his kinsman, Sigismund of Tirol, by which he brought this county under his rule, and when the emperor Frederick died in 1493, Maximilian united the whole of the Austrian lands under his sway.

The emperor Maximilian I.

Continuing his acquisitions of territory, he inherited the possessions of the counts of Görz in 1500, added some districts to Tirol by intervening in a succession war in Bavaria, and acquired Gradisca in 1512 as the result of a struggle with Venice. He did much for the better government of the Austrian duchies. Bodies were established for executive, financial and judicial purposes, the Austrian lands constituted one of the imperial circles which were established in 1512, and in 1518 representatives of the various diets (*Landtage*) met at Innsbruck, a proceeding which marks the beginning of an organic unity in the Austrian lands. In these ways Maximilian proved himself a capable and energetic ruler, although his plans for making Austria into a kingdom, or an electorate, were abortive.

At the close of the middle ages the area of Austria had increased to nearly 50,000 sq. m., but its internal condition does not appear to have improved in proportion to this increase in size. The rulers of Austria lacked the prestige which attached to the electoral office, and, although five of them had held the position of German king, the four who preceded Maximilian had added little or nothing to the power and dignity of this office. The ecclesiastical organization of Austria was imperfect, so long as there was no archbishopric within its borders, and its clergy owed allegiance to foreign prelates. The work of unification which was so successfully accomplished by Maximilian was aided by two events, the progress of the Turks in south-eastern Europe, and the loss of most of the Habsburg possessions on the Rhine. The first tended to draw the separate states together for purposes of defence, and the second turned the attention of the Habsburgs to the possibilities of expansion in eastern Europe. (A. W. H.*)

Austria at the close of the middle ages.

At the time of the death of the emperor Maximilian in 1519 the Habsburg dominions in eastern Germany included the duchies of Upper and Lower Austria, Styria, Carinthia, Carniola and the county of Tirol. Maximilian was succeeded as archduke of Austria as well as emperor by his grandson Charles of Spain, known in history as the emperor Charles V. To his brother Ferdinand Charles resigned all his Austrian lands, including his claims on Bohemia

Austria under Charles V. and Ferdinand.

and Hungary. Austria and Spain were thus divided, and, in spite of the efforts of the archduke Charles in the Spanish Succession War, were never again united, for at the battle of

Mohács and **its results.** Mohács, on the 28th of August 1526, Suleiman the Magnificent defeated and killed Louis, king of Bohemia and of Hungary, whose sister Anne had married Ferdinand.

By this victory the Turks conquered and retained, till the peace of Karlowitz in 1699, the greater part of Hungary. During most of his life Ferdinand was engaged in combating the Turks and in attempting to secure Hungary. In John Zápolya, who was supported by Suleiman, Ferdinand found an active rival. The Turks besieged Vienna in 1530 and made several invasions of Hungary and Austria. At length Ferdinand agreed to pay Suleiman an annual tribute for the small portion—about 12,228 sq. m.—of Hungary which he held. During Charles V.'s struggles with the German Protestants, Ferdinand preserved a neutral attitude, which contributed to gain Germany a short period of internal peace. Though Ferdinand himself did not take a leading part in German religious or foreign politics, the period was one of intense interest to Austria. Throughout the years from 1519 to 1648 there are, said Stubbs, two distinct ideas in progress which "may be regarded as giving a unity to the whole period. . . . The Reformation is one, the claims of the House of Austria is the other." Austria did not benefit from the reign of Charles V. The emperor was too much

Charles V. and Austria. absorbed in the affairs of the rest of his vast dominions, notably those of the Empire, rent in two by religious differences and the secular ambitions for which those were the excuse, to give any effective attention to its needs. The peace of Augsburg, 1555, which recognized a dualism within the Empire in religion as in politics, marked the failure of his plan of union (see CHARLES V.; GERMANY; MAURICE OF SAXONY); and meanwhile he had been able to accomplish nothing to rescue Hungary from the Turkish yoke. It was left for his brother Ferdinand, a ruler of consummate wisdom (1556-1564) "to establish the modern Habsburg-Austrian empire with its exclusive territorial interests, its administrative experiments, its intricacies of religion and of race."

Before his death Ferdinand divided the inheritance of the German Habsburgs between his three sons. Austria proper was left to his eldest son Maximilian, Tirol to the archduke Ferdinand; and Styria with Carinthia and Carniola to the archduke Charles. Under the emperor Maximilian II. (1564-1576), who was also king of Bohemia and Hungary, a liberal policy preserved peace, but he was unable to free his government from its humiliating position of a tributary to the Turk, and he could do nothing to found religious liberty within his dominions on a permanent basis. The whole of Austria and nearly the whole of Styria were mainly Lutheran; in Bohemia, Silesia and Moravia, various forms of Christian belief struggled for mastery; and Catholicism was almost confined to the mountains of Tirol.

The reign of Rudolph II. The accession of Rudolph II.¹ (1576-1612), a fanatical Spanish Catholic, changed the situation entirely. Under him the Jesuits were encouraged to press on the counter-Reformation. In the early part of his reign there was hardly any government at all. In Bohemia a state of semi-independence existed, while Hungary preferred the Turk to the emperor. In both kingdoms Rudolph had failed to assert his sovereign power except in fitful attempts to extirpate heresy. With anarchy prevalent within the Austrian dominions some action became necessary. Accordingly in 1606 the archdukes made a compact agreeing to acknowledge the archduke Matthias as head of the family. This arrangement proved far from successful. Matthias, who was emperor from 1612 to 1619, proved unable to restore order, and when he died Bohemia was practically independent. His successor Ferdinand II. (1619-1637) was strong of will; and resolved to win back Germany to the Catholic faith. As archduke of Styria he had crushed out Protestantism in that duchy, and having been elected king of Bohemia in 1618

The family compact, 1606. was resolved to establish there the rule of the Jesuits. His attempt to do so led to the outbreak of the Thirty Years' War (see BOHEMIA; THIRTY YEARS' WAR). Till 1630 the fortunes of Austria brightened under the active rule of Ferdinand, who was assisted by Maximilian of Bavaria and the Catholic League, and by Wallenstein. The Palatinate was conquered, the Danish king was overthrown, and it seemed that Austria would establish its predominance over the whole of Germany, and that the Baltic would become an Austrian lake. The fortunes of Austria never seemed brighter than in 1628 when Wallenstein began the siege of Stralsund. His failure, followed by the arrival of Gustavus Adolphus in Germany in 1630, proved the death blow of Austrian hopes. In 1632 Gustavus Adolphus was killed, in 1634 Wallenstein was assassinated, and in 1635 France entered into the war. The Thirty Years' War now ceased to be a religious struggle between Catholicism and Protestantism; it resolved itself into a return to the old political strife between France and the Habsburgs. Till 1648 the Bourbon and Habsburg powers continued the war, and at the peace of Westphalia Austria suffered severe losses. Ferdinand III. (1637-1657) was forced to yield Alsace to France, to grant territorial supremacy, including the right of making alliances, to the states of the Empire, and to acknowledge the concurrent jurisdiction of the imperial chamber and the Aulic council. The disintegration of the Holy Roman Empire was now practically accomplished, and though the possession of the imperial dignity continued to give the rulers of Austria prestige, the Habsburgs henceforward devoted themselves to their Austrian interests rather than to those of the Empire.

Leopold I. In 1657 Leopold I., who had already ruled the Austrian dominions for two years, succeeded his father Ferdinand and was crowned emperor in the following year. His long reign of 48 years was of great importance for Austria, as determining both the internal character and the external policy of the monarchy. The long struggle with France to which the ambitions of Louis XIV. gave rise, and which culminated in the War of Spanish Succession, belongs less to the history of Austria proper than to that of Germany and of Europe. Of more importance to Austria itself was the war with Sweden (1657-60) which resulted in the peace of Oliva, by which the independence of Poland was secured and the frontier of Hungary safeguarded, and the campaigns against the Turks (1662-64 and 1683-99), by which the Ottoman power was driven from Hungary, and the Austrian attitude towards Turkey and the Slav peoples of the Balkans determined for a century to come. The first war, due to Ottoman aggression in Transylvania, ended with Montecuculi's victory over the grand vizier at St Gothard on the Raab on the 1st of August 1664.

The general political situation prevented Leopold from taking full advantage of this, and the peace of Vasvár (August 10) left the Turks in possession of Nagyvarad (Grosswardein) and the fortress of Érsekújvár (Neuhäusel), Transylvania being recognized as an independent principality. The next Turkish war was the direct outcome of Leopold's policy in Hungary, where the persecution of the Protestants and the suppression of the constitution in 1658, led to a widespread conspiracy. This was mercilessly suppressed; and though after a period of arbitrary government (1672-1679), the palatinate and the constitution, with certain concessions to the Protestants, were restored, the discontent continued. In 1683, invited by Hungarian malcontents and spurred on by Louis XIV., the Turks burst into Hungary, overran the country and appeared before the walls of Vienna. The victory of the 12th of September, gained over the Turks by John Sobieski (see JOHN III. SOBIESKI, KING OF POLAND) not only saved the Austrian capital, but was the first of a series of successes which drove the Turks permanently beyond the Danube, and established the power of Austria in the East. The victories of Charles of Lorraine at Parkány (1683) and Esztergom (Gran) (1685) were followed by the capture of Budapest (1686) and the defeat of the Ottomans at

was resolved to establish there the rule of the Jesuits. His attempt to do so led to the outbreak of the Thirty Years' War (see BOHEMIA; THIRTY YEARS' WAR). Till 1630 the fortunes of Austria brightened under the active rule of Ferdinand, who was assisted by Maximilian of Bavaria and the Catholic League, and by Wallenstein. The Palatinate was conquered, the Danish king was overthrown, and it seemed that Austria would establish its predominance over the whole of Germany, and that the Baltic would become an Austrian lake. The fortunes of Austria never seemed brighter than in 1628 when Wallenstein began the siege of Stralsund. His failure, followed by the arrival of Gustavus Adolphus in Germany in 1630, proved the death blow of Austrian hopes. In 1632 Gustavus Adolphus was killed, in 1634 Wallenstein was assassinated, and in 1635 France entered into the war. The Thirty Years' War now ceased to be a religious struggle between Catholicism and Protestantism; it resolved itself into a return to the old political strife between France and the Habsburgs. Till 1648 the Bourbon and Habsburg powers continued the war, and at the peace of Westphalia Austria suffered severe losses. Ferdinand III. (1637-1657) was forced to yield Alsace to France, to grant territorial supremacy, including the right of making alliances, to the states of the Empire, and to acknowledge the concurrent jurisdiction of the imperial chamber and the Aulic council. The disintegration of the Holy Roman Empire was now practically accomplished, and though the possession of the imperial dignity continued to give the rulers of Austria prestige, the Habsburgs henceforward devoted themselves to their Austrian interests rather than to those of the Empire.

The Swedish and French intervention. In 1657 Leopold I., who had already ruled the Austrian dominions for two years, succeeded his father Ferdinand and was crowned emperor in the following year. His long reign of 48 years was of great importance for Austria, as determining both the internal character and the external policy of the monarchy. The long struggle with France to which the ambitions of Louis XIV. gave rise, and which culminated in the War of Spanish Succession, belongs less to the history of Austria proper than to that of Germany and of Europe. Of more importance to Austria itself was the war with Sweden (1657-60) which resulted in the peace of Oliva, by which the independence of Poland was secured and the frontier of Hungary safeguarded, and the campaigns against the Turks (1662-64 and 1683-99), by which the Ottoman power was driven from Hungary, and the Austrian attitude towards Turkey and the Slav peoples of the Balkans determined for a century to come. The first war, due to Ottoman aggression in Transylvania, ended with Montecuculi's victory over the grand vizier at St Gothard on the Raab on the 1st of August 1664.

The general political situation prevented Leopold from taking full advantage of this, and the peace of Vasvár (August 10) left the Turks in possession of Nagyvarad (Grosswardein) and the fortress of Érsekújvár (Neuhäusel), Transylvania being recognized as an independent principality. The next Turkish war was the direct outcome of Leopold's policy in Hungary, where the persecution of the Protestants and the suppression of the constitution in 1658, led to a widespread conspiracy. This was mercilessly suppressed; and though after a period of arbitrary government (1672-1679), the palatinate and the constitution, with certain concessions to the Protestants, were restored, the discontent continued. In 1683, invited by Hungarian malcontents and spurred on by Louis XIV., the Turks burst into Hungary, overran the country and appeared before the walls of Vienna. The victory of the 12th of September, gained over the Turks by John Sobieski (see JOHN III. SOBIESKI, KING OF POLAND) not only saved the Austrian capital, but was the first of a series of successes which drove the Turks permanently beyond the Danube, and established the power of Austria in the East. The victories of Charles of Lorraine at Parkány (1683) and Esztergom (Gran) (1685) were followed by the capture of Budapest (1686) and the defeat of the Ottomans at

Wars with Turkey.

Leopold I. In 1657 Leopold I., who had already ruled the Austrian dominions for two years, succeeded his father Ferdinand and was crowned emperor in the following year. His long reign of 48 years was of great importance for Austria, as determining both the internal character and the external policy of the monarchy. The long struggle with France to which the ambitions of Louis XIV. gave rise, and which culminated in the War of Spanish Succession, belongs less to the history of Austria proper than to that of Germany and of Europe. Of more importance to Austria itself was the war with Sweden (1657-60) which resulted in the peace of Oliva, by which the independence of Poland was secured and the frontier of Hungary safeguarded, and the campaigns against the Turks (1662-64 and 1683-99), by which the Ottoman power was driven from Hungary, and the Austrian attitude towards Turkey and the Slav peoples of the Balkans determined for a century to come. The first war, due to Ottoman aggression in Transylvania, ended with Montecuculi's victory over the grand vizier at St Gothard on the Raab on the 1st of August 1664.

Mohács (1688). In 1688 the elector took Belgrade; in 1691 Louis William I. of Baden won the battle of Slankamen, and on the 11th of September 1697 Prince Eugene gained the crowning victory of Zenta. This was followed, on the 26th of January 1699, by the peace of Karlowitz, by which Slavonia, Transylvania and all Hungary, except the banat of Temesvár, were ceded to the Austrian crown. Leopold had wisely decided to initiate a conciliatory policy in Hungary. At the diet of Pressburg (1687-1688) the Hungarian crown had been made hereditary in the house of Habsburg, and the crown prince Joseph had been crowned hereditary king of Hungary (q.v.). In 1697 Transylvania was united to the Hungarian monarchy. A further fact of great prospective importance was the immigration, after an abortive rising against the Turks, of some 30,000 Slav and Albanian families into Slavonia and southern Hungary, where they were granted by the emperor Leopold a certain autonomy and the recognition of the Orthodox religion.

By the conquest of Hungary and Transylvania Leopold completed the edifice of the Austrian monarchy, of which the foundations had been laid by Ferdinand I. in 1526. He had also done much for its internal consolidation. By the death of the archduke Sigismund in 1665 he not only gained Tirol, but a considerable sum of money, which he used to buy back the Silesian principalities of Oppeln and Ratibor, pledged by Ferdinand III. to the Poles. In the administration of his dominions, too, Leopold succeeded in strengthening the authority of the central government. The old estates, indeed, survived; but the emperor kept the effective power in his own hands, and to his reign are traceable the first beginnings of that system of centralized bureaucracy which was established under Maria Theresa and survived, for better or for worse, till the revolution of 1848. It was under Leopold, also, that the Austrian standing army was established in spite of much opposition; the regiments raised in 1672 were never disbanded. For the intellectual life of the country Leopold did much. In spite of his intolerant attitude towards religious dissent, he proved himself an enlightened patron of learning. He helped in the establishment of the universities of Innsbruck and Olmütz; and under his auspices, after the defeat of the Turks in 1683, Vienna began to develop from a mere frontier fortress into one of the most brilliant capitals of Europe. (See LEOPOLD I.)

Leopold died in 1705 during the war of Spanish Succession (1702-13), which he left as an evil inheritance to his sons Joseph I. (d. 1711) and Charles VI. The result of the war was a further aggrandizement of the house of Austria; but not to the extent that had been hoped. Apart from the fact that British and Austrian troops had been unable to deprive Philip V. of his throne, it was from the point of view of Europe at large by no means desirable that Charles VI. should succeed in reviving the empire of Charles V. By the treaty of Utrecht, accordingly, Spain was left to the House of Bourbon, while that of Austria received the Spanish Netherlands, Sardinia and Naples.

The treaty of Karlowitz, and the settlement of 1713-1714, marked a new starting-point in the history of Austria. The efforts of Turkey to regain her ascendancy in eastern Europe at the expense of the Habsburgs had ended in failure, and henceforward Turkish efforts were confined to resisting the steady development of Austria in the direction of Constantinople. The treaties of Utrecht, Rastadt and Baden had also re-established and strengthened the position of the Austrian monarchy in western Europe. The days of French invasions of Germany had for the time ceased, and revenge for the attacks made by Louis XIV. was found in the establishment of Austrian supremacy in Italy and in the substitution of Austrian for Spanish domination in the Netherlands.

The situation, though apparently favourable, was full of difficulty, and only a statesman of uncommon dexterity could have guided Austria with success through the ensuing years. Composed of a congeries of nationalities which included Czechs,

Magyars, Ruthenes, Rumanians, Germans, Italians, Flemings and other races, and with territories separated by many miles, the Habsburg dominions required from their ruler patience, tolerance, administrative skill and a full knowledge of the currents of European diplomacy. Charles VI. possessed none of these qualities; and when he died in 1740, the weakness of the scattered Habsburg empire rendered it an object of the cupidity of the continental powers. Yet, though the War of Spanish Succession had proved a heavy drain on the resources of the hereditary dominions of the Austrian crown, Charles VI. had done much to compensate for this by the successes of his arms in eastern Europe. In 1716, in alliance with Venice, he declared war on the Turks; Eugene's victory at Peterwardein involved the conquest of the banat of Temesvár, and was followed in 1717 by the capture of Belgrade. By the treaty signed at Passarowitz on the 21st of July 1718, the banat, which rounded off Hungary and Belgrade, with the northern districts of Serbia, were annexed to the Habsburg monarchy.

Important as these gains were, the treaty none the less more illustrated the perpetual sacrifice of the true interests of the hereditary dominions of the house of Habsburg to its European entanglements. Had the war continued, Austria would undoubtedly have extended her conquests down the Danube. But Charles was anxious about Italy, then in danger from Spain, which under Alberoni's guidance had occupied Sardinia and Sicily. On the 2nd of August 1718, accordingly, Charles joined the Triple Alliance, henceforth the Quadruple Alliance. The coercion of Spain resulted in a peace by which Charles obtained Sicily in exchange for Sardinia. The shifting of the balance of power that followed belongs to the history of Europe (q.v.); for Austria the only important outcome was that in 1731 Charles found himself isolated. Being without a son, he was now anxious to secure the throne for his daughter Maria Theresa, in accordance with the Pragmatic Sanction of the 10th of April 1713, in which he had pronounced the indivisibility of the monarchy, and had settled the succession on his daughter, in default of a male heir. It now became his object to secure the adhesion of the powers to this instrument. In 1731 Great Britain and Holland agreed to respect it, in return for the cession of Parma, Piacenza and Guastalla to Don Carlos; but the hostility of the Bourbon powers continued, resulting in 1733 in the War of Polish Succession, the outcome of which was the acquisition of Lorraine by France, and of Naples, Sicily and the Tuscan ports by Don Carlos, while the power of the Habsburg monarchy in northern Italy was strengthened by the acquisition of Parma, Piacenza and Guastalla. At the same time Spain and Sardinia adhered to the Pragmatic Sanction. Francis, the dispossessed duke of Lorraine, was to be compensated with Tuscany. On the 12th of February 1736 he was married to the archduchess Maria Theresa, and on the 11th of May following he signed the formal act ceding Lorraine to France.

The last years of Charles VI. were embittered by the disastrous outcome of the war with Turkey (1738-1739), on which he had felt compelled to embark in accordance with the terms of a treaty of alliance with Russia signed in 1726. After a campaign of varying fortunes the Turks beat the imperial troops at Krotzka on the 23rd of July 1739 and laid siege to Belgrade, where on the 1st of September a treaty was signed, which, with the exception of the banat, surrendered everything that Austria had gained by the treaty of Passarowitz. On the 20th of October 1740, Charles died, leaving his dominions in no condition to resist the attacks of the powers, which, in spite of having adhered to the Pragmatic Sanction, now sought to profit from their weakness. Yet for their internal development Charles had done much. His religious attitude was moderate and tolerant, and he did his best to promote the enlightenment of his subjects. He was zealous, too, for the promotion of trade and industry, and, besides the East India Company which he established at Ostend, he encouraged the development of Trieste and Fiume as sea-ports and centres of trade with the Levant.

The Pragmatic Sanction.

Treaty of Belgrade, 1739.

War of Spanish Succession.

Austria from 1715 to 1740.

The accession of Maria Theresa to the throne of the Habsburgs marks an important epoch in the history of Austria. For a while, indeed, it seemed that the monarchy was on the point of dissolution. To the diplomacy of the 18th century the breach of a solemn compact was but lightly regarded; and Charles VI. had neglected the advice of Prince Eugene to leave an effective army of 200,000 men as a more solid guarantee of the Pragmatic Sanction than the signatures of the powers. As it was, the Austrian forces, disorganized in the long confusion of the Turkish wars, were in no condition to withstand Frederick the Great, when, in 1740, at the head of the splendid army bequeathed to him by his father, he invaded Silesia (see AUSTRIAN SUCCESSION, WAR OF). The Prussian victory at Mollwitz (April 10, 1741) brought into the field against Austria all the powers which were ambitious of expansion at her expense: France, Bavaria, Spain, Saxony and Sardinia. Nor was the peril wholly external. Apart from the perennial discontents of Magyars and Slavs, the confusion and corruption of the administration, and the misery caused by the ruin of the finances, had made the Habsburg dynasty unpopular even in its German states, and in Vienna itself a large section of public opinion was loudly in favour of the claims of Bavaria. Yet the war, if it revealed the weakness of the Austrian monarchy, revealed also unexpected sources of strength. Not the least of these was the character of Maria Theresa herself, who to the fascination of a young and beautiful woman added a very masculine resolution and judgment. In response to her personal appeal, and also to her wise and timely concessions, the Hungarians had rallied to her support, and for the first time in history awoke not only to a feeling of enthusiastic loyalty to a Habsburg monarch, but also to the realization that their true interests were bound up with those of Austria (see HUNGARY: History). Although, then, as the result of the war, Silesia was by the treaty of Dresden transferred from Austria to Prussia, while in Italy by the treaty of Aix-la-Chapelle in 1748 cessions were made at the expense of the house of Habsburg to the Spanish Don Philip and to Sardinia, the Austrian monarchy as a whole had displayed a vitality that had astonished the world, and was in some respects stronger than at the beginning of the struggle, notably in the great improvement in the army and in the position of generals schooled by the experience of active service.

The period from 1747 to 1756, the year of the outbreak of the Seven Years' War, was occupied in preparations for carrying into effect the determination of Maria Theresa to recover the lost provinces. To give any chance of success, it was recognized that a twofold change of system was necessary: in internal and in external affairs. To strengthen the state internally a complete revolution of its administration was begun under the auspices of Count F. W. Haugwitz (1700-1765); the motley system which had survived from the middle ages was gradually replaced by an administrative machinery uniformly organized and centralized; and the army especially, hitherto patched together from the quotas raised and maintained by the various diets and provincial estates, was withdrawn from their interference. These reforms were practically confined to the central provinces of the monarchy; for in Hungary, as well as in the outlying territories of Lombardy and the Netherlands, it was recognized that the conservative temper of the peoples made any revolutionary change in the traditional system inadvisable.

Meanwhile, in foreign affairs, it had become clear that for Austria the enemy to be dreaded was no longer France, but Prussia, and Kaunitz prepared the way for a diplomatic revolution, which took effect when, on the 1st of May 1756, Austria and France concluded the first treaty of Versailles. The long rivalry between Bourbons and Habsburgs was thus ended, and France and Austria remained in alliance or at peace until the outbreak of the French Revolution. So far as Austria was concerned, the Seven Years' War (q.v.) in which France and Austria were ranged against Prussia and Great Britain, was an attempt on the part of Maria Theresa to recover Silesia. It failed; and the peace of Hubertsburg, signed on the 15th of February 1763, left Germany

divided between Austria and Prussia, whose rivalry for the hegemony was to last until the victory of Königgrätz (1866) definitely decided the issue in favour of the Hohenzollern monarchy.

The loss of Silesia led Austria to look for "compensation" elsewhere. The most obvious direction in which this could be sought was in Bavaria, ruled by the decadent house of Wittelsbach, the secular rival of the house of Habsburg in southern Germany. The question of the annexation of Bavaria by conquest or exchange had occupied the minds of Austrian statesmen throughout the century: it would not only have removed a perpetual menace to the peace of Austria, but would have given to the Habsburg monarchy an overwhelming strength in South Germany. The matter came to an issue in 1777, on the death of the elector Maximilian III. The heir was the elector palatine Charles Theodore, but Joseph II., who had been elected emperor in 1765, in succession to his father, and appointed co-regent with his mother—claimed the inheritance, and prepared to assert his claims by force. The result was the so-called War of Bavarian Succession. As a matter of fact, however, though the armies under Frederick and Joseph were face to face in the field, the affair was settled without actual fighting; Maria Theresa, fearing the chances of another struggle with Prussia, overruled her son at the last moment, and by the treaty of Teschen agreed to be content with the cession of the Quarter of the Inn (Innviertel) and some other districts.

Meanwhile the ambition of Catherine of Russia, and the war with Turkey by which the empire of the tsars was advanced to the Black Sea and threatened to establish itself south of the Danube, were productive of consequences of enormous importance to Austria in the East. Russian control of the Danube was a far more serious menace to Austria than the neighbourhood of the decadent Ottoman power; and for a while the policy of Austria towards the Porte underwent a change that foreshadowed her attitude towards the Eastern Question in the 19th century. In spite of the reluctance of Maria Theresa, Kaunitz, in July 1771, concluded a defensive alliance with the Porte. He would have exchanged this for an active co-operation with Turkey, could Frederick the Great have been persuaded to promise at least neutrality in the event of a Russo-Austrian War. But Frederick was unwilling to break with Russia, with whom he was negotiating the partition of Poland; Austria in these circumstances dared not take the offensive; and Maria Theresa was compelled to purchase the modification of the extreme claims of Russia in Turkey by agreeing to, and sharing in, the spoliation of Poland. Her own share of the spoils was the acquisition, by the first treaty of partition (August 5, 1772), of Galicia and Lodomeria. Turkey was left in the lurch; and Austrian troops even occupied portions of Moldavia, in order to secure the communication between the new Polish provinces and Transylvania. At Constantinople, too, Austria once more supported Russian policy, and was rewarded, in 1777, by the acquisition of Bukovina from Turkey. In Italy the influence of the House of Austria had been strengthened by the marriage of the archduke Ferdinand with the heiress of the d'Estes of Modena, and the establishment of the archduke Leopold in the grand-duchy of Tuscany.

In internal affairs Maria Theresa may be regarded as the practical founder of the unified Austrian state. The new system of centralization has already been referred to. It only remains to add that, in carrying out this system, Maria Theresa was too wise to fall into the errors afterwards made by her son and successor. She was no doctrinaire, and consistently acted on the principle once laid down by Machiavelli, that while changing the substance, the prince should be careful to preserve the form of old institutions. Alongside the new bureaucracy, the old estates survived in somnolent inactivity, and even in Hungary, though the ancient constitution was left untouched, the diet was only summoned four times during the reign, and reforms were carried out, without protest, by royal ordinance. It was under Maria Theresa, too,

Maria Theresa.

Austria and Bavaria.

Russia, Austria and the Ottoman Empire.

Partition of Poland.

Austrian-French alliance, and Seven Years' War.

Internal reforms under Maria Theresa.

that the attempt was first made to make German the official language of the whole monarchy; an attempt which was partly successful even in Hungary, especially so far as the army was concerned, though Latin remained the official tongue of the diet, the county-assemblies and the courts.

The social, religious and educational reforms of Maria Theresa also mark her reign as the true epoch of transition from medieval to modern conditions in Austria. In religious matters the empress, though a devout Catholic and herself devoted to the Holy See, was carried away by the prevailing reaction, in which her ministers shared, against the pretensions of the papacy. The anti-papal tendency, known as Febronianism (*g.v.*), had made immense headway, not only among the laity but among the clergy in the Austrian dominions. By a new law, papal bulls could not be published without the consent of the crown, and the direct intercourse of the bishops with Rome was forbidden; the privileges of the religious orders were curtailed; and the education of the clergy was brought under state control. It was, however, only with reluctance that Maria Theresa agreed to carry out the papal bull suppressing the Society of Jesus; and, while declaring herself against persecution, she could never be persuaded to accept the views of Kaunitz and Joseph in favour of toleration. Parallel with the assertion of the rights of the state as against the church, was the revolution effected in the educational system of the monarchy. This, too, was taken from the control of the church; the universities were remodelled and modernized by the introduction of new faculties, the study of ecclesiastical law being transferred from that of theology to that of jurisprudence, and the elaborate system of elementary and secondary education was established, which survived with slight modification till 1869.

The death of Maria Theresa in 1780 left Joseph II. free to attempt the drastic revolution from above, which had been restrained by the wise statesmanship of his mother. He was himself a strange incarnation at once of doctrinaire liberalism and the old Habsburg autocracy. Of the essential conditions of his empire he was constitutionally unable to form a conception. He was a disciple, not of Machiavelli, but of Rousseau; and his scattered dominions, divided by innumerable divergences of racial and class prejudice, and encumbered with traditional institutions to which the people clung with passionate conservatism, he regarded as so much vacant territory on which to build up his ideal state. He was, in fact, a Revolutionist who happened also to be an emperor. "Reason" and "enlightenment" were his watchwords; opposition to his wise measures he regarded as obscurantist and unreasonable, and unreason, if it proved stubborn, as a vice to be corrected with whips. In this spirit he at once set to work to reconstruct the state, on lines that strangely anticipated the principles of the Constituent Assembly of 1789. He refused to be crowned or to take the oath of the local constitutions, and divided the whole monarchy into thirteen departments, to be governed under a uniform system. In ecclesiastical matters his policy was also that of "reform from above," the complete subordination of the clergy to the state, and the severance of all effective ties with Rome. This treatment of the "Fakirs and Ulemas" (as he called them in his letters), who formed the most powerful element in the monarchy, would alone have ensured the failure of his plans, but failure was made certain by the introduction of the conscription, which turned even the peasants, whom he had done much to emancipate, against him. The threatened revolt of Hungary, and the actual revolt of Tirol and of the Netherlands (see BELGIUM: History) together with the disasters of the war with Turkey, forced him, before he died, to the formal reversal of the whole policy of reform.

In his foreign policy Joseph II. had been scarcely less unhappy. In 1784 he had resumed his plan of acquiring Bavaria for Austria by negotiating with the elector Charles Theodore its exchange for the Netherlands, which were to be erected for his benefit into a "Kingdom of Burgundy." The elector was not unwilling, but the scheme was wrecked by the opposition of the heir to

the Bavarian throne, the duke of Zweibrücken, in response to whose appeal Frederick the Great formed, on the 23rd of July 1785, a confederation of German princes (*Fürstenbund*) for the purpose of opposing the threatened preponderance of Austria. Prussia was thus for the first time formally recognized as the protector of the German states against Austrian ambition, and had at the same time become the centre of an anti-Austrian alliance, which embraced Sweden, Poland and the maritime powers. In these circumstances the war with Turkey, on which Joseph embarked, in alliance with Russia, in 1788, would hardly have been justified by the most brilliant success. The first campaign, however, which he conducted in person was a dismal failure; the Turks followed the Austrian army, disorganized by disease, across the Danube, and though the transferee of the command to the veteran marshal Loudon somewhat retrieved the initial disasters, his successes were more than counterbalanced by the alliance, concluded on the 31st of January 1790, between Prussia and Turkey. Three weeks later, on the 20th of February 1790, Joseph died broken-hearted.

The situation needed all the statesmanship of the new ruler, Leopold II. This was less obvious in his domestic than in his foreign policy, though perhaps equally present. As grand-duke of Tuscany Leopold had won the reputation of an enlightened and liberal ruler; but meanwhile "Josephinism" had not been justified by its results, and the progress of the Revolution in France was beginning to scare even enlightened princes into reaction. Leopold, then, reverted to the traditional Habsburg methods; the old supremacy of the Church, regarded as the one effective bond of empire, was restored; and the *Einheitsstaat* was once more resolved into its elements, with the old machinery of diets and estates, and the old abuses. It was the beginning of that policy of "stability" associated later with Metternich, which was to last till the cataclysm of 1848. For the time, the policy was justified by its results. The spirit of revolutionary France had not yet touched the heart of the Habsburg empire, and national rivalries were expressed, not so much in expansive ambitions, as in a somnolent clinging to traditional privileges. Leopold, therefore, who made his début on the European stage as the executor of the ban of the Empire against the insurgent Liégeois, was free to pose as the champion of order against the Revolution, without needing to fear the resentment of his subjects. He played this rôle with consummate skill in the negotiations that led up to the treaty of Reichenbach (August 15, 1790), which ended the quarrel with Prussia and paved the way to the armistice of Giurgevo with Turkey (September 10). Leopold was now free to deal with the Low Countries, which were reduced to order before the end of the year. On the 4th of August 1791, was signed at Sistova the definitive peace with Turkey, which practically established the *status quo*.

On the 6th of October 1790, Leopold had been crowned Roman emperor at Frankfort, and it was as emperor, not as Habsburg, that he first found himself in direct antagonism to the France of the Revolution. The fact that Leopold's sister, Marie Antoinette, was the wife of Louis XVI. had done little to cement the Franco-Austrian alliance, which since 1763 had been practically non-existent; nor was it now the mainspring of his attitude towards revolutionary France. But by the decree of the 4th of August, which in the general abolition of feudal rights involved the possessions of many German princes *enclavés* in Alsace and Lorraine, the Constituent Assembly had made the first move in the war against the established European system. Leopold protested as sovereign of Germany; and the protest was soon enlarged into one made in the name of Europe. The circular letter of Count Kaunitz, dated the 6th of July 1791, calling on the sovereigns to unite against the Revolution, was at once the beginning of the Concert of Europe, and in a sense the last manifesto of the Holy Roman Empire as "the centre of political unity." But the common policy proclaimed in the famous declaration of Pillnitz (August 27), was soon wrecked upon the particular interests of the powers. Both Austria and Prussia

Joseph II.
and
"Josephinism."

Leopold II.

Austria and the French Revolution.

were much occupied with the Polish question, and to have plunged into a crusade against France would have been to have left Poland, where the new constitution had been proclaimed on the 3rd of May, to the mercy of Russia. Towards the further development of events in France, therefore, Leopold assumed at first a studiously moderate attitude; but his refusal to respond to the demand of the French government for the dispersal of the corps of *émigrés* assembled under the protection of the German princes on the frontier of France, and the insistence on the rights of princes dispossessed in Alsace and Lorraine, precipitated the crisis. On the 25th of January 1792 the French Assembly adopted the decree declaring that, in the event of no satisfactory reply having been received from the emperor by the 1st of March, war should be declared. On the 7th of February Austria and Prussia signed at Berlin an offensive and defensive treaty of alliance. Thus was ushered in the series of stupendous events which were to change the face of Europe and profoundly to affect the destinies of Austria. Leopold himself did not live to see the beginning of the struggle; he died on the 1st of March 1792, the day fixed by the Legislative Assembly as that on which the question of peace or war was to be decided.

The events of the period that followed, in which Austria necessarily played a conspicuous part, are dealt with elsewhere (see EUROPE, FRENCH REVOLUTIONARY WARS, NAPOLEON, NAPOLEONIC CAMPAIGNS). Here it will only be necessary to mention those which form permanent landmarks in the progressive conformation of the Austrian monarchy. Such was the second partition of Poland (January 23, 1793), which eliminated the "buffer state" on which Austrian statesmanship had hitherto laid such importance, and brought the Austrian and Russian frontiers into contact. Such, too, was the treaty of Campo Formio (October 17, 1797) which ended the first revolutionary war. By this treaty the loss of the Belgian provinces was confirmed, and though Austria gained Venice, the establishment of French preponderance in the rest of Italy made a breach in the tradition of Habsburg supremacy in the peninsula, which was to have its full effect only in the struggles of the next century. The rise of Napoleon, and his masterful interference in Germany, produced a complete and permanent revolution in the relations of Austria to the German states. The campaigns which issued in the treaty of Lunéville (February 9, 1801) practically sealed the fate of the old Empire. Even were the venerable name to survive, it was felt that it would pass, by the election of the princes now tributary to France, from the house of Habsburg to that of Bonaparte. Francis II. determined to forestall the possible indignity of the subordination of his family to an upstart dynasty.

On the 14th of May 1804, Napoleon was proclaimed emperor of the French; on the 11th of August Francis II. assumed the style of Francis I., hereditary emperor of Austria. Two years later, when the defeat of Austerlitz had led to the treaty of Pressburg (January 1, 1806), by which Austria lost Venice and Tirol, and Napoleon's Confederation of the Rhine had broken the unity of Germany, Francis formally abdicated the title and functions of Holy Roman emperor (August 6, 1806).

Austria had to undergo further losses and humiliations, notably by the treaty of Vienna (1809), before the outcome of Napoleon's Russian campaign in 1812 gave her the opportunity for recuperation and revenge. The skilful diplomacy of Metternich, who was now at the head of the Austrian government, enabled Austria to take full advantage of the situation created by the disaster to Napoleon's arms. His object was to recover Austria's lost possessions and if possible to add to them, a policy which did not necessarily involve the complete overthrow of the French emperor. Austria, therefore, refused to join the alliance between Russia and Prussia signed on the 17th of March 1813, but pressed on her armaments so as to be ready in any event. Her opportunity came after the defeats of the Allies at Lützen and Bautzen and the conclusion of an armistice at Pleswitz. Between 200,000 and 300,000 Austrian troops were massed in Bohemia; and Austria took up the rôle of mediator, prepared

to throw the weight of her support into the scale of whichever side should prove most amenable to her claims. The news of the battle of Vittoria, following on the reluctance of Napoleon to listen to demands involving the overthrow of the whole of his political system in central Europe, decided Austria in favour of the Allies. By this fateful decision Napoleon's fall was assured. By the treaty of Trachenberg (July 12, 1813) the Grand Alliance was completed; and on the 16th, 17th and 18th of October the battle of Leipzig was fought; and the victorious advance into France was begun, which issued, on the 11th of April 1814, in Napoleon's abdication. (See NAPOLEON, NAPOLEONIC CAMPAIGNS, EUROPE.)

It was a recognition of the decisive part played by Austria in these great events that Vienna was chosen as the scene of the great international congress summoned (September 1814) for the purpose of re-establishing the balance of power in Europe, which Napoleon's conquests had upset. An account of the congress is given elsewhere (see VIENNA, CONGRESS OF). The result for Austria was a triumphant vindication of Metternich's diplomacy. He had, it is true, been unable to prevent the retention of the grand-duchy of Warsaw by Alexander of Russia; but with the aid of Great Britain and France (secret treaty of January 3, 1815) he had frustrated the efforts of Prussia to absorb the whole of Saxony, Bavaria was forced to disgorge the territories gained for her by Napoleon at Austria's expense, Illyria and Dalmatia were regained, and Lombardy was added to Venetia to constitute a kingdom under the Habsburg crown; while in the whole Italian peninsula French was replaced by Austrian influence. In Germany the settlement was even more fateful for Austria's future. The Holy Empire, in spite of the protests of the Holy See, was not restored. Austria preferring the loose confederation of sovereign states (*Staatenbund*) actually constituted under her presidency. Such a body, Metternich held, "powerful for defence, powerless for offence," would form a guarantee of the peace of central Europe—and of the preponderance of Austria; and in its councils Austrian diplomacy, backed by the weight of the Habsburg power beyond the borders of Germany, would exercise a greater influence than any possible prestige derived from a venerable title that had become a by-word for the union of unlimited pretensions with practical impotence. Moreover, to the refusal to revive the Empire—which shattered so many patriotic hopes in Germany—Austria added another decision yet more fateful. By relinquishing her claim to the Belgian provinces and other outlying territories in western Germany, and by acquiescing in the establishment of Prussia in the Rhine provinces, she abdicated to Prussia her position as the bulwark of Germany against France, and hastened the process of her own gravitation towards the Slavonic East to which the final impetus was given in 1866.

In order to understand the foreign policy of Austria, inseparably associated with the name of Metternich, during the period from the close of the congress of Vienna to the outbreak of the revolutions of 1848, it is necessary to know something of the internal conditions of the monarchy before and during this time. In 1792 Leopold II. had been succeeded by his son Francis II. His popular designation of "our good Kaiser Franz" this monarch owed to a certain simplicity of address and *bonhomie* which pleased the Viennese, certainly not to his serious qualities as a ruler. He shared to the full the autocratic temper of the Habsburgs, their narrow-mindedness and their religious and intellectual obscurantism; and the qualities which would have made him a kindly, if somewhat tyrannical, father of a family, and an excellent head clerk, were hardly those required by the conditions of the Austrian monarchy during a singularly critical period of its history.

The personal character of the emperor, moreover, gained a special importance owing to the modifications that were made in the administrative system of the empire. This had been originally organized in a series of departments: Aulic chanceries for Austria, for Hungary and Transylvania, a general Aulic chamber for finance, domains, mines, trade, post, &c., an Aulic council

Effects of the Revolutionary Wars.

Congress of Vienna.

Internal affairs of Austria under Francis II. and Metternich.

of war, a general directory of accounts, and a chancery of the household, court and state. The heads of all these departments had the rank of secretaries of state and met in council under the royal presidency. In course of time, however, this body became too unwieldy for an effective cabinet, and Maria Theresa established the council of state. During the early years of the reign of Francis, the emperor kept himself in touch with the various departments by means of a cabinet minister; but he had a passion for detail, and after 1805 he himself undertook the function of keeping the administration together. At the same time he had no personal contact with ministers, who might communicate with him only in writing, and for months together never met for the discussion of business. The council of state was, moreover, itself soon enlarged and subdivided; and in course of time the emperor alone represented any synthesis of the various departments of the administration. The jurisdiction of the heads of departments, moreover, was strictly defined, and all that lay outside this was reserved for the imperial decision. Whatever was covered by established precedent could be settled by the department at once; but matters falling outside such precedent, however insignificant, had to be referred to the throne.¹ A system so inelastic, and so deadening to all initiative, could have but one result. Gradually the officials, high and low, subjected to an elaborate system of checks, refused to take any responsibility whatever; and the minutest administrative questions were handed up, through all the stages of the bureaucratic hierarchy, to be shelved and forgotten in the imperial cabinet. For Francis could not possibly himself deal with all the questions of detail arising in his vast empire, even had he desired to do so. In fact, his attitude towards all troublesome problems was summed up in his favourite phrase, "Let us sleep upon it"; questions unanswered would answer themselves.

The result was the gradual atrophy of the whole administrative machine. The Austrian government was not consciously tyrannical, even in Italy; and Francis himself, though determined to be absolute, intended also to be paternal. Nor would the cruelties inflicted on the bolder spirits who dared to preach reform, which made the Austrian government a by-word among the nations, alone have excited the passionate spirit of revolt which carried all before it in 1848. The cause of this is to be sought rather in the daily friction of a system which had ceased to be efficient and only succeeded in irritating the public opinion it was powerless to curb.

Metternich himself was fully conscious of the evil. He recognized that the fault of the government lay in the fact that it did not govern, and he deplored that his own function, in a decadent age, was but "to prop up mouldering institutions." He was not constitutionally averse from change; and he was too clear-sighted not to see that, sooner or later, change was inevitable. But his interest was in the fascinating game of diplomacy; he was ambitious of playing the leading part on the great stage of international politics; and he was too consummate a courtier to risk the loss of the imperial favour by any insistence on unpalatable reforms, which, after all, would perhaps only reveal the necessity for the complete revolution which he feared.

The alternative was to use the whole force of the government to keep things as they were. The disintegrating force of the ever-simmering racial rivalries could be kept in check by the army; Hungarian regiments garrisoned Italy, Italian regiments guarded Galicia, Poles occupied Austria, and Austrians Hungary. The peril from the infiltration of "revolutionary" ideas from without was met by the erection round the Austrian dominions of a Chinese wall of tariffs and censors, which had, however, no more success than is usual with such expedients.² The peril from the independent growth of Liberalism within was guarded against by a rigid supervision of the press and the re-establishment of clerical control over education. Music alone flourished,

¹ Thus, while the number of recruits, though varying from year to year, could be settled by the war department, the question of the claim of a single conscript for exemption, on grounds not recognized by precedent, could only be settled by imperial decree.

² Forbidden books were the only ones read, and forbidden newspapers the only ones believed.

free from government interference; but, curiously enough, the movements, in Bohemia, Croatia and elsewhere, for the revival of the national literatures and languages—which were to issue in the most difficult problem facing the Austrian government at the opening of the 20th century—were encouraged in exalted circles, as tending to divert attention from political to purely scientific interests. Meanwhile the old system of provincial diets and estates was continued or revived (in 1816 in Tirol and Vorarlberg, 1817 in Galicia, 1818 in Carniola, 1828 in the circle of Salzburg), but they were in no sense representative, clergy and nobles alone being eligible, with a few delegates from the towns, and they had practically no functions beyond registering the imperial decrees, relative to recruiting or taxation, and dealing with matters of local police.³ Even the ancient right of petition was seldom exercised, and then only to meet with the imperial disfavour. And this stagnation of the administration was accompanied, as might have been expected, by economic stagnation. Agriculture languished, hampered, as in France before the Revolution, by the feudal privileges of a noble caste which no longer gave any equivalent service to the state; trade was strangled by the system of high tariffs at the frontier and internal *octrois*; and finally public credit was shaken to its foundations by lavish issues of paper money and the neglect to publish the budget.

The maintenance within the empire of a system so artificial and so unsound, involved in foreign affairs the policy of preventing the success of any movements by which it might be threatened. The triumph of Liberal principles **Metternich's policy of stability.** or of national aspirations in Germany, or elsewhere in Europe, might easily, as the events of 1848 proved, shatter the whole rotten structure of the Habsburg monarchy, which survived only owing to the apathy of the populations it oppressed. This, then, is the explanation of the system of "stability" which Metternich succeeded in imposing for thirty years upon Europe. If he persuaded Frederick William III. that the grant of a popular constitution would be fatal to the Prussian monarchy, this was through no love of Prussia; the Carlsbad Decrees and the Vienna Final Act were designed to keep Germany quiet, lest the sleep of Austria should be disturbed; the lofty claims of the Troppau Protocol were but to cover an Austrian aggression directed to purely Austrian ends; and in the Eastern Question, the moral support given to the "legitimate" authority of the sultan over the "rebel" Greeks was dictated solely by the interest of Austria in maintaining the integrity of Turkey. (See EUROPE: History; GERMANY: History; ALEXANDER I. of Russia; METTERNICH, &c.)

Judged by the standard of its own aims Metternich's diplomacy was, on the whole, completely successful. For fifteen years after the congress of Vienna, in spite of frequent alarms, the peace of Europe was not seriously disturbed; and even in 1830, the revolution at Paris found no echo in the great body of the Austrian dominions. The isolated revolts in Italy were easily suppressed; and the insurrection of Poland, though it provoked the lively sympathy of the Magyars and Czechs, led to no actual movement in the Habsburg states. For a moment, indeed, Metternich had meditated taking advantage of the popular feeling to throw the weight of Austria into the scale in favour of the Poles, and thus, by re-establishing a Polish kingdom under Austrian influence, to restore the barrier between the two empires which the partition of Poland had destroyed. But cautious counsels prevailed, and by the victory of the Russian arms the *status quo* was restored (see POLAND).

The years that followed were not wanting in signs of the coming storm. On the 2nd of March 1835 Francis I. died, and was succeeded by his son Ferdinand I. The new emperor was personally amiable, but so enfeebled by epilepsy as to be incapable of ruling; a veiled regency had to be constituted to carry on the government, and the vices of the administration were further accentuated by weakness and divided counsels at the centre. Under these circumstances

³ In Hungary the diet was not summoned at all between 1811 and 1825, nor in Transylvania between 1811 and 1834.

popular discontent made rapid headway. The earliest symptoms of political agitation were in Hungary, where the diet began to show signs of vigorous life, and the growing Slav separatist movements, especially in the south of the kingdom, were rousing the old spirit of Magyar ascendancy (see HUNGARY: *History*). For everywhere the Slav populations were growing restive under the German-Magyar domination. In Bohemia the Czech literary movement had developed into an organized resistance to the established order, which was attacked under the disguise of a criticism of the English administration in Ireland. "Repeal" became the watchword of Bohemian, as of Irish, nationalists (see BOHEMIA). Among the southern Slavs the "Illyrian" movement, voiced from 1836 onward in the *Illyrian National Gazette* of Ljudevit Gaj, was directed in the first instance to a somewhat shadowy Pan-Slav union, which, on the interference of the Austrian government in 1844, was exchanged for the more definite object of a revival of "the Triune Kingdom" (Croatia, Slavonia, Dalmatia) independent of the Hungarian crown (see CROATIA, &c.). In the German provinces also, in spite of Metternich's censors and police, the national movements in Germany had gained an entrance, and, as the revolution of 1848 in Vienna was to show, the most advanced revolutionary views were making headway.

The most important of all the symptoms of the approaching cataclysm was, however, the growing unrest among the peasants.

As had been proved in France in 1789, and was again to be shown in Russia in 1906, the success of any political revolution depended ultimately upon the attitude of the peasant class. In this lies the main significance of the rising in Galicia in 1846. This was in its origin a Polish nationalist movement, hatched in the little independent republic of Cracow. As such it had little importance; though, owing to the incompetence of the Austrian commander, the Poles gained some initial successes. More fateful was the attitude of the Orthodox Ruthenian peasantry, who were divided from their Catholic Polish over-lords by centuries of religious and feudal oppression. The Poles had sought, by lavish promises, to draw them into their ranks; their reply was to rise in support of the Austrian government. In the fight at Gdow (February 26th), where Benedek laid the foundations of the military reputation that was to end so tragically at Königgrätz, flail and scythe wrought more havoc in the rebel ranks than the Austrian musketry. Since, in spite of this object-lesson, the Polish nobles still continued their offers, the peasants consulted the local Austrian authorities as to what course they should take; and the local authorities, unaccustomed to arriving at any decision without consulting Vienna, practically gave them *carte blanche* to do as they liked. A hideous *jacquerie* followed for three or four days; during which cartloads of dead were carried into Tarnow, where the peasants received a reward for every "rebel" brought in.

This affair was not only a scandal for which the Austrian government, through its agents, was responsible; but it placed the authorities at Vienna in a serious dilemma. For the Ruthenians, elated by their victory, refused to return to work, and demanded the abolition of all feudal obligations as the reward of their loyalty. To refuse this claim would have meant the indefinite prolongation of the crisis; to concede it would have been to invite the peasantry of the whole empire to put forth similar demands on pain of a general rising. On the 13th of April 1846 an imperial decree abolished some of the more burdensome feudal obligations; but this concession was greeted with so fierce an outcry, as an authoritative endorsement of the atrocities, that it was again revoked, and Count Franz von Stadion was sent to restore order in Galicia. The result was, that the peasants saw that though their wrongs were admitted, their sole hope of redress lay in a change of government, and added the dead weight of their resentment to the forces making for revolution. It was the union of the agrarian with the nationalist movements that made the downfall of the Austrian system inevitable.

The material for the conflagration in Austria was thus all

prepared when in February 1848 the fall of Louis Philippe fanned into a blaze the smouldering fires of revolution throughout Europe. On the 3rd of March, Kossuth, in the diet at Pressburg, delivered the famous speech which was the declaration of war of Hungarian Liberalism against the Austrian system. "From the charnel-house of the Vienna cabinet," he exclaimed, "a pestilential air breathes on our spirit, which dulls our nerves and paralyses the flight of our us." Hungary liberated was to become the centre of freedom for all the races under the Austrian crown, and the outcome was to be a new "fraternization of the Austrian peoples." In the enthusiasm of the moment the crucial question of the position to be occupied by the conflicting nationalities in this "fraternal union" was overlooked. Germanism had so far served as the basis of the Austrian system, not as a national ideal, but because "it formed a sort of unnational mediating, and common element among the contradictory and clamorous racial tendencies." But with the growth of the idea of German unity, Germanism had established a new ideal, of which the centre lay beyond the boundaries of the Austrian monarchy, and which was bound to be antagonistic to the aspirations of other races. The new doctrine of the fraternization of the Austrian races would inevitably soon come into conflict with the traditional German ascendancy strengthened by the new sentiment of a united Germany. It was on this rock that, both in Austria and in Germany, the revolution suffered shipwreck.

Meanwhile events progressed rapidly. On the 11th of March a meeting of "young Czechs" at Prague drew up a petition embodying nationalist and liberal demands; and on the same day the diet of Lower Austria petitioned the crown to summon a meeting of the delegates of the diets to set the Austrian finances in order. To this last proposal the government, next day, gave its consent. But in the actual temper of the Viennese the slightest concession was dangerous. The hall of the diet was invaded by a mob of students and workmen, Kossuth's speech was read and its proposals adopted as the popular programme, and the members of the diet were forced to lead a tumultuous procession to the Hofburg, to force the assent of the government to a petition based on the catch-words of the Revolution. The authorities, taken by surprise, were forced to temporize and agreed to lay the petition before the emperor. Meanwhile round the hall of the diet a riot had broken out; the soldiers intervened and blood was shed. The middle classes now joined the rebels; and the riots had become a revolution. Threatened by the violence of the mob, Metternich, on the evening of the 13th of March, escaped from the Hofburg and passed into exile in England.

The fall of Metternich was the signal for the outburst of the storm, not in Austria only, but throughout central Europe. In Hungary, on the 31st of March, the government was forced to consent to a new constitution which virtually erected Hungary into an independent state. On the 8th of April a separate constitution was promised to Bohemia; and if the petition of the Croats for a similar concession was rejected, this was due to the armed mob of Vienna, which was in close alliance with Kossuth and the Magyars. The impotence of the Austrian government in this crisis was due to the necessity of keeping the bulk of the Austrian forces in Italy, where the news of Metternich's fall had also led to a concerted rising against the Habsburg rule (see ITALY). Upon the fortunes of war in the peninsula depended the ultimate issue of the revolutions so far as Austria was concerned.

The army and the prestige of the imperial tradition were, in fact, the two sheet-anchors that enabled the Habsburg monarchy to weather the storm. For the time the latter was the only one available; but it proved invaluable, especially in Germany, in preventing any settlement, until Radetzky's victory of Novara had set free the army, and thus once more enabled Austria to back her policy by force. The Austrian government, in no position to refuse, had consented to send delegates from its German provinces to the parliament of united Germany, which met at Frankfurt on the 18th of May 1848. The question at

Gallician
Rising,
1846.

Revolution
of
1848.

Fall of
Metternich,
March 13,
1848.

once arose of the place of the Austrian monarchy in united Germany. Were only its German provinces to be included? Or was it to be incorporated whole? As to the first, the Austrian government would not listen to the suggestion of a settlement which would have split the monarchy in half and subjected it to a double allegiance. As to the second, German patriots could not stomach the inclusion in Germany of a vast non-German population. The dilemma was from the first so obvious that the parliament would have done well to have recognized at once that the only possible solution was that arrived at, after the withdrawal of the Austrian delegates, by the exclusion of Austria altogether and the offer of the crown of Germany to Frederick William of Prussia. But the shadow of the Holy Empire, immemorably associated with the house of Habsburg, still darkened the counsels of German statesmen. The Austrian archduke John had been appointed regent, pending the election of an emperor; and the political leaders could neither break loose from the tradition of Austrian hegemony, nor reconcile themselves with the idea of a mutilated Germany, till it was too late, and Austria was once more in a position to re-establish the system devised by her diplomacy at the congress of Vienna. (See *GERMANY: History.*)

This fatal procrastination was perhaps not without excuse, in view of the critical situation of the Austrian monarchy during 1848. For months after the fall of Metternich Austria was practically without a central government. Vienna itself, where on the 14th of March the establishment of a National Guard was authorized by the emperor, was ruled by a committee of students and citizens, who arrogated to themselves a voice in imperial affairs, and imposed their will on the distracted ministry. On the 15th of March the government proposed to summon a central committee of local diets; but this was far from satisfying public opinion, and on the 25th of April a constitution was proclaimed, including the whole monarchy with the exception of Hungary and Lombardo-Venetia. This was, however, met by vigorous protests from Czechs and Poles, while its provisions for a partly nominated senate, and the indirect election of deputies, excited the wrath of radical Vienna. Committees of students and national guards were formed; on the 13th of May a Central Committee was established; and on the 15th a fresh insurrection broke out, as a result of which the government once more yielded, recognizing the Central Committee, admitting the right of the National Guard to take an active part in politics, and promising the convocation of a National Convention on the basis of a single chamber elected by universal suffrage. On the 17th the emperor left Vienna for Innsbruck "for the benefit of his health," and thence, on the 20th, issued a proclamation in which he cast himself on the loyalty of his faithful provinces, and, while confirming the concessions of March, ignored those of the 15th of May. The flight of the emperor had led to a revulsion of feeling in Vienna; but the issue of the proclamation and the attempt of the government to disperse the students by closing the university, led to a fresh outbreak on the 26th. Once more the ministry conceded all the demands of the insurgents, and even went so far as to hand over the public treasury and the responsibility of keeping order to a newly constituted Committee of Public Safety.

The tide was now, however, on the turn. The Jacobinism of the Vienna democracy was not really representative of any widespread opinion even in the German parts of Austria, while its loud-voiced Germanism excited the lively opposition of the other races. Each of these had taken advantage of the March troubles to press its claims, and everywhere the government had shown the same yielding spirit. In Bohemia, where the attempt to hold elections for the Frankfort parliament had broken down on the opposition of the Czechs and the conservative German aristocracy, a separate constitution had been proclaimed on the 8th of April; on March the 23rd the election by the diet of Agram of Baron Joseph Jellachich as ban of Croatia was confirmed, as a concession to the agitation among the southern Slavs; on the 18th of March Count Stadion had proclaimed a new con-

stitution for Galicia. Even where, as in the case of the Serbs and Rumanians, the government had given no formal sanction to the national claims, the emperor was regarded as the ultimate guarantee of their success; and deputations from the various provinces poured into Innsbruck protesting their loyalty.

To say that the government deliberately adopted the Machiavellian policy of mastering the revolution by setting race against race would be to pay too high a compliment to its capacity. The policy was forced upon it; and was only pursued consciously when it became obvious. Count Stadion began it in Galicia, where, before bombarding insurgent Cracow into submission (April 26), he had won over the Ruthenian peasants by the abolition of feudal dues and by forwarding a petition to the emperor for the official recognition of their language alongside Polish. But the great object lesson was furnished by the events in Prague, where the quarrel between Czechs and Germans, radicals and conservatives, issued on the 12th of June in a rising of the Czech students and populace. The suppression of this rising, and with it of the revolution in Bohemia, on the 16th of June, by Prince Windischgrätz, was not only the first victory of the army, but was the signal for the outbreak of a universal race war, in which the idea of constitutional liberty was sacrificed to the bitter spirit of national rivalry. The parliament at Frankfort hailed Windischgrätz as a national hero, and offered to send troops to his aid; the German revolutionists in Vienna welcomed every success of Radezky's arms in Italy as a victory for Germanism. The natural result was to drive the Slav nationalities to the side of the imperial government, since, whether at Vienna or at Budapest, the radicals were their worst enemies.

The 16th of June had been fatal to the idea of an independent Bohemia, fatal also to Pan-Slav dreams. To the Czechs the most immediate peril now seemed that from the German parliament, and in the interests of their nationality they were willing to join the Austrian government in the struggle against German liberalism. The Bohemian diet, summoned for the 10th, never met. Writs were issued in Bohemia for the election to the Austrian Reichsrath; and when, on the 10th of July, this assembled, the Slav deputies were found to be in a majority. This fact, which was to lead to violent trouble later, was at first subordinate to other issues, of which the most important was the question of the emancipation of the peasants. After long debates the law abolishing feudal services—the sole permanent outcome of the revolution—was carried on the 31st of August, and on the 7th of September received the imperial consent. The peasants thus received all that they desired, and their vast weight was henceforth thrown into the scale of the government against the revolution.

Meanwhile the alliance between the Slav nationalities and the conservative elements within the empire had found a powerful representative in Jellachich, the ban of Croatia. At first, indeed, his activity had been looked at askance at Innsbruck, as but another force making for disintegration. He had apparently identified himself with the "Illyrian" party, had broken off all communications with the Hungarian government, and, in spite of an imperial edict issued in response to the urgency of Batthyáni, had summoned a diet to Agram, which on the 9th of June decreed the separation of the "Triune Kingdom" from Hungary. The imperial government, which still hoped for Magyar aid against the Viennese revolutionists, repudiated the action of the ban, accused him of disobedience and treason, and deprived him of his military rank. But his true motives were soon apparent; his object was to play off the nationalism of the "Illyrians" against the radicalism of Magyars and Germans, and thus to preserve his province for the monarchy; and the Hungarian radicals played into his hands. The fate of the Habsburg empire depended upon the issue of the campaign in Italy, which would have been lost by the withdrawal of the Magyar and Croatian regiments; and the Hungarian government chose this critical moment to tamper with the relations of the army to the monarchy. In May a National Guard had been established;

and the soldiers of the line were invited to join this, with the promise of higher pay; on the 1st of June the garrison of Pest took the oath to the Constitution. On the 10th Jellachich issued a proclamation to the Croatian regiments in Italy, bidding them remain and fight for the emperor and the common Fatherland. His loyalty to the tradition of the imperial army was thus announced, and the alliance was cemented between the army and the southern Slavs.

Jellachich, who had gone to Innsbruck to lay the Slav view before the emperor, was allowed to return to Agram, though not as yet formally reinstated. Here the diet passed a resolution denouncing the dual system and demanding the restoration of the union of the empire. Thus was proclaimed the identity of the Slav and the conservative points of view; the radical "Illyrian" assembly had done its work, and on the 9th of July Jellachich, while declaring it "permanent," prorogued it indefinitely "with a paternal greeting," on the ground that the safety of the Fatherland depended now "more upon physical than upon moral force." The diet thus prorogued never met again. Absolute master of the forces of the banat, Jellachich now waited until the intractable politicians of Pest should give him the occasion and the excuse for setting the imperial army in motion against them.

The occasion was not to be long postponed. Every day the rift between the dominant radical element in the Hungarian parliament and imperial court was widened. Kossuth and his followers were evidently aiming at the complete separation of Hungary from Austria; they were in sympathy, if not in alliance, with the German radicals in Vienna and Frankfurt; they were less than half-hearted in their support of the imperial arms in Italy. The imperial government, pressed by the Magyar nationalists to renounce Jellachich and all his works, equivocated and procrastinated, while within its councils the idea of a centralized state, to replace the loose federalism of the old empire, slowly took shape under the pressure of the military party. It was encouraged by the news from Italy, where, on the 25th of July, Radetzky had won the battle of Custoza, and on the 6th of August the Austrian standard once more floated over the towers of Milan. At Custoza Magyar hussars, Croats from the Military Frontier, and Tirolese sharpshooters had fought side by side. The possibility was obvious of combating the radical and nationalist revolution by means of the army, with its spirit of comradeship in arms and its imperialist tradition.

So early as the beginning of July, Austrian officers, with the permission of the minister of war, had joined the Serb insurgents who, under Stratemirović, were defying the Magyar power in the banat. By the end of August the breach between the Austrian and Hungarian governments was open and complete; on the 4th of September Jellachich was reinstated in all his honours, and on the 11th he crossed the Drave to the invasion of Hungary. The die was thus cast; and, though efforts continued to be made to arrange matters, the time for moderate counsels was passed. The conservative leaders of the Hungarian nationalists, Eötvös and Deák, retired from public life; and, though Batthyáni consented to remain in office, the slender hope that this gage of peace was ruined by the flight of the palatine (September 24) and the murder of Count Lamberg, the newly appointed commissioner and commander-in-chief in Hungary, by the mob at Pest (September 27). The appeal was now to arms; and the fortunes of the Habsburg monarchy were bound up with the fate of the war in Hungary (see HUNGARY: History).

Meanwhile, renewed trouble had broken out in Vienna, where the radical populace was in conflict alike with the government and with the Slav majority of the Reichsrath. The German democrats appealed for aid to the Hungarian government; but the Magyar passion for constitutional legality led to delay, and before the Hungarian advance could be made effective, it was too late. On the 7th of October the emperor Ferdinand had fled from Schönbrunn to Olmütz, a Slav district, whence he issued a proclamation inviting whoever loved "Austria and freedom" to rally round the throne. On the 11th Windischgrätz proclaimed

his intention of marching against rebellious Vienna, and on the 16th an imperial rescript appointed him a field-marshal and commander-in-chief of all the Austrian armies except that of Italy. Meanwhile, of the Reichsrath, the members of the Right and the Slav majority had left Vienna and announced a meeting of the diet at Brünn for the 20th of October; all that remained in the capital was a rump of German radicals, impotent in the hands of the proletariat and the students. The defence of the city was hastily organized under Bem, an ex-officer of Napoleon; but in the absence of help from Hungary it was futile. On the 28th of October Windischgrätz began his attack; on the 1st of November he was master of the city.

The fall of revolutionary Vienna practically involved that of the revolution in Frankfurt and in Pest. From Italy the congratulations of Radetzky's victorious army came to Windischgrätz, from Russia the even more significant commendations of the emperor Nicholas. The moral of the victory was painted for all the world by the military execution of Robert Blum, whose person, as a deputy of the German parliament, should have been sacrosanct. The time had, indeed, not yet come to attempt any conspicuous breach with the constitutional principle; but the new ministry was such as the imperial sentiment would approve, inimical to the German ideals of Frankfurt, devoted to the traditions of the Habsburg monarchy. At its head was Prince Felix Schwarzenberg (q.v.), the "army-diplomat," a statesman at once strong and unscrupulous. On the 27th of November a proclamation announced that the continuation of Austria as a united state was necessary both for Germany and for Europe. On the 2nd of December the emperor Ferdinand, bound by too many personal obligations to the revolutionary parties to serve as a useful instrument for the new policy, abdicated, and his nephew Francis Joseph ascended the throne. The proclamation of the new emperor was a gage of defiance thrown down to Magyars and German unionists alike: "Firmly determined to preserve undimmed the lustre of our crown," it ran, "but prepared to share our rights with the representatives of our peoples, we trust that with God's aid and in common with our peoples we shall succeed in uniting all the countries and races of the monarchy in one great body politic."

Accession
of Francis
Joseph,
1848

While the Reichsrath, transferred to Kremsier, was discussing "fundamental rights" and the difficult question of how to reconcile the theoretical unity with the actual dualism of the empire, the knot was being cut by the sword on the plains of Hungary. The Hungarian retreat after the bloody battle of Kapolna (February 26-27, 1849) was followed by the dissolution of the Kremsier assembly, and a proclamation in which the emperor announced his intention of granting a constitution to the whole monarchy "one and indivisible." On the 4th of March the constitution was published; but it proved all but as distasteful to Czechs and Croats as to the Magyars, and the speedy successes of the Hungarian arms made it, for the while, a dead letter. It needed the intervention of the emperor Nicholas, in the loftiest spirit of the Holy Alliance, before even an experimental unity of the Habsburg dominions could be established (see HUNGARY: History).

The capitulation of Világos, which ended the Hungarian insurrection, gave Schwarzenberg a free hand for completing the work of restoring the *status quo ante* and the influence of Austria in Germany. The account of the process by which this was accomplished belongs to the history of Germany (q.v.). Here it will suffice to say that the terms of the Convention of Olmütz (November 29, 1850) seemed at the time a complete triumph for Austria over Prussia. As a matter of fact, however, the convention was, in the words of Count Beust, "not a Prussian humiliation, but an Austrian weakness." It was in the power of Austria to crush Prussia and to put an end to the dual influence in the Confederation which experience had proved to be unworkable; she preferred to re-establish a discredited system, and to leave to Prussia time and opportunity to gather strength for the inevitable conflict.

In 1851 Austria had apparently triumphed over all its

difficulties. The revolutionary movements had been suppressed, the attempt of Prussia to assume the leadership in Germany defeated, the old Federal Diet of 1815 in Germany had been restored. Vienna again became the centre of a despotic government the objects of which were to

Germanize the Magyars and Slavs, to check all agitation for a constitution, and to suppress all attempts to secure a free press. For some ten years the Austrian dominion groaned under one of the worst possible forms of autocratic government. The failure of the Habsburg emperor to perpetuate this despotic régime was due (1) to the Crimean War, (2) to the establishment of Italian unity, and (3) to the successful assertion by Prussia of its claim to the leadership in Germany. The disputes which resulted in the Crimean War revealed the fact that "gratitude" plays but a small part in international affairs. In the minds of Austrian statesmen the question of the free navigation of the Danube, which would have been imperilled by a Russian occupation of the Principalities, outweighed their sense of obligation to Russia, on which the emperor Nicholas had rashly relied. That Austria at first took no active part in the war was due, not to any sentimental weakness, but to the refusal of Prussia to go along with her and to the fear of a Sardinian attack on her Italian provinces. But, on the withdrawal of the Russian forces from the Principalities, these were occupied by Austrian troops, and on the 2nd of December 1854, a treaty of alliance was signed at Vienna, between Great Britain, Austria and France, by which Austria undertook to occupy Moldavia and Wallachia during the continuance of the war and "to defend the frontier of the said principalities against any return of the Russian forces." By Article III., in the event of war between Russia and Austria the alliance both offensive and defensive was to be made effective (Hertslet, No. 252). With the progressive disasters of the Russian arms, however, Austria grew bolder, and it was the ultimatum delivered by her to the emperor Alexander II. in December 1855, that forced Russia to come to terms (Treaty of Paris, March 30, 1856).

Though, however, Austria by her diplomatic attitude had secured, without striking a blow, the settlement in her sense of the Eastern Question, she emerged from the contest without allies and without friends. The "Holy Alliance" of the three autocratic northern powers, recentered at Münchengrätz in 1833, which had gained for Austria the decisive intervention of the tsar in 1849, had been hopelessly shattered by her attitude during the Crimean War. Russia, justly offended, drew closer her ties with Prussia, where Bismarck was already hatching the plans which were to mature in 1866; and, if the attitude of Napoleon in the Polish question prevented any revival of the alliance of Tilsit, the goodwill of Russia was assured for France in the coming struggle with Austria in Italy. Already the isolation of Austria had been conspicuous in the congress of Paris, where Cavour, the Sardinian plenipotentiary, laid bare before assembled Europe the scandal of her rule in Italy. It was emphasized during the campaign of 1859, when Sardinia, in alliance with France, laid the foundations of united Italy. The threat of Prussian intervention, which determined the provisions of the armistice of Villafranca, was due, not to love of Austria, but to fear of the undue aggrandizement of France. The campaign of 1859, and the diplomatic events that led up to it, are dealt with elsewhere (see ITALY, ITALIAN WARS, NAPOLEON III., CAVOUR). The results to Austria were two-fold. Externally, she lost all her Italian possessions except Venice; internally, her failure led to the necessity of conciliating public opinion by constitutional concessions.

The proclamation on the 26th of February 1861 of the new constitution for the whole monarchy, elaborated by Anton von Schmerling, though far from satisfying the national aspirations of the races within the empire, at least gave Austria a temporary popularity in Germany; the liberalism of the Habsburg monarchy was favourably contrasted with the "reactionary" policy of Prussia, where Bismarck was defying the majority of the diet in his determination to build up the military power of Prussia. The meeting of the princes summoned to Frankfurt by the

emperor Francis Joseph, in 1863, revealed the ascendancy of Austria among the smaller states of the Confederation; but it revealed also the impossibility of any consolidation of the Confederation without the co-operation of Prussia, which stood outside. Bismarck had long since decided that the matter could only be settled by the exclusion of Austria altogether, and that the means to this end were not discussion, but "Blood and Iron." The issue was forced by the developments of the tangled Schleswig-Holstein Question (*q.v.*), which led to the definitive breach between the two great German powers, to the campaign of 1866, and the collapse of Austria on the field of Königgrätz (July 3. See SEVEN WEEKS' WAR). (W. A. P.; A. H.).

The war of 1866 began a new era in the history of the Austrian empire. By the treaty of Prague (August 23, 1866) the emperor surrendered the position in Germany which his ancestors had held for so many centuries; Austria and Tirol, Bohemia and Salzburg, ceased to be German, and eight million Germans were cut off from all political union with their fellow-countrymen. At the same time the surrender of Venetia completed the work of 1859, and the last remnant of the old-established Habsburg domination in Italy ceased. The war was immediately followed by a re-organization of the government. The Magyar nation, *Establishment of the dual monarchy* as well as the Czechs, had refused to recognize the validity of the constitution of 1861 which had established a common parliament for the whole empire; they demanded that the independence of the kingdom of Hungary should be restored. Even before the war the necessity of coming to terms with the Hungarians had been recognized. In June 1865 the emperor Francis Joseph visited Pest and replaced the chancellors of Transylvania and Hungary, Counts Francis Zichy and Nadády, supporters of the February constitution, by Count Majláth, a leader of the old conservative magnates. This was at once followed by the resignation of Schmerling, who was succeeded by Count Richard Belcredi. On the 20th of September the Reichsrath was prorogued, which was equivalent to the suspension of the constitution; and in December the emperor opened the Hungarian diet in person, with a speech from the throne that recognized the validity of the laws of 1848. Before any definite arrangement as to their re-introduction could be made, however, the war broke out; and after the defeats on the field of battle the Hungarian diet was able to make its own terms. They recognized no union between their country and the other parts of the monarchy except that which was based on the Pragmatic Sanction.¹ All recent innovations, all attempts made during the last hundred years to absorb Hungary in a greater Austria, were revoked. An agreement was made by which the emperor was to be crowned at Pest and take the ancient oath to the Golden Bull; Hungary (including Transylvania and Croatia) was to have its own parliament and its own ministry; Magyar was to be the official language; the emperor was to rule as king; there was to be complete separation of the finances; not even a common nationality was recognized between the Hungarians and the other subjects of the emperor; a Hungarian was to be a foreigner in Vienna, an Austrian a foreigner in Budapest. A large party wished indeed that nothing should be left but a purely personal union similar to that between England and Hanover. Deák and the majority agreed, however, that there should be certain institutions common to Hungary and the rest of the monarchy; these were—(1) foreign affairs, including the diplomatic and consular service; (2) the army and navy; (3) the control of the expenses required for these branches of the public service.

Recognizing in a declaratory act the legal existence of these common institutions, they also determined the method by which they should be administered. In doing so they carried out with great exactitude the principle of dualism, establishing in form a complete parity between Hungary on one side and the other territories of the king on the other. They made it a condition

¹ For the separate political histories of Austria and Hungary see the section on II. *Austria Proper*, below, and HUNGARY; the present section deals with the history of the whole monarchy as such.

that there should be constitutional government in the rest of the monarchy as well as in Hungary, and a parliament in which all the other territories should be represented. From both the Hungarian and the Austrian parliament there was to be elected

Delegations.

a *Delegation*, consisting of sixty members; to these Delegations the common ministers were to be responsible, and to them the estimates for the joint services were to be submitted. The annual meetings were to be held alternately in Vienna and in Pest. They were very careful that these Delegations should not overshadow the parliaments by which they were appointed. The Delegations were not to sit together; each was to meet separately; they were to communicate by writing, every document being accompanied by a translation in Magyar or German, as the case might be; only if after three times exchanging notes they failed to agree was there to be a common session; in that case there would be no discussion, and they were to vote in silence; a simple majority was sufficient. There were to be three ministers for common purposes—(1) for foreign affairs; (2) for war; (3) for finance; these ministers were responsible to the Delegations, but the Delegations were really given no legislative power. The minister of war controlled the common army, but even the laws determining the method by which the army was to be recruited had to be voted separately in each of the parliaments. The minister of finance had to lay before them the common budget, but they could not raise money or vote taxes; after they had passed the budget the money required had to be provided by the separate parliaments. Even the determination of the proportion which each half of the monarchy was to contribute was not left to the Delegations. It was to be fixed once every ten years by separate committees chosen for that purpose from the Austrian Reichsrath and the Hungarian parliament, the so-called *Quota-Deputations*. In addition to these "common affairs" the Hungarians, indeed, recognized that there were certain other matters which it was desirable should be managed on identical principles in the two halves of the monarchy—namely, customs and excise currency; the army and common railways. For these, however, no common institutions were created; they must be arranged by agreement; the ministers must confer and then introduce identical acts in the Hungarian and the Austrian parliaments.

The main principles of this agreement were decided during the spring of 1867; but during this period the Austrians were not really consulted at all. The negotiations on behalf of the court of Vienna were entrusted to Beust, whom the emperor appointed chancellor of the empire and also minister-president of Austria. He had no previous experience of Austrian affairs, and was only anxious at once to bring about a settlement which would enable the empire to take a strong position in international politics. In the summer of 1867, however (the Austrian Reichsrath having met), the two parliaments each elected a deputation of fifteen members to arrange the financial settlement. The first matter was the debt, amounting to over 3000 million gulden, in addition to the floating debt, which had been contracted during recent years. The Hungarians laid down the principle that they were in no way responsible for debts contracted during a time when they had been deprived of their constitutional liberties; they consented, however, to pay each year 2½ million gulden towards the interest. The whole responsibility for the payment of the remainder of the interest, amounting annually to over a hundred million gulden, and the management of the debt, was left to the Austrians. The Hungarians wished that a considerable part of it should be repudiated. It was then agreed that the two states should form a Customs Union for the next ten years; the customs were to be paid to the common exchequer; all sums required in addition to this to meet the expenses were to be provided as to 30% by Hungary and as to 70% by Austria. After the financial question had been thus settled, the whole of these arrangements were then, on the 21st and the 24th of December 1867, enacted by the two parliaments, and the system of dualism was established.

The acts were accepted in Austria out of necessity; but no

parties were really satisfied. The Germans, who accepted the principle of dualism, were indignant at the financial arrangements; for Hungary, while gaining more than an equal share of power, paid less than one-third of the common expenses. On the other hand, according to British ideas of taxable capacity, Hungary paid, and still pays, more than her share. The Germans, however, could at least hope that in the future the financial arrangements might be revised; the complaints of the Slav races were political, and within the constitution there was no means of remedy, for, while the settlement gave to the Hungarians all that they demanded, it deprived the Bohemians or Galicians of any hope that they would be able to obtain similar independence. Politically, the principle underlying the agreement was that the empire should be divided into two portions; in one of these the Magyars were to rule, in the other the Germans; in either section the Slav races—the Serbs and Croats, the Czechs, Poles and Slovenes—were to be placed in a position of political inferiority.¹

The logical consistency with which the principle of Dualism was carried out is shown in a change of title. By a letter to Beust of the 14th of November 1868 the emperor ordered that he should henceforward be styled, not as before, "Emperor of Austria, King of Hungary, King of Bohemia, &c.," but "Emperor of Austria, King of Bohemia, &c., and Apostolic King of Hungary," thereby signifying the separation of the two districts over which he rules. His shorter style is "His Majesty the Emperor and King," and "His Imperial and Apostolic Royal Majesty"; the lands over which he rules are called "The Austrian-Hungarian Monarchy" or "The Austrian-Hungarian Realm." The new terminology, "Imperial and Royal" (*Kaiserlich und Königlich*), has since then been applied to all those branches of the public service which belong to the common ministries; this was first the case with the diplomatic service; not till 1880 was it applied to the army, which for some time kept up the old style of *Kaiserlich-Königlich*; in 1895 it was applied to the ministry of the imperial house, an office always held by the minister for foreign affairs. The minister for foreign affairs was at first called the *Reichsbanier*; but in 1871, when Andrássy succeeded Beust, this was given up in deference to Hungarian feeling, for it might be taken to imply that there was a single state of which he was minister. The old style *Kaiserlich-Königlich*, the "K.K.," which has become so familiar through long use, is still retained in the Austrian part of the monarchy. There are, therefore, three ministries of finance: the *Kaiserlich und Königlich* for joint affairs; the *Kaiserlich-Königlich* for Austrian affairs; the *Királyi* for Hungary.

The settlement with Hungary consisted then of three parts:—(1) the political settlement, which was to be permanent and has since remained part of the fundamental constitution of the monarchy; (2) the periodical financial settlement, determining the partition of the common expenses as arranged by the Quota-Deputations and ratified by the parliaments; (3) the Customs Union and the agreement as to currency—a voluntary and terminable arrangement made between the two governments and parliaments. The history of the common affairs which fall under the management of the common ministries is, then, the history of the foreign policy of the empire and of the army. It is with this and this alone that the Delegations are occupied, and it is to this that we must now turn. The annual meetings call for little notice; they have generally been the occasion on which the foreign minister has explained and justified his policy; according to the English custom, red books, sometimes containing important despatches, have been laid before them; but the debates have caused less embarrassment to the government than is generally the case in parliamentary assemblies, and the army budget has generally been passed with few and unimportant alterations.

For the first four years, while Beust was chancellor, the foreign policy was still influenced by the feelings left by the war of 1866. We do not know how far there was a real intention to revenge Königgrätz and recover the position lost in Germany. This would be at least a possible policy, and one to which Beust by his previous history would be inclined. There were sharp passages of arms with the

¹ Baron H. de Worms, *The Austro-Hungarian Empire* (London, 1876), and Beust's *Memoirs*.

Common affairs.

Foreign policy.

Prussian government regarding the position of the South German states; a close friendship was maintained with France; there were meetings of the emperor and of Napoleon at Salzburg in 1868, and the next year at Paris; the death of Maximilian in Mexico cast a shadow over the friendship, but did not destroy it. The opposition of the Hungarians and financial difficulties probably prevented a warlike policy. In 1870 there were discussions preparatory to a formal alliance with France against the North German Confederation, but nothing was signed.¹ The war of 1870 put an end to all ideas of this kind; the German successes were so rapid that Austria was not exposed to the temptation of intervening, a temptation that could hardly have been resisted had the result been doubtful or the struggle prolonged. The absorption of South Germany in the German empire took away the chief cause for friction; and from that time warm friendship, based on the maintenance of the established order, has existed between the two empires. Austria gave up all hope of regaining her position in Germany; Germany disclaimed all intention of acquiring the German provinces of Austria. Beust's retirement in 1871 put the finishing touch on the new relations. His successor, Count Andrassy, a Hungarian, established a good understanding with Bismarck; and in 1872 the visit of the emperor Francis Joseph, accompanied by his minister, to Berlin, was the final sign of the reconciliation with his uncle. The tsar was also present on that occasion, and for the next six years the close friendship between the three empires removed all danger of war. Three years later the full reconciliation with Italy followed, when Francis Joseph consented to visit Victor Emmanuel in Venice.

The outbreak of disturbance in the Balkans ended this period of calm. The insurrection in Bosnia and Herzegovina immediately affected Austria; refugees in large numbers crossed the frontier and had to be maintained by the government. The political problem presented was a very difficult one. The sympathy of the Slav inhabitants of the empire made it impossible for the government of Vienna to regard with indifference the sufferings of Christians in Turkey. Active support was impossible, because the Hungarians, among whom the events of 1848 had obliterated the remembrance of the earlier days of Turkish conquest, were full of sympathy for the Turks. It was a cardinal principle of Austrian policy that she could not allow the erection of new Slav states on her southern frontier. Moreover, the disturbances were fomented by Russian agents, and any increase of Russian influence (for which the Pan-Slav party was working) was full of danger to Austria. For a time the mediation of Germany preserved the good understanding between the two eastern empires. In 1875 Andrassy drafted a note, which was accepted by the powers, requiring Turkey to institute the reforms necessary for the good government of the provinces. Turkey agreed to do this, but the insurgents required a guarantee from the Powers that Turkey would keep her engagements. This could not be given, and the rebellion continued and spread to Bulgaria. The lead then passed to Russia, and Austria, even after the outbreak of war, did not oppose Russian measures. At the beginning of 1877 a secret understanding had been made between the two powers, by which Russia undertook not to annex any territory, and in other ways not to take steps which would be injurious to Austria. The advance of the Russian army on Constantinople, however, was a serious menace to Austrian influence; Andrassy therefore demanded that the terms of peace should be submitted to a European conference, which he suggested should meet at Vienna. The peace of San Stefano violated the engagements made by Russia, and Andrassy was therefore compelled to ask for a credit of 60 million gulden and to mobilize a small portion of the army; the money was granted unanimously in the Hungarian Delegation, though the Magyars disliked a policy the object of which appeared to be not the defence of Turkey against Russia, but an agreement with Russia which would give Austria compensation at the expense of Turkey; in

the Austrian Deputation it was voted only by a majority of 39 to 20, for the Germans were alarmed at the report that it would be used for an occupation of part of the Turkish territory.

The active share taken by Great Britain, however, relieved Austria from the necessity of having recourse to further measures. By an arrangement made beforehand, Austria was requested at the congress of Berlin to undertake the occupation and administration of Bosnia and Herzegovina—an honourable but arduous task. The provinces could not be left to the Turks; Austria could not allow them to fall under Russian influence. The occupation was immediately begun, and 60,000 Austrian troops, under the command of General Philippovich,² crossed the frontier on the 29th of July. The work was, however, more difficult than had been anticipated; the Mahomedans offered a strenuous resistance; military operations were attended with great difficulty in the mountainous country; 200,000 men were required, and they did not succeed in crushing the resistance till after some months of obstinate fighting. The losses on either side were very heavy; even after the capture of Serajevo in August, the resistance was continued; and besides those who fell in battle, a considerable number of the insurgents were put to death under military law. The opposition in the Delegations, which met at the end of the year, was so strong that the government had to be content with a credit to cover the expenses for 1879 of less than half what they had originally asked, and the supplementary estimate of 40,000,000 gulden for 1878 was not voted till the next year. In 1879 the Porte, after long delay, recognized the occupation on the distinct understanding that the sovereignty of the sultan was acknowledged. A civil administration was then established, the provinces not being attached to either half of the empire, but placed under the control of the joint minister of finance. The government during the first two years was not very successful; the Christian population were disappointed at finding that they still had, as in the old days, to pay rent to the Mahomedan begs. There were difficulties also between the Roman Catholics and the members of the Greek Church. In 1881 disturbances in Dalmatia spread over the frontier into Herzegovina, and another expedition had to be sent to restore order. When this was done Benjamin de Kallay was appointed minister, and under his judicious government order and prosperity were established in the provinces. In accordance with another clause of the treaty of Berlin, Austria was permitted to place troops in the sanjak of Novi-Bazar, a district of great strategic importance, which separated Serbia and Montenegro, and through which the communication between Bosnia and Salonica passed. This was done in September 1879 in agreement with Turkey having specified the numbers and position of the garrison. Another slight alteration of the frontier was made in the same year, when, during the delimitation of the new frontier of Montenegro, the district of Spizza was incorporated in the kingdom of Dalmatia.

The congress of Berlin indirectly caused some difficulties with Italy. In that country was a large party which, under the name of the "Irredentists," demanded that those Italian-speaking districts, South Tirol, Istria and Trieste, which were under Austrian rule, should be joined to Italy; there were public meetings and riots in Italy; the Austrian flag was torn down from the consulate in Venice and the embassy at Rome insulted. The excitement spread across the frontier; there were riots in Trieste, and in Tirol it was necessary to make some slight movement of troops as a sign that the Austrian government was determined not to surrender any territory. For a short time there was apprehension that the Italian government might not be strong enough to resist the movement, and might even attempt to realize these wishes by means of an alliance with Russia; but the danger quickly passed away.

In the year 1879 the European position of the monarchy was

The Eastern question.

Bosnia and Herzegovina.

Italy and the Irredentists.

¹ See General Le Brun, *Souvenirs militaires* (1866-1870, Paris, 1895); also, Baron de Worms, *op. cit.*, and the article on BEUST.

² Josef, Freiherr Philippovich von Philippberg (1818-1889), belonged to an old Christian noble family of Bosnia.

placed on a more secure footing by the conclusion of a formal alliance with Germany. In the autumn of that year Bismarck visited Vienna and arranged with Andrassy a treaty by which Germany bound herself to support Austria against an attack from Russia, Austria-Hungary pledging herself to help Germany against a combined attack of France and Russia; the result of this treaty, of which the tsar was informed, was to remove, at least for the time, the danger of war between Austria-Hungary and Russia. It was the last achievement of Andrassy, who had already resigned, but it was maintained by his successor, Baron Haymerle, and after his death in 1881 by Count Kalnoky. It was strengthened in 1882 by the adhesion of Italy, for after 1881 the Italians required support, owing to the French occupation of Tunis, and after five years it was renewed. Since that time it has been the foundation on which the policy of Austria-Hungary has depended, and it has survived all dangers arising either from commercial differences (as between 1880 and 1890) or national discord. The alliance was naturally very popular among the German Austrians; some of them went so far as to attempt to use it to influence internal policy, and suggested that fidelity to this alliance required that there should be a ministry at Vienna which supported the Germans in their internal struggle with the Slavs; they represented it as a national alliance of the Teutonic races, and there were some Germans in the empire who supported them in this view. The governments on both sides could of course give no countenance to this theory; Bismarck especially was very careful never to let it be supposed that he desired to exercise influence over the internal affairs of his ally. Had he done so, the strong anti-German passions of the Czechs and Poles, always inclined to an alliance with France, would have been aroused, and no government could have maintained the alliance. After 1880, the exertions of Count Kalnoky again established a fairly good understanding with Russia, as was shown by the meetings of Francis Joseph with the tsar in 1884 and 1885, but the outbreak of the Bulgarian question in 1885 again brought into prominence the opposed interests of Russia and Austria-Hungary. In the December of this year Austria-Hungary indeed decisively interfered in the war between Bulgaria and Serbia, for at this time Austrian influence predominated in Serbia, and after the battle of Slivnitsa the Austro-Hungarian minister warned Prince Alexander of Bulgaria that if he advanced farther he would be met by Austro-Hungarian as well as Serbian troops. But after the abdication of Alexander, Count Kalnoky stated in the Delegations that Austria-Hungary would not permit Russia to interfere with the independence of Bulgaria. This decided step was required by Hungarian feeling, but it was a policy in which Austria-Hungary could not depend on the support of Germany, for—as Bismarck stated—Bulgaria was not worth the bones of a single Pomeranian grenadier. Austria-Hungary also differed from Russia as to the position of Prince Ferdinand of Bulgaria, and during 1886–1887 much alarm was caused by the massing of Russian troops on the Galician frontier. Councils of war were summoned to consider how this exposed and distant province was to be defended, and for some months war was considered inevitable; but the danger was averted by the renewal of the Triple Alliance and the other decisive steps taken at this time by the German government (see GERMANY).¹

Since this time the foreign policy of Austria-Hungary has been peaceful and unambitious; the close connexion with Germany has so far been maintained, though during the last few years it has been increasingly difficult to prevent the violent passions engendered by national enmity at home from reacting on the foreign policy of the monarchy; it would scarcely be possible to do so, were it not that discussions on foreign policy take place not in the parliaments but in the Delegations where the numbers are fewer and the passions cooler. In May 1895 Count Kalnoky had to retire, owing to a difference with Bánffy, the Hungarian premier, arising out of the struggle with Rome. He was succeeded by Count Goluchowski, the son of a well-

known Polish statesman. In 1898 the expulsion of Austrian subjects from Prussia, in connexion with the Anti-Polish policy of the Prussian government, caused a passing irritation, to which Count Thun, the Austrian premier, gave expression. The chief objects of the government in recent years have been to maintain Austro-Hungarian trade and influence in the Balkan states by the building of railways, by the opening of the Danube for navigation, and by commercial treaties with Rumania, Serbia and Bulgaria; since the abdication of King Milan especially, the affairs of Serbia and the growth of Russian influence in that country have caused serious anxiety.

The disturbed state of European politics and the great increase in the military establishments of other countries made it desirable for Austria also to strengthen her military resources. **The army.** The bad condition of the finances rendered it, however, impossible to carry out any very great measures. In 1868 there had been introduced compulsory military service in both Austria and Hungary; the total of the army available in war had been fixed at 800,000 men. Besides this joint army placed under the joint ministry of war, there was in each part of the monarchy a separate militia and a separate minister for national defence. In Hungary this national force or *honvéd* was kept quite distinct from the ordinary army; in Austria, however (except in Dalmatia and Tirol, where there was a separate local militia), the *Landwehr*, as it was called, was practically organized as part of the standing army. At the renewal of the periodical financial and economic settlement (*Ausgleich*) in 1877 no important change was made, but in 1882 the system of compulsory service was extended to Bosnia and Herzegovina, and a reorganization was carried out, including the introduction of army corps and local organization on the Prussian plan. This was useful for the purposes of speedy mobilization, though there was some danger that the local and national spirit might penetrate into the army. In 1886 a law was carried in either parliament creating a *Landsturm*, and providing for the arming and organization of the whole male population up to the age of forty-two in case of emergency, and in 1880 a small increase was made in the annual number of recruits. A further increase was made in 1892–1893. In contrast, however, with the military history of other continental powers, that of Austria-Hungary shows a small increase in the army establishment. Of recent years there have been signs of an attempt to tamper with the use of German as the common language for the whole army. This, which is now the principal remnant of the old ascendancy of German, and the one point of unity for the whole monarchy, is a matter on which the government and the monarch allow no concession, but in the Hungarian parliament protests against it have been raised, and in 1890 and 1900 it was necessary to punish recruits from Bohemia, who answered the roll call in the Czechish *zde* instead of the German *hier*.

In those matters which belong to the periodical and terminable agreement, the most important is the Customs Union, which was established in 1867, and it is convenient to treat separately the commercial policy of the dual state.² **The Customs Union.** At first the customs tariff in Austria-Hungary, as in most other countries, was based on a number of commercial treaties with Germany, France, Italy, Great Britain, &c., each of which specified the maximum duties that could be levied on certain articles, and all of which contained a "most favoured nation" clause. The practical result was a system very nearly approaching to the absence of any customs duties, and for the period for which these treaties lasted a revision of the tariff could not be carried out by means of legislation. After the year 1873, a strong movement in favour of protective duties made itself felt among the Austrian manufacturers who were affected by the competition of German, English and Belgian goods, and Austria was influenced by the general movement in economic thought which about this time caused the reaction

¹ Sir Charles Dilke, *The Present Position of European Politics* (London, 1887).

² Matlekovits, *Die Zollpolitik der österreichisch-ungarischen Monarchie* (Leipzig, 1891), gives the Hungarian point of view; Bazant, *Die Handelspolitik Österreich-Ungarns* (1875–1892, Leipzig, 1894).

against the doctrines of free trade. Hungary, on the other hand, was still in favour of free trade, for there were no important manufacturing industries in that country, and it required a secure market for agricultural produce. After 1875 the commercial treaties expired; Hungary thereupon also gave notice to terminate the commercial union with Austria, and negotiations began as to the principle on which it was to be renewed. This was done during the year 1877, and in the new treaty, while raw material was still imported free of duty, a low duty was placed on textile goods as well as on corn, and the excise on sugar and brandy was raised. All duties, moreover, were to be paid in gold—this at once involving a considerable increase. The tariff treaties with Great Britain and France were not renewed, and all attempts to come to some agreement with Germany broke down, owing to the change of policy which Bismarck was adopting at this period. The result was that the system of commercial treaties ceased, and Austria-Hungary was free to introduce a fresh tariff depending simply on legislation, an "autonomous tariff" as it is called. With Great Britain, France and Germany, there was now only a "most favoured nation" agreement; fresh commercial treaties were made with Italy (1879), Switzerland and Servia (1881). During 1881–1882 Hungary, desiring means of retaliation against the duties on corn and the impediments to the importation of cattle recently introduced into Germany, withdrew her opposition to protective duties; the tariff was completely revised, protective duties were introduced on all articles of home production, and high finance duties on other articles such as coffee and petroleum. At the same time special privileges were granted to articles imported by sea, so as to foster the trade of Trieste and Fiume; as in Germany a subvention was granted to the great shipping company, the Austrian Lloyd and Adria; the area of the Customs Union was enlarged so as to include Trieste, Istria and Dalmatia, as well as Bosnia and Herzegovina. In 1887 a further increase of duties was laid on corn (this was at the desire of Hungary as against Rumania, for a vigorous customs war was being carried on at this time) and on woollen and textile goods. Austria, therefore, during these years completely gave up the principle of free trade, and adopted a nationalist policy similar to that which prevailed in Germany. A peculiar feature of these treaties was that the government was empowered to impose an additional duty (*Retorsionszoll*) on goods imported from countries in which Austria-Hungary received unfavourable treatment. In 1881 this was fixed at 10% (5% for some articles), but in 1887 it was raised to 30 and 15% respectively. In 1892 Austria-Hungary joined with Germany, Italy, Belgium, and Switzerland in commercial treaties to last for twelve years, the object being to secure to the states of central Europe a stable and extended market; for the introduction of high tariffs in Russia and America had crippled industry. Two years later Austria-Hungary also arranged with Russia a treaty similar to that already made between Russia and Germany; the reductions in the tariff secured in these treaties were applicable also to Great Britain, with which there still was a most favoured nation treaty. The system thus introduced gave commercial security till the year 1903.

The result of these and other laws was an improvement in financial conditions, which enabled the government at last to take in hand the long-delayed task of reforming the currency. Hitherto the currency had been partly in silver (gulden), the "Austrian currency" which had been introduced in 1857, partly in paper money, which took the form of notes issued by the Austro-Hungarian Bank. This institution had, in 1867, belonged entirely to Austria; it had branches in Hungary, and its notes were current throughout the monarchy, but the direction was entirely Austrian. The Hungarians had not sufficient credit to establish a national bank of their own, and at the settlement of 1877 they procured, as a concession to themselves, that it should be converted into an Austro-Hungarian bank, with a head office at Pest as well as at Vienna, and with the management divided between the two countries. This arrangement was renewed in 1887. In 1848 the government had been obliged to authorize the bank to suspend cash payments, and the wars of 1859 and 1866 had rendered abortive all attempts to renew them. The notes, therefore, formed an inconvertible paper currency. The bank by its charter had the sole right of issuing notes, but during the war of 1866 the government, in order

to raise money, had itself issued notes (*Staatsnoten*) to the value of 312 million gulden, thereby violating the charter of the bank. The operation begun in 1892 was therefore threefold: (1) the substitution of a gold for a silver standard; (2) the redemption of the *Staatsnoten*; (3) the resumption of cash payments by the bank.

In 1867 Austria-Hungary had taken part in the monetary conference which led to the formation of the Latin Union; it was intended to join the Union, but this was not done. A first step, however, had to be taken in this direction by the issue of gold coins of the value of eight and four gulden. No attempt was made, however, to regulate the relations of these coins to the "Austrian" silver coinage; the two issues were not brought into connexion, and every payment was made in silver, unless it was definitely agreed that it should be paid in gold. In 1879, owing to the continued depreciation of silver, the free coinage of silver was suspended. In 1892 laws introducing a completely new coinage were carried in both parliaments, in accordance with agreements made by the ministers. The unit in the new issue was to be the krone, divided into 100 heller; the krone being almost of the same value (24-25th) as the franc. (The twenty-krone piece in gold weighs 6-775 gr., the twenty-franc piece 6-453.) The gold krone was equal to .42 of the gold gulden, and it was declared equal to .5 of the silver gulden, so much allowance being made for the depreciation of silver. The first step towards putting this act into practice was the issue of one-krone pieces (silver), which circulated as half gulden, and of nickel coins; all the copper coins and other silver coins were recalled, the silver gulden alone being left in circulation. The coinage of the gold four- and eight-gulden was suspended. Nothing more could be done till the supply of gold had been increased. The bank was required to buy gold (during 1892 it bought over forty M. gulden), and was obliged to coin into twenty- or ten-krone pieces all gold brought to it for that purpose. Then a loan of 150 M. gulden at 4% was made, and from the gold (chiefly bar gold and sovereigns) which Rothschild, who undertook the loan, paid in, coins of the new issue were struck to the value of over 34 million kronen. This was, however, not put into circulation; it was used first for paying off the *Staatsnoten*. By 1894 the state was able to reduce them to the amount of 200 million gulden, including all those for one gulden. It paid the balance in gold, but in silver (one-krone pieces and gulden) and in bank notes; the coins and notes being provided by the bank, and in exchange the newly-coined gold was paid to the bank to be kept as a reserve to cover the issue of notes. At the same time arrangements were made between Austria and Hungary to pay off about 80 million of exchequer bills which had been issued on the security of the government salt-works, and were therefore called "salinenscheine." In 1899 the remainder of the *Staatsnoten* (112 million gulden) were redeemed in a similar manner. The state had in this way acquired a large reserve of gold, and in the new charter which (after long delay) passed in 1899, a clause was introduced requiring the resumption of cash payments, though this was not to come into operation immediately. Then from 1st January 1900 the old reckoning by gulden was superseded, that by krone being introduced in all government accounts, the new silver being made a legal tender only for a limited amount. For the time until the 1st of July 1908, however, the old gulden were left in circulation, payments made in them, at the rate of two kronen to one gulden, being legal up to any amount.

This important reform has thereby been brought to a satisfactory conclusion, and at a time when the political difficulties had reached a most acute stage. It is indeed remarkable that notwithstanding the complicated machinery of the dual monarchy, and the numerous obstacles which have to be overcome before a reform affecting both countries can be carried out, the financial, the commercial, and the foreign policy, has been conducted since 1870 with success. The credit of the state has risen, the chronic deficit has disappeared, the currency has been put on a sound basis, and part of the unfunded debt has been paid off. Universal military service has been introduced, and all the troubles and the presence of difficulties greater than existed in any other civilized country.

Each of the financial and economic reforms described above was, of course, the subject of a separate law, but, so far as they are determined at the general settlement which takes place between Austria and Hungary every ten years, they are comprised under the expression "Ausgleich" with Hungary. (compact or compromise), which includes especially the determination of the Quota, and to this extent they are all dealt with together as part of a general settlement and bargain. In this settlement a concession on commercial policy would be set off against a gain on the financial agreement; e.g. in 1877 Austria gave Hungary a share in the management of the bank, while the arrangement for paying the bonus on exported sugar was favourable to Austria; on the other hand, since the increased duty on coffee and petroleum would fall more heavily on Austria, the Austrians wished to persuade the Hungarians to pay a larger quota of the common expenses, and there was also a dispute whether Hungary was partly responsible for a debt of 80 M.

guilder to the bank. Each measure had, therefore, to be considered not only on its own merits, but in relation to the general balance of advantage, and an amendment in one might bring about the rejection of all. The whole series of acts had to be carried in two parliaments, each open to the influence of national jealousy and race hatred in its most extreme form, so that the negotiations have been conducted under serious difficulties, and the periodical settlement has always been a time of great anxiety. The first settlement occupied two full years, from 1876, when the negotiations began, to June 1878, when at last all the bills were carried successfully through the two parliaments; and it was necessary to prolong the previous arrangements (which expired at the end of 1877) till the middle of 1878. First the two ministries had to agree on the drafts of all the bills; then the bills had to be laid before the two parliaments. Each parliament elected a committee to consider them, and the two committees carried on long negotiations by notes supplemented by verbal discussions. Then followed the debates in the two parliaments; there was a ministerial crisis in Austria, because the House refused to accept the tax on coffee and petroleum which was recommended by the ministers; and finally a great council of all the ministers, with the emperor presiding, determined the compromise that was at last accepted. In 1877 things went better; there was some difficulty about the tariff, especially about the tax on petroleum, but Count Taaffe had a stronger position than the Austrian ministers of 1877. Ten years later, on the third renewal, the difficulties were still greater. They sprang from a double cause. First the Austrians were determined to get a more favourable division of the common expenses; that of 1867 still continued, although Hungary had grown relatively in wealth.¹ Moreover, a proposed alteration in the taxes on sugar would be of considerable advantage to Hungary; the Austrians, therefore, demanded that henceforth the proportion should be not 68.6:31.4 but 58:42. On this there was a deadlock; all through 1897 and 1898 the Quota-Deputations failed to come to an agreement. This, however, was not the worst. Parliamentary government in Austria had broken down; the opposition had recourse to obstruction, and no business could be done. Their object was to drive out the Badeni government, and for that reason the obstruction was chiefly directed against the renewal of the Ausgleich; for, as this was the first necessity of state, no government could remain in office which failed to carry it through. The extreme parties of the Germans and the anti-Semites were also, for racial reasons, opposed to the whole system. When, therefore, the government at the end of 1897 introduced the necessary measures for prolonging the existing arrangements provisionally till the differences with Hungary had been settled, scenes of great disorder ensued, and at the end of the year the financial arrangements had not been prolonged, and neither the bank charter nor the Customs Union had been renewed. The government, therefore (Badeni having resigned), had to proclaim the necessary measures by imperial warrant. Next year it was even worse, for there was obstruction in Hungary as well as in Austria; the Quota-Deputations again came to no agreement, and the proposals for the renewal of the Bank charter, the reform of the currency, the renewal of the Customs Union, and the new taxes on beer and brandy, which were laid before parliament both at Vienna and Pest, were not carried in either country; this time, therefore, the existing arrangements had to be prolonged provisionally by imperial and royal warrant both in Austria and Hungary. During 1899 parliamentary peace was restored in Hungary by the resignation of Bánffy; in Austria, however, though there was again a change of ministry the only result was that the Czechs imitated the example of the Germans and resorted to obstruction so that still no business could be done. The Austrian ministry, therefore, came to an agreement with the Hungarians that the terms of the new Ausgleich should be

finally proclaimed in Austria by imperial warrant; the Hungarians only giving their assent to this in return for considerable financial concessions.

The main points of the agreement were: (1) the Bank charter was to be renewed till 1910, the Hungarians receiving a larger share in the direction than they had hitherto enjoyed; (2) the Customs Union so far as it was based on a reciprocal and binding treaty lapsed, both sides, however, continuing it in practice, and promising to do so until the 31st of December 1907. Not later than 1901 negotiations were to be begun for a renewal of the alliance, and if possible it was to be renewed from the year 1903, in which year the commercial treaties would expire. If this were done, then the tariff would be revised before any fresh commercial treaties were made. If it were not done, then no fresh treaties would be made extending beyond the year 1907, so that if the Commercial Union of Austria and Hungary were not renewed before 1907, each party would be able to determine its own policy unshackled by any previous treaties. These arrangements in Hungary received the sanction of the parliament; but this could not be procured in Austria, and they were, therefore, proclaimed by imperial warrant; first of all, on 20th July, the new duties on beer, brandy and sugar; then on 23rd September the Bank charter, &c. In November the Quota-Deputations at last agreed that Hungary should henceforward pay 33.4% of a very small increase, and this was also in Austria proclaimed in the same way. The result was that a working agreement was made, by which the Union was preserved. (J. W. He.)

Since the years 1866-1871 no period of Austro-Hungarian development has been so important as the years 1903-1907. The defeat of the old Austria by Prussia at Sadowa in 1866, the establishment of the Dual Monarchy ^{Austro-Hungarian} in 1867 and the foundation of the new German empire ¹⁸⁶⁶⁻¹⁸⁷¹ in 1871, formed the starting-point of Austro-Hungarian history properly so called; but the Austro-Hungarian crisis of 1903-1906—a crisis temporarily settled but not definitively solved,—and the introduction of universal suffrage in Austria, discredited the original interpretation of the dual system and raised the question whether it represented the permanent form of the Austro-Hungarian polity.

At the close of the 19th century both states of the Dual Monarchy were visited by political crises of some severity. Parliamentary life in Austria was paralysed by the feud between Germans and Czechs that resulted directly from the Badeni language ordinances of 1897 and indirectly from the development of Slav influence, particularly that of Czechs and Poles during the Taaffe era (1879-1893). Government in Austria was carried on by cabinets of officials with the help of the emergency clause (paragraph 14) of the constitution. Ministers, nominally responsible to parliament, were in practice responsible only to the emperor. Thus during the closing years of last and the opening years of the present century, political life in Austria was at a low ebb and the constitution was observed in the letter rather than in spirit.

Hungary was apparently better situated. Despite the campaign of obstruction that overthrew the Bánffy and led to the formation of the Széll cabinet in 1899, the hegemony of the Liberal party which, under various names, had been the mainstay of dualism since 1867, appeared to be unshaken. But clear signs of the decay of the dualist and of the growth of an extreme nationalist Magyar current were already visible. The Magyar bills of 1889, which involved an increase of the peace footing of the joint Austro-Hungarian army, had been carried with difficulty, despite the efforts of Koloman Tisza and of Count Julius Andrássy the Elder. Demands tending towards the Magyarization of the joint army had been advanced and had found such an echo in Magyar public opinion that Count Andrássy was obliged solemnly to warn the country of the dangers of nationalist Chauvinism and to remind it of its obligations under the Compact of 1867. The struggle over the civil marriage and divorce laws that filled the greater part of the nineties served and was perhaps intended by the Liberal leaders to serve as a diversion in favour of the Liberal-dualist standpoint; nevertheless, Nationalist feeling found strong expression during the negotiations of Bánffy and Széll with various Austrian premiers for the renewal of the economic Ausgleich, or "Customs and Trade Alliance." At the end of 1902 the Hungarian premier, Széll, concluded with the Austrian premier, Kärber, a new customs and trade alliance

¹ The only change was that as the military frontier had been given over to Hungary, Hungary in consequence of this addition of territory had to pay 2%, the remaining 98% being divided as before, so that the real proportion was 31.4 and 68.6.

comprising a joint Austro-Hungarian tariff as a basis for the negotiation of new commercial treaties with Germany, Italy and other states. This arrangement, which for the sake of brevity will henceforth be referred to as the Széll-Körber Compact, was destined to play an important part in the history of the next few years, though it was never fully ratified by either parliament and was ultimately discarded. Its conclusion was prematurely greeted as the end of a period of economic strife between the two halves of the monarchy and as a pledge of a decade of peaceful development. Events were soon to demonstrate the baselessness of these hopes.

In the autumn of 1902 the Austrian and the Hungarian governments, at the instance of the crown and in agreement with the joint minister for war and the Austrian and

The Army question.

Hungarian ministers for national defence, laid before their respective parliaments bills providing for an increase of 21,000 men in the annual contingents of recruits, 17,000 men were needed for the joint army, and the remainder for the Austrian and Hungarian national defence troops (Landwehr and honvéd). The total contribution of Hungary would have been some 6500 and of Austria some 14,500 men. The military authorities made, however, the mistake of detaining in barracks several thousand supernumerary recruits (i.e. recruits liable to military service but in excess of the annual 103,000 enrollable by law) pending the adoption of the Army bills by the two parliaments. The object of this apparently high-handed step was to avoid the expense and delay of summoning the supernumeraries again to the colours when the bills should have received parliamentary sanction; but it was not unnaturally resented by the Hungarian Chamber, which has ever possessed a lively sense of its prerogatives. The Opposition, consisting chiefly of the independence party led by Francis Kossuth (eldest son of Louis Kossuth), made capital out of the grievance and decided to obstruct ministerial measures until the supernumeraries should be discharged. The estimates could not be sanctioned, and though Kossuth granted the Széll cabinet a vote on account for the first four months of 1903, the Government found itself at the mercy of the Opposition. At the end of 1902 the supernumeraries were discharged—too late to calm the ardour of the Opposition, which proceeded to demand that the Army bills should be entirely withdrawn or that, if adopted, they should be counterbalanced by concessions to Magyar nationalist feeling calculated to promote the use of the Magyar language in the Hungarian part of the army and to render the Hungarian regiments, few of which are purely Magyar, more and more Magyar in character. Széll, who vainly advised the crown and the military authorities to make timely concessions, was obliged to reject these demands which enjoyed the secret support of Count Albert Apponyi, the Liberal president of the Chamber and of his adherents. The obstruction of the estimates continued. On the 1st of May the Széll cabinet found itself without supply and governed for a time "ex-lex"; Széll, who had lost the confidence of the crown, resigned and was succeeded (June 26) by Count Khuen-Hederváry, previously ban, or governor, of Croatia. Before taking office Khuen-Hederváry negotiated with Kossuth and other Opposition leaders, who undertook that obstruction should cease if the Army bills were withdrawn. Despite the fact that the Austrian Army bill had been voted by the Reichsrath (February 19), the crown consented to withdraw the bills and thus compelled the Austrian parliament to repeal, at the dictation of the Hungarian obstructionists, what it regarded as a patriotic measure. Austrian feeling became embittered towards Hungary and the action of the crown was openly criticized.

Meanwhile the Hungarian Opposition broke its engagement. Obstruction was continued by a section of the independence party; and Kossuth, seeing his authority ignored, resigned the leadership. The obstructionists now raised the cry that the German words of command in the joint army must be replaced by Magyar words in the regiments recruited from Hungary—a demand which, apart from its disintegrating influence on the army, the crown

considered to be an encroachment upon the royal military prerogatives as defined by the Hungarian Fundamental Law XII. of 1867. Clause 11 of the law runs:—"In pursuance of the constitutional military prerogatives of His Majesty, everything relating to the unitary direction, leadership and inner organization of the whole army, and thus also of the Hungarian army as a complementary part of the whole army, is recognized as subject to His Majesty's disposal." The cry for the Magyar words of command on which the subsequent constitutional crisis turned, was tantamount to a demand that the monarch should differentiate the Hungarian from the Austrian part of the joint army, and should render it impossible for any but Magyar officers to command Hungarian regiments, less than half of which have a majority of Magyar recruits. The partisans of the Magyar words of command based their claim upon clause 12 of the Fundamental Law XII. of 1867—which runs:—"Nevertheless the country reserves its right periodically to complete the Hungarian army and the right of granting recruits, the fixing of the conditions on which the recruits are granted, the fixing of the term of service and all the dispositions concerning the stationing and the supplies of the troops according to existing law both as regards legislation and administration." Since Hungary reserved her right to fix the conditions on which recruits should be granted, the partisans of the Magyar words of command argued that the abolition of the German words of command in the Hungarian regiments might be made such a condition, despite the enumeration in the preceding clause 11, of everything appertaining to the unitary leadership and inner organization of the joint Austro-Hungarian army as belonging to the constitutional military prerogatives of the crown. Practically, the dispute was a trial of strength between Magyar nationalist feeling and the crown. Austrian feeling strongly supported the monarch in his determination to defend the unity of the army, and the conflict gradually acquired an intensity that appeared to threaten the very existence of the dual system.

When Count Khuen-Hederváry took office and Kossuth relinquished the leadership of the independence party, the extension of the crisis could not be foreseen. A few extreme nationalists continued to obstruct the estimates, and it appeared as though their energy would soon flag. An attempt to quicken this process by bribery provoked, however, an outburst of feeling against Khuen-Hederváry who, though personally innocent, found his position shaken. Shortly afterwards Magyar resentment of an army order issued from the cavalry manoeuvres at Chlopy in Galicia—in which the monarch declared that he would "hold fast to the existing and well-tryed organization of the army" and would never "relinquish the rights and privileges guaranteed to its highest war-lord"; and of a provocative utterance of the Austrian premier Körber in the Reichsrath led to the overthrow of the Khuen-Hederváry cabinet (September 30) by an immense majority. The cabinet fell on a motion of censure brought forward by Kossuth, who had profited by the bribery incident to resume the leadership of his party.

An interval of negotiation between the crown and many leading Magyar Liberals followed, until at the end of October 1903 Count Stephen Tisza, son of Koloman Tisza, accepted a mission to form a cabinet after all others had declined.

Stephen Tisza.

As concession Tisza brought with him a number of concessions from the crown to Magyar nationalist feeling in regard to military matters, particularly in regard to military badges, penal procedure, the transfer of officers of Hungarian origin from Austrian to Hungarian regiments, the establishment of military scholarships for Magyar youths and the introduction of the two years' service system. In regard to the military language, the Tisza programme—which, having been drafted by a committee of nine members, is known as the "programme of the nine"—declared that the responsibility of the cabinet extends to the military prerogatives of the crown, and that "the legal influence of parliament exists in this respect as in respect of every constitutional right." The programme, however, expressly excluded for "weighty political reasons affecting great interests of the nation" the question of the military

language; and on Tisza's motion the Liberal party adopted an addendum, sanctioned by the crown: "the party maintains the standpoint that the king has a right to fix the language of service and command in the Hungarian army on the basis of his constitutional prerogatives as recognized in clause 11 of law XII. of 1867."

Notwithstanding the concessions, obstruction was continued by the Clericals and the extreme Independents, partly in the hope of compelling the crown to grant the Magyar words of command and partly out of antipathy towards the person of the young calvinist premier. In March 1904, Tisza, therefore, introduced a drastic "guillotine" motion to amend the standing orders of the House, but withdrew it in return for an undertaking from the Opposition that obstruction would cease. This time the Opposition kept its word. The Recruits bill and the estimates were adopted, the Delegations were enabled to meet at Budapest—where they voted £22,000,000 as extraordinary estimates for the army and navy and especially for the renewal of the field artillery—and the negotiations for new commercial treaties with Germany and Italy were sanctioned, although parliament had never been able to ratify the Széll-Körber compact with the tariff on the basis of which the negotiations would have to be conducted. But, as the autumn session approached, Tisza foresaw a new campaign of obstruction, and resolved to revert to his drastic reform of the standing orders. The announcement of his determination caused the Opposition to rally against him, and when on the 18th of November the Liberal party adopted a "guillotine" motion by a show of hands in defiance of orthodox procedure, a section of the party seceded. On the 13th of December the Opposition, infuriated by the formation of a special corps of parliamentary constables, invaded and wrecked the Chamber. Tisza appealed to the country and suffered, on the 26th of January 1905, an overwhelming defeat at the hands of a coalition composed of dissentient Liberals, Clericals, Independents and a few Bánfyyites. The Coalition gained an absolute majority and the Independence party became the strongest political group. Nevertheless the various adherents of the dual system retained an actual majority in the Chamber and prevented the Independence party from attempting to realize its programme of reducing the ties between Hungary and Austria to the person of the joint ruler. On the 25th of January, the day before his defeat, Count Tisza had signed on behalf of Hungary the new commercial treaties concluded by the Austro-Hungarian foreign office with Germany and Italy on the basis of the Széll-Körber tariff. He acted *ultra vires*, but by his act saved Hungary from a severe economic crisis and retained for her the right to benefit by economic partnership with Austria until the expiry of the new treaties in 1917.

A deadlock, lasting from January 1905 until April 1906, ensued between the crown and Hungary and, to a great extent, between Hungary and Austria. The Coalition, though

possessing the majority in the Chamber, resolved not to take office unless the crown should grant its demands, including the Magyar words of command and customs separation from Austria. The crown declined to concede these points, either of which would have wrecked the dual system as interpreted since 1867. The Tisza cabinet could not be relieved of its functions till June 1905, when it was succeeded by a non-parliamentary administration under the premiership of General Baron Fejérváry, formerly minister for national defence. Seeing that the Coalition would not take office on acceptable terms, Fejérváry obtained the consent of the crown to a scheme, drafted by Kristóffy, minister of the interior, that the dispute between the crown and the Coalition should be subjected to the test of universal suffrage and that to this end the franchise in Hungary be radically reformed. The scheme alarmed the Coalition, which saw that universal suffrage might destroy not only the hegemony of the Magyar nobility and gentry in whose hands political power was concentrated, but might, by admitting the non-Magyars to political equality with the Magyars, undermine the supremacy of the Magyar race itself. Yet the Coalition did not yield at once. Not until the Chamber had been dissolved

by military force (February 19, 1906) and an open breach of the constitution seemed within sight did they come to terms with the crown and form an administration. The miserable state of public finances and the depression of trade doubtless helped to induce them to perform a duty which they ought to have performed from the first; but their chief motive was the desire to escape the menace of universal suffrage or, at least, to make sure that it would be introduced in such a form as to safeguard Magyar supremacy over the other Hungarian races.

The pact concluded (April 8, 1906) between the Coalition and the crown is known to have contained the following conditions:—All military questions to be suspended until after the introduction of universal suffrage; the estimates and the normal contingent of recruits to be voted for 1905 and 1906; the extraordinary military credits, sanctioned by the delegations in 1904, to be voted by the Hungarian Chamber; ratification of the commercial treaties concluded by Tisza; election of the Hungarian Delegation and of the Quota-Deputation; introduction of a suffrage reform at least as far reaching as the Kristóffy scheme. These "capitulations" obliged the Coalition government to carry on a dualist policy, although the majority of its adherents became, by the general election of May 1906, members of the Kossuth or Independence party, and, as such, pledged to the economic and political separation of Hungary from Austria save as regards the person of the ruler. Attempts were, however, made to emphasize the independence of Hungary. During the deadlock (June 2, 1905) Kossuth had obtained the adoption of a motion to authorize the compilation of an autonomous Hungarian tariff, and on the 28th of May 1906, the Coalition cabinet was authorized by the crown to present the Széll-Körber tariff to the Chamber in the form of a Hungarian autonomous tariff distinct from but identical with the Austrian tariff. This concession of form having been made to the Magyars without the knowledge of the Austrian government, Prince Konrad Hohenlohe, the Austrian premier, resigned office; and his successor, Baron Beck, eventually (July 6) withdrew from the table of the Reichsrath the whole Széll-Körber compact, declaring that the only remaining economic ties between the two countries were freedom of trade, the commercial treaties with foreign countries, the joint state bank and the management of excise. If the Hungarian government wished to regulate its relationship to Austria in a more definite form, added the Austrian premier, it must conclude a new agreement before the end of the year 1907, when the reciprocity arrangement of 1899 would lapse. The Hungarian government replied that any new arrangement with Austria must be concluded in the form of a commercial treaty as between two foreign states and not in the form of a "customs and trade alliance."

Austria ultimately consented to negotiate on this basis. In October 1907 an agreement was attained, thanks chiefly to the sobering of Hungarian opinion by a severe economic crisis, which brought out with unusual clearness the fact that separation from Austria would involve a period of distress if not of commercial ruin for Hungary. Austria also came to see that separation from Hungary would seriously enhance the cost of living in Cisleithania and would deprive Austrian manufacturers of their best market. The main features of the new "customs and commercial treaty" were: (1) Each state to possess a separate but identical customs tariff. (2) Hungary to facilitate the establishment of direct railway communication between Vienna and Dalmatia, the communication to be established by the end of 1911, each state building the sections of line that passed through its own territory. (3) Austria to facilitate railway communication between Hungary and Prussia. (4) Hungary to reform her produce and Stock Exchange laws so as to prevent speculation in agrarian produce. (5) A court of arbitration to be established for the settlement of differences between the two states, Hungary selecting four Austrian and Austria four Hungarian judges, the presidency of the court being decided by lot, and each government being represented before the court by its own delegates. (6) Impediments

Pact of 1906.

Agreement of 1907.

to free trade in sugar to be practically abolished. (7) Hungary to be entitled to redeem her share of the old Austrian debt (originally bearing interest at 5 and now at 4.2%) at the rate of 4.35% within the next ten years; if not redeemed within ten years the rate of capitalization to decrease annually by $\frac{1}{2}\%$ until it reaches 4.2%. This arrangement represents a potential economy of some £2,000,000 capital for Hungary as compared with the original Austrian demand that the Hungarian contribution to the service of the old Austrian debt be capitalized at 4.2%. (8) The securities of the two governments to rank as investments for savings banks, insurance companies and similar institutions in both countries, but not as trust fund investments. (9) Commercial treaties with foreign countries to be negotiated, not, as hitherto, by the joint minister for foreign affairs alone, but also by a nominee of each government. (10) The quota of Austrian and Hungarian contribution to joint expenditure to be 63.6 and 36.4 respectively—an increase of 2% in the Hungarian quota, equal to some £200,000 a year.

The economic dispute between Hungary and Austria was thus settled for ten years after negotiations lasting more than twelve years. One important question, however, that of the future of the joint State Bank, was left over for subsequent decision. During the negotiations for the customs and commercial treaty, the Austrian government attempted to conclude for a longer period than ten years, but was unable to overcome Hungarian resistance. Therefore, at the end of 1917, the commercial treaties with Germany, Italy and other countries, and the Austro-Hungarian customs and commercial treaty, would all lapse. Ten years of economic unity remained during which the Dual Monarchy might grow together or grow asunder, increasing accordingly in strength or in weakness. (H. W. S.)

During this period of internal crisis the international position of the Dual Monarchy was threatened by two external dangers. The unrest in Macedonia threatened to reopen the Eastern Question in an acute form; with Italy the irredentist attitude of the Zanardelli cabinet led in 1902-1903 to such strained relations that war seemed imminent. The southern Tirol, the chief passes into Italy, strategic points on the Istrian and Dalmatian coasts, were strongly fortified, while in the interior the Tauern, Karawanken and Wochein railways were constructed, partly in order to facilitate the movement of troops towards the Italian border. The tension was relaxed with the fall of the Zanardelli government, and comparatively cordial relations were gradually re-established.

In the affairs of the Balkan Peninsula a temporary agreement with Russia was reached in 1903 by the so-called "February Programme," supplemented in the following October by the "Mürzsteg Programme" (see MACEDONIA; TURKEY; EUROPE: History). The terms of the Mürzsteg programme were observed by Count Goluchowski, in spite of the ruin of Russian prestige in the war with Japan, so long as he remained in office. In October 1906, however, he retired, and it was soon clear that his successor, Baron von Aerenthal,¹ was determined to take advantage of the changed European situation to take up once more the traditional policy of the Habsburg monarchy in the Balkan Peninsula. He gradually departed from the Mürzsteg basis, and in January 1908 deliberately undermined the Austro-Russian agreement by obtaining from the sultan a concession for a railway from the Bosnian frontier through the sanjak of Novibazar to the Turkish terminus at Mitrovitza. This was done in the teeth of the expressed wish of Russia; it roused the helpless resentment of Serbia, whose economic dependence upon the Dual Monarchy was emphasized by the outcome of the war of tariffs into which she had plunged in 1906, and who saw in this scheme another link in the chain forged for her by the Habsburg empire; it

offended several of the great powers, who seemed to see in this railway concession the price of the abandonment by Austria-Hungary of her interest in Macedonian reforms. That Baron von Aerenthal was able to pursue a policy apparently so rash, was due to the fact that he could reckon on the support of Germany. The intimate relations between the two powers had been revealed during the dispute between France and Germany about Morocco; in the critical division of the 3rd of March 1906 at the Algeiras Conference Austria-Hungary, alone of all the powers, had sided with Germany, and it was a proposal of the Austro-Hungarian plenipotentiary that formed the basis of the ultimate settlement between Germany and France (see MOROCCO: History). The cordial relations thus emphasized encouraged Baron Aerenthal, in the autumn of 1908, to pursue a still bolder policy. The revolution in Turkey had entirely changed the face of the Eastern Question; the problem of Macedonian reform was swallowed up in that of the reform of the Ottoman empire generally, there was even a danger that a rejuvenated Turkey might in time lay claim to the provinces occupied by Austria-Hungary under the treaty of Berlin; in any case, the position of these provinces, governed autocratically from Vienna, between a constitutional Turkey and a constitutional Austria-Hungary, would have been highly anomalous. In the circumstances Baron Aerenthal determined on a bold policy. Without consulting the co-signatory powers of the treaty of Berlin, and in deliberate violation of its provisions, the king-emperor issued, on the 13th of October, a decree annexing Bosnia and Herzegovina to the Habsburg Monarchy, and at the same time announcing the withdrawal of the Austro-Hungarian troops from the sanjak of Novibazar. (See EUROPE: History.)

Meanwhile the relations between the two halves of the Dual Monarchy had again become critical. The agreement of 1907 had been but a truce in the battle between two irreconcilable principles: between Magyar nationalism, determined to maintain its ascendancy in an independent Hungary, and Habsburg imperialism, equally determined to preserve the economic and military unity of the Dual Monarchy. In this conflict the tactical advantage lay with the monarchy; for the Magyars were in a minority in Hungary, their ascendancy was based on a narrow and artificial franchise, and it was open to the king-emperor to hold in *terrorem* over them an appeal to the disfranchised majority. It was the introduction of a Universal Suffrage Bill by Mr Joseph Kristóffy, minister of the interior in the "unconstitutional" cabinet of Baron Fejérváry, which brought the Opposition leaders in the Hungarian parliament to terms and made possible the agreement of 1907. But the Wckerle ministry which succeeded that of Fejérváry on the 9th of April 1906 contained elements which made any lasting compromise impossible. The burning question of the "Magyar word of command" remained unsettled, save in so far as the fixed determination of the king-emperor had settled it; the equally important question of the renewal of the charter of the Austro-Hungarian State Bank had also formed no part of the agreement of 1907. On the other hand, the Wckerle ministry was pledged to a measure of franchise reform, a pledge which they showed no eagerness to redeem, though the granting of universal suffrage in the Austrian half of the Monarchy had made such a change inevitable. In March 1908 Mr Hallo laid before the Hungarian parliament a formal proposal that the charter of the Austro-Hungarian Bank, which was to expire at the end of 1910, should not be renewed; and that, in the event of failure to negotiate a convention between the banks of Austria and Hungary, a separate Hungarian Bank should be established. This question, obscured during the winter by the Balkan crisis, once more became acute in the spring of 1909. In the Coalition cabinet itself opinion was sharply divided, but in the end the views of the Independence party prevailed, and Dr Wckerle laid the proposal for a separate Hungarian Bank before the king-emperor and the Austrian government. Its reception was significant. The emperor Francis Joseph pointed out that the question of a separate Bank for Hungary

Internal
diffi-
culties.

¹ Alois, Count Lexa von Aerenthal, was born on the 27th of September 1854 at Gross-Schlatt in Bohemia, studied at Bonn and Prague, was attaché at Paris (1877) and afterwards at St Petersburg, envoy extraordinary at Bucharest (1895) and ambassador at St Petersburg (1896). He was created a count on the emperor's 79th birthday in 1909.

did not figure in the act of 1867, and could not be introduced into it, especially since the capital article of the ministerial programme, i.e. electoral reform, was not realized, nor near being realised. This was tantamount to an appeal from the Magyar *populus* to the Hungarian *plebs*, the disfranchised non-Magyar majority; an appeal all the more significant from the fact that it ignored the suffrage bill brought in on behalf of the Hungarian government by Count Julius Andrassy in November 1908, a bill which, under the guise of granting the principle of universal suffrage, was ingeniously framed so as to safeguard and even to extend Magyar ascendancy (see HUNGARY: History). In consequence of this rebuff Dr Wekerle tendered his resignation on the 27th of April. Months passed without it being possible to form a new cabinet, and a fresh period of crisis and agitation was begun.

(W. A. P.)

II. Austria Proper since 1867.

As already explained, the name Austria is used for convenience to designate those portions of the possessions of the house of Habsburg, which were not included by the settlement of 1867 among the lands of the Hungarian crown. The separation of Hungary made it necessary to determine the method by which these territories¹ were henceforth to be governed. It was the misfortune of the country that there was no clear legal basis on which new institutions could be erected. Each of the territories was a separate political unit with a separate history, and some of them had a historic claim to a large amount of self-government; in many the old feudal estates had survived till 1848. Since that year the empire had been the subject of numerous experiments in government; by the last, which began in 1860, *Landtage* or diets have been instituted in each of the territories on a nearly uniform system and with nearly identical powers, and by the constitution published in February 1861 (the February Constitution, as it is called), which is still the ultimate basis for the government, there was instituted a *Reichsrath* or parliament for the whole empire; it consisted of a House of Lords (*Herrenhaus*), in which sat the archbishops and prince bishops, members of the imperial family, and other members appointed for life, besides some hereditary members, and a Chamber of Deputies. The members of the latter for each territory were not chosen by direct election, but by the diets. The diets themselves were elected for six years; they were chosen generally (there were slight local differences) in the following way: (a) a certain number of bishops and rectors of universities sat in virtue of their office; (b) the rest of the members were chosen by four electoral bodies or *curiae*,—(1) the owners of estates which before 1848 had enjoyed certain feudal privileges, the so-called great proprietors; (2) the chambers of commerce; (3) the towns; (4) the rural districts. In the two latter classes all had the suffrage who paid at least ten gulden in direct taxes. The districts were so arranged as to give the towns a very large representation in proportion to their populations. In Bohemia, e.g., the diet consisted of 241 members: of these five were *ex officio* members; the feudal proprietors had seventy; the towns and chambers of commerce together had eighty-seven; the rural districts seventy-nine. The electors in the rural districts were 236,000, in the towns 93,000. This arrangement seems to have been deliberately made by Schmerling, so as to

¹ It is impossible to avoid using the word "Austria" to designate these territories, though it is probably incorrect. Officially the word "Austria" is not found, and though the sovereign is emperor of Austria, an Austrian empire appears not to exist; the territories are spoken of in official documents as "the kingdoms and lands represented in the Reichsrath." The Hungarians and the German party in Austria have expressed their desire that the word Austria should be used, but it has not been gratified. On the other hand, expressions such as "Austrian citizens," "Austrian law" are found. The reason of this peculiar use is probably twofold. On the one hand, a reluctance to confess that Hungary is no longer in any sense a part of Austria; on the other hand, the refusal of the Czechs to recognize that their country is part of Austria. Sometimes the word *Erbländer*, which properly is applied only to the older ancestral dominions of the house of Habsburg, is used for want of a better word.

give greater power to the German inhabitants of the towns; the votes of the proprietors would, moreover, nearly always give the final decision to the court and the government, for the influence exercised by the government over the nobility would generally be strong enough to secure a majority in favour of the government policy.

This constitution had failed; territories so different in size, history and circumstances were not contented with similar institutions, and a form of self-government which satisfied Lower Austria and Salzburg did not satisfy Galicia and Bohemia. The Czechs of Bohemia, like the Magyars, had refused to recognize the common parliament on the ground that it violated the historic rights of the Bohemian as of the Hungarian crown, and in 1865 the constitution of 1861 had been superseded, while the territorial diets remained. In 1867 it was necessary once more to summon, in some form or another, a common parliament for the whole of Austria, by which the settlement with Hungary could be ratified.

This necessity brought to a decisive issue the struggle between the parties of the Centralists and Federalists. The latter claimed that the new constitution must be made by agreement with the territories; the former maintained that the constitution of 1861 was still valid, and demanded that in accordance with it the Reichsrath should be summoned and a "constitutional" government restored. The difference between the two parties was to a great extent, though not entirely, one of race. The kernel of the empire was the purely German district, including Upper and Lower Austria, Salzburg, Tirol (except the south) and Vorarlberg, all Styria except the southern districts, and a large part of Carinthia. There was strong local feeling, especially in Tirol, but it was local feeling similar to that which formerly existed in the provinces of France; among all classes and parties there was great loyalty both to the ruling house and to the idea of the Austrian state; but while the Liberal party, which was dominant in Lower Austria and Styria, desired to develop the central institutions, there was a strong Conservative and Clerical party which supported local institutions as a protection against the Liberal influence of a centralized parliament and bureaucracy, and the bishops and clergy were willing to gain support in the struggle by alliance with the Federalists.

Very different was it in the other territories where the majority of the population was not German—and where there was a lively recollection of the time when they were not Austrian. With Palacky, they said, "We existed before Austria; we shall continue to exist after it is gone." Especially was this the case in Bohemia.

In this great country, the richest part of the Austrian dominions, where over three-fifths of the population were Czech, racial feeling was supported by the appeal to historic law. A great party, led by Palacky and Rieger, demanded the restoration of the Bohemian monarchy in its fullest extent, including Moravia and Silesia, and insisted that the emperor should be crowned as king of Bohemia at Prague as his predecessors had been, and that Bohemia should have a position in the monarchy similar to that obtained by Hungary. Not only did the party include all the Czechs, but they were supported by many of the great nobles who were of German descent, including Count Leo Thun, his brother-in-law Count Heinrich Clam-Martinitz, and Prince Friedrich von Schwarzenberg, cardinal archbishop of Prague, who hoped in a self-governing kingdom of Bohemia to preserve that power which was threatened by the German Liberals. The feudal nobles had great power arising from their wealth, the great traditions of their families, and the connexion with the court, and by the electoral law they had a large number of representatives in the diet. On the other hand the Germans of Bohemia, fearful of falling under the control of the Czechs, were the most ardent advocates of centralization. The Czechs were supported also by their fellow-countrymen in Moravia, and some of the nobles, headed by Count Belcredi, brother of the minister; but in Brünn there was a strong German party. In Silesia the Germans had a considerable majority, and as

Centralists and Federalists.

The February Constitution.

The Slavonic lands.

there was a large Polish element which did not support the Czechs, the diet refused to recognize the claims of the Bohemians.

The Poles of Galicia stood apart from the other Slav races. The German-speaking population was very small, consisting chiefly of government officials, railway servants and Jews; but there was a large minority (some 43%) of Ruthenes. The Poles wished to gain as much autonomy as they could for their own province, but they had no interest in opposing the centralization of other parts; they were satisfied if Austria would surrender the Ruthenes to them. They were little influenced by the pan-Slav agitation; it was desirable for them that Austria, which gave them freedom and power, should continue strong and united. Their real interests were outside the monarchy, and they did not cease to look forward to a restoration of the Polish kingdom. The great danger was that they might entangle Austria in a war with Russia.

The southern Slavs had neither the unity, nor the organization, nor the historical traditions of the Czechs and Poles; but the Slovenes, who formed a large majority of the population in Carniola, and a considerable minority in the adjoining territory of Carinthia and the south of Styria, demanded that their language should be used for purposes of government and education. Their political ideal was an "Illyrian" kingdom, including Croatia and all the southern Slavs in the coast district, and a not very successful movement had been started to establish a so-called Illyrian language, which should be accepted by both Croats and Slovenes. There was, however, another element in the southern districts, viz. the Serbs, who, though of the same race and language as the Croats, were separated from them by religion. Belonging to the Orthodox Church they were attracted by Russia. They were in constant communication with Serbia and Montenegro; and their ultimate hope, the creation of a great Servian kingdom, was less easy to reconcile with loyalty to Austria. Of late years attempts have been made to turn the Slovenian national movement into this direction, and to attract the Slovenes also towards the Orthodox non-Austrian Slavs.

In the extreme south of Dalmatia is a small district which had not formed part of the older duchy of Dalmatia, and had not been joined to the Austrian empire till 1814; in former years part of it formed the republic of Ragusa, and the rest belonged to Albania. The inhabitants of this part, who chiefly belonged to the Greek Church, still kept up a close connexion with Albania and with Montenegro, and Austrian authority was maintained with difficulty. Disturbances had already broken out once before; and in 1869 another outbreak took place. This district had hitherto been exempted from military service; by the law of 1869, which introduced universal military service, those who had hitherto been exempted were required to serve, not in the regular army but in the militia. The inhabitants of the district round the Bocche di Cattaro (the Bocchesi, as they are commonly called) refused to obey this order, and when a military force was sent it failed to overcome their resistance; and by an agreement made at Knežac in December 1869, Rodics, who had taken command, granted the insurgents all they asked and a complete amnesty. After the conquest of Bosnia another rebellion was made to enforce military service; once more a revolt broke out, and spread to the contiguous districts of Herzegovina. This time, however, the government, whose position in the Balkans had been much strengthened by the occupation of the new provinces, did not fear to act with decision. A considerable force was sent under General Baron Stephan von Jovanovich (1828-1885); they were supported from sea by the navy, and eventually the rebellion was crushed. An amnesty was proclaimed, but the greater number of the insurgents sought refuge in Montenegro rather than submit to military service.

The Italians of Trieste and Istria were the only people of the empire who really desired separation from Austria; annexation to Italy was the aim of the *Italianissimi*, as they were called. The feeling was less strong in Tirol, where, except in the city of Trent, they seem chiefly to have wished for separate local institutions, so that they should no longer be governed from Innsbruck. The Italian-speaking population on the coast of Dalmatia only asked that the government should uphold them against the pressure of the Slav races in the interior, and for this reason were ready to support the German constitutionalists.

The party of centralization was then the Liberal German

party, supported by a few Italians and the Ruthenes, and as years went by it was to become the National German party. They hoped by a common parliament to create the feeling of a common Austrian nationality, by German schools to spread the use of the German language. Every grant of self-government to the territories must diminish the influence of the Germans, and bring about a restriction in the use of the German language; moreover, in countries such as Bohemia, full self-government would almost certainly mean that the Germans would become the subject race. This was a result which they could not accept. It was intolerable to them that just at the time when the national power of the non-Austrian Germans was so greatly increased, and the Germans were becoming the first race in Europe, they themselves should resign the position as rulers which they had won during the last three hundred years. They maintained, moreover, that the ascendancy of the Germans was the only means of preserving the unity of the monarchy; German was the only language in which the different races could communicate with one another; it must be the language of the army, the civil service and the parliament. They laid much stress on the historic task of Austria in bringing German culture to the half-civilized races of the east. They demanded, therefore, that all higher schools and universities should remain German, and that so far as possible the elementary schools should be Germanized. They looked on the German schoolmaster as the apostle of German culture, and they looked forward to the time when the feeling of a common Austrian nationality should obscure the national feeling of the Slavs, and the Slavonic idioms should survive merely as the local dialects of the peasantry, the territories becoming merely the provinces of a united and centralized state. The total German population was not quite a third of the whole. The maintenance of their rule was, therefore, only possible by the exercise of great political ability, the more so, since, as we have seen, they were not united among themselves, the clergy and Feudal party being opposed to the Liberals. Their watchword was the constitution of 1861, which had been drawn up by their leaders; they demanded that it should be restored, and with it parliamentary government. They called themselves, therefore, the Constitutional party. But the introduction of parliamentary government really added greatly to the difficulty of the task before them. In the old days German ascendancy had been secured by the common army, the civil service and the court. As soon, however, as power was transferred to a parliament, the Germans must inevitably be in a minority, unless the method of election was deliberately arranged so as to give them a majority. Parliamentary discussion, moreover, was sure to bring out those racial differences which it was desirable should be forgotten, and the elections carried into every part of the empire a political agitation which was very harmful when each party represented a different race.

The very first events showed one of those extraordinary changes of policy so characteristic of modern Austrian history. The decision of the government on the constitutional question was really determined by immediate practical necessity. The Hungarians required that the settlement should be ratified by a parliament, therefore a parliament must be procured which would do this. It must be a parliament in which the Germans had a majority, for the system of dualism was directly opposed to the ambitions of the Slavs and the Federalists. Belcredi, who had come into power in 1865 as a Federalist, and had suspended the constitution of 1861 on the 2nd of January 1867, ordered new elections for the diets, which were then to elect deputies to an extraordinary Reichsrath which should consider the *Ausgleich*, or compact with Hungary. The wording of the decree implied that the February constitution did not exist as of law; the Germans and Liberals, strenuously objecting to a "feudal-federal" constitution which would give the Slavs a preponderance in the empire, maintained that the February constitution was still in force, and that changes could only be introduced by a regular Reichsrath summoned in accordance with it, protested against the decree, and, in some cases, threatened not to take part in the elections. As the Federalists

were all opposed to the Ausgleich, it was clear that a Reichsrath chosen in these circumstances would refuse to ratify it, and this was probably Belcredi's intention. As the existence of the empire would thereby be endangered, Beust interfered; Belcredi was dismissed, Beust himself became minister-president on the 7th of February 1867, and a new edict was issued from Vienna ordering the diets to elect a Reichsrath, according to the constitution, which was now said to be completely valid. Of course, however, those diets in which there was a Federalist majority, viz. those of Bohemia, Moravia, Carinthia and Tirol, which were already pledged to support the January policy of the government, did not acquiesce in the February policy; and they refused to elect except on terms which the government could not accept. The first three were immediately dissolved. In the elections which followed in Bohemia the influence of the government was sufficient to secure a German majority among the landed proprietors; the Czechs, who were therefore in a minority, declared the elections invalid, refused to take any part in electing deputies for the Reichsrath, and seceded altogether from the diet. The result was that Bohemia now sent a large German majority to Vienna, and the few Czechs who were chosen refused to take their seat in the parliament. Had the example of the Czechs been followed by the other Slav races it would still have been difficult to get together a Reichsrath to pass the Ausgleich. It was, however, easier to deal with the Poles of Galicia, for they had no historical rights to defend; and by sending delegates to Vienna they would not sacrifice any principle or prejudice any legal claim; they had only to consider how they could make the best bargain. Their position was a strong one; their votes were essential to the government, and the government could be useful to them; it could give them the complete control over the Ruthenes. A compact then was easily arranged.

Beust promised them that there should be a special minister for Galicia, a separate board for Galician education, that Polish should be the language of instruction in all secondary schools, that Polish instead of German should be the official language in the law courts and public offices, Ruthenian being only used in the elementary schools under strict limitations. On these terms the Polish deputies, led by Ziemiakowski, agreed to go to Vienna and vote for the Ausgleich.

When the Reichsrath met, the government had a large majority; and in the House, in which all the races except the Czechs were represented, the Ausgleich was ratified almost unanimously. This having been done, it was possible to proceed to special legislation for the territories, which were henceforward officially known as "the kingdoms and lands represented in the Reichsrath." A series of fundamental laws were carried, which formally established parliamentary government, with responsibility of ministers, and complete control over the budget, and there were included a number of clauses guaranteeing personal rights and liberties in the way common to all modern constitutions. The influence of the Poles was still sufficient to secure considerable concessions to the wishes of the Federalists, since if they did not get what they wished they would leave the House, and the Slovenes, Dalmatians and Tirolese would certainly follow them. Hence the German Liberals were prevented from introducing direct elections to the Reichsrath, and the functions of the Reichsrath were slightly less extensive than they had hitherto been. Moreover, the Delegation was to be chosen not by the House as a whole, but by the representatives of the separate territories. This is one reason for the comparative weakness of Austria as compared with Hungary, where the Delegation is elected by each House as a whole; the Bohemian representatives, e.g., meet and choose 10 delegates, the Galicians 7, those from Trieste 1; the Delegation, is, therefore, not representative of the majority of the chamber of deputies, but includes representatives of all the groups which may be opposing the government there, and they can carry on their opposition even in the Delegation. So it came about in 1869, that on the first occasion when there was a joint sitting of the Delegations to settle a point in the

budget, which Hungary had accepted and Austria rejected, the Poles and Tirolese voted in favour of the Hungarian proposal.

As soon as these laws had been carried (December 1867), Beust retired from the post of minister-president; and in accordance with constitutional practice a parliamentary ministry was appointed entirely from the ranks of the Liberal majority; a ministry generally known as the "Bürger Ministerium" in which Giskra and Herbst—the leaders of the German party in Moravia and Bohemia—were the most important members. Austria now began its new life as a modern constitutional state. From this time the maintenance of the revised constitution of 1867 has been the watchword of what is called the Constitutional party. The first use which the new government made of their power was to settle the finances, and in this their best work was done. Among them were nearly all the representatives of trade and industry, of commercial enterprise and financial speculation; they were the men who hoped to make Austria a great industrial state, and at this time they were much occupied with railway enterprise. Convinced free-traders, they hoped by private energy to build up the fortunes of the country, parliamentary government—which meant for them the rule of the educated and well-to-do middle class—being one of the means to this end. They accepted the great burden of debt which the action of Hungary imposed upon the country, and rejected the proposals for repudiation, but notwithstanding the protest of foreign bondholders they imposed a tax of 16% on all interest on the debt. They carried out an extension of the commercial treaty with Great Britain by which a further advance was made in the direction of free trade.

Of equal importance was their work in freeing Austria from the control of the Church, which checked the intellectual life of the people. The concordat of 1855 had given the Church complete freedom in the management of all ecclesiastical affairs; there was full liberty of intercourse with Rome, the state gave up all control over the appointment of the clergy, and in matters of church discipline the civil courts had no voice—the clergy being absolutely subject to the power of the bishops, who could impose temporal as well as spiritual penalties. The state had even resigned to the Church all authority over some departments of civil life, and restored the authority of the canon law. This was the case as regards marriage; all disputes were to be tried before ecclesiastical courts, and the marriage registers were kept by the priests. All the schools were under the control of the Church; the bishops could forbid the use of books prejudicial to religion; in elementary schools all teachers were subject to the inspection of the Church, and in higher schools only Roman Catholics could be appointed. It had been agreed that the whole education of the Roman Catholic youth, in all schools, private as well as public, should be in accordance with the teaching of the Roman Catholic Church. The authority of the Church extended even to the universities. Some change in this system was essential; the Liberal party demanded that the government should simply state that the concordat had ceased to exist. To this, however, the emperor would not assent, and there was a difficulty in over-throwing an act which took the form of a treaty. The government wished to come to some agreement by friendly discussion with Rome, but Pius IX. was not willing to abate anything of his full claims. The ministry, therefore, proceeded by internal legislation, and in 1868 introduced three laws: (1) a marriage law transferred the decisions on all questions of marriage from the ecclesiastical to the civil courts, abolished the authority of the canon law, and introduced civil marriage in those cases where the clergy refused to perform the ceremony; (2) the control of secular education was taken from the Church, and the management of schools transferred to local authorities which were to be created by the diets; (3) complete civil equality between Catholics and non-Catholics was established. These laws were carried through both Houses in May amid almost unparalleled excitement, and at once received the imperial sanction, notwithstanding the protest of all the bishops, led by Joseph Othmar

Beust's compact with the Poles.

The constitution of 1867.

The Bürger Ministerium.

The Liberals and the concordat.

von Rauscher (1797-1875), cardinal archbishop of Vienna, who had earned his red hat by the share he had taken in arranging the concordat of 1855, and now attempted to use his great personal influence with the emperor (his former pupil) to defeat the bill.

The ministry had the enthusiastic support of the German population in the towns. They were also supported by the teaching profession, which desired emancipation from ecclesiastical control, and hoped that German schools and German railways were to complete the work which Joseph II. had begun. But the hostility of the Church was dangerous. The pope, in an allocution of 22nd June 1868, declared that these "damnable and abominable laws" which were "contrary to the concordat, to the laws of the Church and to the principles of Christianity," were "absolutely and for ever null and void." The natural result was that when they were carried into effect the bishops in many cases refused to obey. They claimed that the laws were inconsistent with the concordat, that the concordat still was in force, and that the laws were consequently invalid. The argument was forcible, but the courts decided against them. Rudigier, bishop of Linz, was summoned to a criminal court for disturbing the public peace; he refused to appear, for by the concordat bishops were not subject to temporal jurisdiction; and when he was condemned to imprisonment the emperor at once telegraphed his full pardon. In the rural districts the clergy had much influence; they were supported by the peasants, and the diets of Tirol and Vorarlberg, where there was a clerical majority, refused to carry out the school law.

On the proclamation of papal infallibility in 1870, the government took the opportunity of declaring that the concordat had lapsed, on the ground that there was a fundamental change in the character of the papacy. Nearly all the Austrian prelates had been opposed to the new doctrine; many of them remained to the end of the council and voted against it, and they only declared their submission with great reluctance. The Old Catholic movement, however, never made much progress in Austria. Laws regulating the position of the Church were carried in 1874. (For the concordat see Laveleye, *La Prusse et l'Autriche*, Paris, 1870.)

During 1868 the constitution then was open to attack on two sides, for the nationalist movement was gaining ground in Bohemia and Galicia. In Galicia the extreme party, headed by Smolka, had always desired to imitate the Czechs and not attend at Vienna; they were outvoted, but all parties agreed on a declaration in which the final demands of the Poles were drawn up;¹ they asked that the powers of the Galician diet should be much increased, and that the members from Galicia should cease to attend the Reichsrath on the discussion of those matters with which the Galician diet should be qualified to deal. If these demands were not granted they would leave the Reichsrath. In Bohemia the Czechs were very active; while the Poles were parading their hostility to Russia in such a manner as to cause the emperor to avoid visiting Galicia, some of the Czech leaders attended a Slav demonstration at Moscow, and in 1868 they drew up and presented to the diet at Prague a "declaration" which has since been regarded as the official statement of their claims. They asked for the full restoration of the Bohemian kingdom; they contended that no foreign assembly was qualified to impose taxes in Bohemia; that the diet was not qualified to elect representatives to go to Vienna, and that a separate settlement must be made with Bohemia similar to that with Hungary. This declaration was signed by eighty-one members, including many of the feudal nobles and bishops.² The German majority declared that they had forfeited their seats, and ordered new elections. The agitation spread over the country, serious riots took place, and with a view to keeping order the government decreed exceptional laws. Similar events happened in Moravia, and in Dalmatia the revolt broke out among the Bocchesi.

Before the combination of Clericals and Federalists the ministry broke down; they were divided among themselves; Counts Taaffe and Alfred Potocki, the minister of agriculture, wished to conciliate the Slav races—a policy recommended

by Beust, probably with the sympathy of the emperor; the others determined to cripple the opposition by taking away the elections for the Reichsrath from the diets. *Parliamentary breakdown of 1870.* Taaffe and his friends resigned in January 1870, but the majority did not long survive. In March, after a long delay, the new Galician demands were definitely rejected; the whole of the Polish club, followed by the Tirolese and Slovenes, left the House, which consequently consisted of 110 members—the Germans and German representatives from Bohemia and Moravia. It was clearly impossible to govern with such a parliament. Not four years had gone by, and the new constitution seemed to have failed like the old one. The only thing to do was to attempt a reconciliation with the Slavs. The ministry resigned, and Potocki and Taaffe formed a government with this object. Potocki, now minister-president, then entered on negotiations, hoping to persuade the Czechs to accept the constitution. Rieger and Thun were summoned to Vienna; he himself went to Prague, but after two days he had to give up the attempt in despair. Feudals and Czechs all supported the declaration of 1868, and would accept no compromise, and he returned to Vienna after what was the greatest disappointment of his life. Government, however, had to be carried on; the war between Germany and France broke out in July, and Austria might be drawn into it; the emperor could not at such a crisis alienate either the Germans or the Slavs. The Reichsrath and all the diets were dissolved. This time in Bohemia the Czechs, supported by the Feudals and the Clericals, gained a large majority; they took their seats in the diet only to declare that they did not regard it as the legal representative of the Bohemian kingdom, but merely an informal assembly, and refused to elect delegates for the Reichsrath. The Germans in their turn now left the diet, and the Czechs voted an address to the crown, drawn up by Count Thun, demanding the restoration of the Bohemian kingdom. When the Reichsrath met there were present only 130 out of 203 members, for the whole Bohemian contingent was absent; the government then, under a law of 1868, ordered that as the Bohemian diet had sent no delegates, they were to be chosen directly from the people. Twenty-four Constitutionalists and thirty *Declaranten* were chosen; the latter, of course, did not go to Vienna, but the additional twenty-four made a working majority by which the government was carried on for the rest of the year.

But Potocki's influence was gone, and as soon as the European crisis was over, in February 1871, the emperor appointed a ministry chosen not from the Liberals but from the Federalists and Clericals, led by Count Hohenwart and A. E. F. Schaffle, a professor at the university of Vienna, chiefly known for his writings on political economy. They attempted to solve the problem by granting to the Federalists all their demands. So long as parliament was sitting they were kept in check; as soon as it had voted supplies and the Delegations had separated, they ordered new elections in all those diets where there was a Liberal majority. By the help of the Clericals they won enough seats to put the Liberals in a minority in the Reichsrath, and it would be possible to revise the constitution if the Czechs consented to come. They would only attend, however, on their own terms, which were a complete recognition by the government of the claims made in the Declaration. This was agreed to; and on the 12th of September at the opening of the diet, the governor read a royal message recognizing the separate existence of the Bohemian kingdom, and promising that the emperor should be crowned as king at Prague. It was received with delight throughout Bohemia, and the Czechs drew a draft constitution of fundamental rights. On this the Germans, now that they were in a minority, left the diet, and began preparations for resistance. In Upper Austria, Moravia and Carinthia, where they were outvoted by the Clericals, they seceded, and the whole work of 1867 was on the point of being overthrown. Were the movement not stopped the constitution would be superseded, and the union with Hungary endangered. Beust and Andrassy warned the emperor of the danger, and the crown prince of Saxony was summoned

¹ The documents are printed in Baron de Worms, *op. cit.*

² It is printed in the *Europäischer Geschichtskalender* (1868).

by Beust to remonstrate with him. A great council was called at Vienna (October 20), at which the emperor gave his decision that the Bohemian demands could not be accepted. The Czechs must come to Vienna, and consider a revision of the constitution in a constitutional manner. Hohenwart resigned, but at the same time Beust was dismissed, and a new cabinet was chosen once more from among the German Liberals, under the leadership of Prince Adolf Auersperg, whose brother Carlos had been one of the chief members in the Bürgerministerium. For the second time in four years the policy of the government had completely changed within a few months. On 12th September the decree had been published accepting the Bohemian claims; before the end of the year copies of it were seized by the police, and men were thrown into prison for circulating it.

Auersperg's ministry held office for eight years. They began as had the Bürgerministerium, with a vigorous Liberal centralizing policy. In Bohemia they succeeded at first in almost crushing the opposition. In 1872 the diet was dissolved; and the whole influence of the government was used to procure a German majority. Koller, the governor, acted with great vigour. Opposition newspapers were suppressed; cases in which Czech journalists were concerned were transferred to the German districts, so that they were tried by a hostile German jury. Czech manifestoes were confiscated, and meetings stopped at the slightest appearance of disorder; and the riots were punished by quartering soldiers upon the inhabitants. The decision between the two races turned on the vote of the feudal proprietors, and in order to win this a society was formed among the German capitalists of Vienna (to which the name of *Chabrus* was popularly given) to acquire by real or fictitious purchase portions of those estates to which a vote was attached. These measures were successful; a large German majority was secured; Jews from Vienna sat in the place of the Thuns and the Schwarzenbergs; and as for many years the Czechs refused to sit in the diet, the government could be carried on without difficulty. A still greater blow to the Federalists was the passing of a new electoral law in 1873. The measure transferred the right of electing members of the Reichsrath from the diets to the direct vote of the people, the result being to deprive the Federalists of their chief weapon; it was no longer possible to take a formal vote of the legal representatives in any territory refusing to appoint deputies, and if a Czech or Slovene member did not take his seat the only result was that a single constituency was unrepresented, and the opposition weakened. The measure was strongly opposed. A petition with 250,000 names was presented from Bohemia; and the Poles withdrew from the Reichsrath when the law was introduced. But enough members remained to give the legal quorum, and it was carried by 120 to 2 votes. At the same time the number of members was increased to 353, but the proportion of representatives from the different territories was maintained and the system of election was not altered. The proportion of members assigned to the towns was increased, the special representatives of the chambers of commerce and of the landed proprietors were retained, and the suffrage was not extended. The artificial system which gave to the Germans a parliamentary majority continued.

At this time the Czechs were much weakened by quarrels among themselves. A new party had arisen, calling themselves Radicals, but generally known as the Young Czechs. They disliked the alliance with the aristocracy and the clergy; they wished for universal suffrage, and recalled the Hussite traditions. They desired to take their seats in the diet, and to join with the Germans in political reform. They violently attacked Rieger, the leader of the Old Czechs, who maintained the alliance with the Feudalists and the policy of passive opposition. Twenty-seven members of the diet led by Greg and Stadkowsky, being outvoted in the Czech Club, resigned their seats. They were completely defeated in the elections which followed, but for the next four years the two parties among the Czechs were as much occupied in opposing one another as in opposing the Germans. These events might have

secured the predominance of the Liberals for many years. The election after the reform bill gave them an increased majority in the Reichsrath. Forty-two Czechs who had won seats did not attend; forty-three Poles stood aloof from all party combination, giving their votes on each occasion as the interest of their country seemed to require; the real opposition was limited to forty Clericals and representatives of the other Slav races, who were collected on the Right under the leadership of Hohenwart. Against them were 227 Constitutionals, and it seemed to matter little that they were divided into three groups; there were 105 in the Liberal Club under the leadership of Herbst, 57 Constitutionals, elected by the landed proprietors, and a third body of Radicals, some of whom were more democratic than the old Constitutional party, while others laid more stress on nationality. They used their majority to carry a number of important laws regarding ecclesiastical affairs. Yet within four years the government was obliged to turn for support to the Federalists and Clericals, and the rule of the German Liberals was overthrown. Their influence was indirectly affected by the great commercial crisis of 1873. For some years there had been active speculations on the Stock Exchange; a great number of companies, chiefly banks and building societies, had been founded on a very insecure basis. The inevitable crisis began in 1872; it was postponed for a short time, and there was some hope that the Exhibition, fixed for 1873, would bring fresh prosperity; the hope was not, however, fulfilled, and the final crash, which occurred in May, brought with it the collapse of hundreds of undertakings. The loss fell almost entirely on those who had attempted to increase their wealth by speculative investment. Sound industrial concerns were little touched by it, but speculation had become so general that every class of society was affected, and in the investigation which followed it became apparent that some of the most distinguished members of the governing Liberal party, including at least two members of the government, were among those who had profited by the unsound finance. It appeared also that many of the leading newspapers of Vienna, by which the Liberal party was supported, had received money from financiers. For the next two years political interest was transferred from parliament to the law courts, in which financial scandals were exposed, and the reputations of some of the leading politicians were destroyed.¹

This was to bring about a reaction against the economic doctrines which had held the field for nearly twenty years; but the full effect of the change was not seen for some time. What ruined the government was the want of unity in the party, and their neglect to support a ministry which had been taken from their own ranks. In a country like Austria, in which a mistaken foreign policy or a serious quarrel with Hungary might bring about the disruption of the monarchy, parliamentary government was impossible unless the party which the government helped in internal matters were prepared to support it in foreign affairs and in the commercial policy bound up with the settlement with Hungary. This the constitutional parties did not do. During discussions on the economic arrangement with Hungary in 1877 a large number voted against the duties on coffee and petroleum, which were an essential part of the agreement; they demanded, moreover, that the treaty of Berlin should be laid before the House, and 112 members, led by Herbst, gave a vote hostile to some of its provisions, and in the Delegation refused the supplies necessary for the occupation of Bosnia. They doubtless were acting in accordance with their principles, but the situation was such that it would have been impossible to carry out their wishes; the only result was that the Austrian ministers and Andrassy had to turn for help to the Poles, who began to acquire the position of a government party, which they have kept since then. At the beginning of 1879 Auersperg's resignation, which had long been offered, was accepted. The constitutionalists remained

¹ See Wirth, *Geschichte der Handelskrisen* (Frankfurt, 1885); and an interesting article by Schaffer in the *Zeitschrift f. Staatswissenschaft* (Stuttgart, 1874).

**Auersperg's
ministry,
1871 to
1879.**

**Financial
crisis of
1873.**

**Fall of the
Liberal
ministry.**

in power; but in the reconstructed cabinet, though Stremayr was president, Count Taaffe, as minister of the interior, was the most important member.

Parliament was dissolved in the summer, and Taaffe, by private negotiations, first of all persuaded the Bohemian feudal proprietors to give the Feudalists, who had long been excluded, a certain number of seats; secondly, he succeeded where Potocki had failed, and came to an agreement with the Czechs; they had already, in 1878, taken their seats in the diet at Prague, and now gave up the policy of "passive resistance," and consented to take their seats also in the parliament at Vienna.

On entering the House they took the oath without reservation, but in the speech from the throne the emperor himself stated

that they had entered without prejudice to their convictions, and on the first day of the session Rieger read a formal reservation of right. The Liberals had also lost many seats, so that the House now had a completely different aspect; the constitutionalists were reduced to 91 Liberals and 54 Radicals; but the Right, under Hohenwart, had increased to 57, and there were 57 Poles and 54 Czechs. A combination of these three parties might govern against the constitutionalists. Taaffe, who now became first minister, tried first of all to govern by the help of the moderates of all parties, and he included representatives of nearly every party in his cabinet. But the Liberals again voted against the government on an important military bill, an offence almost as unpardonable in Austria as in Germany, and a great meeting of the party decided that they would not support the government. Taaffe, therefore, was obliged to turn for support to the Right. The German members of the government resigned, their place was taken by Clericals, Poles and Czechs, Smolka was elected president of the Lower House of the Reichsrath, and the German Liberals found themselves in a minority opposed by the "iron ring" of these three parties, and helpless in the parliament of their own creation. For fourteen years Taaffe succeeded in maintaining the position he had thus secured. He was not himself a party man; he had sat in a Liberal government; he had never assented to the principles of the Federalists, nor was he an adherent of the Clerical party. He continued to rule according to the constitution; his watchword was "unpolitical politics," and he brought in little contentious legislation. The great source of his strength was that he stood between the Right and a Liberal government. There was a large minority of constitutionalists; they might easily become a majority, and the Right were therefore obliged to support Taaffe in order to avert this. They continued to support him, even if they did not get from him all that they could have wished, and the Czechs acquiesced in a foreign policy with which they had little sympathy. Something, however, had to be done for them, and from time to time concessions had to be made to the Clericals and the Federalists.

The real desire of the Clericals was an alteration of the school law, by which the control of the schools should be restored to the Church and the period of compulsory education reduced. In this, however, the government did not meet them, and in 1882 the Clericals, under Prince Alfred v. Liechtenstein, separated from Hohenwart's party and founded their own club, so that they could act more freely. Both the new Clerical Club and the remainder of the Conservatives were much affected by the reaction against the doctrines of economic Liberalism. They began to adopt the principles of Christian Socialism expounded by Rudolf Mayer and Baron von Vogelfang, and the economic revolt against the influence of capital was with them joined to a half-religious attack upon the Jews. They represented that Austria was being governed by a close ring of political financiers, many of whom were Jews or in the pay of the Jews, who used the forms of the constitution, under which there was no representation of the working classes, to exploit the labour of the poor at the same time that they ruined the people by alienating them from Christianity in "godless schools." It was during these years that the foundation for the democratic clericalism of the future was laid. The chief

political leader in this new tendency was Prince Aloys v. Liechtenstein, who complained of the political influence exercised by the chambers of commerce, and demanded the organization of working men in guilds. It was by their influence that a law was introduced limiting the rate of interest, and they co-operated with the government in legislation for improving the material condition of the people, which had been neglected during the period of Liberal government, and which was partly similar to the laws introduced at the same time in Germany.

There seems no doubt that the condition of the workmen in the factories of Moravia and the oil-mines of Galicia was peculiarly unfortunate; the hours of work were very long, the conditions were very injurious to health, and there were no precautions against accidents. The report of a parliamentary inquiry, called for by the Christian Socialists, showed the necessity for interference. In 1883 a law was carried, introducing factory inspection, extending to mines and all industrial undertakings. The measure seems to have been successful, and there is a general agreement that the inspectors have done their work with skill and courage. In 1884 and 1885 important laws were passed regulating the work in mines and factories, and introducing a maximum working day of eleven hours in factories, and ten hours in mines. Sunday labour was forbidden, and the hours during which women and children could be employed were limited. Great power was given to the administrative authorities to relax the application of these laws in special cases and special trades. This power was at first freely used, but it was closely restricted by a further law of 1893. In 1887-1888 laws, modelled on the new German laws, introduced compulsory insurance against accidents and sickness. These measures, though severely criticized by the Opposition, were introduced to remedy obvious, and in some cases terrible social evils. Other laws to restore guilds among working men had a more direct political object. Another form of state socialism was the acquisition of railways by the state. Originally railways had been built by private enterprise, supported in some cases by a state guarantee; a law of 1877 permitted the acquisition of private lines; when Taaffe retired the state possessed nearly 5000 m. of railway, not including those which belonged to Austria and Hungary conjointly. In 1899 a minister of railways was appointed. In this policy military considerations as well as economic were of influence. In every department we find the same reaction against the doctrines of *laissez-faire*. In 1889 for the first time the Austrian budget showed a surplus, partly the result of the new import duties, partly due to a reform of taxation.

For a fuller description of these social reforms, see the *Jahrbuch für Gesetzgebung* (Leipzig, 1886, 1888 and 1894); also the annual summary of new laws in the *Zeitschrift für Staatswissenschaft* (Stuttgart). For the Christian Socialists, see Nitti, *Catholic Socialism* (London, 1895).

Meanwhile it was necessary for the government to do something for the Czechs and the other Slavs, on whose support they depended for their majority. The influence of the government became more favourable to them in the matter of language, and this caused the struggle of nationalities to assume the first place in Austrian public life—a place which it has ever since maintained. The question of language becomes a political one, so far as it concerns the use of different languages in the public offices and law courts, and in the schools. There never was any general law laying down clear and universal rules, but since the time of Joseph II. German had been the ordinary language of the government. All laws were published in German; German was the sole language used in the central public offices in Vienna, and the language of the court and of the army; moreover, in almost every part of the monarchy it had become the language of what is called the *internal service* in the public offices and law courts; all books and correspondence were kept in German, not only in the German districts, but also in countries such as Bohemia and Galicia. The bureaucracy and the law courts had therefore become a network of German-speaking officialism extending over the whole country; no one had any share in the government

Special legislation.

The language question.

Count Taaffe.

The Clericals.

unless he could speak and write German. The only exception was in the Italian districts; not only in Italy itself (in Lombardy, and afterwards in Venetia), but in South Tirol, Trieste, Istria and Dalmatia, Italian has always been used, even for the internal service of the government offices, and though the actual words of command are now given in German and the officers are obliged to know Serbo-Croatian it remains to this day the language of the Austrian navy. Any interference with the use of German would be a serious blow to the cause of those who hoped to Germanize the whole empire. Since 1867 the old rules have been maintained absolutely as regards the army, and German has also, as required by the military authorities, become the language of the railway administration. It remains the language of the central offices in Vienna, and is the usual, though not the only, language used in the Reichsrath. In 1869 a great innovation was made, when Polish was introduced throughout the whole of Galicia as the normal language of government; and since that time the use of German has almost entirely disappeared in that territory. Similar innovations have also begun, as we shall see, in other parts.

Different from this is what is called the *external service*. Even in the old days it was customary to use the language of the district in communication between the government offices and private individuals, and evidence could be given in the law courts in the language generally spoken. This was not the result of any law, but depended on administrative regulations of the government service; it was practically necessary in remote districts, such as Galicia and Bukovina, where few of the population understood German. In some places a Slav-speaking individual would himself have to provide the interpreter, and approach the government in German. Local authorities, e.g. town councils and the diets, were free to use what language they wished, and in this matter the Austrian government has shown great liberality. The constitution of 1867 laid down a principle of much importance, by which previous custom became established as a right. Article 19 runs: "All races of the empire have equal rights, and every race has an inviolable right to the preservation and use of its own nationality and language. The equality of all customary (*landesüblich*) languages in school, office and public life, is recognized by the state. In those territories in which several races dwell, the public and educational institutions are to be so arranged that, without applying compulsion to learn a second *Landessprache*, each of the races receives the necessary means of education in its own language." The application of this law gives great power to the government, for everything depends on what is meant by *landesüblich*, and it rests with them to determine when a language is customary. The Germans demand the recognition of German as a customary language in every part of the empire, so that a German may claim to have his business attended to in his own language, even in Dalmatia and Galicia. In Bohemia the Czechs claim that their language shall be recognized as customary, even in those districts such as Reichenberg, which are almost completely German; the Germans, on the other hand, claim that the Czech language shall only be recognized in those towns and districts where there is a considerable Czech population. What Taaffe's Administration did was to interpret this law in a sense more favourable to the Slavs than had hitherto been the case.

Particular importance is attached to the question of education. The law of 1867 required that the education in the elementary schools in the Slav districts should be given in Czech or Slovenian, as the case might be. The Slavs, however, required that, even when a small minority of Slav race settled in any town, they should not be compelled to go to the German schools, but should have their own school provided for them; and this demand was granted by Prazak, minister of education under Count Taaffe. The Germans had always hoped that the people as they became educated would cease to use their own particular language. Owing to economic causes the Slavs, who increase more rapidly than the Germans, tend to move westwards, and large numbers settle in the towns and manufacturing districts. It might have been expected that they would then cease to use

their own language and become Germanized; but, on the contrary, the movement of population is spreading their language and they claim that special schools should be provided for them, and that men of their own nationality should be appointed to government offices to deal with their business. This has happened not only in many places in Bohemia, but in Styria, and even in Vienna, where there has been a great increase in the Czech population and a Czech school has been founded. The introduction of Slavonic into the middle and higher schools has affected the Germans in their most sensitive point. They have always insisted that German is the *Kultur-sprache*. On one occasion Count A. Auersperg (Anastasius Grün) entered the diet of Carniola carrying the whole of the Slovenian literature under his arm, as evidence that the Slovenian language could not well be substituted for German as a medium of higher education.

The first important regulations which were issued under the law of 1867 applied to Dalmatia, and for that country between 1872 and 1876 a series of laws and edicts were issued determining to what extent the Slavonic idioms were to be recognized. Hitherto all business had been done in Italian, the language of a small minority living in the seaport towns. The effect of these laws has been to raise Croatian to equality with Italian. It has been introduced in all schools, so that nearly all education is given in Croatian, even though a knowledge of Italian is quite essential for the maritime population; and it is only in one or two towns, such as Zara, the ancient capital of the country, that Italian is able to maintain itself. Since 1882 there has been a Slav majority in the diet, and Italian has been disused in the proceedings of that body. In this case the concessions to the Servo-Croatians had been made by the Liberal ministry; they required the parliamentary support of the Dalmatian representatives, who were more numerous than the Italian, and it was also necessary to cultivate the loyalty of the Slav races in this part so as to gain a support for Austria against the Russian party, which was very active in the Balkan Peninsula. It was better to sacrifice the Italians of Dalmatia than the Germans of Carinthia.¹

It was not till 1870 that the Slovenes received the support of the government. In Carniola they succeeded, in 1882, in winning a majority in the diet, and from this time, while the diet of Styria is the centre of the German, that of Carniola is the chief support of the Slovene agitation. In the same year they won the majority in the town council of Laibach, which had hitherto been German. They were able, therefore, to introduce Illyrian as the official language, and cause the names of the streets to be written up in Illyrian. This question of street names is, as it were, a sign of victory. Serious riots broke out in some of the towns of Istria when, for the first time, Illyrian was used for this purpose as well as Italian. In Prague the victory of the Czechs has been marked by the removal of all German street names, and the Czech town council even passed a by-law forbidding private individuals to have tablets put up with the name of the street in German. In consequence of a motion by the Slovene members of the Reichsrath and a resolution of the diet of Carniola, the government also declared Slovenian to be a recognized language for the whole of Carniola, for the district of Cilli in Styria, and for the Slovene and mixed districts in the south of Carinthia, and determined that in Laibach a Slovene gymnasium should be maintained as well as the German one.

The Germans complain that in many cases the government acted very unfairly to them. They constantly refer to the case of Klagenfurt. This town in Carinthia had a population of 16,491 German-speaking Austrians; the Slovenian-speaking population numbered 568, of whom 180 were inhabitants of the gaol or the hospital. The government, however, in 1880 declared Slovenian a customary language, so that provision had to be made in public offices and law courts for dealing with business in Slovenian. It must be remembered, however, that even though the town was German, the rural population of the surrounding villages was chiefly Slovene.

It was in Bohemia and Moravia that the contest was fought out with the greatest vehemence. The two races were nearly equal, and the victory of Czech would mean that nearly two

¹ For Dalmatia, see T. G. Jackson, *Dalmatia, &c.* (Oxford, 1886).

million Germans would be placed in a position of subordination; but for the last twenty years there had been a constant encroachment by Czech on German. This was partly due to the direct action of the government. An ordinance of 1880 determined that henceforward all business which had been brought before any government office or law court should be dealt with, within the office, in the language in which it was introduced; this applied to the whole of Bohemia and Moravia, and meant that Czech would henceforward have a position within the government service. It was another step in the same direction when, in 1886, it was ordered that "to avoid frequent translations" business introduced in Czech should be dealt with in the same language in the high courts of Prague and Brünn. Then not only were a large number of Czech elementary schools founded, but also many middle schools were given to the Czechs, and Czech classes introduced in German schools; and, what affected the Germans most, in 1882 classes in Czech were started in the university of Prague—a desecration, as it seemed, of the oldest German university.

The growth of the Slav races was, however, not merely the result of government assistance; it had begun long before Taaffe assumed office; it was to be seen in the census returns and in the results of elections. Prague was no longer the German city it had been fifty years before; the census of 1880 showed 36,000 Germans to 120,000 Czechs. It was the same in Pilsen. In 1861 the Germans had a majority in this town; in 1880 they were not a quarter of the population. This same phenomenon, which occurs elsewhere, cannot be attributed to any laxity of the Germans. The generation which was so vigorously demanding national rights had themselves all been brought up under the old system in German schools, but this had not implanted in them a desire to become German. It was partly due to economic causes—the greater increase among the Czechs, and the greater migration from the country to the towns; partly the result of the romantic and nationalist movement which had arisen about 1830, and partly the result of establishing popular education and parliamentary government at the same time. As soon as these races which had so long been ruled by the Germans received political liberty and the means of education, they naturally used both to reassert their national individuality.

It may be suggested that the resistance to the German language is to some extent a result of the increased national feeling among the Germans themselves. They have made it a matter of principle. In the old days it was common for the children of German parents in Bohemia to learn Czech; since 1867 this has ceased to be the case. It may almost be said that they make it a point of honour not to do so. A result of this is that, as educated Czechs are generally bilingual, it is easier for them to obtain appointments in districts where a knowledge of Czech is required, and the Germans, therefore, regard every order requiring the use of Czech as an order which excludes Germans from a certain number of posts. This attitude of hostility and contempt is strongest among the educated middle class; it is not shown to the same extent by the clergy and the nobles.

The influence of the Church is also favourable to the Slav races, not so much from principle as owing to the fact that they supply more candidates for ordination than the Germans. There is no doubt, however, that the tendency among Germans has been to exalt the principle of nationality above religion, and to give it an absolute authority in which the Roman Catholic Church cannot acquiesce. In this, as in other ways, the Germans in Austria have been much influenced by the course of events in the German empire. This hostility of the Church to the German nationalist movement led in 1898 to an agitation against the Roman Catholic Church, and among the Germans of Styria and other territories large numbers left the church, going over either to Protestantism or to Old Catholicism. This "Los von Rom" movement, which was caused by the continued alliance of the Clerical party with the Slav parties, is more of the nature of a political demonstration than of a religious movement.

The Germans, so long accustomed to rule, now saw their old ascendancy threatened, and they defended it with an energy that increased with each defeat. In 1880 they founded a great society, the *Deutscher Schutzbund*, to establish and assist German schools. It spread over the whole of the empire; in a few years it numbered 100,000 members, and had an income of nearly 300,000 gulden; no private society in Austria

had ever attained so great a success. In the Reichsrath a motion was introduced, supported by all the German Liberal parties, demanding that German should be declared the language of state and regulating the conditions under which the other idioms could be recognized; it was referred to a committee from which it never emerged, and a bill to the same effect, introduced in 1886, met a similar fate. In Bohemia they demanded, as a means of protecting themselves against the effect of the language ordinances, that the country should be divided into two parts; in one German was to be the sole language, in the other Czech was to be recognized. A proposal to this effect was introduced by them in the diet at the end of 1886, but since 1882 the Germans had been in a minority. The Czechs, of course, refused even to consider it; it would have cut away the ground on which their whole policy was built up, namely, the indissoluble unity of the Bohemian kingdom, in which German and Czech should throughout be recognized as equal and parallel languages. It was rejected on a motion of Prince Karl Schwarzenberg without discussion, and on this all the Germans rose and left the diet, thereby imitating the action of the Czechs in old days when they had the majority.

These events produced a great change on the character of the German opposition. It became more and more avowedly racial; the defence of German nationality was put in the front of their programme. The growing national animosity added bitterness to political life, and destroyed the possibility of a strong homogeneous party on which a government might depend. The beginning of this movement can be traced back to the year 1870. About that time a party of young Germans had arisen who professed to care little for constitutionalism and other "legal mummies," but made the preservation and extension of their own nationality their sole object. As is so often the case in Austria, the movement began in the university of Vienna, where a *Leseverein* (reading club) of German students was formed as a point of cohesion for Germans, which had eventually to be suppressed. The first representative of the movement in parliament was Herr von Schönerer, who did not scruple to declare that the Germans looked forward to union with the German empire. They were strongly influenced by men outside Austria. Bismarck was their national hero, the anniversary of Sedan their political festival, and approximation to Germany was dearer to them than the maintenance of Austria. After 1878 a heightening of racial feeling began among the Radicals, and in 1881 all the German parties in opposition joined together in a club called the United Left, and in their programme put in a prominent place the defence of the position of the Germans as the condition for the existence of the state, and demanded that German should be expressly recognized as the official language. The younger and more ardent spirits, however, found it difficult to work in harmony with the older constitutional leaders. They complained that the party leaders were not sufficiently decisive in the measures for self-defence. In 1885 great festivities in honour of Bismarck's eightieth birthday, which had been arranged 'in Graz, were forbidden by the government, and the Germans of Styria were very indignant that the party did not take up the matter with sufficient energy. After the elections of 1885 the Left, therefore, broke up again into two clubs, the "German Austrian," which included the more moderate, and the "German," which wished to use sharper language. The German Club, e.g., congratulated Bismarck on his measures against the Poles; the German Austrians refused to take cognizance of events outside Austria with which they had nothing to do. Even the German Club was not sufficiently decided for Herr von Schönerer and his friends, who broke off from it and founded a "National German Union." They spoke much of *Germanentum* and *Unerfälschtes Deutschum*, and they advocated a political union with the German empire, and were strongly anti-Hungarian and wished to resign all control over Galicia, if by a closer union with Germany they could secure German supremacy in Bohemia and the south Slav countries. They play the same part in Austria as does the "pan-Germanic Union" in Germany. When in 1888 the

New
German
parties.

two clubs, the German Austrians and the Germans, joined once more under the name of the "United German Left" into a new club with eighty-seven members, so as the better to guard against the common danger and to defeat the educational demands of the Clericals, the National Germans remained apart with seventeen members. They were also infected by the growing spirit of anti-Semitism. The German parties had originally been the party of the capitalists, and comprised a large number of Jews; this new German party committed itself to violent attacks upon the Jews, and for this reason alone any real harmony between the different branches would have been impossible.

Notwithstanding the concessions about language the Czechs had, however, made no advance towards their real object—the recognition of the Bohemian kingdom. Perhaps the leaders of the party, who were now growing old, would have been content with the influence they had already attained, but they were hard pressed at home by the Young Czechs, who were more impatient. When Count Thun was appointed governor of Bohemia their hopes ran high, for he was supposed to favour the coronation of the emperor at Prague. In 1890, however, instead of proceeding to the coronation as was expected, Taaffe attempted to bring about a reconciliation between the opposing parties. The influence by which his policy was directed is not quite clear, but the Czechs had been of recent years less easy to deal with, and Taaffe had never really shown any wish to alter the constitution; his policy always was to destroy the influence of parliament by playing off one party against the other, and so to win a clear field for the government. During the month of January conferences were held at Vienna, with Taaffe in the chair, to which were invited representatives of the three groups into which the Bohemian representatives were divided, the German party, the Czechs, and the Feudal party. After a fortnight's discussion an agreement was made on the basis of a separation between the German and the Czech districts, and a revision of the electoral law. A protocol enumerating the points agreed on was signed by all who had taken part in the conference, and in May bills were laid before the diet incorporating the chief points in the agreement. But they were not carried; the chief reason being that the Young Czechs had not been asked to take part in the conference, and did not consider themselves bound by its decisions; they opposed the measures and had recourse to obstruction, and a certain number of the Old Czechs gradually came over to them. Their chief ground of criticizing the proposed measures was that they would threaten the unity of the Bohemian country.¹ At the elections in 1891 a great struggle took place between the Old and the Young Czechs. The latter were completely victorious; Rieger, who had led the party for thirty years, disappeared from the Reichsrath. The first result was that the proposed agreement with Bohemia came to an end. But the disappearance of the Old Czechs made the parliamentary situation very insecure. The Young Czechs could not take their place; their Radical and anti-clerical tendencies alarmed the Feudalists and Clericalists who formed so large a part of the Right; they attacked the alliance with Germany; they made public demonstration of their French sympathies; they entered into communication with other Slav races, especially the Serbs of Hungary and Bosnia; they demanded universal suffrage, and occasionally supported the German Radicals in their opposition to the Clerical parties, especially in educational matters; under their influence disorder increased in Bohemia, a secret society called the *Umladina* (an imitation of the Servian society of that name) was discovered, and stringent measures had to be taken to preserve order. The government therefore veered round towards the German Liberals; some of the ministers most obnoxious to the Germans resigned, and their places were taken by Germans. For two years the government seemed to waver, looking now to the Left, now to Hohenwart and his friends; for a time Taaffe really had the support of all parties except the Young Czechs.

¹ On this see Menger, *Der Ausgleich mit Böhmen* (Vienna, 1891), where the documents are printed.

After two years he gave up his cautious policy and took a bold move. In October 1893 he introduced a reform bill. Universal suffrage had long been demanded by the working men and the Socialists; the Young Czechs also had put it on their programme, and many of the Christian Socialists and anti-Semites desired an alteration of the franchise. Taaffe's bill, while keeping the *curiae* of the feudal proprietors and the chambers of commerce as they were, and making no change in the number of members, proposed to give the franchise in both towns and rural districts to every one who could read and write, and had resided six months in one place. This was opposed by the Liberals, for with the growth of socialism and anti-Semitism, they knew that the extension of the franchise would destroy their influence. On this Taaffe had probably calculated, but he had omitted to inquire what the other parties would do. He had not even consulted Hohenwart, to whose assistance he owed his long tenure of power. Not even the pleasure of ruining the Liberals was sufficient to persuade the Conservatives to vote for a measure which would transfer the power from the well-to-do to the indigent, and Hohenwart justly complained that they ought to have been secure against surprises of this kind. The Poles also were against a measure which would give more influence to the Ruthenes. The position of the government was hopeless, and without waiting for a division Taaffe resigned.

The event to which for fourteen years the Left had looked forward had now happened. Once more they could have a share in the government, which they always believed belonged to them by nature. Taught by experience and adversity, they did not scruple to enter into an alliance with their old enemies, and a coalition ministry was formed from the Left, the Clericals and the Poles. The president was Prince Alfred Windisch-Grätz, grandson of the celebrated general, one of Hohenwart's ablest lieutenants; Hohenwart himself did not take office. Of course an administration of this kind could not take a definite line on any controversial question, but during 1894 they carried through the commercial treaty with Russia and the laws for the continuance of the currency reform. The differences of the clubs appeared, however, in the discussions on franchise reform; the government, not strong enough to have a policy of its own, had referred the matter to a committee; for the question having once been raised, it was impossible not to go on with it. This would probably have been fatal to the coalition, but the final blow was given by a matter of very small importance arising from the disputes on nationality. The Slovenes had asked that in the gymnasium at Cilli classes in which instruction was given in Slovenian should be formed parallel to the German classes. This request caused great excitement in Styria and the neighbouring districts; the Styrian diet (from which the Slovene minority had seceded) protested. The Slovenes were, however, members of the Hohenwart Club, so Hohenwart and his followers supported the request, which was adopted by the ministry. The German Left opposed it; they were compelled to do so by the popular indignation in the German districts; and when the vote was carried against them (12th June 1895) they made it a question of confidence, and formally withdrew their support from the government, which therefore at once resigned.

After a short interval the emperor appointed as minister-president Count Badeni, who had earned a great reputation as governor of Galicia. He formed an administration the merit of which, as of so many others, was that it was to belong to no party and to have no programme. He hoped to be able to work in harmony with the moderate elements of the Left; his mission was to carry through the composition (*Ausgleich*) with Hungary; to this everything else must be subordinated. During 1896 he succeeded in carrying a franchise reform bill, which satisfied nearly all parties. All the old categories of members were maintained, but a fifth *curia* was added, in which almost any one might vote who had resided six months in one place and was not in domestic service; in this way seventy-two would be added to the existing members. This matter having been

Electoral reform.

The coalition ministry, 1893.

Badeni's ministry.

settled, parliament was dissolved. The result of the elections of 1897 was the return of a House so constituted as to make any strong government impossible. On both sides the anti-Semitic parties representing the extreme demagogic elements were present in considerable numbers. The United German Left had almost disappeared; it was represented only by a few members chosen by the great proprietors; in its place there were the three parties—the German Popular party, the German Nationalists, and the German Radicals—who all put questions of nationality first and had deserted the old standpoint of the constitution. Then there were the fourteen Social Democrats who had won their seats under the new franchise. The old party of the Right was, however, also broken up; side by side with forty-one Clericals there were twenty-eight Christian Socialists led by Dr Lueger, a man of great oratorical power, who had won a predominant influence in Vienna, so long the centre of Liberalism, and had quite eclipsed the more modest efforts of Prince Liechtenstein. As among the German National party, there were strong nationalist elements in his programme, but they were chiefly directed against Jews and Hungarians; Lueger had already distinguished himself by his violent attacks on Hungary, which had caused some embarrassment to the government at a time when the negotiations for the *Ausgleich* were in progress. Like anti-Semites elsewhere, the Christian Socialists were reckless and irresponsible, appealing directly to the passions and prejudices of the most ignorant. There were altogether 200 German members of the Reichsrath, but they were divided into eight parties, and nowhere did there seem to be the elements on which a government could be built up.

The parliamentary situation is best explained by the following table showing the parties:—

<i>German Liberals—</i>	1897.	1901.
Constitutional Landed Proprietors	28	28
German Radicals	49	41
German Popular Party	42	51
Schoenerer Group	5	21
Kronawetter	1	..
Democrat	1	..
	— 126	— 141
<i>Social Democrats</i>	14	10
<i>German Conservatives—</i>		37
German Clericals	30	}
Catholic Popular Party	15	
Christian Socialists	28	23
	— 73	— 60
<i>Federalist Great Proprietors</i>	16	16
<i>Czechs—</i>		
Young Czechs	60	53
Radical Young Czechs	1	4
Clerical Czechs	1	2
Agrarian Czechs	1	6
	— 63	— 65
<i>Poles—</i>		
Polish Club	59	60
Stoyalowski Group	6	..
Popul Polish Party	3	11
	— 68	— 71
<i>Slovenes—</i>		
Clerical Slovenes	11	..
Radical "	5	..
	— 16	— 16
<i>Italians—</i>		
Liberal Italians	14	..
Clerical "	5	..
	— 19	— 19
<i>Croatians</i>	11	9
<i>Serbs</i>	2	2
<i>Ruthenes—</i>		
Ruthenes	6	..
Young Ruthenes	5	..
	— 11	— 11
<i>Rumanians—</i>		
Rumanians	5	..
Young Rumanians	1	..
	— 6	— 5
Total	425	425

The most remarkable result of the elections was the disappearance of the Liberals in Vienna. In 1879, out of 37 members returned in Lower Austria, 33 were Liberals, but now they were

replaced to a large extent by the Socialists. It was impossible to maintain a strong party of moderate constitutionalists, on whom the government could depend, unless there was a large nucleus from Lower Austria. The influence of Lueger was very embarrassing; he had now a majority of two-thirds in the town council, and had been elected burgomaster. The emperor had refused to confirm the election; he had been re-elected, and then the emperor, in a personal interview, appealed to him to withdraw. He consented to do so; but, after the election of 1897 had given him so many followers in the Reichsrath, Badeni advised that his election as burgomaster should be confirmed. There was violent antipathy between the Christian Socialists and the German Nationalists, and the transference of their quarrels from the Viennese Council Chamber to the Reichsrath was very detrimental to the orderly conduct of debate.

The limited suffrage had hitherto prevented socialism from becoming a political force in Austria as it had in Germany, and the national divisions have always impeded the *Socialism*. creation of a centralized socialist party. The first object of the working classes necessarily was the attainment of political power; in 1867 there had been mass demonstrations and petitions to the government for universal suffrage. During the next years there was the beginning of a real socialist movement in Vienna and in Styria, where there is a considerable industrial population; after 1870, however, the growth of the party was interrupted by the introduction of anarchical doctrines. Most's paper, the *Freiheit*, was introduced through Switzerland, and had a large circulation. The anarchists, under the leadership of Peukert, seem to have attained considerable numbers. In 1883-1884 there were a number of serious strikes, collisions between the police and the workmen, followed by assassinations; it was a peculiarity of Austrian anarchists that in some cases they united robbery to murder. The government, which was seriously alarmed, introduced severe repressive measures; the leading anarchists were expelled or fled the country. In 1887, under the leadership of Dr Adler, the socialist party began to revive (the party of violence having died away), and since then it has steadily gained in numbers; in the forefront of the political programme is put the demand for universal suffrage. In no country is the 1st of May, as the festival of Labour, celebrated so generally.

Badeni after the election sent in his resignation, but the emperor refused to accept it, and he had, therefore, to do the best he could and turn for support to the other nationalities. The strongest of them were the fifty-nine Poles and sixty Young Czechs; he therefore attempted, as Taaffe had done, to come to some agreement with them. The Poles were always ready to support the government; among the Young Czechs the more moderate had already attempted to restrain the wilder spirits of the party, and they were quite prepared to enter into negotiations. They did not wish to lose the opportunity which now was open to them of winning influence over the administration. What they required was further concession as to the language in Bohemia. In May 1897 Badeni, therefore, published his celebrated *ordinances*. They determined (1) that all correspondence and documents regarding every matter *The* brought before the government officials should be *language ordinances of 1897* conducted in the language in which it was first introduced. This applied to the whole of Bohemia, and meant the introduction of Czech into the government offices throughout the whole of the kingdom; (2) after 1903 no one was to be appointed to a post under the government in Bohemia until he had passed an examination in Czech. These ordinances fulfilled the worst fears of the Germans. The German Nationalists and Radicals declared that no business should be done till they were repealed and Badeni dismissed. They resorted to obstruction. They brought in repeated motions to impeach the ministers, and parliament had to be prorogued in June, although no business of any kind had been transacted. Badeni had not anticipated the effect his ordinances would have; as a Pole he had little experience in the western part of the empire. During the recess he tried to open negotiations, but

the Germans refused even to enter into a discussion until the ordinances had been withdrawn. The agitation spread throughout the country; great meetings were held at Eger and Aussig, which were attended by Germans from across the frontier, and led to serious disturbances; the cornflower, which had become the symbol of German nationality and union with Germany, was freely worn, and the language used was in many cases reasonable. The emperor insisted that the Reichsrath should again be summoned to pass the necessary measures for the agreement with Hungary; scenes then took place which have no parallel in parliamentary history. To meet the obstruction it was determined to sit at night, but this was unsuccessful. On one occasion Dr Lecher, one of the representatives of Moravia, spoke for twelve hours, from 9 P.M. till 9 A.M., against the Ausgleich. The opposition was not always limited to feats of endurance of this kind. On the 3rd of November there was a free fight in the House; it arose from a quarrel between Dr Lueger and the Christian Socialists on the one side (for the Christian Socialists had supported the government since the confirmation of Lueger as burgomaster) and the German Nationalists under Herr Wolf, a German from Bohemia, the violence of whose language had already caused Badeni to challenge him to a duel. The Nationalists refused to allow Lueger to speak, clapping their desks, hissing and making other noises, till at last the Young Czechs attempted to prevent the disorder by violence. On the 24th of November the scenes of disturbance were renewed. The president, Herr v. Abrahamovitch, an Armenian from Galicia, refused to call on Schönerer to speak. The Nationalists therefore stormed the platform, and the president and ministers had to fly into their private rooms to escape personal violence, until the Czechs came to their rescue, and by superiority in numbers and physical strength severely punished Herr Wolf and his friends. The rules of the House giving the president no authority for maintaining order, he determined, with the assent of the ministers, to propose alterations in procedure. The next day, when the sitting began, one of the ministers, Count Falkenhayn, a Clerical who was very unpopular, moved "That any member who continued to disturb a sitting after being twice called to order could be suspended—for three days by the president, and for thirty days by the House." The din and uproar was such that not a word could be heard, but at a pre-arranged signal from the president all the Right rose, and he then declared that the new order had been carried, although the procedure of the House required that it should be submitted to a committee. The next day, at the beginning of the sitting, the Socialists rushed on the platform, tore up and destroyed all the papers lying there, seized the president, and held him against the wall. After he had escaped, eighty police were introduced into the House and carried out the fourteen Socialists. The next day Herr Wolf was treated in the same manner. The excitement spread to the street. Serious disorders took place in Vienna and in Graz; the German opposition had the support of the people, and Lueger warned the ministers that as burgomaster he would be unable to maintain order in Vienna; even the Clerical Germans showed signs of deserting the government. The emperor, hastily summoned to Vienna, accepted Badeni's resignation, the Germans having thus by obstruction attained part of their wishes. The new minister, Gautsch, a man popular with all parties, held office for three months; he proclaimed the budget and the Ausgleich, and in February replaced the language ordinances by others, under which Bohemia was to be divided into three districts—one Czech, one German and one mixed. The Germans, however, were not satisfied with this; they demanded absolute repeal. The Czechs also were offended; they arranged riots at Prague; the professors in the university refused to lecture unless the German students were defended from violence; Gautsch resigned, and Thun, who had been governor of Bohemia, was appointed minister. Martial law was proclaimed in Bohemia, and strictly enforced. Thun then arranged with the Hungarian ministers a compromise about the Ausgleich.

Badeni resigns.

less disturbed than in the former year, but the Germans still prevented any business from being done. The Germans now had a new cause of complaint. Paragraph 14 of the Constitutional law of 1867 provided that, in cases of pressing necessity, orders for which the assent of the Reichsrath was required might, if the Reichsrath were not in session, be proclaimed by the emperor; they had to be signed by the whole ministry, and if they were not laid before the Reichsrath within four months of its meeting, or if they did not receive the approval of both Houses, they ceased to be valid. The Germans contended that the application of this clause to the Ausgleich was invalid, and demanded that it should be repealed. Thun had in consequence to retire, in September 1899. His successor, Count Clary, began by withdrawing the ordinances which had been the cause of so much trouble, but it was now too late to restore peace. The Germans were not sufficiently strong and united to keep in power a minister who had brought them the relief for which they had been clamouring for two years. The Czechs, of course, went into opposition, and used obstruction. The extreme German party, however, took the occasion to demand that paragraph 14 should be repealed. Clary explained that this was impossible, but he gave a formal pledge that he would not use it. The Czechs, however, prevented him passing a law on excise which was a necessary part of the agreements with Hungary; it was, therefore, impossible for him to carry on the government without breaking his word; there was nothing left for him to do but to resign, after holding office for less than three months. The emperor then appointed a ministry of officials, who were not bound by his pledge, and used paragraph 14 for the necessary purposes of state. They then made way for a ministry under Herr v. Körber. During the early months of 1900 matters were more peaceful, and Körber hoped to be able to arrange a compromise; but the Czechs now demanded the restoration of their language in the internal service of Bohemia, and on 8th June, by noise and disturbance, obliged the president to suspend the sitting. The Reichsrath was immediately dissolved, the emperor having determined to make a final attempt to get together a parliament with which it would be possible to govern. The new elections on which so much was to depend did not take place till January 1901. They resulted in a great increase of the extreme German Nationalist parties. Schönerer and the German Radicals—the fanatical German party who in their new programme advocated union of German Austria with the German empire—now numbered twenty-one, who chiefly came from Bohemia. They were able for the first time to procure the election of one of their party in the Austrian Delegation, and threatened to introduce into the Assembly scenes of disorder similar to those which they had made common in the Reichsrath. All those parties which did not primarily appeal to national feeling suffered loss; especially was this the case with the two sections of the Clericals, the Christian Socialists and the Ultramontanes; and the increasing enmity between the German Nationalists (who refused even the name German to a Roman Catholic) and the Church became one of the most conspicuous features in the political situation. The loss of seats by the Socialists showed that even among the working men the national agitation was gaining ground; the diminished influence of the anti-Semites was the most encouraging sign.

Notwithstanding the result of the elections, the first months of the new parliament passed in comparative peace. There was a truce between the nationalities. The Germans were more occupied with their opposition to the Clericals than with their feud with the Slavs. The Czechs refrained from obstruction, for they did not wish to forfeit the alliance with the Poles and Conservatives, on which their parliamentary strength depended, and the Germans used the opportunity to pass measures for promoting the material prosperity of the country, especially for an important system of canals which would bring additional prosperity to the coal-fields and manufactures of Bohemia. (J. W. H.E.)

Renewed conflict between Germans and Czechs.

The history of Austria since the general election of 1901 is thus

history of franchise reform as a crowning attempt to restore parliament to normal working conditions. The premier, Dr von Körber, who had undertaken to overcome obstruction and who hoped to effect a compromise between Germans and Czechs, induced the Chamber to sanction the estimates, the contingent of recruits and other "necessities of state" for 1901 and 1902, by promising to undertake large public works in which Czechs and Germans were alike interested. These public works were chiefly a canal from the Danube to the Oder; a ship canal from the Danube to the Moldau near Budweis, and the canalization of the Moldau from Budweis to Prague; a ship canal running from the projected Danube-Oder canal near Prerau to the Elbe near Pardubitz, and the canalization of the Elbe from Pardubitz to Melnik; a navigable connexion between the Danube-Oder Canal and the Vistula and the Dniester. It was estimated that the construction of these four canals would require twenty years, the funds being furnished by a 4% loan amortizable in ninety years. In addition to the canals, the cabinet proposed and the Chamber sanctioned the construction of a "second railway route to Trieste" designed to shorten the distance between South Germany, Salzburg and the Adriatic, by means of a line passing under the Alpine ranges of central and southern Austria. The principal sections of this line were named after the ranges they pierced, the chief tunnels being bored through the Tauern, Karawanken and Wochein hills. Sections were to be thrown open to traffic as soon as completed and the whole work to be ended during 1909. The line forms one of the most interesting railway routes in Europe. The cost, however, greatly exceeded the estimate sanctioned by parliament; and the contention that the parliamentary adoption of the Budget in 1901-1902 cost the state £100,000,000 for public works, is not entirely unfounded. True, these works were in most cases desirable and in some cases necessary, but they were hastily promised and often hastily begun under pressure of political expediency. The Körber administration was for this reason subsequently exposed to severe censure.

Despite these public works Dr von Körber found himself unable to induce parliament to vote the Budgets for 1903, 1904 or 1905, and was obliged to revert to the expedient employed by his predecessors of sanctioning the estimates by imperial ordinance under paragraph 14 of the constitution. His attempts in December 1902 and January 1903 to promote a compromise between Czechs and Germans proved equally futile. Körber proposed that Bohemia be divided into 10 districts, of which 5 would be Czech, 3 German and 2 mixed. Of the 234 district tribunals, 133 were to be Czech, 94 German and 7 mixed. The Czechs demanded on the contrary that both their language and German should be placed on an equal footing throughout Bohemia, and be used for all official purposes in the same way. As this demand involved the recognition of Czech as a language of internal service in Bohemia it was refused by the Germans. Thenceforward, until his fall on the 31st of December 1904, Körber governed practically without parliament. The Chamber was summoned at intervals rather as a pretext for the subsequent employment of paragraph 14 than in the hope of securing its assent to legislative measures. The Czechs blocked business by a pile of "urgency motions" and occasionally indulged in noisy obstruction. On one occasion a sitting lasted 57 hours without interruption. In consequence of Czech aggressiveness, the German parties (the German Progressists, the German Populists, the Constitutional Landed Proprietors and the Christian Socialists) created a joint executive committee and a supreme committee of four members to watch over German racial interests.

By the end of 1904 it had become clear that the system of government by paragraph 14, which Dr von Körber had perfected was not effective in the long run. Loans were needed for military and other purposes, and paragraph 14 itself declares that it cannot be employed for the contraction of any lasting burden upon the exchequer, nor for any sale of state patrimony. As the person of the premier

had become so obnoxious to the Czechs that his removal would be regarded by them as a concession, his resignation was suddenly accepted by the emperor, and, on the 1st of January 1905, a former premier, Baron von Gautsch, was appointed in his stead. Parliamentary activity was at once resumed; the Austro-Hungarian tariff contained in the Széll-Körber compact was adopted, the estimates were discussed and the commercial treaty with Germany ratified. In the early autumn, however, a radical change came over the spirit of Austrian politics. For nearly three years Austria had been watching with bitterness and depression the course of the crisis in Hungary. Parliament had repeatedly expressed its disapproval of the Magyar demands upon the crown, but had succeeded only in demonstrating its own impotence. The feeling that Austria could be compelled by imperial ordinance under paragraph 14 to acquiesce in whatever concessions the crown might make to Hungary galled Austrian public opinion and prepared it for coming changes. In August 1905 the crown took into consideration and in September sanctioned the proposal that universal suffrage be introduced into the official programme of the Fejérváry cabinet then engaged in combating the Coalition in Hungary. It is not to be supposed that the king of Hungary assented to this programme without reflecting that what he sought to further in Hungary, it would be impossible for him, as emperor of Austria, to oppose in Cisleithania. His subsequent action justifies, indeed, the belief that, when sanctioning the Fejérváry programme, the monarch had already decided that universal suffrage should be introduced in Austria; but even he can scarcely have been prepared for the rapidity with which the movement in Austria gained ground and accomplished its object.

On the 15th of September 1905 a huge socialist and working-class demonstration in favour of universal suffrage took place before the parliament at Budapest. The Austrian Socialist party, encouraged by this manifestation and influenced by the revolutionary movement in Russia, resolved to press for franchise reform in Austria also. An initial demonstration, resulting in some bloodshed, was organized in Vienna at the beginning of November. At Prague, Graz and other towns, demonstrations and collisions with the police were frequent. The premier, Baron Gautsch, who had previously discountenanced universal suffrage while admitting the desirability of a restricted reform, then changed attitude and permitted an enormous Socialist demonstration, in support of universal suffrage, to take place (November 28) in the Vienna Ringstrasse. Traffic was suspended for five hours while an orderly procession of workmen, ten abreast, marched silently along the Ringstrasse past the houses of parliament. The demonstration made a deep impression upon public opinion. On the same day the premier promised to introduce by February a large measure of franchise reform so framed as to protect racial minorities from being overwhelmed at the polls by majorities of other races. On the 23rd of February 1906 he indeed brought in a series of franchise reform measures. Their main principles were the abolition of the *curia* or electoral class system and the establishment of the franchise on the basis of universal suffrage; and the division of Austria electorally into racial compartments within which each race would be assured against molestation from other races. The Gautsch redistribution bill proposed to increase the number of constituencies from 425 to 455, to allot a fixed number of constituencies to each province and, within each province, to each race according to its numbers and tax-paying capacity. The reform bill proper proposed to enfranchise every male citizen above 24 years of age with one year's residential qualification.

At first the chances of the adoption of such a measure seemed small. It was warmly supported from outside by the Social Democrats, who held only 11 seats in the House; inside, the Christian Socialists or Lueger party were favourable on the whole as they hoped to gain seats at the expense of the German Progressives and German Populists and to extend their own organization throughout the empire. The Young Czechs, too, were favourable, while the Poles reserved their attitude. Hostile

in principle and by instinct, they waited to ascertain the mind of the emperor, before actively opposing the reform. With the exception of the German Populists who felt that a German "Liberal" party could not well oppose an extension of popular rights, all the German Liberals were antagonistic, some bitterly, to the measure. The Constitutional Landed Proprietors who had played so large a part in Austrian politics since the 'sixties, and had for a generation held the leadership of the German element in parliament and in the country, saw themselves doomed and the leadership of the Germans given to the Christian Socialists. None of the representatives of the *curia* system fought so tenaciously for their privileges as did the German nominees of the *curia* of large landed proprietors. Their opposition proved unavailing. The emperor frowned repeatedly upon their efforts.

Baron Gautsch fell in April over a difference with the Poles, and his successor, Prince Konrad zu Hohenlohe-Schillingsfürst, who had taken over the reform bills, resigned also, six weeks later, as a protest against the action of the crown in consenting to the enactment of a customs tariff in Hungary distinct from, though identical with, the joint Austro-Hungarian tariff comprised in the Széll-Körber compact and enacted as a joint tariff by the Reichsrath. A new cabinet was formed (June 2) by Baron von Beck, permanent under secretary of state in the ministry for agriculture, an official of considerable ability who had first acquired prominence as an instructor of the heir apparent, Archduke Francis Ferdinand, in constitutional and administrative law. By dint of skilful negotiation with the various parties and races, and steadily supported by the emperor who, on one occasion, summoned the recalcitrant party leaders to the Hofburg *ad audiendum verbum* and told them the reform "must be accomplished," Baron Beck succeeded, in October 1906, in attaining a final agreement, and on the 1st of December in securing the adoption of the reform. During the negotiations the number of constituencies was raised to 516, divided, according to provinces, as follows:—

Bohemia	130	previously	110
Galicja	106	"	78
Lower Austria	64	"	46
Moravia	49	"	43
Syria	30	"	27
Tirol	25	"	21
Upper Austria	22	"	20
Austrian Silesia	15	"	12
Bukovina	14	"	11
Carniola	12	"	11
Dalmatia	11	"	11
Carinthia	10	"	10
Salzburg	7	"	7
Istria	6	"	5
Görz and Gradisca	6	"	5
Trieste and territory	5	"	5
Vorarlberg	4	"	4

In the allotment of the constituencies to the various races their tax-paying capacity was taken into consideration. In mixed districts separate constituencies and registers were established for the electors of each race, who could only vote on their own register for a candidate of their own race. Thus Germans were obliged to vote for Germans and Czechs for Czechs; and, though there might be victories of Clerical over Liberal Germans or of Czech Radicals over Young Czechs, there could be no victories of Czechs over Germans, Poles over Ruthenes, or Slovenes over Italians. The constituencies were divided according to race as follows:—

Germans of all parties	233	previously	205
Czechs of all parties	168	"	81
Poles	80	"	71
Southern Slavs (Slovenes, Croats, Serbs)	37	"	27
Ruthenes	34	"	11
Italians	19	"	18
Rumanians	5	"	5

These allotments were slightly modified at the polls by the victory of some Social Democratic candidates not susceptible of strict racial classification. The chief feature of the allotment was, however, the formal overthrow of the fiction that Austria

is preponderatingly a German country and not a country preponderatingly Slav with a German dynasty and a German façade. The German constituencies, though allotted in a proportion unduly favourable, left the Germans, with 233 seats, in a permanent minority as compared with the 259 Slav seats. Even with the addition of the "Latin" (Rumanian and Italian) seats the "German-Latin block" amounted only to 257. This "block" no longer exists in practice, as the Italians now tend to co-operate rather with the Slavs than with the Germans. The greatest gainers by the redistribution were the Ruthenes, whose representation was trebled, though it is still far from being proportioned to their numbers. This and other anomalies will doubtless be corrected in future revisions of the allotment, although the German parties, foreseeing that any revision must work out to their disadvantage, stipulated that a two-thirds majority should be necessary for any alteration of the law.

After unsuccessful attempts by the Upper House to introduce plural voting, the bill became law in January 1907, the peers insisting only upon the establishment of a fixed *maximum* number or *numerus clausus*, of non-hereditary peers, so as to prevent the resistance of the Upper Chamber from being overwhelmed at any critical moment by an influx of crown nominees appointed *ad hoc*. The general election which took place amid considerable enthusiasm on the 14th of May resulted in a sweeping victory for the Social Democrats whose number rose from 11 to 87; in a less complete triumph for the Christian Socialists who increased from 27 to 67; and in the success of the extremer over the conservative elements in all races. A classification of the groups in the new Chamber presents many difficulties, but the following statement is approximately accurate. It must be premised that, in order to render the Christian Socialist or Lueger party the strongest group in parliament, an amalgamation was effected between them and the conservative Catholic party:—

	Total.
<i>German Conservatives—</i>	
Christian Socialists	96
German Agrarians	19
<i>German Liberals—</i>	
Progressives	15
Populists	29
Fan-German radicals (Wolf group)	13
Unattached Pan-Germans	3
Progressives	2
<i>Czechs—</i>	
Czech Agrarians	28
Young Czechs	18
Czech Clericals	17
Old Czechs	7
Czech National Socialists	9
Realists	2
Unattached Czech	1
<i>Social Democrats—</i>	
Of all races	87
<i>Poles—</i>	
Democrats	26
Conservatives	15
Populists	18
Centre	12
Independent Socialist	1
<i>Ruthenes—</i>	
National Democrats	25
Old or Russophil Ruthenes	5
<i>Slovenes—</i>	
Clericals	17
<i>Southern Slav Club—</i>	
Croats	20
Serbs	
Slovene Liberals }	
<i>Italians—</i>	
Clerical Populists	11
Liberals	4
<i>Rumanians—</i>	
Rumanian Club	5
<i>Jews—</i>	
Zionists	4
Democrats	1
Unclassified, vacancies, &c.	6

General election 1907.

The legislature elected by universal suffrage worked fairly smoothly during the first year of its existence. The estimates were voted with regularity, racial animosity was somewhat less prominent, and some large issues were debated. The desire not to disturb the emperor's Diamond Jubilee year by untoward scenes doubtless contributed to calm political passion, and it was celebrated in 1908 with complete success. But it was no sooner over than the crisis over the annexation of Bosnia and Herzegovina, which is dealt with above, eclipsed all purely domestic affairs in the larger European question. (H. W. S.)

BIBLIOGRAPHY.—1. *Sources.* A collection of early authorities on Austrian history was published in 3 vols. folio by Hieronymus Pez (Leipzig, 1721-1725) under the title *Scriptoria rerum Austriacarum veteris et genuini*, of which a new edition was printed at Regensburg in 1745, and again, under the title *Opera Austriacarum scriptores*, by A. Rauch at Vienna in 1793-1794. It was not, however, till the latter half of the 19th century that the vast store of public and private archives began to be systematically exploited. Apart from the material published in the *Monumenta Germ. Hist.* of Pertz and his collaborators, there are several collections devoted specially to the sources of Austrian history. Of these the most notable is the *Fonnes rerum Austriacarum*, published under the auspices of the Historical Commission of the Imperial Academy of Sciences at Vienna; the series, of which the first volume was published in 1855, is divided into two parts: (i.) *Scriptores*, of which the 9th vol. appeared in 1904; (ii.) *Diplomatia et cta.*, of which the 58th vol. appeared in 1906. It covers the whole range of Austrian history, medieval and modern. Another collection is the *Quellen und Forschungen zur Geschichte, Literatur und Sprache Österreichs und seiner Kronländer*, edited by J. Hirn and J. E. Wackernagel (Graz, 1895, &c.), of which vol. x. appeared in 1906. Besides these there are numerous accounts and inventories of public and private archives, for which see Dahlmann-Waitz, *Quellenkunde* (ed. 1906), pp. 14-15, 43, and suppl. vol. (1907), pp. 4-5. Collections of treaties the most notable is that of L. Neumann, *Recueil des traités conclus par l'Autriche avec les puissances étrangères depuis 1763 (6 vols., Leipzig, 1855, &c.)*, continued by A. de Plason (18 vols., Vienna, 1877-1905). In 1907, however, the Imperial Commission for the Modern History of Austria issued the first volume of a new series, *Österreichische Staatsverträge*, which promises to be of the utmost value. Like the *Recueil des traités conclus par la Russie* of T. T. de Martens, it is compiled on the principle of devoting separate volumes to the treaties entered into with the several states; this is obviously convenient as enabling the student to obtain a clear review of the relations of Austria to any particular state throughout the whole period covered. For treaties see also Freiherr von Vasque von Füttingen, *Übersicht der österreichischen Staatsverträge seit Maria Theresia bis auf die neueste Zeit* (Vienna, 1868); and J. A. Bittner, *Chronologisches Verzeichniss der österreichischen Staatsverträge* (Band G, 1526-1723, Vienna, 1903).

2. *Works.*—(a) *General.* Archdeacon William Cox's *History of the House of Austria, 1218-1792* (3 vols., London, 1817), with its continuation by W. Kelly (London, 1853; new edition, 1873), remains the only general history of Austria in the English language. It has, of course, long been superseded as a result of the research indicated above. The amount of work that has been devoted to this subject since Cox's time will be seen from the following list of books, which are given in the chronological order of their publication:—Hamburg, 1834-1850; Count F. von Hartig, *Geschichte der Revolution in Österreich im Jahre 1848* (Leipzig, 1851; 3rd edition, enlarged, 1851; translated as appendix to Cox's *House of Austria*, ed. 1853), a work which created a great sensation at the time and remains of much value; W. H. Stiles, *Austria in 1848-1849* (2 vols., New York, 1852), by an eye-witness of events; M. Büdinger, *Österreichische Gesch. bis zum Ausgange des dreizehnten Jahrhunderts*, vol. i. to A. D. 1055 (Leipzig, 1858); A. Springer, *Geschichte Österreichs seit dem Wiener Frieden, 1806-2* vols., to 1849; Leipzig, 1863-1865; A. von Arneth, *Geschichte Maria Theresias* (to vi., Vienna, 1865-1879); the series *Österreichische Gesch. für das Volk*, 17 vols., by various authors (Vienna, 1864, &c.), for which see Dahlmann-Waitz, p. 86; H. Bidermann, *Gesch. der österreichischen Gesamtstaatsidee, 1526-1804*, parts 1 and 2 to 1740 (Innsbruck, 1867, 1887); J. A. Freiherr von Helfert, *Gesch. Österreichs vom Ausgange des Oktoberaufstandes, 1848*, vols. i.-iv. (Leipzig and Prague, 1869-1886); W. Rogge, *Österreich von Vilagos bis zur Gegenwart* (3 vols., Leipzig and Vienna, 1872, 1873), and *Österreichs völkische Höhenwacht-Beute* (Leipzig, 1879).

(b) *General.* Franz X. Kroner (Ritter von Marchland), the German historian of the class of 1848, *Handbuch der Gesch. Österreichs* (5 vols., Berlin, 1876-1879), with copious references, *Gesch. der Neuzeit Österreichs vom 18ten Jahrhundert bis auf die Gegenwart* (Berlin, 1879), from the German-liberal point of view, and *Grundriss der österreichischen Gesch.* (Vienna, 1882); Baron Henry de Worms, *The Austro-Hungarian Empire* (London, 2nd ed., 1876); Louis Asseline, *Histoire de l'Autriche depuis la mort de Marie Thérèse* (Paris, 1877), sides with the Slavs against Germans and Magyars; Louis Leger, *Hist. de l'Autriche-*

Hongrie (Paris, 1879), also strongly Slavophil; A. Wolf, *Geschichtliche Bilder aus Österreich* (2 vols., Vienna, 1878-1880), and *Österreich unter Maria Theresia, Joseph II. und Leopold I.* (Berlin, 1882); E. Wertheimer, *Gesch. Österreichs und Ungarns im ersten Jahrzehnt des 19ten Jahrhunderts* (2 vols., Leipzig, 1884-1890); A. Huber, *Gesch. Österreichs*, vols. i. to v. up to 1648 (in Heeren's *Gesch. der europ. Staaten*, Gotha, 1885-1895); J. Emmer, *Kaiser Franz Joseph I. fünfzig Jahre österreichischer Gesch.* (2 vols., Vienna, 1898); F. M. Mayer, *Gesch. Österreichs mit besonderer Rücksicht auf das Kulturleben* (2 vols. 2nd ed., Vienna, 1900-1901); A. Dopsch, *Forschungen zur inneren Gesch. Österreichs*, vol. i. (Innsbruck, 1903); Louis Eisenmann, *Le Compromis austro-hongrois de 1867* (Paris, 1904); H. Friedjung, *Österreich von 1848 bis 1860* (Stuttgart, 1908 seq.); Geoffrey Drage, *Austria-Hungary* (London, 1909).

(c) *Constitutional.*—E. Werunsky, *Österreichische Rechts- und Rechtsgeschichte* (Vienna, 1894, &c.); A. Bechmann, *Lehrbuch der österreichischen Rechtsgesch.* (Prague, 1895-1896); A. Huber, *Österreichische Rechtsgesch.* (Leipzig and Vienna, 1895, 2nd ed. by A. Dopsch, ib., 1901); A. Luschin von Ebengruß, *Österreichische Rechtsgesch.* (2 vols., Bamberg, 1895, 1896), a work of first-class importance; and *Grundriss der österreichischen Rechtsgesch.* (Bamberg, 1899); G. Kolmer, *Parlament und Verfassung in Österreich*, vols. i. to iii. from 1848 to 1885 (Vienna, 1902-1905). For relations with Hungary see J. Andrassy, *Ungarns Ausgleich mit Österreich, 1867* (Leipzig, 1897); L. Eisenmann, *Le Compromis austro-hongrois de 1867* (Paris, 1904).

(d) *Diplomatic.*—A. Beer, *Zehn Jahre österreichischer Politik, 1801-1810* (Leipzig, 1877), and *Die orientalische Politik Österreichs seit 1774* (Prague and Leipzig, 1883); A. Fournier, *Gente and Cobenzl: Geschichte der öst. Politik in den Jahren 1801-1805* (Vienna, 1880); F. von Demelitsch, *Metternich und seine auswärtige Politik*, vol. i. (1809-1812, Stuttgart, 1898); H. Ubersberger, *Österreich und Russland seit dem Ende des 15ten Jahrhunderts*, vol. i. 1488 to 1605 (Kommission für die neuere Gesch. Österreichs, Vienna, 1905). See further the bibliographies to the articles on METTERNICH, GENTZ, &c. For the latest developments of the "Austrian question" see André Chéradame, *L'Europe et la question d'Autriche au sens du XX^e siècle* (Paris, 1901), and J. Allouvier, *La question d'Autriche* (Paris, 1901); René Henry, *Questions d'Autriche-Hongrie et question d'Orient* (Paris, 1903), with preface by Anatole Leroy-Beaulieu; "Scotus Viator," *The Future of Austria-Hungary* (London, 1907).

(e) *Racial Question.*—There is a very extensive literature on the question of languages and race in Austria. The best statement of the legal questions involved is in Josef Ulbrith and Ernst Mischler's *Österr. Staatswörterbuch* (3 vols., Vienna, 1894-1897; 2nd ed. 1904, &c.). See also Dummreicher, *Süddeutsche Betrachtungen* (Leipzig, 1893); Hainisch, *Die Zukunft der Deutsch-Österreicher* (Vienna, 1892); Heimner, *Die Zukunft der Deutsch-Österreicher* (ib. 1893); L. Leger, *La race, le Danube et le Balkan* (Paris, 1884); Bressnitz von Sylacloff, *Die panславistische Agitation* (Berlin, 1899); Bertrand Auerbach, *Les Races et les nationalités en Autriche-Hongrie* (Paris, 1898).

(f) *Biographical.*—C. von Wurzbach, *Biographisches Lexikon des Kaiserthums Österreich* (60 vols., Vienna, 1856-1891); also the *Allgemeine deutsche Biographie*.

Many further authorities, whether works, memoirs or collections of documents, are referred to in the lists appended to the articles in this book on the various Austrian sovereigns, and in the sections on full bibliographies, see Dahlmann-Waitz, *Quellenkunde* (ed. 1906, and subsequent supplements); many works, covering particular periods, are also enumerated in the bibliographies in the several volumes of the *Cambridge Modern History*. (W. A. P.)

AUSTRIAN SUCCESSION, WAR OF THE (1740-1748).

This war began with the invasion of Silesia by Frederick II. of Prussia in 1740, and was ended by the peace of Aix-la-Chapelle (Aachen) in 1748. After 1741 nearly all the powers of Europe were involved in the struggle, but the most enduring interest of the war lies in the struggle of Prussia and Austria for Silesia. South-west Germany, the Low Countries and Italy were, as usual, the battle-grounds of France and Austria. The constant allies of France and Prussia were Spain and Bavaria; various other powers at intervals joined them. The cause of Austria was supported almost as a matter of course by England and Holland, the traditional enemies of France. Of Austria's allies from time to time Sardinia and Saxony were the most important.

1. *Frederick's Invasion of Silesia, 1740.*—Prussia in 1740 was a small, compact and thoroughly organized power, with an army 100,000 strong. The only recent war service of this army had been in the desultory Rhine campaign of 1733-35. It was therefore regarded as one of the minor armies of Europe, and few thought that it could rival the forces of Austria and France. But it was drilled to a perfection not hitherto attained, and the Prussian infantry soldier was so well trained and equipped that

he could fire five shots to the Austrian's three, though the cavalry and artillery were less efficient. But the initial advantage of Frederick's army was that it had, undisturbed by wars, developed the standing army theory to full effect. While the Austrians had to wait for drafts to complete the field forces, Prussian regiments could take the field at once, and thus Frederick was able to overrun Silesia almost unopposed. His army was concentrated quietly upon the Oder, and without declaration of war, on the 16th of December 1740, it crossed the frontier into Silesia. The Austrian generals could do no more than garrison a few fortresses, and with the small remnant of their available forces fell back to the mountain frontier of Bohemia and Moravia. The Prussian army was soon able to go into winter quarters, holding all Silesia and investing the strong places of Glogau, Brieg and Neisse.

2. *Silesian Campaign of 1741.*—In February 1741, the Austrians collected a field army under Count Neipperg (1684-1774) and made preparations to reconquer Silesia. The Austrians in Neisse and Brieg still held out. Glogau, however, was stormed on the night of the 9th of March, the Prussians, under Prince Leopold (the younger) of Anhalt-Dessau, executing their task in one hour with a mathematical precision which excited universal admiration. But the Austrian army in Moravia was now in the field, and Frederick's cantonments were dispersed over all Upper Silesia. It was a work of the greatest difficulty to collect the army, for the ground was deep in snow, and before it was completed Neisse was relieved and the Prussians cut off from their own country by the march of Neipperg from Neisse on Brieg; a few days of slow manœuvring between these places ended in the battle of Mollwitz (10th April 1741), the first pitched battle fought by Frederick and his army. The Prussian right wing of cavalry was speedily routed, but the day was retrieved by the magnificent discipline and tenacity of the infantry. The Austrian cavalry was shattered in repeated attempts to ride them down, and before the Prussian volleys the Austrian infantry, in spite of all that Neipperg and his officers could do, gradually melted away. After a stubborn contest the Prussians remained masters of the field. Frederick himself was far away. He had fought in the cavalry *mêlée*, but after this, when the battle seemed lost, he had been persuaded by Field Marshal Schwerin to ride away. Schwerin thus, like Marshal Saxe at Fontenoy, remained behind to win the victory, and the king narrowly escaped being captured by wandering Austrian hussars. The immediate result of the battle was that the king secured Brieg, and Neipperg fell back to Neisse, where he maintained himself and engaged in a war of manœuvring during the summer. But Europe realized suddenly that a new military power had arisen, and France sent Marshal Belleisle to Frederick's camp to negotiate an alliance. Thenceforward the "Silesian adventure" became the War of the Austrian Succession. The elector of Bavaria's candidature for the imperial dignity was to be supported by a French "auxiliary" army, and other French forces were sent to observe Hanover. Saxony was already watched by a Prussian army under Prince Leopold of Anhalt-Dessau, the "old Dessauer," who had trained the Prussian army to its present perfection. The task of Sweden was to prevent Russia from attacking Prussia, but her troops were defeated, on the 3rd of September 1741, at Wilmanstrand by a greatly superior Russian army, and in 1742 another great reverse was sustained in the capitulation of Helsingfors. In central Italy an army of Neapolitans and Spaniards was collected for the conquest of the Milanese.

3. *The Allies in Bohemia.*—The French duly joined the elector's forces on the Danube and advanced on Vienna; but the objective was suddenly changed, and after many counter-marches the allies advanced, in three widely-separated corps, on Prague. A French corps moved via Amberg and Pilsen. The elector marched on Budweis, and the Saxons (who had now joined the allies) invaded Bohemia by the Elbe valley. The Austrians could at first offer little resistance, but before long a considerable force intervened at Tabor between the Danube and the allies, and Neipperg was now on the march from Neisse to

join in the campaign. He had made with Frederick the curious agreement of Klein Schnellendorf (9th October 1741), by which Neisse was surrendered after a mock siege, and the Austrians undertook to leave Frederick unmolested in return for his releasing Neipperg's army for service elsewhere. At the same time the Hungarians, moved to enthusiasm by the personal appeal of Maria Theresa, had put into the field a *levée en masse*, or "insurrection," which furnished the regular army with an invaluable force of light troops. A fresh army was collected under Field Marshal Khevenhüller at Vienna, and the Austrians planned an offensive winter campaign against the Franco-Bavarian forces in Bohemia and the small Bavarian army that remained on the Danube to defend the electorate. The French in the meantime had stormed Prague on the 26th of November, the grand-duke Francis, consort of Maria Theresa, who commanded the Austrians in Bohemia, moving too slowly to save the fortress. The elector of Bavaria, who now styled himself archduke of Austria, was crowned king of Bohemia (19th December 1741) and elected to the imperial throne as Charles VII. (24th January 1742), but no active measures were undertaken. In Bohemia the month of December was occupied in mere skirmishes. On the Danube, Khevenhüller, the best general in the Austrian service, advanced on the 27th of December, swiftly drove back the allies, shut them up in Linz, and pressed on into Bavaria. Munich itself surrendered to the Austrians on the coronation day of Charles VII. At the close of this first act of the campaign the French, under the old Marshal de Broglie, maintained a precarious foothold in central Bohemia, menaced by the main army of the Austrians, and Khevenhüller was ranging unopposed in Bavaria, while Frederick, in pursuance of his secret obligations, lay inactive in Silesia. In Italy the allied Neapolitans and Spaniards had advanced towards Modena, the duke of which state had allied himself with them, but the vigilant Austrian commander Count Traun had outmarched them, captured Modena, and forced the duke to make a separate peace.

4. *Campaign of 1742.*—Frederick had hoped by the truce to secure Silesia, for which alone he was fighting. But with the successes of Khevenhüller and the enthusiastic "insurrection" of Hungary, Maria Theresa's opposition became firmer, and she divulged the provisions of the truce, in order to compromise Frederick with his allies. The war recommenced. Frederick had not rested on his laurels; in the uneventful summer campaign of 1741 he had found time to begin that reorganization of his cavalry which was before long to make it even more efficient than his infantry. Charles VII., whose territories were overrun by the Austrians, asked him to create a diversion by invading Moravia. In December 1741, therefore, Schwerin had crossed the border and captured Olmütz. Glatz also was invested, and the Prussian army was concentrated about Olmütz in January 1742. A combined plan of operations was made by the French, Saxons and Prussians for the rescue of Linz. But Linz soon fell; Broglie on the Moldau, weakened by the departure of the Bavarians to oppose Khevenhüller, and of the Saxons to join forces with Frederick, was in no condition to take the offensive, and large forces under Prince Charles of Lorraine lay in his front from Budweis to Iglau. Frederick's march was made towards Iglau in the first place. Brünn was invested about the same time (February), but the direction of the march was changed, and instead of moving against Prince Charles, Frederick pushed on southwards by Znaim and Nikolsburg. The extreme outposts of the Prussians appeared before Vienna. But Frederick's advance was a mere foray, and Prince Charles, leaving a screen of troops in front of Broglie, marched to cut off the Prussians from Silesia, while the Hungarian levies poured into Upper Silesia by the Jablunka Pass. The Saxons, disintegrated and demoralized, soon marched off to their own country, and Frederick with his Prussians fell back by Zwittau and Leuto-mischl to Kuttenberg in Bohemia, where he was in touch with Broglie on the one hand and (Glatz having now surrendered) with Silesia on the other. No defence of Olmütz was attempted, and the small Prussian corps remaining in Moravia fell back towards Upper Silesia. Prince Charles, in pursuit of the king

marched by Iglau and Teutsch (Deutsch) Brod on Kuttenberg, and on the 17th of May was fought the battle of Chotusitz or Czaslau, in which after a severe struggle the king was victorious. His cavalry on this occasion retrieved its previous failure, and its conduct gave an earnest of its future glory not only by its charges on the battlefield, but its vigorous pursuit of the defeated Austrians. Almost at the same time Broglie fell upon a part of the Austrians left on the Moldau and won a small, but morally and politically important, success in the action of Sahay, near Budweis (May 24, 1742). Frederick did not propose another combined movement. His victory and that of Broglie disposed Maria Theresa to cede Silesia in order to make good her position elsewhere, and the separate peace between Prussia and Austria, signed at Breslau on the 11th of June, closed the First Silesian War. The War of the Austrian Succession continued.

5. *The French at Prague.*—The return of Prince Charles, released by the peace of Breslau, put an end to Broglie's offensive. The prince pushed back the French posts everywhere, and his army converged upon Prague, where, towards the end of June 1742, the French were to all intents and purposes surrounded. Broglie had made the best resistance possible with his inferior forces, and still displayed great activity, but his position was one of great peril. The French government realized at last that it had given its general inadequate forces. The French army on the lower Rhine, hitherto in observation of Hanover and other possibly hostile states, was hurried into Franconia. Prince Charles at once raised the siege of Prague (September 14), called up Khevenhüller with the greater part of the Austrian army on the Danube, and marched towards Amberg to meet the new opponent. Marshal Maillebois (1682-1762), its commander, then manoeuvred from Amberg towards the Eger valley, to gain touch with Broglie. Marshal Belleisle, the political head of French affairs in Germany and a very capable general, had accompanied Broglie throughout, and it seems that Belleisle and Broglie believed that Maillebois' mission was to regain a permanent foothold for the army in Bohemia; Maillebois, on the contrary, conceived that his work was simply to disengage the army of Broglie from its dangerous position, and to cover its retreat. His operations were no more than a demonstration, and had so little effect that Broglie was sent for in haste to take over the command from him, Belleisle at the same time taking over charge of the army at Prague. Broglie's command was now on the Danube, east of Regensburg, and the imperial (chiefly Bavarian) army of Charles VII. under Seckendorf aided him to clear Bavaria of the Austrians. This was effected with ease, for Khevenhüller and most of his troops had gone to Bohemia. Prince Charles and Khevenhüller now took post between Linz and Passau, leaving a strong force to deal with Belleisle in Prague. This, under Prince Lobkowitz, was little superior in numbers or quality to the troops under Belleisle, under whom served Saxe and the best of the younger French generals, but its light cavalry swept the country clear of provisions. The French were quickly on the verge of starvation, winter had come, and the marshal resolved to retreat. On the night of the 16th of December 1742, the army left Prague to be defended by a small garrison under Chevert, and took the route of Eger. The retreat (December 16-26) was accounted a triumph of generalship, but the weather made it painful and costly. The brave Chevert displayed such confidence that the Austrians were glad to allow him freedom to join the main army. The cause of the new emperor was now sustained only in the valley of the Danube, where Broglie and Seckendorf opposed Prince Charles and Khevenhüller, who were soon joined by the force lately opposing Belleisle.

In Italy, Traun held his own with ease against the Spaniards and Neapolitans. Naples was forced by a British squadron to withdraw her troops for home defence, and Spain, now too weak to advance in the Po valley, sent a second army to Italy via France. Sardinia had allied herself with Austria, and at the same time neither state was at war with France, and this led to curious complications, combats being fought in the Isère valley between

the troops of Sardinia and of Spain, in which the French took no part.

6. *The Campaign of 1743* opened disastrously for the emperor. The French and Bavarian armies were not working well together, and Broglie and Seckendorf had actually quarrelled. No connected resistance was offered to the converging march of Prince Charles's army along the Danube, Khevenhüller from Salzburg towards southern Bavaria, and Prince Lobkowitz (1685-1755) from Bohemia towards the Naab. The Bavarians suffered a severe reverse near Braunau (May 9, 1743), and now an Anglo-allied army commanded by King George II., which had been formed on the lower Rhine on the withdrawal of Maillebois, was advancing southward to the Main and Neckar country. A French army, under Marshal Noailles, was being collected on the middle Rhine to deal with this new force. But Broglie was now in full retreat, and the strong places of Bavaria surrendered one after the other to Prince Charles. The French and Bavarians had been driven almost to the Rhine when Noailles and the king came to battle. George, completely outmanoeuvred by his veteran antagonist, was in a position of the greatest danger between Aschaffenburg and Hanau in the defile formed by the Spessart Hills and the river Main. Noailles blocked the outlet and had posts all around, but the allied troops forced their way through and inflicted heavy losses on the French, and the battle of Dettingen is justly reckoned as a notable victory of the British arms (June 27). Both Broglie, who, worn out by age and exertions, was soon replaced by Marshal Coigny (1670-1759), and Noailles were now on the strict defensive behind the Rhine. Not a single French soldier remained in Germany, and Prince Charles prepared to force the passage of the great river in the Breisgau while the king of England moved forward via Mainz to co-operate by drawing upon himself the attention of both the French marshals. The Anglo-allied army took Worms, but after several unsuccessful attempts to cross, Prince Charles went into winter quarters. The king followed his example, drawing in his troops to the northward, to deal, if necessary, with the army which the French were collecting on the frontier of Flanders. Austria, England, Holland and Sardinia were now allied. Saxony changed sides, and Sweden and Russia neutralized each other (peace of Abo, August 1743). Frederick was still quiescent; France, Spain and Bavaria alone continued actively the struggle against Maria Theresa.

In Italy, the Spaniards on the Panaro had achieved a Pyrrhic victory over Traun at Campo Santo (February 8, 1743), but the next six months were wasted in inaction, and Lobkowitz, joining Traun with reinforcements from Germany, drove back the enemy to Rimini. The Spanish-Piedmontese war in the Alps continued without much result, the only incident of note being a combat at Castelfelfino won by the king of Sardinia in person.

7. *Campaign of 1744.*—With 1744 began the Second Silesian War. Frederick, disquieted by the universal success of the Austrian cause, secretly concluded a fresh alliance with Louis XV. France had posed hitherto as an auxiliary, her officers in Germany had worn the Bavarian cockade, and only with England was she officially at war. She now declared war direct upon Austria and Sardinia (April 1744). A corps was assembled at Dunkirk to support the cause of the Pretender in Great Britain, and Louis in person, with 90,000 men, prepared to invade the Austrian Netherlands, and took Menin and Ypres. His presumed opponent was the allied army previously under King George and now composed of English, Dutch, Germans and Austrians. On the Rhine, Coigny was to make head against Prince Charles, and a fresh army under the prince de Conti was to assist the Spaniards in Piedmont and Lombardy. This plan was, however, at once dislocated by the advance of Charles, who, assisted by the veteran Traun, skillfully manoeuvred his army over the Rhine near Philippsburg (July 1), captured the lines of Weissenburg, and cut off the French marshal from Alsace. Coigny, however, cut his way through the enemy at Weissenburg and posted himself near Strassburg. Louis XV. now abandoned the invasion of Flanders, and his army moved down to take a decisive part

in the war in Alsace and Lorraine. At the same time Frederick crossed the Austrian frontier (August).

The attention and resources of Austria were fully occupied, and the Prussians were almost unopposed. One column passed through Saxony, another through Lusatia, while a third advanced from Silesia. Prague, the objective, was reached on the 2nd of September. Six days later the Austrian garrison was compelled to surrender, and the Prussians advanced to Budweis. Maria Theresa once again rose to the emergency, a new "insurrection" took the field in Hungary, and a corps of regulars was assembled to cover Vienna, while the diplomatists won over Saxony to the Austrian side. Prince Charles withdrew from Alsace, unmolested by the French, who had been thrown into confusion by the sudden and dangerous illness of Louis XV. at Metz. Only Seckendorf with the Bavarians pursued him. No move was made by the French, and Frederick thus found himself after all isolated and exposed to the combined attack of the Austrians and Saxons. Marshal Traun, summoned from the Rhine, held the king in check in Bohemia, the Hungarian irregulars inflicted numerous minor reverses on the Prussians, and finally Prince Charles arrived with the main army. The campaign resembled that of 1742; the Prussian retreat was closely watched, and the rearguard pressed hard. Prague fell, and Frederick, completely outmanœuvred by the united forces of Prince Charles and Traun, regained Silesia with heavy losses. At the same time, the Austrians gained no foothold in Silesia itself. On the Rhine, Louis, now recovered, had besieged and taken Freiburg, after which the forces left in the north were reinforced and besieged the strong places of Flanders. There was also a slight war of manœuvre on the middle Rhine.

In 1744 the Italian war became for the first time serious. A grandiose plan of campaign was formed, and as usual the French and Spanish generals at the front were hampered by the orders of their respective governments. The object was to unite the army in Dauphiné with that on the lower Po. The adhesion of Genoa was secured, and a road thereby obtained into central Italy. But Lobkowitz had already taken the offensive and driven back the Spanish army of Count de Gages towards the Neapolitan frontier. The king of Naples at this juncture was compelled to assist the Spaniards at all hazards. A combined army was formed at Velletri, and defeated Lobkowitz there on the 11th of August. The crisis past, Lobkowitz then went to Piedmont to assist the king against Conti, the king of Naples returned home, and de Gages followed the Austrians with a weak force. The war in the Alps and the Apennines was keenly contested. Villeda and Montalban were stormed by Conti on the 20th of April, a desperate fight took place at Peyre-Longue on the 18th of July, and the king of Sardinia was defeated in a great battle at Madonna del Olmo (September 30) near Coni (Cuneo). Conti did not, however, succeed in taking this fortress, and had to retire into Dauphiné for his winter quarters. The two armies had, therefore, failed in their attempt to combine, and the Austro-Sardinians still lay between them.

8. *Campaign of 1745.*—The interest of the next campaign centres in the three greatest battles of the war—Hohenfriedberg, Kesselsdorf and Fontenoy. The first event of the year was the Quadruple Alliance of England, Austria, Holland and Saxony, concluded at Warsaw on the 8th of January. Twelve days previously, the death of Charles VII. submitted the imperial title to a new election, and his successor in Bavaria was not a candidate. The Bavarian army was again unfortunate; caught in its scattered winter quarters (action of Amberg, January 7), it was driven from point to point, and the young elector had to abandon Munich once more. The peace of Füssen followed on the 22nd of April, by which he secured his hereditary states on condition of supporting the candidature of the grand-duke Francis, consort of Maria Theresa. The "imperial" army ceased *ipso facto* to exist, and Frederick was again isolated. No help was to be expected from France, whose efforts this year were centred on the Flanders campaign. In effect, on the 10th of May, before Frederick took the field, Louis XV. and Saxe had besieged Tournay, and inflicted upon the relieving army of

the duke of Cumberland the great defeat of Fontenoy (q.v.). In Silesia the customary small war had been going on for some time, and the concentration of the Prussian army was not effected without severe fighting. At the end of May, Frederick, with about 65,000 men, lay in the camp of Frankenstein, between Glatz and Neisse, while behind the Riesengebirge about Landshut Prince Charles had 85,000 Austrians and Saxons. On the 4th of June was fought the battle of Hohenfriedberg (q.v.) or Striegau, the greatest victory as yet of Frederick's career, and, of all his battles, excelled perhaps by Leuthen and Rossbach only. Prince Charles suffered a complete defeat and withdrew through the mountains as he had come. Frederick's pursuit was methodical, for the country was difficult and barren, and he did not know the extent to which the enemy was demoralized. The manœuvres of both leaders on the upper Elbe occupied all the summer, while the political questions of the imperial election and of an understanding between Prussia and England were pending. The chief efforts of Austria were directed towards the valleys of the Main and Lahn and Frankfurt, where the French and Austrian armies manœuvred for a position from which to overawe the electoral body. Marshal Traun was successful, and the grand-duke became the emperor Francis I. on the 13th of September. Frederick agreed with England to recognize the election a few days later, but Maria Theresa would not conform to the treaty of Breslau without a further appeal to the fortune of war. Saxony joined in this last attempt. A new advance of Prince Charles quickly brought on the battle of Soor, fought on ground destined to be famous in the war of 1866. Frederick was at first in a position of great peril, but his army changed front in the face of the advancing enemy and by its boldness and tenacity won a remarkable victory (September 30). But the campaign was not ended. An Austrian contingent from the Main joined the Saxons under Marshal Rutowski, and a combined movement was made in the direction of Berlin by Rutowski from Saxony and Prince Charles from Bohemia. The danger was very great. Frederick hurried up his forces from Silesia and marched as rapidly as possible on Dresden, winning the actions of Katholisch-Hennersdorf (November 24) and Görlitz (November 25). Prince Charles was thereby forced back, and now a second Prussian army under the old Dessauer advanced up the Elbe from Magdeburg to meet Rutowski. The latter took up a strong position at Kesselsdorf between Meissen and Dresden, but the veteran Leopold attacked him directly and without hesitation (December 14). The Saxons and their allies were completely routed after a hard struggle, and Maria Theresa at last gave way. In the peace of Dresden (December 25) Frederick recognized the imperial election, and retained Silesia, as at the peace of Breslau.

9. *Operations in Italy, 1745-1747.*—The campaign in Italy this year was also no mere war of posts. In March 1745 a secret treaty allied the Genoese republic with France, Spain and Naples. A change in the command of the Austrians favoured the first move of the allies. De Gages moved from Modena towards Leuca, the French and Spaniards in the Alps under Marshal Maillebois advanced through the Riviera to the Tanaro, and in the middle of July the two armies were at last concentrated between the Scrvia and the Tanaro, to the unusually large number of 80,000. A swift march on Piacenza drew the Austrian commander thither, and in his absence the allies fell upon and completely defeated the Sardinians at Bassignano (September 27), a victory which was quickly followed by the capture of Alessandria, Valenza and Casale. Jomini calls the concentration of forces which effected the victory "le plus remarquable de toute la guerre." But the complicated politics of Italy brought it about that Maillebois was ultimately unable to turn his victory to account. Indeed, early in 1746, Austrian troops, freed by the peace with Frederick, passed through Tirol into Italy; the Franco-Spanish winter quarters were brusquely attacked, and a French garrison of 6000 men at Asti was forced to capitulate. At the same time Count Browne with an Austrian corps struck at the allies on the lower Po, and cut off their communication with the main body

in Piedmont. A series of minor actions thus completely destroyed the great concentration. The allies separated, Maillebois covering Liguria, the Spaniards marching against Browne. The latter was promptly and heavily reinforced, and all that the Spaniards could do was to entrench themselves at Piacenza; the Spanish Infant as supreme commander calling up Maillebois to his aid. The French, skilfully conducted and marching rapidly, joined forces once more, but their situation was critical, for only two marches behind them the army of the king of Sardinia was in pursuit, and before them lay the principal army of the Austrians. The pitched battle of Piacenza (June 16) was hard fought, and Maillebois had nearly achieved a victory when orders from the Infant compelled him to retire. That the army escaped at all was in the highest degree creditable to Maillebois and to his son and chief of staff, under whose leadership it eluded both the Austrians and the Sardinians, defeated an Austrian corps in the battle of Rottofreddo (August 12), and made good its retreat on Genoa. It was, however, a mere remnant of the allied army which returned, and the Austrians were soon masters of north Italy, including Genoa (September). But they met with no success in their forays towards the Alps. Soon Genoa revolted from the oppressive rule of the victors, rose and drove out the Austrians (December 5-11), and the French, now commanded by Belleisle, took the offensive (1747). Genoa held out against a second Austrian siege, and after the plan of campaign had as usual been referred to Paris and Madrid, it was relieved, though a picked corps of the French army under the chevalier de Belleisle, brother of the marshal, was defeated in the almost impossible attempt (July 19) to storm the entrenched pass of Exiles (Col di Assietta), the chevalier, and with him the *élite* of the French nobility, being killed at the barricades. Before the steady advance of Marshal Belleisle the Austrians retired into Lombardy, and a desultory campaign was waged up to the conclusion of peace.

In North America the most remarkable incident of what has been called "King George's War" was the capture of the French Canadian fortress of Louisburg by a British expedition (April 29-June 16, 1745), of which the military portion was furnished by the colonial militia under Colonel (afterwards Lieutenant-General Sir William) Pepperell (1696-1759) of Maine. Louisburg was then regarded merely as a nest of privateers, and at the peace it was given up, but in the Seven Years' War it came within the domain of grand strategy, and its second capture was the preliminary step to the British conquest of Canada. For the war in India, see INDIA: History.

10. *Later Campaigns.*—The last three campaigns of the war in the Netherlands were illustrated by the now fully developed genius of Marshal Saxe. After Fontenoy the French carried all before them. The withdrawal of most of the English to aid in suppressing the 'Forty-Five rebellion at home left their allies in a helpless position. In 1746 the Dutch and the Austrians were driven back towards the line of the Meuse, and most of the important fortresses were taken by the French. The battle of Roucoux (or Raucourt) near Liège, fought on the 11th of October between the allies under Prince Charles of Lorraine and the French under Saxe, resulted in a victory for the latter. Holland itself was now in danger, and when in April 1747 Saxe's army, which had now conquered the Austrian Netherlands up to the Meuse, turned its attention to the United Provinces, the old fortresses on the frontier offered but slight resistance. The prince of Orange and the duke of Cumberland underwent a severe defeat at Lauffeld (Lawfield, &c., also called Val) on the 2nd of July 1747, and Saxe, after his victory, promptly and secretly despatched a corps under (Marshal) Löwendahl to besiege Bergen-op-Zoom. On the 18th of September Bergen-op-Zoom was stormed by the French, and in the last year of the war Maestricht, attacked by the entire forces of Saxe and Löwendahl, surrendered on the 7th of May 1748. A large Russian army arrived on the Meuse to join the allies, but too late to be of use. The quarrel of Russia and Sweden had been settled by the peace of Abo in 1743, and in 1746 Russia had allied herself with Austria. Eventually a large army marched from Moscow to the Rhine, an event

which was not without military significance, and in a manner precluded the great invasions of 1813-1814 and 1815. The general peace of Aix-la-Chapelle (Aachen) was signed on the 18th of October 1748.

11. *General Character of the War.*—Little need be said of the military features of the war. The intervention of Prussia as a military power was indeed a striking phenomenon, but her triumph was in a great measure due to her fuller application of principles of tactics and discipline universally recognized though less universally enforced. The other powers reorganized their forces after the war, not so much on the Prussian model as on the basis of a stricter application of known general principles. Prussia, moreover, was far ahead of all the other continental powers in administration, and over Austria, in particular, her advantage in this matter was almost decisive of the struggle. Added to this was the personal ascendancy of Frederick, not yet a great general, but energetic and resolute, and, further, opposed to generals who were responsible for their men to their individual sovereigns. These advantages have been decisive in many wars, almost in all. The special feature of the war of 1740 to 1748, and of other wars of the time, is the extraordinary disparity between the end and the means. The political schemes to be executed by the French and other armies were as grandiose as any of modern times; their execution, under the then conditions of time and space, invariably fell short of expectation, and the history of the war proves, as that of the Seven Years' War was to prove, that the small standing army of the 18th century could conquer by degrees, but could not deliver a decisive blow. Frederick alone, with a definite end and proportionate means wherewith to achieve it, succeeded completely. The French, in spite of their later victories, obtained so little of what they fought for that Parisians could say to each other, when they met in the streets, "You are as stupid as the Peace." And if, when fighting for their own hand, the governments of Europe could so fail of their purpose, even less was to be expected when the armies were composed of allied contingents, sent to the war each for a different object. The allied national armies of 1813 co-operated loyally, for they had much at stake and worked for a common object; those of 1741 represented the divergent private interests of the several dynasties, and achieved nothing.

BIBLIOGRAPHY.—Besides general works on Frederick's life and reign, of which Carlyle, Preuss and v. Taysen are of particular importance, and Frederick's own works, see the Prussian official *Die I. und II. schlesischen Kriege* (Berlin, 1890-1895); Austrian official *Kriege der Kaiserin Maria Theresia; Gesch. des österr. Erbfolgekrieges* (Vienna, from 1895); Jomini, *Traité des grandes opérations militaires*, introduction to vol. I. (Paris, 4th edition, 1851); C. von B.-K., *Geist und Stoff im Kriege* (Vienna, 1895); v. Arnet, *Maria Theresia's ersten Regierungsjahre* (1863); v. Schönig, *Die 5 erste Jahre der Regierung Friedrichs des Grossen*; Bernhard, *Friedrich der Grosse als Feldherr* (Berlin, 1881); v. Canitz, *Nachrichten, &c., über die Taten und Schicksale der Restiere, &c.* (Berlin, 1861); Grünhagen, *Gesch. des I. schlesischen Krieges* (Gotha, 1881-1882); Orlich, *Gesch. der schlesischen Kriege*; Deroz, *Beiträge zur Gesch. des österr. Erbfolgekrieges* (Munich, 1883); Crousse, *La Guerre de la succession dans les provinces belgiques* (Paris, 1888); Duncker, *Militärische, &c., Aftenblätter zur Gesch. des I. schles. Krieges; Militär-Wachblatt supplement* 1875, 1877, 1878, 1883, 1891, 1901, &c. (Berlin); *Mitteilungen des k.k. Kriegsarchivs*, from 1887 (Vienna); Baumgart, *Die Litteratur, &c., über Friedrich d. Gr.* (Berlin, 1886); Fortescue, *History of the British Army*, vol. II.; F. H. Skrine, *Fontenoy and the War of the Austrian Succession*, London, 1906; Francis Parkman, *A Half-Century of Conflict* (1892). (C. F. A.)

Naval Operations.

The naval operations of this war were languid and confused. They are complicated by the fact that they were entangled with the Spanish war, which broke out in 1739 in consequence of the long disputes between England and Spain over their conflicting claims in America. Until the closing years they were conducted with small intelligence or spirit. The Spanish government was nerveless, and sacrificed its true interest to the family ambition of the king Philip V., who wished to establish his younger sons as ruling princes in Italy. French administration was corrupt, and the government was chiefly concerned in its political interests in Germany. The British navy was at its lowest point of energy

and efficiency after the long administration of Sir Robert Walpole. Therefore, although the war contained passages of vigour, it was neither interesting nor decisive on the sea.

War on Spain was declared by Great Britain on the 23rd of October 1739. It was universally believed that the Spanish colonies would fall at once before attack. A plan was laid for combined operations against them from east and west. One force, military and naval, was to assault them from the West Indies under Admiral Edward Vernon. Another, to be commanded by Commodore George Anson, afterwards Lord Anson, was to round Cape Horn and to fall upon the Pacific coast. Delays, bad preparations, dockyard corruption, and the unpatriotic squabbles of the naval and military officers concerned caused the failure of a hopeful scheme. On the 21st of November 1739 Admiral Vernon did indeed succeed in capturing the ill-defended Spanish harbour of Porto Bello (in the present republic of Panama)—a trifling success to boast of. But he did nothing to prevent the Spanish convoys from reaching Europe. The Spanish privateers cruised with destructive effect against British trade, both in the West Indies and in European waters. When Vernon had been joined by Sir Chaloner Ogle with naval reinforcements and a strong body of troops, an attack was made on Cartagena in what is now Colombia (March 9-April 24, 1741). The delay had given the Spanish admiral, Don Blas de Leso, time to prepare, and the siege failed with a dreadful loss of life to the assailants. Want of success was largely due to the incompetence of the military officers and the brutal insolence of the admiral. The war in the West Indies, after two other unsuccessful attacks had been made on Spanish territory, died down and did not revive till 1748. The expedition under Anson sailed late, was very ill provided, and less strong than had been intended. It consisted of six ships and left England on the 18th of September 1740. Anson returned alone with his flagship the "Centurion" on the 15th of June 1744. The other vessels had either failed to round the Horn or had been lost. But Anson had harried the coast of Chile and Peru and had captured a Spanish galleon of immense value near the Philippines. His cruise was a great feat of resolution and endurance.

While Anson was pursuing his voyage round the world, Spain was mainly intent on the Italian policy of the king. A squadron was fitted out at Cadiz to convey troops to Italy. It was watched by the British admiral Nicholas Haddock. When the blockading squadron was forced off by want of provisions, the Spanish admiral Don José Navarro put to sea. He was followed, but when the British force came in sight of him Navarro had been joined by a French squadron under M. de Court (December 1741). The French admiral announced that he would support the Spaniards if they were attacked and Haddock retired. France and Great Britain were not yet openly at war, but both were engaged in the struggle in Germany—Great Britain as the ally of the queen of Hungary, Maria Theresa; France as the supporter of the Bavarian claimant of the empire. Navarro and M. de Court went on to Toulon, where they remained till February 1744. A British fleet watched them, under the command of admiral Richard Lestock, till Sir Thomas Mathews was sent out as commander-in-chief, and as minister to the court of Turin. Partial manifestations of hostility between the French and British took place in different seas, but avowed war did not begin till the French government issued its declaration of the 30th of March, to which Great Britain replied on the 31st. This formality had been preceded by French preparations for the invasion of England, and by a collision between the allies and Mathews in the Mediterranean (see *TOULON, BATTLE OF*). On the 11th of February a most confused battle was fought, in which the van and centre of the British fleet was engaged with the rear and centre of the allies. Lestock, who was on the worst possible terms with his superior, took no part in the action. He endeavoured to excuse himself by alleging that the orders of Mathews were contradictory. Mathews, a puzzle-headed and hot-tempered man, fought with spirit but in a disorderly way, breaking the formation of his fleet, and showing no power of direction. The mismanagement of the British fleet in the battle,

by arousing deep anger among the people, led to a drastic reform of the British navy which bore its first fruits before the war ended.

The French invasion scheme was arranged in combination with the Jacobite leaders, and soldiers were to be transported from Dunkirk. But though the British government showed itself wholly wanting in foresight, the plan broke down. In February 1744, a French fleet of twenty sail of the line entered the Channel under Jacques Aymar, comte de Roquefeuil, before the British force under admiral John Norris was ready to oppose him. But the French force was ill equipped, the admiral was nervous, his mind dwelt on all the misfortunes which might possibly happen, and the weather was bad. M. de Roquefeuil came up almost as far as the Downs, where he learnt that Sir John Norris was at hand with twenty-five sail of the line, and thereupon precipitately retreated. The military expedition prepared at Dunkirk to cross under cover of Roquefeuil's fleet naturally did not start. The utter weakness of the French at sea, due to long neglect of the fleet and the bankrupt state of the treasury, was shown during the Jacobite rising of 1745, when France made no attempt to profit by the distress of the British government. The Dutch having by this time joined Great Britain, made a serious addition to the naval power opposed to France, though Holland was compelled by the necessity for maintaining an army in Flanders to play a very subordinate part at sea. Not being stimulated by formidable attack, and having immediate interests both at home and in Germany, the British government was slow to make use of its latest naval strength. Spain, which could do nothing of an offensive character, was almost neglected. During 1745 the New England expedition which took Louisburg (April 30-June 16) was covered by a British naval force, but the operations were in a general way sporadic, subordinated to the supply of convoy, or to unimportant particular ends. In the East Indies, Mahé de la Bourdonnais made a vigorous use of a small squadron to which no effectual resistance was offered by the British naval forces. He captured Madras (July 24-September 9, 1746), a set-off for Louisburg, for which it was exchanged at the close of the war. In the same year a British combined naval and military expedition to the coast of France—the first of a long series of similar ventures which in the end were derided as "breaking windows with guineas"—was carried out during August and October. The aim was the capture of the French East India company's dockyard at L'Orient, but it was not attained.

From 1747 till the close of the war in October 1748 the naval policy of the British government, without reaching a high level, was yet more energetic and coherent. A closer watch was kept on the French coast, and effectual means were taken to intercept communication between France and her American possessions. In the spring information was obtained that an important convoy for the East and West Indies was to sail from L'Orient. In the previous year the British government had allowed a French expedition under M. d'Anville to fail mainly by its own weakness. In 1747 a more creditable line was taken. An overwhelming force was employed under the command of Anson to intercept the convoy in the Channel. It was met, crushed and captured, or driven back, on the 3rd of May. On the 14th of October another French convoy, protected by a strong squadron, was intercepted by a well-appointed and well-directed squadron of superior numbers—the squadrons were respectively eight French and fourteen British—in the Bay of Biscay. The French admiral Desherbiers de l'Étenduère made a very gallant resistance, and the fine quality of his ships enabled him to counteract to some extent the superior numbers of Sir Edward Hawke, the British admiral. While the war-ships were engaged, the merchant vessels, with the small protection which Desherbiers could spare them, continued on their way to the West Indies. Most of them were, however, intercepted and captured in those waters. This disaster convinced the French government of its helplessness at sea, and it made no further effort.

The last naval operations took place in the West Indies, where the Spaniards, who had for a time been treated as a negligible quantity, were attacked on the coast of Cuba by a British

squadron under Sir Charles Knowles. They had a naval force under Admiral Regio at Havana. Each side was at once anxious to cover its own trade, and to intercept that of the other. Capture was rendered particularly desirable to the British by the fact that the Spanish homeward-bound convoy would be laden with the bullion sent from the American mines. In the course of the movement of each to protect its trade, the two squadrons met on the 1st of October 1748 in the Bahama Channel. The action was indecisive when compared with the successes of British fleets in later days, but the advantage lay with Sir Charles Knowles. He was prevented from following it up by the speedy receipt of the news that peace had been made in Europe by the powers, who were all in various degrees exhausted. That it was arranged on the terms of a mutual restoration of conquests shows that none of the combatants could claim to have established a final superiority. The conquests of the French in the Bay of Bengal, and their military successes in Flanders, enabled them to treat on equal terms, and nothing had been taken from Spain.

The war was remarkable for the prominence of privateering on both sides. It was carried on by the Spaniards in the West Indies with great success, and actively at home. The French were no less active in all seas. Mahé de Bourdonnais's attack on Madras partook largely of the nature of a privateering venture. The British retaliated with vigour. The total number of captures by French and Spanish corsairs was in all probability larger than the list of British—partly for the reason given by Voltaire, namely, that more British merchants were taken because there were many more British merchant ships to take, but partly also because the British government had not yet begun to enforce the use of convoy so strictly as it did in later times.

See Beaton's *Naval and Military Memoirs* (London, 1804); *La Marine militaire de la France sous le règne de Louis XV.*; by G. Lacour-gayet (Paris, 1902); *The Royal Navy*, by Sir W. L. Clowes and others (London, 1891, &c.). (D. H.)

AUTHENTIC (from Gr. *αὐθέρης*, one who does a thing himself), genuine, as opposed to counterfeit, true or original. In music it is one of the terms used for the ecclesiastical modes. The title of *Authentic* was also used for Justinian's *Novells*.

AUTOCEPHALOUS (from Gr. *αὐτός*, self, and *κεφαλή*, head), of independent headship, a term used of certain ecclesiastical functionaries and organizations.

AUTOCHTHONES (Gr. *αὐτός*, and *χθών*, earth, i.e. people sprung from earth itself; Lat. *terrigenae*; see also under **ABORIGINES**), the original inhabitants of a country as opposed to settlers, and those of their descendants who kept themselves free from an admixture of foreign peoples. The practice in ancient Greece of describing legendary heroes and men of ancient lineage as "earthborn" greatly strengthened the doctrine of autochthony; for instance, the Athenians were golden grasshoppers in their hair in token that they were born from the soil and had always lived in Attica (Thucydides i. 6; Plato, *Menexenus*, 245). In Thebes, the race of Sparti were believed to have sprung from a field sown with dragons' teeth. The Phrygian Corybantes had been forced out of the hill-side like trees by Rhea, the great mother, and hence were called *δενδροβάνει*. It is clear from Aeschylus (*Prometheus*, 447) that primitive men were supposed to have at first lived like animals in caves and woods, till by the help of the gods and heroes they were raised to a stage of civilization.

AUTOCLAVE, a strong closed vessel of metal in which liquids can be heated above their boiling points under pressure. Etymologically the word indicates a self-closing vessel (*αὐτός*, self, and *clavis*, key, or *clavus*, nail), in which the tightness of the joints is maintained by the internal pressure, but this characteristic is frequently wanting in the actual apparatus to which the name is applied. The prototype of the autoclave was the digester of Denis Papin, invented in 1681, which is still used in cooking, but the appliance finds a much wider range of employment in chemical industry, where it is utilized in various forms in the manufacture of caudles, coal-tar colours, &c. Frequently an agitator, passing through a stuffing-box, is fitted so that the

contents may be stirred, and renewable linings are provided in cases where the substances under treatment exert a corrosive action on metal.

AUTOCRACY (Gr. *αὐτοκράτεια*, absolute power), a term applied to that form of government which is absolute or irresponsible, and vested in one single person. It is a type of government usually found amongst eastern peoples; amongst more civilized nations the only example is that of Russia, where the sovereign assumes as a title "the autocrat of all the Russias."

AUTO-DA-FÉ, more correctly **AUTO-DE-FÉ** (act of faith), the name of the ceremony during the course of which the sentences of the Spanish inquisition were read and executed. The auto-da-fé was almost identical with the *sermo generalis* of the medieval inquisition. It never took place on a feast day of the church, but on some famous anniversary: the accession of a Spanish monarch, his marriage, the birth of an infant, &c. It was public: the king, the royal family, the grand councils of the kingdom, the court and the people being present. The ceremony comprised a procession in which the members of the Holy Office, with its familiars and agents, the condemned persons and the penitents took part; a solemn mass; an oath of obedience to the inquisition, taken by the king and all the lay functionaries; a sermon by the Grand Inquisitor; and the reading of the sentences, either of condemnation or acquittal, delivered by the Holy Office. The handing over of impenitent persons, and those who had relapsed, to the secular power, and their punishment, did not usually take place on the occasion of an auto-da-fé, properly so called. Sometimes those who were condemned to the flames were burned on the night following the ceremony. The first great auto-da-fés were celebrated when Thomas de Torquemada was at the head of the Spanish inquisition (Seville 1482, Toledo 1486, &c.). The last, subsequent to the time of Charles III., were held in secret; moreover, they dealt with only a very small number of sentences, of which hardly any were capital. The isolated cases of the torturing of a revolutionary priest in Mexico in 1816, and of a relapsed Jew and of a Quaker in Spain during 1826, cannot really be considered as auto-da-fés. (P. A.)

AUTOGAMY (from Gr. *αὐτός*, self, and *γάμια*, marriage), a botanical term for self-fertilization. (See **ANGIOSPERMS**.)

AUTOGENY, AUTOGENOUS (Gr. *αὐτογενής*), spontaneous generation, self-produced. Haeckel distinguished *autogeny* and *plasmogeny*, applying the former term when the formative fluid in which the first living matter was supposed to arise was inorganic and the latter when it was organic, i.e. contained the requisite fundamental substances dissolved in the form of complicated and fluid combinations of carbon. In "autogenous soldering" two pieces of metal are united by the melting of the opposing surfaces, without the use of a separate fusible alloy or solder as a cementing material.

AUTOGRAPHS. Autograph (Gr. *αὐτός*, self, *γράφειν*, to write) is a term applied by common usage either to a document signed by the person from whom it emanates, or to one written entirely by the hand of such person (which, however, is also more technically described as *holograph*, from *ὅλος*, entire, *γράφειν*, to write), or simply to an independent signature.

The existence of autographs must necessarily have been coeval with the invention of letters. Documents in the handwriting of their composers may possibly exist among the early papyri of Egypt and the clay tablets of Babylonia and Assyria, and among the early examples of writing in the East. But the oriental practice of employing professional scribes in writing the body of documents and of using seals for the purpose of "signing" (the "signum" originally meaning the impression of the seal) almost precludes the idea. When we are told (1 Kings xxi. 8) that Jezebel wrote letters in Ahab's name and sealed them with his seal, we are, of course, to understand that the letters were written by the professional scribes and that the impression of the king's seal was the authentication, equivalent to the signature of western nations; and again, when King Darius "signed" the writing and the decree (Dan. vi. 9), he did so with his seal. To find documents which we can

recognize with certainty to be autographs, we must descend to the Ptolemaic and Roman periods of Egyptian history, which are represented by an abundance of papyrus documents of all kinds, chiefly in Greek. Among them are not a few original letters and personal documents, in which we may see the handwriting of many lettered and unlettered individuals who lived during the 3rd century B.C. and in succeeding times, and which prove how very widespread was the practice of writing in those days. We owe it to the dry and even atmosphere of Egypt that these written documents have been preserved in such numbers. On the other hand, in Italy and Greece ancient writings have perished, save the few charred papyrus rolls and waxen tablets which have been recovered from the ruins of Herculaneum and Pompeii. These tablets, however, have a special value, for many of them contain autograph signatures of principals and witnesses to legal deeds to which they were attached, together with impressions of seals, in compliance with the Roman law which required the actual subscriptions, or attested marks, of the persons concerned.

But, when we now speak of autographs and autograph collections, we use such terms in a restricted sense and imply documents or signatures written by persons of some degree of eminence or notoriety in the various ranks and professions of life; and naturally the only early autographs in this sense which could be expected to survive are the subscriptions and signatures of royal personages and great officials attached to important public deeds, which from their nature have been more jealously cared for than mere private documents.

Following the Roman practice, subscriptions and signatures were required in legal documents in the early centuries of our era. Hence we find them in the few Latin deeds on papyrus which have come to light in Egypt; we find them on the well-known Dacian waxen tablets of the 2nd century; and we find them in the series of papyrus deeds from Ravenna and other places in Italy between the 5th and 10th centuries. The same practice obtained in the Frankish empire. The Merovingian kings, or at least those of them who knew how to write, subscribed their diplomas and great charters with their own hands; and their great officers of state, chancellors and others, countersigned in autograph. The unlettered Merovingian kings made use of monograms composed of the letters of their names; and, curiously, the illiterate monogram was destined to supersede the literate subscriptions. For the monogram was adopted by Charlemagne and his successors as a recognized symbol of their subscription. It was their *signum manuale*, their sign manual. In courtly imitation of the royal practice, monograms and other marks were adopted by official personages, even though they could write. The notarial marks of modern times are a survival of the practice. By the illiterate other signs, besides the monogram, came to be employed, such as the cross, &c., as signs manual. The monogram was used by French monarchs from the reign of Charlemagne to that of Philip the Fair, who died in 1314. It is very doubtful, however, whether in any instance this sign manual was actually traced by the monarch's own hand. At the most, the earlier sovereigns appear to have drawn one or two strokes in their monograms, which, so far, may be called their autographs. But in the later period not even this was done; the monogram was entirely the work of the scribe. (See DIPLOMATIC.)

The employment of marks or signs manual went out of general use after the 12th century, in the course of which the affixing or appending of seals became the common method of executing deeds. But, as education became more general and the practice of writing more widely diffused, the usage grew up in the course of the 14th century of signing the name-signature as well as of affixing the seal; and by the 15th century it had become established, and it remains to the present time. Thus the *signum manuale* had disappeared, except among notaries; but the term survived, and by a natural process it was transferred to the signature. In the present day it is used to designate the "sign manual" or autograph signature of the sovereign.

The Anglo-Saxon kings of England did not sign their charters,

their names being invariably written by the official scribes. After the Norman conquest, the sign manual, usually a cross, which sometimes accompanied the name of the sovereign, may in some instances be autograph; but no royal signature is to be found earlier than the reign of Richard II. Of the signatures of this king there are two examples, of the years 1386 and 1389, in the Public Record Office; and there is one, of 1307, in the British Museum. Of his father, the Black Prince, there is in the Record Office a motto-signature, *De par Homont* (high courage), *Ich dese*, subscribed to a writ of privy seal of 1370. The kings of the Lancastrian line were apparently ready writers. Of the handwriting of both Henry IV. and Henry V. there are specimens both in the Record Office and in the British Museum. But by their time writing had become an ordinary accomplishment.

Apart from the autographs of sovereigns, those of famous men of the early middle ages can hardly be said to exist, or, if they do exist, they are difficult to identify. For example, there is a charter at Canterbury bearing the statement that it was written by Dunstan; but, as there is a duplicate in the British Museum with the same statement, it is probable that both the one and the other are copies. The autograph MSS. of the chronicles of Orderic Vitalis, of Robert de Monte, and of Siebert of Gembloux are in existence; and among the Cottonian MSS. there are undoubtedly autograph writings of Matthew of Paris, the English chronicler of Henry III.'s reign. There are certain documents in the British Museum in the hand of William of Wykeham; and among French archives there are autograph writings of the historian Joinville. These are a few instances. When we come to such a collection as the famous Paston Letters, the correspondence of the Norfolk family of Paston of the 15th century, we find therein numerous autographs of historical personages of the time.

From the 16th century onward, we enter the period of modern history, and autograph documents of all kinds become plentiful. And yet in the midst of this plenty, by a perverse fate, there is in certain instances a remarkable dearth. The instance of Shakespeare is the most famous. But for three signatures to the three sheets of his will, and two signatures to the conveyances of property in Blackfriars, we should be without a vestige of his handwriting. For certain other signatures, professing to be his, inscribed in books, may be dismissed as imitations. Such forgeries come up from time to time, as might be expected, and are placed upon the market. The Shakespearean forgeries, however, of W. H. Ireland were perpetrated rather with a literary intent than as an autographic venture.

Had autograph collecting been the fashion in Shakespeare's days, we should not have had to deplore the loss of his and of other great writers' autographs. But the taste had not then come into vogue, at least not in England. The series of autograph documents which were gathered in such a library as that of Sir Robert Cotton, now in the British Museum, found their way thither on account of their literary or historic interest, and not merely as specimens of the handwriting of distinguished men. Such a series also as that formed by Philippe de Béhune, Comte de Selles et Charost, and his son, in the reign of Louis XIV., consisting for the most part of original letters and papers, now in the Bibliothèque Nationale, might have been regarded as the result of autograph collecting did we not know that it was brought together for historical purposes. It was in Germany and the Low Countries that the practice appears to have originated, chiefly among students and other members of the universities, of collecting autograph inscriptions and signatures of one's friends in albums, *alba amicorum*, little oblong pocket volumes of which a considerable number have survived, a very fair collection being in the British Museum. The earliest album in the latter series is the Egerton MS. 1178, beginning with an entry of the year 1554. Once the taste was established, the collecting of autographs of living persons was naturally extended to those of former times; and many collections, famous in their day, have been formed, but in most instances only to be dispersed again as the owners tired of their fancy or as their heirs failed to inherit their tastes along with their

possessions. The most celebrated collection formed in England in recent years is that of the late Mr Alfred Morrison, which still remains intact, and which is well known by means of the sumptuous catalogue, with its many facsimiles, compiled by the owner.

The rivalry of collectors and the high prices which rare or favourite autographs realize have naturally given encouragement to the forger. False letters of popular heroes and of popular authors, of Nelson, of Burns, of Thackeray, and of others, appear from time to time in the market: in some instances clever imitations, but more generally too palpably spurious to deceive any one with experience. Like the Shakespearean forgeries of Ireland, referred to above, the forgeries of Chatterton were literary inventions; and both were poor performances. One of the cleverest frauds of this nature in modern times was the fabrication, in the middle of the 19th century, of a series of letters of Byron and Shelley, with postmarks and seals complete, which were even published as *bona fide* documents (Brit. Mus. Add. MS. 19,377).

There are many published collections of facsimiles of autographs of different nations. Among those published in England the following may be named:—*British Autography*, by J. Thane (1788–1793, with supplement by Daniell, 1854); *Autographs of Royal, Noble, Learned and Remarkable Personages in English History*, by J. G. Nichols (1829); *Facsimiles of Original Documents of Eminent Literary Characters*, by C. J. Smith (1832); *Autographs of the Kings and Queens and Eminent Men of Great Britain*, by J. Netherclift (1835); *One Hundred Characteristic Autograph Letters*, by J. Netherclift and Son (1849); *The Autograph Miscellany*, by F. Netherclift (1855); *The Autograph Souvenir*, by F. G. Netherclift and R. Sims (1865); *The Autographic Mirror* (1864–1866); *The Handbook of Autographs*, by F. G. Netherclift (1862); *The Autograph Album*, by L. B. Phillips (1866); *Facsimiles of Autographs* (British Museum publication), five series (1896–1900). Facsimiles of autographs also appear in the official publications, *Facsimiles of National MSS.*, from *William the Conqueror to Queen Anne* (Master of the Rolls), 1865–1868; *Facsimiles of National MSS. of Scotland* (Lord Clerk Register), 1867–1871; and *Facsimiles of National MSS. of Ireland* (Public Record Office, Ireland), 1874–1884. (E. M. T.)

AUTOLYCUS, in Greek mythology, the son of Hermes and father of Anticleia, mother of Odysseus. He lived at the foot of Mount Parnassus, and was famous as a thief and swindler. On one occasion he met his match. Sisyphus, who had lost some cattle, suspected Autolycus of being the thief, but was unable to bring it home to him, since he possessed the power of changing everything that was touched by his hands. Sisyphus accordingly burnt his name into the hoofs of his cattle, and, during a visit to Autolycus, recognized his property. It is said that on this occasion Sisyphus seduced Autolycus's daughter Anticleia, and that Odysseus was really the son of Sisyphus, not of Laertes, whom Anticleia afterwards married. The object of the story is to establish the close connexion between Hermes, the god of theft and cunning, and the three persons—Sisyphus, Odysseus, Autolycus—who are the incarnate representations of these practices. Autolycus is also said to have instructed Heracles in the art of wrestling, and to have taken part in the Argonautic expedition.

Iliad, x. 267; *Odyssey*, xix. 395; Ovid, *Metam.* xi. 313; Apollodorus i. 9; Hyginus, *Fab.* 201.

AUTOLYCUS OF PITANE, Greek mathematician and astronomer, probably flourished in the second half of the 4th century B.C., since he is said to have instructed Arcesilaus. His extant works consist of two treatises; the one, *Περὶ κωνομέτρων σφαιρῶν*, contains some simple propositions on the motion of the sphere, the other, *Περὶ ἑπιπέδων καὶ διόσεων*, in two books, discusses the rising and setting of the fixed stars. The former treatise is historically interesting for the light it throws on the development which the geometry of the sphere had already reached even before Autolycus and Euclid (see THEODOSIUS OF TRIPOLIS).

There are several Latin versions of Autolycus, a French translation by Forcadel (1572), and an admirable edition of the Greek text with Latin translation by F. Hultsch (Leipzig, 1885).

AUTOMATIC WRITING, the name given by students of psychical research to writing performed without the volition of the agent. The writing may also take place without any consciousness of the words written; but some automatists are

aware of the word which they are actually writing, and perhaps of two or three words on either side, though there is rarely any clear perception of the meaning of the whole. Automatic writing may take place when the agent is in a state of trance, spontaneous or induced, in hystero-epilepsy or other morbid states; or in a condition not distinguishable from normal wakefulness. Automatic writing has played an important part in the history of modern spiritualism. The phenomenon first appeared on a large scale in the early days (c. 1850–1860) of the movement in America. Numerous writings are reported at that period, many of considerable length, which purported for the most part to have been produced under spirit guidance. Some of these were written in "unknown tongues." Of those which were published the most notable are Andrew J. Davis's *Great Harmonia*, Charles Linton's *The Healing of the Nations*, and J. Murray Spear's *Messages from the Spirit Life*.

In England also the early spiritualist newspapers were filled with "inspirational" writing,—*Pages of the Paraclete*, &c. The most notable series of English automatic writings are the *Spirit Teachings* of the Rev. W. Stainton Moses. The phenomenon, of course, lends itself to deception, but there seems no reason to doubt that in the great majority of the cases recorded the writing was in reality produced without deliberate volition. In the earlier years of the spiritualist movement, a "planchette," a little heart-shaped board running on wheels, was employed to facilitate the process of writing.

Of late years, whilst the theory of external inspiration as the cause of the phenomenon has been generally discredited, automatic writing has been largely employed as a method of experimentally investigating subconscious mental processes. Knowledge which had lapsed from the primary consciousness is frequently revealed by this means; e.g. forgotten fragments of poetry or foreign languages are occasionally given. An experimental parallel to this reproduction of forgotten knowledge was devised by Edmund Gurney. He showed that information communicated to a subject in the hypnotic trance could be subsequently reproduced through the handwriting, whilst the attention of the subject was fully employed in conversing or reading aloud; or an arithmetical problem which had been set during the trance could be worked out under similar conditions without the apparent consciousness of the subject.

Automatic writing for the most part, no doubt, brings to the surface only the débris of lapsed memories and half-formed impressions which have never reached the focus of consciousness—the stuff that dreams are made of. But there are indications in some cases of something more than this. In some spontaneous instances the writing produces anagrams, puns, nonsense verses and occasional blasphemies or obscenities; and otherwise exhibits characteristics markedly divergent from those of the normal consciousness. In the well-known case recorded by Th. Flournoy (*Des Indes à la planète Mars*) the automatist produced writing in an unknown character, which purported to be the Martian language. The writing generally resembles the ordinary handwriting of the agent, but there are sometimes marked differences, and the same automatist may employ two or three distinct handwritings. Occasionally imitations are produced of the handwriting of other persons, living or dead. Not infrequently the writing is reversed, so that it can be read only in a looking-glass (*Spiegel-schrift*); the ability to produce such writing is often associated with the liability to spontaneous somnambulism. The hand and arm are often insensible in the act of writing. There are some cases on record in which the automatist has seemed to guide his hand not by sight, but by some special extension of the muscular sense (Carpenter, *Mental Physiology*, § 128; W. James, *Proceedings American S.P.R.* p. 554).

Automatic writing frequently exhibits indications of telepathy. The most remarkable series of automatic writings recorded in this connexion are those executed by the American medium, Mrs Piper, in a state of trance (*Proceedings S.P.R.*). These writings appear to exhibit remarkable telepathic powers, and are thought by some to indicate communication with the spirits of the dead.

The opportunities afforded by automatic writing for communicating with subconscious strata of the personality have been made use of by Pierre Janet and others in cases of hysterical epilepsy, and other forms of dissociation of consciousness. A patient in an attack of hysterical convulsions, to whom oral appeals are made in vain, can sometimes be induced to answer in writing questions addressed to the hand, and thus to reveal the secret of the malady or to accept therapeutic suggestions.

See Edmonds and Dexter, *Spiritualism* (New York, 1853); Epes Sargent, *Planchette, the Despair of Science* (Boston, U.S.A., 1869); Mrs de Morgan, *From Matter to Spirit* (London, 1863); W. Stainton Moses, *Spirit Teachings* (London, 1883); *Proceedings S.P.R. Society*; Th. Flournoy, *Des Indes à la Planète Mars* (Geneva, 1900); F. Podmore, *Modern Spiritualism* (London, 1902); F. W. H. Myers, *Human Personality* (London, 1903); Pierre Janet, *L'Automatisme psychologique* (2nd ed., Paris, 1894); Morton Prince, *The Dissociation of a Personality* (London, 1906). (F. P.)

AUTOMATISM. In philosophical terminology this word is used in two main senses: (1) in ethics, for the view that man is not responsible for his actions, which have, therefore, no moral value; (2) in psychology, for all actions which are not the result of conation or conscious endeavour. Certain actions being admittedly automatic, Descartes maintained that, in regard of the lower animals, all action is purely mechanical. The same theory has since been applied to man, with this difference that, accompanying the mechanical phenomena of action, and entirely disconnected with it, are the phenomena of consciousness. Thus certain physical changes in the brain result in a given action; the concomitant mental desire or volition is in no sense causally connected with, or prior to, the physical change. This theory, which has been maintained by T. Huxley (*Science and Culture*) and Shadworth Hodgson (*Metaphysics of Experience and Theory of Practice*), must be distinguished from that of the psychophysical parallelism, or the "double aspect theory" according to which both the mental state and the physical phenomena result from a so-called "mind stuff," or single substance, the material or cause of both.

Automatic acts are of two main kinds. Where the action goes on while the attention is focused on entirely different subjects (e.g. in cycling), it is purely automatic. On the other hand, if the attention is fixed on the end or on any particular part of a given action, and the other component parts of the action are performed unconsciously, the automatism may be called relative.

See G. F. Stout, *Anal. Psych.* i. 258 foll.; Wm. James, *Princ. of Psych.* i. chap. 5; also the articles PSYCHOLOGY, SUGGESTION, &c.

Sensory Automatism is the term given by students of psychical research to a centrally initiated hallucination. Such hallucinations are commonly provoked by crystal-gazing (*q.v.*), but auditory hallucinations may be caused by the use of a shell (shell-hearing), and the other senses are occasionally affected.

Motor Automatism, on the other hand, is a non-reflex movement of a voluntary muscle, executed in the waking state but not controlled by the ordinary waking consciousness. Phenomena of this kind play a large part in primitive ceremonies of divination (*q.v.*) and in our own day furnish much of the material of Psychical Research. At the lowest level we have vague movements of larger groups of muscles, as in "hier-divination," where the ruderer or his residence is inferred from the actions of the bearers; of a similar character but combined with more specialized action are many kinds of witch seeking. These more specialized actions are most typically seen in the Divining Rod (*q.v.*; see also TABLE-TURNING), which indicates the presence of water and is used among the uncivilized to trace criminals. At a higher stage still we have the delicate movements necessary for Automatic Writing (*q.v.*) or Drawing. A parallel case to Automatic Writing is the action of the speech centres, resulting in the production of all kinds of utterances from trance speeches in the ordinary language of the speaker to mere unintelligible babblings. An interesting form of speech automatism is known as Glossolalia; in the typical case of Helène Smith, Th. Flournoy has shown that these utterances may reach a higher plane and

form a real language, which is, however, based on one already known to the speaker.

See *Man* (1904), No. 68; *Folklore*, xiii. 134; Myers in *Proc. S.P.R.* ix. 26, xii. 277; xv. 403; Flournoy, *Des Indes à la planète Mars* and in *Arch. de Psychologie*; Myers, *Human Personality*. (N. W. T.)

AUTOMATON (from *abros*, self, and *μάωα*, to seize), a self-moving machine, or one in which the principle of motion is contained within the mechanism itself. According to this description, clocks, watches and all machines of a similar kind, are automata, but the word is generally applied to contrivances which simulate for a time the motions of animal life. If the human figure and actions be represented, the automaton has sometimes been called specially an *andrioides*. We have very early notices of the construction of automata, e.g. the tripods of Vulcan, and the moving figures of Daedalus. In 400 B.C., Archytas of Tarentum is said to have made a wooden pigeon that could fly, and during the middle ages numerous instances of the construction of automata are recorded. Regiomontanus is said to have made of iron a fly, which would flutter round the room and return to his hand, and also an eagle, which flew before the emperor Maximilian when he was entering Nuremberg. Roger Bacon is said to have forged a brazen head which spoke, and Albertus Magnus to have had an andrioides, which acted as doorkeeper, and was broken to pieces by Aquinas. Of these, as of some later instances, e.g. the figure constructed by Descartes and the automata exhibited by Dr Camus, not much is accurately known. But in the 18th century, Jacques de Vaucanson, the celebrated mechanician, exhibited three admirable figures,—the flute-player, the tambourine-player, and the duck, which was capable of eating, drinking, and imitating exactly the natural voice of that fowl. The means by which these results had been produced were clearly seen, and a great impulse was given to the construction of similar figures. Knauss exhibited at Vienna an automaton which wrote; a father and son named Droz constructed several ingenious mechanical figures which wrote and played music; Frederick Kaufmann and Leonard Maelzel made automatic trumpeters who could play several marches. The Swiss have always been celebrated for their mechanical ingenuity, and they construct most of the curious toys, such as flying and singing birds, which are frequently met with in industrial exhibitions. The greatest difficulty has generally been experienced in devising any mechanism which shall successfully simulate the human voice (not to be compared with the gramophone, which reproduces mechanically a real voice). No attempt has been thoroughly successful, though many have been made. A figure exhibited by Fabermann of Vienna remains the best. Kempelen's famous chess-player for many years astonished and puzzled Europe. This figure, however, was no true automaton, although the mechanical contrivances for concealing the real performer and giving effect to his desired movements were exceedingly ingenious. J. N. Maskelyne, in more recent times (1875-1880), has been prominent in exhibiting his automata, Psycho (who played cards) and Zoe (who drew pictures), at the Egyptian Hall, London, but the secret of these contrivances was well kept. (See CONJURING.)

AUTOMORPHISM (from *Gr. abros*, self, and *μορφή*, form), the conception and interpretation of other people's habits and ideas on the analogy of one's own.

AUTONOMY (*Gr. abros*, self, and *νόμος*, law), in general, freedom from external restraint, self-government. The term is usually coupled with a qualifying adjective. Thus, political autonomy is self-government in its widest sense, independence of all control from without. Local autonomy is a freedom of self-government within a sphere marked out by some superior authority; e.g. municipal corporations in England have their administrative powers marked out for them by acts of parliament, and in so far as they govern themselves within these limits exercise local autonomy. Administrative or constitutional autonomy, such as exists in the British colonies, implies an extent of self-government which falls short only of complete independence. The term is used loosely even in the case of e.g. religious bodies, individual churches and other communities

which enjoy a measure of self-government in certain specified respects.

In philosophy, the term (with its antithesis "heteronomy") was applied by Kant to that aspect of the rational will in which, *qua* rational, it is a law to itself, independently alike of any external authority, of the results of experience and of the impulses of pleasure and pain. In the sphere of morals, the ultimate and only authority which the mind can recognize is the law which emerges from the pure moral consciousness. This is the only sense in which moral freedom can be understood. (See ETHICS; KANT.) Though the term "autonomy" in its fullest sense implies entire freedom from causal necessity, it can also be used even in determinist theories for relative independence of particular conditions, theological or conventional.

AUTOPSY (Gr. *avros*, self, and *opsis*, sight, investigation), a personal examination, specifically a *post-mortem* ("after death") examination of a dead body, to ascertain the cause of death, &c. The term "necropsy" (Gr. *νεκρός*, corpse) is sometimes used in this sense. (See CORONER and MEDICAL JURISPRUDENCE.)

AUTRAN, JOSEPH (1813-1877), French poet, was born at Marseilles on the 20th of June 1813. In 1832 he addressed an ode to Lamartine, who was then at Marseilles on his way to the East. The elder poet persuaded the young man's father to allow him to follow his poetic bent, and Autran remained from that time a faithful disciple of Lamartine. His best known work is *La Mer* (1835), remodelled in 1852 as *Les Poèmes de la mer*. *Ludibria ventis* (1838) followed, and the success of these two volumes gained for Autran the librarianship of his native town. His other most important work is his *Vie rurale* (1856), a series of pictures of peasant life. The Algerian campaigns inspired him with verses in honour of the common soldier. *Milénach* (1842) describes the heroic defence of that town, and in the same vein is his *Laboureurs et soldats* (1854). Among his other works are the *Paroles de Salomon* (1868), *Épîtres rustiques* (1861), *Sonnets capricieux*, and a tragedy played with great success at the Odéon in 1848, *La Pille d'Eschyle*. A definitive edition of his works was brought out between 1875 and 1881. He became a member of the French Academy in 1868, and died at Marseilles on the 6th of March 1877.

AUTUN, a town of east-central France, capital of an arrondissement in the department of Saône-et-Loire, 62 m. S.W. of Dijon on the Paris-Lyon railway to Nevers. Pop. (1906) 11,927. Autun is pleasantly situated on the slope of a hill at the foot of which runs the Arroux. Its former greatness is attested by many Roman remains, the chief of which are two well-preserved stone gateways, the Porte d'Arroux and the Porte St André, both pierced with four archways and surmounted by arcades. There are also remains of the old ramparts and aqueducts, of a square tower called the Temple of Janus, of a theatre and of an amphitheatre. A pyramid in the neighbouring village of Couhard was probably a sepulchral monument. The chapel of St Nicolas (12th century) contains many of the remains discovered at Autun. The cathedral of St Lazare, once the chapel attached to the residence of the dukes of Burgundy, is in the highest part of the town. It belongs mainly to the 12th century, but the Gothic central tower and the chapels were added in the 15th century by Nicolas Rolin, chancellor of Burgundy, born at Autun. The chief artistic features of the church are the group of the Last Judgment sculptured on the tympanum above the west door, and the painting by Ingres representing the martyrdom of St Symphorien, which took place at Autun in 179. In the cathedral square stands the fountain of St Lazare, a work of the Renaissance. The hôtel Rolin, a house of the 15th century, contains the collections of the "Aeduan literary and scientific society." The hôtel de ville, containing a museum of paintings, the law-court and the theatre are modern buildings. Autun is the seat of a bishopric, of tribunals of first instance and of commerce, and has an ecclesiastical seminary, a communal college and a cavalry school. Among the industries of the town are the extraction of oil from the bituminous schist obtained in the neighbourhood, leather

manufacture, metal-founding, marble-working, and the manufacture of machinery and furniture. Autun is the commercial centre for a large part of the Morvan, and has considerable trade in timber and cattle.

Autun (*Augustodunum*) succeeded Bibracte as capital of the Aedui when Gaul was reorganized by Augustus. Under the Romans, it was a flourishing town, covering double its present extent and renowned for its schools of rhetoric. In the succeeding centuries its prosperity drew upon it the attacks of the barbarians, the Saracens and the Normans. The counts of Autun in 880 became dukes of Burgundy, and the town was the residence of the latter till 1276. It was ravaged by the English in 1379, and, in 1591, owing to its support of the League, had to sustain a siege conducted by Marshal Jean d'Amont, general of Henry IV.

See H. de Fontenay, *Autun et ses monuments* (Autun, 1889).

AUTUNITE, or CALCO-URANITE, a mineral which is one of the "uranium mica," differing from the more commonly occurring torbernite (*q.v.*) or cupro-uranite in containing calcium in place of copper. It is a hydrous uranium and calcium phosphate, $\text{Ca}(\text{UO}_2)_2(\text{PO}_4)_2 \cdot 8\text{H}_2\text{O}$. Though closely resembling the tetragonal torbernite in form, it crystallizes in the orthorhombic system and is optically biaxial. The crystals have the shape of thin plates with very nearly square outline ($89^\circ 17'$ instead of 90°). An important character is the perfect micaceous cleavage parallel to the basal plane, on which plane the lustre is pearly. The colour is sulphur-yellow, and this enables the mineral to be distinguished at a glance from the emerald-green torbernite. Hardness 2-2½; specific gravity 3.05-3.19. Autunite is usually found with pitchblende and other uranium minerals, or with ores of silver, tin and iron; it sometimes coats joint-planes in gneiss and pegmatite. Falkenstein in Saxony, St Symphorien near Autun (hence the name of the species), and St Day in Cornwall are well-known localities for this mineral. (L. J. S.)

AUVERGNE, formerly a province of France, corresponding to the departments of Cantal and Puy-de-Dôme, with the arrondissement of Brioude in Haute-Loire. It contains many mountains volcanic in origin (Plomb du Cantal, Puy de Dôme, Mont Dore), fertile valleys such as that of Limagne, vast pasturelands, and numerous medicinal springs. Up to the present day the population retains strongly-marked Celtic characteristics. In the time of Caesar the *Arverni* were a powerful confederation, the Arvernian Vercingetorix being the most famous of the Gallic chieftains who fought against the Romans. Under the empire *Arvernica* formed part of *Primo Aquitania*, and the district shared in the fortunes of Aquitaine during the Merovingian and Carolingian periods. Auvergne was the seat of a separate countship before the end of the 8th century; the first hereditary count was William the Pious (886). By the marriage of Eleanor of Aquitaine with Henry Plantagenet, the countship passed under the suzerainty of the kings of England, but at the same time it was divided, William VII., called the Young (1145-1168), having been despoiled of a portion of his domain by his uncle William VIII., called the Old, who was supported by Henry II. of England, so that he only retained the region bounded by the Allier and the Coux. It is this district that from the end of the 13th century was called the *Dauphiné d'Auvergne*. This family quarrel occasioned the intervention of Philip Augustus, king of France, who succeeded in possessing himself of a large part of the country, which was annexed to the royal domains under the name of *Terre d'Auvergne*. As the price of his concurrence with the king in this matter, the bishop of Clermont, Robert I. (1195-1227), was granted the lordship of the town of Clermont, which subsequently became a countship. Such was the origin of the four great historic lordships of Auvergne. The *Terre d'Auvergne* was first an appanage of Count Alphonse of Poitiers (1241-1271), and in 1360 was erected into a duchy in the peerage of France (*duché-pairie*) by King John II. in favour of his son John, through whose daughter the new title passed in 1416 to the house of Bourbon. The last duke, the celebrated constable Charles of Bourbon, united the domains of the *Dauphiné* to those of the

duchy, but all were confiscated by the crown in consequence of the sentence which punished the constable's treason in 1527. The countyship, however, had passed in 1422 to the house of La Tour, and was not annexed to the domain until 1615. The administration of the royal province of Auvergne was organized under Louis XIV. At the time of the revolution it formed what was called a "government," with two divisions: Upper Auvergne (Aurillac), and Lower Auvergne (Clermont).

BIBLIOGRAPHY.—Baluze, *Histoire généalogique de la maison d'Auvergne* (1708); André Imberdis, *Histoire générale de l'Auvergne* (1867); J. B. M. Bielawski, *Histoire de la comté d'Auvergne et de sa capitale Vie-le-Comte* (1868); B. Gonot, *Catalogue des ouvrages imprimés et manuscrits concernant l'Auvergne* (1849). See further Chevalier, *Répertoire des sources hist.*, *Topobibliographie*, s.v.

AUXANOMETER (Gr. *αὐξάνειν*, to increase, *μέτρον*, measure), an apparatus for measuring increase or rate of growth in plants.

AUXENTIUS (fl. c. 370), of Cappadocia, an Arian theologian of some eminence (see ARIUS). When Constantine deposed the orthodox bishops who resisted, Auxentius was installed into the seat of Dionysius, bishop of Milan, and came to be regarded as the great opponent of the Nicene doctrine in the West. So prominent did he become, that he was specially mentioned by name in the condemnatory decree of the synod which Damasus, bishop of Rome, urged by Athanasius, convened in defence of the Nicene doctrine (A.D. 369). When the orthodox emperor Valentinian ascended the throne, Auxentius was left undisturbed in his diocese, but his theological doctrines were publicly attacked by Hilary of Poitiers.

The chief source of information about him is the *Liber contra Auxantium* in the Benedictine edition of the works of Hilary.

AUXERRE, a town of central France, capital of the department of Yonne, 38 m. S.E. of Sens on the Paris-Lyon railway, between Larochefort and Nevers. Pop. (1906) 16,971. It is situated on the slopes and the summit of an eminence on the left bank of the Yonne, which is crossed by two bridges leading to suburbs on the right bank. The town is irregularly built and its streets are steep and narrow, but it is surrounded by wide tree-lined boulevards, which have replaced the ancient fortifications, and has some fine churches. That of St Étienne, formerly the cathedral, is a majestic Gothic building of the 13th to the 16th centuries. It is entered by three richly sculptured portals, over the middle and largest of which is a rose window; over the north portal rises a massive tower, but that which should surmount the south portal is unfinished. The lateral entrances are sheltered by tympana and arches profusely decorated with statuettes. The plan consists of a nave, with aisles and lateral chapels, transept and choir, with a deambulatory at a slightly lower level. Beneath the choir, which is a fine example of early Gothic architecture, extends a crypt of the 11th century with mural paintings of the 12th century. The church has some fine stained glass and many pictures and other works of art. The ancient episcopal palace, now used as prefecture, stands behind the cathedral; it preserves a Romanesque gallery of the 12th century. The church of St Eusèbe belongs to the 12th, 13th and 16th centuries. Of the abbey church of St Germain, built in the 13th and 14th centuries, most of the nave has disappeared, so that its imposing Romanesque tower stands apart from it; crypts of the 9th century contain the tombs of bishops of Auxerre. The abbey was once fortified and a high wall and cylindrical tower remain. The buildings (18th century) are partly occupied by a hospital and a training-college. The church of St Pierre, in the Renaissance style of the 16th and 17th centuries, is conspicuous for the elaborate ornamentation of its west façade. The old law-court contains the museum, with a collection of antiquities and paintings, and a library. In the middle of the town is a gateway surmounted by a belfry, dating from the 15th century. Auxerre has statues of Marshal Davout, J. B. J. Fourier and Paul Bert, the two latter natives of the town. The town is the seat of a court of assizes, and has tribunals of first instance and of commerce, and a branch of the Bank of France. A lycée for girls, a communal college and training colleges are among its educational establishments. Manufactures of ochre, of which there are quarries in the vicinity, and of iron goods are carried on. The

canal of Nivernais reaches as far as Auxerre, which has a busy port and carries on boat-building. Trade is principally in the choice wine of the surrounding vineyards, and in timber and coal.

Auxerre (*Autessiodurum*) became the seat of a bishop and a civitas in the 3rd century. Under the Merovingian kings the abbey of St Germain, named after the 6th bishop, was founded, and in the 9th century its schools had made the town a seat of learning. The bishopric was suppressed in 1790.

The countyship of Auxerre was granted by King Robert I. to his son-in-law Renaud, count of Nevers. It remained in the house of Nevers until 1184, when it passed by marriage to that of Courtenay. Other alliances transferred it successively to the families of Donzy, Châtillon, Bourbon and Burgundy. Alice of Burgundy, countess of Auxerre, married John of Châlons (d. 1309), and several counts of Auxerre belonging to the house of Châlons distinguished themselves in the wars against the English during the 14th century. John II., count of Auxerre, was killed at the battle of Crécy (1346), and his grandson, John IV., sold his countyship to King Charles V. in 1370.

AUXILIARY (from Lat. *auxilium*, help), that which gives aid or support; the term is used in grammar of a verb which completes the tense, mood or voice of another verb; in engineering, e.g. of the low steam power used to supplement the sail-power in sailing ships, still occasionally used in yachts, sealers or whalers; and in military use, of foreign or allied troops, more properly of any troops not permanently maintained under arms. In the British army the term "Auxiliary Forces" was employed formerly to include the Militia, the Imperial Yeomanry and the Volunteers.

AUXIMUM (mod. *Osimo*), an ancient town in Picenum, situated on an isolated hill 8 m. from the Adriatic, on the road from Ancona to Nuceria. It was selected by the Romans as a fortress to protect their settlements in northern Picenum, and strongly fortified in 174 B.C. The walls erected at that period, of large rectangular blocks of stone, still exist in great part. Auximum became a colony at latest in 157 B.C. It often appears in the history of the civil wars, owing to its strong position. Pompey was its patron, and intended that Caesar should find resistance here in 49 B.C. It appears to have been a place of some importance in imperial times, as inscriptions and the monuments of its forum (the present piazza) show. In the 6th century it is called by Procopius the chief town of Picenum, Ancona being spoken of as its harbour. (T. As.)

AUXONNE, a town of eastern France, in the department of Côte d'Or, 19 m. E.S.E. of Dijon on the Paris-Lyon railway to Belfort. Pop. (1906) 2766 (town); 6307 (commune). Auxonne is a quiet town situated in a wide plain on the left bank of the Saône. It preserves remains of ramparts, a stronghold of the 16th century flanked by cylindrical towers, and a sculptured gateway of the 15th century. Vauban restored these works in the latter half of the 17th century, and built the arsenal now used as a market. The church of Notre-Dame dates from the 14th century. Of the two towers surmounting its triple porch only that to the south is finished. A lofty spire rises above a third tower over the crossing. The hôtel de ville (15th century) and some houses of the Renaissance period are also of architectural interest. A statue of Napoleon I. as a sub-lieutenant commemorates his sojourns in the town from 1788 to 1791. Auxonne has a tribunal of commerce and a communal college. Its industries are unimportant, but it has a large trade in the vegetables produced by the numerous market gardens in the vicinity.

Auxonne, the name of which is derived from its position on the Saône (*ad Sonam*), was in the middle ages chief place of a countyship, which in the first half of the 13th century passed to the dukes of Burgundy. The town received a charter in 1229 and derived some importance from the mint which the dukes of Burgundy founded in it. It was invested by the allies in 1814, and surrendered to an Austrian force in the following year.

AVA, the ancient capital of the Burman empire, now a subdivision of the Sagaing district in the Sagaing division of Upper Burma. It is situated on the Irrawaddy on the opposite

bank to Sagaing, with which it was amalgamated in 1889. Amarapura, another ancient capital, lies 5 m. to the north-east of Ava, and Mandalay, the present capital, 6 m. to the north. The classical name of Ava is Yadanapura, "the city of precious gems." It was founded by Thadomin Payā in A.D. 1364 as successor to Pagān, and the religious buildings of Pagān were to a certain extent reproduced here, although on nothing like the same scale as regards either size or splendour. It remained the seat of government for about four centuries with a succession of thirty kings. In 1782 a new capital, Amarapura, was founded by Bodaw Payā, but was deserted again in favour of Ava by King Baggidaw in 1823. On his deposition by King Tharawaddi in 1837, the capital reverted to Amarapura; but finally in 1860 the last capital of Mandalay was occupied by King Mindōn. For picturesque beauty Ava is unequalled in Burma, but it is now more like a park than the site of an old capital. Traces of the great council chamber and various portions of the royal palace are still visible, but otherwise the secular buildings are completely destroyed; and most of the religious edifices are also dilapidated.

AVADĀNA, the name given to a type of Buddhist romance literature represented by a large number of Sanskrit (Nepalese) collections, of which the chief are the *Avadānasataka* (Century of Legends), and the *Divyāvadāna* (The Heavenly Legend). Though of later date than most of the canonical Buddhist books, they are held in veneration by the orthodox, and occupy much the same position with regard to Buddhism that the Purānas do towards Brahminism.

AVAHĪ, the native name of a Malagasy lemur (*Avahis laniger*) nearly allied to the indri (*g.g.*), and the smallest representative of the subfamily *Indrisinae*, characterized by its woolly coat, and measuring about 28 in. in length, of which rather more than half is accounted for by the tail. Unlike the other members of the group, the avahis is nocturnal, and does not associate in small troops, but is met with either alone or in pairs. Very slow in its movements, it rarely descends to the ground, but, when it does, walks upright like the other members of the group. It is found throughout the forests which clothe the mountains on the east coast of Madagascar, and also in a limited district on the north-west coast, the specimens from the latter locality being of smaller size and rather different in colour. The eastern phase is generally rusty red above, with the inner sides of the limbs white; while the predominant hue in the western form is usually yellowish brown. (See PRIMATES.) (R. L. *)

AVALANCHE (adopted from a French dialectic form, *avalanche*, descent), a mass of snow and ice mingled with earth and stones, which rushes down a mountain side, carrying everything before it, and producing a strong wind which uproots trees on each side of its course. Where the supply of snow exceeds the loss by evaporation the surplus descends the mountain sides, slowly in the form of glaciers, or suddenly in ice-falls or in avalanches. A mass of snow may accumulate upon a steep slope and become compacted into ice by pressure, or remain loosely aggregated. When the foundation gives way, owing to the loosening effect of spring rains or from any other cause, the whole mass slides downward. A very small cause will sometimes set a mass of overloaded snow in motion. Thunder or even a loud shout is said to produce this effect when the mass is just poised, and Swiss guides often enjoin absolute silence when crossing dangerous spots.

AVALLON, a town of central France, capital of an arrondissement in the department of Yonne, 34 m. S.S.E. of Auxerre on a branch of the Paris-Lyon railway. Pop. (1906) 5197. The town, with wide streets and picturesque promenades, is finely situated on a promontory, the base of which is washed on the south by the Cousin, on the east and west by small streams. Its chief building, the church of St Lazare, dates from the 12th century. The two western portals are adorned with sculpture in the ornate Romanesque style; the tower on the left of the façade was rebuilt in the 17th century. The Tour de L'Horloge, pierced by a gateway through which passes the Grande Rue, is a 15th century structure containing a museum on its second floor. Remains of the ancient fortifications, including seven of

the flanking towers, are still to be seen. Avallon has a statue of Vauban, the military engineer. The public institutions include the subprefecture, a tribunal of first instance, and a communal college. The manufacture of biscuits and gingerbread, and of leather and farm implements is carried on, and there is considerable traffic in wood, wine, and the live-stock and agricultural produce of the surrounding country.

Avallon (*Aballo*) was in the middle ages the seat of a viscounty dependent on the duchy of Burgundy, and on the death of Charles the Bold passed under the royal authority.

AVALLON (also written **AVALLON**, **AVOLLON**, **AVLILON** and **AVELION**), in Welsh mythology the kingdom of the dead, afterwards an earthly paradise in the western seas, and finally, in the Arthurian romances, the abode of heroes to which King Arthur was conveyed after his last battle. In Welsh the name is *Ynys yr Afallon*, usually interpreted "Isle of Apples," but possibly connected with the Celtic tradition of a king over the dead named *Avallac* (in Welsh *Afallach*). If the traditional derivation is correct, the name is derived from the Welsh *afal*, an apple, and, as no other large fruit was well known to the races of northern Europe, is probably intended to symbolize the feasting and enjoyments of elysium. Other forms of the name are *Ynysvitrin* and *Ynysgutrinn*, "Isle of Glass"—which appear to be identical with *Glaserberg*, the Teutonic kingdom of the dead. Perhaps owing to a confusion between *Glaserberg* or *Ynysvitrin* and the Anglo-Saxon *Glaestinga-burh*, *Glastonbury*, the name "Isle of Avalon" was given to the low ridge in central Somersetshire which culminates in *Glastonbury Tor*, while *Glastonbury* itself came to be called *Avalon*. Attempts have also been made to identify *Avalon* with other places in England and Wales.

See *Studies in the Arthurian Legend*, by J. Rhys (Oxford, 1891); also **ARTHUR (KING)**; **ATLANTIS**.

AVARAY, a French territorial title belonging to a family some of whose members have been conspicuous in history. The Bérnaise family named Bésiade moved into the province of Orléanais in the 17th century, and there acquired the estate of Avaray. In 1667 Théophile de Bésiade, marquis d'Avaray, obtained the office of grand baillif of Orleans, which was held by several of his descendants after him. Claude Antoine de Bésiade, marquis d'Avaray, was deputy for the bailliage of Orleans in the states-general of 1789, and proposed a *Declaration of the Duties of Man* as a pendant to the *Declaration of the Rights of Man*; he subsequently became a lieutenant-general in 1814, a peer of France in 1815, and duc d'Avaray in 1818. Antoine Louis François, comte d'Avaray, son of the above, distinguished himself during the Revolution by his devotion to the comte de Provence, afterwards Louis XVIII., whose emigration he assisted. Having nominally become king in 1799, that prince created the estate of Ile-Jourdain a duchy, under the title of Avaray, in favour of the comte d'Avaray, whom he termed his "liberator." (M. P. *)

AVARS, or **AVARI**, an East Caucasian people, the most renowned of the Lesghian tribes, inhabiting central Daghestan (see **LESGHIAN**). They are the only Lesghian tribe who possess a written language, for which they make use of the Arabic characters. They are often confused with the Avars whose empire on the Danube was broken by Charlemagne; but Komarov asserts that they are of more recent origin as a tribe, their name being Lowland Turki for "vagrant" or "refugee."

AVATAR, a Sanskrit word meaning "descent," specially used in Hindu mythology (and so in English) to express the incarnation of a deity visiting the earth for any purpose. The ten Avatars of Vishnu are the most famous. The Hindus believe he has appeared (1) as a fish, (2) as a tortoise, (3) as a hog, (4) as a monster, half man half lion, to destroy the giant Iranian, (5) as a dwarf, (6) as Rāma, (7) again as Rāma for the purpose of killing the thousand-armed giant *Cartasuciriargunan*, (8) as Krishna, (9) as Buddha. They allege that the tenth Avatar has yet to occur and will be in the form of a white-winged horse (*Kalki*) who will destroy the earth.

AVEBURY, JOHN LUBBOCK, 1ST BARON (1834—), English banker, politician and naturalist, was born in London

on the 30th of April 1834, the son of Sir John William Lubbock, 3rd baronet, himself a highly distinguished man of science. John Lubbock was sent to Eton in 1845; but three years later was taken into his father's bank, and became a partner at twenty-two. In 1865 he succeeded to the baronetcy. His love of science kept pace with his increasing participation in public affairs. He served on commissions upon coinage and other financial questions; and at the same time acted as president of the Entomological Society and of the Anthropological Institute. Early in his career several banking reforms of great importance were due to his initiative, while such works as *Prehistoric Times* (1865) and *The Origin of Civilisation* (1870) were proceeding from his pen. In 1870, and again in 1874, he was elected a member of parliament for Maidstone. He lost the seat at the election of 1880; but was at once elected member for London University, of which he had been vice-chancellor since 1872. He carried numerous enactments in parliament, including the Bank Holidays Act 1871, and bills dealing with absconding debtors, shop hours regulations, public libraries, open spaces, and the preservation of ancient monuments, and he proved himself an indefatigable and influential member of the Unionist party. A prominent supporter of the Statistical Society, he took an active part in criticizing the encroachment of municipal trading and the increase of the municipal debt. He was elected the first president of the Institute of Bankers in 1879; in 1881 he was president of the British Association, and from 1881 to 1886 president of the Linnean Society. He received honorary degrees from the universities of Oxford, Cambridge (where he was Rede lecturer in 1886), Edinburgh, Dublin and Würzburg; and in 1878 was appointed a trustee of the British Museum. From 1888 to 1892 he was president of the London Chamber of Commerce; from 1889 to 1890 vice-chairman and from 1890 to 1892 chairman of the London County Council. During the same period he served on royal commissions on education and on gold and silver. In 1890 he was appointed a privy councillor; and was chairman of the committee of design on the new coinage in 1891. In 1900 he was raised to the peerage, under the title of Baron Avebury, and he continued to play a leading part in public life, not only by the weight of his authority on many subjects, but by the readiness with which he lent his support to movements for the public benefit. Among other matters he was a prominent advocate of proportional representation. As an original author and a thoughtful popularizer of natural history and philosophy he had few rivals in his day, as is evidenced by the number of editions issued of many of his writings, among which the most widely-read have been: *The Origin and Metamorphoses of Insects* (1873), *British Wild Flowers* (1875), *Ants, Bees and Wasps* (1882), *Flowers, Fruit and Leaves* (1886), *The Pleasures of Life* (1887), *The Senses, Instincts and Intelligence of Animals* (1888), *The Beauties of Nature* (1892), *The Use of Life* (1894).

AVEBURY, a village in the Devizes parliamentary division of Wiltshire, England, on the river Kennet, 8 m. by road from Marlborough. The fine church of St James contains an early font with Norman carving, a rich Norman doorway, a painted rearedos, and a beautiful old roodstone in good preservation. Avebury House is Elizabethan, with a curious stone dovecot. The village has encroached upon the remains of a huge stone circle (not quite circular), surrounded by a ditch and rampart of earth, and once approached by two avenues of monoliths. Within the larger circle were two smaller ones, placed not in the axis of the great one but on its north-eastern side, each of which consisted of a double concentric ring of stones; the centre being in one case a menhir or pillar, in the other a dolmen or tablestone resting on two uprights. Few traces remain, as the monoliths have been largely broken up for building purposes. The circle is the largest specimen of primitive stone monuments in Britain, measuring on the average 1200 ft. in diameter. The stones are all the native Sarsens which occur everywhere in the district, and show no evidence of having been hewn. Those still remaining vary in size from 5 to 20 ft. in height above ground, and from 3 to 12 ft. in breadth. As in the case of Stonehenge,

the purpose for which the Avebury monument was erected has been the source of much difference of opinion among antiquaries, Dr Stukely (*Stonehenge a Temple restored to the British Druids*, 1740) regarding it as a Druidical temple, while Fergusson (*Rude Stone Monuments*, 1872) believed that it, as well as Silbury Hill, marks the site of the graves of those who fell in the last Arthurian battle at Badon Hill (A.D. 520). The majority of antiquaries, however, see no reason for dissociating its chronological horizon from that of the numerous other analogous monuments found in Great Britain, many of which have been shown to be burial places of the Bronze Age. Excavations were carried out here in 1908, but without throwing any important new light on the monument.

There are many barrows on the neighbouring downs, besides traces of a double oval of monoliths on Hackpen Hill, and the huge mound of Silbury Hill. Waden Hill, to the south, has been, like Badbury, identified with Badon Hill, which was the traditional scene of the twelfth and last great battle of King Arthur in 520. The Roman road from Winchester to Bath skirts the south side of Silbury Hill.

At the time of the Domesday Survey, the church of Avebury (Avreberic, Abury), with two hides attached, was held in chief by Rainbold, a priest, and was bestowed by Henry III. to the abbot and monks of Cirencester, who continued to hold it until the reign of Henry VIII. The manor of Avebury was granted in the reign of Henry I. to the Benedictine monks of St George of Boucherville in Normandy, and a cell from that abbey was subsequently established here. In consequence of the war with France in the reign of Edward III., this manor was annexed by the crown, and was conferred on the newly founded college of New College, Oxford, together with all the possessions, spiritual and temporal, of the priory.

AVEIA, an ancient town of the Vestini, on the Via Claudia Nova, 6 m. S.E. of Aquila, N.E. of the modern village of Fossa. Some remains of ancient buildings still exist, and the name Aveia still clings to the place. The identification was first made by V. M. Giovenazzi, *Della Città di Aveia nei Vestini* (Rome, 1773). Paintings in the church of S. Maria ad Cryptas, of the 12th to 15th centuries, are important in the history of art. An inscription of a *stationarius* of the 3rd century, sent here on special duty (no doubt for the suppression of brigandage), was found here in 1902 (A. von Domaszewski, *Röm. Mitt.*, 1902, 330).

AVEIRO, a seaport, episcopal see, and the capital of an administrative district, formerly included in the province of Beira, Portugal; on the river Vouga, and the Lisbon-Oporto railway. Pop. (1900) 9970. Aveiro is built on the southern shore of a marshy lagoon, containing many small islands, and measuring about 15 m. from north to south, with an average breadth of about 1 m. The Barra Nova, an artificial canal about 33 ft. deep, was constructed between 1801 and 1808, and gives access to the Atlantic ocean. The local industries include the preparation of sea-salt, the catching and curing of fish, especially sardines and oysters, and the gathering of aquatic plants (*molico*). There is also a brisk trade in wine, oil and fruit; while the Aveiro district contains copper and lead mines, besides much good pasture-land.

Aveiro is probably the Roman Talabriga. In the 16th century it was the birthplace of João Afonso, one of the first navigators to visit the fishing-grounds of Newfoundland; and it soon became famous for its fleet of more than sixty vessels, which sailed yearly to that country, and returned laden with dried codfish. During the same century the cathedral was built, and the city was made a duchy. The title "duke of Aveiro" became extinct when its last holder, Dom José Mascarenhas e Lancaster, was burned alive for high treason, in 1750. The administrative district of Aveiro coincides with the north-western part of the province of Beira; pop. (1900) 303,169; area, 1065 sq. m.

AVELLA (anc. *Abella*), a city of Campania, Italy, in the province of Avellino, 23 m. N.E. of Naples by rail. Pop. (1901) 4107. It is finely situated in fertile territory and its nuts (*nucis Abellanæ*) and fruit were renowned in Roman days. About 2 m. to the north-east lies Avella Vecchia, the ancient Abella, regarded

by the ancients as a Chalcidian colony. An important Oscan inscription relates to a treaty with Nola, regarding a joint temple of Hercules, attributable to the 2nd century B.C. Under the early empire it had already become a colony and had perhaps been one since the time of Sulla. It has remains of the walls of the citadel and of an amphitheatre, and lay on the road from Nola to Abellinum, which was here perhaps joined by a branch from Suessula.

See J. Beloch, *Campanien* (2nd ed., Breslau, 1890), 411 seq. (T. As.)

AVELLINO, a city and episcopal see of Campania, Italy, the capital of the province of Avellino, 1,150 ft. above sea-level, 28 m. direct and 39 m. by rail E.N.E. of Naples, at the foot of Monte Vergine. Pop. (1901) 23,760. There are ruins of the castle constructed in the 9th or 10th century, in which the antipope Anacletus II. crowned Count Roger II. king of Sicily and Apulia. Avellino is the junction of lines to Benevento and Rocchetta S. Antonio. The name is derived from the ancient Abellinum, the ruins of which lie $2\frac{1}{2}$ m. north-east, close to the village of Atripalda, and consist of remains of city walls and an amphitheatre in *opus reticulatum*, i.e. of the early imperial period, when Abellinum appears to have been the chief place of a tribe, to which belonged also the independent communities of the *Abellinates cognomine Protopri* among the Hirpini, and the *Abellinates cognominati Marsi* among the Apulians (Nissen, *Italische Landeskunde*, ii. 822). It lay on the boundary of Campania and the territory of the Hirpini, at the junction of the roads from Nola (and perhaps also from Suessula) and Salernum to Beneventum.

The Monte Vergine (4,165 ft.) lies 4 m. to the N.W. of Avellino; upon the summit is a sanctuary of the Virgin, founded in 1119, which contains a miraculous picture attributed to S. Luke (the greatest festival is on the 8th of September). The present church is baroque in style, but contains some works of art of earlier periods. The important archives have been transported to Naples.

(T. As.)

AVEMPACE [Abu Bakr Muhammad ibn Yahya, known as Ibn Bājija or Ibn Šā'igh, i.e. son of the goldsmith, the name being corrupted by the Latins into Avempace, Avenpace or Aben Pace], the earliest and one of the most distinguished of the Arab philosophers of Spain. Little is known of the details of his life. He was born probably at Saragossa towards the close of the 11th century. According to Ibn Khāqān, a contemporary writer, he became a student of the exact sciences and was also a musician and a poet. But he was a philosopher as well, and apparently a sceptic. He is said to have rejected the Koran, to have denied the return to God, and to have regarded death as the end of existence. But even in that orthodox age he became vizier to the amir of Murcia. Afterwards he went to Valencia, then to Saragossa. After the fall of Saragossa (1119) he went to Seville, then to Xativa, where he is said to have returned to Islam to save his life. Finally he retired to the Almoravid court at Fez, where he was poisoned in 1138. Ibn 'Usaibi 'a gives a list of twenty-five of his works, but few of these remain. He had a distinct influence upon Averroes (see ARABIAN PHILOSOPHY).

For his life see M.G. de Slane's trans. of Ibn Khallikān's *Biographical Dictionary* (Paris and London, 1842), vol. iii. pp. 130 ff., and Ibn 'Usaibi 'a's biography translated in P. de Gayangos' edition of the *History of the Mohammedan Dynasties in Spain*, by al-Maqqari (London, 1840), vol. ii., appendix, p. xii. List of extant works in C. Brockelmann's *Geschichte der arabischen Literatur*, vol. i. p. 460. For his philosophy cf. T. J. de Boer's *The History of Philosophy in Islam* (London, 1903), ch. vi. (G. W. T.)

AVENARIUS, RICHARD HEINRICH LUDWIG (1843-1896), German philosopher, was born in Paris on the 19th of November 1843. His education, begun in Zürich and Berlin, was completed at the university of Leipzig, where he graduated in 1876. In 1877 he became professor of philosophy in Zürich, where he died on the 18th of August 1896. At Leipzig he was one of the founders of the *Abademsich-philosophische Verein*, and was the first editor of the *Vierteljahrsschrift für wissenschaftliche Philosophie*. In 1868 he published an essay on the Pantheism of Spinoza. His chief works are *Philosophie als Denken der Welt gemäss dem Princip des kleinsten Kraftmasses* (1876) and the

Kritik der reinen Erfahrung (1888-1890). In these works he made an attempt to co-ordinate thought and action. Like Mach, he started from the principle of economy of thinking, and in the *Kritik* endeavoured to explain pure experience in relation to knowledge and environment. He discovers that statements dependent upon environment constitute pure experience. This philosophy, called Empirio-criticism, is not, however, a realistic but an idealistic dualism, nor can it be called materialism. See Wundt, *Philos. Stud.* xiii. (1897); Carstanjen and Willy in *Zeitsch. f. wiss. Philos.* xx. (1896), 361 ff.; xx. 57 ff.; xxii. 53 ff.; J. Petzoldt's *Einführung in d. Philos. d. reinen Erfahrung* (1900).

AVENGERS OF BLOOD, the person, usually the nearest kinsman of the murdered man, whose duty it was to avenge his death by killing the murderer. In primitive societies, before the evolution of settled government, or the uprise of a systematized criminal law, crimes of violence were regarded as injuries of a personal character to be punished by the sufferer or his kinsfolk. This right of vengeance was common to most countries, and in many was the subject of strict regulations and limitations. It was prevented from running into excesses by the law of sanctuary (*q.v.*) and in many lands the institution of blood-money, and the *wergild* offered the wrong-doer a mode of escaping from his enemies' revenge. The Mosaic law recognized the right of vengeance, but not the money-compensation. The Koran, on the contrary, while sanctioning the vengeance, also permits pecuniary commutation for murder.

AVENGERS, or **VENDICATORI**, a secret society formed about 1186 in Sicily to avenge popular wrongs. The society was finally suppressed by King William II., the Norman, who hanged the grand master and branded the members with hot irons.

AVANTAIL, or **AVANTAILLE** (O. Fr. *essentail*, presumably from a Latin word *aventaculum*, air-hole), the mouthpiece of an old-fashioned helmet, movable to admit the air.

AVENTINUS (1477-1534), the name taken by JOHANN TURMAIR, author of the *Annales Botorum*, or *Annals of Bavaria*, from Aventinum, the Latin name of the town of Abensberg, where he was born on the 4th of July 1477. Having studied at Ingolstadt, Vienna, Cracow and Paris, he returned to Ingolstadt in 1507, and in 1509 was appointed tutor to Louis and Ernest, the two younger sons of Albert the Wise, the late duke of Bavaria-Munich. He retained this position until 1517, wrote a Latin grammar, and other manuals for the use of his pupils, and in 1515 travelled in Italy with Ernest. Encouraged by William IV., duke of Bavaria, he began to write the *Annales Botorum*, about 1517, and finishing this book in 1521, undertook a German version of it, entitled *Bayerische Chronik*, which he completed some years later. He assisted to found the *Sodalitas litteraria Angilostadensis*, under the auspices of which several old manuscripts were brought to light. Although Aventinus did not definitely adopt the reformed faith, he sympathized with the reformers and their teaching, and showed a strong dislike for the monks. On this account he was imprisoned in 1528, but his friends soon effected his release. The remainder of his life was somewhat unsettled, and he died at Regensburg on the 9th of January 1534. The *Annales*, which are in seven books, deal with the history of Bavaria in conjunction with general history from the earliest times to 1460, and the author shows a strong sympathy for the Empire in its struggle with the Papacy. He took immense pains with his work, and to some degree anticipated the modern scientific method of writing history. The *Annales* were first published in 1554, but many important passages were omitted in this edition, as they reflected on the Roman Catholics. A more complete edition was published at Basel in 1580 by Nicholas Ciser. Aventinus, who has been called the "Bavarian Herodotus," wrote other books of minor importance, and a complete edition of his works was published at Munich (1881-1886). More recently a new edition (six vols.) has appeared.

See T. Wiedemann, *Johann Turmair gen. Aventinus* (Freising, 1858); W. Dittmar, *Aventin* (Nördlingen, 1862); J. von Döllinger, *Aventin und seine Zeit* (Munich, 1877); S. Riezler, *Zum Schicksal der neuesten Edition von Aventins Annales* (Munich, 1886); F. X. von Wegele, *Aventin* (Bamberg, 1890).

AVENTURINE, or AVANTURINE, a variety of quartz containing spangles of mica or scales of iron-oxide, which confer brilliancy on the stone. It is found chiefly in the Ural Mountains, and is cut for ornamental purposes at Ekaterinburg. Some of the Siberian aventurine, like that of the vase given by Nicholas I. to Sir R. Murchison, in 1843, is a micaceous iron-stained quartz, of but little beauty. Most aventurine is of reddish brown or yellow colour, but a green variety, containing scales of fuchsite or chrome-mica, is also known. This green aventurine, highly valued by the Chinese, is said to occur in the Bellary district in India.

Aventurine felspar, known also as Sun-stone (*g.s.*) is found principally at Tvedestrand in south Norway, and is a variety of oligoclase enclosing micaceous scales of haematite. Other kinds of felspar, even orthoclase, may however also show the aventurine appearance. Both plagioclastic and orthoclastic aventurine occur at several localities in the United States.

The mineral aventurine takes its name from the well-known aventurine-glass of Venice. This is a reddish brown glass with gold-like spangles, more brilliant than most of the natural stone. The story runs that this kind of glass was originally made accidentally at Murano by a workman, who let some copper filings fall into the molten "metal," whence the product was called *aventurino*. From the Murano glass the name passed to the mineral, which displayed a rather similar appearance. (F. W. R.)*

AVENUE (the past participle feminine of Fr. *ouvrir*, to come to), a way of approach; more particularly, the chief entrance-road to a country house, with rows of trees on each side; the trees themselves are said to form the avenue. In modern times the word has been much used as a name for streets in towns, whether with or without trees, such as Fifth Avenue in New York, or Shaftesbury Avenue in London.

AVENZOAR, or ABUMERON [Abū Merwān 'Abdal-Malik ibn Zuhri], Arabian physician, who flourished at the beginning of the 12th century, was born at Seville, where he exercised his profession with great reputation. His ancestors had been celebrated as physicians for several generations, and his son was afterwards held by the Arabians to be even more eminent in his profession than Avenzoar himself. He was a contemporary of Averroes, who, according to Leo Africanus, heard his lectures, and learned physic of him. He belonged, in many respects, to the *Dogmatists* or *Rational School*, rather than to the *Empirics*. He was a great admirer of Galen; and in his writings he protests emphatically against quackery and the superstitious remedies of the astrologers. He shows no inconsiderable knowledge of anatomy in his remarkable description of inflammation and abscess of the mediastinum in his own person, and its diagnosis from common pleuritis as well as from abscess and dropsy of the pericardium. In cases of obstruction or of palsy of the gullet, his three modes of treatment are ingenious. He proposes to support the strength by placing the patient in a tepid bath of nutritious liquids, that might enter by cutaneous imbibition, but does not recommend this. He speaks more favourably of the introduction of food into the stomach by a silver tube; and he strongly recommends the use of nutritive enemata. From his writings it would appear that the offices of physician, surgeon and apothecary were already considered as distinct professions. He wrote a book entitled *The Method of Preparing Medicines and Diet*, which was translated into Hebrew in the year 1280, and thence into Latin by Paravicinus, whose version, first printed at Venice, 1490, has passed through several editions.

AVERAGE, a term found in two main senses. (1) The first, which occurs in old law, is from a Law-Latin *averagium*, and is connected with the Domesday Book *avera*, the "day's work which the king's tenants gave to the sheriff"; it is supposed to be a form of the O. Fr. *avre* (*œuvre*), work, affected by *aver*, the O. Eng. word for cattle or property, but the etymology is uncertain. As meaning some form of feudal service rendered by tenants to their superiors, it survived for a long time in the Scottish phrase "arriage and carriage," this form of the word being due to a contraction into "arage." (2) The second word, which represents the modern usages, is also uncertain in its

derivation, but corresponded with the Fr. *avarie*, and was early spelt "averays," recurring also as "avarria," "averia," and meaning a certain tax on goods, and then more precisely in maritime law any charge additional to "freight" (see AFFREIGHTMENT), payable by the owner of goods sent by ship. Hence the modern employment of the term for *particular* and *general* average (see below) in marine insurance. The essential of equitable distribution, involved in this sense, was transferred to give the word "average" its more colloquial meaning of an equalization of amount, or medium among various quantities, or nearest common rate or figure. (For a discussion of the etymology, see the *New English Dictionary*, especially the concluding note with reference to authorities.)

In Shipping.—Average, in modern law, is the term used in maritime commerce to signify damages or expenses resulting from the accidents of navigation. Average is either *general* or *particular*. General average arises when sacrifices have been made, or expenditures incurred, for the preservation of the ship, cargo and freight, from some peril of the sea or from its effects. It implies a subsequent contribution, from all the parties concerned, ratably to the values of their respective interests, to make good the loss thus occasioned. Particular average signifies the damage or partial loss happening to the ship, goods, or freight by some fortuitous or unavoidable accident. It is borne by the parties to whose property the misfortune happens or by their insurers. The term average originally meant what is now distinguished as general average; and the expression "particular average," although not strictly accurate, came to be afterwards used for the convenience of distinguishing those damages or partial losses for which no general contribution could be claimed.

Although nothing can be more simple than the fundamental principle of general average, that a loss incurred for the advantage of all the coadventurers should be made good by them all in equitable proportion to their stakes in the adventure, the application of this principle to the varied and complicated cases which occur in the course of maritime commerce has given rise to many diversities of usage at different periods and in different countries. It is soon discovered that the principle cannot be applied in any settled or consistent manner unless by the aid of rules of a technical and sometimes of a seemingly arbitrary character. The difficulty, which at one time seemed nearly insuperable, of bringing together the rules in force in the several maritime countries, has been to a large extent overcome—not by legislation but by framing a set of rules covering the principal points of difference in such a manner as to satisfy, on the whole, those who are practically concerned, and to lead them to adopt these rules in their contracts of affreightment and contracts of insurance (see INSURANCE: *Marine*). The honour of the achievement belongs to a small number of men who recognized the need of uniformity. The work began in May 1860 at a congress held at Glasgow, under the presidency of Lord Brougham, assisted by Lord Neaves. Further congresses were held in London (1862), and at York (1864), when a body of rules known as the "York Rules" was agreed to. There the matter stood, until it was taken up by the "Association for the Reform and Codification of the Law of Nations" at conferences held at the Hague (1875), Bremen (1876) and Antwerp (1877). Some changes were made in the "York Rules"; and so altered, the body of rules was adopted at the last-named conference, and was styled the "York and Antwerp (or York-Antwerp) Rules." The value of these rules was quickly perceived, and practical use of them followed. But they proved to be insufficient, or unsatisfactory, on some points; and again, in the autumn of 1890, a conference on the subject was held, this time at Liverpool, by the same Association, under the able presidency of Dr F. Sieveking, president of the Hanseatic High Court of Appeal at Hamburg. Important changes were then made, carrying further certain departures from English law, already apparent in the earlier rules, in favour of views prevailing upon the continent of Europe and in the United States. The new rules were styled the York-

History of the York-Antwerp rules.

Antwerp Rules 1890. In practice they quickly displaced those of 1877; and in 1892, at a conference of the same Association held at Genoa, it was formally declared that the only international rules of general average having the sanction and authority of the association were the York-Antwerp Rules as revised in 1890, and that the original rules were rescinded. It is this latter body of rules which is now known as the York-Antwerp Rules. Reference is now to be found in most English contracts of carriage and contracts of insurance, to these rules, as intended to govern the adjustment of G.A. between the parties; with the result that (so far as the rules cover the ground) adjustments do not depend upon the law of the place of destination, and so do not vary according to the destination, or the place at which the voyage may happen to be broken up, as used formerly to be the case.

The rules are as follows:—

RULE I.—JETTISON OF DECK CARGO

No jettison of deck cargo shall be made good as G.A. Every structure not built in with the frame of the vessel shall be considered to be a part of the deck of the vessel.

RULE II.—DAMAGE BY JETTISON AND SACRIFICE FOR THE COMMON SAFETY

Damage done to a ship and cargo, or either of them, by or in consequence of a sacrifice made for the common safety, and by water which goes down a ship's hatches opened, or other opening made for the purpose of making a jettison for the common safety, shall be made good as G.A.

RULE III.—EXTINGUISHING FIRE ON SHIPBOARD

Damage done to a ship and cargo, or either of them, by water or otherwise, including damage by beaching or scuttling a burning ship, in extinguishing a fire on board the ship, shall be made good as G.A.; except that no compensation shall be made for damage to such portions of the ship and bulk cargo, or to such separate packages of cargo, as have been on fire.

RULE IV.—CUTTING AWAY WRECK

Loss or damage caused by cutting away the wreck or remains of spars, or of other things which have previously been carried away by sea-peril, shall not be made good as G.A.

RULE V.—VOLUNTARY STRANDING

When a ship is intentionally run on shore, and the circumstances are such that if that course were not adopted she would inevitably sink, or drive on shore or on rocks, no loss or damage caused to the ship, cargo and freight, or any of them, by such intentional running on shore, shall be made good as G.A. But in all other cases where a ship is intentionally run on shore for the common safety, the consequent loss or damage shall be allowed as G.A.

RULE VI.—CARRYING PRESS OF SAIL—DAMAGE TO OR LOSS OF SAILS

Damage to or loss of sails and spars, or either of them, caused by forcing a ship off the ground or by driving her higher up the ground, for the common safety, shall be made good as G.A.; but where a ship is afloat, no loss or damage caused to the ship, cargo and freight, or any of them, by carrying a press of sail, shall be made good as G.A.

RULE VII.—DAMAGE TO ENGINES IN REFLOATING A SHIP

Damage caused to machinery and boilers of a ship which is ashore and in a position of peril, in endeavouring to refloat, shall be allowed in G.A., when shown to have arisen from an actual intention to float the ship for the common safety at the risk of such damage.

RULE VIII.—EXPENSES OF LIGHTENING A SHIP WHEN ASHORE, AND CONSEQUENT DAMAGE

When a ship is ashore, and, in order to float her, cargo, bunker coals and ship's stores, or any of them, are discharged, the extra cost of lightening, lighter hire, and reshipping (if incurred), and the loss or damage sustained thereby, shall be admitted as G.A.

RULE IX.—CARGO, SHIP'S MATERIALS, AND STORES BURNT FOR FUEL

Cargo, ship's materials and stores, or any of them, necessarily burnt for fuel for the common safety at a time of peril, shall be admitted as G.A. when and only when an ample supply of fuel had been provided; but the estimated quantity of coals that would have been consumed, calculated at the price current at the ship's last port of departure at the date of her leaving, shall be charged to the shipowner and credited to the G.A.

RULE X.—EXPENSES AT PORT OF REFUGE, &c.

(a) When a ship shall have entered a port or place of refuge, or shall have returned to her port or place of loading, in consequence of accident, sacrifice, or other extraordinary circumstances, which render that necessary for the common safety, the expenses of entering such port or place shall be admitted as G.A.; and when

she shall have sailed thence with her original cargo, or a part of it, the corresponding expenses of leaving such port or place, consequent upon such entry or return, shall likewise be admitted as G.A.

(b) The cost of discharging cargo from a ship, whether at a port or place of loading, call or refuge, shall be admitted as G.A., when the discharge was necessary for the common safety or to enable damage to the ship, caused by sacrifice or accident during the voyage, to be repaired, if the repairs were necessary for the safe prosecution of the voyage.

(c) Whenever the cost of discharging cargo from a ship is admissible as G.A., the cost of reloading and storing such cargo on board the said ship, together with all storage charges on such cargo, shall likewise be so admitted. But when the ship is condemned or does not proceed on her original voyage, no storage expenses incurred after the date of the ship's condemnation or of the abandonment of the voyage shall be admitted as G.A.

(d) If a ship under average be in a port or place at which it is practicable to repair her, so as to enable her to carry on the whole cargo, and if, in order to save expenses, either she is towed thence to some other port or place of repair or to her destination, or the cargo or a portion of it is transhipped by another ship, or otherwise forwarded, then the extra cost of such towage, transhipment and forwarding, or any of them (up to the amount of the extra expense saved), shall be payable by the several parties to the adventure in proportion to the extraordinary expense saved.

RULE XI.—WAGES AND MAINTENANCE OF CREW IN PORT OF REFUGE, &c.

When a ship shall have entered or shall have been detained in any port or place under the circumstances, or for the purposes of the repairs, mentioned in Rule X., the wages payable to the master, officers and crew, together with the cost of maintenance of the same, during the extra period of detention in such port or place until the ship shall or should have been made ready to proceed upon her voyage, shall be admitted as G.A. But when this ship is condemned or does not proceed on her original voyage, the wages and maintenance of the master, officers and crew, incurred after the date of the ship's condemnation or of the abandonment of the voyage, shall not be admitted as G.A.

RULE XII.—DAMAGE TO CARGO IN DISCHARGING, &c.

Damage done to or loss of cargo necessarily caused in the act of discharging, storing, reloading and stowing shall be made good as G.A. when and only when the cost of those measures respectively is admitted as G.A.

RULE XIII.—DEDUCTIONS FROM COST OF REPAIRS

In adjusting claims for G.A., repairs to be allowed in G.A. shall be subject to the following deductions in respect of "new for old," viz.:

In the case of iron or steel ships, from date of original rigging to the date of accident:—

Up to 1 year old (A.)	}	All repairs to be allowed in full, except painting or coating of bottom, from which one-third is to be deducted.
Between 1 and 3 years (B.)		One-third to be deducted off repairs to and renewal of woodwork of hull, masts and spars, furniture, upholstery, crockery, metal and glassware, also sails, rigging, ropes, sheets and hawsers (other than wire and chain), awnings, covers and painting.
Between 3 and 6 years (C.)		One-sixth to be deducted off wire rigging, wire ropes and wire hawsers, chain cables and chains, donkey engines, steam winches and connexions, steers, ranes and connexions; other repairs in full.
Between 6 and 10 years (D.)		Deductions as above under clause B, except that one-sixth be deducted off ironwork of masts and spars, and machinery (inclusive of boilers and their mountings).
Between 10 & 15 years (E.)		Deductions as above under clause C, except that one-third be deducted off ironwork of masts and spars, repairs to and renewal of all machinery (inclusive of boilers and their mountings), and all hawsers, ropes, sheets and rigging.
Over 15 years (F.)		One-third to be deducted off all repairs and renewals, except ironwork of hull and cementing and chain cables, from which one-sixth is to be deducted. Anchors to be allowed in full.
Generally (G.)		One-third to be deducted off all repairs and renewals. Anchors to be allowed in full. One-sixth to be deducted off chain cables.
		The deductions (except as to provisions and stores, machinery and boilers) to be regulated by the age of the ship, and not the age of the particular part of her to which they apply. No painting bottom to be allowed if the bottom has not been painted within six months previous to the date of accident. No deduction to be made in respect of old material which is repaired without being replaced by new, and provisions and stores which have not been in use.

In the case of wooden or composite ships:—

When a ship is under one year old from date of original register, at the time of accident, no deduction "new for old" shall be made. After that period a deduction of one-third shall be made, with the following exceptions:—

Anchors shall be allowed in full. Chain cables shall be subject to a deduction of one-sixth only.

No deduction shall be made in respect of provisions and stores which had not been in use.

Metal sheathing shall be dealt with, by allowing in full the cost of a weight equal to the gross weight of metal sheathing stripped off, minus the proceeds of the old metal. Nails, felt and labour metalling are subject to a deduction of one-third.

In the case of ships generally:—

In the case of all ships, the expense of straightening bent iron-work, including labour of taking out and replacing it, shall be allowed in full.

Graving dock dues, including expenses of removals, cartage, use of shears, staves and graving dock materials, shall be allowed in full.

RULE XIV.—TEMPORARY REPAIRS

No deductions "new for old" shall be made from the cost of temporary repairs of damage allowable as G.A.

RULE XV.—LOSS OF FREIGHT

Loss of freight arising from damage to or loss of cargo shall be made good as G.A., either when caused by a G.A. act or when the damage to or loss of cargo is so made good.

RULE XVI.—AMOUNT TO BE MADE GOOD FOR CARGO LOST OR DAMAGED BY SACRIFICE

The amount to be made good as G.A. for damage or loss of goods sacrificed shall be the loss which the owner of the goods has sustained thereby, based on the market values at the date of the arrival of the vessel or at the termination of the adventure.

RULE XVII.—CONTRIBUTORY VALUES

The contribution to a G.A. shall be made upon the actual values of the property at the termination of the adventure, to which shall be added the amount made good as G.A. for property sacrificed; deduction being made from the shipowner's freight and passage-money at risk, of such port charges and crew's wages as would not have been incurred had the ship and cargo been totally lost at the date of the G.A. act or sacrifice, and which has not been allowed as G.A. deduction being also made from the value of the property of all charges incurred in respect thereof subsequently to the G.A. act, except such charges as are allowed in G.A.

Passengers' luggage and personal effects, not shipped under bill of lading, shall not contribute to G.A.

RULE XVIII.—ADJUSTMENT

Except as provided in the foregoing rules, the adjustment shall be drawn up in accordance with the law and practice that would have governed the adjustment had the contract of affreightment not contained a clause to pay G.A. according to these rules.

The above rules differ in some important respects from English common law, and from former English practice. They follow ideas upon the subject of G.A. which have prevailed in practice in foreign countries (though often in apparent opposition to the language of the codes), in preference to the more strict principle of the common law applied by English courts. That principle requires that, in order to have the character of G.A. a sacrifice or expenditure must be made for the common safety of the several interests in the adventure and under the pressure of a common risk. It is not enough that the sacrifice or expenditure is prudent, or even necessary to enable the common adventure to be completed. G.A., on the English view, only arises where the safety of the several interests is at stake. "The idea of the common commercial adventure, as distinguished from the common safety from the sea," is not recognized. It is not sufficient "that an expenditure should have been made to benefit both cargo owner and shipowner."¹

Thus expenses incurred after ship and cargo are in safety, say at a port of refuge, are not generally, by English law, to be treated as G.A.; although the putting into port may have been for safety, and therefore a G.A. act. If the putting into port has been necessitated by a G.A. sacrifice, as by cutting away the ship's masts, the case is different; the port expenses, the expenses of repairing the G.A. damage, and the incidental expenses of unloading, storing and reloading the cargo are, in such a case, treated as consequences of the original sacrifice, and therefore subjects for contribution. But where the reason for putting in is to avoid some danger, such as a storm or

hostile cruiser, or to effect repairs necessitated by some accidental damage to the ship, the G.A. sacrifice is considered to be at an end when the port has been reached, if the ship and cargo are then in physical safety. The subsequent expenditure in the port is said not to flow from that sacrifice, but from the necessity of completing the voyage, and is incurred in performance of the shipowner's obligation under his contract. The practice of English average adjusters has indeed modified this strict view by treating the expense of unloading as G.A.; but it may well be doubted whether that practice can be legally supported. Moreover, expenditure in the port which is incurred in protecting the cargo as in warehousing it, is by English practice treated as a charge to be borne by the cargo for whose benefit it was incurred.

If we turn now to York-Antwerp Rule X., it will be seen that a much broader view is adopted. Whatever the reason for putting into the port of refuge, provided it was necessary for the common safety, the expenses of going in, and the consequent expenses of getting out (if she sails again with all or part of her original cargo), are allowed as G.A., Rule X. (a). Further, the cost of discharging the cargo to enable damage to the ship to be repaired, whether caused by sacrifice or by accident during the voyage, is to be allowed as G.A., "if the repairs were necessary for the safe prosecution of the voyage," Rule X. (b). And that is to be so even where such repairs are done at a port of call, as well as where done at a port of refuge. Again, when the cost of discharging is treated as G.A., so also are to be the expenses of storing the cargo on shore, and of reloading and stowing it on board, after the repairs have been done (Rule X. (c)), together with any damage or loss incidental to those operations (Rule XII.).

Further, by Rule XI. the wages of the master, officers and crew, and the cost of the maintenance, during the detention of a ship under the circumstances, or for the purpose of the repairs mentioned in Rule X., are to be allowed in G.A. It is questionable whether English law allows the wages and maintenance of the crew at a port of refuge in any case. Where the detention is to repair accidental damage it seems clear that they are not allowed. And in practice under common law, the allowance is never made; so that Rule XI. is an important concession to the shipowner. Like the changes introduced by Rule X., it is a change towards the practice in foreign countries.

It may be noted that the rules do not afford equal protection to a master in the comparatively infrequent case of his being put to expense by the delay at a port of refuge. Thus a shipper of cattle is not entitled to have the extra wages and provisions of his cattle-men on board, nor the extra fodder consumed by the cattle during the stay at a repairing port, made as good as G.A. under Rules XI. and X. (*Anglo-Argentine &c. Agency v. Temperley Shipping Co.*, 1899, 2 Q.B. 403).

As to the acts which amount to G.A. sacrifices, as distinguished from expenditures, the York-Antwerp Rules do not much alter English common law. They do, however, make definite provision upon some points on which authority was scanty or doubtful. (See Rules I.-IX.) And in Rule I., as to jettison of deck cargo, a change is made from the common law rule, for the jettison is not allowed as G.A. even though the cargo be carried on deck in accordance with an established custom of the particular trade.

Rule III. deals with damage done in extinguishing fire on board a ship. Modern decisions have cleared away the old doubts whether such damage to ship or cargo should, at law, be allowed in G.A. But recent cases in the United States have raised the question whether the allowance should be made where the fire occurs in port, and is extinguished, not by the master, but by a public authority acting in the interests of the public. The Supreme Court of the United States decided against the allowance in 1894 in a case of *Ralli v. Troup* (157 U.S. 386). The ship had there been scuttled to put out a fire on board, by the port authority, acting upon their own judgment, but with the assent of the master. It was held that the damage suffered by ship and cargo ought not to be made good by G.A. contributions; for the sacrifice had not been made "by some one specially charged with the control and safety of that adventure," but was the consequence of a public authority. On the other hand, in the English case of *Papanicolaou v. Grampian S.S. Co.* (1. Com. Ca. 448), Mathew, J., held that the scuttling of a ship at a port of refuge in Algeria, by orders of the captain of the port, was a G.A. act. It had been done in the interest of ship and cargo, and there was no evidence of any other motive.

Rule V. deals with the question whether, and under what conditions, a voluntary stranding of the ship is a G.A. act, in a manner which will probably be held to express the law in England when the matter comes up for decision.

Rules VI. and VII. deal with the damage sustained by the ship, or her appliances, in efforts to force her off the ground when she has stranded. Such efforts involve an abnormal use which is likely to cause damage to sails and spars, or to engines and boilers; and they are treated as acts of sacrifice. The case of "The Bona," 1895 (P. 125) shows that the rules are in accord with English law upon the point. The court of appeal held that both the damage sustained by the engines while worked to get the ship off, and the coal and stores consumed, were subjects for G.A. contribution at common law.

¹ Per Bowen, L.J., in *Svensden v. Wallace*, 1883, 13 Q.B.D. at p. 84.

Rule VIII. allows as G.A. any damage sustained by cargo when discharged and, say, lightered for the purpose of getting the ship off a strand. And the corresponding damage in the case of cargo discharged at a port of refuge to enable repairs to be done to the ship is allowed by Rule XII. But in the latter case the allowance does not expressly extend to damage sustained while stored on land. Whether the law would require contribution to a loss of goods, say, by thieves or by fire, while landed for repairs, is not clear. Where the landing has been necessitated by a G.A. act, as cutting away masts, it would seem that the loss ought to be made good, as being a result of the special risks to which those goods have thereby been exposed. The risks which they would have run if they had remained on board throughout are taken into account, as will presently appear, in estimating how much of the damage is to be made good.

Where cattle were taken into a port of refuge in Brazil, owing to accidental damage to the ship, with the result that they could not legally be landed at their destination (Deptford), and had to be taken to another port (Antwerp), at which they were of much less value, this loss of value was allowed in G.A. (*Anglo-Argentine & C. Agency v. Temperley Shipping Co.*, 1899, 2 Q.B. 403).

The case of a stranded ship and cargo often gives rise to difficulty as to whether the cost of operations to lighten the ship, and afterwards to get her floated, should be treated as G.A. expenditure, or as expenses separately incurred in saving the separate interests. The true conclusion seems to be that either the whole operation should be treated as one for the common safety, and the whole expense be contributed to by all the interests saved, or else the several parts of the operation should be kept distinct, debiting the cost of each to the interests thereby saved. Which of these two views should be adopted in any case seems to depend upon the motives with which the earlier operations (usually the discharge of the cargo) were presumably undertaken. It may, however, happen that this test cannot be applied once for all. Take the case of a stranded ship carrying a bulky cargo of hemp and grain, but carrying also some bullion. Suppose this last to be rescued and taken to a place of safety at small expense in comparison with its value. It may well be that that operation must be regarded as done in the interest simply of the bullion itself, but that the subsequent operations of lightening the ship and floating her can only be properly regarded as undertaken in the common interest of ship, hemp, grain and freight. In such a case there will be a G.A. contribution towards those later operations by those interests. But the bullion will not contribute; it will merely bear the expense of its own rescue (*Royal Mail S. P. Co. v. English Bank of Rio de Janeiro*, 1887, 19 Q.B.D. 362).

The York-Antwerp Rules have not only had the valuable result of introducing uniformity where there had been great variety, and corresponding certainty as to the principles which will be acted upon in adjusting a G.A. loss, but also they have introduced greater clarity and definiteness on points where there had been a want of definition. Thus Rule XIII. has laid down a careful and definite scale to regulate the deductions from the cost of repairs, in respect of "new for old," in place of the former somewhat uncertain customary rules which varied according to the place of adjustment; while at the same time the opportunity has been taken of adapting the scale of deductions to modern conditions of shipbuilding. And Rule XVII. lays down a rule as to contributory values in place of the widely varying rules of different countries as to the amounts upon which ship and freight shall contribute (cf. Gow, *Marine Insurance*, 305).

It may be of interest to refer briefly to one or two main principles which govern the adjustment (*q.v.*) of general average, *i.e.* the calculation of the amounts to be made good and paid by the several interests, which is a complicated matter. The fundamental idea is that the several interests at risk shall contribute in proportion to the benefits they have severally received by the completion of the adventure. Contributions are not made in proportion to the amounts at stake when the sacrifice was made, but in proportion to the results when the adventure has come to an end. An interest which has become lost after the sacrifice, during the subsequent course of the voyage, will pay nothing; an interest which has become depreciated will pay in proportion to the diminished value. The liability to contribute is inchoate only when the sacrifice has been made. It becomes complete when the adventure has come to an end, either by arrival at the destination, or by having been broken up at some intermediate point, while the interest in question still survives. To this there is one exception, in the case of G.A. expenditure. Where such expenditure has been incurred by the owner of one interest, generally by the shipowner, the repayment to him by the other interests ought not to be wholly dependent upon the subsequent safety of those interests at the ultimate destination. If those other interests or some of them arrive, or are realized, as by being landed at an intermediate port, the rule (as in the case of G.A. sacrifices)

is that the contributions are to be in proportion to the arrived or realized values. But if all are lost the burden of the expenditure ought not to remain upon the interest which at first bore it; and the proper rule seems to be that contributions must be made by all the interests which were at stake when it was made, in proportion to their *then* values.

Again, the object of the law of G.A. is to put one whose property is sacrificed upon an equal footing with the rest, not upon a better footing. Thus, if goods to the value of £100 have been thrown overboard for the general safety, the owner of those goods must not receive the full £100 in contribution. He himself must bear a part of it, for those goods formed part of the adventure for whose safety the jettison was made; and it is owing to the partial safety of the adventure that any contribution at all is received by him. He, therefore, is made to contribute with the other saved interests towards his own loss, in respect of the amount "made good" to him for that. The full £100 is treated as the amount to be made good, but the owner of the goods is made to contribute towards that upon the sum of £100 thus saved to him.

The same principle has a further consequence. The amount to be made good will not necessarily be the value of the goods or other property in their condition at the time they were sacrificed; so to calculate it would in effect be to withdraw those goods from the subsequent risks of the voyage, and thus to put them in a better position than those which were not sacrificed. Hence, in estimating the amount to be made good, the value of the goods or property sacrificed must be estimated as on arrival, with reference to the condition in which they would probably have arrived had they remained on board throughout the voyage.

The liability to pay G.A. contributions falls primarily upon the owner of the contributing interest, ship, goods or freight. But in practice the contributions are paid by the insurers of the several interests. Merchants seldom have to concern themselves with the subject. And yet in an ordinary policy of insurance there is no express provision requiring the underwriter to indemnify the assured against this liability. The policy commonly contains clauses which recognize such an obligation, *e.g.* a warranty against average "unless general," or an agreement that G.A. shall be payable "as per foreign statement," or "according to York-Antwerp Rules"; but it does not directly state the obligation. It assumes that. The explanation seems to be that the practice of the underwriter to pay the contribution has been so uniform, and his liability has been so fully recognized, that express provisions were needless. But one result has been that very differing views of the ground of the obligation have been held. One view has been that it is covered by the sue and labour clause of an ordinary policy, by which the insurer agrees to bear his proportion of expenses voluntarily incurred "in and about the defence, safeguard and recovery" of the insured subject. But that has been held to be mistaken by the House of Lords (*Aitchison v. Lohre*, 1879, A.C. 755). Another view is that the underwriter impliedly undertakes to repay sums which the law may require the assured to pay towards averting losses which would, by the contract, fall upon the underwriter. Expenses voluntarily incurred by the assured with that object are expressly made repayable by the sue and labour clause of the policy. It might well be implied that payments compulsorily required from the assured by law for contributions to G.A., or as salvage for services by salvors, will be undertaken or repaid by the underwriter, the service being for his benefit. But the decision in *Aitchison v. Lohre* negatives this ground also. The claim was against underwriters on a ship which had been so damaged that the cost of repairs had exceeded her insured value. A claim for the ship's contribution to certain salvage and G.A. expenses which had been incurred, over and above the cost of repairs, was disallowed. The view seems to have been that the insurer is liable for salvage and G.A. payments as losses of the subject insured, and therefore included in the sum insured, not as collateral payments made on his behalf. This bases the claim against the insurer upon a fiction, for there has been no loss of

the subject insured; in fact, the payment has been for averting such a loss. And it suggests that the insurer is not liable for salvage where the policy is free of particular average, which does not accord with practice.

An important question as to an insurer's liability for G.A. arose in the case of the *Brigella* (1893, P. 189), where a shipowner had incurred expenses which would have been the subject of G.A. contributions, but that he alone was interested in the voyage. There were no contributories. He claimed from the insurers of the ship what would have been the ship's G.A. contribution had there been other persons to contribute in respect of freight or cargo. The claim was disallowed on the ground that there could be no G.A. in such circumstances, and therefore no basis for a claim against the insurer. The liability of the insurer was thus made to depend, not upon the character of the loss, but upon the fact or possibility of contribution. But this was not followed in *Montgomery v. Indemnity Mutual M. I. Co.* (1901, 1 K.B. 147). There ship, freight and cargo all belonged to the same person. He had insured the cargo but not the ship. The cargo underwriters were held liable to pay a contribution to damage done to the ship by cutting away masts for the general safety. The loss was in theory spread over all the interests at risk, and they had undertaken to bear the cargo's share of such losses. Their liability did not depend upon the accident of whether the interests all belonged to one person or not. This agrees with the view taken in the United States.

As to *Particular Average*, see under *INSURANCE: Marine*.

AUTHORITIES.—Lowndes on *General Average* (4th ed., London, 1888); Abbott's *Merchant Ships and Seamen* (14th ed., London, 1901); Arnold's *Marine Insurance* (9th ed., London, 1901); Carver's *Carriage by Sea* (4th ed., London, 1905). (T. G. C.)

AVERNUS, a lake of Campania, Italy, about $1\frac{1}{2}$ m. N. of Baia. It is an old volcanic crater, nearly 2 m. in circumference, now, as in Roman times, filled with water. Its depth is 213 ft., and its height above sea-level $3\frac{1}{2}$ ft.; it has no natural outlet. In ancient times it was surrounded by dense forests, and was the centre of many legends. It was represented as the entrance by which both Odysseus and Aeneas descended to the infernal regions, and as the abode of the Cimmerii. Its Greek name, "Aopos," was explained to mean that no bird could fly across it. Hannibal made a pilgrimage to it in 214 B.C. Agrippa in 37 B.C. converted it into a naval harbour, the *Portus Iulius*; joining it to the Lacus Lucrinus by a canal, and connecting the latter with the sea, he reduced the distance to Cumae by boring a tunnel over $\frac{1}{2}$ m. in length, now called Grotta della Pace, through the hill on the north-west side of Lake Avernus. After Sextus Pompeius had been subdued, the chief naval harbour was transferred to Misenum. Nero's works for his proposed canal from Baiae to the Tiber (A.D. 64) seem to have begun near Lake Avernus; indeed, according to one theory, the Grotta della Pace would be a portion of this canal. On the east side of the lake are remains of baths, including a great octagonal hall known as the Temple of Apollo, built of brickwork, and belonging to the 1st century. The so-called Grotto of the Cumaean Sibyl, on the south side, is a rock-cut passage, ventilated by vertical apertures, possibly a part of the works connected with the naval harbour. To the south-east of the lake is the Monte Nuovo, a volcanic hill upheaved in 1538, with a deep extinct crater in the centre. To the south is the Lacus Lucrinus.

See J. Beloch, *Campanien* (2nd ed., Breslau, 1890), pp. 168 seq. (T. As.)

AVERROES [Abū-Walid Muḥammad ibn-Aḥmad Ibn-Muḥammad ibn-Rushd] (1126-1198), Arabian philosopher, was born at Cordova. His early life was occupied in mastering the curriculum of theology, jurisprudence, mathematics, medicine and philosophy, under the approved teachers of the time. The years of his prime fell during the 44th period of Mahomedan rule in Spain under the Almohades (q.v.). It was Ibn-Tufail (Abubacer), the philosophic vizier of Yusef, who introduced Averroes to that prince, and Avenzoar (Ibn-Zuhr), the greatest of Moslem physicians, was his friend. Averroes, who was versed in the Malekite system of law, was made *cadi* of Seville (1166), and in similar appointments the next twenty-five years

of his life were passed. We find him at different periods in Seville, Cordova and Morocco, probably as physician to Yusef al-Mansur, who took pleasure in engaging him in discussions on the theories of philosophy and their bearings on the faith of Islam. But science and free thought then, as now, in Islam, depended almost solely on the tastes of the wealthy and the favour of the monarch. The ignorant fanaticism of the multitude viewed speculative studies with deep dislike and distrust, and deemed any one a *Zendik* (infidel) who did not rest content with the natural science of the Koran. These smouldering hatreds burst into open flame about the year 1195. Averroes was accused of heretical opinions and pursuits, stripped of his honours, and banished to a place near Cordova, where his actions were closely watched. At the same time efforts were made to stamp out all liberal culture in Andalusia, so far as it went beyond the little medicine, arithmetic and astronomy required for practical life. But the storm soon passed. Averroes was recalled to Morocco when the transient passion of the people had been satisfied, and for a brief period survived his restoration to honour. He died in the year before his patron, al-Mansur, with whom (in 1199) the political power of the Moslems came to an end, as did the culture of liberal science with Averroes. The philosopher left several sons, some of whom became jurists like his own grandfather. One of them has left an essay, expounding his father's theory of the intellect. The personal character of Averroes is known to us only in a general way, and as we can gather it from his writings. His clear, exhaustive and dignified style of treatment evidences the rectitude and nobility of the man. In the histories of his own nation he has little place; the renown which spread in his lifetime to the East ceased with his death, and he left no school. Yet, from a note in a manuscript, we know that he had intelligent readers in Spain more than a century afterwards. His historic fame came from the Christian Schoolmen, whom he almost initiated into the system of Aristotle, and who, but vaguely discerning the expositors who preceded, admired in his commentaries the accumulated results of two centuries of labours.

The literary works of Averroes include treatises on jurisprudence, grammar, astronomy, medicine and philosophy. In 1859 a work of Averroes was for the first time published in Arabic by the Bavarian Academy, and a German translation appeared in 1875 by the editor, J. Müller. It is a treatise entitled *Philosophy and Theology*, and, with the exception of a German version of the essay on the conjunction of the intellect with man, is the first translation which enables the non-Semitic scholar to form any adequate idea of Averroes. The Latin translations of most of his works are barbarous and obscure. A great part of his writings, particularly on jurisprudence and astronomy, as well as essays on special logical subjects, prolegomena to philosophy, criticisms on Avicenna and Alfarabius (Fārābī), remain in manuscript in the Escorial and other libraries. The Latin editions of his medical works include the *Colliget* (i.e. *Kulliyat*, or summary), a *résumé* of medical science, and a commentary on Avicenna's poem on medicine; but Averroes, in medical renown, always stood far below Avicenna. The Latin editions of his philosophical works comprise the *Commentaries on Aristotle*, the *Destructio Destructio* (against Ghazālī), the *De Substantia Orbis* and a double treatise *De Animæ Beatitudine*. The Commentaries of Averroes fall under three heads:—the larger commentaries, in which a paragraph is quoted at large, and its clauses expounded one by one; the medium commentaries, which cite only the first words of a section; and the paraphrases or analyses, treatises on the subjects of the Aristotelian books. The larger commentary was an innovation of Averroes; for Avicenna, copied by Albertus Magnus, gave under the rubrics furnished by Aristotle works in which, though the materials were borrowed, the grouping was his own. The great commentaries exist only for the *Posterior Analytics*, *Physics*, *De Caelo*, *De Anima* and *Metaphysics*. On the *History of Animals* no commentary at all exists, and Plato's *Republic* is substituted for the then inaccessible *Politics*. The Latin editions of these works between 1480 and 1580 number about 100. The first

appeared at Padua (1472); about fifty were published at Venice, the best-known being that by the Juntas (1552-1553) in ten volumes folio.

See E. Renan, *Averroës et l'Averroïsme* (2nd ed., Paris, 1861); S. Munk, *Mélanges*, 418-458; G. Stöckl, *Phil. d. Mittelalters*, ii. 67-124; *Averroës (Vater und Sohn)*, *Drei Abhandl. über d. Conjunction d. separaten Intellects mit d. Menschen*, trans. into German from the Arabic version of Sam. Ben-Tibbon, by Dr. J. Herzer (Berlin, 1869); T. J. de Boer, *History of Philosophy in Islam* (London, 1903), ch. vi.; A. F. M. Mehren in *Museon*, vii. 613-627; viii. 1-20; Carl Brockelmann, *Geschichte der arabischen Litteratur* (Weimar, 1898), vol. i. pp. 461 f. See also ARABIAN PHILOSOPHY. (W. W.; G. W. T.)

AVERRUNCATOR, a form of long shears used in arboriculture for "averruncating" or pruning off the higher branches of trees, &c. The word "averruncate" (from Lat. *averruncare*, to ward off, remove mischiefs) glided into meaning to "weed the ground," "prune vines," &c., by a supposed derivation from the Lat. *ab*, off, and *eruncare*, to weed out, and it was spelt "aberruncate" to suit this; but the *New English Dictionary* regards such a derivation as impossible.

AVERSA, a town and episcopal see of Campania, Italy, in the province of Caserta, 15½ m. S.S.W. by rail from Caserta, and 12½ m. N. by rail from Naples, from which there is also an electric tramway. Pop. (1901) 23,477. Aversa was the first place in which the Normans settled, it being granted to them in 1027 for the help which they had given to Duke Sergius of Naples against Pandulf IV. of Capua. The Benedictine abbey of S. Lorenzo preserves a portal of the 11th century. There is also a large lunatic asylum, founded by Joachim Murat in 1813.

AVESNES, a town of northern France, capital of an arrondissement in the department of Nord, on the Helpe, 28 m. S.E. of Valenciennes by rail. Pop. (1906) 5076. The town is the seat of a sub-prefect, and has a tribunal of first instance, a chamber of commerce and a communal college. Its church of St Nicholas (16th century) has a tower 200 ft. high, with a fine chime of bells. The chief industry of the town is wool-spinning, and there is trade in wood. Avesnes was founded in the 11th century, and formed a county which in the 15th century passed to the house of Burgundy and afterwards to that of Habsburg. In 1477 it was destroyed by Louis XI. By the treaty of the Pyrenees (1659) it came into the possession of the French, and was fortified by Vauban. It was captured by the Prussians in 1815.

AVEYRON, a department of southern France, bounded N. by Cantal, E. by Lozère and Gard, S.W. by Tarn and W. by Tarn-et-Garonne and Lot. Area, 3386 sq. m. Pop. (1906) 377,299. It corresponds nearly to the old district of Rouergue, which gave its name to a county established early in the 9th century, and united with that of Toulouse towards the end of the 11th century. The earliest known natives of this region were the Celtic Rutheni, to whom the numerous megalithic monuments found in the department are attributed. Aveyron lies on the southern border of the central plateau of France. Its chief rivers are the Lot in the north, the Aveyron in the centre and the Tarn in the south, all tributaries of the Garonne. They flow from east to west, following the general slope of the department, and divide it into four zones. In the north-east, between the Lot and its tributary the Truyère, lies the lonely pastoral plateau of the Viadène, dominated by the volcanic mountains of Aubrac, which form the north-eastern limit of the department and include its highest summit (4760 ft.). Entraygues, at the confluence of the Lot and the Truyère, is one of the many picturesque towns of the department. Between the Lot and the Aveyron is a belt of *causses* or monotonous limestone table-lands, broken here and there by profound and beautiful gorges—a type of scenery characteristic of Aveyron. This zone is also watered by the Dourdou du Nord, a tributary of the Lot. The salient feature of the region between the Tarn and the Aveyron is the plateau of the Ségala, bordered on the east by the heights of Lézéou and Palanges and traversed from east to west by the deep valley of the Viaur, a tributary of the Aveyron. The country south of the Tarn is occupied in great part by the huge plateau of Larzac, which lies between the Causse Noir and the Causse St Affrique, the three forming the south-western termination of the

Cévennes. On the Causse Noir is found the fantastic chaos of rocks and precipices known as Montpellier-le-Vieux, resembling the ruins of a huge city. The climate of Aveyron varies from extreme rigour in the mountains to mildness in the sheltered valleys; the south wind is sometimes of great violence. Wheat, rye and oats are the chief cereals cultivated, the soil of Aveyron being naturally poor. Other crops are potatoes, colza, hemp and flax. The mainstay of the agriculture of the department is the raising of live-stock, especially of cattle of the Aubrac breed, for which Laguiole is an important market. The wines of Entraygues, St Georges, Bouillac and Najac have some reputation; in the Ségala chestnuts form an important element in the food of the peasants, and the walnut, cider-apple, mulberry (for the silk-worm industry), and plum are among the fruit trees grown. The production of Roquefort cheeses is prominent among the agricultural industries. They are made from the milk of the large flocks of the plateau of Larzac, and the cheese are ripened in the even temperature of the caves in the cliff which overhangs Roquefort. The minerals found in the department include the coal of the basins of Aubin and Rodez as well as iron, zinc and lead. Quarries of various kinds of stone are also worked. The chief industrial centres are Decazeville, which has metallurgical works, and Millau, where leather-dressing and the manufacture of gloves have attained considerable importance. Wool-weaving and the manufacture of woollen goods, machinery, chemicals and bricks are among the other industries.

There are five arrondissements, of which the chief towns are Rodez, capital of the department, Espalion, Millau, St Affrique and Villefranche, with 43 cantons and 304 communes. Rodez is the seat of a bishopric, the diocese of which comprises the department. Aveyron belongs to the 16th military region, and to the *académie* or educational circumscription of Toulouse. Its court of appeal is at Montpellier. The department is traversed by the lines both of the Orléans and Southern railways. The more important towns are Rodez, Millau, St Affrique, Villefranche-de-Rouergue and Decazeville. The following are also of interest:—Sauveterre, founded in 1281, a striking example of the bastide (*q.v.*) of that period; Conques, which has a remarkable abbey-church of the 11th century like St Sernin of Toulouse in plan and possessing a rich treasury of reliquaries, &c.; Espalion, where among other old buildings there are the remains of a feudal stronghold and a church of the Romanesque period; Najac, which has the ruins of a magnificent chateau of the 13th century; and Sylvanès, with a church of the 12th century, once attached to a Cistercian abbey.

AVEZZANO, a town of the Abruzzi, Italy, in the province of Aquila, 67 m. E. of Rome by rail and 38 m. S. of Aquila by road. Pop. (1901) 9442. It has a fine and well-preserved castle, built in 1490 by Gentile Virginio Orsini; it is square, with round towers at the angles. Avezzano is on the main line from Rome to Castellammare Adriatico; a branch railway diverges to Roccasecca, on the line from Naples to Rome. The Lago Fucino lies 1½ m. to the east.

AVIANUS, a Latin writer of fables, placed by some critics in the age of the Antonines, by others as late as the 6th century A.D. He appears to have lived at Rome and to have been a heathen. The 42 fables which bear his name are dedicated to a certain Theodosius, whose learning is spoken of in most flattering terms. He may possibly be Macrobius Theodosius, the author of the *Saturnalia*; some think he may be the emperor of that name. Nearly all the fables are to be found in Babrius, who was probably Avianus's source of inspiration, but as Babrius wrote in Greek, and Avianus speaks of having made an elegiac version from a rough Latin copy, probably a prose paraphrase, he was not indebted to the original. The language and metre are on the whole correct, in spite of deviations from classical usage, chiefly in the management of the pentameter. The fables soon became popular as a school-book. Promythia and epimythia (introductions and morals) and paraphrases, and imitations were frequent, such as the *Novus Avianus* of Alexander Neckam (12th century).

EDITIONS.—Cannegieter (1731), Lachmann (1845), Fröhner (1862),

Bithrens in *Poetae Latini Minores*, Ellis (1887). See Müller, *De Phaedri et Aviani Fabulis* (1875); Unrein, *De Aviani Aetate* (1885); Herveux, *Les Fabulistes latins* (1894); *The Fables of Avian translated into English* . . . by William Caxton at Westmynstre (1483).

AVIARY (from Lat. *avis*, a bird), called by older writers "volary," a structure in which birds are kept in a state of captivity. While the habit of keeping birds in cages dates from a very remote period, it is probable that structures worthy of being termed aviaries were first used by the ancient Romans, chiefly for the process of fattening birds for the table. In Varro's time, 116-127 B.C., aviaries or "ornithones" (from Gr. *ὄρνις* *ὄρνιθον*, bird) were common. These consisted of two kinds, those constructed for pleasure, in which were kept nightingales and other song-birds, and those used entirely for keeping and fattening birds for market or for the tables of their owners. Varro himself had an aviary for song-birds exclusively, while Lucullus combined the two classes, keeping birds both for pleasure and as delicacies for his table. The keeping of birds for pleasure, however, was very rarely indulged in, while it was a common practice with poulterers and others to have large ornithones either in the city or at Sabinum for the fattening of thrushes and other birds for food.

Ornithones consisted merely of four high walls and a roof, and were lighted with a few very small windows, as the birds were considered to pine less if they could not see their free companions outside. Water was introduced by means of pipes, and conducted in narrow channels, and the birds were fed chiefly upon dried figs, carefully peeled, and chewed into a pulp by persons hired to perform this operation.

Turtle-doves were fattened in large numbers for the market on wheat and millet, the latter being moistened with sweet wine; but thrushes were chiefly in request, and Varro mentions one ornithon from which no less than five thousand of these birds were sold for the table in one season.

The habit of keeping birds in aviaries, as we understand the term, for the sake of the pleasure they afford their owners and for studying their habits is, however, of comparatively recent date. The beginning of geographical research in the 15th century brought with it the desire to keep and study at home some of the beautiful forms of bird-life which the explorers came across, and hence it became the custom to erect aviaries for the reception of these creatures. In the 16th century, in the early part of which the canary-bird was introduced into Europe, aviaries were not uncommon features of the gardens of the wealthy, and Bacon refers to them in his essay on gardening (1597). Elizabeth of Bohemia, the daughter of James I. of England, when a child, had an outdoor aviary at Coombe Abbey near Coventry, the back and roof of which were formed of natural rock, in which were kept birds of many species from many countries.

Within recent years the method of keeping birds in large aviaries has received considerable attention, and it is fully recognized that by so doing, not only do we derive great pleasure, but our knowledge of avian habits and mode of living can thereby be very considerably increased.

An aviary may be of almost any size, from the large cage known, on account of its shape, as the "Crystal Palace aviary," to a structure as large as a church; and the term is sometimes applied to the room of a house with the windows covered with wire-netting; but as a rule it is used for outdoor structures, composed principally of wire-netting supported on a framework of either iron or woodwork. For quite hardy birds little more than this is necessary, providing that protection is given in the form of growing trees and shrubs, rock-work or rough wooden shelters. For many of the delicate species, however, which hail from tropical countries, warmth must be provided during the inclement months of the year, and thus a part at least of an aviary designed for these birds must be in the form of a wooden or brick house which can be shut up in cold weather and artificially warmed.

The ideal aviary, probably, is that which is constructed in two parts, viz. a well-built house for the winter, opening out

into a large wire enclosure for use in the summer months. The doors between the two portions may be of wood or glazed. The part intended as the winter home of the birds is best built in brick or stone, as these materials are practically vermin-proof and the temperature in such a building is less variable than that in a thin wooden structure. The floor should be of concrete or brick, and the house should be fitted with an efficient heating apparatus from which the heat is distributed by means of hot-water pipes. Any arrangement which would permit the escape into the aviary of smoke or noxious fumes is to be strongly condemned. Such a house must be well lighted, preferably by means of skylights; but it is a mistake to have the whole roof glazed, at least if it should be of wood, covered with slates or tiles. Perches consisting of branches of trees with the bark adhering should be fixed up, and, if small birds are to be kept, bundles of bushy twigs should be securely fixed up in corners under the roofs.

The outer part, which will principally be used during the summer, though it will do most birds good to be let out for a few hours on mild winter days also, should be as large as possible, and constructed entirely of wire-netting stretched on a framework of wood or iron. If the latter material is selected, stout gas-piping is both stronger and more easily fitted together than solid iron rods.

If the framework be of wood, this should be creosoted, preferably under pressure, or painted with three coats of good lead paint, the latter preservative also being used if iron is the material selected.

The wire-netting used may be of almost any sized mesh, according to the sized birds to be kept, but as a general rule the smallest mesh, such as half or five-eighths of an inch, should be used, as it is practically vermin-proof, and allows of birds of any size being kept. Wire-netting for aviaries should be of the best quality, and well galvanized. The new interlinked type is less durable than the old mesh type, though perhaps it looks somewhat neater when fixed.

Provision must be made for the entire exclusion of such vermin as rats, stoats and weasels, which, if they were to gain access, would commit great havoc amongst the birds. The simplest and most effectual method of doing this is by sinking the wire-netting some 2 ft. into the ground all round the aviary, and then turning it outwards for a distance of another foot as shown in the annexed cut (fig. 1).

The outer part of the aviary should be turfed and planted with evergreen and deciduous shrubs, and be provided with some means of supplying an abundance of pure water for the birds to drink and bathe in; and a gravel path should not be forgotten.

Perhaps the most useful type of aviary is that built as above described, but with several compartments, and a passage at the back by which any compartment may be visited without the necessity of passing through and disturbing the birds in other compartments. Fig. 2 represents a ground plan of an aviary of this type divided into four compartments, each with an inner house 10 ft. square, and an outer flight of double that area. The outer flights are intended to be turfed, and planted with shrubs, and the gravel path has a glazed roof above it by which it is kept dry in wet weather. Shallow water-basins are shown, which should be supplied by means of an underground pipe and a cock which can be turned on from outside the aviary; and they must be connected with a properly laid drain by means of a waste plug and an overflow pipe.

An aviary should always be built with a southern or south-eastern aspect, and, where possible, should be sheltered from the north, north-east and north-west by a belt of fir-trees, high wall or bank, to protect the birds from the biting winds from these quarters.

When parrots of any kind are to be kept it is useless to try

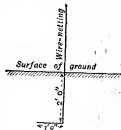

FIG. 1.

to grow any kind of vegetation except grass, and even this will be demolished unless the aviary is of considerable size. The larger parrots will, in fact, bite to pieces not only living trees but also the woodwork of their abode, and the only really suitable materials for the construction of an aviary for these birds are brick or stone and iron; and the wire-netting used must be of the stoutest gauge or it will be torn to pieces by their strong bills.

The feeding of birds in aviaries is, obviously, a matter of the utmost importance, and, in order that they may have what is most suitable, the aviculturist should find out as much as possible of the wild life of the species he wishes to keep, or if little or nothing is known about their mode of living, as is often the case with rare forms, of nearly related species whose habits and food are probably much the same, and he should endeavour to provide food as nearly as possible resembling that which would be obtained by the birds when wild. It is often, however, impossible to supply precisely the same food as would be obtained by the birds had they their liberty, but a substitute which suits them well can

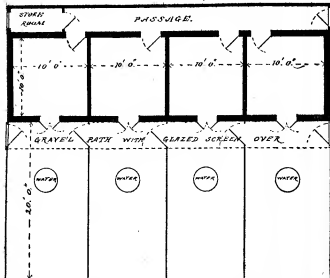

FIG. 2.—Plan of 4-compartment Aviary for Foreign Birds.

generally be obtained. The majority of the parrot tribe subsist principally upon various nuts, seed and fruit, while some of the smaller parakeets or paroquets appear to feed almost exclusively upon the seeds of various grasses. Almost all of these are comparatively easy to treat in captivity, the larger ones being fed on maize, sunflower-seed, hemp, dari, oats, canary-seed, nuts and various ripe fruits, while the grass-parakeets thrive remarkably well on little besides canary-seed and green food, the most suitable of which is grass in flower, chickweed, groundsel and various seed-bearing weeds. But there is another large group of parrots, the *Loridæ* or brush-tongued parrots, some of the most interesting and brightly coloured of the tribe, which, when wild, subsist principally upon the pollen and nectar of flowers, notably the various species of *Eucalyptus*, the filamented tongues of these parrots being peculiarly adapted for obtaining this. In captivity these birds have been found to live well upon sweetened milk-sop, which is made by pouring boiling milk upon crumbled bread or biscuit. They frequently learn to eat seed like other parrots, but, if fed exclusively upon this, are apt, especially if deprived of abundance of exercise, to suffer from fits which are usually fatal. Fruit is also readily eaten by the lories and lorikeets, and should always be supplied.

The foreign doves and pigeons form a numerous and beautiful group which are mostly hardy and easily kept and bred in captivity. They are for the most part grain-feeders and require only small corn and seeds, though a certain group, known as the fruit-pigeons, are fed in captivity upon soft fruits, berries, boiled potato and soaked grain.

The various finches and finch-like birds form an exceedingly large group and comprise perhaps the most popular of foreign

aviary birds. The weaver-birds of Africa are mostly quite hardy and very easily kept, their food consisting, for the most part, of canary-seed. The males of these birds are, as a rule, gorgeously attired in brilliant colours, some having long flowing tail-feathers during the nuptial season, while in the winter their showy dress is replaced by one of sparrow-like sombreness. The grass-finches of Australasia contain some of the most brilliantly coloured birds, the beautiful grass-finch (*Poephila mirabilis*) being resplendent in crimson, green, mauve, blue and yellow. Most of these birds build their nests, and many rear their young, successfully in outdoor aviaries, their food consisting of canary and millet seeds, while flowering grasses provide them with an endless source of pleasure and wholesome food. The same treatment suits the African waxbills, many of which are extremely beautiful, the crimson-eared waxbill or "cord-bleu" being one of the most lovely and frequently imported. These little birds are somewhat delicate, especially when first imported, and during the winter months require artificial warmth.

There is a very large group of insectivorous and fruit-eating birds very suitable for aviculture, but their mode of living necessarily involves considerable care on the part of the aviculturist in the preparation of their food. Many birds are partially insectivorous, feeding upon insects when these are plentiful, and upon various seeds at other times. Numbers of species again which, when adult, feed almost entirely upon grain, feed their young, especially during the early stages of their existence, upon insects; while others are exclusively insect-eaters at all times of their lives. All of these points must be considered by those who would succeed in keeping and breeding birds in aviaries.

It would be almost an impossibility to keep the purely insectivorous species, were it not for the fact that they can be gradually accustomed to feed on what is known as "insectivorous" or "insectile" food, a composition of which the principal ingredients generally consist of dried ants' cocoons, dried flies, dried powdered meat, preserved yolk of egg,¹ and crumb of bread or biscuit. This is moistened with water or mixed with mashed boiled potato, and forms a diet upon which most of the insectivorous birds thrive. The various ingredients, or the food ready made, can be obtained at almost any bird-fancier's shop. Although it is a good staple diet for these birds, the addition of mealworms, caterpillars, grubs, spiders and so forth is often a necessity, especially for purely insectivorous species.

The fruit-eating species, such as the tanagers and sugar-birds of the New World, require ripe fruit in abundance in addition to a staple diet such as that above described, while for such birds as feed largely upon earth-worms, shredded raw meat is added with advantage.

Many of the waders make very interesting aviary birds, and require a diet similar to that above recommended, with the addition of chopped raw meat, mealworms and any insects that can be obtained.

Birds of prey naturally require a meat diet, which is best given in the form of small, freshly killed mammals and birds, the fur or feathers of which should not be removed, as they aid digestion.

The majority of wild birds, from whatever part of the world they may come, will breed successfully in suitable aviaries providing proper nesting sites are available. Large bundles of brushwood, fixed up in sheltered spots, will afford accommodation for many kinds of birds, while some will readily build in evergreen shrubs if these are grown in their enclosure. Small boxes and baskets, securely fastened to the wall or roof of the

¹ It has recently been stated by certain medical men that egg-food in any form is an undesirable diet for birds, owing to its being peculiarly adapted to the multiplication of the bacillus of septicæmia, a disease which is responsible for the death of many newly imported birds. It is a significant fact, however, that insectivorous species, which are those principally fed upon this substance, are not nearly so susceptible to this disease as seed-eating birds which rarely taste egg; and in spite of what has been written concerning its harmfulness, the large majority of aviculturists use it, in both the fresh and the preserved state, with no apparent ill effects, but rather the reverse.

sheltered part of an aviary, will be appropriated by such species as naturally build in holes and crevices. Parrots, when wild, lay their eggs in hollow trees, and occasionally in holes in rocks, making no nest,¹ but merely scraping out a slight hollow in which to deposit the eggs. For these birds hollow logs, with small entrance holes near the top, or boxes, varying in size according to the size of the parrots which they are intended for, should be supplied. In providing nesting accommodation for his birds the aviculturist must endeavour to imitate their natural surroundings and supply sites as nearly as possible similar to those which the birds, to whatever order they may belong, would naturally select.

Aviculture is a delightful pastime, but it is also far more than this; it is of considerable scientific importance, for it admits of the living birds being studied in a way that would be quite impossible otherwise. There are hundreds of species of birds, from all parts of the world, the habits of which are almost unknown, but which may be kept without difficulty in suitable aviaries. Many of these birds cannot be studied satisfactorily in a wild state by reason of their shy nature and retiring habits, not to mention their rarity and the impossibility, so far as most people are concerned, of visiting their native haunts. In suitable large aviaries, however, their nesting habits, courtship, display, incubation, moult and so forth can be accurately observed and recorded. The keeping of birds in aviaries is therefore a practice worthy of every encouragement, so long as the aviaries are of sufficient size and suitable design to allow of the birds exhibiting their natural habits; for in a large aviary they will reveal the secrets of their nature as they never would do in a cage or small aviary. (D. S. S.)

AVICENNA [Abū 'Alī al-Husain ibn 'Abdallāh ibn Sīnā] (980-1037). Arabian philosopher, was born at Afshena in the district of Bokhara. His mother was a native of the place; his father, a Persian from Balkh, filled the post of tax-collector in the neighbouring town of Harmaitin, under Nūh II. ibn Mansur, the Samanid amir of Bokhara. On the birth of Avicenna's younger brother the family migrated to Bokhara, then one of the chief cities of the Moslem world, and famous for a culture which was older than its conquest by the Saracens. Avicenna was put in charge of a tutor, and his precocity soon made him the marvel of his neighbours,—as a boy of ten who knew by rote the Koran and much Arabic poetry besides. From a green-rocker he learnt arithmetic; and higher branches were begun under one of those wandering scholars who gained a livelihood by cures for the sick and lessons for the young. Under him Avicenna read the *Isagoge* of Porphyry and the first propositions of Euclid. But the pupil soon found his teacher to be but a charlatan, and betook himself, aided by commentaries, to master logic, geometry and the *Almagest*. Before he was sixteen he not merely knew medical theory, but by gratuitous attendance on the sick had, according to his own account, discovered new methods of treatment. For the next year and a half he worked at the higher philosophy, in which he encountered greater obstacles. In such moments of baffled inquiry he would leave his books, perform the requisite ablutions, then lie to the mosque, and continue in prayer till light broke on his difficulties. Deep into the night he would continue his studies, stimulating his senses by occasional cups of wine, and even in his dreams problems would pursue him and work out their solution. Forty times, it is said, he read through the *Metaphysics* of Aristotle, till the words were imprinted on his memory; but their meaning was hopelessly obscure, until one day they found illumination from the little commentary by Fārābī (*q.v.*), which he bought at a bookstall for the small sum of three dirhems. So great was his joy at the discovery, thus made by help of a work from which he had expected only mystery, that he hastened to return thanks to God, and bestowed an alms upon the poor. Thus, by the end of his seventeenth year his apprenticeship of study was
¹ There is, however, one true nest-building parrot, the grey-breasted parakeet (*Mopsittacus monachus*), which constructs a huge nest of twigs. The true love-birds (*Agapornis*) may also be said to build nests, for they line their nest-hole with strips of pliant bark.

concluded, and he went forth to find a market for his accomplishments.

His first appointment was that of physician to the amir, who owed him his recovery from a dangerous illness (997). Avicenna's chief reward for this service was access to the royal library of the Samanids (*q.v.*), well-known patrons of scholarship and scholars. When the library was destroyed by fire not long after, the enemies of Avicenna accused him of burning it, in order for ever to conceal the sources of his knowledge. Meanwhile, he assisted his father in his financial labours, but still found time to write some of his earliest works.

At the age of twenty-two Avicenna lost his father. The Samanid dynasty came to its end in December 1004. Avicenna seems to have declined the offers of Mahmūd the Ghaznevid, and proceeded westwards to Urjensh in the modern Khiva, where the vizier, regarded as a friend of scholars, gave him a small monthly stipend. But the pay was small, and Avicenna wandered from place to place through the districts of Nishapur and Merv to the borders of Khorasan, seeking an opening for his talents. Shams al-Ma'ālī Qābūs, the generous ruler of Dailam, himself a poet and a scholar, with whom he had expected to find an asylum, was about that date (1012) starved to death by his own revolted soldiery. Avicenna himself was at this season stricken down by a severe illness. Finally, at Jorjān, near the Caspian, he met with a friend, who bought near his own house a dwelling in which Avicenna lectured on logic and astronomy. For this patron several of his treatises were written; and the commencement of his *Canon of Medicine* also dates from his stay in Hyrcania.

He subsequently settled at Rai, in the vicinity of the modern Teheran, where a son of the last amir, Majd Addaula, was nominal ruler, under the regency of his mother. At Rai about thirty of his shorter works are said to have been composed. But the constant feuds which raged between the regent and her second son, Shams Addaula, compelled the scholar to quit the place, and after a brief sojourn at Kazwīn, he passed southwards to Hamadān, where that prince had established himself. At first he entered into the service of a high-born lady; but ere long the amir, hearing of his arrival, called him in as medical attendant, and sent him back with presents to his dwelling. Avicenna was even raised to the office of vizier; but the turbulent soldiery, composed of Kurds and Turks, mutinied against their nominal sovereign, and demanded that the new vizier should be put to death. Shams Addaula consented that he should be banished from the country. Avicenna, however, remained hidden for forty days in a sheikh's house, till a fresh attack of illness induced the amir to restore him to his post. Even during this perturbed time he prosecuted his studies and teaching. Every evening extracts from his great works, the *Canon* and the *Sandho*, were dictated and explained to his pupils; among whom, when the lesson was over, he spent the rest of the night in festive enjoyment with a band of singers and players. On the death of the amir Avicenna ceased to be vizier, and hid himself in the house of an apothecary, where, with intense assiduity, he continued the composition of his works. Meanwhile, he had written to Abu Ya'far, the prefect of Isfahan, offering his services; but the new amir of Hamadān getting to hear of this correspondence, and discovering the place of Avicenna's concealment, incarcerated him in a fortress. War meanwhile continued between the rulers of Isfahan and Hamadān; in 1024 the former captured Hamadān and its towns, and expelled the Turkish mercenaries. When the storm had passed Avicenna returned with the amir to Hamadān, and carried on his literary labours; but at length, accompanied by his brother, a favourite pupil, and two slaves, made his escape out of the city in the dress of a Sufite ascetic. After a perilous journey they reached Isfahan, and received an honourable welcome from the prince. The remaining ten or twelve years of Avicenna's life were spent in the service of Abu Ya'far 'Alā Addaula, whom he accompanied as physician and general literary and scientific adviser, even in his numerous campaigns. During these years he began to study literary matters and philology, instigated, it is asserted, by

criticisms on his style. But amid his restless study Avicenna never forgot his love of enjoyment. Unusual bodily vigour enabled him to combine severe devotion to work with facile indulgence in sensual pleasures. His passion for wine and women was almost as well known as his learning. Versatile, light-hearted, boastful and pleasure-loving, he contrasts with the nobler and more intellectual character of Averroes. His bouts of pleasure gradually weakened his constitution; a severe colic, which seized him on the march of the army against Hamadán, was checked by remedies so violent that Avicenna could scarcely stand. On a similar occasion the disease returned; with difficulty he reached Hamadán, where, finding the disease gaining ground, he refused to keep up the regimen imposed, and resigned himself to his fate. On his deathbed remorse seized him; he bestowed his goods on the poor, restored unjust gains, freed his slaves, and every third day till his death listened to the reading of the Koran. He died in June 1037, in his fifty-eighth year, and was buried in Hamadán.

It was mainly accident which determined that from the 12th to the 17th century Avicenna should be the guide of medical study in European universities, and eclipse the names of Rhazes, Ali ibn al-Abbas and Avenzoar. His work is not essentially different from that of his predecessors Rhazes and Ali; all present the doctrine of Galen, and through Galen the doctrine of Hippocrates, modified by the system of Aristotle. But the *Canon* of Avicenna is distinguished from the *Al-Hawi* (*Continens*) or *Summary* of Rhazes by its greater method, due perhaps to the logical studies of the former, and entitling him to his surname of Prince of the Physicians. The work has been variously appreciated in subsequent ages, some regarding it as a treasury of wisdom, and others, like Avenzoar, holding it useful only as waste paper. In modern times it has been more criticized than read. The vice of the book is excessive classification of bodily faculties, and over-subtlety in the discrimination of diseases. It includes five books; of which the first and second treat of physiology, pathology and hygiene, the third and fourth deal with the methods of treating disease, and the fifth describes the composition and preparation of remedies. This last part contains some contingent of personal observation. He is, like all his countrymen, ample in the enumeration of symptoms, and is said to be inferior to Ali in practical medicine and surgery. He introduced into medical theory the four causes of the Peripatetic system. Of natural history and botany he pretends to no special knowledge. Up to the year 1650, or thereabouts, the *Canon* was still used as a text-book in the universities of Louvain and Montpellier.

About 100 treatises are ascribed to Avicenna. Some of them are tracts of a few pages, others are works extending through several volumes. The best-known amongst them, and that to which Avicenna owed his European reputation, is the *Canon of Medicine*; an Arabic edition of it appeared at Rome in 1503, and a Hebrew version at Naples in 1491. Of the Latin version there were about thirty editions, founded on the original translation by Gerard of Cremona. The 15th century has the honour of composing the great commentary on the text of the *Canon*, grouping around it all that theory had imagined, and all that practice had observed. Other medical works translated into Latin are the *Medicamenta Cordialis*, *Canticum de Medicina*, *Tractatus de Symplo Acetoso*. Scarcely any member of the Arabian circle of the sciences, including theology, philology, mathematics, astronomy, physics and music, was left untouched by the treatises of Avicenna, many of which probably varied little, except in being commissioned by a different patron and having a different form or extent. He wrote at least one treatise on alchemy, but several others have been falsely attributed to him. His book on animals was translated by Michael Scot. His *Logic*, *Metaphysics*, *Physics*, *De Caelo*, are treatises giving a synoptic view of Aristotelian doctrine. The *Logic* and *Metaphysics* have been printed more than once, the latter, e.g., at Venice in 1493, 1495 and 1546. Some of his shorter essays on medicine, logic, &c., take a poetical form (the poem on logic was published by Schmoelders in 1836). Two encyclopaedic

treatises, dealing with philosophy, are often mentioned. The larger, *Al-Shifá'* (*Sanatio*), exists nearly complete in manuscript in the Bodleian library and elsewhere; part of it on the *De Anima* appeared at Pavia (1490) as the *Liber Sextus Naturalium*, and the long account of Avicenna's philosophy given by Shah-rastani seems to be mainly an analysis, and in many places a reproduction, of the *Al-Shifá'*. A shorter form of the work is known as the *An-naját* (*Liberatio*). The Latin editions of part of these works have been modified by the corrections which the monkish editors confess that they applied. There is also a *Philosophia Orientalis*, mentioned by Roger Bacon, and now lost, which according to Averroes was pantheistic in tone.

For Avicenna's life, see Ibn Khalikán's *Biographical Dictionary*, translated by McG. de Slane (1842); F. Wüstenfeld's *Geschichte der arabischen Aerzte und Naturforscher* (Göttingen, 1840). For his medicine, see Sprengel, *Histoire de la Médecine*; and for his philosophy, see Shahrastani, German trans. vol. ii. 213-332; K. Prantl, *Geschichte der Logik*, ii. 318-361; A. Stöckl, *Phil. d. Mittelalters*, ii. 23-58; S. Munk, *Mélanges*, 352-366; B. Haneberg in the *Abhandlungen der philos.-philolog. Class. der bayerischen Academie* (1867); and Carra de Vaux, *Avicenne* (Paris, 1900). For list of extant works see C. Brockelmann's *Geschichte der arabischen Litteratur* (Weimar, 1898), vol. i. pp. 452-458. (W. W.; G. W. T.)

AVIENUS, RUFIIUS FESTUS, a Roman aristocrat and poet, of Vulsinii in Etruria, who flourished during the second half of the 4th century A.D. He was probably proconsul of Africa (366) and of Achaia (372). Avienus was a pagan and a staunch supporter of the old religion. He translated the *Φαινόμενα* of Aratus and paraphrased the *Πεπύρηγος* of Dionysius under the title of *Descriptio Orbis Terrarum*, both in hexameters. He also compiled a description, in iambic trimeters, of the coasts of the Mediterranean, Caspian and Black Seas in several books, of which only a fragment of the first is extant. He also epitomized Livy and Virgil's *Aeneid* in the same metre, but these works are lost. Some minor poems are found under his name in anthologies, e.g. a humorous request to one Favianus for some pomegranates for medicinal purposes.

AVIGLIANA, a town of Piedmont, Italy, in the province of Turin, 14 m. W. by rail from the town of Turin. Pop. (1901) 4629. It has medieval buildings of some interest, but is mainly remarkable for its large dynamite factory, employing over 500 workman.

AVIGNON, a city of south-eastern France, capital of the department of Vaucluse, 143 m. S. of Lyons on the railway between that city and Marseilles. Pop. (1906) 35,356. Avignon, which lies on the left bank of the Rhone, a few miles above its confluence with the Durance, occupies a large oval-shaped area not fully populated, and covered in great part by parks and gardens. A suspension bridge leads over the river to Villeneuve-lès-Avignon (q.v.), and a little higher up, a picturesque ruined bridge of the 12th century, the Pont Saint-Bénézet, projects into the stream. Only four of the eighteen piles are left; on one of them stands the chapel of Saint-Bénézet, a small Romanesque building. Avignon is still encircled by the ramparts built by the popes in the 14th century, which offer one of the finest examples of medieval fortification in existence. The walls, which are of great strength, are surmounted by machicolated battlements, flanked at intervals by thirty-nine massive towers and pierced by several gateways, three of which date from the 14th century. The whole is surrounded by a line of pleasant boulevards. The life of the town is almost confined to the Place de l'Hôtel de Ville and the Cours de la République, which leads out of it and extends to the ramparts. Elsewhere the streets are narrow, quiet, and, for the most part, badly paved. At the northern extremity of the town a precipitous rock, the Rocher des Doms, rises from the river's edge and forms a plateau stretching southwards nearly to the Place de l'Hôtel de Ville. Its summit is occupied by a public garden and, to the south of this, by the cathedral of Notre-Dame des Doms and the Palace of the Popes. The cathedral is a Romanesque building, mainly of the 12th century, the most prominent feature of which is the gilded statue of the Virgin which surmounts the western tower. Among the many works of art in the interior, the most beautiful is the mausoleum of Pope John XXII., a masterpiece of Gothic

carving of the 14th century. The cathedral is almost dwarfed by the Palace of the Popes, a sombre assemblage of buildings, which rises at its side and covers a space of more than 1½ acres. Begun in 1316 by John XXII., it was continued by succeeding popes until 1370, and is in the Gothic style; in its construction everything has been sacrificed to strength, and though the effect is imposing, the place has the aspect rather of a fortress than of a palace. It was for long used as a barracks and prison, to the exigencies of which the fine apartments were ruthlessly adapted, but it is now municipal property. Among the minor churches of the town are St Pierre, which has a graceful façade and richly carved doors, St Didier and St Agricol, all three of Gothic architecture. The most notable of the civil buildings are the hôtel de ville, a modern building with a belfry of the 14th century, and the old Hôtel des Monnaies, the papal mint which was built in 1610 and is now used as a music-school. The Calvet Museum, so named after F. Calvet, physician, who in 1810 left his collections to the town, is rich in inscriptions, bronzes, glass and other antiquities, and in sculptures and paintings. The library has over 140,000 volumes. The town has a statue of a Persian, Jean Althen, who in 1765 introduced the culture of the madder plant, which long formed the staple and is still an important branch of local trade. In 1873 John Stuart Mill died at Avignon, and is buried in the cemetery. For the connexion of Petrarch with the town see PETRARCH.

Avignon is subject to violent winds, of which the most disastrous is the *mistral*. The popular proverb is, however, somewhat exaggerated, *Atenio ventosa, sine vento venenosa, cum vento fastidiosa* (windy Avignon, pest-ridden when there is no wind, wind-pestered when there is).

Avignon is the seat of an archbishop and has tribunals of first instance and of commerce, a council of trade-arbitrators, a lycée, and training college, a chamber of commerce and a branch of the Bank of France. It is in the midst of a fertile district, in the products of which it has a large trade, and has flour-mills, distilleries, oil-works and leather-works, manufactures soap, chemicals and liquorice, and is well known for its sarsenet and other fabrics.

Avignon (*Atenio*) was an important town of the Gallic tribe of the Cavares, and under the Romans one of the leading cities of Gallia Narbonensis. Severely harassed during the barbarian invasions and by the Saracens, it was, in later times, attached successively to the kingdoms of Burgundy and of Arles and to the domains of the counts of Provence and of Toulouse and of Forcalquier. At the end of the 12th century it became a republic, but in 1226 was taken and dismantled by Louis VIII. as punishment for its support of the Albigenes, and in 1251 was forced to submit to the counts of Toulouse and Provence. In 1309 the city was chosen by Clement V. as his residence, and from that time till 1377 was the papal seat. In 1348 the city was sold by Joanna, countess of Provence, to Clement VI. After Gregory XI. had migrated to Rome, two antipopes, Clement VII. and Benedict XIII., resided at Avignon, from which the latter was expelled in 1408. The town remained in the possession of the popes, who governed it by means of legates, till its annexation by the National Assembly in 1791, though during this interval several kings of France made efforts to unite it with their dominions. In 1791 conflicts between the adherents of the Papacy and the Republicans led to much bloodshed. In 1815 Marshal Brune was assassinated in the town by the adherents of the royalist party. The bishopric, founded in the 3rd century, became an archbishopric in 1475.

See Fantoni Castrucci, *Storia della città d'Avignone e del Contado Venesino* (Venice, 1678); J. B. Joudou, *Histoire des souverains pontifics qui ont siégé à Avignon* (Avignon, 1855); A. Canron, *Guide de l'étranger dans la ville d'Avignon et ses environs* (Avignon, 1858); J. F. André, *Histoire de la Papauté à Avignon* (Avignon, 1887).

ÁVILA, GIL GONZALEZ DE (c. 1577-1658). Spanish biographer and antiquary, was born and died at Ávila. He was made historiographer of Castile in 1612, and of the Indies in 1621. Of his numerous works, the most valuable are his *Teatro de las Grandezas des Madrid* (Madrid, 1623, sqq.), and his *Teatro Eclesiastico*, descriptive of the metropolitan churches and

cathedrals of Castile, with lives of the prelates (Madrid, 1645-1653, 4 vols. 4to).

ÁVILA, a province of central Spain, one of the modern divisions of the kingdom of Old Castile; bounded on the N. by Valladolid, E. by Segovia and Madrid, S. by Toledo and Cáceres, and W. by Salamanca. Pop. (1900) 200,457; area, 2,570 sq. m. Ávila is naturally divided into two sections, differing completely in soil, climate, productions and social economy. The northern portion is generally level; the soil is of indifferent quality; strong and marly in a few places, but rocky in all the valleys of the Sierra de Ávila; and the climate alternates from severe cold in winter to extreme heat in summer. The population of this part is mainly agricultural. The southern division is one mass of rugged granitic sierras, interspersed, however, with sheltered and well-watered valleys, abounding with rich vegetation. The winter here, especially in the elevated region of the Paramera and the waste lands of Ávila, is long and severe, but the climate is not unhealthy. In this region stock-breeding is an important industry. The principal mountain chains are the Guadarrama, separating this province from Madrid; the Paramera and Sierra de Ávila, west of the Guadarrama; and the vast wall of the Sierra de Gredos along the southern frontier, where its outstanding peaks rise to 6000 or even 8000 ft. The ridges which ramify from the Paramera are covered with valuable forests of beeches, oaks and firs, presenting a striking contrast to the bare peaks of the Sierra de Gredos. The principal rivers are the Alberche and Tietar, belonging to the basin of the Tagus, and the Tórmes, Trabancos and Adaja, belonging to that of the Douro. The mountains contain silver, copper, iron, lead and coal, but their mineral wealth has been exaggerated, and at the beginning of the 20th century mining had practically been abandoned. Quarries of fine marble and jasper exist in the district of Arenas. The province declined in wealth and population during the 18th and 19th centuries, a result due less to the want of activity on the part of the inhabitants than to the oppressive manorial and feudal rights and the strict laws of entail and mortmain, which acted as barriers to progress.

Towards the close of this period many improvements were introduced, although the want of irrigation is still keenly felt. Wide tracts of waste land were planted with pinewoods by the ducal house of Medina Sidonia. The main roads are fairly good; and Ávila, the capital, is connected by rail with Salamanca, Valladolid and Madrid; but in many parts of the province the means of communication are defective. Except Ávila there are no important towns. The principal production is the wool of the merino sheep, which at one time yielded an immense revenue. Game is plentiful, and the rivers abound in fish, specially trout. Olives, chestnuts and grapes are grown, and silk-worms are kept. There is little trade, and the manufactures are few, consisting chiefly of copper utensils, lime, soap, cloth, paper and combs. The state of elementary education is comparatively good, rather more than two-thirds of the population being able to read and write, and the ratio of crime is proportionately low.

ÁVILA (anc. *Abula* or *Avela*), the capital of the province described above; on the right bank of the river Adaja, 54 m. W. by N. of Madrid, by the Madrid-Valladolid railway. Pop. (1900) 11,885. The city is built on the flat summit of a rocky hill, which rises abruptly in the midst of a veritable wilderness; a brown, arid, treeless table-land, strewn with immense grey boulders, and shut in by lofty mountains. The ancient walls of Ávila, constructed of brown granite, and surmounted by a breastwork, with eighty-six towers and nine gateways, are still in excellent repair; but a large part of the city lies beyond their circuit. Ávila is the seat of a bishop, and contains several ecclesiastical buildings of high interest. The Gothic cathedral, said by tradition to date from 1107, but probably of 13th or 14th century workmanship, has the appearance of a fortress, with embattled walls and two solid towers. It contains many interesting sculptures and paintings, besides one especially fine silver pyx, the work of Juan de Arphe, dating from 1571. The churches of San Vicente, San Pedro, Santo Tomás and San

Segundo are, in their main features, Romanesque of the 13th century, although parts of the beautiful San Vicente, and of San Pedro, may be as old as the 12th century. Especially noteworthy is the marble monument in Santo Tomás, carved by the 15th-century Florentine sculptor Domenico Fancelli, over the tomb of Prince John (d. 1497), the only son of Ferdinand and Isabella. The convent and church of Santa Teresa mark the supposed birthplace of the saint whose name they bear (c. 1515-1582). Ávila also possesses an old Moorish castle (*alcázar*) used as barracks, a foundling hospital, infirmary, military academy, and training schools for teachers of both sexes. From 1822 to 1807 it was also the seat of a university. It has a considerable trade in agricultural products, leather, pottery, hats, linen and cotton goods.

For the local history see V. Picatoste, *Tradiciones de Ávila* (Madrid, 1888); and L. Ariz, *Historia de las grandezas de . . . Ávila* (Alcalá de Henares, 1607).

AVILA Y ZUNIGA, LUIS DE (c.1490 - c. 1560), Spanish historian, was born at Placentia. He was probably of low origin, but married a wealthy heiress of the family of Zuniga, whose name he added to his own. He rose rapidly in the favour of the emperor Charles V., served as ambassador to Rome, and was made grand commander of the order of the Knights of Alcántara. He accompanied the emperor to Africa in 1547, and having served during the war of the league of Schmalkalden, wrote a history of this war entitled *Comentarios de la guerra de Alemania, hecha de Carlos V en el año de 1546 y 1547*. This was first printed in 1548, and becoming very popular was translated into French, Dutch, German, Italian and Latin. As may be expected from the author's intimacy with Charles, the book is very partial to the emperor, and its misrepresentations have been severely criticized.

AVILÉS, PEDRO MENÉNDEZ DE (1519-1574), Spanish seaman, founder of St Augustine, Florida, was born at Avilés in Asturias on the 15th of February 1519. His family were gentry, and he was one of nineteen brothers and sisters. At the age of fourteen he ran away to sea, and was engaged till he was thirty in a life of adventure as a corsair. In 1549 during peace between France and Spain he was commissioned by the emperor Charles V. to clear the north coast of Spain and the Canaries of French pirates. In 1554 he was appointed captain-general of the "flota" or convoy which carried the trade between Spain and America. The appointment was made by the emperor over the head and against the will of the Casa de Contratación, or governing board of the American trade. In this year, and before he sailed to America, Avilés accompanied the prince of Spain, afterwards Philip II., to England, where he had gone to marry Queen Mary. As commander of the flota he displayed a diligence, and achieved a degree of success in bringing back treasure, which earned him the hearty approval of the emperor. But his devotion to the imperial service, and his steady refusal to receive bribes as the reward for permitting breaches of the regulations, made him unpopular with the merchants, while his high-handed ways offended the Casa de Contratación. Re-appointed commander in 1557, and knowing the hostility of the Casa, he applied for service elsewhere. The war with France in which Spain and England were allies was then in progress, and until the close of 1559 ample occupation was found for Avilés in bringing money and recruits from Spain to Flanders. When peace was restored he commanded the fleet which brought Philip II. back from the Low Countries to Spain. In 1560 he was again appointed to command the flota, and he made a most successful voyage to America and back, in that and the following year. His relations with the Casa de Contratación were, however, as strained as ever. On his return from another voyage in 1563 he was arrested by order of the Casa, and was detained in prison for twenty months. What the charges brought against him were is not known. Avilés in a letter to the king avows his innocence, and he was finally discharged by the judges, but not until they had received two peremptory orders from the king to come to a decision.

On his release he prepared to sail to the Bermudas to seek for

his son Juan, who had been shipwrecked in the previous year. At that time the French Huguenots were engaged in endeavouring to plant a colony in Florida. As the country had been explored by the Spaniards they claimed it as theirs, and its position on the track of the home-coming trade of Mexico rendered its possession by any other power highly dangerous. Philip II. endeavoured to avert the peril by making an "asiento" or contract with Avilés, by which he advanced 15,000 ducats to the seaman, and constituted him proprietor of any colony which he could establish in Florida, on condition that the money was repaid. The contract was signed on the 20th of March 1565. Avilés sailed on the 28th of July of the same year with one vessel of 600 tons, ten sloops and 1500 men. On the 28th of August he entered and named the Bay of St Augustine, and began a fort there. He took the French post of Fort Caroline on the 20th of September 1565, and in October exterminated a body of Frenchmen who, under the Huguenot Jean Ribault, had arrived on the coast of Florida to relieve their colony. The Spanish commander, after slaying nearly all his prisoners, hung their bodies on trees, with the inscription, "Not as Frenchmen but as Lutherans." A French sea-captain named Dominique de Gourgues revenged the massacre by capturing in 1568 Fort San Mateo (as the Spanish had renamed Fort Caroline), and hanging the garrison, with the inscription, "Not as Spaniards but as murderers." Till 1567 Avilés remained in Florida, busy with his colony. In that year he returned to Spain. He made one more voyage to Florida, and died on the 17th of September 1574. Avilés married María de Solís, when very young, and left three daughters. His letters prove him to have been a pious and high-minded officer, who never imagined that he could be supposed by any honest man to have gone too far in massacring the Frenchmen, whom he regarded as pirates and heretics.

See *The Spanish Settlements within the Present Limits of the United States, Virginia, 1562-1574*, by Woodbury Lowery (New York, 1905). (D. H.)

AVILÉS, or S. N. NICOLÁS DE AVILÉS (the Roman *Flavionavia*), a seaport of northern Spain, in the province of Oviedo; on the Bay of Avilés, a winding inlet of the Bay of Biscay, 24 m. by rail W. of Gijón. Pop. (1900) 12,763. Avilés is a picturesque and old-fashioned town, containing several ancient palaces and Gothic churches. The bay, which is crossed by a fine bridge at its narrow landward extremity, is the headquarters of a fishing fleet, and a port of call for many coasting vessels. Coal from the Oviedo mines is exported coastwise, and in 1904 the shipments from Avilés for the first time exceeded those from Gijón, reaching a total of more than 200,000 tons. Glass and coarse linen and woollen stuffs are manufactured; and there are valuable stone quarries in the neighbourhood.

AVIZANDUM (from Late Lat. *avizare*, to consider), a Scots law term; the judge "makes avizandum with a cause," i.e. takes time to consider his judgment.

AVLONA (anc. *Avlona*; Ital. *Valona*; Alb. *Vliona*), a town and seaport of Albania, Turkey, in the vilayet of Iannina. Pop. (1900) about 6000. Avlona occupies an eminence near the Gulf of Avlona, an inlet of the Adriatic, almost surrounded by mountains. The port is the best on the Albanian coast, and the nearest to Italy. It is protected by the island of Saseno, the ancient Saso, and by Cape Glossa, the northernmost headland of the Acroceraunian mountains. It is regularly visited by steamers from Trieste, Fiume, Brindisi, and other Austro-Hungarian and Italian ports, as well as by many small Greek and Turkish coasters. The cable and telegraph line from Otranto, in Italy, to Constantinople, has an important station here. The town is about 1½ m. from the sea, and has rather a pleasant appearance with its minarets and its palace, surrounded with gardens and olive-groves. Valonia, a material largely used by tanners, is the pericarp of an acorn obtained in the neighbouring oak-woods, and derives its name from Valona. The surrounding district is mainly agricultural and pastoral, producing oats, maize, cotton, olive oil, cattle, sheep, skins, hides and butter. All these commodities are exported in considerable quantities, besides bitumen, which is obtained from a mine worked by a French

company. The imports are woollen and cotton piece-goods, metals and petroleum.

Avlona played an important part in the wars between the Normans and the Byzantines, during the 11th and 12th centuries. In 1464 it was taken by the Ottomans; and after being in Venetian possession in 1690, was restored to them in 1691. In 1851 it suffered severely from an earthquake.

AVOCA, or **Ovoca**, **VALE OF**, a mountain glen of county Wicklow, Ireland, in the south-eastern part of the county, formed by the junction of the small rivers Avonmore and Avonbeg, which, rising in the central highlands of the county, form with their united waters the Ovoca river, flowing south and south-east to the Irish Sea at Arklow. The vale would doubtless rank only as one among the many beautiful glens of the district, but that it has obtained a lasting celebrity through one of the *Irish Melodies* of the poet Thomas Moore, in which its praises are sung. It is through this song that the form "Avoca" is most familiar, although the name is locally spelt "Ovoca." The glen is narrow and densely wooded. Its beauty is somewhat marred by the presence of lead and copper mines, and by the main line of the Dublin & South Eastern railway, on which Ovoca station, midway in the vale, is 42½ m. south of Dublin. Of the two "meetings of the waters" (the upper, of the Avonmore and Avonbeg, and the lower, of the Aughrim with the Ovoca) the upper, near the fine seat of Castle Howard, is that which inspired the poet. At Avondale, above the upper "meeting," by the Avonmore, Charles Stewart Parnell was born.

AVOCADO PEAR, the fruit of the tree *Persea gratissima*, which grows in the West Indies and elsewhere; the flesh is of a soft and buttery consistency and highly esteemed. The name *avocado*, the Spanish for "advocate," is a sound-substitute for the Aztec *ahuacatl*; it is also corrupted into "alligator-pear." *Avocato*, *avigato*, *abbogada* are variants.

AVOGADRO, **AMEDEO**, CONTE DI QUARZAGNA (1776-1856), Italian physicist, was born at Turin on the 9th of June 1776, and died there on the 9th of July 1856. He was for many years professor of higher physics in Turin University. He published many physical memoirs on electricity, the dilatation of liquids by heat, specific heats, capillary attraction, atomic volumes &c. as well as a treatise in 4 volumes on *Fisica di corpi ponderabili* (1837-1841). But he is chiefly remembered for his "Essai d'une manière de déterminer les masses relatives des molécules élémentaires des corps, et les proportions selon lesquelles elles entrent dans les combinaisons" (*Journ. de Phys.*, 1811), in which he enunciated the hypothesis known by his name (Avogadro's rule) that under the same conditions of temperature and pressure equal volumes of all gases contain the same number of smallest particles or molecules, whether those particles consist of single atoms or are composed of two or more atoms of the same or different kinds.

AVOIDANCE (from "avoid," properly to make empty or void, in current usage, to keep away from, to shun; the word "avoid" is adapted from the O. Fr. *evuidier* or *evider*, to empty out, *void*, modern *vide*, empty, connected with Lat. *vacuus*), the action of making empty, void or null, hence, in law, invalidation, annulment (see CONFESION AND AVOIDANCE); also the becoming void or vacant, hence in ecclesiastical law a term signifying the vacancy of a benefice—that it is *void* of an incumbent. In general use, the word means the action of keeping away from anything, shunning or avoiding.

AVOIRDUPOIS, or **AVERDUPOIS** (from the French *avoir de poids*, goods of weight), the name of a system of weights used in Great Britain and America for all commodities except the precious metals, gems and medicines. The foundation of the system is the grain. A cubic inch of water weighs 252.458 grains. Of this grain 7000 now (see WEIGHTS AND MEASURES) make a pound avoirdupois. This pound is divided into 16 oz., and these ounces into 16 drachms.

Avoirdupois Weight.

Drachm, 16 = ounce 16 = pound, 14 = stone, 2 = quarter, 4 = hundred, 20 = ton.
273 grains 437 5 7000 98,000 196,000 grs. 112 lb 2240 lb.

AVON, the name of several rivers in England and elsewhere. The word is Celtic, appearing in Welsh (very frequently) as *afon*, in Manx as *oon*, and in Gaelic as *abhainn* (pronounced *avainn*), and is radically identical with the Sanskrit *ap*, water, and the Lat. *aqua* and *amnis*. The root appears more or less disguised in a vast number of river names all over the Celtic area in Europe. Thus, besides such forms as *Evan*, *Aune*, *Anne*, *Ive*, *Auncy*, *Incky*, &c., in the British Isles, *Aff*, *Avon*, *Avon*, *Aune* appear in Brittany and elsewhere in France, *Aventa* and *Avens* in Italy, *Avia* in Portugal, and *Avono* in Spain; while the terminal syllable of a large proportion of the Latinized names of French rivers, such as the *Sequana*, the *Matrona* and the *Garumna*, seems originally to have been the same word. The names Punjab, *Doab*, &c., show the root in a clearer shape.

In England the following are the principal rivers of this name.

1. THE EAST or HAMPSHIRE AVON rises in Wiltshire south of Marlborough, and watering the Vale of Pewsey collects feeders from the high downs between Marlborough and Devizes. Breaching the high ground of Salisbury Plain, it passes Amesbury, and following a very sinuous course reaches Salisbury. Here it receives on the east bank the waters of the Bourne, and on the west those of the Wylly. With a more direct course, and in a widening, fertile valley it continues past Downton, Fording-bridge and Ringwood, skirting the New Forest on the west, to Christchurch, where it receives the Stour from the west, and 2½ m. lower enters the English Channel through the broad but narrow-mouthed Christchurch harbour. The length, excluding lesser sinuosities, is about 60 m., Salisbury being 35 m. above the mouth. The total fall is rather over 500 ft., and that from Salisbury about 140 ft. The river is of no commercial value for navigation. It abounds in loach, and there are valuable salmon fisheries. The drainage area is 1132 sq. m.

2. THE LOWER or BRISTOL AVON rises on the eastern slope of the Cotteswold Hills in Gloucestershire, collecting the waters of several streams south of Tetbury and east of Malmesbury. It flows east and south in a wide curve, through a broad upper valley past Chippenham and Melksham, after which it turns abruptly west to Bradford-on-Avon, receives the waters of the Frome from the south, and enters the beautiful narrow valley in which lie Bath and Bristol. Below Bristol the valley becomes the Clifton Gorge, famous for its wooded cliffs and for the Clifton (q.v.) suspension bridge which bestrides it. The cliffs and woods have been so far disfigured by quarries that public feeling was aroused, and in 1904 an "Avon Gorge Committee" was appointed to report to the corporation of Bristol on the possibility of preserving the beauties of the locality. The Avon finally enters the estuary of the Severn at Avonmouth, though it can hardly be reckoned as a tributary of that river. From Bristol downward the river is one of the most important commercial waterways in England, as giving access to that great port. The Kennet and Avon Canal, between Reading and the Avon, follows the river closely from Bradford down to Bath, where it enters it by a descent of seven locks. The length of the river, excluding minor sinuosities, is about 75 m., the distance from Bradford to Bath being 10 m., thence to Bristol 12 m., and thence to the mouth 8 m. The total fall is between 500 and 600 ft., but it is only 235 ft. from Malmesbury. The drainage area is 891 sq. miles.

3. THE UPPER AVON, also called the Warwickshire, and sometimes the "Shakespeare" Avon from its associations with the poet's town of Stratford on its banks, is an eastern tributary of the Severn. It rises near Naseby in Northamptonshire, and, with a course of about 100 m. joins the Severn immediately below Tewkesbury in Gloucestershire. Its early course is south-westerly to Rugby, thereafter it runs west and south-west to Warwick, receiving the Leam on the east. Its general direction thereafter remains south-westerly, and it flows past Stratford-on-Avon, receives the Stour on the south and the Arrow on the north and thence past Evesham and Pershore to Tewkesbury. The valley is always broad, and especially from Warwick downward, through the Vale of Evesham, the scenery is very beautiful, the rich valley being flanked by the bold Cotteswold Hills on

the south and by the wooded slopes of the Arden district of Warwickshire on the north. The view of Warwick Castle, rising from the wooded banks of the river, is unsurpassed, and the positions of Stratford and Evesham are admirable. The river is locked, and carries a small trade up to Evesham, 28 m. from Tewkesbury; the locks from Evesham upward to Stratford (17 m.) are decayed, but the weirs, and mill-dams still higher, afford many navigable reaches to pleasure boats. The total fall of the river is about 500 ft.; from Rugby about 230 ft., and from Warwick 120 ft. The river abounds in coarse fish.

Among other occurrences of the name of Avon in Great Britain there may be noted—in England, a stream flowing south-east from Dartmoor in Devonshire to the English Channel; in South Wales, the stream which has its mouth at Aberavon in Glamorganshire; in Scotland, tributaries of the Clyde, the Spey and the Forth.

AVONIAN, in geology, the name proposed by Dr A. Vaughan in 1905 (*Q.J.G.S.* vol. lxi. p. 264) for the rocks of Lower Carboniferous age in the Avon gorge at Bristol. The Avonian stage appears to embrace precisely the same rocks and fossil-zones as the earlier designation "Daninian" (see **CARBONIFEROUS SYSTEM**); but its substages, being founded upon different local conditions and a different interpretation of the zonal fossils, do not correspond exactly with those of the French and Belgian geologists.

	Substages.	ZONES.	Substages.	
Avonian	{	Kidwellian { Dibunophyllum Seminula Clevedonian { Syringophrys Zaphrentis Cleistopora	} Viséen } Tournaisien	} Dinanian

The upper Avonian (Kidwellian) is well developed about Kidwelly in Carmarthenshire. The lower substage (Clevedonian) is well displayed near Clevedon in Somerset.

See A. Vaughan, "The Carboniferous Limestone Series (Avonian) of the Avon Gorge," *Proc. Bristol Naturalists' Soc.*, 4th series, vol. i. pt. 2, 1906, pp. 74-168 (many plates); and T. F. Sibley, "On the Carboniferous Limestone (Avonian) of the Mendip area (Somerset)," *Q.J.G.S.* vol. lxii., 1906, pp. 324-380 (plates). (J. A. H.)

AVONMORE, BARRY YELVERTON, 1st VISCOUNT (1736-1805), Irish judge, was born in 1736. He was the eldest son of Frank Yelverton of Blackwater, Co. Cork. Educated at Trinity College, Dublin, he was for some years an assistant master under Andrew Buck in the Hibernian Academy. In 1761 he married Miss Mary Nugent, a lady of some fortune, and was then enabled to read for the bar. He was called in 1764, his success was rapid, and he took silk eight years afterwards. He sat in the Irish parliament as member successively for the boroughs of Donegal and Carrickfergus, becoming attorney-general in 1782, but was elevated to the bench as chief baron of the exchequer in 1783. He was created (Irish) Baron Avonmore in 1795, and in 1800 (Irish) viscount. Among his colleagues at the Irish bar Yelverton was a popular and charming companion. Of insignificant appearance, he owed his early successes to his remarkable eloquence, which made a great impression on his contemporaries; as a judge, he was inclined to take the view of the advocate rather than that of the impartial lawyer. He gave his support to Grattan and the Whigs during the greater part of his parliamentary career, but in his latter days became identified with the court party and voted for the union, for which his viscounty was a reward. He had three sons and one daughter, and the title has descended in the family.

AVRANCHES, a town of north-western France, capital of an arrondissement in the department of Manche, 87 m. S. of Cherbourg on the Western railway. Pop. (1906) 7186. It stands on a wooded hill, its botanical gardens commanding a fine view westward of the bay and rock of St Michel. At the foot of the hill flows the river Sée, which at high tide is navigable from the sea. The town is surrounded by avenues, which occupy the site of the ancient ramparts, remains of which are to be seen on the north side. Avranches was from 511 to 1790 a bishop's see, held at the end of the 17th century by the scholar Daniel Huet; and its

cathedral, destroyed as insecure in the time of the first French Revolution, was the finest in Normandy. Its site is now occupied by an open square, one stone remaining to mark the spot where Henry II. of England received absolution for the murder of Thomas Becket. The churches of Notre-Dame des Champs and St Saturnin are modern buildings in the Gothic style. The ancient episcopal palace is now used as a court of justice; a public library is kept in the hôtel de ville. In the public gardens there is a statue of General Jean Marie Valhubert, killed at Austerlitz. Avranches is seat of a sub-prefect and has a tribunal of first instance and a communal college. Leather-dressing is the chief industry; steam-sawing, brewing and dyeing are also carried on, and horticulture flourishes in the environs. Trade is in cider, cattle, butter, flowers and fruit, and there are salmon and other fisheries.

Avranches, an important military station of the Romans, was in the middle ages chief place of a county of the duchy of Normandy. It sustained several sieges, the most noteworthy of which, in 1501, was the result of its opposition to Henry IV. In 1639 Avranches was the focus of the peasant revolt against the salt-tax, known as the revolt of the Nu-pieds.

AWADIA and FADNIA, two small nomad tribes of pure Arab blood living in the Bayuda desert, Anglo-Egyptian Sudan, between the wells of Jakdul and Metemna. They are often incorrectly classed as Ja'alin. They own numbers of horses and cattle, the former of the black Dongola breed. At the battle of Abu Klea (17th of January 1885) they were conspicuous for their courage in riding against the British square.

See *Anglo-Egyptian Sudan*, edited by Count Gleichen (London, 1905).

AWAJI, an island belonging to Japan, situated at the eastern entrance of the Inland Sea, having a length of 32 m., an extreme breadth of 16 m., and an area of 218 sq. m., with a population of about 190,000. It is separated on the south from the island of Shikoku by the Naruto channel, through which, in certain conditions of the tide, a remarkable torrential current is set up. The island is celebrated for its exquisite scenery, and also for the fact that it is traditionally reputed to have been the first of the Japanese islands created by the deities Izanagi and Izanami. The loftiest peak is Yuruuba-yama (1098 ft.), the most picturesque Sen-zan (1510 ft.). Awaji is noted for a peculiar manufacture of pottery.

AWARD (from O. Fr. *ewart*, or *esguart*, cf. "reward"), the decision of an arbitrator. (See **ARBITRATION**.)

AWE, LOCH, the longest freshwater lake in Scotland, situated in mid-Argyllshire, 116 ft. above the sea, with an area of nearly 16 sq. m. It has a N.E. to S.W. direction and is fully 23 m. long from Kilchurn Castle to Ford, its breadth varying from $\frac{1}{2}$ of a mile to 3 m. at its upper end, where it takes the shape of a crescent, one arm of which runs towards Glen Orchy, the other to the point where the river Awe leaves the lake. The two ends of the loch are wholly dissimilar in character, the scenery of the upper extremity being majestic, while that of the lower half is pastoral and tame. Of its numerous islands the best-known is Inishail, containing ruins of a church and convent, which was suppressed at the Reformation. At the extreme north-eastern end of the lake, on an islet which, when the water is low, becomes part of the mainland, stand the imposing ruins of Kilchurn Castle. Its romantic surroundings have made this castle a favourite subject of the landscape painter. Dalmally, about 2 m. from the loch, is one of the pleasantest villages in the Highlands and has a great vogue in midsummer. The river Awe, issuing from the north-western horn of the loch, affords excellent trout and salmon fishing.

AWL (O. Eng. *ael*; at one time spelt *awl* by a confusion with the indefinite article before it), a small hand-tool for piercing holes.

AXE (O. Eng. *ax*; a word common, in different forms, in the Teutonic languages, and akin to the Greek ἄξιν; the *New English Dictionary* prefers the spelling "ax"), a tool or weapon, taking various shapes, but, when not compounded with some distinguishing word (e.g. in "pick-axe"), generally formed

by an edged head fixed upon a handle for striking. A "hatchet" is a small sort of axe.

AXHOLME, an island in the north-west part of Lincolnshire, England, lying between the rivers Trent, Idle and Don, and isolated by drainage channels connected with these rivers. It consists mainly of a plateau of slight elevation, rarely exceeding 100 ft., and comprises the parishes of Althorpe, Belton, Epworth, Haxey, Luddington, Owston and Crowle; the total area being about 47,900 acres. At a very early period it would appear to have been covered with forest; but this having been in great measure destroyed, it became in great part a swamp. In 1627 King Charles I., who was lord of the island, entered into a contract with Cornelius Vermuyden, a Dutchman, for reclaiming the meres and marshes, and rendering them fit for tillage. This undertaking led to the introduction of a large number of Flemish workmen, who settled in the district, and, in spite of the violent measures adopted by the English peasantry to expel them, retained their ground in sufficient numbers to affect the physical appearance and the accent of the inhabitants to this day. The principal towns in the isle are Crowle (pop. 2769) and Epworth. The Axholme joint light railway runs north and south through the isle, connecting Goole with Haxey junction; and the Great Northern, Great Eastern and Great Central lines also afford communications. The land is extremely fertile. The name, probably Axyholm (cf. *Axholm*), is hybrid, *Ax* being the Celtic *uisg*, water; *ey* the Anglo-Saxon for island; and *holm* the Norse word with the same signification.

AXILE, or **AXIAL**, a term (=related to the axis) used technically in science; in botany an embryo is called axial when it has the same direction as the axis of the seed.

AXINITE, a mineral consisting of a complex aluminium and calcium borosilicate with a small amount of basic hydrogen; the calcium is partly replaced in varying amounts by ferrous iron and manganese, and the aluminium by ferric iron: the formula is $\text{HCa}_2\text{Al}_2(\text{SiO}_4)_2$. The mineral was named (from ἀξίτης, an axe) by R. J. Haiiy in 1799, on account of the characteristic thin wedge-like form of its anorthic crystals. The colour is usually clove-brown, but rarely it has a violet tinge (on this account the mineral was named yanolite, meaning violet stone, by J. C. Delaméthérie in 1792). The best specimens are afforded by the beautifully developed transparent glassy crystals, found with albite, prhenite and quartz,

in a zone of amphibolite and chlorite-schists at Le Bourg d'Oisans in Dauphiné. It is found in the greenstone and hornblende-schists of Battalack Head near St Just in Cornwall, and in diabase in the Harz; and small ones in Maine and in Northampton county, Pennsylvania, U.S.A. Large crystals have also been found in Japan. In its occurrence in basic rather than in acid eruptive rocks, axinite differs from the borosilicate tourmaline, which is usually found in granite. The specific gravity is 3.28. The hardness of 6½-7, combined with the colour and transparency, renders axinite applicable for use as a gemstone, the Dauphiné crystals being occasionally cut for this purpose. (L. J. S.)

AXIOM (Gr. ἀξίωμα), a general proposition or principle accepted as self-evident, either absolutely or within a particular sphere of thought. Each special science has its own axioms (cf. the Aristotelian ἀρχαί, "first principles") which, however, are sometimes susceptible of proof in another wider science. The Greek word was probably confined by Plato to mathematical axioms, but Aristotle (*Anal. Post.* i. 2) gave it also the wider significance of the ultimate principles of thought which are behind all special sciences (e.g. the principle of contradiction). These are apprehended solely by the mind, which may, however, be led to them by an inductive process. After Aristotle, the term was used by the Stoics and the school of Ramus for a proposition simply, and Bacon (*Nor. Organ.* i. 7) used it of any general proposition. The word was reintroduced in modern philosophy probably by René Descartes (or by his followers)

who, in the search for a definite self-evident principle as the basis of a new philosophy, naturally turned to the familiar science of mathematics. The axiom of Cartesianism is, therefore, the *Cogito ergo sum*. Kant still further narrowed the meaning to include only self-evident (intuitive) synthetic propositions, i.e. of space and time. The nature of axiomatic certainty is part of the fundamental problem of logic and metaphysics. Those who deny the possibility of all non-empirical knowledge naturally hold that every axiom is ultimately based on observation. For the Euclidian axioms see **GEOMETRY**.

AXIS (Lat. for "axle"), a word having the same meaning as axle, and also used with many extensions of this primary meaning. It denotes the imaginary line about which a body or system of bodies rotates, or a line about which a body or action is symmetrically disposed. In geometry, and in geometrical crystallography, the term denotes a line which serves to aid the orientation of a figure. In anatomy, it is, among other uses, applied to the second cervical vertebra, and in botany it means the stem.

AXLE (in Mid. Eng. *axel-tre*, from O. Norweg. *áxull-tre*, cognate with the O. Eng. *axe* or *eaxe*, and connected with Sansk. *áksha*, Gr. ἄξων, and Lat. *axis*), the pin or spindle on which a wheel turns. In carriages the axle-tree is the bar on which the wheels are mounted, the axles being strictly its thinner rounded prolongations on which they actually turn. The pins which pass through the ends of the axles and keep the wheels from slipping off are known as axle-pins or "linch-pins," "linch" being a corruption, due to confusion with "link," of the Old English word for "axle," *lynis*, cf. Ger. *Linse*.

AX - LES - THERMES, a watering place of south-western France, in the department of Ariège, at the confluence of the Ariège with three tributaries, 26 m. S.S.E. of Foix by rail. Pop. (1906) 1179. Ax (Aque), situated at a height of 2300 ft., is well known for its warm sulphur springs (77°-172° F.), of which there are about sixty. The waters, which were used by the Romans, are efficacious in the treatment of rheumatism, skin diseases and other maladies.

AXMINSTER, a market-town in the Honiton parliamentary division of Devonshire, England, on the river Axe, 27 m. E. by N. of Exeter by the London & South-Western railway. Pop. (1901) 2906. The minster, dedicated to St Mary the Virgin, illustrates every style of architecture from Norman to Perpendicular. There are in the chancel two freestone effigies, perhaps of the 14th century, besides three sedilia, and a piscina under arches. Axminster was long celebrated for the admirable quality of its carpets, which were woven by hand, like tapestry. Their manufacture was established in 1755. Their name is preserved, but since the seat of this industry was removed to Wilton near Salisbury, the inhabitants of Axminster have found employment in brush factories, corn mills, timber yards and an iron foundry. Cloth, druggery, cotton, leather, gloves and tapes are also made. Coaxdon House, the birthplace in 1602 of Sir Symonds d'Ewes, the Puritan historian, is about 2 m. distant, and was formerly known as St Calyst.

Axminster (Axemystre) derives its name from the river Axe and from the old abbey church or minster said to have been built by King Æthelstan. The situation of Axminster at the intersection of the two great ancient roads, Binfeld Street and the Fosse Way, and also the numerous earthworks and hill-fortresses in the neighbourhood indicate a very early settlement. There is a tradition that the battle of Brunanburh was fought in the valley of the Axe, and that the bodies of the Danish princes who perished in action were buried in Axminster church. According to Domesday, Axminster was held by the king. In 1246 Reginald de Mohun, then lord of the manor, founded a Cistercian abbey at Newenham within the parish of Axminster, granting it a Saturday market and a fair on Midsummer day, and the next year made over to the monks from Beaulieu the manor and hundred of Axminster. The abbey was dissolved in 1539. The midsummer fair established by Reginald de Mohun is still held.

See *Victoria County History—Devon*; James Davidson, *British and Roman Remains in the Vicinity of Axminster* (London, 1833).

AXOLOTL, the Mexican name given to larvae salamanders of the genus *Amblystoma*. It required the extraordinary acumen of the great Cuvier at once to recognize, when the first specimens

of the *Gyrinus edulis* or *Axolotl* of Mexico were brought to him by Humboldt in the beginning of the 19th century, that these Batrachians were not really related to the Perennibranchiates, such as *Siren* and *Proteus*, with which he was well acquainted, but represented the larval form of some air-breathing salamander. Little heed was paid to his opinion by most systematists, and when, more than half a century later, the axolotl was found to breed in its branchiferous condition, the question seemed to be settled once for all against him, and the genus *Siredon*, as it was called by J. Wagler, was unanimously maintained and placed among the permanent gill-breathers.

It seemed impossible to admit that an animal which lives for years without losing its gills, and is able to propagate in that state, could be anything but a perfect form. And yet subsequent discoveries, which followed in rapid succession, have established that *Siredon* is but the larval form of the salamander *Amblystoma*, a genus long known from various parts of North America; and Cuvier's conclusions now read much better than they did half a century after they were published. Before reviewing the history of these discoveries, it is desirable to say a few words of the characters of the axolotl (larval form) and of the *Amblystoma* (perfect or imago form).

The axolotl has been known to the Mexicans from the remotest times, as an article of food regularly brought from neighbouring lakes to the Mexico market, its flesh being agreeable and wholesome. Francisco Hernandez (1514-1578) has alluded to it as *Gyrinus edulis* or *atolocali*, and as *Iusis aquarum*, *piscis ludicrus*, or *axolotl*, which latter name has remained in use, in Mexico and elsewhere, to the present day. But for its large size—it grows to a length of eleven inches—it is a nearly exact image of the British newt larvae. It has the same moderately long, plump body, with a low dorsal crest, the continuation of the membrane bordering the strongly compressed tail; a large thick head with small eyes without lids and with a large pendent upper lip; two pairs of well-developed limbs, with free digits; and above all, as the most characteristic feature, three large appendages on each side of the back of the head, fringed with filaments which, in their fullest development, remind one of black ostrich feathers. These are the external gills, through which the animal breathes the oxygen dissolved in the water. The jaws are provided with small teeth in several rows, and there is an elongate patch of further teeth on each side of the front of the palate (inserted on the vomerine and palatine bones). The colour is blackish, or of a dark olive-grey or brownish grey with round black spots or dots.

The genus *Amblystoma* was established by J. J. Tschudi in 1838 for various salamanders from North America, which had previously been described as *Lacerta* or *Salamandra*, and which, so far as general appearance is concerned, differ little from the European salamanders. The body is smooth and shiny, with vertical grooves on the sides, the tail is but feebly compressed, the eye is moderately large and provided with movable lids, and the upper lip is nearly straight. But the dentition of the palate is very different; the small teeth, which are in a single row, as in the jaws, form a long transverse, continuous or interrupted series behind the inner nares or choanae. The animal leaves the water after completing its metamorphosis, the last stage of which is marked by the loss of the gills. One of the largest and most widely distributed species of this genus, which includes about twenty, is the *Amblystoma tigrinum*, an inhabitant of both the east and west of the United States and of a considerable part of the cooler parts of Mexico. It varies much in colour, but it may be described as usually brown or blackish, with more or less numerous yellow spots, sometimes arranged in transverse bands. It rarely exceeds a length of nine inches. This is the *Amblystoma* into which the axolotl has been ascertained to transform. It is generally admitted that the axolotls which were kept alive in Europe and were particularly abundant between 1870 and 1880 are all the descendants of a stock bred in Paris and distributed chiefly by dealers, originally, we believe, by the late P. Carbonnier. Close in-breeding without the infusion of new blood is probably the cause of the decrease in their numbers at the present day, specimens being more difficult to procure and

fetching much higher prices than they did formerly, at least in England and in France.

The original axolotls, from the vicinity of Mexico City, it is believed, arrived at the Jardin d'Acclimatation, Paris, late in 1863. They were thirty-four in number, among which was an albino, and had been sent to that institution, together with a few other animals, by order of Marshal Forey, who was appointed commander-in-chief of the French expeditionary force to Mexico after the defeat of General Lorencez at Puebla (May 5th, 1862), and returned to France at the end of 1863, after having handed over the command to Marshal (then General) Bazaine. Six specimens (five males and one female) were given by the Société d'Acclimatation to Professor A. Duméril, the administrator of the reptile collection of the Jardin des Plantes, the living specimens of which were at that time housed in a very miserable structure, situated at a short distance from the comparatively sumptuous building which was erected some years later and opened to the public in 1874. Soon after their arrival at the Jardin d'Acclimatation, some of the axolotls spawned, but the eggs, not having been removed from the aquarium, were devoured by its occupants. At the same time, in the Jardin des Plantes, the single female axolotl also spawned, twice in succession, and a large number of young were successfully reared. This, it then seemed, solved the often-discussed question of the perennibranchiate nature of these Batrachians. But a year later, the second generation having reached sexual maturity, new broods were produced, and out of these some individuals lost their gills and dorsal crest, developed movable eyelids, changed their dentition, and assumed yellow spots,—in fact, took on all the characters of *Amblystoma tigrinum*. However, these transformed salamanders, of which twenty-nine were obtained from 1865 to 1870, did not breed, although their branchiate brethren continued to do so very freely. It was not until 1876 that the axolotl in its *Amblystoma* state, offspring of several generations of perennibranchiates, was first observed to spawn, and this again took place in the reptile house of the Jardin des Plantes, as reported by Professor E. Blanchard.

The original six specimens received in 1864 at the Jardin des Plantes, which had been carefully kept apart from their progeny, remained in the branchiate condition, and bred eleven times from 1865 to 1868, and, after a period of two years' rest, again in 1870. According to the report of Aug. Duméril, they and their offspring gave birth to 9000 or 10,000 larvae during that period. So numerous were the axolotls that the Paris Museum was able to distribute to other institutions, as well as to dealers and private individuals, over a thousand examples, which found their way to all parts of Europe, and numberless specimens have been kept in England from 1866 to the present day. The first specimens exhibited in the London Zoological Gardens, in August 1864, were probably part of the original stock received from Mexico by the Société d'Acclimatation, but do not appear to have bred.

"White" axolotls, albinos of a pale flesh colour, with beautiful red gills, have also been kept in great numbers in England and on the continent. They are said to be all descendants of one albino male specimen received in the Paris Museum menagerie in 1866, which, paired with normal specimens in 1867 and 1868, produced numerous white offspring, which by selection have been fixed as a permanent race, without, according to L. Vaillant, showing any tendency to reversion. We are not aware of any but two of these albinos having ever turned into the perfect *Amblystoma* form, as happened in Paris in 1870, the albinism being retained.

Thus we see that in our aquariums most of the axolotls remain in the branchiate condition, transformed individuals being on the whole very exceptional. Now it has been stated that in the lakes near Mexico City, where it was first discovered, the axolotl never transforms into an *Amblystoma*. This the present writer is inclined to doubt, considering that he has received examples of the normal *Amblystoma tigrinum* from various parts of Mexico, and that Alfred Dugès has described an *Amblystoma* from mountains near Mexico City; at the same time he feels very

suspicious of the various statements to that effect which have appeared in so many works, and rather disposed to make light of the ingenious theories launched by biological speculators who have never set foot in Mexico, especially Weismann's picture of the dismal condition of the salt-incrusted surroundings which were supposed to have hemmed in the axolotl—the brackish Lago de Texcoco, the largest of the lakes near Mexico, being evidently in the philosopher's mind.

Thanks to the enthusiasm of H. Gadow during his visit to Mexico in the summer of 1902, we are now better informed on the conditions under which the axolotl lives near Mexico City. First, he ascertained that there are no axolotls at all in the Lago de Texcoco, thus disposing at once of the Weismannian explanation; secondly, he confirmed A. Dugès's statement that there is a second species of *Amblystoma*, which is normal in its metamorphosis, near Mexico but at a higher altitude, which may explain Velasco's observation that regularly transforming *Amblystomas* occur near that city; and thirdly, he made a careful examination of the two lakes, Chalco and Xochimilco, where the axolotls occur in abundance and are procured for the market. The following is an abstract of Gadow's very interesting account. "Lakes Chalco and Xochimilco are a paradise, situated about 10 ft. higher than the Texcoco Lake and separated from it by several hills. High mountains slope down to the southern shores, with a belt of fertile pastures, with shrubs and trees and little streams, here and there with rocks and ravines. In fact, there are thousands of inviting opportunities for newts to leave the lake if they wanted to do so. Lake Xochimilco contains powerful springs, but away from them the water appears dark and muddy, full of suspended fresh and decomposing vegetable matter, teeming with fish, larvae of insects, *Daphniae*, worms and axolotl. These breed in the beginning of February. The native fishermen know all about them; how the eggs are fastened to the water plants, how soon after the little larvae swarm about in thousands, how fast they grow, until by the month of June they are all grown into big, fat creatures ready for the market; later in the summer the axolotls are said to take to the rushes, in the autumn they become scarce, but none have ever been known to leave the water or to metamorphose, nor are any perfect *Amblystomas* found in the vicinity of the two lakes."

In Gadow's opinion, the reason why there are only perennibranchiate axolotls in these lakes is obvious. The constant abundance of food, stable amount of water, innumerable hiding-places in the mud, under the banks, amongst the reeds and roots of the floating islands which are scattered all over them,—all these points are inducements or attractions so great that the creatures remain in their paradise and consequently retain all those larval features which are not directly connected with sexual maturity. There is nothing whatever to prevent them from leaving these lakes, but there is also nothing to induce them to do so. The same applies occasionally to European larvae, as in the case observed in the Italian Alps by F. de Filippi. Nevertheless, in the axolotl the latent tendency can still be revived, as we have seen above and as is proved by the experiments of Marie von Chauvin. When once sexually ripe the axolotl are apparently incapable of changing, but their ancestral course of evolution is still latent in them, and will, if favoured by circumstances, reappear in following generations.

BIBLIOGRAPHY.—G. Cuvier, *Mém. Inst. Nat.* (1807), p. 149, and in A. Humboldt and A. Bonpland, *Observ. zool.* i. (1811), p. 93; L. Calori, *Mem. Acc. Bologna*, iii. (1851), p. 269; A. Dumeril, *Comptes rendus*, lx. (1865), p. 765, and *N. Arch. Mus.* ii. (1866), p. 265; E. Blanchard, *Comptes rendus*, lxxxii. (1876), p. 716; A. Weismann, *Z. wiss. Zool.* xxv. (Suppl. 1875), p. 297; M. von Chauvin, *Z. wiss. Zool.* xxvii. (1876), p. 522; F. de Filippi, *Arch. p. la zool.* i. (1862), p. 206; G. Hahn, *Rev. Quet. Sci. Brussels* (2), i. (1892), p. 178; H. Gadow, *Nature*, lxxvii. (1903), p. 330. (G. A. B.)

AXUM, or **AKSUM**, an ancient city in the province of Tigré, Abyssinia ($14^{\circ} 7' 52''$ N., $38^{\circ} 31' 10''$ E.; altitude, 7226 ft.), 12 m. W. by S. of Adowa. Many European travellers have given descriptions of its monuments, though none of them has stayed there more than a few days. The name, written Aksum and Aksum in the Sabæan and Ethiopic inscriptions in the place,

is found in classical and early Christian writers in the forms of Auxome, Axumis, Axume, &c., the first mention being in the *Periplus Maris Erythraei* (c. A.D. 67), where it is said to be the seat of a kingdom, and the emporium for the ivory brought from the west. For the history of this kingdom see ETHIOPIA. J. T. Bent conjectured that the seat of government was transferred to Axum from Jeha, which he identified with the ancient Ava; and according to a document quoted by Achille Raffray the third Christian monarch transferred it from Axum to Lalibela. This second transference probably took place very much later; in spite of it, the custom of crowning Abyssinian kings at Axum continued, and King John was crowned there as late as 1871 or 1872. A. B. Wyde conjectures that it had become unsuitable for a royal seat by having acquired the status of a sacred city, and thus affording sanctuary to criminals and political offenders within the chief church and a considerable area round it, where there are various houses in which persons can be lodged and entertained. This same sanctity makes it serve as a depository for goods of all sorts in times of danger, the chief church forming a sort of bank. The present town, containing less than a thousand houses, is supposed to occupy only a small portion of the area covered by the ancient city; it lies in a kloof or valley, but the old town must have been built on the western ridge rather than in the valley, as the traces of well-dressed stones are more numerous there than elsewhere.

Most of the antiquities of Axum still await excavation; those that have been described consist mainly of obelisks, of which about fifty are still standing, while many more are fallen. They form a consecutive series from rude unheaved stones to highly finished obelisks, of which the tallest still erect is 60 ft. in height, with 8 ft. 7 in. extreme front width; others that are fallen may have been taller. The highly finished monoliths are all representations of a many-storied castle, with an altar at the base of each. They appear to be connected with Semitic sun-worship, and are assigned by Bent to the same period as the temple at Baalbek, though some antiquarians would place them much earlier; the representation of a castle in a single stone seems to bear some relation to the idea worked out in the monolith churches of Lalibela described by Raffray. The fall of many of the monuments, according to Bent, was caused by the washing away of the foundations by the stream called Mai Shum, and indeed the native tradition states that "Gudert, queen of the Amhara," when she visited Axum, destroyed the chief obelisk in this way by digging a trench from the river to its foundation. Others attribute it to religious fanaticism, or to the result of some barbaric invasion, such as Axum may have repeatedly endured before it was sacked by Mahomed Gran, sultan of Harrar, about 1535.

LITERATURE.—Classical references to Axum are collected by Pletschmann in Pauly's *Realencyclopädie* (2nd ed.); for the history as derived from the inscriptions see D. H. Müller, Appendix to J. T. Bent's *Sacred City of the Ethiopians* (London, 1893), and E. Glaser, *Die Abessinier in Arabien* (Munich, 1895). For the antiquities, Bruce's *Travels* (1790); Salt, in the *Travels of Viscount Valentia* (London, 1806), iii. 87-97 and 178-200; J. T. Bent, *l.c.*; and A. B. Wyde, *Modern Abyssinia* (London, 1901). For geology, Schimper, in the *Zeitschrift der Gesellschaft für Erdkunde* (Berlin, 1866). (D. S. M.)*

AY, AYE. The word "aye," meaning *always* (and pronounced as in "day"); connected with Gr. *ai*, always, and Lat. *æum*, an age), is often spelt "ay," and the *New English Dictionary* prefers this. "Aye," meaning *Yes* (and pronounced almost like the word "eye"), though sometimes identified with "yea," is probably the same word etymologically, though differentiated by usage; the form "ay" for this is also common, but inconvenient; at one time it was spelt simply *I* (e.g. in Michael Drayton's *Idea*, 57; published in 1593).

AYACUCHO, a city and department of central Peru, formerly known as Guamanga or Huamanga, renamed from the small plain of Ayacucho (*Quichua*, "corner of death"). This lies near the village of Quinua, in an elevated valley 11,600 ft. above sea-level, where a decisive battle was fought between General Sucre and the Spanish viceroy La Serna in 1824, which resulted in the defeat of the latter and the independence of Peru. The city of Ayacucho, capital of the department of that name

and of the province of Guamanga, is situated on an elevated plateau, 8911 ft. above sea-level, between the western and central Cordilleras, and on the main road between Lima and Cuzco, 304 m. from the former by way of Jauja. Pop. (1896) 20,000. It has an agreeable, temperate climate, is regularly built, and has considerable commercial importance. It is the seat of a bishopric and of a superior court of justice. It is distinguished for the number of its churches and conventual establishments, although the latter have been closed. The city was founded by Pizarro in 1539 and was known as Guamanga down to 1825. It has been the scene of many notable events in the history of Peru.

The department of AVACUCHO extends across the great plateau of central Peru, between the departments of Huancavelica and Apurímac, with Cuzco on the E. and Ica on the W. Area, 18,185 sq. m.; pop. (1896) 302,469. It is divided into six provinces, and covers a broken, mountainous region, partially barren in its higher elevations but traversed by deep, warm, fertile valleys. It formed a part of the original home of the Incas and once sustained a large population. It produces Indian corn and other cereals and potatoes in the colder regions, and tropical fruits, sweet potatoes and mandioca (*Jatropha manihot*, L.) in the low tropical valleys. It is also an important mining region, having a large number of silver mines in operation. Its name was changed from Guamanga to Ayacucho by a decree of 1825.

AYAH, a Spanish word (*aya*) for children's nurse or maid, introduced by the Portuguese into India and adopted by the English to denote their native nurses.

AYALA, DON PEDRO LOPEZ DE (1332-1407), Spanish statesman, historian and poet, was born at Vittoria in 1332. He first came into prominence at the court of Peter the Cruel, whose cause he finally deserted; he greatly distinguished himself in subsequent campaigns, during which he was twice made prisoner, by the Black Prince at Nájera (1367) and by the Portuguese at Aljubarrota (1385). A favourite of Henry II. and John I. of Castile, he was made grand chancellor of the realm by Henry III. in 1398. A brave officer and an able diplomat, Ayala was one of the most cultivated Spaniards of his time, at once historian, translator and poet. Of his many works the most important are his chronicles of the four kings of Castile during whose reigns he lived; they give a generally accurate account of scenes and events, most of which he had witnessed; he also wrote a long satirical and didactic poem, interesting as a picture of his personal experiences and of contemporary morality. The first part of his chronicle, covering only the reign of Peter the Cruel, was printed at Seville in 1495; the first complete edition was printed in 1779-1780 in the collection of *Crónicas Españolas*, under the auspices of the Spanish Royal Academy of History. Ayala died at Calahorra in 1407.

See Rafael Floranes, "Vida literaria de Pedro Lopez de Ayala," in the *Documentos inéditos para la historia de España*, vols. xix. and xx.; P. W. Schirmacher, "Über die Glaubwürdigkeit der Chronik Ayalas," in *Geschichte von Spanien* (Berlin, 1902), vol. v. pp. 510-532.

AYALA Y HERRERA, ADELARDO LOPEZ DE (1828-1879), Spanish writer and politician, was born at Guadalcanal on the 1st of May 1828, and at a very early age began writing for the theatre of his native town. The titles of these juvenile performances, which were played by amateurs, were *Pañal por donde saliere*, *Me voy á Sevilla* and *La Corona y el Puñal*. As travelling companies never visited Guadalcanal, and as ladies took no part in the representations, these three plays were written for men only. Ayala persuaded his sister to appear as the heroine of his comedy, *La primera Dama*, and the innovation, if it scandalized some of his townsmen, permitted him to develop his talent more freely. In his twentieth year he matriculated at the university of Seville, but his career as a student was undistinguished. In Seville he made acquaintance with Garcia Gutierrez, who is reported to have encouraged his dramatic ambitions and to have given him the benefit of his own experience as a playwright. Early in 1850 Ayala removed his name from the university books, and settled in Madrid with the purpose of becoming a professional dramatist. Though he had no friends and no influence, he speedily found an opening. A four-

act play in verse, *Un Hombre de Estado*, was accepted by the managers of the Teatro Español, was given on the 25th of January 1851, and proved a remarkable success. Henceforward Ayala's position and popularity were secure. Within a twelve-month he became more widely known by his *Castigo y Perdón*, and by a more humorous effort, *Los dos Guzmanes*; and shortly afterwards he was appointed by the *Moderado* government to a post in the home office, which he lost in 1854 on the accession to power of the Liberal party. In 1854 he produced *Rioja*, perhaps the most admired and the most admirable of all his works, and from 1854 to 1856 he took an active part in the political campaign carried on in the journal *El Padre Cobos*. A *zarzuela*, entitled *Guerta a muerte*, for which Emilio Arrieta composed the music, belongs to 1855, and to the same collaboration is due *El Agente de Matrimonios*. At about this date Ayala passed over from the Moderates to the Progressives, and this political manœuvre had its effect upon the fate of his plays. The performances of *Los Comunereros* were attended by members of the different parties; the utterances of the different characters were taken to represent the author's personal opinions, and every speech which could be brought into connexion with current politics was applauded by one half of the house and derided by the other half. A *zarzuela*, named *El Conde de Castrolla*, was given amid much uproar on the 20th of February 1856, and, as the piece seemed likely to cause serious disorder in the theatre, it was suppressed by the government after the third performance. Ayala's rupture with the Moderates was now complete, and in 1857, through the interest of O'Donnell, he was elected as Liberal deputy for Badajoz. His political changes are difficult to follow, or to explain, and they have been unsparingly censured. So far as can be judged, Ayala had no strong political views, and drifted with the current of the moment. He took part in the revolution of 1868, wrote the "Manifiesto of Cadiz," took office as colonial minister, favoured the candidature of the duc de Montpensier, resigned in 1871, returned to his early Conservative principles, and was a member of Alfonso XII.'s first cabinet. Meanwhile, however divided in opinion as to his political conduct, his countrymen were practically unanimous in admiring his dramatic work; and his reputation, if it gained little by *El Nuevo Don Juan*, was greatly increased by *El Tanto por Ciento* and *El Tejado de Vidrio*. His last play, *Consuelo*, was given on the 30th of March 1878. Ayala was nominated to the post of president of congress shortly before his death, which occurred unexpectedly on the 30th of January 1879. The best of his lyrical work, excellent for finish and intense sincerity, is his *Epístola* to Emilio Arrieta, and had he chosen to dedicate himself to lyric poetry, he might possibly have ranked with the best of Spain's modern singers; as it is, he is a very considerable poet who affects the dramatic form. In his later writings he deals with modern society, its vices, ideals and perils; yet in many essentials he is a manifest disciple of Calderon. He has the familiar Calderonian limitations; the substitution of types for characters, of eloquence for vital dialogue. Nor can he equal the sublime lyricism of his model; but he is little inferior in poetic conception, in dignified idealization, and in picturesque imagery. And it may be fairly claimed for him that in *El Tejado de Vidrio* and *El Tanto por Ciento* he displays a very exceptional combination of satiric intention with romantic inspiration. By these plays and by *Rioja* and *Consuelo* he is entitled to be judged. They will at least ensure for him an honourable place in the history of the modern Spanish theatre.

A complete edition of his dramatic works, edited by his friend and rival Tamayo y Baus, has been published in seven volumes (Madrid, 1881-1885). (J. F.-K.)

AYE-AYE, a word of uncertain signification (perhaps only an exclamation), but universally accepted as the designation of the most remarkable and aberrant of all the Malagasy lemurs (see PRIMATES). The aye-aye, *Chiromys* (or *Daubentonia*) *madagascariensis*, is an animal with a superficial resemblance to a long-haired and dusky-coloured cat with unusually large eyes. It has a broad rounded head, short face, large naked eyes, large hands, and long thin fingers with pointed claws, of which the

third is remarkable for its extreme slenderness. The foot resembles that of the other lemurs in its large opposable great toe with a flat nail; but all the other toes have pointed compressed claws. Tail long and bushy. General colour dark brown, the outer fur being long and rather loose, with a woolly under-coat. Teats two, inguinal in position. The aye-aye was discovered by Pierre Sonnerat in 1780, the specimen brought to Paris by that traveller being the only one known until 1860. Since then many others have been obtained, and one lived for several years in the gardens of the Zoological Society of London. Like so many lemurs, it is completely nocturnal in its habits, living either alone or in pairs, chiefly in the bamboo forests. Observations upon captive specimens have led to the conclusion that it feeds principally on juices, especially of the sugar-cane, which it obtains by tearing open the hard woody circumference of the stalk with its strong incisor teeth; but it is said also to devour certain species of wood-boring caterpillars, which it obtains by first cutting down with its teeth upon their burrows, and then picking them out of their retreat with the claw of its attenuated middle finger. It constructs large ball-like nests of dried leaves, lodged in a fork of the branches of a large tree, and with the opening on one side.

Till recently the aye-aye was regarded as representing a family by itself—the *Chiromyidae*; but the discovery that it resembles the other lemurs of Madagascar in the structure of the inner ear, and thus differs from all other members of the group, has led to the conclusion that it is best classed as a subfamily (*Chiromyinae*) of the Lemuridae. (R. L.*)

AYLESBURY, a market-town in the Aylesbury parliamentary division of Buckinghamshire, England, 38 m. N.W. by W. of London; served by the Great Central, Metropolitan and Great Western railways (which use a common station) and by a branch of the London & North-Western railway. Pop. of urban district (1901) 9243. It has connexion by a branch with the Grand Junction canal. It lies on a slight eminence in a fertile tract called the Vale of Aylesbury, which extends northward from the foot of the Chiltern Hills. Its streets are mostly narrow and irregular, but picturesque. The church of St Mary, a large cruciform building, is primarily Early English, but has numerous additions of later dates. The font is transitional Norman, a good example; and a small pre-Norman crypt remains beneath part of the church. There are some Decorated canopied tombs, and the chancel stalls are of the 15th century. The central tower is surmounted by an ornate clock-turret dating from the second half of the 17th century. The county-hall and town-hall, overlooking a broad market-place, are the principal public buildings. The grammar school was founded in 1611. Aylesbury is the assize town for the county, though Buckingham is the county town. There is a large agricultural trade, the locality being especially noted for the rearing of ducks; straw-plaiting and the manufacture of condensed milk are carried on, and there are printing works. The Jacobean mansion of Hartwell in the neighbourhood of Aylesbury was the residence of the French king Louis XVIII. during his exile (1810-1814).

Aylesbury (Æylesburge, Eilesberia, Aillesbir) was famous in Saxon times as the supposed burial-place of St Osith. In A.D. 571 it was one of the towns captured by Cuthwulf, brother of Ceawlin, king of the Saxons. At the time of the Domesday survey the king owned the manor. In 1554, by a charter from Queen Mary, bestowed as a reward for fidelity during the rebellion of the duke of Northumberland, Aylesbury was constituted a free borough corporate, with a common council consisting of a bailiff, 10 aldermen and 12 chief burgesses. The borough returned two members to parliament from this date until the Redistribution Act of 1885, but the other privileges appear to have lapsed in the reign of Elizabeth. Aylesbury evidently had a considerable market from very early times, the tolls being assessed at the time of Edward the Confessor at £25 and at the time of the Domesday survey at £10. In 1239 Henry III. made a grant to John, son of Geoffrey FitzPeter of an annual fair at the feast of St Oath (June 3rd), which was confirmed by Henry VI. in 1440. Queen Mary's charter instituted a Wednesday market and fairs at the feasts of the Annunciation and the Invention of the Holy Cross. In 1570 John Pakington obtained a grant of two annual fairs to be held on the day before Palm Sunday and on the feast of the Invention of the Holy Cross, and a Monday market for the sale of horses and other animals, grain and merchandise.

AYLESFORD, HENEAGE FINCH, 1ST EARL OF (c. 1649-1710), 2nd son of Heneage Finch, 1st earl of Nottingham, was educated at Westminster school and at Christ Church, Oxford, where he matriculated on the 18th of November 1664. In 1673 he became a barrister of the Inner Temple; king's counsel and bench in 1677; and in 1679, during the chancellorship of his father, was appointed solicitor-general, being returned to parliament for Oxford University, and in 1685 for Guildford. In 1682 he represented the crown in the attack upon the corporation of London, and next year in the prosecution of Lord Russell, when, according to Burnet, "and in several other trials afterwards, he showed more of a vicious eloquence in turning matters with some subtlety against the prisoners than of strict or sincere reasoning."¹ He does not, however, appear to have exceeded the duties of prosecutor for the crown as they were then understood. In 1684, in the trial of Algernon Sidney, he argued that the unpublished treatise of the accused was an overt act, and supported the opinion of Jeffreys that *scribere est agere*.² The same year he was counsel for James in his successful action against Titus Oates for libel, and in 1685 prosecuted Oates for the crown for perjury. Finch, however, though a Tory and a crown lawyer, was a staunch churchman, and on his refusal in 1686 to defend the royal dispensing power he was summarily dismissed by James. He was the leading counsel in June 1688 for the seven bishops, when he "strangely exposed and very boldly ran down" the dispensing power, but his mistaken tactics were nearly the cause of his clients losing their case.⁴ He sat again for Oxford University in the convention parliament, which constituency he represented in the following assemblies except that of 1698, till his elevation to the peerage. He was, however, no supporter of the House of Orange, advocated a regency in James's name, and was one of the few who in the House of Commons opposed the famous vote that James had broken the contract between king and people and left the throne vacant. He held no office during William's reign, and is described by Macky as "always a great opposer" of the administration. In 1689 he joined in voting for the reversal of Lord Russell's attainder, and endeavoured to defend his conduct in the trial, but was refused a hearing by the House. He opposed the Triennial Bill of 1692, but in 1696 spoke against the bill of association and test, which was voted for the king's protection, on the ground that though William was to be obeyed as sovereign he could not be acknowledged "rightful and lawful king." In 1694 he argued against the crown in the bankers' case. In 1703 he was created baron of Guernsey and a privy councillor, and after the accession of George I. on the 19th of October 1714, earl of Aylesford, being reappointed a privy councillor and made chancellor of the duchy of Lancaster, which office he retained till February 1716. He died on the 22nd of July 1719. According to John Macky (*Memoirs*, p. 71; published by Roxburghe Club, 1895) he was accounted "one of the greatest orators in England and a good common lawyer; a firm asserter of the prerogative of the crown and jurisdiction of the church; a tall, thin, black man, splenetic." He married Elizabeth, daughter and co-heiress of Sir John Banks of Aylesford, by whom, besides six daughters, he had three sons, of whom the eldest, Heneage, succeeded him as 2nd earl of Aylesford. The 2nd earl died in 1757, and since this date the earldom has been held by his direct descendants, six of whom in succession have borne the Christian name of Heneage.

Many of his legal arguments are printed in *State Trials* (see esp. viii. 604, 1087, ix. 625, 880, 996, x. 126, 319, 405, 1199, xii. 183, 353, 365). Wood attributes to him on the faith of common rumour the authorship of *An Antidote against Poison*. . . Remarks upon a Paper printed by Lady (Rachel) Russel (1683); ascribed in *State Trials* (x. 710) to Sir Bartholomew Shower; but see the latter's allusion to it on p. 753.

¹ *Hist. of His Own Times*, i. 556. Swift has appended a note, "an arrant rascal," but Finch's great offence with the dean was probably his advancement by George I. rather than his conduct of state trials as here described.

² *Ibid.* 572, and Speaker Onslow's note.

³ N. Luttrell's *Relation*, l. 447.

⁴ *State Trials*, xii. 353.

AYLESFORD, a town in the Medway parliamentary division of Kent, England, $3\frac{1}{2}$ m. N.W. of Maidstone on the South-Eastern & Chatham railway. Pop. (1901) 2678. It stands at the base of a hill on the right bank of the Medway. The ancient church of St Peter (restored in 1878) is principally Perpendicular, but contains some Norman and Decorated portions. It has interesting brasses of the 15th and 16th centuries and an early embattled tower. At a short distance west, a residence occupying part of the site, are remains of a Carmelite friary, founded here in 1240. It is claimed for this foundation (but not with certainty) that it was the first house of Carmelites established in England, and the first general chapter of the order was held here in 1245. Several remains of antiquity exist in the neighbourhood, among them a cromlech called Kit's Coty House, about a mile north-east from the village. (See **STONE MONUMENTS**, Plate, fig. 2.) In accordance with tradition this has been thought to mark the burial-place of Catigern, who was slain here in a battle between the Britons and Saxons in A.D. 455; the name has also been derived from Celtic *Ked-coit*, that is, the tomb in the wood. The name of the larger group of monuments close by, called the Countess Stones, is due to the popular belief, which occurs elsewhere, that they are not to be counted. Large numbers of British coins have been found in the neighbourhood. The supposed tomb of Horsa, who fell in the same battle, is situated at Horsted, about 2 m. to the north.

AYLLON, LUCAS VASQUEZ DE (c. 1475-1526), Spanish adventurer and colonizer in America, was born probably in Toledo, Spain, about 1475. He accompanied Nicolas Ovando to Hispaniola (Santo Domingo) in 1502, and there became a magistrate of La Concepcion and other towns, and a member of the superior court of Hispaniola. He engaged with great profit in various commercial enterprises, became interested in a plan for the extension of the Spanish settlements to the North American mainland, and in 1521 sent Francisco Gordillo on an exploring expedition which touched on the coast of the Florida peninsula and coasted for some distance northward. Gordillo's report of the region was so favourable that Ayllon in 1523 obtained from Charles V. a rather indefinite charter giving him the right to plant colonies. He sent another reconnoitring expedition in 1525, and early in 1526 he himself set out with 500 colonists and about 100 African slaves. He touched at several places along the coast, at one time stopping long enough to replace a wrecked ship with a new one, this being considered the first instance of shipbuilding on the North American continent. Sailing northward to about latitude $33^{\circ} 40'$, he began the construction of a town which he called San Miguel. The exact location of this town is in dispute, some writers holding that it was on the exact spot upon which Jamestown, Va., was later built; more probably, however, as Lowery contends, it was near the mouth of the Pedee river. The employment of negro slaves here was undoubtedly the first instance of the sort in what later became the United States. The spot was unhealthy and fever carried off many of the colonists, including Ayllon himself, who died on the 18th of October 1526. After the death of their leader dissensions broke out among the colonists, some of the slaves rebelled and escaped into the forest, and in December the town was abandoned and the remnant of the colonists embarked for Hispaniola, less than 150 arriving in safety.

See Woodbury Lowery, *Spanish Settlements within the Present Limits of the United States* (2 vols., New York, 1903-1905).

AYLMER, JOHN (1521-1594), English divine, was born in the year 1521 at Aylmer Hall, Tivetshall St. Mary, Norfolk. While still a boy, his precocity was noticed by Henry Grey, marquis of Dorset, afterwards duke of Suffolk, who sent him to Cambridge, where he seems to have become a fellow of Queens' College. About 1541 he was made chaplain to the duke, and tutor to his daughter, Lady Jane Grey. His first preferment was to the archdeaconry of Stow, in the diocese of Lincoln, but his opposition in convocation to the doctrine of transubstantiation led to his deprivation and to his flight into Switzerland. While there he wrote a reply to John Knox's famous *Blast*

against the *Monstrous Regiment of Women*, under the title of *An Harbourove for Faithfull and Trewe Subjects, &c.*, and assisted John Foxe in translating the *Acts of the Martyrs* into Latin. On the accession of Elizabeth he returned to England. In 1559 he resumed the Stow archdeaconry, and in 1562 he obtained that of Lincoln. He was a member of the famous convocation of 1562, which reformed and settled the doctrine and discipline of the Church of England. In 1576 he was consecrated bishop of London, and while in that position made himself notorious by his harsh treatment of all who differed from him on ecclesiastical questions, whether Puritan or Papist. Various efforts were made to remove him to another see. He is frequently assailed in the famous *Marpreatle Tracts*, and is characterized as "Morrell," the bad shepherd, in Spenser's *Shepherd's Calendar* (July). His reputation as a scholar hardly balances his inadequacy as a bishop in the transition time in which he lived. He died in June 1594. His Life was written by John Strype (1701).

AYMARAS (anc. *Colla*), a tribe of South American Indians, formerly inhabiting the country around Lake Titicaca and the neighbouring valleys of the Andes. They form now the chief ethnical element in Bolivia, but are of very mixed blood. In early days the home of the Aymaras by Lake Titicaca was a "holy land" for the Incas themselves, whose national legends attributed the origin of all Quichua (Inca) civilization to that region. The Aymaras, indeed, seem to have possessed a very considerable culture before their conquest by the Incas in the 13th and 14th centuries, evidence of which remains in the megalithic ruins of Tiahuanaoco. When the Spaniards arrived the Aymaras had been long under the Inca domination, and were in a decadent state. They, however, retained certain privileges, such as the use of their own language; and their treatment by their conquerors generally suggested that the latter believed themselves of Aymara blood. Physically, the pure Aymara is short and thick-set, with a great chest development, and with the same reddish complexion, broad face, black eyes and rounded forehead which distinguish the Quichuas. Like the latter, too, the Aymaras are sullen and apathetic in disposition. They number now, including half-breeds, about half a million in Bolivia. Some few are also found in southern Peru.

See *Journal Ethnol. Society* (1870), "The Aymara Indians of Bolivia and Peru."

AYMER, or ÆTHELMAR, OF VALENCE (d. 1260), bishop of Winchester, was a half-brother of Henry III. His mother was Isabelle of Angoulême, the second wife of King John, his father was Hugo of Lusignan, the count of La Marche, whom Isabelle married in 1220. The children of this marriage came to England in 1247 in the hope of obtaining court preferment. In 1250 the king, by putting strong pressure upon the electors, succeeded in obtaining the see of Winchester for Aymer. The appointment was in every way unsuitable. Aymer was illiterate, ignorant of the English language, and wholly secular in his mode of life. Upon his head was concentrated the whole of the popular indignation against the foreign favourites; and he seems to have deserved this unenviable distinction. At the parliament of Oxford (1258) he and his brothers repudiated the new constitution prepared by the barons. He was pursued to surrender, besieged in Wolvesey castle, and finally compelled to surrender and leave the kingdom. He had never been consecrated; accordingly in 1259 the chapter of Winchester proceeded to a new election. Aymer, however, gained the support of the pope; he was on his way back to England when he was overtaken by a fatal illness at Paris.

See W. Stubbs' *Constitutional History*, vol. ii. (1896); G. W. Prothero's *Simon de Montfort* (1877); W. H. Blaauw's *Barons' War* (1871).

AYMESTRY LIMESTONE, an inconstant limestone which occurs locally in the Ludlow series of Silurian rocks, between the Upper and Lower Ludlow shales. It derives its name from Aymestry in Herefordshire, where it may be seen on both sides of the river Lugg. It is well developed in the neighbourhood of Ludlow (it is sometimes called the Ludlow limestone) and occupies a similar position in the Ludlow shales at Woolhope,

the Aberley Hills, May Hill and the Malvern Hills. In lithological character it varies greatly; in one place it is a dark grey, somewhat crystalline limestone, elsewhere it passes into a flaggy, earthy or shaly condition, or even into a mere layer of nodules. When well developed it may reach 50 ft. in thickness in beds of from 1 to 5 ft.; in this condition it naturally forms a conspicuous feature in the landscape because it stands out by its superior hardness from the soft shales above and below.

The most common fossil is *Pentamerus Knightii*, which is extremely abundant in places. Other brachiopods, corals and trilobites are present, and are similar to those found in the Wenlock limestone. (See SILURIAN.)

AYR, a royal, municipal and police burgh and seaport, and county town of Ayrshire, Scotland, at the mouth of the river Ayr, 41½ m. S.S.W. of Glasgow by the Glasgow & South-Western railway. Pop. (1801) 24,044; (1901) 29,101. It is situated on a fine bay and its beautiful sands attract thousands of summer visitors. Ayr proper lies on the south bank of the river, which is crossed by three bridges, besides the railway viaduct—the Victoria Bridge (erected in 1898) and the famous "Two Brigs" of Burns. The Auld Brig is said to date from the reign of Alexander III. (d. 1286). The New Brig was built in 1788, mainly owing to the efforts of Provost Ballantyne. The prophecy which Burns put into the mouth of the venerable structure came true in 1877, when the newer bridge yielded to floods and had to be rebuilt (1879); and the older structure itself was closed for public safety in 1904. The town has extended greatly on the southern side of the stream, where, in the direction of the racecourse, there are now numerous fine villas. The county buildings, designed after the temple of Isis in Rome, accommodate the circuit and provincial courts and various local authorities. The handsome town buildings, surmounted by a fine spire 226 ft. high, contain assembly and reading rooms. Of the schools the most notable is the Academy (rebuilt in 1880), which in 1764 superseded the grammar school of the burgh, which existed in the 13th century. The Gothic Wallace Tower in High Street stands on the site of an old building of the same name taken down in 1835, from which were transferred the clock and bells of the Dungeon steeple. A niche in front is filled by a statue of the Scottish hero by James Thom (1802–1850), a self-taught sculptor. There are statues of Burns, the 13th earl of Eglinton, General Smith Neill and Sir William Wallace. The Carnegie free library was established in 1893. The charitable institutions include the county hospital, district asylum, a deaf and dumb home, the Kyle combination poor-house, St John's refuge and industrial schools for boys and girls. The *Ayr Advertiser* first appeared on 5th of August 1803, and was the earliest newspaper published in Ayrshire. In the suburbs is a racecourse where the Western Meeting is held in September of every year. The principal manufactures include leather, carpets, woollen goods, flannels, blankets, lace, boots and shoes; and fisheries and shipbuilding are also carried on. There are several foundries, engineering establishments and saw mills. Large quantities of timber are imported from Canada and Norway; coal, iron, manufactured goods and agricultural produce are the chief exports. The harbour, with wet and slip dock, occupies both sides of the river from the New Bridge to the sea, and is protected on the south by a pier projecting some distance into the sea, and on the north by a breakwater with a commodious dry dock. There are esplanades to the south and north of the harbour. The town is governed by a provost and council, and unites with Irvine, Inveraray, Campbeltown and Oban in returning one member to parliament.

In 1873 the municipal boundary was extended northwards beyond the river so as to include Newton-upon-Ayr and Wallace Town, formerly separate. Newton is a burgh or barony of very ancient creation, the charter of which is traditionally said to have been granted by Robert Bruce in favour of forty-eight of the inhabitants who had distinguished themselves at Bannockburn. The suburb is now almost wholly occupied with manufactures, the chief of which are chemicals, boots and shoes, carpets and lace. It is on the Glasgow & South-Western

railway, and has a harbour and dock from which coal and goods are the main exports. About 3 m. north of Ayr is Prestwick, a popular watering-place and the headquarters of one of the most flourishing golf clubs in Scotland. The outstanding attraction of Ayr, however, is the pleasant suburb of Alloway, 2½ m. to the south, with which there is frequent communication by electric cars. The "auld clay biggin" in which Robert Burns was born on the 25th of January 1759, has been completely repaired and is now the property of the Ayr Burns's Monument trustees. In the kitchen is the box bed in which the poet was born, and many of the articles of furniture belonged to his family. Adjoining the cottage is a museum of Burnsiana. The "auld haunted kirk," though roofless, is otherwise in a fair state of preservation, despite relic-hunters who have removed all the woodwork. In the churchyard is the grave of William Burnes, the poet's father. Not far distant, on a conspicuous position close by the banks of the Doon, stands the Grecian monument to Burns, in the grounds of which is the grotto containing Thom's figures of Tam o' Shanter and Souter Johnnie.

Nothing is known of the history of Ayr till the close of the 12th century, when it was made a royal residence, and soon afterwards a royal burgh, by William the Lion. During the wars of Scottish independence the possession of Ayr and its castle was an object of importance to both the contending parties, and the town was the scene of many of Wallace's exploits. In 1315 the Scottish parliament met in the church of St John to confirm the succession of Edward Bruce to the throne. Early in the 16th century it was a place of considerable influence and trade. The liberality of William the Lion had bestowed upon the corporation an extensive grant of lands; while in addition to the well-endowed church of St John, it had two monasteries, each possessed of a fair revenue. When Scotland was overrun by Cromwell, Ayr was selected as the site of one of the forts which he built to command the country. This fortification, termed the citadel, enclosed an area of ten or twelve acres, and included within its limits the church of St John, which was converted into a storehouse, the Protector partly indemnifying the inhabitants by contributing £150 towards the erection of a new place of worship, now known as the Old Church. A portion of the tower of St John's church remains, but has been completely modernized. The site of the fort is now nearly covered with houses, the barracks being in Fort Green.

AYRER, JAKOB (?–1605), German dramatist, of whose life little is known. He seems to have come to Nuremberg as a boy and worked his way up to the position of imperial notary. He died at Nuremberg on the 26th of March 1605. Besides a rhymed *Chronik der Stadt Bamberg* (edited by J. Heller, Bamberg, 1838), and an unpublished translation of the Psalms, Ayrer has left a large number of dramas which were printed at Nuremberg under the title *Opus Theatricum* in 1618. This collection contains thirty tragedies and comedies and thirty-six *Fastnachtsspiele* (Shrovetide plays) and *Singspiele*. As a dramatist, Ayrer is virtually the successor of Hans Sachs (q.v.), but he came under the influence of the so-called *Englische Komödianten*, that is, troupes of English actors, who, at the close of the 16th century and during the 17th, repeatedly visited the continent, bringing with them the repertory of the Elizabethan theatre. From those actors Ayrer learned how to enliven his dramas with sensational incidents and spectacular effects, and from them he borrowed the character of the clown. His plays, however, are in spite of his foreign models, hardly more dramatic, in the true sense of the word, than those of Hans Sachs, and they are inferior to the latter in poetic qualities. The plots of two of his comedies, *Von der schönen Phoenicia* and *Von der schönen Sidea*, were evidently drawn from the same sources as those of Shakespeare's *Much Ado about Nothing* and *Tempest*.

Ayres Dramen, edited by A. von Keller, have been published by the Stuttgart Lit. Verein (1804–1865). See also L. Tieck, *Deutsches Theater* (1817); A. Cohn, *Shakespeare in Germany* (1885), which contains a translation of the two plays mentioned above; J. Tittmann, *Schauspiele des sechzehnten Jahrhunderts* (1888).

AYRSHIRE, a south-western county of Scotland, bounded N. by Renfrewshire, E. by Lanarkshire and Dumfriesshire, S.E. by

Kirkcubrightshire, S. by Wigtonshire and W. by the Firth of Clyde. It includes off its coast the conspicuous rock of Ailsa Craig, 10 m. W. of Girvan, Lady Island, 3 m. S.W. of Troon, and Horse Island, off Ardrossan. Its area is 724,523 acres or 1142 sq. m., its coast-line being 70 m. long. In former times the shire was divided into the districts of Cunningham (N. of the Irvine), Kyle (between the Irvine and the Doon), and Carrick (S. of the Doon), and these terms are still occasionally used. Kyle was further divided by the Ayr into King's Kyle on the north and Kyle Stewart. Robert Bruce was earl of Carrick, a title now borne by the prince of Wales. The county is politically divided into North and South Ayrshire, the former comprising Cunningham and the latter Kyle and Carrick. The surface is generally undulating with a small mountainous tract in the north and a larger one in the south and south-east. The principal hills are Black Craig (2298 ft.), 5 m. south-east of New Cumnock; Enoch (1865 ft.), 5 m. east of Dalmellington; Polmaddie (1750 ft.) 2 m. south-east of Barr; Stake on the confines of Ayrshire and Renfrewshire, and Corsancone (1547 ft.), 3 m. north-east of New Cumnock. None of the rivers is navigable, but their varied and tranquil beauty has made them better known than many more important streams. The six most noted are the Stinchar (c soft), Girvan, Doon, Ayr, Irvine and Garnock. Of these the Ayr is the longest. It rises at Glenbuck, on the border of Lanarkshire, and after a course of some 38 m. falls into the Firth of Clyde at the county town which, with the county, is named from it. The scenery along its banks from Sorn downwards—passing Catrine, Ballochmyle, Barskimming, Sundrum, Auchencruive and Craigue—is remarkably picturesque. The lesser streams are numerous, but Burns's verse has given pre-eminence to the Afton, the Cessnock and the Lugar. There are many lochs, the largest of which is Loch Doon, 5½ m. long, the source of the river of the same name. From Loch Finlas, about 20 m. south-east of Ayr, the town derives its water-supply. The Nith rises in Ayrshire and a few miles of its early course belong to the county.

Geology.—The greater portion of the hilly region in the south of the county forms part of the Silurian tableland of the south of Scotland. Along its north margin there is a belt of lava ground consisting mainly of Old Red Sandstone strata, while the tract of fertile low ground is chiefly occupied by younger Palaeozoic rocks. The Silurian belt stretching eastwards from the mouth of Loch Ryan to the Merrick range is composed of grits, greywackes and shales with thin layers of black shales, containing graptolites of Upper Llandoilid age which are repeated by folding and cover a broad area. Near their northern limit Radiolarian cherts, mudstones and lavas of Arenig age rise from underneath the former along anticlines striking north-east and south-west. In the Ballantrae region there is a remarkable development of volcanic rocks—lavas, tufts and agglomerates—of Arenig age; their horizon being defined by graptolites occurring in cherty mudstones and black shales intercalated in lavas and agglomerates. These volcanic materials are pierced by serpentine, gabbro and granite. The serpentine forms two belts running inland from near Bennane Head and from Burnfoot, being typically developed on Balthamie Hill near Colmonell. Gabbro appears on the shore north of Lendalloft, while on the Byne and Grey Hills south of Girvan there are patches of granite and quartz-diorite which seem to pass into more basic varieties. These volcanic and plutonic rocks and Radiolarian cherts are covered unconformably by conglomerates (Bennane Hill near Stranraer and Kennedy's Pass) which are associated with the limestones of Upper Llandoilid age that have been wrought in the Stinchar valley and at Craigue. South of the river Girvan there is a sequence from Llandoilid—Caradoc to Llandovery—Tarannon strata, excellent sections of which are seen on the shore north of Kennedy's Pass and in Penwhapple Glen near Girvan. Llandovery strata again appear north of the Girvan at Dailly, where they form an inlier surrounded by the Old Red Sandstone and Carboniferous formations. Representatives of Wenlock rocks form a narrow belt near the village of Stratton. Some of the Silurian sediments of the Girvan province are highly fossiliferous, but the order of succession is determined by the graptolites. Near Muirkirk and in the Douglas Water there are inliers of Wenlock, Ludlow and Devonian rocks, coming to the surface along anticlines truncated by faults and surrounded by Old Red Sandstone and Carboniferous strata. In the south-east of the county there is a part of the large granite mass that stretches from Loch Doon south to Loch Dee, giving rise to wild scenery and bounded by the high ground near the head of the Girvan Water, boulders of which have been distributed over a wide area during the glacial period. Along the northern margin of the uplands the Lower Old Red Sandstone is

usually faulted against the Silurian strata, but on Hadyard Hill south of the Girvan valley they rest on the folded and denuded members of the latter system. The three divisions of this formation are well represented. The lower group of conglomerates and sandstones are well displayed on Hadyard Hill and on the tract near Maybole; the middle volcanic series on the shore south of the Heads of Ayr and from the Stinchar valley along the Old Red belt towards Dalmellington and New Cumnock; while the upper group, comprising conglomerates and sandstones, form a well-marked synclinal fold at Corsancone north-east of New Cumnock. The Upper Old Red Sandstone appears as a fringe round the south-west margin of the Carboniferous rocks of the county, and it rises from beneath them on the shore of the Firth of Clyde south of Wemyss Bay. The Carboniferous strata of the central low ground form a great basin traversed by faults, all the subdivisions of the system being represented save the Millstone Grit. Round the north and north-east margin there is a great development of volcanic rocks—lavas, tufts and agglomerates—belonging to the Calciferous Sandstone series, and passing upwards into the Carboniferous Limestone. The lower limestones of the latter division are typically represented near Dalry and Beith, where in one instance they reach a thickness of over 100 ft. They are followed by the coal-bearing group (Edge coals of Midlothian) which have been wrought in the Dalry and Patna districts and at Dailly. The position of the Millstone Grit is occupied by lavas and tufts, extending almost continually as a narrow fringe round the northern margin of the Coal Measures from Saltcoats by Kilmours to the Crawfordland Water. The workable coals of the true Coal Measures have a wide distribution from Kilmwinning by Kilmarnock to Galeston and again in the districts of Coyton, Dalmellington, Lugar and Cumnock. These members are overlaid by a set of upper barren red sandstones, probably the equivalents of the red beds of Uddington, Dalkeith and Wemyss in Fife, visible in the ravines of Lugar near Ochiltree and of Ayr at Catrine. In various parts of the Ayrshire coalfield the coal-seams are rendered useless by intrusive sheets of dolerite as near Kilmarnock and Dalmellington. In the central part of the field there is an oval-shaped area of red sandstones now grouped with the Trias, extending from near Tarbolton to Mauchline, where they are largely worked for building stone. They are underlain by a volcanic series which forms a continuous belt between the underlying red sandstones of the Coal Measures and the overlying Trias. In the north part of the county, as near Wemyss Bay, the strata are traversed by dykes of dolerite and basalt trending in a north-west direction and probably of Tertiary age.

Agriculture.—There has been no lack of agricultural enterprise. With a moist climate, and, generally, a rather heavy soil, drainage was necessary for the successful growth of green crops. Up to about 1840, a green crop in the rotation was seldom seen, except on porous river-side land, or on the lighter farms of the lower districts. In the early part of the 19th century lime was a powerful auxiliary in the inland districts, but with repeated applications it gradually became of little avail. Thorough draining gave the next great impetus. Enough had been done to test its efficacy before the announcement of Sir Robert Peel's drainage loan, after which it was rapidly extended throughout the county. Green-crop husbandry, and the liberal use of guano and other manures, made a wonderful change in the county, and immensely increased the amount of produce. Potatoes are now extensively grown, the coast-lands supplying the markets of Scotland and the north of England. Of roots, turnips, carrots and mangolds are widely cultivated, heavy crops being obtained by early sowing and rich manuring. Oats form the bulk of the cereal crop, but wheat and barley are also grown. High farming has developed the land enormously. Dairying has received particular attention. Dunlop cheese was once a well-known product. Part of it was very good; but it was unequal in its general character, and unsaleable in English markets. Dissatisfied with the inferior commercial value of their cheese in comparison with some English varieties, the Ayrshire Agricultural Association brought a Somerset farmer and his wife in 1855 to teach the Cheddar method, and their effort was most successful. Cheddar cheese of first-rate quality is now made in Ayrshire, and the annual cheese show at Kilmarnock is the most important in Scotland. The Ayrshire breed of cows are famous for the quantity and excellence of their milk. Great numbers of cattle, sheep and pigs are raised for the market, and the Ayrshire horse is in high repute.

Other Industries.—Ayrshire is the principal mining county in Scotland and has the second largest coalfield. There is a heavy annual output also of iron ore, pig iron and fire-clay. The chief coal districts are Ayr, Dalmellington, Patna, Maybole, Drongan, Irvine, Coyton, Stevenston, Beith, Kilmwinning,

Dalry, Kilbirnie, Dreghorn, Kilmarnock, Galston, Hurlford, Muirkirk, Cumnock and New Cumnock. Ironstone occurs chiefly at Patna, Coynton, Dalry, Kilbirnie, Dreghorn and Cumnock, and there are blast furnaces at most of these towns. A valuable whetstone is quarried at Bridge of Stair on the Ayr—the Water-of-Ayr stone. The leading manufactures are important. At Catrine are cotton factories and bleachfields, and at Ayr and Kilmarnock extensive engineering works, and carpet, blanket and woollens, boot and shoe factories. Cotton, woollens, and other fabrics and hosiery are also manufactured at Dalry, Kilbirnie, Kilmaurs, Beith and Stewarton. An extensive trade in chemicals is carried on at Irvine. Near Stevenston works have been erected in the sandhills for the making of dynamite and other explosives. There are large lace curtain factories at Galston, Newmilns and Darvel, and at Beith cabinet-making is a considerable industry. Shipbuilding is conducted at Troon, Ayr, Irvine and Fairlie, which is famous for its yachts. The leading ports are Ardrossan, Ayr, Girvan, Irvine and Troon. Fishing is carried on in the harbours and creeks, which are divided between the fishery districts of Greenock and Ballantrae.

Communications.—The Glasgow & South-Western railway owns most of the lines within the shire, its system serving all the industrial towns, ports and seaside resorts. Its trunk line via Girvan to Stranraer commands the shortest sea passage to Belfast and the north of Ireland, and its main line via Kilmarnock communicates with Dumfries and Carlisle and so with England. The Lanarkshire & Ayrshire branch of the Caledonian railway company also serves a part of the county. For passenger steamer traffic Ardrossan is the principal port, there being services to Arran and Belfast and, during the season, to Douglas in the Isle of Man. Millport, on Great Cumbrae, is reached by steamer from Fairlie.

Population and Administration.—The population of Ayrshire in 1801 was 226,386, and in 1901, 254,468, or 223 to the sq. m. In 1901 the number of persons speaking Gaelic only was 17. The chief towns, with populations in 1901 are: Ardrossan (6077), Auchinleck (2168), Ayr (29,101), Beith (4963), Cumnock (3088), Dalry (5316), Darvel (3070), Galston (4876), Girvan (4024), Hurlford (4601), Irvine (9618), Kilbirnie (4571), Kilmarnock (35,091), Kilwinning (4440), Largs (3246), Maybole (5892), Muirkirk (3892), Newmilns (4467), Saltcoats (8120), Stevenston (6554), Stewarton (2858), Troon (4764). The county returns two members to parliament, who represent North and South Ayrshire respectively. Ayr (the county town) and Irvine are royal burghs and belong to the Ayr group of parliamentary burghs, and Kilmarnock is a parliamentary burgh of the Kilmarnock group. Under the county council special water districts, drainage districts, and lighting and scavenging districts have been formed. The county forms a sheriffdom, and there are resident sheriffs-substitute at Ayr and Kilmarnock, who sit also at Irvine, Beith, Cumnock and Girvan. The shire is under school-board jurisdiction, but there are a considerable number of voluntary schools, besides secondary schools at Ayr, Irvine, Kilmarnock and Beith, while Kilmarnock Dairy School is a part of the West of Scotland Agricultural College established in 1899. In addition to grants earned by the schools, the county and borough councils expend a good deal of money upon secondary and technical education, towards which contributions are also made by the Glasgow and West of Scotland Technical College and the Kilmarnock Dairy School. The technical classes, subsidized at various local centres, embrace instruction in agriculture, mining, engineering, plumbing, gardening, and various science and art subjects.

History.—Traces of Roman occupation are found in Ayrshire. At the time of Agricola's campaigns the country was held by the Damnonii, and their town of Vandogara has been identified with a site at Loudoun Hill near Darvel, where a serious encounter with the Scots took place. On the withdrawal of the Romans, Ayrshire formed part of the kingdom of Strathclyde and ultimately passed under the sway of the Northumbrian kings. Save for occasional intertribal troubles, as that in which the

Scottish king Alpin was slain at Dalmellington in the 9th century, the annals are silent until the battle of Largs in 1263, when the pretensions of Haakon of Norway to the sovereignty of the Isles were crushed by the Scots under Alexander III. A generation later William Wallace conducted a vigorous campaign in the shire. He surprised the English garrison at Ardrossan, and burned the barns of Ayr in which the forces of Edward I. were lodged. Robert Bruce is alleged to have been born at Turnberry Castle, some 12 m. S.W. of Ayr. In 1307 he defeated the English at Loudoun Hill. Cromwell paid the county a hurried visit, during which he demolished the castle of Ardrossan and is said to have utilized the stones in rearing a fort at Ayr. Between 1660 and 1688 the sympathies of the county were almost wholly with the Covenanters, who suffered one of their heaviest reverses at Airds Moss—a morass between the Ayr and Lugar,—their leader, Richard Cameron, being killed (20th of July 1680). The county was dragooned and the Highland host ravaged wherever it went. The Hanoverian succession excited no active hostility if it evoked no enthusiasm. Antiquarian remains include cairns in Galston, Sorn and other localities; a road supposed to be a work of the Romans, which extended from Ayr, through Dalrymple and Dalmellington, towards the Solway; camps attributed to the Norwegians or Danes on the hills of Knockgeorgan and Dundonald; and the castles of Loch Doon, Turnberry, Dundonald, Portencross, Ardrossan and Dunure. There are ruins of celebrated abbays at Kilwinning and Crossraguel, and of Alloway's haunted church, famous from their associations.

See James Paterson, "History of the County of Ayr." *Transactions of Ayrshire and Galloway Archaeological Associations*, Edinburgh, 1879-1900; John Smith, *Prehistoric Man in Ayrshire* (London, 1895); William Robertson, *History of Ayrshire* (Edinburgh, 1894); Archibald Sturrock, "On the Agriculture of Ayrshire," *Transactions of Highland and Agricultural Society*; D. Landsborough, *Contributions to Local History* (Kilmarnock, 1878).

AYRTON, WILLIAM EDWARD (1847-1908), English physicist, was born in London on the 14th of September 1847. He was educated at University College, London, and in 1868 went out to Bengal in the service of the Indian Government Telegraph department. In 1873 he was appointed professor of physics and telegraphy at the Imperial College of Engineering, Tokio. On his return to London six years later he became professor of applied physics at the Finsbury College of the City and Guilds of London Technical Institute, and in 1884 he was chosen professor of electrical engineering at the Central Technical College, South Kensington. He published, both alone and jointly with others, a large number of papers on physical, and in particular electrical, subjects, and his name was especially associated, together with that of Professor John Perry, with the invention of a long series of electrical measuring instruments. He died in London on the 8th of November 1908. His wife, Mrs Hertha Ayrtton, whom he married in 1885, assisted him in his researches, and became known for her scientific work on the electric arc and other subjects. The Royal Society awarded her one of its Royal medals in 1906.

AYSCOUGH, SAMUEL (1745-1804), English librarian and index-maker, was born at Nottingham in 1745. His father, a printer and stationer, having ruined himself by speculation, Samuel Ayscough left Nottingham for London, where he obtained an engagement in the cataloguing department of the British Museum. In 1782 he published a two-volume catalogue of the then undescribed manuscripts in the museum. About 1785 he was appointed assistant librarian at the museum, and soon afterwards took holy orders. In 1786 he published an index to the first seventy volumes of the *Monthly Review*, and in 1796 indexed the remaining volumes. Both this index and his catalogue of the undescribed manuscripts in the museum were private ventures. His first official work was a third share in the British Museum catalogue of 1787, and he subsequently catalogued the ancient rolls and charters, 16,000 in all. In 1789 he produced the first two volumes of the index to the *Gentleman's Magazine*, and in 1790 the first index-concordance to Shakespeare. He was a Fellow of the Society of Antiquaries, and has been called

"The Prince of Indexers." He died at the British Museum on the 30th of October 1804.

AYSUCUE (erroneously ASKEW or AYSUCOUGH), **SIR GEORGE** (d. 1671), British admiral, came of an old Lincolnshire family. Beyond the fact that he was knighted by Charles I., nothing is known of his career until in 1646 he received a naval command. Through the latter years of the first civil war, Ayscue seems to have acted as one of the senior officers of the fleet. In 1648, when Sir William Batten went over to Holland with a portion of his squadron, Ayscue's influence kept a large part of the fleet loyal to the Parliament, and in reward for this service he was appointed the following year admiral of the Irish Seas. For his conduct at the relief of Dublin he received the thanks of Parliament, and in 1651 he was employed under Blake in the operations for the reduction of Scilly. He was next sent to the West Indies in charge of a squadron destined for the conquest of Barbadoes and the other islands still under royalist control. This task successfully accomplished, he returned to take part in the first Dutch War. In this he played a prominent part, but the indecisive battle off Plymouth (August 16th, 1652) cost him his command, though an annuity was assigned him. For some years Sir George Ayscue lived in retirement, but the later years of the Commonwealth he spent in Sweden, Cromwell having despatched him thither as naval adviser. At the Restoration he returned, and became one of the commissioners of the navy, but on the outbreak of the second Dutch War in 1664 he once more hoisted his flag as rear-admiral of the Blue, and took part in the battle of Lowestoff (June 3rd, 1665). In the great Four Days' Battle (June 11th-14th, 1666) he served with Monck as admiral of the White. His flagship, the "Prince Royal," was taken on the third day, and he himself remained a prisoner in Holland till the peace. It seems doubtful whether he ever again flew his flag at sea, and the date of his death is supposed to be 1671. Lely's portrait of Sir George Ayscue is in the Painted Hall at Greenwich.

AYTOUN, or AYTON, SIR ROBERT (1570-1638), Scottish poet, son of Andrew Aytoun of Kinaldie, Fifeshire, was born in 1570. He was educated at the university of St Andrews, where he was incorporated as a student of St Leonard's College in 1584 and graduated M.A. in 1588. He lived for some years in France, and on the accession of James VI. to the English throne he wrote in Paris a Latin panegyric, which brought him into immediate favour at court. He was knighted in 1612. He held various lucrative offices, and was private secretary to the queens of James I. and Charles I. He died in London and was buried in Westminster Abbey on the 28th of February 1638. His reputation with his contemporaries was high, both personally and as a writer, though he had no ambition to be known as the latter.

Aytoun's remains are in Latin and English. In respect of the latter he is one of the earliest Scots to use the southern standard as a literary medium. The Latin poems include the panegyric already referred to, an *Epicidium in obitum Thoma Rhodi*; *Basia, sive Strena ad Jacobum Hayum*; *Lessus in funere Raphaelis Thores*; *Carina Caro*; and minor pieces, occasional and epitaphic. His first English poem was *Diophantus and Charidora* (to which he refers in his Latin panegyric to James). He has left a number of pieces on amatory subjects, including songs and sonnets.

Aytoun's Latin poems are printed in *Delitiae Poetarum Scotorum* (Amsterdam, 1637), i. pp. 40-75. His English poems are preserved in a MS. in the British Museum (*Add. MSS.* 10,308), which was prepared by his nephew, Sir John Aytoun. Both were collected by Charles Rogers in *The Poems of Sir Robert Aytoun* (London, privately printed, 1871). This edition is unsatisfactory, though it is better than the first issue by the same editor in 1844. Additional poems are included which cannot be ascribed to Aytoun, and which in some cases have been identified as the work of others. The poem "I do confess thou'rt smooth and fair" may be suspected, and the old version of "Auld Lang Syne" and "Sweet Empress" are certainly not Aytoun's. Some of the English poems are printed in *Watson's Collection* (1706-1711) and in the *Bannatyne Miscellany*, i. p. 299 (1827). There is a memoir of Aytoun in Rogers's edition, and another by Grosart in the *Dict. of Nat. Biog.* Particulars of his public career will be found in the printed *Calendar of State Papers and Register of the Privy Council of the period.*

AYTOUN, WILLIAM EDMONSTOUNE (1813-1865), Scottish poet, humorist and miscellaneous writer, was born at Edinburgh on the 21st of June 1813. He was the only son of Roger Aytoun, a writer to the signet, and the family was of the same stock as Sir Robert Aytoun noticed above. From his mother, a woman of marked originality of character and considerable culture, he derived his distinctive qualities, his early tastes in literature, and his political sympathies, his love for ballad poetry, and his admiration for the Stuarts. At the age of eleven he was sent to the Edinburgh Academy, passing in due time to the university. In 1833 he spent a few months in London for the purpose of studying law; but in September of that year he went to study German at Aschaffenburg, where he remained till April 1834. He then resumed his legal pursuits in his father's chambers, was admitted a writer to the signet in 1835, and five years later was called to the Scottish bar. But, by his own confession, though he "followed the law, he never could overtake it." His first publication—a volume entitled *Poland, Homer, and other Poems*, in which he gave expression to his eager interest in the state of Poland—had appeared in 1832. While in Germany he made a translation in blank verse of the first part of *Faust*; but, forestalled by other translations, it was never published. In 1836 he made his earliest contributions to *Blackwood's Magazine*, in translations from Uhland; and from 1839 till his death he remained on the staff of *Blackwood*. About 1841 he became acquainted with Mr (afterwards Sir) Theodore Martin, and in association with him wrote a series of light humorous papers on the tastes and follies of the day, in which were interspersed the verses which afterwards became popular as the *Bon Gaultier Ballads* (1855). The work on which his reputation as a poet chiefly rests is the *Lays of the Scottish Cavaliers* (1848; 20th ed. 1883). In 1845 he was appointed professor of rhetoric and *belles lettres* at Edinburgh University. His lectures were very attractive, and the number of students increased correspondingly. His services in support of the Tory party, especially during the Anti-Corn-Law struggle, received official recognition in his appointment (1852) as sheriff of Orkney and Zetland. In 1854 appeared *Firmilian, a Spasmodic Tragedy*, in which he attacked and parodied the writings of Philip James Bailey, Sydney Dobell and Alexander Smith; and two years later he published his *Bothwell, a Poem*. Among his other literary works are a *Collection of the Ballads of Scotland* (1858), a translation of the *Poems and Ballads of Goethe*, executed in co-operation with his friend Theodore Martin (1858), a small volume on the *Life and Times of Richard I.* (1840), written for the *Family Library*, and a novel entitled *Norman Sinclair* (1861), many of the details in which are taken from incidents in his own experience. In 1860 Aytoun was elected honorary president of the Associated Societies of Edinburgh University. In 1859 he lost his first wife, a daughter of John Wilson (Christopher North), to whom he was married in 1840, and this was a great blow to him. His mother died in November 1861, and his own health began to fail. In December 1863 he married Miss Kinnear. He died at Blackhills, near Elgin, on the 4th of August 1865.

See *Memoirs of W. E. Aytoun* (1867), by Sir Theodore Martin, with an appendix containing some of his prose essays.

AYUB KHAN (1855-), Afghan prince, son of Shere Ali (formerly amir of Afghanistan), and cousin of the amir Abdur Rahman, was born about 1855. During his father's reign little is recorded of him, but after Shere Ali's expulsion from Kabul by the English, and his death in January 1879, Ayub took possession of Herat, and maintained himself there until June 1881, when he invaded Afghanistan with the view of asserting his claims to the sovereignty, and in particular of gaining possession of Kandahar, still in the occupation of the British. He encountered the British force commanded by General Burrows at Maiwand on the 27th of July, and was able to gain one of the very few pitched battles that have been won by Asiatic leaders over an army under European direction. His triumph, however, was short-lived; while he hesitated to assault Kandahar he was attacked by Sir Frederick (afterwards Lord) Roberts, at the close of the latter's memorable march from Kabul, and utterly discomfited,

10th of September 1880. He made his way back to Herat, where he remained for some time unmolested. In the summer of 1881 he again invaded Afghanistan, and on the anniversary of the battle of Maiwand obtained a signal victory over Abdur Rahman's lieutenants, mainly through the defection of a Durani regiment. Kandahar fell into his hands, but Abdur Rahman now took the field in person, totally defeated Ayub, and expelled him from Herat. He took refuge in Persia, and for some time lived quietly in receipt of an allowance from the Persian government. In 1887 internal troubles in Afghanistan tempted him to make another endeavour to seize the throne. Defeated and driven into exile, he wandered for some time about Persia, and in November gave himself up to the British agent at Meshed. He was sent to India to live as a state prisoner.

AYUNTAMIENTO, the Spanish name for the district over which a town council has administrative authority; it is used also for a town council, and for the town-hall. The word is derived from the Latin *adjungere*, and originally meant "meeting." In some parts of Spain and in Spanish America the town council was called the *cabildo* or chapter, from the Latin *capitulum*. The ayuntamiento consisted of the official members, and of *regidores* or regulators, who were chosen in varying proportions from the "hidalgos" or nobles (*hijos de algo*, sons of somebody) and the "pecheros," or commoners, who paid the *pecho*, or personal tax; *pecho* (Lat. *pectus*) is in Spanish the breast, and then by extension the person. The *regidores* of the ayuntamientos, or *lay cabildos*, were checked by the royal judge or *corregidor*, who was in fact the permanent chairman or president. The distinction between hidalgo and pechero has been abolished in modern Spain, but the powers and the constitution of ayuntamientos have been subject to many modifications.

AYUTHIA, a city of Siam, now known to the Siamese as *Krung Kao* or "the Old Capital," situated in 100° 32' E., 14° 21' N. Pop. about 10,000. The river Me Nam, broken up into a network of creeks, here surrounds a large island upon which stand the ruins of the famous city which was for more than four centuries the capital of Siam. The bulk of the inhabitants live in the floating houses characteristic of lower Siam, using as thoroughfares the creeks to the edges of which the houses are moored. The ruins of the old city are of great archaeological interest, as are the relics, of which a large collection is housed in the local museum. Outside the town is an ancient masonry enclosure for the capture of elephants, which is still periodically used. Ayuthia is on the northern main line of the state railways, 42 m. from Bangkok. Great quantities of paddy are annually sent by river and rail to Bangkok, in return for which cloth and other goods are imported to supply the wants of the agriculturist peasantry. There is no other trade. Ayuthia is the chief town of one of the richest agricultural provincial divisions of Siam and is the headquarters of a high commissioner. The government offices occupy spacious buildings, once a royal summer retreat; the government is that of an ordinary provincial division (*Mouton*).

Historically Ayuthia is the most interesting spot in Siam. Among the innumerable ruins may be seen those of palaces, pagodas, churches and fortifications, the departed glories of which are recorded in the writings of the early European travellers who first brought Siam within the knowledge of the West, and laid the foundations of the present foreign intercourse and trade. The town was twice destroyed by the Burmese, once in 1555 and again in 1767, and from the date of the second destruction it ceased to be the capital of the country.

AZALS, PIERRE HYACINTHE (1766-1845), French philosopher, was born at Sorèze and died at Paris. He spent his early years as a teacher and a village organist. At the outbreak of the Revolution he viewed it with favour, but was soon disgusted at the violence of its methods. A critical pamphlet drew upon him the hatred of the revolutionists, and it was not until 1806 that he was able to settle in Paris. In 1809 he published his great work, *Des Compensations dans les destinées humaines* (5th ed. 1846), which pleased Napoleon so much that he made its author professor at St. Cyr. In 1811 he became

inspector of the public library at Avignon, and from 1812 to 1815 he held the same position at Nancy. The Restoration government at first suspected him as a Bonapartist, but at length granted him a pension. From that time he occupied himself in lecturing and the publication of philosophical works. In the *Compensations* he sought to prove that, on the whole, happiness and misery are equally balanced, and therefore that men should accept the government which is given them rather than risk the horrors of revolution. "Le principe de l'inégalité naturelle et essentielle dans les destinées humaines conduit inévitablement au fanatisme révolutionnaire ou au fanatisme religieux." The principles of compensation and equilibrium are found also in the physical universe, the product of matter and force, whose cause is God. Force, naturally expansive and operating on the homogeneous atoms which constitute elemental matter, is subject to the law of equilibrium, or equivalence of action and reaction. The development of phenomena under this law may be divided into three stages—the physical, the physiological, the intellectual and moral. The immaterial in man is the expansive force inherent in him. Moral and political phenomena are the result of the opposing forces of progress and preservation, and their perfection lies in the fulfilment of the law of equilibrium or universal harmony. This may be achieved in seven thousand years, when man will vanish from the world. In an additional five thousand, a similar equilibrium will obtain in the physical sphere, which will then itself pass away. In addition to his philosophical work, Azals studied music under his father, Pierre Hyacinthe Azals (1743-1796), professor of music at Sorèze and Toulouse, and composer of sacred music in the style of Gossec. He wrote for the *Revue musicale* a series of articles entitled *Acoustique fondamentale* (1831), containing an ingenious, but now exploded, theory of the vibration of the air. His other works are: *Système universel* (8 vols., 1812); *Du Sort de l'homme* (3 vols., 1820); *Cours de philosophie* (8 vols., 1824), reproduced as *Explication universelle* (3 vols., 1826-1828); *Juennesse, maturité, religion, philosophie* (1837); *De la phrénologie, du magnétisme, et de la folie* (1843).

AZALEA, a genus of popular hardy or greenhouse plants, belonging to the heath order (Ericaceae), and scarcely separable botanically from *Rhododendron*. The beautiful varieties now in cultivation have been bred from a few originals, natives of the hilly regions of China and Japan, Asia Minor, and the United States. They are perhaps unequalled as indoor decorative plants. They are usually increased by grafting the half-ripened shoots on the stronger-growing kinds, the shoots of the stock and the grafts being in a similarly half-ripened condition, and the plants being placed in a moist heat of 65°. Large plants of inferior kinds, if healthy, may be grafted all over with the choicer sorts, so as to obtain a large specimen in a short time. They require a rich and fibrous peat soil, with a mixture of sand to prevent its getting water-logged. The best time to pot azaleas is three or four weeks after the blooming is over. The soil should be made quite solid to prevent its retaining too much water. To produce handsome plants, they must while young be stopped as required. Specimens that have got leggy may be cut back just before growth commences. The lowest temperature for them during the winter is about 35°, and during their season of growth from 55° to 65° at night, and 75° by day, the atmosphere being at the same time well charged with moisture. They are liable to the attacks of thrips and red spider, which do great mischief if not promptly destroyed.

The following are some well-known species:—*A. arborescens* (Pennsylvania), a deciduous shrub 10-20 ft. high; *A. calendulacea* (Carolina to Pennsylvania), a beautiful deciduous shrub 2-6 ft. high, with yellow, red, orange and copper-coloured flowers; *A. hispida*, a North American shrub, 10-15 ft. high, flowers white edged with red; *A. indica* (China), the so-called Indian azalea, a shrub 3-6 ft. or more high, the original of numerous single and double varieties, many of the more vigorous of which are hardy in southern England and Ireland; *A. nudiflora*, a North American shrub, 3-4 ft. high, which hybridizes freely with *A. calendulacea*, *A. pontica* and others, to produce single and

double forms of a great variety of shades; *A. pontica* (Levant, Caucasus, &c.), 4-6 ft. high, with numerous varieties differing in the colour of the flowers and the tint of the leaves; *A. sinensis* (China and Japan), a beautiful shrub, 3-4 ft. high, with orange-red or yellow bell-shaped flowers, hardy in the southern half of England, large numbers of varieties being in cultivation under the name of Japanese azaleas.

AZAMGARH, or **AZIMGARH**, a city and district of British India, in the Gorakhpur division of the United Provinces. The town is situated on the river Tons, and has a railway station. It is said to have been founded about 1665 by a powerful landholder named Azim Khan, who owned large estates in this part of the country. Pop. (1901) 18,835.

The area of the district is 2207 sq. m. It is bounded on the N. by the river Gogra, separating it from Gorakhpur district; on the E. by Ghazipur district and the river Ganges; on the S. by the districts of Jaunpur and Ghazipur; and on the W. by Jaunpur and Fyzabad. The portion of the district lying along the banks of the Gogra is a low-lying tract, varying considerably in width; south of this, however, the ground takes a slight rise. The slope of the land is from north-west to south-east, but the general drainage is very inadequate. Roughly speaking, the district consists of a series of parallel ridges, whose summits are depressed into beds or hollows, along which the rivers flow; while between the ridges are low-lying rice lands, interspersed with numerous natural reservoirs. The soil is fertile, and very highly cultivated, bearing magnificent crops of rice, sugar-cane and indigo. There are several indigo factories. A branch of the Bengal & North-Western railway to Azamgarh town was opened in 1898. In 1901 the population was 1,529,785, showing a decrease of 11% in the decade. The district was ceded to the Company in 1801 by the wazirs of Lucknow. In 1857 it became a centre of mutiny. On the 3rd of June 1857 the 17th Regiment of Native Infantry mutinied at Azamgarh, murdered some of their officers, and carried off the government treasure to Fyzabad. The district became a centre of the fighting between the Gurkhas and the rebels, and was not finally cleared until October 1858 by Colonel Kelly.

AZĀN (Arabic for "announcement"), the call or summons to public prayers proclaimed by the Muezzin (crier) from the mosque twice daily in all Mahomedan countries. In small mosques the Muezzin at Azān stands at the door or at the side of the building; in large ones he takes up his position in the minaret. The call translated runs: "God is most great!" (four times), "I testify there is no God but God!" (twice), "I testify that Mahomet is the apostle of God!" (twice), "Come to prayer!" (twice), "Come to salvation!" (twice), "God is most great!" (twice), "There is no God but God!" To the morning Azān are added the words, "Prayer is better than sleep!" (twice). The devout Moslem has to make a set response to each phrase of the Muezzin. At first these are mere repetitions of Azān, but to the cry "Come to prayer!" the listener must answer, "I have no power nor strength but from God the most High and Great." To that of "Come to salvation!" the formal response is, "What God willeth will be: what He willeth not will not be." The recital of the Azān must be listened to with the utmost reverence. The passers in the streets must stand still, all those at work must cease from their labours, and those in bed must sit up.

The Muezzin, who is a paid servant of the mosque, must stand with his face towards Mecca and with the points of his forefingers in his ears while reciting Azān. He is specially chosen for good character, and Azān must not be recited by any one unclean, by a drunkard, by the insane, or by a woman. The summons to prayers was at first simply "Come to prayer!" Mahomet, anxious to invest the call with the dignity of a ceremony, took counsel of his followers. Some suggested the Jewish trumpet, others the Christian bell, but according to legend the matter was finally settled by a dream:—"While the matter was under discussion, Abdallah, a Khazrajite, dreamed that he met a man clad in green raiment, carrying a bell. Abdallah sought to buy it, saying that it would do well for bringing together the assembly

of the faithful. 'I will show thee a better way,' replied the stranger; 'let a crier cry aloud "God is most great, &c."' On awaking, Abdallah went to Mahomet and told him his dream," and Azān was thereupon instituted.

AZARA, **DON JOSE NICHOLAS DE** (1731-1804), Spanish diplomatist, was born in 1731 at Barbuñales, Aragon, and was appointed in 1765 Spanish agent and procurator-general, and in 1785 ambassador at Rome. During his long residence there he distinguished himself as a collector of Italian antiquities and as a patron of art. He was also an able and active diplomatist, took a leading share in the difficult and hazardous task of the expulsion of the Jesuits from Spain, and was instrumental in securing the election of Pius VI. He withdrew to Florence when the French took possession of Rome in 1798, but acted on behalf of the pope during his exile and after his death at Valence in 1799. He was afterwards Spanish ambassador in Paris. In that post it was his misfortune to be forced by his government to conduct the negotiations which led to the treaty of San Ildefonso, by which Spain was wholly subjected to Napoleon. Azara was friendly to a French alliance, but his experience showed him that his country was being sacrificed to Napoleon. The First Consul liked him personally, and found him easy to influence. Azara died, worn out, in Paris in 1804. His end was undoubtedly embittered by his discovery of the ills which the French alliance must produce for Spain.

Several sympathetic notices of Azara will be found in Thiers, *Consulat et Empire*. See also *Reinado de Carlos IV*, by Gen. J. Gomez de Arceche, in the *Historia General de España*, published by the R. Acad. de la Historia, Madrid, 1892, &c. There is a *Notice historique sur le Chevalier d'Azara* by Bourgoing (1804).

His younger brother, **DON FELIX DE AZARA** (1746-1811), spent twenty years in South America as a commissioner for delimiting the boundary between the Spanish and Portuguese territories. He made many observations on the natural history of the country, which, together with an account of the discovery and history of Paraguay and Rio de la Plata, were incorporated in his principal work, *Voyage dans l'Amérique méridionale depuis 1781 jusqu'en 1801*, published at Paris in 1809 in French from his MS. by C. A. Walckenaer.

AZARIAH, the name of several persons mentioned in the Old Testament. (1) One of Solomon's "princes," son of Zadok the priest (1 Kings iv. 2), was one of several Azariah among the descendants of Levi (1 Chron. vi. 9, 10, 13, 36; 2 Chron. xxvi. 17). (2) The son of Nathan, a high official under King Solomon (1 Kings iv. 5). (3) King of Judah, son of Amaziah by his wife Jecholiah (2 Kings xv. 1, 2), also called Uzziah (2 Chron. xxvi. 1). (4) Son of Ethan and great-grandson of Judah (1 Chron. ii. 8). (5) Son of Jehu, of the posterity of Judah (1 Chron. ii. 38). (6) A prophet in the reign of Asa, king of Judah (2 Chron. xv. 1). (7) Two sons of Jehoshaphat, king of Judah (2 Chron. xxii. 2). (8) King of Judah, also called Ahaziah and Jehoahaz, son of Jehoram (2 Chron. xxi. 17; xxii. 1, 6). (9) The son of Jehoram, and (10) the son of Obad, were made "captains of hundreds" by Jehoiah the priest (2 Chron. xxiii. 1). (11) Son of Hilkiah and grandfather of Ezra the Scribe (Ezra vii. 1; Neh. vii. 7, viii. 7, x. 2). (12) Son of Maseiah, one of those who under the commission of Artaxerxes restored the wall of Jerusalem (Neh. iii. 23). (13) Son of Hoshai, an opponent of the prophet Jeremiah (Jer. xliii. 2). (14) One of the companions in captivity of the prophet Daniel, called Abednego by Nebuchadnezzar, by whom with two companions he was cast into a "burning fiery furnace" for refusing to worship the golden image set up by that monarch (Dan. i. 6, iii. 8-30).

AZAY-LE-RIDEAU, a town of western France, in the department of Indre-et-Loire, on the Indre, 16 m. S.W. of Tours by rail. Pop. (1906) 1453. The town has a fine Renaissance chateau, well restored in modern times, with good collections of furniture and pictures.

AZEGLIO, **MASSIMO TAPARELLI**, MARQUIS D' (1798-1866), Italian statesman and author, was born at Turin in October 1798, descended from an ancient and noble Piedmontese family. His father, Cesare d'Azeglio, was an officer in the Piedmontese army and held a high position at court; on the return of Pope

Pius VII. to Rome after the fall of Napoleon, Cesare d'Azeglio was sent as special envoy to the Vatican, and he took his son, then sixteen years of age, with him as an extra attaché. Young Massimo was given a commission in a cavalry regiment, which he soon relinquished on account of his health. During his residence in Rome he had acquired a love for art and music, and he now determined to become a painter, to the horror of his family, who belonged to the stiff and narrow Piedmontese aristocracy. His father reluctantly consented, and Massimo settled in Rome, devoting himself to art. He led an abstemious life, maintaining himself by his painting for several years. But he was constantly meditating on the political state of Italy. In 1830 he returned to Turin, and after his father's death in 1831 removed to Milan. There he remained for twelve years, moving in the literary and artistic circles of the city. He became the intimate of Alessandro Manzoni the novelist, whose daughter he married; and thenceforth literature became his chief occupation instead of art, and he produced two historical novels, *Niccolò dei Lapi* and *Ettore Fieramosca*, in imitation of Manzoni, and with pronounced political tendencies, his object being to point out the evils of foreign domination in Italy and to reawaken national feeling. In 1845 he visited Romagna as an unauthorized political envoy, to report on its conditions and the troubles which he foresaw would break out on the death of Pope Gregory XVI. The following year he published his famous pamphlet *Degli ultimi casi di Romagna* at Florence, in consequence of which he was expelled from Tuscany. He spent the next few months in Rome, sharing the general enthusiasm over the supposed liberalism of the new pope, Pius IX.; like V. Gioberti and Balbo he believed in an Italian confederation under papal auspices, and was opposed to the Radical wing of the Liberal party. His political activity increased, and he wrote various other pamphlets, among which was *I lutti di Lombardia* (1848).

On the outbreak of the first war of independence, d'Azeglio donned the papal uniform and took part under General Durando in the defence of Vicenza, where he was severely wounded. He retired to Florence to recover, but as he opposed the democrats who ruled in Tuscany, he was expelled from that country for the second time. He was now a famous man, and early in 1849 Charles Albert, king of Sardinia, invited him to form a cabinet. But realizing how impossible it was to renew the campaign, and "not having the heart to sign, in such wretched internal and external conditions, a treaty of peace with Austria" (*Correspondance politique*, by E. Rendu), he refused. After the defeat of Novara (23rd of March 1849), Charles Albert abdicated and was succeeded by Victor Emmanuel II. D'Azeglio was again called on to form a cabinet, and this time, although the situation was even more difficult, he accepted, concluded a treaty of peace, dissolved the Chamber, and summoned a new one to ratify it. The treaty was accepted, and d'Azeglio continued in office for the next three years. While all the rest of Italy was a prey to despotism, in Piedmont the king maintained the constitution intact in the face of the general wave of reaction. D'Azeglio conducted the affairs of the country with tact and ability, improving its diplomatic relations, and opposing the claims of the Roman Curia. He invited Count Cavour, then a rising young politician, to enter the ministry in 1850. Cavour and Farini, also a member of the cabinet, made certain declarations in the Chamber (May 1852) which led the ministry in the direction of an alliance with Rattazzi and the Left. Of this d'Azeglio disapproved, and therefore resigned office, but on the king's request he formed a new ministry, including both Cavour and Farini. In October, however, owing to ill-health and dissatisfaction with some of his colleagues, as well as for other reasons not quite clear, he resigned once more and retired into private life, suggesting Cavour to the king as his successor.

For the next four years he lived modestly at Turin, devoting himself once more to art, although he also continued to take an active interest in politics, Cavour always consulting him on matters of moment. In 1855 he was appointed director of the Turin art gallery. In 1859 he was given various political missions, including one to Paris and London to prepare the basis for a

general congress of the powers on the Italian question. When war between Piedmont and Austria appeared inevitable he returned to Italy, and was sent as royal commissioner by Cavour to Romagna, whence the papal troops had been expelled. After the peace of Villafranca, d'Azeglio was recalled with orders to withdraw the Piedmontese garrisons; but he saw the danger of allowing the papal troops to reoccupy the province, and after a severe inner struggle left Bologna without the troops, and interviewed the king. The latter approved of his action, and said that his orders had not been accurately expressed; thus Romagna was saved. That same year he published a pamphlet in French entitled *De la Politique et du droit chrétien au point de vue de la question italienne*, with the object of inducing Napoleon III. to continue his pro-Italian policy. Early in 1860 Cavour appointed him governor of Milan, evacuated by the Austrians after the battle of Magenta, a position which he held with great ability. But, disapproving of the government's policy with regard to Garibaldi's Sicilian expedition and the occupation by Piedmont of the kingdom of Naples as inopportune, he resigned office.

The death of his two brothers in 1862 and of Cavour in 1861 caused Massimo great grief, and he subsequently led a comparatively retired life. But he took part in politics, both as a deputy and a writer, his two chief subjects of interest being the Roman question and the relations of Piedmont (now the kingdom of Italy) with Mazzini and the other revolutionists. In his opinion Italy must be unified by means of the Franco-Piedmontese army alone, all connexion with the conspirators being eschewed, while the pope should enjoy nominal sovereignty over Rome, with full spiritual independence, the capital of Italy being established elsewhere, but the Romans being Italian citizens (see his letters to E. Rendu and his pamphlet *Le questioni urgenti*). He strongly disapproved of the convention of 1864 between the Italian government and the pope. The last few years of d'Azeglio's life were spent chiefly at his villa of Cannero, where he set to work to write his own memoirs. He died of fever on the 15th of January 1866.

Massimo d'Azeglio was a very attractive personality, as well as an absolutely honest patriot, and a characteristic example of the best type of Piedmontese aristocrat. He was cautious and conservative; in his general ideas on the liberation of Italy he was wrong, and to some extent he was an amateur in politics, but of his sincerity there is no doubt. As an author his political writings are trenchant and clear, but his novels are somewhat heavy and old-fashioned, and are interesting only if one reads the political allusions between the lines.

Besides a variety of newspaper articles and pamphlets, d'Azeglio's chief works are the two novels *Ettore Fieramosca* (1833) and *Niccolò dei Lapi* (1841), and a volume of autobiographical memoirs entitled *Mei Ricordi*, a most charming work published after his death, in 1866, but unfortunately incomplete. See in addition to the *Ricordi*, L. Carpi's *Il Risorgimento Italiano*, vol. I, pp. 288 sq., and the *Souvenirs historiques* of Constance d'Azeglio, Massimo's niece (Turin, 1884). (L. V.*)

AZERBAIJĀN (also spelt **ADERBIJĀN**; the *Azerbādeğān* of medieval writers, the *Athrapatakān* and *Atropateneē* of the ancients), the north-western and most important province of Persia. It is separated from Russian territory on the N. by the river Aras (Araxes), while it has the Caspian Sea, Gilan and Khamsheh (Zenjān) on the E., Kurdistan on the S., and Asiatic Turkey on the W. Its area is estimated at 32,000 sq. m.; its population at 1½ to 2 millions, comprising various races, as Persians proper, Turks, Kurds, Syrians, Armenians, &c. The country is superior in fertility to most provinces of Persia, and consists of a regular succession of undulating eminences, partially cultivated and opening into extensive plains. Near the centre of the province the mountains of Sahand rise in an accumulated mass to the height of 12,000 ft. above the sea. The highest mountain of the province is in its eastern part, Mount Savelan, with an elevation of 15,792 ft., and the Talish Mountains, which run from north to south, parallel to and at no great distance from the Caspian, have an altitude of 9000 ft. The principal rivers are the Aras and Kizil Uzun, both receiving numerous tributaries and flowing into the Caspian, and the Jaghatu, Tataba, Murdi, Aji and others, which

drain into the Urmia lake. The country to the west of the lake, with the districts of Selmas and Urmia, is the most prosperous part of Azerbâijân, yet even here the intelligent traveller laments the want of enterprise among the inhabitants. Azerbâijân is one of the most productive provinces of Persia. The orchards and gardens in which many villages are embosomed yield delicious fruits of almost every description, and great quantities, dried, are exported, principally to Russia. Provisions are cheap and abundant, but there is a lack of forests and timber trees. Lead, copper, sulphur, orpiment, also lignite, have been found within the confines of the province; also a kind of beautiful, variegated, translucent marble, which takes a high polish, is used in the construction of palatial buildings, tanks, baths, &c., and is known as Maragha, or Tabriz marble. The climate is healthy, not hot in summer, and cold in winter. The cold sometimes is severely felt by the poor classes owing to want of proper fuel, for which a great part of the population has no substitute except dried cowdung. Snow lies on the mountains for about eight months in the year, and water is everywhere abundant. The best soils when abundantly irrigated yield from 50- to 60-fold, and the water for this purpose is supplied by the innumerable streams which intersect the province. The natives of Azerbâijân make excellent soldiers, and about a third of the Persian army is composed of them. The province is divided into a number of administrative sub-provinces or districts, each with a *hâkim*, governor or sub-governor, under the governor-general, who under the Kajâr dynasty has always been the heir-apparent to the throne of Persia, assisted by a responsible minister appointed by the shah. The administrative divisions are as follows:—Tabriz and environs; Uskûh; Deh-Kharegan; Maragha; Miandoab; Satjbulagh; Suldûz; Urmia; Selmas; Khoi; Maku; Geger; Merend; Karadagh; Arvanek; Talish; Ardebil; Mishkin; Khalkhâl; Hashtadr; Garmrud; Afshar; Sain Kaleb; Ujan; Sarab. The revenue amounts to about £200,000 per annum in cash and kind, and nearly all of it is expended in the province for the maintenance of the court of the heir-apparent, the salaries and pay to government officials, troops, pensions, &c. (A.H.S.).

AZIMUTH (from the Arabic), in astronomy, the angular distance from the north or south point of the horizon to the foot of the vertical circle through a heavenly body. In the case of a horizontal line the azimuth is its deviation from the north or south direction.

AZO (c. 1150–1230), Italian jurist. This Azo, whose name is sometimes written Azzo and Azzolenus, and who is occasionally described as Azo Soldanus, from the surname of his father, is to be distinguished from two other famous Italians of the same name, viz. Azo Lambertaccius, a canonist of the 13th century, professor of canon law at the university of Bologna, author of *Questiones in jus canonicum*, and Azo de Ramenghis, a canonist of the 14th century, also a professor of canon law at Bologna, and author of *Repetitiones super libro Decretorum*. Few particulars are known as to the life of Azo, further than that he was born at Bologna about the middle of the 12th century, and was a pupil of Joannes Bassianus, and afterwards became professor of civil law in the university of his native town. He also took an active part in municipal life, Bologna, with the other Lombard republics, having gained its municipal independence. Azo occupied a very important position amongst the glossators, and his *Readings on the Code*, which were collected by his pupil, Alessandro de Santo Aegidio, and completed by the additions of Hugolino and Odofredus, form a methodical exposition of Roman law, and were of such weight before the tribunals that it used to be said, “Chi non ha Azzo, non vada a palazzo.” Azo gained a great reputation as a professor, and numbered amongst his pupils Accursius and Jacobus Baldinus. He died about 1230.

AZO COMPOUNDS, organic substances of the type R-N:N-R' (where R = an aryl radical and R' = a substituted alkyl, or aryl radical). They may be prepared by the reduction of nitro compounds in alkaline solution (using zinc dust and alkali, or a solution of an alkaline stannite as a reducing agent); by oxidation of hydrazo compounds; or by the coupling of a diazotized amine and any compound of a phenolic or aminic type, provided

that there is a free para position in the amine or phenol. They may also be obtained by the molecular rearrangement of the diazoamines, when these are warmed with the parent base and its hydrochloride. This latter method of formation has been studied by H. Goldschmidt and R. U. Reinders (*Ber.*, 1896, 29, p. 1369), who found that the reaction is monomolecular, and that the velocity constant of the reaction is proportional to the amount of the hydrochloride of the base present and also to the temperature, but is independent of the concentration of the diazoamine. The azo compounds are intensely coloured, but are not capable of being used as dyestuffs unless they contain salt-forming, acid or basic groups (see DYEING). By oxidizing agents they are converted into azoxy compounds, and by reducing agents into hydrazo compounds or amines.

Azo-benzene, C₆H₅N:NC₆H₅, discovered by E. Mitscherlich in 1834, may be prepared by reducing nitrobenzene in alcoholic solution with zinc dust and caustic soda; by the condensation of nitrosobenzene with aniline in hot glacial acetic acid solution; or by the oxidation of aniline with sodium hypobromite. It crystallizes from alcohol in orange red plates which melt at 68° C. and boil at 295° C. It does not react with acids or alkalis, but on reduction with zinc dust in acetic acid solution yields aniline.

Amino-azo Compounds may be prepared as shown above. They are usually yellowish brown or red in colour, the presence of more amino groups leading to browner shades, whilst the introduction of alkylated amino groups gives redder shades. They usually crystallize well and are readily reduced. When heated with aniline and aniline hydrochloride they yield indulines (q.v.). *Amino-azo-benzene*, C₆H₅N₂C₆H₄NH₂, crystallizes in yellow plates or needles and melts at 126° C. Its constitution is determined by the facts that it may be prepared by reducing nitro-azo-benzene by ammonium sulphide and that by reduction with stannous chloride it yields aniline and meta-phenylene diamine. *Diamino-azo-benzene* (chrysoidine), C₆H₅N₂C₆H₄(NH₂)₂, first prepared by O. Witt (*Ber.*, 1877, 10, p. 656), is obtained by coupling phenyl diazonium chloride with meta-phenylene diamine. It crystallizes in red octahedra and dyes silk and wool yellow. *Triamino-azo-benzene* (meta-aminobenzene-azo-meta-phenylene diamine or Bismarck brown, phenylene brown, vesuvine, Manchester brown), NH₂C₆H₄N₂C₆H₃(NH₂)₂, is prepared by the action of nitrous acid on meta-phenylene diamine. It forms brown crystals which are readily soluble in hot water, and it dyes mordanted cotton a dark brown. On the composition of the commercial Bismarck brown see E. Täuber and F. Walder (*Ber.*, 1897, 30, pp. 2111, 2899; 1900, 33, p. 2116). Alkylated amino-azo-benzenes are also known, and are formed by the coupling of diazonium salts with alkylated amines, provided they contain a free para position with respect to the amino group. In these cases it has been shown by H. Goldschmidt and A. Merz (*Ber.*, 1897, 30, p. 670) that the velocity of formation of the amino-azo compound depends only on the nature of the reagents and not on the concentration, and that in coupling the hydrochloride of a tertiary amine with diazobenzene sulphonic acid the reaction takes place between the acid and the base set free by the hydrolytic dissociation of its salt, for the formation of the amino-azo compound, when carried out in the presence of different acids, takes place most rapidly with the weakest acid (H. Goldschmidt and F. Buss, *Ber.*, 1897, 30, p. 2075).

Methyl orange (helianthin, gold orange, Mandarin orange), (CH₃)₂N·C₆H₄·N₂·C₆H₄SO₃Na, is the sodium salt of para-dimethylaminobenzene-azo-benzene sulphonic acid. It is an orange crystalline powder which is soluble in water, forming a yellow solution. The free acid is intensely red in colour. Methyl orange is used largely as an indicator. The constitution of methyl orange follows from the fact that on reduction by stannous chloride in hydrochloric acid solution it yields sulphanic acid and para-aminodimethyl aniline.

Oxyazo Compounds.—The oxyazo compounds are prepared by adding a solution of a diazonium salt to a cold slightly alkaline solution of a phenol. The diazo group takes up the para position

with regard to the hydroxyl group, and if this be prevented it then goes into the ortho position. It never goes directly into the meta position.

The constitution of the oxazo compounds has attracted much attention, some chemists holding that they are true azophenols of the type $R-N_2-R_1-OH$, while others look upon them as having a quinonoid structure, i.e. as being quinone hydrazones, type $R-NH-N:R_1O$. The first to attack the purely chemical side were Th. Zincke (*Ber.*, 1883, 16, p. 2929; 1884, 17, p. 3026; 1887, 20, p. 3171) and R. Meldola (*Jour. Chem. Soc.*, 1889, 55, pp. 114, 603). Th. Zincke found that the products obtained by coupling a diazonium salt with α -naphthol, and by condensing phenylhydrazine with α -naphthoquinone, were identical; whilst Meldola acetylated the azophenols, and split the acetyl products by reduction in acid solution, but obtained no satisfactory results. K. Auwers (*Zeit. f. phys. Chem.*, 1896, 21, p. 355; *Ber.*, 1900, 33, p. 1302) examined the question from the physico-chemical standpoint by determining the freezing-point depressions, the result being that the para-oxazo compounds give abnormal depressions and the ortho-oxazo compounds give normal depressions; Auwers then concluded that the para compounds are phenolic and the ortho compounds are quinone hydrazones or act as such. A. Hantzsch (*Ber.*, 1899, 32, pp. 590, 3089) considers that the oxazo compounds are to be classed as pseudo-acids, possessing in the free condition the configuration of quinone hydrazones, their salts, however, being of the normal phenolic type. J. T. Hewitt (*Jour. Chem. Soc.*, 1900, 77, pp. 99 et seq.) nitrated para-oxazobenzene with dilute nitric acid and found that it gave a benzene-azo-ortho-nitrophenol, whereas quinones are not attacked by dilute nitric acid. Hewitt has also attacked the problem by brominating the oxazobenzenes, and has shown that when the hydrobromic acid produced in the reaction is allowed to remain in the system, a brombenzene-azo-phenol is formed, whilst if it be removed (by the addition of sodium acetate) bromination takes place in the phenolic nucleus; consequently the presence of the mineral acid gives the azo compound a pseudo-quinonoid character, which it does not possess if the mineral acid be removed from the sphere of the reaction.

Para-oxazobenzene (benzene-azo-phenol), $C_6H_5N:N(1) \cdot C_6H_5OH(4)$, is prepared by coupling diazotized aniline with phenol in alkaline solution. It is an orange-red crystalline compound which melts at $154^\circ C$. Ortho-oxazobenzene, $C_6H_5N:N(1) \cdot C_6H_5OH(2)$, was obtained in small quantity by E. Bamberger (*Ber.*, 1900, 33, p. 3189) simultaneously with the para compound, from which it may be separated by distillation in a current of steam, the ortho compound passing over with the steam. It crystallizes in orange-red needles which melt at $82.5-83^\circ C$. On reduction with zinc dust in dilute ammoniac solution, it yields ortho-aminophenol and aniline. Meta-oxazobenzene, $C_6H_5N:N(1) \cdot C_6H_5OH(3)$, was obtained in 1903 by P. Jacobson (*Ber.*, 1903, 36, p. 4093) by condensing ortho-anisidine with diazo benzene, the resulting compound being then diazotized and reduced by alcohol to benzene-azo-meta-anisole, from which meta-oxazobenzene was obtained by hydrolysis with aluminium chloride. It melts at $112-114^\circ C$. and is easily reduced to the corresponding hydrazo compound.

Diazo-Amines.—The diazo-amines, $R-N:NHR_1$, are obtained by the action of primary amines on diazonium salts; by the action of nitrous acid on a free primary amine, an isodiazohydroxide being formed as an intermediate product which then condenses with the amine; and by the action of nitrosamines on primary amines. They are crystalline solids, usually of a yellow colour, which do not unite with acids; they are readily converted into amino-azo compounds (see above) and are decomposed by the concentrated halogen acids, yielding haloid benzenes, nitrogen and an amine. Acid anhydrides replace the imino-hydrogen atom by acyl radicals, and boiling with water converts them into phenols. They combine with phenyl isocyanate to form urea derivatives (H. Goldschmidt, *Ber.*, 1888, 21, p. 2578), and on reduction with zinc dust (preferably in alcoholic acetic acid solution) they yield usually a hydrazine and an amine. Diazoamino benzene, $C_6H_5N:N \cdot NHCC_6H_5$, was first

obtained by P. Griess (*Ann.*, 1862, 121, p. 258). It crystallizes in yellow laminae, which melt at $96^\circ C$. and explode at slightly higher temperatures. It is readily soluble in alcohol, ether and benzene.

Diazoimino benzene, $C_6H_5N_2$, is also known. It may be prepared by the action of ammonia on diazobenzene perbromide; by the action of hydroxylamine on a diazonium sulphate (K. Heumann and L. Oeconomidis, *Ber.*, 1887, 20, p. 372); and by the action of phenylhydrazine on a diazonium sulphate. It is a yellow oil which boils at $50^\circ C$. (12 mm.), and possesses a stupefying odour. It explodes when heated. Hydrochloric acid converts it into chloraniline, nitrogen being eliminated; whilst boiling sulphuric acid converts it into aminophenol.

Azoxy Compounds, $R-N(O)-N-R'$, are usually yellow or red crystalline solids which result from the reduction of nitro or nitroso compounds by heating them with alcoholic potash (preferably using methyl alcohol). They may also be obtained by the oxidation of azo compounds. When reduced (in acid solution) they yield amines; distillation with reduced iron gives azo compounds, and warming with ammonium sulphide gives hydrazo compounds. Concentrated sulphuric acid converts azoxybenzene into oxazobenzene (O. Wallach, *Ber.*, 1880, 13, p. 525). Azoxybenzene, $(C_6H_5N_2O)_2$, crystallizes from alcohol in yellow needles, which melt at $36^\circ C$. On distillation, it yields aniline and azobenzene. Azoxybenzene is also found among the electro-reduction products of nitrobenzene, when the reduction is carried out in alcoholic-alkaline solution.

The mixed azo compounds are those in which the azo group $-N:N-$ is united with an aromatic radical on the one hand, and with a radical of the aliphatic series on the other. The most easily obtained mixed azo compounds are those formed by the union of a diazonium salt with the potassium or sodium salt of a nitroparaffin (V. Meyer, *Ber.*, 1876, 9, p. 384):

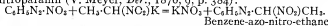

Benzene-azo-nitroethane, $C_6H_5NH \cdot CH_2 \cdot CH_2 \cdot NO_2$, those not containing a nitro group may be prepared by the oxidation of the corresponding mixed hydrazo compounds with mercuric oxide. E. Bamberger (*Ber.*, 1898, 31, p. 455) has shown that the nitro-alkyl derivatives behave as though they possess the constitution of hydrazones, for on heating with dilute alkalis they split more or less readily into an alkaline nitrite and an acid hydrazone:

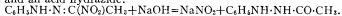

Benzene-azo-methane, $C_6H_5N_2 \cdot CH_3$, is a yellow oil which boils at $150^\circ C$. and is readily volatile in steam. Benzene-azo-ethane, $C_6H_5N_2 \cdot C_2H_5$, is a yellow oil which boils at about $180^\circ C$. with more or less decomposition. On standing with 60% sulphuric acid for some time, it is converted into the isomeric acetaldehyde-phenylhydrazone, $C_6H_5NH \cdot N:CH \cdot CH_3$ (*Ber.*, 1896, 29, p. 794).

The diazo cyanides, $C_6H_5N_2 \cdot CN$, and carboxylic acids, $C_6H_5N_2 \cdot COOH$, may also be considered as mixed azo derivatives. Diazobenzene cyanide, $C_6H_5N_2 \cdot CN$, is an unstable oil, formed when potassium cyanide is added to a solution of a diazonium salt. Phenyl-azo-carboxylic acid, $C_6H_5N_2 \cdot COOH$, is obtained in the form of its potassium salt when phenylsemicarbazide is oxidized with potassium permanganate in alkaline solution (J. Thiele, *Ber.*, 1895, 28, p. 2600). It crystallizes in orange-red needles and is decomposed by water. The corresponding amide, phenyl-azo-carbonamide, $C_6H_5N_2 \cdot CONH_2$, also results from the oxidation of phenylsemicarbazide (Thiele, *loc. cit.*), and forms reddish-yellow needles which melt at $114^\circ C$. When heated with benzaldehyde to $120^\circ C$. it yields diphenyloxtriazone, $(C_6H_5)_2C_2N_2C(OH)$.

AZOIMIDE, or HYDRAZOIC ACID, N_2H_4 , a compound of nitrogen and hydrogen, first isolated in 1890 by Th. Curtius (*Berichte*, 1890, 23, p. 3023). It is the hydrogen compound corresponding to P. Griess' diazoimino benzene, $C_6H_5N_2$, which is prepared by the addition of ammonia to diazobenzene perbromide.

Curtius found that benzoyl glycolic acid gave benzoyl hydrazine with hydrazine hydrate:

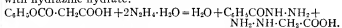

(Ethyl benzoate may be employed instead of benzoyl glycolic acid for this reaction.) This compound gave a nitroso compound with nitrous acid, which changed spontaneously into benzoyl-azoimide by loss of water:

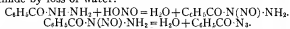

The resulting benzoylazoimide is easily hydrolysed by boiling with alcoholic solutions of caustic alkalis, a benzoate of the alkali metal and an alkali salt of the new acid being obtained; the latter is precipitated in crystalline condition on standing.

An improved method of preparation was found in the use of hippuric acid, which reacts with hydrazine hydrate to form hippuryl hydrazine, $\text{C}_6\text{H}_5\text{CONH-CH}_2\text{CONH-NH}_2$, and this substance is converted by nitrous acid into diazo-hippuramide, $\text{C}_6\text{H}_5\text{CONH-CH}_2\text{-CO-NH-N}_2$, which is hydrolysed by the action of caustic alkalis with the production of salts of hydrazoic acid. To obtain the free acid it is best to dissolve the diazo-hippuramide in dilute soda, warm the solution to ensure the formation of the sodium salt, and distil the resulting liquid with dilute sulphuric acid. The pure acid may be obtained by fractional distillation as a colourless liquid of very unpleasant smell, boiling at 30°C ., and extremely explosive. It is soluble in water, and the solution dissolves many metals (zinc, iron, &c.) with liberation of hydrogen and formation of salts (azoimides, azides or hydrazoates). All the salts are explosive and readily interact with the alkyl iodides. In its properties it shows some analogy to the halogen acids, since it forms difficultly soluble lead, silver and mercurous salts. The metallic salts all crystallize in the anhydrous condition and decompose on heating, leaving a residue of the pure metal. The acid is a "weak" acid, being ionized only to a very slight extent in dilute aqueous solution.

E. Noelting and E. Grandmougin (*Berichte*, 1897, 24, p. 2546) obtained azoimide from dinitraniline, $\text{C}_6\text{H}_4(\text{NO}_2)_2\text{-NH}_2$, by diazotization and conversion of the diazo compound into the perbromide, $(\text{NO}_2)_2\text{C}_6\text{H}_3\text{-N}_2\text{-Br}_2$. This compound is then decomposed by ammonia, dinitrophenylhydrazoate being formed, which on hydrolysis with alcoholic potash gives potassium hydrazoate (azide) and dinitrophenol. The solution is then acidified and distilled, when azoimide passes over. Somewhat later, they found that it could be prepared from diazobenzene imide, provided a nitro group were present in the ortho or para position to the diazo group. The para-nitro compound is dropped slowly into a cold solution of one part of caustic potash in ten parts of absolute alcohol; the solution becomes dark red in colour and is then warmed for two days on the water bath. After the greater portion of the alcohol has distilled off, the solution is acidified with sulphuric acid and the azoimide distilled over. The yield obtained is only about 40% of that required by theory, on account of secondary reactions taking place. Ortho-nitro-diazobenzene imide only yields 30%.

W. Wislicenus (*Berichte*, 1892, 25, p. 2084) has prepared the sodium salt by passing nitrous oxide over sodamide at high temperatures. The acid can also be obtained by the action of nitrous acid on hydrazine sulphate; by the oxidation of hydrazine by hydrogen peroxide and sulphuric acid (A. W. Browne, *J. Amer. Chem. Soc.*, 1905, 25, p. 251), or by ammonium metavanadate (A. W. Browne and F. F. Shetterly, *Abst. J.C.S.*, 1907, ii, p. 863).

Ammonium azoimide, $\text{N}_2\text{-NH}_4$, may be prepared by boiling diazohippuramide with alcoholic ammonia, until no more ammonia escapes, the following reaction taking place:

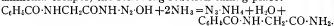

The liquid is then allowed to stand for twelve hours, and the clear alcoholic solution is decanted from the precipitated hippuramide. To the alcoholic solution, four times its volume of ether is added, when the ammonium salt is precipitated. It is then filtered, washed with ether, and air-dried. The salt is readily soluble in water, and is only feebly alkaline. It is extremely explosive. *Hydrazine azoimide*, N_2H_4 , is also known.

Chloroazoimide, Cl-N_2 , the chloride corresponding to azoimide,

was obtained by F. Raschig (*Ber.*, 1908, 41, p. 4194) as a highly explosive colourless gas on acidifying a mixture of sodium azide and hypochlorite with acetic or boric acid.

AZORES (*Açores*), or WESTERN ISLANDS, an archipelago in the Atlantic Ocean, belonging to the kingdom of Portugal. Pop. (1900) 256,291; area, 922 sq. m. The Azores extend in an oblique line from N.W. to S.E., between $36^\circ 55'$ and $30^\circ 55'$ N., and between 25° and $31^\circ 16'$ W. They are divided into three widely severed groups, rising from a depth of more than $2\frac{1}{2}$ m. The south-eastern group consists of St Michael's (São Miguel) and St Mary (Santa Maria), with Formigas; the central, of

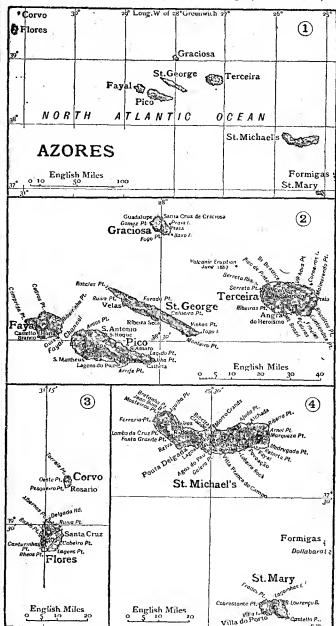

Fayal (Faial), Pico, St George (São Jorge), Terceira and Graciosa; the north-western, of Flores and Corvo.

The nearest continental land is Cape da Roca on the Portuguese coast, which lies 830 m. E. of St Michael's; while Cape Cantin, the nearest point on the African mainland, is more than 900 m. distant, and Cape Race in Newfoundland, the nearest American headland, is more than 1000 m. Thus the Azores are the farthest from any continent of all the island groups in the Atlantic; but they are usually regarded as belonging to Europe, as their climate and flora are European in character.

Physical Description.—The aspect of all the islands is very similar in general characteristics, presenting an elevated and

undulating outline, with little or no tableland, and rising into peaks, of which the lowest, that of Corvo, is 350 ft., and the highest that of Pico, 7612 ft. above sea-level. The lines of sea-coast are, with few exceptions, high and precipitous, with bases of accumulated masses of fallen rock, in which open bays, or scarcely more enclosed inlets, form the harbours of the trading towns. The volcanic character of the whole archipelago is obvious, and has been abundantly confirmed by the numerous earthquakes and eruptions which have taken place since its discovery. Basalt and scoria are the chief erupted materials. Hitherto Flores, Corvo and Graciosa have been quite exempt, and Fayal has only suffered from one eruption (1672). The centre of activity has for the most part been St Michael's, while the neighbouring island of St Mary has altogether escaped. In 1444-1445 there was a great eruption at St Michael's, of which, however, the accounts that have been preserved exaggerate the importance. In 1522 the town of Villa Franca, at that time the capital of the island, was buried, with all its 6000 inhabitants, during a violent convulsion. In 1572 an eruption took place in Pico; in 1580 St George was the scene of numerous outbursts; and in 1614 a little town in Terceira was destroyed. In 1630, 1652, 1656, 1755, 1852, &c., St Michael's was visited with successive eruptions and earthquakes, several of them of great violence. On various occasions, as in 1638, 1720, 1811 and 1867, subterranean eruptions have taken place, which have sometimes been accompanied by the appearance of temporary islands. Of these the most remarkable was thrown up in June 1811, about half a league from the western extremity of St Michael's. It was called Sabrina by the commander of the British man-of-war of that name, who witnessed the phenomenon.

Climate.—The climate is particularly temperate, but the extremes of sensible heat and cold are increased by the humidity. The range of the thermometer is from 45° Fahr., the lowest known extreme, or 48°, the ordinary lowest extreme of January, to 82°, the ordinary, or 86°, the highest known extreme of July, near the level of the sea. Between these two points (both taken in the shade) there is from month to month a pretty regular gradation of increase or decrease, amounting to somewhat less than four degrees. In winter the prevailing winds are from the north-west, west and south; in summer the most frequent are the north, north-east and east. The weather is often extremely stormy, and the winds from the west and south-west render the navigation of the coasts very dangerous.

Fauna.—The mammalia of the Azores are limited to the rabbit, weasel, ferret, rat (brown and black), mouse and bat, in addition to domestic animals. The game includes the woodcock, red partridge (introduced in the 16th century), quail and snipe. Owing to the damage inflicted on the crops by the multitude of blackbirds, bullfinches, chaffinches and green canaries, a reward was formerly paid for the destruction of birds in St Michael's, and it is said that over 400,000 were destroyed in several successive years between 1875 and 1885. There are valuable fisheries of tunny, mullet and bonito. The porpoise, dolphin and whale are also common. Whale-fishing is a profitable industry, with its headquarters at Fayal, whence the sperm-oil is exported. Eels are found in the rivers. The only indigenous reptile is the lizard. Fresh-water molluscs are unknown, and near the coast the marine fauna is not rich; but terrestrial molluscs abound, several species being peculiar to the Azores.

Flora.—The general character of the flora is decidedly European, no fewer than 400 out of the 478 species generally considered as indigenous belonging likewise to that continent, while only four are found in America, and forty are peculiar to the archipelago. Vegetation in most of the islands is remarkably rich, especially in grasses, mosses, and ferns, heath, juniper, and a variety of shrubs. Of tall-growing trees there was, till the 19th century, an almost total lack; but the Bordeaux pine, European poplar, African palm-tree, Australian eucalyptus, chestnut, tulip-tree, elm, oak, and many others, were then successfully introduced. The orange, apricot, banana, lemon, citron, Japanese medlar, and pomegranate are the common fruits, and various other varieties are more or less cultivated.

At one time much attention was given to the growing of sugarcane, but it has now for the most part been abandoned. The culture of indigo, introduced in the 16th century, also belongs to the past. A kind of fern (*Dicksonia calcitica*), called by the natives *cabellino*, furnishes a silky material for the stuffing of mattresses and is exported to Brazil and Portugal.

Population.—The inhabitants of the islands are mostly of Portuguese origin, with a well-marked strain of Moorish and Flemish blood. There is a high birth-rate and a low average of infant mortality. A large proportion of the poorer classes, especially among the older men and women, are totally illiterate, but education tends to spread more rapidly than in Portugal itself, owing to the custom of sending children to the United States, where they are taught in the state schools. Negroes, mulattoes, English, Scottish and Irish immigrants are present in considerable numbers, especially in Fayal and St Michael's. The total number of resident foreigners in 1900 was 1490.

Government.—The Azores are subdivided into three administrative districts named after their chief towns, *i.e.* Ponta Delgada, the capital of St Michael's; Angra, or Angra do Heroísmo, the capital of Terceira; and Horta, the capital of Fayal. St Michael's and St Mary are included in the district of Ponta Delgada; Terceira, St George and Graciosa, in that of Angra; Pico, Fayal, Flores and Corvo, in that of Horta. Four members are returned by Ponta Delgada to the parliament in Lisbon, while each of the other districts returns two members. Roman Catholicism is the creed of the majority, and Angra is an episcopal see. For purposes of military administration the islands form two commands, with their respective headquarters at Angra and Ponta Delgada. Besides the frequent and regular services of mails which connect the Azores with Portugal and other countries, there is a cable from Lisbon to Villa Franca do Campo, in St Michael's, and thence to Pico, Fayal, St George and Graciosa. Fayal is connected with Waterville, in Ireland, by a cable laid in 1901. At Angra and Ponta Delgada there are meteorological stations. The principal seaports are Angra (pop. 1900, 10,788), Ponta Delgada (17,620), and Horta (6574).

Trade.—The trade of the Azores, long a Portuguese monopoly, is now to a great extent shared by the United Kingdom and Germany, and is chiefly carried in British vessels. Textiles are imported from Portugal; coal from Great Britain; sugar from Germany, Madeira and the United States; stationery, hardware, chemicals, paints, oils, &c., from the United Kingdom and Germany. The exports consist chiefly of fruit, wine, natural mineral waters and provisions. The trade in pineapples is especially important. No fewer than 400,000 pineapples were exported in 1902 and 1903, going in almost equal quantities to London and Hamburg. The fruit is raised under glass. Pottery, cotton fabrics, spirits, straw hats and tea are produced in the district of Ponta Delgada; linen and woollen goods, cheese, butter, soap, bricks and tiles, in that of Angra; baskets, mats, and various ornamental articles made from straw, osier, and the pith of dried fig-wood, in that of Horta.

The largest and most populous of the Azores is St Michael's, which has an area of 297 sq. m., and in 1900 had 121,340 inhabitants. Graciosa (pop. 8385; area, 17 sq. m.) and St George (16,177; 40 sq. m.) form part of the central group. Terceira is noteworthy for the beauty of its scenery. Its chief towns are Santa Cruz de Graciosa (2185) and Guadalupe (2717). The chief towns of St George are Ribeira Seca (2817) and Velas (2000).

History.—It does not appear that the ancient Greeks and Romans had any knowledge of the Azores, but from the number of Carthaginian coins discovered in Corvo it has been supposed that the islands must have been visited by that adventurous people. The Arabian geographers, Edrisi in the 12th century, and Ibn-al-Wardi in the 14th, describe, after the Canaries, nine other islands in the Western Ocean, which are in all probability the Azores. This identification is supported by various considerations. The number of islands is the same; the climate under which they are placed by the Arabians makes them north of the Canaries; and special mention is made of the hawks or buzzards, which were sufficiently numerous at a later period to

give rise to the present name (Port. *Açor*, a hawk). The Arabian writers represent them as having been populous, and as having contained cities of some magnitude; but they state that the inhabitants had been greatly reduced by intestine warfare. The Azores are first found distinctly marked in a map of 1351, the southern group being named the Goat Islands (*Cabrerias*); the middle group, the Wind or Dove Islands (*De Ventura sive de Columbis*); and the western, the Brazil Island (*De Brazi*)—the word Brazil at that time being employed for any red dye-stuff. In a Catalan map of the year 1375 Corvo is found as *Corvi Marini*, and Flores as *Li Conigi*; while St George is already designated *San Zorce*. It has been conjectured that the discoverers were Genoese, but of this there is not sufficient evidence. It is plain, however, that the so-called Flemish discovery by van der Berg is only worthy of the name in a very secondary sense. According to the usual account, he was driven on the islands in 1432, and the news excited considerable interest at the court of Lisbon. The navigator, Gonzalo Velho Cabral—not to be confounded with his greater namesake, Pedro Alvarez Cabral—was sent to prosecute the discovery. Another version relates that Prince Henry the Navigator of Portugal had in his possession a map in which the islands were laid down, and that he sent out Cabral through confidence in its accuracy. The map had been presented to him by his brother, Dom Pedro, who had travelled as far as Babylon. Be this as it may, Cabral reached the island, which he named *Santa Maria*, in 1432, and in 1444 took possession of St Michael's. The other islands were all discovered by 1457. Colonization had meanwhile been going on prosperously; and in 1466 Fayal was presented by Alphonso V. to his aunt, Isabella, the duchess of Burgundy. An influx of Flemish settlers followed, and the islands became known for a time as the Flemish Islands. From 1580 to 1640 they were subject, like the rest of the Portuguese kingdom, to Spain. At that time the Azores were the grand rendezvous for the fleets on their voyage home from the Indies; and hence they became a theatre of that maritime warfare which was carried on by the English under Queen Elizabeth against the Peninsular powers. One such expedition, which took place in 1591, led to the famous sea-fight off Flores, between the English ship "Revenge," commanded by Sir Richard Grenville, and a Spanish fleet of fifty-three vessels. Under the active administration of the marquis de Pombal (1699–1782), considerable efforts were made for the improvement of the Azores, but the stupid and bigoted government which followed rather tended to destroy these benefits. Towards the beginning of the 19th century, the possession of the islands, was contested by the claimants for the crown of Portugal. The adherents of the constitution, who supported against Miguel the rights of Maria (II.) da Gloria, obtained possession of Terceira in 1829, where they succeeded in maintaining themselves, and after various struggles, Queen Maria's authority was established over all the islands. She resided at Angra from 1830 to 1833.

For a general account of the islands, see *The Azores*, by W. F. Walker (London, 1886), and *Madeira and the Canary Islands; with the Azores*, by A. S. Brown (London, 1901). On the fauna and flora of the islands, the following books by H. Drouet are useful:—*Éléments de la faune açorienne* (Paris, 1861); *Mollusques marins des Îles Açores* (1858); *Lettres açorienne* (1862); and *Catalogue de la flore des Îles Açores, précédé de l'itinéraire d'un voyage dans cet archipel* (1866). The progress of Azorian commerce is best shown in the British and American consular reports. For history, see *La Conquête de las Azores en 1583*, by C. Fernandez Duro (Madrid, 1886), and *Histoire de la découverte des Îles Açores et de l'origine de leur dénomination d'Îles flamandes*, by J. Mees (Ghent, 1901).

AZOTH, the name given by the alchemists to mercury, and by Paracelsus to his universal remedy.

AZOTUS, the name given by Greek and Roman writers to Ashdod, an ancient city of Palestine, now represented by a few remains in the little village of 'Esdud, in the governmental district of Acre. It was situated about 3 m. inland from the Mediterranean, on the famous military route between Syria and Egypt, about equidistant (18 m.) from Joppa and Gaza. As one of the five chief cities of the Philistines and the seat of the worship of Dagon (1 Sam. v.; cf. 1 Macc. x. 83), it maintained, down even to the days of the Maccabees, a vigorous though

somewhat intermittent independence against the power of the Israelites, by whom it was nominally assigned to the territory of Judah. In 711 B.C. it was captured by the Assyrians (Is. xx. 1), but soon regained its power, and was strong enough in the next century to resist the assaults of Psammeticus, king of Egypt, for twenty-nine years (Herod. ii. 157). Restored by the Roman Gabinius from the ruins to which it had been reduced by the Jewish wars (1 Macc. v. 68, x. 77, xvi. 10), it was presented by Augustus to Salome, the sister of Herod. The only New Testament reference is in Acts viii. 40. Ashdod became the seat of a bishop early in the Christian era, but seems never to have attained any importance as a town. The Mount Azotus of 1 Macc. ix. 15, where Judas Maccabeus fell, is possibly the rising ground on which the village stands. A fine Saracenic khân is the principal relic of antiquity at 'Esdud.

AZOV, or Asov (in Turkish, *Asâb*), a town of Russia, in the government of the Don Cossacks, on the left bank of the southern arm of the Don, about 20 m. from its mouth. The ancient Tanais lay some 10 m. to the north. In the 13th century the Genoese had a factory here which they called Tana. Azov was long a place of great military and commercial importance. Peter the Great obtained possession of it after a protracted siege in 1696, but in 1711 restored it to the Turks; in 1730 it was finally united to the Russian empire. Since then it has greatly declined, owing to the silting up of its harbour and the competition of Taganrog. Its population, principally engaged in the fisheries, numbered 25,124 in 1900.

AZOV, SEA OF, an inland sea of southern Europe, communicating with the Black Sea by the Strait of Yenikale, or Kerch, the ancient *Bosporus Cimmerius*. To the Romans it was known as the *Palmus Maeoticus*, from the name of the neighbouring people, who called it in their native language *Temarenda*, or Mother of Waters. It was long supposed to possess direct communication with the Northern Ocean. In prehistoric times a connexion with the Caspian Sea existed; but since the earliest historical times no great change has taken place in regard to the character or relations of the Sea of Azov. It lies between 45° 20' and 47° 18' N. lat., and between 35° and 39° E. long., its length from southwest to north-east being 230 m., and its greatest breadth 110. The area runs to 14,515 sq. m. It generally freezes from November to the middle of April. The Don is its largest and, indeed, its only very important affluent. Near the mouth of that river the depth of the sea varies from 3 to 10 ft., and the greatest depth does not exceed 45 ft. Of recent years, too, the level has been constantly dropping, for the surface lies 4½ ft. higher than the surface of the Black Sea. Fierce and continuous winds from the east prevail during July and August, and in the latter part of the year those from the north-east and south-east are not unusual; a great variety of currents is thus produced. The water is for the most part comparatively fresh, but differs considerably in this respect according to locality and current. Fish are so abundant that the Turks describe it as *Baluk-denis*, or Fish Sea. To the west, separated from the main basin by the long narrow sand-spit of Arabat, lie the remarkable lagoons and marshes known as the Sivash, or Putrid Sea; here the water is intensely salt. The Sea of Azov is of great importance to Russian commerce; along its shores stand the cities of Taganrog, Berdyansk, Mariupol and Yenikale.

AZOXIMES (furo [a. b.] diazoles), a class of organic compounds which contain the ring system $\begin{matrix} \text{HC} & \text{N} \\ | & | \\ \text{N} & = \text{CH} > \text{O} \end{matrix}$. They may be prepared by converting nitriles into amidoximes by the action of hydroxylamine, the amidoximes so formed being then acylated by acid chlorides or anhydrides. From these acyl derivatives the elements of water are removed, either by simple heating or by boiling their aqueous solution; this elimination is accompanied by the formation of the azoxime ring. Thus

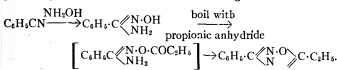

Azoximes can also be produced from *o*-benzil dioxide by the "Beckmann" change. Most of the azoximes are very volatile substances, sublime readily, and are easily soluble in water, alcohol and benzene.

For detailed descriptions, see F. Tiemann (*Ber.*, 1885, 18, p. 1059), O. Schulz (*Ber.*, 1885, 18, pp. 1084, 2459), and G. Müller (*Ber.*, 1886, 19, p. 1492); also *Annual Reports of the Chemical Society*.

AZTECS from the Nahuatl word *aztlan*, "place of the Heron," or "Heron" people), the native name of one of the tribes that occupied the tableland of Mexico on the arrival of the Spaniards in America. It has been very frequently employed as equivalent to the collective national title of Nahuatlacas or Mexicans. The Aztecs came, according to native tradition, from a country to which they gave the name of Aztlan, usually supposed to lie towards the north-west, but the satisfactory localization of it is one of the greatest difficulties in Mexican history. The date of the exodus from Aztlan is equally undetermined, being fixed by various authorities in the 11th and by others in the 12th century. One Mexican manuscript gives a date equivalent to A.D. 1164. They gradually increased their influence among other tribes, until, by union with the Toltecs, who occupied the tableland before them, they extended their empire to an area of from 18,000 to 20,000 square leagues. The researches of Humboldt gave the first clear insight into the early periods of their history. See MEXICO; NAHUATLAN STOCK.

AZUAGA, a town of western Spain, in the province of Badajoz, on the Belmez-Fuente del Arco railway. Pop. (1900) 14,192. Azuaga is the central market for the live-stock of the broad upland pastures watered by the Matalach, a left-hand tributary of the Guadiana, and by the Bembézar, a right-hand tributary of the Guadalquivir. Coarse woollen goods and pottery are manufactured in the town.

AZUAY (sometimes written ASSUAY), a province of Ecuador, bounded N. by the province of Cañar, E. by Oriente, S. by Loja, and W. by El Oro. It was formerly called Cuenca, and formed part of the department of Azuay, which also included the province of Loja. Azuay is an elevated mountainous district with a great variety of climates and products; among the latter are silver, quicksilver, wheat, Indian corn, barley, cattle, wool, cinchona and straw hats. The capital is Cuenca.

AZUNI, DOMENICO ALBERTO (1749-1827), Italian jurist, was born at Sassari, in Sardinia, in 1749. He studied law at Sassari and Turin, and in 1782 was made judge of the consulate at Nice. In 1786-1788 he published his *Dizionario Universale Ragionato della Giurisprudenza Mercantile*. In 1795 appeared his systematic work on the maritime law of Europe, *Sistema Universale dei Principii del Diritto Marittimo dell' Europa*, which he afterwards recast and translated into French. In 1806 he was appointed one of the French commission engaged in drawing up a general code of commercial law, and in the following year he proceeded to Genoa as president of the court of appeal. After the fall of Napoleon in 1814, Azuni lived for a time in retirement at Genoa, till he was invited to Sardinia by Victor Emmanuel I., and appointed judge of the consulate at Cagliari, and director of the university library. He died at Cagliari in 1827. Azuni also wrote numerous pamphlets and minor works, chiefly on maritime law, an important treatise on the origin and progress of maritime law (Paris, 1810), and an historical, geographical and political account of Sardinia (1799, enlarged 1802).

AZURARA, GOMES EANNES DE (?-1474), the second notable Portuguese chronicler in order of date. He adopted the career of letters in middle life. He probably entered the royal library as assistant to Fernão Lopes (*q.v.*) during the reign of King Duarte (1433-1438), and he had sole charge of it in 1452. His *Chronicle of the Siege and Capture of Ceuta*, a supplement to the *Chronicle of King John I.*, by Lopes, dates from 1450, and three years later he completed the first draft of the *Chronicle of the Discovery and Conquest of Guinea*, our authority for the early Portuguese voyages of discovery down the African coast and in the ocean, more especially for those undertaken under the auspices of Prince Henry the Navigator. It contains some account of the life work of that prince, and has a biographical as well as a geographical interest. On the 6th of June 1454 Azurara

became chief keeper of the archives and royal chronicler in succession to Fernão Lopes. In 1456 King Alphonso V. commissioned him to write the history of Ceuta, "the land-gate of the East," under the governorship of D. Pedro de Menezes, from its capture in 1415 until 1437, and he had it ready in 1463. A year afterwards the king charged him with a history of the deeds of D. Duarte de Menezes, captain of Alcaccer, and, proceeding to Africa, he spent a twelvemonth in the town collecting materials and studying the scenes of the events he was to describe, and in 1468 he completed the chronicle. Alphonso corresponded with Azurara on terms of affectionate intimacy, and no less than three *comendas* of the order of Christ rewarded his literary services. He has little of the picturesque ingenueness of Lopes, and loved to display his erudition by quotations and philosophical reflections, showing that he wrote under the influence of the first Renaissance. Nearly all the leading classical, early Christian and medieval writers figure in his pages, and he was acquainted with the notable chronicles and romances of Europe and had studied the best Italian and Spanish authors. In addition, he had mastered the geographical system of the ancients and their astrology. As an historian he is laborious, accurate and conscientious, though his position did not allow him to tell the whole truth about his hero, Prince Henry.

His works include: (1) *Chronica del Rei D. Joam I. Terceira parte em que se tem a tomada de Ceuta* (Lisbon, 1644); (2) *Chronica do Descobrimto e Conquista de Guiné* (Paris, 1841; Eng. version in 2 vols. issued by the Hakluyt Society, London, 1896-1899); (3) *Chronica do Conde D. Pedro (de Menezes)*, printed in the *Inéditos de Historia Portuguesa*, vol. ii. (Lisbon, 1792); (4) *Chronica do Conde D. Duarte de Menezes*, printed in the *Inéditos*, vol. iii. (Lisbon, 1793). The preface to the English version of the *Chronicle of Guinea* contains a full account of the life and writings of Azurara and cites all the authorities. (E. Pr.)

AZURE (derived, through the Romance languages, from the Arabic *al-lawzard*, for the precious stone *lapis lazuli*, the initial *l* having dropped), the lapis lazuli; and so its colour, blue.

AZURITE, or **CHESSYLITE**, a mineral which is a basic copper carbonate, $2\text{CuCO}_3 \cdot \text{Cu}(\text{OH})_2$. In its vivid blue colour it contrasts strikingly with the emerald-green malachite, also a basic copper carbonate, but containing rather more water and less carbon dioxide. It was known to Pliny under the name *caeruleum*, and the modern name azurite (given by F. S. Beudant in 1824) also has reference to the azure-blue colour; the name chesylite, also in common use, is of later date (1852), and is from the locality,

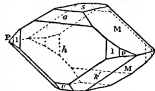

Chesny near Lyons, which has supplied the best crystallized specimens of the mineral. Crystals of azurite belong to the monoclinic system; they have a vitreous lustre and are translucent. The streak is blue, but lighter than the colour of the mineral in mass. Hardness $3\frac{1}{2}$ -4; sp. gr. 3.8.

Azurite occurs with malachite in the upper portions of deposits of copper ore, and owes its origin to the alteration of the sulphide or of native copper by water containing carbon dioxide and oxygen. It is thus a common mineral in all copper mines, and sometimes occurs in large masses, as in Arizona and in South Australia, where it has been worked as an ore of copper, of which element it contains 55%. Being less hydrated than malachite it is itself liable to alteration into this mineral, and pseudomorphs of malachite after azurite are not uncommon. Occasionally the massive material is cut and polished for decorative purposes, though the application in this direction is far less extensive than that of malachite. (L. J. S.)

AZYMITES (Gr. $\acute{\alpha}$ -, without; $\zeta\acute{\upsilon}\mu\eta$, leaven), a name given by the Orthodox Eastern to the Western or Latin Church, because of the latter's use of unleavened bread in the Eucharist, a practice which arose in the 9th century and is also observed by Armenians and Maronites following the Jewish passover custom. The Orthodox Church strenuously maintains its point, arguing that the very name bread, the holiness of the mystery, and the example of Jesus and the early church alike, testify against the use of unleavened bread in this connexion.

B This letter corresponds to the second symbol in the Phoenician alphabet, and appears in the same position in all the European alphabets, except those derived, like the Russian, from medieval Greek, in which the pronunciation of this symbol had changed from *b* to *v*. A new form had therefore to be invented for the genuine *b* in Slavonic, to which there was, at the period when the alphabet was adopted, no corresponding sound in Greek. The new symbol, which occupies the second position, was made by removing the upper loop of *B*, thus producing a symbol somewhat resembling an ordinary lowercase *b*. The old *B* retained the numerical value of the Greek β as 2, and no numerical value was given to the new symbol. In the Phoenician alphabet the earliest forms are β or more rounded β . The rounded form appears also in the earliest Aramaic (see ALPHABET). Like some other alphabetic symbols it was not borrowed by Greek in its original form. In the very early rock inscriptions of Thera (700-600 B.C.), written from right to left; it appears in a form resembling the ordinary Greek λ ; this form apparently arose from writing the Semitic symbol upside down. Its form in inscriptions of Melos, Selinus, Syracuse and elsewhere in the 6th and 5th centuries suggests the influence of Aramaic forms in which the head of the letter is opened, β . The Corinthian β , β and β (also at Corcyra) and the β of Byzantine coins are other adaptations of the same symbol. The form β which it takes in the alphabets of Naxos, Delos and other Ionic islands at the same period is difficult to explain. Otherwise its only variation is between pointed and rounded loops (β and β). The sound which the symbol represents is the voiced stop made by closing the lips and vibrating the vocal chords (see PHONETICS). It differs from β by the presence of vibration of the vocal chords and from m because the nasal passage as well as the lips is closed. When an audible emission of breath attends its production the aspirate *bh* is formed. This sound was frequent in the pre-ethnic period of the Indo-European languages and survived into the Indo-Aryan languages. According to the system of phonetic changes generally known as "Grimm's law," an original *b* appears in English as β , an original *bh* as *b*. An original medial β preceding the chief accent of the word also appears as *b* in English and the other members of the same group. It is not certain that any English word is descended from an original word beginning with *b*, though it has been suggested that *peg* is of the same origin as the Latin *vaculum* and the Greek $\beta\alpha\kappa\tau\omicron\nu\nu$. When the lips are not tightly closed the sound produced is not a stop, but a spirant like the English *w*. In Late Latin there was a tendency to this spirant pronunciation which appears as early as the beginning of the 2nd century A.D.; by the 3rd century *b* and consonantal *u* are inextricably confused. When this consonantal *u* (English *w* as seen in words borrowed very early from Latin like *wall* and *wine*) passed into the sound of English *v* (labio-dental) is not certain, but Germanic words borrowed into Latin in the 5th century A.D. have in their Latin representation *gu-* for Germanic *w-*, *guis*a corresponding to English *wise* and reborrowed indirectly as *guise*. The earliest form of the name of the symbol which we can reach is the Hebrew *bet*, to which the Phoenician must have been closely akin, as is shown by the Greek $\beta\eta\tau\alpha$, which is borrowed from it with a vowel affixed. (P. G.)

BAADER, FRANZ XAVER VON (1765-1841), German philosopher and theologian, born on the 27th of March 1765 at Munich, was the third son of F. P. Baader, court physician to the elector of Bavaria. His brothers were both distinguished—the elder, Clemens, as an author; the second, Joseph (1763-1835), as an engineer. Franz studied medicine at Ingolstadt and Vienna, and for a short time assisted his father in his practice. This life he soon found uncongenial, and decided on becoming a mining engineer. He studied under Abraham Gottlob Werner at Freiberg, travelled through several of the mining districts in north Germany, and for four years, 1792-1796, resided in

England. There he became acquainted with the works of Jakob Boehme, and with the ideas of Hume, Hartley and Godwin, which were extremely distasteful to him. The mystical speculations of Meister Eckhart, Saint Martin, and above all those of Boehme, were more in harmony with his mode of thought. In 1796 he returned from England, and in Hamburg became acquainted with F. H. Jacobi, with whom he was for years on terms of friendship. He now learned something of Schelling, and the works he published during this period were manifestly influenced by that philosopher. Yet Baader is no disciple of Schelling, and probably gave out more than he received. Their friendship continued till about the year 1822, when Baader's denunciation of modern philosophy in his letter to the emperor Alexander I. of Russia entirely alienated Schelling.

All this time Baader continued to apply himself to his profession of engineer. He gained a prize of 12,000 guineas (about £1000) for his new method of employing Glauber's salts instead of potash in the making of glass. From 1817 to 1820 he held the post of superintendent of mines, and was raised to the rank of nobility for his services. He retired in 1820, and soon after published one of the best of his works, *Fermenta Cognitiois*, 6 parts, 1822-1825, in which he combats modern philosophy and recommends the study of Boehme. In 1826, when the new university was opened at Munich, he was appointed professor of philosophy and speculative theology. Some of the lectures delivered there he published under the title, *Spekulative Dogmatik*, 4 parts, 1827-1836. In 1838 he opposed the interference in civil matters of the Roman Catholic Church, to which he belonged, and in consequence was, during the last three years of his life, interdicted from lecturing on the philosophy of religion. He died on the 23rd of May 1841.

It is difficult to summarize Baader's philosophy, for he himself generally gave expression to his deepest thoughts in obscure aphorisms and mystical symbols and analogies (see Edl. Zeller's *Ges. d. deut. Phil.* 732, 736). Further, he has no systematic works; his doctrines exist for the most part in short detached essays, in comments on the writings of Boehme and Saint Martin, or in his extensive correspondence and journals. At the same time there are salient points which mark the outline of his thought. Baader starts from the position that human reason by itself can never reach the end it aims at, and maintains that we cannot throw aside the presuppositions of faith, church and tradition. His point of view may be described as Scholasticism; for, like the scholastic doctors, he believes that theology and philosophy are not opposed sciences, but that reason has to make clear the truths given by authority and revelation. But in his attempt to draw still closer the realms of faith and knowledge he approaches more nearly to the mysticism of Eckhart, Paracelsus and Boehme. Our existence depends on the fact that we are cognized by God (*cogitor ergo cogito et sum*). All self-consciousness is at the same time God-consciousness; our knowledge is never mere *scientia*, it is invariably *con-scientia*—a knowing with, consciousness of, or participation in *God*. Baader's philosophy is thus essentially a theosophy. God is not to be conceived as mere abstract Being (*substantia*), but as everlasting process, activity (*actus*). Of this process, this self-generation of God, we may distinguish two aspects—the immanent or esoteric, and the emanent or exoteric. God has reality only in so far as He is absolute spirit, and only in so far as the primitive will is conscious of itself can it become spirit at all. But in this very cognition of self is involved the distinction of knower and known, from which proceeds the power to become spirit. This immanent process of self-consciousness, wherein indeed a trinity of persons is not given, but only rendered possible, is mirrored in, and takes place through, the eternal and impersonal idea or wisdom of God, which exists beside, though not distinct from, the primitive will. Concrete reality or personality is given to this divine *Ternar*, as Baader calls it, through *nature*, the principle of self-hood, of individual being, which is eternally and necessarily produced by God. Only in nature is the trinity of persons attained. These processes, it must be noticed, are not to be conceived as successive, or as taking place in time; they are to be looked at *sub specie eternitatis*, as the necessary elements or moments in the self-evolution of the divine Being. *Nature* is *natura* to be confounded with created substance, or with matter as it exists in space and time; it is pure non-being, the mere otherness (*alteritas*) of God—his shadow, desire, want, or *desiderium sui*, as it is called by mystical writers. Creation, itself a free and non-temporal act of God's love and will, cannot be speculatively deduced, but must be accepted as an historic

fact. Created beings were originally of three orders—the intelligent or angels; the non-intelligent natural existences; and man, who mediated between these two orders. Intelligent beings are endowed with freedom; it is possible, but not necessary, that they should fall. Hence the fact of the fall is not a speculative but an historic truth. The angels fell through pride—through desire to raise themselves to equality with God; man fell by lowering himself to the level of nature. Only after the fall of man begins the creation of space, time and matter, or of the world as we now know it; and the motive of this creation was the desire to afford man an opportunity for taking advantage of the scheme of redemption, for bringing forth in purity the image of God according to which he has been fashioned. The physical philosophy and anthropology which Baader, in connexion with this, unfolds in various works, is but little instructive, and coincides in the main with the utterances of Boehme. In nature and in man he finds traces of the dire effects of sin, which has corrupted both and has destroyed their natural harmony. As regards ethics, Baader rejects the Kantian or any autonomic system of morals. "Not obedience to a moral law, but realization in ourselves of the divine life is the true ethical end. But man has lost the power to effect this by himself; he has alienated himself from God, and therefore no ethical theory which neglects the facts of sin and redemption is satisfactory or even possible. The history of man and of humanity is the history of the redeeming love of God. The means whereby we put ourselves so in relation with Christ as to receive from Him his healing virtue are chiefly prayer and the sacraments of the church; his works are never sufficient. Man in his social relations is under two general institutions. One is temporal, natural and limited—the state; the other is eternal, cosmopolitan and universal—the church. In the state two things are requisite: first, common submission to the ruler, which can be secured or given only when the state is Christian, for God alone is the true ruler of men; and, secondly, inequality of rank, without which there can be no organization. A despotism of mere power and liberalism, which naturally produces socialism, are equally objectionable. The ideal state is a civil community ruled by a universal or Catholic church, the principles of which are equally distinct from mere passive pietism or faith which will know nothing, and from the Protestant doctrine, which is the very radicalism of reason.

Baader is, without doubt, among the greatest speculative theologians of modern Catholicism, and his influence has extended itself even beyond the precincts of his own church. Among those whom he influenced were R. Rothe, Julius Müller and Hans L. Markensen.

His works were collected and published by a number of his adherents—F. Hoffman, J. Hamberger, E. v. Schaden, Lutterbeck, von Gumboldt, and G. Ziegler's *Sammlung seiner sämtlichen Werke* (16 vols., 1851–1860). Valuable introductions by the editors are prefixed to the several volumes. Vol. xv. contains a full biography; vol. xvi. an index, and an able sketch of the whole system by Lutterbeck. See F. Hoffmann, *Vorhalle zur spekultativen Lehre Baaders's* (1836); *Grundsätze der Societäts-Philosophie Franz Baaders's* (1837); *Philosophische Schriften* (3 vols., 1868–1872); *Die Weltalter* (1868); *Biographie und Briefwechsel* (Leipzig, 1887); J. Hamberger, *Cardinalpunkte der Baaderschen Philosophie* (1855); *Fundamentalbegriff von F. B.'s Ethik, Politik, u. Religions-Philosophie* (1858); J. A. B. Lutterbeck, *Philosophische Standpunkte Baaders* (1854); *Baaders Lehre vom Weltgebäude* (1866). The most satisfactory surveys are those given by Erdmann, *Ver such einer Gesch. d. neuern Phil.* iii. 2, pp. 583–636; J. Claassen, *Franz von Baaders Leben und theologische Werke* (Stuttgart, 1886–1887), and Franz von Baaders *Gedanken über Staat und Gesellschaft* (Gütersloh, 1890); Otto Pfleiderer, *Philosophy of Religion* (vol. ii., Eng. trans. 1887); R. Falckenberg, *History of Philosophy*, pp. 472–475 (trans. A. C. Armstrong, New York, 1893); Reichel, *Die Societäts-Philosophie Franz v. Baaders* (Tübingen, 1901); Kuno Fischer, *Zur hundertjährigen Gedenkfeier Baaders* (Erlangen, 1865).

BAAL, a Semitic word, which primarily signifies lord, owner or inhabitant,¹ and then, in accordance with the Semitic way of looking at family and religious relations, is specially appropriated to express the relation of a husband to his wife and of the deity to his worshipper. In the latter usage it indicated not that the god was the lord of the worshipper, but rather the possessor of, or ruler in, some place or district. In the Old Testament it is regularly written with the article, i.e. "the Baal"; and the baals of different tribes or sanctuaries were not necessarily conceived as identical, so that we find frequent mention of Baalim, or rather "the Baalim" in the plural. That the Israelites even applied the title of Baal to Yahweh himself is proved by the occurrence of such names as Jerubbaal (Gideon), Eshbaal (one of Saul's sons) and Beeliada (a son of David, 1 Chron. xiv. 7). The last name appears in 2 Sam. v. 16 as Eliada, showing that El

(God) was regarded as equivalent to Baal; cf. also the name Be'alah, "Yahweh is baal or lord," which survives in 1 Chron. xii. 5. However, when the name Baal was exclusively appropriated to idolatrous worship (cf. Hos. ii. 16 seq.), abhorrence for the unholy word was marked by writing *bôsheth* (shameful thing) for *baal* in compound proper names, and thus we get the usual forms Ishbosheth, Mephibosheth.

The great difficulty which was felt by investigators in determining the character and attributes of the god Baal mainly arises from the original appellative sense of the word, and many obscure points become clear if we remember that when a title becomes a proper name it may be appropriated by different peoples to quite distinct deities. Baal being originally a title, and not a proper name, the innumerable baals could be distinguished by the addition of the name of a place or of some special attribute.² Accordingly, the baals are not to be regarded necessarily as local variations of one and the same god, like the many Virgins or Madonnas of Catholic lands, but as distinct *numina*. Each community could speak of its own baal, although a collection of allied communities might share the same cult, and naturally, since the attributes ascribed to the individual baals were very similar, subsequent syncretism was facilitated.

The Baal, as the head of each worshipping group, is the source of all the gifts of nature (cf. Hos. ii. 8 seq., Ezek. xvi. 10); as the god of fertility all the produce of the soil is his, and his adherents bring to him their tribute of first-fruits. He is the patron of all growth and fertility, and, by the "uncontrolled use of analogy characteristic of early thought," the Baal is the god of the productive element in its widest sense. Originating probably, in the observation of the fertilizing effect of rains and streams upon the receptive and reproductive soil, baalism becomes identical with the grossest nature-worship. Joined with the baals there are naturally found corresponding female figures known as Ashtārōth, embodiments of Ashtōreth (see ASTARTE; ISHTAR). In accordance with primitive notions of analogy,³ which assume that it is possible to control or aid the powers of nature by the practice of "sympathetic magic" (see MAGIC), the cult of the baals and Ashtārōth was characterized by gross sensuality and licentiousness. The fragmentary allusions to the cult of Baal Peor (Num. xxv., Hos. ix. 10, Ps. cvl. 28 seq.) exemplify the typical species of Dionysiac orgies that prevailed.⁴ On the summits of hills and mountains flourished the cult of the givers of increase, and "under every green tree" was practised the licentiousness which in primitive thought was held to secure abundance of crops (see Frazer, *Golden Bough*, 2nd ed. vol. ii. pp. 204 sqq.). Human sacrifice (Jer. xix. 5), the burning of incense (Jer. vii. 9), violent and ecstatic exercises, ceremonial acts of bowing and kissing, the preparing of sacred mystic cakes, appear among the offences denounced by the Israelite prophets, and show that the cult of Baal (and Astarte) included the characteristic features of heathen worship which recur in various parts of the Semitic world, although attached to other names.⁵

By an easy transition the local gods of the streams and springs which fertilized the increase of the fields became identified with

¹ Compounds with geographical terms (towns, mountains), e.g. Baal of Tyre, of Lebanon, &c., are frequent; see G. B. Gray, *Heb. Proper Names*, pp. 124–126. Baal-berith or El-berith of Shechem (Judg. ix. 4, 46) is usually interpreted to be the Baal or God of the covenant, but whether of covenants in general or of a particular covenant concluded at Shechem is disputed. The *Ba'alonos* (near Beirut) apparently presided over dancing; another compound (in Cyprus) seems to represent a Baal of healing. On the "Baal of flies" see BEELZEBUB.

² The general analogy shows itself further in the idea of the deity as the husband (*ba'al*) of his worshippers or of the land in which they dwell. The Astarte of Gabal (Byblus) was regularly known as the *ba'alah* (fem. of *baal*), her real name not being pronounced (perhaps out of reverence).

³ See further Clermont-Ganneau, *Pal. Explor. Fund. Quart. Stat.*, 1901, pp. 239, 369 sqq.; Büchler, *Rev. d'études juives*, 1901, pp. 125 sqq.

⁴ The extent to which elements of heathen cult entered into purer types of religion is illustrated in the worship of Yahweh. The sacred cakes of Astarte and old holy wells associated with her cult were later even transferred to the worship of the Virgin (*Encyc. Bib.* col. 3993; Rouvier, in *Bull. Archéol.*, 1900, p. 170).

¹ Cf. its usage as a noun of relation, e.g. a *ba'al* of hair, "a hairy man" (2 Kings i. 8), *b.* of wings, "a winged creature," and in the plural, *b.* of arrows, "archers" (Gen. xlix. 23), *b.* of oath, "conspirators" (Neh. vi. 18).

the common source of all streams, and proceeding along this line it was possible for the numerous baals to be regarded eventually as mere forms of one absolute deity. Consequently, the Baal could be identified with some supreme power of nature, e.g. the heavens, the sun, the weather or some planet. The particular line of development would vary in different places, but the change from an association of the Baal with earthly objects to heavenly is characteristic of a higher type of belief and appears to be relatively later. The idea which has long prevailed that Baal was properly a sky-god affords no explanation of the local character of the many baals; on the other hand, on the theory of a higher development where the gods become heavenly or astral beings, the fact that ruder conceptions of nature were still retained (often in the unofficial but more popular forms of cult) is more intelligible.

A specific Baal of the heavens appears to have been known among the Hittites in the time of Rameses II., and considerably later, at the beginning of the 7th century, it was the title of one of the gods of Phoenicia. In Babylonia, from a very early period, Baal became a definite individual deity, and was identified with the planet Jupiter. This development is a mark of superior culture and may have been spread through Babylonian influence. Both Baal and Astarte were venerated in Egypt at Thebes and Memphis in the XIXth Dynasty, and the former, through the influence of the Aramaeans who borrowed the Babylonian spelling Bel, ultimately became known as the Greek Bēlos who was identified with Zeus.

Of the worship of the Tyrian Baal, who is also called Melkart (king of the city), and is often identified with the Greek Heracles, but sometimes with the Olympian Zeus, we have many accounts in ancient writers, from Herodotus downwards. He had a magnificent temple in insular Tyre, founded by Hiram, to which gifts streamed from all countries, especially at the great feasts. The solar character of this deity appears especially in the annual feast of his awakening shortly after the winter solstice (Joseph. c. *Apon.* i. 18). At Tyre, as among the Hebrews, Baal had his symbolical pillars, one of gold and one of smaragdus, which, transported by phantasy to the farthest west, are still familiar to us as the Pillars of Hercules. The worship of the Tyrian Baal was carried to all the Phoenician colonies.¹ His name occurs as an element in Carthaginian proper names (Hannibal, Hasdrubal, &c.), and a tablet found at Marseilles still survives to inform us of the charges made by the priests of the temple of Baal for offering sacrifices.

The history of Baalism among the Hebrews is obscured by the difficulty of determining whether the false worship which the prophets stigmatize is the heathen worship of Yahweh under a conception, and often with rites, which treated him as a local nature god; or whether Baalism was consciously recognized to be distinct from Yahwism from the first. Later religious practice was undoubtedly opposed to that of earlier times, and attempts were made to correct narratives containing views which had come to be regarded as contrary to the true worship of Yahweh. The Old Testament depicts the history of the people as a series of acts of apostasy alternating with subsequent penitence and return to Yahweh, and the question whether this gives effect to actual conditions depends upon the precise character of the elements of Yahweh worship brought by the Israelites into Palestine. This is still under dispute. There is strong evidence at all events that many of the conceptions are contrary to historical fact, and the points of similarity between native Canaanite cult and Israelite worship are so striking that only the persistent traditions of Israel's origin and of the work of Moses compel the conclusion that the germs of specific Yahweh worship existed from his day. The earliest certain reaction against Baalism is ascribed to the reign of Ahab, whose marriage with Jezebel gave the impulse to the introduction of a particular form of the cult. In honour of his wife's god, the king, following the example of Solomon, erected a temple to the Tyrian Baal (see above). This, however, did not prevent him from remaining a follower of Yahweh, whose prophets he still consulted, and

¹ The sanctuary of Heracles at Daphne near Antioch was properly that of the Semitic Baal, and at Amathus Jupiter Hospes takes the place of Heracles or Malika, in which the Tyrian Melkart is to be recognized (W. R. Smith, *Rel. Sem.* 2nd ed. pp. 178, 376). See further PHOENICIA.

whose protection he still cherished when he named his sons Ahaziah and Jehoram ("Yah[weh] holds," "Y. is high"). The antagonism of Elijah was not against Baalism in general, but against the introduction of a rival deity. But by the time of Hosea (ii. 16 seq.) a further advance was marked, and the use of the term "Baal" was felt to be dangerous to true religion. Thus there gradually grew up a tendency to avoid the term, and in accordance with the idea of Ex. xxiii. 13, it was replaced by the contemptuous *bāsheth*, "shame" (see above). However, the books of Deuteronomy and Jeremiah (cf. also Zeph. i. 4) afford complete testimony for the prevalence of Baalism as late as the exile, but prove that the clearest distinction was then drawn between the pure worship of Yahweh the god of Israel and the inveterate and debased cults of the gods of the land. (See further HEBREW RELIGION; PROPHET.)

BIBLIOGRAPHY.—W. Robertson Smith, *Relig. Semites*, 2nd ed. pp. 93-113 (against his theory of the introduction of Baal among the Arabs see M. J. Lagrange, *Études d. relig. sem.* pp. 83-98). For the reading "Baal" in the Amarna tablets (Palestine, about 1400 B.C.) see Knudtzon, *Beitr. z. Assyriol.* (1901), pp. 320 seq., 415; other cuneiform evidence in E. Schrader's *Keilsch. u. Alte Test.* 3rd ed. p. 357 (by H. Zimmern; see also his *Index*, sub voce). In *Baal-Shamem* (B. of the heavens) M. Lidzbarski's monograph (*Zaberner*, i. 243-260, ii. 120) is invaluable, and this work, with his *Handbuch d. nordsem. Epigraphik*, contains full account of the epigraphical material. See Baethgen, *Beitr. z. semit. Religionsgesch.* pp. 17-32; also the articles on Baal by E. Meyer in Roscher's *Lexikon*, and G. F. Moore in *Ency. Bib.* (On *Beltane* fires and other apparent points of connexion with Baal it may suffice to refer to Aug. Fick, *Vergleich. Wörterbuch*, who derives the element *bel* from an old Celtic root meaning shining, &c.) (W. R. S.; S. A. C.)

BAALBEK (anc. *Heliopolis*), a town of the Buka'a (Coesyria), altitude 3850 ft., situated E. of the Litani and near the parting between its waters and those of the Asi. Pop. about 5000, including 2000 Metawali and 1000 Christians (Maronite and Orthodox). Since 1902 Baalbek has been connected by railway with Rayak (Rejak) on the Beirut-Damascus line, and since 1907 with Aleppo. It is famous for its temple ruins of the Roman period, before which we have no record of it, certain though it be that Heliopolis is a translation of an earlier native name, in which Baal was an element. It has been suggested, but without good reason, that this name was the Baalgad of Josh. xi. 17.

Heliopolis was made a *colonia* probably by Octavian (coins of 1st century A.D.), and there must have been a Baal temple there in which Trajan consulted the oracle. The foundation of the present buildings, however, dates from Antoninus Pius, and their dedication from Septimius Severus, whose coins first show the two temples. The great courts of approach were not finished before the reigns of Caracalla and Philip. In commemoration, no doubt, of the dedication of the new sanctuaries, Severus conferred the *jus Italicum* on the city. The greater of the two temples was sacred to Jupiter (Baal), identified with the Sun, with whom were associated Venus and Mercury as *σὺνθεσμία θεοὶ*. The lesser temple was built in honour of Bacchus (not the Sun, as formerly believed). Jupiter-Baal was represented locally as a beardless god in long scaly drapery, holding a whip in his right hand and lightning and ears of corn in his left. Two bulls supported him. In this guise he passed into European worship in the 3rd and 4th centuries A.D. The extreme licence of the Heliopolitan worship is often animadverted upon by early Christian writers, and Constantine, making an effort to curb the Venus cult, built a basilica. Theodosius erected another, with western apse, in the main court of the Jupiter temple.

When Abu Ubaida (or Obaida) attacked the place after the Moslem capture of Damascus (A.D. 635), it was still an opulent city and yielded a rich booty. It became a bone of contention between the various Syrian dynasties and the caliphs first of Damascus, then of Egypt, and in 748 was sacked with great slaughter. In 1090 it passed to the Seljuks, and in 1134 to Jenghiz Khan; but after 1145 it remained attached to Damascus and was captured by Saladin in 1175. The Crusaders raided its valley more than once, but never took the city. Three times shaken by earthquake in the 12th century, it was dismantled by Hulagu in 1260. But it revived, and most of its fine Moslem mosque and fortress architecture, still extant, belongs to the

reign of Sultan Kalaün (1282) and the succeeding century, during which Abulfeda describes it as a very strong place. In 1400 Timur pillaged it, and in 1517 it passed, with the rest of Syria, to the Ottoman dominion. But Ottoman jurisdiction was merely nominal in the Lebanon district, and Baalbek was really in the hands of the Metawali (see **LEBANON**), who retained it against other Lebanon tribes, until "Jezzar" Pasha, the rebel governor of the Acre province, broke their power in the last half of the 18th century. The anarchy which succeeded his death in 1804 was only ended by the Egyptian occupation (1832). With the treaty of London (1840) Baalbek became really Ottoman, and since the settlement of the Lebanon (1864) has attracted great numbers of tourists.

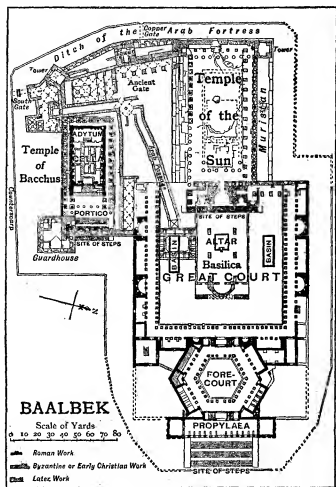

After Puchstein, with permission of Georg Reimer

Emery Walker sc.

The ruins were brought to European notice by Pierre Belon in 1555, though previously visited, in 1507, by Martin von Baumgarten. Much damaged by the earthquake of 1759, they remained a wilderness of fallen blocks till 1901, when their clearance was undertaken by the German Archaeological Institute and entrusted to the direction of Prof. O. Puchstein. They lie mainly on the ancient Acropolis, which has been shored up with huge walls to form a terrace raised on vaults and measuring about 1100 ft. from E. to W. The *Propylaea* lie at the E. end, and were approached by a flight of steps now quarried away. These propylaea formed a covered hall, or vestibule, about 35 ft. deep, flanked by towers richly decorated within and without (much damaged by Arab reconstruction). Columns stood in front, whose bases still exist and bear the names of Antoninus Pius and Julia Domna. Hence, through a triple gateway in a richly ornamented screen, access is gained to the first or Hexagonal Court, which measures about 250 ft. from angle to angle. It is now razed almost to foundation level; but it can be seen that it was flanked with halls each having four columns in front. A

portal on the W., 50 ft. wide, flanked by lesser ones 10 ft. wide (that on the N. is alone preserved), admitted to the Main Court, in whose centre was the High Altar of Burnt Sacrifice. This altar and a great tank on the N. were covered by the foundations of Theodosius' basilica and not seen till the recent German clearance. The Main Court measures about 440 ft. from E. to W. and 370 ft. from N. to S., thus covering about 3½ acres. It had a continuous fringe of covered halls of various dimensions and shapes, once richly adorned with statues and columnar screens. Some of these halls are in fair preservation. Stairs on the W. led up to the temple of Jupiter-Baal, now much ruined, having only 6 of the 54 columns of its peristyle erect. Three fell in the earthquake of 1759. Those still standing are Nos. 11 to 16 in the southern rank. Their bases and shafts are not finished, though the capitals and rich entablature seem completely worked. They have a height of 60 ft. and diameter of 7½ ft., and are mostly formed of three blocks. The architrave is threefold and bears a frieze with lion-heads, on which rest a moulding and cornice.

The temple of Bacchus stood on a platform of its own formed by a southern projection of the Acropolis. It was much smaller than the Jupiter temple, but is better preserved. The steps of the E. approach were intact up to 1688. The temple was peripteral with 46 columns in its peristyle. These were over 52 ft. in height and of the Corinthian order, and supported an entablature 7 ft. high with double frieze, connected with the cella walls by a coffered ceiling, which contained slabs with heads of gods and emperors. Richard Burton, when consul-general at Damascus in 1870, cleared an Arab screen out of the vestibule, and in consequence the exquisite doorway leading into the cella can now be well seen. On either side of its staircases constructed within columns lead to the roof. The cracked door-lintel, which shows an eagle on the soffit, was propped up first by Burton, and lately, more securely, by the Germans. The cella, now ruinous, had inner wall-reliefs and engaged columns, which supported rich entablatures.

The vaults below the Great Court of the Jupiter Temple, together with the supporting walls of the terrace, are noticeable. In the W. wall of the latter occur the three famous megaliths, which gave the name *Trilithion* to the Jupiter temple in Byzantine times. These measure from 63 to 64 ft. in length and 13 ft. in height and breadth, and have been raised 20 ft. above the ground. They are the largest blocks known to have been used in actual construction, but are excelled by another block still attached to its bed in the quarries half a mile S.W. This is 68 ft. long by 14 ft. high and weighs about 1500 tons. For long these blocks were supposed, even by European visitors, to be relics of a primeval race of giant builders.

In the town, below the Acropolis, on the S.E. is a small temple of the late imperial age, consisting of a semicircular cella with a peristyle of eight Corinthian columns, supporting a projecting entablature. The cella is decorated without with a frieze, and within with pillars and arcading. This temple owes its preservation to its use as a church of St Barbara, a local martyr, also claimed by the Egyptian Heliopolis. Hence the building is known as *Barbarat-al-atika*. Considerable remains of the N. gate of the city have also been exposed.

BIBLIOGRAPHY.—These vast ruins, more imposing from their immensity than pleasing in detail, have been described by scores of travellers and tourists; but it will be sufficient here to refer to the following works:—(First discoverer) M. von Baumgarten, *Peregrinatio in . . . Syria* (1604); P. Belon, *De admirabili operum antiquorum praestantia* (1553); and *Observations*, &c. (1555). (Before earthquake of 1759) R. Wood, *Ruins of Baalbek* (1757). (Before excavation) H. Frauberger, *Die Akropolis von Baalbek* (1892). (After excavation) O. Puchstein, *Führer durch die Ruinen v. Baalbek* (1905), (with Th. v. Lüpcke) *Ansichten*, &c. (1905). See also R. Phené Spiers, *Quart. Stat. Pal. Exp. Fund.*, 1904, pp. 58-64, and the *Builder*, 11 Feb. 1905. (D. G. H.)

BAARN, a small town in the province of Utrecht, Holland, 5 m. by rail E. of Hilversum, at the junction of a branch line to Utrecht. Like Hilversum it is situated in the midst of picturesque and wooded surroundings, and is a favourite summer resort of people from Amsterdam. The Baarnsche Bosch, or wood, stretches southward to Soestdyk, where there is a royal country-

seat, originally acquired by the state in 1795. Louis Bonaparte, king of Holland, who was very fond of the spot, formed a zoological collection here which was removed to Amsterdam in 1809. In 1816 the estate was presented by the nation to the prince of Orange (afterwards King William II.) in recognition of his services at the battle of Quatre Bras. Since then the palace and grounds have been considerably enlarged and beautified. Close to Baarn in the south-west were formerly situated the ancient castles of Drakenburg and Drakenstein, and at Vuursche there is a remarkable dolmen.

BABADAG, or **BABATAJ**, a town in the department of Tulcea, Rumania; situated on a small lake formed by the river Taïtza among the densely wooded highlands of the northern Dobruđja. Pop. (1900) about 3500. The Taïtza lake is divided only by a strip of marshland from Lake Razim, a broad landlocked sheet of water which opens on the Black Sea. Babadag is a market for the wool and mutton of the Dobruđja. It was founded by Bayezid I., sultan of the Turks from 1389 to 1403. It occasionally served as the winter headquarters of the Turks in their wars with Russia, and was bombarded by the Russians in 1854.

BABBAGE, CHARLES (1792-1871), English mathematician and mechanic, was born on the 26th of December 1792 at Teignmouth in Devonshire. He was educated at a private school, and afterwards entered St Peter's College, Cambridge, where he graduated in 1814. Though he did not compete in the mathematical tripos, he acquired a great reputation at the university. In the years 1815-1817 he contributed three papers on the "Calculus of Functions" to the *Philosophical Transactions*, and in 1816 was made a fellow of the Royal Society. Along with Sir John Herschel and George Peacock he laboured to raise the standard of mathematical instruction in England, and especially endeavoured to supersede the Newtonian by the Leibnitzian notation in the infinitesimal calculus. Babbage's attention seems to have been very early drawn to the number and importance of the errors introduced into astronomical and other calculations through inaccuracies in the computation of tables. He contributed to the Royal Society some notices on the relation between notation and mechanism; and in 1822, in a letter to Sir H. Davy on the application of machinery to the calculation and printing of mathematical tables, he discussed the principles of a calculating engine, to the construction of which he devoted many years of his life. Government was induced to grant its aid, and the inventor himself spent a portion of his private fortune in the prosecution of his undertaking. He travelled through several of the countries of Europe, examining different systems of machinery; and some of the results of his investigations were published in the admirable little work, *Economy of Machines and Manufactures* (1834). The great calculating engine was never completed; the constructor apparently desired to adopt a new principle when the first specimen was nearly complete, to make it not a difference but an analytical engine, and the government declined to accept the further risk (see **CALCULATING MACHINES**). From 1828 to 1830 Babbage was Lucasian professor of mathematics at Cambridge. He contributed largely to several scientific periodicals, and was instrumental in founding the Astronomical (1820) and Statistical (1834) Societies. He only once endeavoured to enter public life, when, in 1832, he stood unsuccessfully for the borough of Finsbury. During the later years of his life he resided in London, devoting himself to the construction of machines capable of performing arithmetical and even algebraical calculations. He died at London on the 18th of October 1871. He gives a few biographical details in his *Passages from the Life of a Philosopher* (1864), a work which throws considerable light upon his somewhat peculiar character. His works, pamphlets and papers were very numerous; in the *Passages* he enumerates eighty separate writings. Of these the most important, besides the few already mentioned, are *Tables of Logarithms* (1826); *Comparative View of the Various Institutions for the Assurance of Lives* (1826); *Decline of Science in England* (1830); *Ninth Bridgewater Treatise* (1837); *The Exposition of 1851* (1851).

See *Monthly Notices, Royal Astronomical Society*, vol. 32.

BABEL, the native name of the city called Babylon (*q.v.*) by the Greeks, the modern *Hillah*. It means "gate of the god," not "gate of the gods," corresponding to the Assyrian *Bab-il*. According to Gen. xi. 1-9 (J), mankind, after the deluge, travelled from the mountain of the East, where the ark had rested, and settled in Shinar. Here they attempted to build a city and a tower whose top might reach unto heaven, but were miraculously prevented by their language being confounded. In this way the diversity of human speech and the dispersion of mankind were accounted for; and in Gen. xi. 9 (J) an etymology was found for the name of Babylon in the Hebrew verb *bālal*, "to confuse or confound," Babel being regarded as a contraction of Babel. In Gen. x. 10 it is said to have formed part of the kingdom of Nimrod.

The origin of the story has not been found in Babylonia. The tower was no doubt suggested by one of the temple towers of Babylon. W. A. Bernet (*Genesis*, p. 169; cf. *Hommel in Hastings' Dictionary of the Bible*) suggests E-Saggila, the great temple of Merodach (Marduk). The variety of languages and the dispersion of mankind were regarded as a curse, and it is probable that, as Prof. Cheyne (*Encyclopaedia Biblica*, col. 411) says, there was an ancient North Semitic myth to explain it. The event was afterwards localized in Babylon. The myth, as it appears in *Genesis*, is quite polytheistic and anthropomorphic. According to Cornelius Alexander (*frag. 10*) and Abydenus (*frags. 5 and 6*) the tower was overthrown by the winds; according to Yaqut (*i. 448 f.*) and the *Lisan el-'Arab* (xiii. 72) mankind were swept together by winds into the plain afterwards called "Babil," and were scattered again in the same way (see further D. B. Macdonald in the *Jewish Encyclopaedia*). A tradition similar to that of the tower of Babel is found in Central America. Xelhua, one of the seven giants rescued from the deluge, built the great pyramid of Cholula in order to storm heaven. The gods, however, destroyed it with fire and confounded the language of the builders. Traces of a somewhat similar story have also been met with among the Mongolian Tharus in northern India (*Report of the Census of Bengal, 1872*, p. 160), and, according to Dr Livingstone, among the Africans of Lake Ngami. The Estonian myth of "the Cooking of Languages" (Kohl, *Reisen in die Ostsee-provinzen*, ii. 251-255) may also be compared, as well as the Australian legend of the origin of the diversity of speech (Gerstäcker, *Reisen*, vol. iv. pp. 381 seq.).

BAB-EL-MANDEB (Arab. for "The Gate of Tears"), the strait between Arabia and Africa which connects the Red Sea (*q.v.*) with the Indian Ocean. It derives its name from the dangers attending its navigation, or, according to an Arabic legend, from the numbers who were drowned by the earthquake which separated Asia and Africa. The distance across is about 20 m. from Ras Menbel on the Arabian coast to Ras Siyan on the African. The island of Perim (*q.v.*), a British possession, divides the strait into two channels, of which the eastern, known as the Bab Iskender (Alexander's Strait), is 2 m. wide and 16 fathoms deep, while the western, or Dact-el-Mayun, has a width of about 16 m. and a depth of 170 fathoms. Near the African coast lies a group of smaller islands known as the "Seven Brothers." There is a surface current inwards in the eastern channel, but a strong under-current outwards in the western channel.

BABENBERG, the name of a Franconian family which held the duchy of Austria before the rise of the house of Habsburg. Its earliest known ancestor was one Poppo, who early in the 9th century was count in Graffeld. One of his sons, Henry, called margrave and duke in Franconia, fell fighting against the Normans in 886; another, Poppo, was margrave in Thuringia from 880 to 892, when he was deposed by the German king Arnulf. The family had been favoured by the emperor Charles the Fat, but Arnulf reversed this policy in favour of the rival family of the Conradines. The leaders of the Babenbergs were the three sons of Duke Henry, who called themselves after their castle of Babenberg on the upper Main, round which their possessions centred. The rivalry between the two families was intensified by their efforts to extend their authority in the region of the middle Main, and this quarrel, known as the "Babenberg feud," came to a head at the beginning of the 10th century during the

troubled reign of the German king, Louis the Child. Two of the Babenberg brothers were killed, and the survivor Adalbert was summoned before the imperial court by the regent Hatto I., archbishop of Mainz, a partisan of the Conradines. He refused to appear, held his own for a time in his castle at Theres against the king's forces, but surrendered in 906, and in spite of a promise of safe-conduct was beheaded. From this time the Babenbergs lost their influence in Franconia; but in 976 Leopold, a member of the family who was a count in the Donnegau, is described as margrave of the East Mark, a district not more than 60 m. in breadth on the eastern frontier of Bavaria which grew into the duchy of Austria. Leopold, who probably received the mark as a reward for his fidelity to the emperor Otto II. during the Bavarian rising in 976, extended its area at the expense of the Hungarians, and was succeeded in 994 by his son Henry I. Henry, who continued his father's policy, was followed in 1018 by his brother Adalbert and in 1055 by his nephew Ernest, whose marked loyalty to the emperors Henry III. and Henry IV. was rewarded by many tokens of favour. The succeeding margrave, Leopold II., quarrelled with Henry IV., who was unable to oust him from the mark or to prevent the succession of his son Leopold III. in 1096. Leopold supported Henry, son of Henry IV., in his rising against his father, but was soon drawn over to the emperor's side, and in 1106 married his daughter Agnes, widow of Frederick I., duke of Swabia. He declined the imperial crown in 1125. His zeal in founding monasteries earned for him his surname "the Pious," and canonization by Pope Innocent VIII. in 1485. He is regarded as the patron saint of Austria. One of Leopold's sons was Otto, bishop of Freising (*q.v.*). His eldest son, Leopold IV., became margrave in 1136, and in 1139 received from the German king Conrad III. the duchy of Bavaria, which had been forfeited by Duke Henry the Proud. Leopold's brother Henry (surnamed Jasomirgott from his favourite oath, "So help me God!") was made count palatine of the Rhine in 1140, and became margrave of Austria on Leopold's death in 1141. Having married Gertrude, the widow of Henry the Proud, he was invested in 1143 with the duchy of Bavaria, and resigned his office as count palatine. In 1147 he went on crusade, and after his return renounced Bavaria at the instance of the new king Frederick I. As compensation for this, Austria, the capital of which had been transferred to Vienna in 1146, was erected into a duchy. The second duke was Henry's son Leopold I., who succeeded him in 1177 and took part in the crusades of 1182 and 1190. In Palestine he quarrelled with Richard I., king of England, captured him on his homeward journey and handed him over to the emperor Henry VI. Leopold increased the territories of the Babenbergs by acquiring Styria in 1192 under the will of his kinsman Duke Ottakar IV. He died in 1194, and Austria fell to one son, Frederick, and Styria to another, Leopold; but on Frederick's death in 1198 they were again united by Duke Leopold II., surnamed "the Glorious." The new duke fought against the infidel in Spain, Egypt and Palestine, but is more celebrated as a lawgiver, a patron of letters and a founder of towns. Under him Vienna became the centre of culture in Germany and the great school of Minnesingers (*q.v.*). His later years were spent in strife with his son Frederick, and he died in 1230 at San Germano, whither he had gone to arrange the peace between the emperor Frederick II. and Pope Gregory IX. His son Frederick II. followed as duke, and earned the name of "Quarrelsome" by constant struggles with the kings of Hungary and Bohemia and with the emperor. He deprived his mother and sisters of their possessions, was hated by his subjects on account of his oppressions, and in 1236 was placed under the imperial ban and driven from Austria. Restored when the emperor was excommunicated, he treated in vain with Frederick for the erection of Austria into a kingdom. He was killed in battle in 1246, when the male line of the Babenbergs became extinct. The city of Bamberg grew up around the ancestral castle of the family.

See G. Juritsch, *Geschichte der Babenberger und ihrer Länder* (Innsbruck, 1894); M. Schmitz, *Oesterreichs Scheyern-Wittelsbacher oder die Dynastie der Babenberger* (Munich, 1880).

BABER, or **BABAR** (1483-1530), a famous conqueror of India and founder of the so-called Mogul dynasty. His name was Zahir ud-din-Mahomet, and he was given the surname of Baber, meaning the tiger. Born on the 14th of February 1483, he was a descendant of Timur, and his father, Omar Sheik, was king of Ferghana, a district of what is now Russian Turkestan. Omar died in 1495, and Baber, though only twelve years of age, succeeded to the throne. An attempt made by his uncles to dislodge him proved unsuccessful, and no sooner was the young sovereign firmly settled than he began to meditate an extension of his own dominions. In 1497 he attacked and gained possession of Samarkand, to which he always seems to have thought he had a natural and hereditary right. A rebellion among his nobles robbed him of his native kingdom, and while marching to recover it his troops deserted him, and he lost Samarkand also. After some reverses he regained both these places, but in 1501 his most formidable enemy, Shaibani (Sheibani) Khan, ruler of the Uzbeks, defeated him in a great engagement and drove him from Samarkand. For three years he wandered about trying in vain to recover his lost possessions; at last, in 1504, he gathered some troops, and crossing the snowy Hindu Kush besieged and captured the strong city of Kabul. By this dexterous stroke he gained a new and wealthy kingdom, and completely re-established his fortunes. In the following year he united with Hussain Mirza of Herat against Shaibani. The death of Hussain put a stop to this expedition, but Baber spent a year at Herat, enjoying the pleasures of that capital. He returned to Kabul in time to quell a formidable rebellion, but two years later a revolt among some of the leading Moguls drove him from his city. He was compelled to take to flight with very few companions, but his great personal courage and daring struck the army of his opponents with such dismay that they again returned to their allegiance and Baber regained his kingdom. Once again, in 1510, after the death of Shaibani, he endeavoured to obtain possession of his native country. He received considerable aid from Shah Ismael of Persia, and in 1511 made a triumphal entry into Samarkand. But in 1514 he was utterly defeated by the Uzbeks and with difficulty reached Kabul. He seems now to have resigned all hopes of recovering Ferghana, and as he at the same time dreaded an invasion of the Uzbeks from the west, his attention was more and more drawn towards India. Several preliminary incursions had been already made, when in 1521 an opportunity presented itself for a more extended expedition. Ibrahim, emperor of Delhi, had made himself detested, even by his Afghan nobles, several of whom called upon Baber for assistance. He at once assembled his forces, 12,000 strong, with some pieces of artillery and marched into India. Ibrahim, with 100,000 soldiers and numerous elephants, advanced against him. The great battle was fought at Panipat on the 21st of April 1526, when Ibrahim was slain and his army routed. Baber at once took possession of Agra. A still more formidable enemy awaited him; the Rana Sanga of Mewar collected the enormous force of 210,000 men, with which he moved against the invaders. On all sides there was danger and revolt, even Baber's own soldiers, worn out with the heat of this new climate, longed for Kabul. By vigorous measures and inspiring speeches he restored their courage, though his own heart was nearly failing him, and in his distress he abjured the use of wine, to which he had been addicted. At Kanwaha, on the 10th of March 1527, he won a great victory and made himself absolute master of northern India. The remaining years of his life he spent in arranging the affairs and revenues of his new empire and in improving his capital, Agra. He died on the 26th of December 1530 in his forty-eighth year. Baber was above the middle height, of great strength and an admirable archer and swordsman. His mind was as well cultivated as his bodily powers; he wrote well, and his observations are generally acute and accurate; he was brave, kindly and generous.

Full materials for his life are found in his *Memoirs*, written by himself (translated into English by Leyden and Erskine (London, 1826); abridged in Caldecott, *Life of Baber* (London, 1844). See also Lane-Poole, *Baber* (Rulers of India Series), 1899.

BABEUF, FRANÇOIS NOEL (1760-1797), known as GRACCHUS BABEUF, French political agitator and journalist, was born at Saint Quentin on the 23rd of November 1760. His father, Claude Babeuf, had deserted the French army in 1738 and taken service under Maria Theresa, rising, it is said, to the rank of major. Amnestied in 1755 he returned to France, but soon sank into dire poverty, being forced to earn a pittance for his wife and family as a day labourer. The hardships endured by Babeuf during early years do much to explain his later opinions. He had received from his father the smatterings of a liberal education, but until the outbreak of the Revolution he was a domestic servant, and from 1785 occupied the invidious office of *commissaire à terrier*, his function being to assist the nobles and priests in the assertion of their feudal rights as against the unfortunate peasants. On the eve of the Revolution Babeuf was in the employ of a land surveyor at Roze. His father had died in 1780, and he was now the sole support, not only of his wife and two children, but of his mother, brothers and sisters. In the circumstances it is not surprising that he was the life and soul of the malcontents of the place. He was an indefatigable writer, and the first germ of his future socialism is contained in a letter of the 21st of March 1787, one of a series—mainly on literature—addressed to the secretary of the Academy of Arras. In 1780 he drew up the first article of the *cahier* of the electors of the *bailliage* of Roze, demanding the abolition of feudal rights. Then, from July to October, he was in Paris superintending the publication of his first work: *Cadastre perpétuel, dédié à l'Assemblée nationale, l'an 1789 et le premier de la liberté française*, which was written in 1787 and issued in 1790. The same year he published a pamphlet against feudal aids and the *gabelle*, for which he was denounced and arrested, but provisionally released. In October, on his return to Roze, he founded the *Correspondant picard*, the violent character of which cost him another arrest. In November he was elected a member of the municipality of Roze, but was expelled. In March 1791 he was appointed commissioner to report on the national property (*biens nationaux*) in the town, and in September 1792 was elected a member of the council-general of the department of the Somme. Here, as everywhere, the violence of his attitude made his position intolerable to himself and others, and he was soon transferred to the post of administrator of the district of Montdidier. Here he was accused of fraud for having substituted one name for another in a deed of transfer of national lands. It is probable that his fault was one of negligence only; but, distrusting the impartiality of the judges of the Somme, he fled to Paris, and on the 23rd of August 1793 was condemned in *contumaciam* to twenty years' imprisonment. Meanwhile he had been appointed secretary to the relief committee (*comité des subsistances*) of the commune of Paris. The judges of Amiens, however, pursued him with a warrant for his arrest, which took place in Brumaire of the year II. (1794). The court of cassation quashed the sentence, through defect of form, but sent Babeuf for a new trial before the Aisne tribunal, by which he was acquitted on the 18th of July.

Babeuf now returned to Paris, and on the 3rd of September 1794 published the first number of his *Journal de la liberté de la presse*, the title of which was altered on the 5th of October to *Le Tribun du peuple*. The execution of Robespierre on the 28th of July had ended the Terror, and Babeuf—now self-styled "Gracchus"—Babeuf—defended the men of Thermidor and attacked the fallen terrorists with his usual violence. But he also attacked, from the point of view of his own socialistic theories, the economic outcome of the Revolution. This was an attitude which had few supporters, even in the Jacobin club, and in October Babeuf was arrested and sent to prison at Arras. Here he came under the influence of certain terrorist prisoners, notably of Lebois, editor of the *Journal de l'égalité*, afterwards of the *Ami du peuple*, papers which carried on the traditions of Marat. He emerged from prison a confirmed terrorist and convinced that his Utopia, fully proclaimed to the world in No. 33 of his *Tribun*, could only be realized through the restoration of the constitution of 1793. He was now in open conflict with the

whole trend of public opinion. In February 1795 he was again arrested, and the *Tribun du peuple* was solemnly burnt in the Théâtre des Bergères by the *jeunesse dorée*, the young men whose mission it was to bludgeon Jacobinism out of the streets and cafés. But for the appalling economic conditions produced by the fall in the value of *assignats*, Babeuf might have shared the fate of other agitators who were whipped into obscenity.

It was the attempts of the Directory to deal with this economic crisis that gave Babeuf his real historic importance. The new government was pledged to abolish the vicious system by which Paris was fed at the expense of all France, and the cessation of the distribution of bread and meat at nominal prices was fixed for the 20th of February 1796. The announcement caused the most wide-spread consternation. Not only the workmen and the large class of idlers attracted to Paris by the system, but *rentiers* and government officials, whose incomes were paid in *assignats* on a scale arbitrarily fixed by the government, saw themselves threatened with actual starvation. The government yielded to the outcry that arose; but the expedients by which it sought to mitigate the evil, notably the division of those entitled to relief into classes, only increased the alarm and the discontent. The universal misery gave point to the virulent attacks of Babeuf on the existing order, and at last gained him a hearing. He gathered round him a small circle of his immediate followers known as the *Société des Égaux*, soon merged with the rump of the Jacobins, who met at the Pantheon; and in November 1795 he was reported by the police to be openly preaching "insurrection, revolt and the constitution of 1793."

For a time the government, while keeping itself informed of his activities, left him alone; for it suited the Directory to let the socialist agitation continue, in order to frighten the people from joining in any royalist movement for the overthrow of the existing régime. Moreover the mass of the *ouvriers*, even of extreme views, were repelled by Babeuf's bloodthirstiness; and the police agents reported that his agitation was making many converts—for the government. The Jacobin club of the Faubourg Saint-Antoine refused to admit Babeuf and Lebois, on the ground that they were "*égorgeurs*." With the development of the economic crisis, however, Babeuf's influence increased. After the club of the Pantheon was closed by Bonaparte, on the 27th of February 1796, his aggressive activity redoubled. In Ventôse and Germinal he published, under the *nom de plume* of "Lalande, soldat de la patrie," a new paper, the *Éclaircur du peuple, ou le défenseur de vingt-cinq millions d'opprimés*, which was hawked clandestinely from group to group in the streets of Paris. At the same time No. 40 of the *Tribun* excited an immense sensation. In this he praised the authors of the September massacres as "deserving well of their country," and declared that a more complete "September 2nd" was needed to annihilate the actual government, which consisted of "starvers, blood-suckers, tyrants, hangmen, rogues and mountebanks." The distress among all classes continued to be appalling; and in March the attempt of the Directory to replace the *assignats* (g.r.) by a new issue of *mandats* created fresh dissatisfaction after the breakdown of the hopes first raised. A cry went up that national bankruptcy had been declared, and thousands of the lower class of *ouvrier* began to rally to Babeuf's flag. On the 4th of April it was reported to the government that 500,000 people in Paris were in need of relief. From the 11th Paris was placarded with posters headed *Analyse de la doctrine de Babeuf* (sic), *tribun du peuple*, of which the opening sentence ran: "Nature has given to every man the right to the enjoyment of an equal share in all property," and which ended with a call to restore the constitution of 1793. Babeuf's song *Mourant de faim, mourant de froid* (Dying of hunger, dying of cold), set to a popular air, began to be sung in the cafés, with immense applause; and reports were current that the disaffected troops in the camp of Grenelle were ready to join an *émeute* against the government. The Directory thought it time to act; the *bureau central* had accumulated through its agents, notably the ex-captain Georges

Grisel, who had been initiated into Babeuf's society, complete evidence of a conspiracy for an armed rising fixed for Floréal 22, year IV. (11th of May 1796), in which Jacobins and socialists were combined. On the 10th of May Babeuf was arrested with many of his associates, among whom were A. Darthé and P. M. Buonarroti, the ex-members of the Convention, Robert Lindet, J. A. B. Amar, M. G. A. Vadier and Jean Baptiste Drouet, famous as the postmaster of Saint-Menechould who had arrested Louis XVI., and now a member of the Council of Five Hundred.

The *coup* was perfectly successful. The last number of the *Tribun* appeared on the 24th of April, but Lebois in the *Ami du peuple* tried to incite the soldiers to revolt, and for a while there were rumours of a military rising. The trial of Babeuf and his accomplices was fixed to take place before the newly constituted high court of justice at Vendôme. On Fructidor 10 and 11 (27th and 28th of August), when the prisoners were removed from Paris, there were tentative efforts at a riot with a view to rescue, but these were easily suppressed. The attempt of five or six hundred Jacobins (7th of September) to rouse the soldiers at Grenelle met with no better success. The trial of Babeuf and the others, begun at Vendôme on the 20th of February 1797, lasted two months. The government for reasons of their own made the socialist Babeuf the leader of the conspiracy, though more important people than he were implicated; and his own vanity played admirably into their hands. On Prairial 7 (26th of April 1797) Babeuf and Darthé were condemned to death; some of the prisoners, including Buonarroti, were exiled; the rest, including Vadier and his fellow-conventionals, were acquitted. Drouet had succeeded in making his escape, according to Barras, with the connivance of the Directory. Babeuf and Darthé were executed at Vendôme on Prairial 8 (1797).

Babeuf's character has perhaps been sufficiently indicated above. He was a type of the French revolutionists, excitable, warm-hearted, half-educated, who lost their mental and moral balance in the chaos of the revolutionary period. Historically, his importance lies in the fact that he was the first to propound socialism as a practical policy, and the father of the movements which played so conspicuous a part in the revolutions of 1848 and 1871.

See V. Advielle, *Hist. de Gracchus Babeuf et de Babouvisme* (2 vols., Paris, 1884); P. M. Buonarroti, *Confession pour l'égalité, dite de Babeuf* (2 vols., Brussels, 1828; later editions, 1850 and 1866). English translation by Bronterre O'Brien (London, 1836); *Cambridge Modern History*, vol. viii.; Adolf Schmidt, *Pariser Zustände während der Revolutionszeit von 1790-1800* (Jena, 1874). French trans. by P. Viollet, *Paris pendant la Révolution d'après les rapports de la police secrète, 1790-1800* (4 vols., 1880-1894); A. Schmidt, *Tableaux de la Révolution française, &c.* (Leipzig, 1867-1870), a collection of reports of the secret police on which the above work is based. A full report of the trial at Vendôme was published in four volumes at Paris in 1797, *Débats du procès, &c.* (N. A. P.)

BĀBIISM, the religion founded in Persia in A.D. 1844-1845 by Mirzā 'Alī Muhammad of Shīrāz, a young Sayyid who was at that time not twenty-five years of age. Before his "manifestation" (*zuhūr*), of which he gives in the Persian *Bayān* a date corresponding to 23rd May 1844, he was a disciple of Sayyid Kāzīm of Rasht, the leader of the Shaykhīs, a sect of extreme Shī'ites characterized by the doctrine (called by them *Rukn-i-rābī*, "the fourth support") that at all times there must exist an intermediary between the twelfth Imām and his faithful followers. This intermediary they called "the perfect Shī'ite," and his prototype is to be found in the four successive *Bābs* or "gates" through whom alone the twelfth Imām, during the period of his "minor occultation" (*Gaybat-i-sughrā*, A.D. 874-940), held communication with his partisans. It was in this sense, and not, as has been often asserted, in the sense of "Gate of God" or "Gate of Religion," that the title *Bāb* was understood and assumed by Mirzā 'Alī Muhammad; but, though still generally thus styled by non-Bābīs, he soon assumed the higher title of *Nuqta* ("Point"), and the title *Bāb*, thus left vacant, was conferred on his ardent disciple, Mullā Husayn of Bushrawayh.

The history of the Bābīs, though covering a comparatively short period, is so full of incident and the particulars now available

are so numerous, that the following account purports to be only the briefest sketch. The Bāb himself was in captivity first at Shīrāz, then at Mākū, and lastly at Chīhrīq, during the greater part of the six years (May 1844 until July 1850) of his brief career, but an active propaganda was carried on by his disciples, which resulted in several serious revolts against the government, especially after the death of Muhammad Shāh in September 1848. Of these risings the first (December 1848-July 1849) took place in Māzandarān, at the ruined shrine of Shaykh Tabarsī, near Bārfurūsh, where the Bābīs, led by Mullā Muhammad 'Alī of Bārfurūsh and Mullā Husayn of Bushrawayh ("the first who believed"), defied the shah's troops for seven months before they were finally subdued and put to death. The revolt at Zanjān in the north-west of Persia, headed by Mullā Muḥammad 'Alī Zanjānī, also lasted seven or eight months (May-December 1850), while a serious but less protracted struggle was waged against the government at Nīrīz in Fārs by Agā Sayyid Yahyā of Nīrīz. Both revolts were in progress when the Bāb, with one of his devoted disciples, was brought from his prison at Chīhrīq to Tabrīz and publicly shot in front of the *arg* or citadel. The body, after being exposed for some days, was recovered by the Bābīs and conveyed to a shrine near Tehrān, whence it was ultimately removed to Acre in Syria, where it is now buried. For the next two years comparatively little was heard of the Bābīs, but on the 15th of August 1852 three of them, acting on their own initiative, attempted to assassinate Nāsrū'd-Dīn Shāh as he was returning from the chase to his palace at Nīyāvārān. The attempt failed, but was the cause of a fresh persecution, and on the 31st of August 1852 some thirty Bābīs, including the beautiful and talented poetess Qurraṭul-'Ayn, were put to death in Tehrān under atrocious cruelty. Another of the victims of that day was Hājji Mirzā Jānī of Kāshān, the author of the oldest history of the movement from the Bābī point of view. Only one complete MS. of his invaluable work (obtained by Count Gobineau in Persia) exists in any public library, the Bibliothèque Nationale at Paris. The so-called "New History" (of which an English translation was published at Cambridge in 1893 by E. G. Browne) is based on Mirzā Jānī's work, but many important passages which did not accord with later Bābī doctrine or policy have been suppressed or modified, while some additions have been made. The Bāb was succeeded on his death by Mirzā Yahyā of Nūr (at that time only about twenty years of age), who escaped to Bagdad, and, under the title of *Subh-i-Ezel* ("the Morning of Eternity"), became the pontiff of the sect. He lived, however, in great seclusion, leaving the direction of affairs almost entirely in the hands of his elder half-brother (born 12th November 1817), Mirzā Husayn 'Alī, entitled *Bahā' u'llāhī* ("the Splendour of God"), who thus gradually became the most conspicuous and most influential member of the sect, though in the *iqān*, one of the most important polemical works of the Bābīs, composed in 1858-1859, he still implicitly recognized the supremacy of *Subh-i-Ezel*. In 1863, however, Bahā declared himself to be "He whom God shall manifest" (*Man Yas-hiruhu'llāh*, with prophecies of whose advent the works of the Bāb are filled), and called on all the Bābīs to recognize his claim. The majority responded, but *Subh-i-Ezel* and some of his faithful adherents refused. After that date the Bābīs divided into two sects, *Ezelīs* and Bahā'īs, of which the former steadily lost and the latter gained ground, so that in 1908 there were probably from half a million to a million of the latter, and at most only a hundred or two of the former. In 1863 the Bābīs were, at the instance of the Persian government, removed from Bagdad to Constantinople, whence they were shortly afterwards transferred to Adrianople. In 1868 Bahā and his followers were exiled to Acre in Syria, and *Subh-i-Ezel* with his few adherents to Famagusta in Cyprus, where he was still living in 1908. Bahā u'llāh died at Acre on the 16th of May 1892. His son 'Abbās Efendī (also called 'Abdu'l-Bahā, "the servant of Bahā") was generally recognized as his successor, but another of his four sons, Muhammad 'Alī, put forward a rival claim. This caused a fresh and bitter schism, but 'Abbās Efendī steadily gained ground, and there could be little doubt as to his eventual

triumph. The controversial literature connected with this latest schism is abundant, not only in Persia, but in English, for since 1900 many Americans have adopted the religion of Bahá'. The original apostle of America was Ibráhím George Khayrú'lláh, who began his propaganda at the Chicago Exhibition and later supported the claims of Muhammad 'Alí. Several Persian missionaries, including the aged and learned Mirzá Abul-Fazl of Gulpáyyágán, were thereupon despatched to America by 'Abbás Efendi, who was generally accepted by the American Bahá'ís as "the Master." The American press contained many notices of the propaganda and its success. An interesting article on the subject, by Stoyan Krstoff Vatralsky of Boston, Mass., entitled "Mohammedan Gnosticism in America," appeared in the *American Journal of Theology* for January 1902, pp. 57-58.

A correct understanding of the doctrines of the early Bábis (now represented by the Ezelis) is hardly possible save to one who is conversant with the theology of Islám and its developments, and especially the tenets of the Shí'a. The Bábis are Muhammadans only in the sense that the Muhammadans are Christians or the Christians Jews; that is to say, they recognize Muhammad (Mahomet) as a true prophet and the Qur'án (Koran) as a revelation, but deny their finality. Revelation, according to their view, is progressive, and no revelation is final, for, as the human race progresses, a fuller measure of truth, and ordinances more suitable to the age, are vouchsafed. The Divine Unity is incomprehensible, and can be known only through its Manifestations; to recognize the Manifestation of the cycle in which he lives is the supreme duty of man. Owing to the enormous volume and unsystematic character of the Bábi scriptures, and the absence of anything resembling church councils, the doctrine on many important points (such as the future life) is undetermined and vague. The resurrection of the body is denied, but some form of personal immortality is generally, though not universally, accepted. Great importance was attached to the mystical values of letters and numbers, especially the numbers 18 and 19 ("the number of the unity") and $19^2 = 361$ ("the number of all things"). In general, the Bábi's doctrines most closely resembled those of the Isma'ílís and Hurúfís. In the hands of Bahá the aims of the sect became much more practical and ethical, and the wilder pantheistic tendencies and metaphysical hair-splittings of the early Bábis almost disappeared. The intelligence, integrity and morality of the Bábis are high, but their efforts to improve the social position of woman have been much exaggerated. They were in no way concerned (as was at the time falsely alleged) in the assassination of Náshír'ud-Dín Sháh in May 1806. Of recent persecutions of the sect the two most notable took place at Yazd, one in May 1891, and another of greater ferocity in June 1903. Some account of the latter is given by Napier Malcolm in his book *Five Years in a Persian Town* (London, 1905), pp. 87-89 and 186. In the constitutional movement in Persia (1907) the Bábis, though their sympathies are undoubtedly with the reformers, wisely refrained from outwardly identifying themselves with that party, to whom their open support, by alienating the orthodox *mujtahids* and *mullás*, would have proved fatal. Here, as in all their actions, they clearly obeyed orders issued from headquarters.

LITERATURE.—The literature of the sect is very voluminous, but mostly in manuscript. The most valuable public collections in Europe are at St Petersburg, London (British Museum) and Paris (Bibliothèque Nationale), where two of three very rare MSS. collected by Gobineau, including the precious history of the Bábis contemporary, Hájjí Mirzá Ján of Káshán, are preserved. For the bibliography up to 1889, see vol. ii, pp. 173-211 of the *Traveller's Narrative, written to illustrate the Episode of the Bábi*, a Persian work composed by Bahá's son, 'Abbás Efendi, edited, translated and annotated by E. G. Browne (Cambridge, 1891). More recent works are:—Browne, *The New History of the Bábi* (Cambridge, 1893); and "Catalogue and Description of the 27 Bábi Manuscripts," *Journal of R. Asiatic Soc.* (July and October 1892); Andreas, *Die Bábis in Persien* (1890); Baron Victor Rosen, *Collections scientifiques de l'Institut des Langues orientales*, vol. 1 (1877), pp. 179-212; vol. iii. (1886), pp. 1-141; vol. vi. (1891), pp. 141-255; "Manuscripts Bábis"; and other important articles in Russian by a number of scholars; and by Captain A. G. Toumanský in the *Zapiski Ostochenna otdeleniya Imperatorskava Russkava Arheologicheskava Obshchestva*

(vols. iv.-xii., St Petersburg, 1890-1900); also an excellent edition by Toumanský, with Russian translation, notes and introduction, of the *Kitáb-i-Aqdas* (the most important of Bahá's works), &c. (St Petersburg, 1899). Mention should also be made of an Arabic history of the Bábis (unsympathetic but well-informed) written by a Persian, Mirzá Muhammad Mahdí Khan, *Za'imu'd-Duwa*, printed in Cairo in A.H. 1321 (= A.D. 1903-1904). Of the works composed in English for the American converts the most important are:—*Bahá'u'lláh* (The Glory of God), by Ibráhím Khayrú'lláh, assisted by Howard MacNutt (Chicago, 1900); *The Three Questions* (s.d.) and *Facts for Baháists* (1901), by the same; *Life and Teachings of 'Abbás Efendi*, by Myron H. Phelps, with preface by E. G. Browne (New York, 1903); Isabella Brittingham, *The Revelations of Bahá'u'lláh, in a Sequence of Four Lessons* (1902); Laura Clifford Burney, *Some Answered Questions Collected* (in *Acree*, 1904-1906) and *Translated from the Persian of 'Abdu'l-Bahá* (i.e., 'Abbás Efendi) (London, 1908). In French, A. L. M. Nicolas (first dragoman at the French legation at Tehrán) has published several important translations, viz. *Le Livre des sept preuves de la mission du Báb* (Paris, 1902); *Le Livre de la carité* (1904); and *Le Beydn arabe* (1905); and there are other notable works by H. Dreyfus, an adherent of the Bábi faith. Lastly, mention should be made of a remarkable but scarce little tract by Gabriel Sacy, printed at Cairo in June 1902, and entitled *Du règne de Dieu et de l'Agneau, connu sous le nom de Babysme*. (E. G. B.)

BABINGTON, ANTHONY (1561-1586), English conspirator, son of Henry Babington of Dethick in Derbyshire, and of Mary, daughter of George, Lord Darcy, was born in October 1561, and was brought up secretly a Roman Catholic. As a youth he served at Sheffield as page to Mary queen of Scots, for whom he early felt an ardent devotion. In 1580 he came to London, attended the court of Elizabeth, and joined the secret society formed that year supporting the Jesuit missionaries. In 1582 after the execution of Father Campion he withdrew to Dethick, and attaining his majority occupied himself for a short time with the management of his estates. Later he went abroad and became associated at Paris with Mary's supporters who were planning her release with the help of Spain, and on his return he was entrusted with letters for her. In April 1586 he became, with the priest John Ballard, leader of a plot to murder Elizabeth and her ministers, and organize a general Roman Catholic rising in England and liberate Mary. The conspiracy was regarded by Mendoza, the Spanish ambassador, one of its chief instigators, and also by Walsingham, as the most dangerous of recent years; it included, in its general purpose of destroying the government, a large number of Roman Catholics, and had ramifications all over the country. Philip II. of Spain, who ardently desired the success of an enterprise "so Christian, just and advantageous to the holy Catholic faith," promised to assist with an expedition directly the assassination of the queen was effected. Babington's conduct was marked by open folly and vanity. Desirous of some token of appreciation from Mary for his services, he entered into a long correspondence with her, which was intercepted by the spies of Walsingham. On the 4th of August Ballard was seized and betrayed his comrades, probably under torture. Babington then applied for a passport abroad, for the ostensible purpose of spying upon the refugees, but in reality to organize the foreign expedition and secure his own safety. The passport being delayed, he offered to reveal to Walsingham a dangerous conspiracy, but the latter sent no reply, and meanwhile the ports were closed and none allowed to leave the kingdom for some days. He was still allowed his liberty, but one night while supping with Walsingham's servant he observed a memorandum of the minister's concerning himself, fled to St John's Wood, where he was joined by some of his companions, and after disguising himself succeeded in reaching Harrow, where he was sheltered by a recent convert to Romanism. Towards the end of August he was discovered and imprisoned in the Tower. On the 13th and 14th of September he was tried with Ballard and five others by a special commission, when he confessed his guilt, but strove to place all the blame upon Ballard. All were condemned to death for high treason. On the 19th he wrote to Elizabeth praying for mercy, and the same day offered £1000 for procuring his pardon; and on the 20th, having disclosed the cipher used in the correspondence between himself and Mary, he was executed

¹ *Cata. of State Papers Simancas*, iii. 606, Mendoza to Philip.

with the usual barbarities in Lincoln's Inn Fields. The detection of the plot led to Mary's own destruction. There is no positive documentary proof in Mary's own hand that she had knowledge of the intended assassination of Elizabeth, but her circumstances, together with the tenour of her correspondence with Babington, place her complicity beyond all reasonable doubt.

BABINGTON, CHURCHILL (1821-1889), English classical scholar and archaeologist, was born at Roeliff, in Leicestershire, on the 11th of March 1821. He was educated by his father till he was seventeen, when he was placed under the tuition of Charles Wycliffe Goodwin, the orientalist and archaeologist. He entered St John's College, Cambridge, in 1839, and graduated B.A. in 1843, being seventh in the first class of the classical tripos and a senior optime. In 1845 he obtained the Hulsean Prize for his essay *The Influence of Christianity in promoting the Abolition of Slavery in Europe*. In 1846 he was elected to a fellowship and took orders. He proceeded to the degree of M.A. in 1846 and D.D. in 1879. From 1848 to 1861 he was vicar of Horningsea, near Cambridge, and from 1866 to his death on the 12th of January 1889, vicar of Cockfield in Suffolk. From 1865 to 1880 he held the Disney professorship of archaeology at Cambridge. In his lectures, illustrated from his own collections of coins and vases, he dealt chiefly with Greek and Roman pottery and numismatics.

Dr Babington was a many-sided man and wrote on a variety of subjects. His early familiarity with country life gave him a taste for natural history, especially botany and ornithology. He was also an authority on conchology. He was the author of the appendices on botany (in part) and ornithology in Potter's *History and Antiquities of Charnwood Forest* (1842); *Mr Macaulay's Character of the Clergy . . . considered* (1849), a defence of the clergy of the 17th century, which received the approval of Mr Gladstone, against the strictures of Macaulay. He also brought out the *editio princeps* of the speeches of Hyperides *Against Demosthenes* (1850), *On Behalf of Lycophron and Euxenippus* (1853), and his *Funerary Oration* (1858). It was by his edition of these speeches from the papyri discovered at Thebes (Egypt) in 1847 and 1856 that Babington's fame as a Greek scholar was made. In 1855 he published an edition of *Beneficio della Morte di Cristo*, a remarkable book of the Reformation period, attributed to Paleario, of which nearly all the copies had been destroyed by the Inquisition. Babington's edition was a facsimile of the *editio princeps* published at Venice in 1543, with Introduction and French and English versions. He also edited the first two volumes of Higden's *Polychronicon* (1858) and Bishop Peacock's *Repressor of Overmuch Blaming of the Clergy* (1860), undertaken at the request of the Master of the Rolls; *Introductory Lecture on Archaeology* (1865); *Roman Antiquities found at Rougham* [1872]; *Catalogue of Birds of Suffolk* (1884-1886); *Flora of Suffolk* (with W. M. Hind, 1889), and (1835, 1865) some inscriptions found in Crete by T. A. B. Spratt, the explorer of the island. In addition to contributing to various classical and scientific journals, he catalogued the classical MSS. in the University Library and the Greek and English coins in the Fitzwilliam museum.

BABIRUSA ("pig-deer"), the Malay name of the wild swine of Celebes and Buru, which has been adopted in zoology as the scientific designation of this remarkable animal (the only representative of its genus), in the form of *Babirusa alfurus*. The skin is nearly naked, and very rough and rugged. The total number of teeth is 34, with the formula $i \frac{3}{3}$. $c \frac{1}{1}$. $p \frac{3}{3}$. $m \frac{3}{3}$. The molars, and more especially the last, are smaller and simpler than in the pigs of the genus *Sus*, but the peculiarity of this genus is the extraordinary development of the canines, or tusks, of the male. These teeth are ever-growing, long, slender and curved, and without enamel. Those of the upper jaw are directed upwards from their bases, so that they never enter the mouth, but pierce the skin of the face, thus resembling horns rather than teeth; they curve backwards, downwards, and finally often forwards again, almost or quite touching the forehead. Dr A. R. Wallace remarks that "it is difficult to understand what can be the use of these horn-like teeth. Some of the old writers supposed that they served as hooks by which the creature could rest its

head on a branch. But the way in which they usually diverge just over and in front of the eye has suggested the more probable idea, that they serve to guard these organs from thorns and spines while hunting for fallen fruits among the tangled thickets of rattans and other spiny plants. Even this, however, is not satisfactory, for the female, who must seek her food in the same way, does not possess them. I should be inclined to believe rather that these tusks were once useful, and were then worn

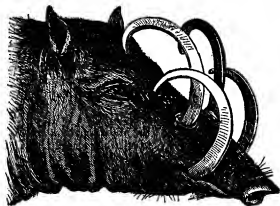

Old Male Babirusa (*Babirusa alfurus*).

down as fast as they grew, but that changed conditions of life have rendered them unnecessary, and they now develop into a monstrous form, just as the incisors of the beaver and rabbit will go on growing if the opposite teeth do not wear them away. In old animals they reach an enormous size, and are generally broken off as if by fighting." On this latter view we may regard the tusks of the male babirusa as examples of redundant development, analogous to that of the single pair of lower teeth in some of the beaked whales. Unlike ordinary wild pigs, the babirusa produces uniformly coloured young. (See SWINE.) (R. L.*)

BABOON (from the Fr. *babuin*, which is itself derived from *Babon*, the Egyptian deity to whom it was sacred), properly the designation of the long-muzzled, medium-tailed Egyptian monkey, scientifically known as *Papio anubis*; in a wider sense applied to all the members of the genus *Papio* (formerly known as *Cynocephalus*) now confined to Africa and Arabia, although in some times extending into India. Baboons are for the most part large terrestrial monkeys with short or medium-sized tails, and long naked dog-like muzzles, in the truncated extremity of which are pierced the nostrils. As a rule, they frequent barren rocky districts in large droves, and are exceedingly fierce and dangerous to approach. They have large cheek-pouches, large naked callosities, often brightly coloured, on the buttocks, and short thick limbs, adapted rather to walking than to climbing. Their diet includes practically everything eatable they can capture or kill. The typical representative of the genus is the yellow baboon (*P. cynocephalus*, or *babuin*), distinguished by its small size and grooved muzzle, and ranging from Abyssinia to the Zambesi. The above-mentioned anubis baboon, *P. anubis* (with the subspecies *neumannii*, *pruinusos*, *heuglinii* and *doguera*), ranging from Egypt all through tropical Africa, together with *P. sphinx*, *P. olivaceus*, the Abyssinian *P. iydekkeri*, and the chacma, *P. porciarius* of the Cape, represent the subgenus *Choeropithecus*. The named Arabian baboon, *P. hamadryas* of North Africa and Arabia, dedicated by the ancient Egyptians to the god Thoth, and the South Arabian *P. arabicus*, typify *Hamadryas*; while the drill and mandrill of the west coast, *P. leucophaeus* and *P. maimon*, constitute the subgenus *Maimon*. The anubis baboons, as shown by the frescoes, were tamed by the ancient Egyptians and trained to pluck sycamore-figs from the trees. (See PRIMATES; CHACMA; DRILL; GELADA and MANDRILL.) (R. L.*)

BABRIUS, author of a collection of fables written in Greek. Practically nothing is known of him. He is supposed to have been a Roman, whose gentile name was possibly Valerius, living in the East, probably in Syria, where the fables seem first

to have gained popularity. The address to "a son of King Alexander" has caused much speculation, with the result that dates varying between the 3rd century B.C. and the 3rd century A.D. have been assigned to Babrius. The Alexander referred to may have been Alexander Severus (A.D. 222-235), who was fond of having literary men of all kinds about his court. "The son of Alexander" has further been identified with a certain Branchus mentioned in the fables, and it is suggested that Babrius may have been his tutor; probably, however, Branchus is a purely fictitious name. There is no mention of Babrius in ancient writers before the beginning of the 3rd century A.D., and his language and style seem to show that he belonged to that period. The first critic who made Babrius more than a mere name was Richard Bentley, in his *Dissertation on the Fables of Aesop*. In a careful examination of these prose Aesopian fables, which had been handed down in various collections from the time of Maximus Planudes, Bentley discovered traces of versification, and was able to extract a number of verses which he assigned to Babrius. Tyrwhitt (*De Babrio*, 1776) followed up the researches of Bentley, and for some time the efforts of scholars were directed towards reconstructing the metrical original of the prose fables. In 1842 M. Minas, a Greek, the discoverer of the *Philosophoumena* of Hippolytus, came upon a MS. of Babrius in the convent of St. Laura on Mount Athos, now in the British Museum. This MS. contained 123 fables out of the supposed original number, 160. They are arranged alphabetically, but break off at the letter O. The fables are written in choliambic, i.e. limping or imperfect iambic verse, having a spondee as the last foot, a metre originally appropriated to satire. The style is extremely good, the expression being terse and pointed, the versification correct and elegant, and the construction of the stories is fully equal to that in the prose versions. The genuineness of this collection of the fables was generally admitted by scholars. In 1857 Minas professed to have discovered at Mount Athos another MS. containing 94 fables and a preface. As the monks refused to sell this MS., he made a copy of it, which was sold to the British Museum, and was published in 1859 by Sir G. Cornewall Lewis. This, however, was soon proved to be a forgery. Six more fables were brought to light by P. Knöll from a Vatican MS. (edited by A. Eberhard, *Analecta Babriana*, 1879).

ENTRIGUES.—Boissonade (1844); Lachmann (1845); Schneider (1853); Eberhard (1876); Giltbauer (1882); Rutherford (1883); Knöll, *Fabularum Babrianarum Paraphrasis Boileiana* (1877); Feuillet (1890); Desrousseaux (1890); Passerat (1892); Croiset (1892); Crusius (1897). See also Mantels, *Über die Fabeln des B.* (1840); Crusius, *De Babrii Aetate* (1879); Ficus, *De Babrii Vita* (1889); J. Weiner, *Quaestiones Babrianae* (1891); Conington, *Miscellaneous Writings*, ii. 460-491; Marchiano, *Babrio* (1899); Fuscini, *Babrio* (1901); Christofferson, *Studia de Fabulis Babrianis* (1901). There are translations in English by Davies (1860) and in French by Leveque (1890), and in many other languages.

BABU, a native Indian clerk. The word is really a term of respect attached to a proper name, like "master" or "Mr.", and *Babu-ji* is still used in many parts of India, meaning "sir"; but without the suffix the word itself is now generally used contemptuously as signifying a semi-literate native, with a mere veneer of modern education.

BABY-FARMING,¹ a term meaning generally the taking in of infants to nurse for payment, but usually with an implication of improper treatment. Previous to the year 1871 the abuse of the practice of baby-farming in England had grown to an alarming extent, while the trials of Margaret Waters and Mary Hall called attention to the infamous relations between the lying-in houses and the baby-farming houses of London. The evil was, no doubt, largely connected with the question of illegitimacy, for there was a wide-spread existence of baby-farmers where children were received without question on payment of a lump sum. Such children were nearly all illegitimate, and in these cases it was to the pecuniary advantage of the baby-farmer to hasten the death of the child. It had become also the practice for factory operatives and mill-hands to place out

their children by the day, and since in many cases the children were looked upon as a burden and a drain on their parents' resources, too particular inquiry was not always made as to the mode in which the children were cared for. The form was gone through too of paying a ridiculously insufficient sum for the maintenance of the child. In 1871 the House of Commons found it necessary to appoint a select committee "to inquire as to the best means of preventing the destruction of the lives of infants put out to nurse for hire by their parents." "Improper and insufficient food," said the committee, "opiates, drugs, crowded rooms, bad air, want of cleanliness, and wilful neglect are sure to be followed in a few months by diarrhoea, convulsions and wasting away." These unfortunate children were nearly all illegitimate, and the mere fact of their being hand-nursed, and not breast-nursed, goes some way (according to the experience of the Foundling hospital and the Magdalene home) to explain the great mortality among them. Such children, when nursed by their mothers in the workhouse, generally live. The practical result of the committee of 1871 was the act of 1872, which provided for the compulsory registration of all houses in which more than one child under the age of one year were received for a longer period than twenty-four hours. No licence was granted by the justices of the peace, unless the house was suitable for the purpose, and its owner a person of good character and able to maintain the children. Offences against the act, including wilful neglect of the children even in a suitable house, were punishable by a fine of £5 or six months' imprisonment with or without hard labour. In 1866 a select committee of the House of Lords sat and reported on the working of this act. In consequence of this report the act of 1872 was repealed and superseded by the Infant Life Protection Act 1897, which did away with the system of registration and substituted for it one of notice to a supervening authority. By the act all persons retaining or receiving for hire more than one infant under the age of five had to give written notice of the fact to the local authority. The local authorities were empowered to appoint inspectors, and required to arrange for the periodical inspection of infants so taken in, while they could also fix the number of infants which might be retained. By a special clause any person receiving an infant under the age of two years for a sum of money not exceeding twenty pounds had to give notice of the fact to the local authority. If any infants were improperly kept, the inspector might obtain an order for their removal to a workhouse-place of safety until restored to their parents or guardians, or otherwise legally disposed of. The act of 1897 was repealed and amended by the Children Act 1908, which codified the law relating to children, and added many new provisions. This act is dealt with in the article CHILDREN, LAW RELATING TO.

In the United States the law is noticeably strict in most states. In Massachusetts, a law of 1801 directs that "every person who receives for board, or for the purpose of procuring adoption, an infant under the age of three years shall use diligence to ascertain whether or not such infant is illegitimate, and if he knows or has reason to believe it to be illegitimate shall forthwith notify the State Board of Charity of the fact of such reception; and said board and its officers or agents may enter and inspect any building where they may have reason to believe that any such illegitimate infant is boarded, and remove such infant when, in their judgment, such removal is necessary by reason of neglect, abuse or other causes, in order to preserve the infant's life, and such infant so removed shall be in the custody of said Board of Charity, which shall make provision therefor according to law." The penal code of the state of New York requires a licence for baby-farming to be issued by the board of health of the city or town where such children are boarded or kept, and "every person so licensed must keep a register wherein he shall enter the names and ages of all such children, and of all children born on such premises, and the names and residences of their parents, as far as known, the time of reception and the discharge of such children, and the reasons therefor, and also a correct register of every child under five years of age who is given out, adopted, taken away, or indentured from such place

¹ Baby is a diminutive or pet form of "babe," now chiefly used in poetry or scriptural language. "Babe" is probably a form of the earlier *baban*, a reduplicated form of the infant sound *ba*.

to or by any one, together with the name and residence of the person so adopting" (Pen. Code, § 288, subsec. 4).

Persons neglecting children may be prosecuted under § 289 of the N.Y. penal code, which provides that any person who "wilfully causes or permits the life or limb of any child, actually or apparently under the age of sixteen years, to be endangered, or its health to be injured, or its morals to become depraved . . . is guilty of a misdemeanor."

In Australia particular care has been taken by most of the states to prevent the evils of baby-farming. In South Australia there is a State Children's Council, which, under the State Children Act of 1895, has large powers with respect to the oversight of infants under two years boarded out by their mother. "Foster-mothers," as the women who take in infants as boarders are called, must be licensed, while the number of children authorized to be kept by the foster-mother is fixed by licence; every licensed foster-mother must keep a register containing the name, age and place of birth of every child received by her, the names, addresses and description of the parents, or of any person other than the parents from or to whom the child was received or delivered over, the date of receipt or delivery over, particulars of any accident to or illness of the child, and the name of the medical practitioner (if any) by whom attended. In New South Wales the Children's Protection Act of 1892, with the amendments of 1902, requires the same state supervision over the homes in which children are boarded out, with licensing of foster-mothers. In Victoria an act was passed in 1890 for "making better provision for the protection of infant life." In New Zealand, there is legislation to the same effect by the "Adoption of Children Act 1895" and the "Infant Life Protection Act 1896."

BABYLON (mod. *Hillah*), an ancient city on the left bank of the Euphrates, about 70 m. S. of Bagdad. "Babylon" is the Greek form of Babel or Bab-ili, "the gate of the god" (sometimes incorrectly written "of the gods"), which again is the Semitic translation of the original Sumerian name Ka-dimirra. The god was probably Merodach or Marduk (*q.v.*), the divine patron of the city. In an inscription of the Kassite conqueror Gaddas the name appears as Ba-ba-lam, as if from the Assyrian *babālu*, "to bring"; another foreign *Volksetymologie* is found in Genesis xi. 9, from *babal*, "to confound." A second name of the city, which perhaps originally denoted a separate village or quarter, was Su-anna, and in later inscriptions it is often represented ideographically by E-ki, the pronunciation and meaning of which are uncertain. One of its oldest names, however, was Din-tir, of which the poets were especially fond; Din-tir signifies in Sumerian "the life of the forest," though a native lexicon translates it "seat of life." Uru-azaga, "the holy city," was also a title sometimes applied to Babylon as to other cities in Babylonia. Ka-dimirra, the Semitic Bab-ili, probably denoted at first E-Saggila, "the house of the lofty head," the temple dedicated to Bel-Merodach, along with its immediate surroundings. Like the other great sanctuaries of Babylonia the temple had been founded in pre-Semitic times, and the future Babylon grew up around it. Since Merodach was the son of Ea, the culture god of Eridu near Ur on the Persian Gulf, it is possible that Babylon was a colony of Eridu. Adjoining Babylon was a town called Borsippa (*q.v.*).

The earliest mention of Babylon is in a dated tablet of the reign of Sargon of Akkad (3800 B.C.), who is stated to have built sanctuaries there to Anunit and Aë (or Ea), and H. Winckler may be right in restoring a mutilated passage in the annals of this king so as to make it mean that Babylon owed its name to Sargon, who made it the capital of his empire. If so, it fell back afterwards into the position of a mere provincial town and remained so for centuries, until it became the capital of "the first dynasty of Babylon" and then of Hammurabi's empire (2250 B.C.). From this time onward it continued to be the capital of Babylonia and the holy city of western Asia. The claim to supremacy in Asia, however real in fact, was not admitted *de jure* until the claimant had "taken the hands" of Bel-Merodach at Babylon, and thereby been accepted as his adopted

son and the inheritor of the old Babylonian empire. It was this which made Tiglath-pileser III. and other Assyrian kings so anxious to possess themselves of Babylon and so to legitimize their power. Sennacherib alone seems to have failed in securing the support of the Babylonian priesthood; at all events he never underwent the ceremony, and Babylonian throughout his reign was in a constant state of revolt which was finally suppressed only by the complete destruction of the capital. In 689 B.C. its walls, temples and palaces were razed to the ground and the rubbish thrown into the Arakhtu, the canal which bordered the earlier Babylon on the south. The act shocked the religious conscience of western Asia; the subsequent murder of Sennacherib was held to be an expiation of it, and his successor Esarhaddon hastened to rebuild the old city, to receive there his crown, and make it his residence during part of the year. On his death Babylonia was left to his elder son Samas-sum-yukin, who eventually headed a revolt against his brother Assur-bani-pal of Assyria. Once more Babylon was besieged by the Assyrians and starved into surrender. Assur-bani-pal purified the city and celebrated a "service of reconciliation," but did not venture to "take the hands" of Bel. In the subsequent overthrow of the Assyrian empire the Babylonians saw another example of divine vengeance.

With the recovery of Babylonian independence under Nabopolassar a new era of architectural activity set in, and his son Nebuchadrezzar made Babylon one of the wonders of the ancient world. It surrendered without a struggle to Cyrus, but two sieges in the reign of Darius Hystaspis, and one in the reign of Xerxes, brought about the destruction of the defences, while the monotheistic rule of Persia allowed the temples to fall into decay. Indeed part of the temple of E-Saggila, which like other ancient temples served as a fortress, was intentionally pulled down by Xerxes after his capture of the city. Alexander was murdered in the palace of Nebuchadrezzar, which must therefore have been still standing, and cuneiform texts show that, even under the Seleucids, E-Saggila was not wholly a ruin. The foundation of Seleucia in its neighbourhood, however, drew away the population of the old city and hastened its material decay. A tablet dated 275 B.C. states that on the 12th of Nisan the inhabitants of Babylon were transported to the new town, where a palace was built as well as a temple to which the ancient name of E-Saggila was given. With this event the history of Babylon comes practically to an end, though more than a century later we find sacrifices being still performed in its old sanctuary.

Our knowledge of its topography is derived from the classical writers, the inscriptions of Nebuchadrezzar, and the excavations of the *Deutsche Orientgesellschaft*, which were begun in 1899. The topography is necessarily that of the Babylon of Nebuchadrezzar; the older Babylon which was destroyed by Sennacherib having left few, if any, traces behind. Most of the existing remains lie on the E. bank of the Euphrates, the principal being three vast mounds, the *Babil* to the north, the *Qasr* or "Palace" (also known as the *Mujelliba*) in the centre, and the Ishān 'Amrān ibn 'Ali, with the outlying spur of the Jumjuma, to the south. Eastward of these come the Ishān el-Aswad or "Black Mound" and three lines of rampart, one of which encloses the *Babil* mound on the N. and E. sides, while a third forms a triangle with the S.E. angle of the other two. W. of the Euphrates are other ramparts and the remains of the ancient Borsippa.

We learn from Herodotus and Ctesias that the city was built on both sides of the river in the form of a square, and enclosed within a double row of lofty walls to which Ctesias adds a third. Ctesias makes the outermost wall 360 stades (42 m.) in circumference, while according to Herodotus it measured 480 stades (56 m.), which would include an area of about 200 sq. m. The estimate of Ctesias is essentially the same as that of Q. Curtius (v. 1. 26), 368 stades, and Clitarchus (*ap. Diod. Sic. ii. 7.*), 365 stades; Strabo (xvi. 1. 5) makes it 385 stades. But even the estimate of Ctesias, assuming the stade to be its usual length, would imply an area of about 100 sq. m. According to Herodotus the height of the walls was about 335 ft. and their width 85 ft.;

according to Ctesias the height was about 300 ft. The measurements seem exaggerated, but we must remember that even in Xenophon's time (*Anab.* iii. 4. 10) the ruined wall of Nineveh was still 150 ft. high, and that the spaces between the 250 towers of the wall of Babylon (*Ctes.* 417, *ap.* Diod. ii. 7) were broad enough to let a four-horse chariot turn (*Herod.* i. 179). The clay dug from the moat served to make the bricks of the wall, which had 100 gates, all of bronze, with bronze lintels and posts. The two inner enclosures were faced with enamelled tiles and represented hunting-scenes. Two other walls ran along the banks of the Euphrates and the quays with which it was lined, each containing 25 gates which answered to the number of streets they led into. Ferry-boats plied between the landing-places of the gates, and a movable drawbridge (30 ft. broad), supported on stone piers, joined the two parts of the city together.

The account thus given of the walls must be grossly exaggerated and cannot have been that of an eye-witness. Moreover, the two walls—Imgur-Bel, the inner wall, and Nimitti-Bel, the outer—which enclosed the city proper on the site of the older Babylon have been confused with the outer ramparts (enclosing the whole of Nebuchadrezzar's city), the remains of which can still be traced to the east. According to Nebuchadrezzar, Imgur-Bel was built in the form of a square, each side of which measured "30 *aslu* by the great cubit"; this would be equivalent, if Professor F. Hommel is right, to 2400 metres. Four thousand cubits to the east the great rampart was built "mountain high," which surrounded both the old and the new town; it was provided with a moat, and a reservoir was excavated in the triangle on the inner side of its south-east corner, the western wall of which is still visible. The Imgur-Bel of Sargon's time has been discovered by the German excavators running south of the *Qasr* from the Euphrates to the Gate of Ishtar.

The German excavations have shown that the *Qasr* mound represents both the old palace of Nabopolassar, and the new palace adjoining it built by Nebuchadrezzar, the wall of which he boasts of having completed in 15 days. They have also laid bare the site of the "Gate of Ishtar" on the east side of the mound and the little temple of Nin-Makh (Beltilis) beyond it, as well as the raised road for solemn processions (*A-ibur-sabu*) which led from the Gate of Ishtar to E-Saggila and skirted the east side of the palace. The road was paved with stone and its walls on either side lined with enamelled tiles, on which a procession of lions is represented. North of the mound was a canal, which seems to have been the Libilkehal of the inscriptions, while on the south side was the Arakhtu, "the river of Babylon," the brick quays of which were built by Nabopolassar.

The site of E-Saggila is still uncertain. The German excavators assign it to the 'Amrân mound, its tower having stood in a depression immediately to the north of this, and so place it south of the *Qasr*; but E. Lindl and F. Hommel have put forward strong reasons for considering it to have been north of the latter, on a part of the site which has not yet been explored. A tablet copied by George Smith gives us interesting details as to the plan and dimensions of this famous temple of Bel; a plan based on these will be found in Hommel's *Grundriss der Geographie und Geschichte des alten Orients*, p. 321. There were three courts, the outer or great court, the middle court of Ishtar and Zamama, and the inner court on the east side of which was the tower of seven stages (known as the House of the Foundation of Heaven and Earth), 90 metres high according to Hommel's calculation of the measurements in the tablet; while on the west side was the temple proper of Merodach and his wife Sarpanit or Zarpanit, as well as chapels of Anu, Ea and Bel on either side of it. A winding ascent led to the summit of the tower, where there was a chapel, containing, according to Herodotus, a couch and golden table (for the showbread), but no image. The golden image of Merodach 40 ft. high, stood in the temple below, in the sanctuary called E-Kua or "House of the Oracle," together with a table, a mercys-seat and an altar—all of gold. The deities whose chapels were erected within the precincts of the temple enclosure were regarded as forming his court. Fifty-five of these chapels existed

altogether in Babylon, but some of them stood independently in other parts of the city.

There are numerous gates in the walls both of E-Saggila and of the city, the names of many of which are now known. Nebuchadrezzar says that he covered the walls of some of them with blue enamelled tiles "on which bulls and dragons were portrayed," and that he set up large bulls and serpents of bronze on their thresholds.

The *Babil* mound probably represents the site of a palace built by Nebuchadrezzar at the northern extremity of the city walls and attached to a defensive outwork 60 cubits in length. Since H. Rassam found remains of irrigation works here it might well be the site of the Hanging Gardens. These consisted, we are told, of a garden of trees and flowers, built on the topmost of a series of arches some 75 ft. high, and in the form of a square, each side of which measured 400 Greek ft. Water was raised from the Euphrates by means of a screw (*Strabo* xvi. 1. 5; *Diod.* ii. 10. 6). In the Jumjuma mound at the southern extremity of the old city the contract and other business tablets of the Egibi firm were found.

See C. J. Rich, *Memoir on the Ruins of Babylon* (1816), and *Collected Memoirs* (1839); A. H. Layanard, *Nineveh and Babylon* (1853); C. F. Tiele, *De Hoofdsteden van Babel* (1886); A. H. Sayce, *Reign of the Ancient Babylonians*, App. II. (1887); C. J. Ball, *Records of the Past* (new ser. iii. 1890); *Mittheilungen der deutschen Orientgesellschaft* (1899-1906); F. Delitzsch, *Im Lande des einstigen Paradieses* (1903); F. H. Weissbach, *Das Stadtbild von Babylon* (1904); F. Hommel, *Grundriss der Geographie und Geschichte des alten Orients* (1904). (A. H. S.)

BABYLONIA AND ASSYRIA. I. Geography.—Geographically as well as ethnologically and historically, the whole district enclosed between the two great rivers of western Asia, the Tigris and Euphrates, forms but one country. The writers of antiquity clearly recognized this fact, speaking of the whole under the general name of Assyria, though Babylonia, as will be seen, would have been a more accurate designation. It naturally falls into two divisions, the northern being more or less mountainous, while the southern is flat and marshy; the near approach of the two rivers to one another, at a spot where the undulating plateau of the north sinks suddenly into the Babylonian alluvium, tends to separate them still more completely. In the earliest times of which we have any record, the northern portion was included in Mesopotamia; it was definitely marked off as Assyria only after the rise of the Assyrian monarchy. With the exception of Assur, the original capital, the chief cities of the country, Nineveh, Calah and Arbela, were all on the left bank of the Tigris. The reason of this preference for the eastern bank of the Tigris was due to its abundant supply of water, whereas the great Mesopotamian plain on the western side had to depend upon the streams which flowed into the Euphrates. This vast flat, the modern El-Jezireh, is about 250 miles in length, interrupted only by a single limestone range, rising abruptly out of the plain, and branching off from the Zagros mountains under the names of *Sarazir*, *Hamrin* and *Sinjir*. The numerous remains of old habitations show how thickly this level tract must once have been peopled, though now for the most part a wilderness. North of the plateau rises a well-watered and undulating belt of country, into which run low ranges of limestone hills, sometimes arid, sometimes covered with dwarf-oak, and often shutting in, between their northern and north-eastern flank and the main mountain-line from which they detach themselves, rich plains and fertile valleys. Behind them tower the massive ridges of the Niphates and Zagros ranges, where the Tigris and Euphrates take their rise, and which cut off Assyria from Armenia and Kurdistan.

The name Assyria itself was derived from that of the city of Assur (*q.v.*) or Asur, now Qal'at Sherqat (Kaleh Sherqat), which stood on the right bank of the Tigris, midway between the Greater and the Lesser Zab. It remained the capital long after the Assyrians had become the dominant power in western Asia, but was finally supplanted by Calah (*Nimrud*), Nineveh (*Nebi Yunus* and *Kuyunjik*), and Dur-Sargina (*Khorsabad*), some 60 m. farther north (see NINEVEH).

In contrast with the arid plateau of Mesopotamia, stretched the

rich alluvial plain of Chaldea, formed by the deposits of the two great rivers by which it was enclosed. The soil was extremely fertile, and teemed with an industrious population. Eastward rose the mountains of Elam, southward were the sea-marshes and the Kaldā or Chaldaeans and other Aramaic tribes, while on the west the civilization of Babylonia encroached beyond the banks of the Euphrates, upon the territory of the Semitic nomads (or Suti). Here stood Ur (*Mugheir*, more correctly *Muqayyar* (or Suti)). Here stood Ur (the earliest capital of the country; and Babylon, with its suburb, Borsippa (*Birs Nimrūd*), as well as the two Sipparas (the Sefharvaīm of Scripture, now *Abu Habba*), occupied both the Arabian and Chaldaean sides of the river (see *BABYLON*). The Arakhtu, or "river of Babilon," flowed past the southern side of the city, and to the south-west of it on the Arabian bank lay the great inland freshwater sea of *Nejef*, surrounded by red sandstone cliffs of considerable height, 40 m. in length and 35 in breadth in the widest part. Above and below this sea, from Borsippa to Kufa, extend the famous Chaldaean marshes, where Alexander was nearly lost (Arrian, *Exp. Al. vii. 22*; Strab. xvi. 1, § 12); but these depend upon the state of the Hindiyā canal, disappearing altogether when it is closed.

Eastward of the Euphrates and southward of Sippara, Kutha and Babylon were Kis (*Uhairim*, 9 m. E. of *Hilab*), Nippur (*Nifer*)—where stood the great sanctuary of El-il, the older Bel—Uruk or Erech (*Warka*) and Larsa (*Senkera*) with its temple of the sun-god, while eastward of the Shatt el-Hai, probably the ancient channel of the Tigris, was Lagash (*Tello*), which played an important part in early Babylonian history. The primitive seaport of the country, Eridu, the seat of the worship of Ea the culture-god, was a little south of Ur (at *Abu Shahrain* or *Nowdzu* on the west side of the Euphrates). It is now about 130 m. distant from the sea; as about 46 m. of land have been formed by the silting up of the shore since the foundation of Spasinus Charax (*Mahamrah*) in the time of Alexander the Great, or some 115 ft. a year, the city would have been in existence at least 600 years ago. The marshes in the south like the adjoining desert were frequented by Aramaic tribes; of these the most famous were the Kaldā or Chaldaeans who under Merodach-baladan made themselves masters of Babylon and gave their name in later days to the whole population of the country. The combined stream of the Euphrates and Tigris as it flowed through the marshes was known to the Babylonians as the *nār marrāti*, "the salt river" (cp. Jer. i. 21), a name originally applied to the Persian Gulf.

The alluvial plain of Babylonia was called Edin, the Eden of Gen. ii., though the name was properly restricted to "the plain" on the western bank of the river where the Bedouins pastured the flocks of their Babylonian masters. This "bank" or *kisad*, together with the corresponding western bank of the Tigris (according to Hommel the modern Shatt el-Hai), gave its name to the land of Cheshed, whence the *Kasdim* of the Old Testament. In the early inscriptions of Lagash the whole district is known as Gu-Edinna, the Sumerian equivalent of the Semitic *Kisad Edini*. The coast-land was similarly known as Gu-ābba (*Semitic Kisad tamtim*), the "bank of the sea." A more comprehensive name of southern Babylonia was Kengi, "the land," or Kengi Sumer, "the land of Sumer," for which Sumer alone came afterwards to be used. Sumer has been supposed to be the original of the Biblical Shinar; but Shinar represented northern rather than southern Babylonia, and was probably the Sankhar of the Tell el-Amarna tablets (but see *SUMER*). Opposed to Kengi and Sumer were Ura (Uri) and Akkad or northern Babylonia. The original meaning of *Ura* was perhaps "clayey soil," but it came to signify "the upper country" or "highlands," *kengi* being "the lowlands." In Semitic times *Ura* was pronounced *Uri* and confounded with *urs*, "city"; as a geographical term, however, it was replaced by Akkadu (Akkad), the Semitic form of Agadē—written Akkattim in the Elamite inscriptions—the name of the elder Sargon's capital, which must have stood close to Sippara, if indeed it was not a quarter of Sippara itself. The rise of Sargon's empire was doubtless the cause of this extension of the name of Akkad; from henceforward, in the imperial title,

"Sumer and Akkad" denoted the whole of Babylonia. After the Kassite conquest of the country, northern Babylonia came to be known as Kar-Duniyas, "the wall of the god Duniyas," from a line of fortification similar to that built by Nebuchadrezzar between Sippara and Opis, so as to defend his kingdom from attacks from the north. As this last was "the Wall of Semiramis" mentioned by Strabo (xi. 14. 8), Kar-Duniyas may have represented the Median Wall of Xenophon (*Anab. ii. 4. 12*), traces of which were found by F. R. Chesney extending from Faluja to Jibbar.

The country was thickly studded with towns, the sites of which are still represented by mounds, though the identification of most of them is still doubtful. The latest to be identified are Bismya, between Nippur and Erech, which recent American excavations have proved to be the site of Udab (also called Adab and Usab) and the neighbouring Fāra, the site of the ancient Kisurra. The dense population was due to the elaborate irrigation of the Babylonian plain which had originally reclaimed it from a pestiferous and uninhabitable swamp and had made it the most fertile country in the world. The science of irrigation and engineering seems to have been first created in Babylonia, which was covered by a network of canals, all skillfully planned and regulated. The three chief of them carried off the waters of the Euphrates to the Tigris above Babylon,—the Zabzallat canal (or *Nahr Sarsar*) running from Faluja to Ctesiphon, the Kutha canal from Sippara to Madain, passing Tell Ibrahim or Kutha on the way, and the King's canal or Ar-Malcha between the other two. This last, which perhaps owed its name to Khammurabi, was conducted from the Euphrates towards Upi or Opis, which has been shown by H. Winckler (*Altorientalische Forschungen*, ii. pp. 509 seq.) to have been close to Seleucia on the western side of the Tigris. The Pallacopas, called Pallukkatu in the Neo-Babylonian texts, started from Pallukkatu or Faluja, and running parallel to the western bank of the Euphrates as far as Iddaratu or Teredon (?) watered an immense tract of land and supplied a large lake near Borsippa. B. Meissner may be right in identifying it with "the Canal of the Sun-god" of the early texts. Thanks to this system of irrigation the cultivation of the soil was highly advanced in Babylonia. According to Herodotus (i. 193) wheat commonly returned two hundred-fold to the sower, and occasionally three hundred-fold. Pliny (*H. N.* xviii. 17) states that it was cut twice, and afterwards was good keep for sheep, and Berossus remarked that wheat, sesame, barley, ochrys, palms, apples and many kinds of shelled fruit grew wild, as wheat still does in the neighbourhood of Anah. A Persian poem celebrated the 360 uses of the palm (Strabo xvi. 1. 14), and Ammianus Marcellinus (xxiv. 3) says that from the point reached by Julian's army to the shores of the Persian Gulf was one continuous forest of verdure.

II. *Classical Authorities.*—Such a country was naturally fitted to be a pioneer of civilization. Before the decipherment of the cuneiform texts our knowledge of its history, however, was scanty and questionable. Had the native history of Berossus survived, this would not have been the case; all that is known of the Chaldaean historian's work, however, is derived from quotations in Josephus, Ptolemy, Eusebius and the Syncellus. The authenticity of his list of 10 antediluvian kings who reigned for 120 *sari* or 432,000 years, was but partially confirmed by the inscriptions; but his 8 postdiluvian dynasties are difficult to reconcile with the monuments, and the numbers attached to them are probably corrupt. It is different with the 7th and 8th dynasties as given by Ptolemy in the *Almagest*, which prove to have been faithfully recorded:—

1. Nabonassar (747 B.C.)	14 years
2. Nadios	2 "
3. Khinziros and Poros (Pul)	5 "
4. Hulaoos	5 "
5. Mardokempados (Merodach-Baladan)	12 "
6. Arkeanos (Sargon)	5 "
7. Interregnum	2 "
8. Haggias	1 month
9. Relfibos (702 B.C.)	3 years
10. Assaranadios (Assur-nadin-sum)	6 "

11. Rēgebelos	1 year
12. Mesēšimordakos	4 years
13. Interregnum	8 "
14. Asaridinūs (Esar-haddon)	13 "
15. Saodukhinos (Savul-sum-yukin)	20 "
16. Sinēladanos (Assur-bani-pal)	22 "

The account of Babylon given by Herodotus is not that of an eye-witness, and his historical notices are meagre and untrustworthy. He was controverted by Ctesias, who, however, has mistaken mythology for history, and Greek romance owed to him its Ninus and Semiramis, its Ninyas and Sardanapalus. The only ancient authority of value on Babylonian and Assyrian history is the Old Testament.

III. *Modern Discovery.*—The excavations of P. E. Botta and A. H. Layard at Nineveh opened up a new world, coinciding as they did with the successful decipherment of the cuneiform system of writing. Layard's discovery of the library of Assur-bani-pal put the materials for reconstructing the ancient life and history of Assyria and Babylonia into the hands of scholars. He also was the first to excavate in Babylonia, where C. J. Rich had already done useful topographical work. Layard's excavations in this latter country were continued by W. K. Loftus, who also opened trenches at Susa, as well as by J. Oppert on behalf of the French government. But it was only in the last quarter of the 19th century that anything like systematic exploration was attempted. After the death of George Smith at Aleppo in 1876, an expedition was sent by the British Museum (1877-1879), under the conduct of Hormuzd Rassam, to continue his work at Nineveh and its neighbourhood. Excavations in the mounds of Balawāt, called Imgur-Bel by the Assyrians, 15 m. east of Mosul, resulted in the discovery of a small temple dedicated to the god of dreams by Assur-nazir-pal III. (883 B.C.), containing a stone coffer or ark in which were two inscribed tables of alabaster of rectangular shape, as well as of a palace which had been destroyed by the Babylonians but restored by Shalmaneser II. (858 B.C.). From the latter came the bronze gates with hammered reliefs, which are now in the British Museum. The remains of a palace of Assur-nazir-pal III. at Nimrūd (Calah) were also excavated, and hundreds of enamelled tiles were disinterred. Two years later (1880-1881) Rassam was sent to Babylonia, where he discovered the site of the temple of the sun-god of Sippara at Abu-Habba, and so fixed the position of the two Sipparas or Sepharvaim. Abu-Habba lies south-west of Bagdad, midway between the Euphrates and Tigris, on the south side of a canal, which may once have represented the main stream of the Euphrates, Sippara of the goddess Anunit, now *Dēr*, being on its opposite bank.

Meanwhile (1877-1881) the French consul, de Sarzec, had been excavating at Tello, the ancient Lagash, and bringing to light monuments of the pre-Semitic age, which included the diorite statues of Gudea now in the Louvre, the stone of which, according to the inscriptions upon them, had been brought from Magan, the Sinaitic peninsula. The subsequent excavations of de Sarzec in Tello and its neighbourhood carried the history of the city back to at least 4000 B.C., and a collection of more than 30,000 tablets has been found, which were arranged on shelves in the time of Gudea (c. 2700 B.C.). In 1886-1887 a German expedition under Dr Koldewey explored the cemetery of El Hibba (immediately to the south of Tello), and for the first time made us acquainted with the burial customs of ancient Babylonia. Another German expedition, on a large scale, was despatched by the *Orienteingesellschaft* in 1899 with the object of exploring the ruins of Babylon; the palace of Nebuchadrezzar and the great processional road were laid bare, and Dr W. Andrae subsequently conducted excavations at Qal'at Sherqat, the site of Assur. Even the Turkish government has not held aloof from the work of exploration, and the Museum at Constantinople is filled with the tablets discovered by Dr V. Scheil in 1897 on the site of Sippara. J. de Morgan's exceptionally important work at Susa lies outside the limits of Babylonia; not so, however, the American excavations (1903-1904) under E. J. Banks at Bismya (Udab), and those of the university of Pennsylvania at Niffer (see NIFFUR) first begun in 1889, where Mr J. H. Haynes

has systematically and patiently uncovered the remains of the great temple of El-il, removing layer after layer of debris and cutting sections in the ruins down to the virgin soil. Midway in the mound is a platform of large bricks stamped with the names of Sargon of Akkad and his son Naram-Sin (3800 B.C.); as the debris above them is 34 ft. thick, the topmost stratum being not later than the Parthian era (H. V. Hilprecht, *The Babylonian Expedition*, i. 2, p. 23), it is calculated that the debris underneath the pavement, 30 ft. thick, must represent a period of about 3000 years, more especially as older constructions had to be levelled before the pavement was laid. In the deepest part of the excavations, however, inscribed clay tablets and fragments of stone vases are still found, though the cuneiform characters upon them are of a very archaic type, and sometimes even retain their primitive pictorial forms.

IV. *Chronology.*—The latter chronology of Assyria has long been fixed, thanks to the lists of *limmi*, or archons, who gave their names in succession to their years of office. Several copies of these lists from the library of Nineveh are in existence, the earliest of which goes back to 911 B.C., while the latest comes down to the middle of the reign of Assur-bani-pal. The beginning of a king's reign is noted in the lists, and in some of them the chief events of the year are added to the name of its archon. Assyrian chronology is, therefore, certain from 911 B.C. to 666, and an eclipse of the sun which is stated to have been visible in the month Sivan, 763 B.C., is one that has been calculated to have taken place on the 15th of June of that year. The system of reckoning time by *limmi* was of Assyrian origin, and recent discoveries have made it clear that it went back to the first days of the monarchy. Even in the distant colony at Kara Euyuk near Kansiriyeh (Caesarea) in Cappadocia cuneiform tablets show that the Assyrian settlers used it in the 15th century B.C. In Babylonia a different system was adopted. Here the years were dated by the chief events that distinguished them, as was also the case in Egypt in the epoch of the Old Empire. What the event should be was determined by the government and notified to all its officials; one of these notices, sent to the Babylonian officials in Canaan in the reign of Samsuiluna, the son of Khammurabi, has been found in the Lebanon. A careful register of the dates was kept, divided into reigns, from which dynastic lists were afterwards compiled, giving the duration of each king's reign as well as that of the several dynasties. Two of these dynastic compilations have been discovered, unfortunately in an imperfect state.¹ In addition to the chronological tables, works of a more ambitious and literary character were also attempted of the nature of chronicles. One of these is the so-called "Synchronous History of Assyria and Babylonia," consisting of brief notices, written by an Assyrian, of the occasions on which the kings of the two countries had entered into relation, hostile or otherwise, with one another; a second is the *Babylonian Chronicle* discovered by Dr Th. G. Pinches, which gave a synopsis of Babylonian history from a Babylonian point of view, and was compiled in the reign of Darius. It is interesting to note that its author says of the battle of Khalūl, which we know from the Assyrian inscriptions to have taken place in 691 or 690 B.C., that he does "not know the year" when it was fought: the records of Assyria had been already lost, even in Babylonia. The early existence of an accurate system of dating is not surprising; it was necessitated by the fact that Babylonia was a great trading community, in which it was not only needful that commercial and legal documents should be dated, but also that it should be possible to refer easily to the dates of former business transactions. The Babylonian and Assyrian kings had consequently no difficulty in

¹ For a survey of the chronological systems adopted by different modern scholars, see below, section viii. ² Chronological Systems."
² The compiler of the more complete one seems to have allowed himself liberties. At all events he gives 30 years of reign to Sinsuballid instead of the 20 assigned to him in a list of dates drawn up at the time of Ammi-zadok's accession, 55 years to Khammurabi instead of 43, and 35 years to Samsuiluna instead of 38, while he omits altogether the seven years' reign of the Assyrian king Tukulti-In-arišti at Babylon.

determining the age of their predecessors or of past events. Nabonidus (Nabunaid), who was more of an antiquarian than a politician, and spent his time in excavating the older temples of his country and ascertaining the names of their builders, tells us that Naram-Sin, the son of Sargon of Akkad, lived 3200 years before himself (*i.e.* 3750 B.C.), and Sagarakti-surysa 800 years; and we learn from Sennacherib that Shalmaneser I. reigned 600 years earlier, and that Tiglath-pileser I. fought with Merodach-nadin-akhi (Marduk-nadin-akhe) of Babylon 478 years before the campaign of 680 B.C.; while, according to Tiglath-pileser I., the high-priest Samas-Hadad, son of Isme-Dagon, built the temple of Anu and Hadad at Assur 701 years before his own time. Shalmaneser I. in his turn states that the high-priest Samas-Hadad, the son of Bel-kabi, governed Assur 580 years previously, and that 159 years before this the high-priest Erisum was reigning there. The raid of the Elamite king Kutur-Nakhkhunté is placed by Assur-bani-pal 1635 years before his own conquest of Susa, and Khammurabi is said by Nabonidus to have preceded Burna-buryas by 700 years.

V. History.—In the earliest period of which we have any knowledge Babylonia was divided into several independent states, the limits of which were defined by canals and boundary stones. Its culture may be traced back to two main centres, Eridu in the south and Nippur in the north. But the streams of civilization which flowed from them were in strong contrast. El-il, around whose sanctuary Nippur had grown up, was lord of the ghost-land, and his gifts to mankind were the spells and incantations which the spirits of good or evil were compelled to obey. The world which he governed was a mountain; the creatures whom he had made lived underground. Eridu, on the other hand, was the home of the culture-god Ea, the god of light and beneficence, who employed his divine wisdom in healing the sick and restoring the dead to life. Rising each morning from his palace in the deep, he had given man the arts and sciences, the industries and manners of civilization. To him was due the invention of writing, and the first law-book was his creation. Eridu had once been a seaport, and it was doubtless its foreign trade and intercourse with other lands which influenced the development of its culture. Its cosmology was the result of its geographical position: the earth, it was believed, had grown out of the waters of the deep, like the ever-widening coast at the mouth of the Euphrates. Long before history begins, however, the cultures of Eridu and Nippur had coalesced. While Babylon seems to have been a colony of Eridu, Ur, the immediate neighbour of Eridu, must have been colonized from Nippur, since its moon-god was the son of El-il of Nippur. But in the admixture of the two cultures the influence of Eridu was predominant.

We may call the early civilization of Babylonia Sumerian. The race who first developed it spoke an agglutinative language, and to them was due the invention of the pictorial hieroglyphs which became the running-hand or cuneiform characters of later days, as well as the foundation of the chief cities of the country and the elements of its civilization. The great engineering works by means of which the marshes were drained and the overflow of the rivers regulated by canals went back to Sumerian times, like a considerable part of later Babylonian religion and the beginnings of Babylonian law. Indeed Sumerian continued to be the language of religion and law long after the Semites had become the ruling race.

Arrival of the Semites.—When the Semites first entered the Eden or plain of Babylonia is uncertain, but it must have been at a remote period. The cuneiform system of writing

was still in process of growth when it was borrowed and adapted by the new comers, and the Sumerian Babylonian language was profoundly influenced by the older language of the country, borrowing its words and even its grammatical usages. Sumerian in its turn borrowed from Semitic Babylonian, and traces of Semitic influence in some of the earliest Sumerian texts indicate that the Semite was already on the Babylonian border. His native home was probably Arabia; hence Eridu ("the good city") and Ur ("the city")

would have been built in Semitic territory, and their population may have included Semitic elements from the first. It was in the north, however, that the Semites first appear on the monuments. Here in Akkad the first Semitic empire was founded, Semitic conquerors or settlers spread from Sippara to Susa, Khana to the east of the Tigris was occupied by "West Semitic" tribes, and "out of" Babylonia "went forth the Assyrian." As in Assyria, so too in the states of Babylonia the *patesi* or high-priest of the god preceded the king. The state had grown up around a sanctuary, the god of which was nominally its ruler, the human *patesi* being his viceregent. In course of time many of the high-priests assumed the functions and title of king; while retaining their priestly office they claimed at the same time to be supreme in the state in all secular concerns. The god remained nominally at its head; but even this position was lost to him when Babylonia was unified under Semitic princes, and the earthly king became an incarnate god. A recollection of his former power survived, however, at Babylon, where Bel-Merodach adopted the king before his right to rule was allowed.

Early Princes.—The earliest monuments that can be approximately dated come from Lagash (Tello). Here we hear of a "king of Kengi," as well as of a certain Me-silim, king of Kis, who had dealings with Lugal-sugur, high-priest of Lagash, and the high-priest of a neighbouring town, the name of which is provisionally transcribed Gis-ukh (formerly written Gis-ban and confounded with the name of Opis). According to Scheil, Gis-ukh is represented by Jokha, south of Fāra and west of the Shatt el-Hai, and since two of its rulers are called kings of Tē on a seal-cylinder, this may have been the pronunciation of the name.¹ At a later date the high-priests of Lagash made themselves kings, and a dynasty was founded there by Ur-Ninā. In the ruins of a building, attached by him to the temple of Ninā, terra-cotta bas-reliefs of the king and his sons have been found, as well as the heads of lions in onyx, which remind us of Egyptian work and onyx patesis. These were "booty" dedicated to the goddess Bau. E-anna-du, the grandson of Ur-Ninā, made himself master of the whole of southern Babylonia, including "the district of Sumer" together with the cities of Erech, Ur and Larsa (?). He also annexed the kingdom of Kis, which, however, recovered its independence after his death. Gis-ukh was made tributary, a certain amount of grain being levied upon each person in it, which had to be paid into the treasury of the goddess Ninā and the god Ingurisa. The so-called "Stele of the Vultures," now in the Louvre, was erected as a monument of the victory. On this various incidents in the war are represented. In one scene the king stands in his chariot with a curved weapon in his right hand formed of three bars of metal bound together by rings (similar, as M. L. Heuzey has pointed out, to one carried by the chief of an Asiatic tribe in a tomb of the 12th dynasty at Beni-Hasan in Egypt), while his killed followers with helmets on their heads and lances in their hands march behind him. In another a flock of vultures is feeding on the bodies of the fallen enemy; in a third a tumulus is being heaped up over those who had been slain on the side of Lagash. Elsewhere we see the victorious prince beating down a vanquished enemy, and superintending the execution of other prisoners who are being sacrificed to the gods, while in one curious scene he is striking with his mace a sort of wicker-work cage filled with naked men. In his hand he holds the crest of Lagash and its god—a lion-headed eagle with outstretched wings, supported by two lions which are set heraldischally back to back. The sculptures belong to a primitive period of art.

E-anna-du's campaigns extended beyond the confines of Babylonia. He overran a part of Elam and took the city of Az on the Persian Gulf. Temples and palaces were repaired or erected at Lagash and elsewhere, the town of Ninā—which probably gave

¹ They are also called high-priests of Gunammidē and a contract-tablet speaks of "Tē in Babylon," but this was probably not the Tē of the seal. It must be remembered that the reading of most of the early Sumerian proper names is merely provisional, as we do not know how the ideographs of which they are composed were pronounced in either Sumerian or Assyrian.

Early Sumerian period.

Ur-ninā dynasty.

its name to the later Ninā or Nineveh—was rebuilt, and canals and reservoirs were excavated. He was succeeded by his brother En-anna-tum I., under whom Gis-ukh once more became the dominant power. As En-anna-tum has the title only of high-priest, it is probable that he acknowledged Ur-lumma of Gis-ukh as his suzerain. His son and successor Entemena restored the prestige of Lagash. Gis-ukh was subdued and a priest named Illi was made its governor. A tripod of silver dedicated by Entemena to his god is now in the Louvre. A frieze of lions devouring ibexes and deer, and incised with great artistic skill, runs round the neck, while the eagle crest of Lagash adorns the globular part. The vase is a proof of the high degree of excellence to which the goldsmith's art had already attained. A vase of calcite, also dedicated by Entemena, has been found at Nippur.

The eighth successor of Ur-Ninā was Uru-duggina, who was overthrown and his city captured by Lugal-zaggisi, the high-priest of Gis-ukh. Lugal-zaggisi was the founder of the first empire in Asia of which we know. He made Erech his capital and calls himself king of Kengi. In a long inscription which he caused to be engraved on hundreds of stone vases dedicated to El-il of Nippur, he declares that his kingdom extended "from the Lower Sea of the Tigris and Euphrates," or Persian Gulf, to "the Upper Sea" or Mediterranean. It was at this time that Erech received the name of "the City," which it continued to bear when written ideographically.

Semitic Empire of Sargon of Akkad.—The next empire founded in western Asia was Semitic. Semitic princes had already established themselves at Kis, and a long inscription **Sargon.** has been discovered at Susa by J. de Morgan, belonging to one of them, Manishtusu, who like Lugal-zaggisi was a contemporary of Uru-duggina. Another Semitic ruler of Kis of the same period was Alusarsid (or Urumus) who "subdued Elam and Barahshé." But the fame of these early establishers of Semitic supremacy was far eclipsed by that of Sargon of Akkad and his son, Naram-Sin. The date of Sargon is placed by Nabonidus at 3800 B.C. He was the son of Itti-Bel, and a legend related how he had been born in concealment and sent adrift in an ark of bulrushes on the waters of the Euphrates. Here he had been rescued and brought up by "Akki the husbandman"; but the day arrived at length when his true origin became known, the crown of Babylonia was set upon his head and he entered upon a career of foreign conquest. Four times he invaded Syria and Palestine, and spent three years in thoroughly subduing the countries of "the west," and in uniting them with Babylonia "into a single empire." Images of himself were erected on the shores of the Mediterranean in token of his victories, and cities and palaces were built at home out of the spoils of the conquered lands. Elam and the northern part of Mesopotamia were also subjugated, and rebellions were put down both in Kazalla and in Babylonia itself. Contract tablets have been found dated in the years of the campaigns against Palestine and Sarlak, king of Gutium or Kurdistan, and copper is mentioned as being brought from Magan or the Sinaitic peninsula.

Sargon's son and successor, Naram-Sin, followed up the successes of his father by marching into Magan, whose king he took captive. He assumed the imperial title of "king of the four zones," and, like his father, was addressed as a god. He is even called "the god of Agadé" (Akkad), reminding us of the divine honours claimed by the Pharaohs of Egypt, whose territory now adjoined that of Babylonia. A finely executed bas-relief, representing Naram-Sin, and bearing a striking resemblance to early Egyptian art in many of its features, has been found at Diarbekr. Babylonian art, however, had already attained a high degree of excellence; two seal cylinders of the time of Sargon are among the most beautiful specimens of the gem-cutter's art ever discovered. The empire was bound together by roads, along which there was a regular postal service; and clay seals, which took the place of stamps, are now in the Louvre bearing the names of Sargon and his son. A cadastral survey seems also to have been instituted, and one of the documents relating to it states that a certain Uru-Malik, whose name appears to indicate his Canaanitish origin, was

governor of the land of the Amorites, as Syria and Palestine were called by the Babylonians. It is probable that the first collection of astronomical observations and terrestrial omens was made for a library established by Sargon.

Bingani-sar-ali was the son of Naram-Sin, but we do not yet know whether he followed his father on the throne. Another son was high-priest of the city of Tutu, and in the name of his daughter, Lipus-Eaum, a priestess of Sin, some scholars have seen that of the Hebrew deity Yahweh.

*Ur
dynasty.*

The Babylonian god Ea, however, is more likely to be meant. The fall of Sargon's empire seems to have been as sudden as its rise. The seat of supreme power in Babylonia was shifted southwards to Isin and Ur. It is generally assumed that two dynasties reigned at Ur and claimed suzerainty over the other Babylonian states, though there is as yet no clear proof that there was more than one. It was probably Gungunu who succeeded in transferring the capital of Babylonia from Isin to Ur, but his place in the dynasty (or dynasties) is still uncertain. One of his successors was Ur-Gur, a great builder, who built or restored the temples of the Moon-god at Ur, of the Sun-god at Larsa, of Ishtar at Erech and of Bel at Nippur. His son and successor was Dungi, whose reign lasted more than 51 years, and among whose vassals was Gudea, the *patesi* or high-priest of Lagash. Gudea was also a great builder, and the materials for his buildings and statues were brought from all parts of western Asia, cedar wood from the Amanus mountains, quarried stones from Lebanon, copper from northern Arabia, gold and precious stones from the desert between Palestine and Egypt, dolerite from Magan (the Sinaitic peninsula) and timber from Dilmun in the Persian Gulf. Some of his statues, now in the Louvre, are carved out of Sinaitic dolerite, and on the lap of one of them (statue E) is the plan of his palace, with the scale of measurement attached. Six of the statues bore special names, and offerings were made to them as to the statues of the gods. Gudea claims to have conquered Anshan in Elam, and was succeeded by his son Ur-Ningirsu. His date may be provisionally fixed at 2700 B.C.

This dynasty of Ur was Semitic, not Sumerian, notwithstanding the name of Dungi. Dungi was followed by Bur-Sin, Gimil-Sin, and Ibi-Sin. Their power extended to the Mediterranean, and we possess a large number of contemporaneous monuments in the shape of contracts and similar business documents, as well as chronological tables, which belong to their reigns.

After the fall of the dynasty, Babylonia passed under foreign influence. Sumuabi ("Shem is my father"), from southern Arabia (or perhaps Canaan), made himself master of northern Babylonia, while Elamite invaders occupied the south. After a reign of 14 years Sumuabi was succeeded by his son Sumu-la-ilu, in the fifth year of whose reign the fortress of Babylon was built, and the city became for the first time a capital. Rival kings, Pungunila and Immerum, are mentioned in the contract tablets as reigning at the same time as Sumu-la-ilu (or Samu-la-ilu); and under Sin-muballidh, the great-grandson of Sumu-la-ilu, the Elamites laid the whole of the country under tribute, and made Eri-Aku or Arioch, called Rim-Sin by his Semitic subjects, king of Larsa. Eri-Aku was the son of Kudur-Mabug, who was prince of Yamutbal, on the eastern border of Babylonia, and also "governor of Syria." The Elamite supremacy was at last shaken off by the son and successor of Sin-muballidh, Khammurabi, whose name is also written Ammurabi and Khammuram. and who was the Amraphel of Gen. xiv. 1.

*Kham-
murabi.*

The Elamites, under their king Kudur-Lagamar or Chedor-laomer, seem to have taken Babylon and destroyed the temple of Bel-Merodach; but Khammurabi retrieved his fortunes, and in the thirtieth year of his reign (in 2340 B.C.) he overthrew the Elamite forces in a decisive battle and drove them out of Babylonia. The next two years were occupied in adding Larsa and Yamutbal to his dominion, and in forming Babylonia into a single monarchy, the head of which was Babylon. A great literary revival followed the recovery of Babylonian independence, and the rule of Babylon was obeyed as far as the shores of the Mediterranean. Vast numbers of contract tablets, dated in the reigns of Khammurabi and other kings of the dynasty, have

been discovered, as well as autograph letters of the kings themselves, more especially of Khammurabi. Among the latter is one ordering the despatch of 240 soldiers from Assyria and Sittulum, a proof that Assyria was at the time a Babylonian dependency. Constant intercourse was kept up between Babylonia and the west, Babylonian officials and troops passing to Syria and Canaan, while "Amorite" colonists were established in Babylonia for the purposes of trade. One of these Amorites, Abi-raman or Abram by name, is the father of a witness to a deed dated in the reign of Khammurabi's grandfather. Ammi-ditana, the great-grandson of Khammurabi, still entitles himself "king of the land of the Amorites," and both his father and son bear the Canaanitish (and south Arabian) names of Abesukh or Abishua and Ammi-zadok.

One of the most important works of this "First Dynasty of Babylon," as it was called by the native historians, was the compilation of a code of laws (see BABYLONIAN LAW). This was made by order of Khammurabi after the expulsion of the Elamites and the settlement of his kingdom. A copy of the Code has been found at Susa by J. de Morgan and is now in the Louvre. The last king of the dynasty was Samsu-ditana the son of Ammi-zadok. He was followed by a dynasty of 11 Sumerian kings, who are said to have reigned for 368 years, a number which must be much exaggerated. As yet the name of only one of them has been found in a contemporaneous document. They were overthrown and Babylonia was conquered by Kassites or Kossaeans from the mountains of Elam, with whom Samsu-iluna had already come into conflict in his 9th year. The Kassite dynasty was founded by Kandis, Gandis or Gaddas (about 1780 B.C.), and lasted for 576 years. Under this foreign dominion, which offers a striking analogy to the contemporary rule of the Hyksos in Egypt, Babylonia lost its empire over western Asia, Syria and Palestine became independent, and the high-priests of Assur made themselves kings of Assyria. The divine attributes with which the Semitic kings of Babylonia had been invested disappeared at the same time; the title of "god" is never given to a Kassite sovereign. Babylon, however, remained the capital of the kingdom and the holy city of western Asia, where the priests were all-powerful, and the right to the inheritance of the old Babylonian empire could alone be conferred.

Rise of Assyria.—Under Khammurabi a Samsi-Hadad (or Samsi-Raman) seems to have been vassal-prince at Assur, and the names of several of the high-priests of Assur who succeeded him have been made known to us by the recent German excavations. The foundation of the monarchy was ascribed to Zulilu, who is described as living after Bel-kapapi or Belkabi (1900 B.C.), the ancestor of Shalmaneser I. Assyria grew in power at the expense of Babylonia, and a time came when the Kassite king of Babylonia was glad to marry the daughter of Assur-yuballdih of Assyria, whose letters to Amenophis (Amon-hotep) IV. of Egypt have been found at Tell el-Amarna. The marriage, however, led to disastrous results, as the Kassite faction at court murdered the king and placed a pretender on the throne. Assur-yuballdih promptly marched into Babylonia and avenged his son-in-law, making Burna-buryas of the royal line king in his stead. Burna-buryas, who reigned 22 years, carried on a correspondence with Amenophis IV. of Egypt. After his death, the Assyrians, who were still nominally the vassals of Babylonia, threw off all disguise, and Shalmaneser I. (1300 B.C.), the great-grandson of Assur-yuballdih, openly claimed the supremacy in western Asia. Shalmaneser was the founder of Calah, and his annals, which have recently been discovered at Assur, show how widely extended the Assyrian empire already was. Campaign after campaign was carried on against the Hittites and the wild tribes of the north-west, and Assyrian colonists were settled in Cappadocia. His son Tukulti-In-risti conquered Babylon, putting its king Bitiliasu to death, and thereby made Assyria the mistress of the oriental world. Assyria had taken the place of Babylonia.

For 7 years Tukulti-In-risti ruled at Babylon with the old imperial title of "king of Sumer and Akkad." Then the Babylonians revolted. The Assyrian king was murdered by his

son, Assur-nazir-pal I., and Hadad-nadin-akhi made king of Babylonia. But it was not until several years later, in the reign of the Assyrian king Tukulti-Assur, that a reconciliation was effected between the two rival kingdoms. The next Assyrian monarch, Bel-kudur-uzur, was the last of the old royal line. He seems to have been slain fighting against the Babylonians, who were still under the rule of Hadad-nadin-akhi, and a new dynasty was established at Assur by In-risti-pikeser, who claimed to be a descendant of the ancient prince Erba-Raman. His fourth successor was Tiglath-pileser I., one of the great conquerors of Assyria, who carried his arms towards Armenia on the north and Cappadocia on the west; he hunted wild bulls in the Lebanon and was presented with a crocodile by the Egyptian king. In 1107 B.C., however, he sustained a temporary defeat at the hands of Merodach-nadin-akhi (Marduk-nadin-akhe) of Babylonia, where the Kassite dynasty had finally succumbed to Elamite attacks and a new line of kings was on the throne.

Of the immediate successors of Tiglath-pileser I. we know little, and it is with Assur-nazir-pal III. (883-858 B.C.) that our knowledge of Assyrian history begins once more to be fairly full. The empire of Assyria was again extended in all directions, and the palaces, temples and other buildings raised by him bear witness to a considerable development of wealth and art. Calah became the favourite residence of a monarch who was distinguished even among Assyrian conquerors for his revolting cruelties. His son Shalmaneser II. had a long reign of 35 years, during which the Assyrian capital was converted into a sort of armed camp. Each year the Assyrian armies marched out of it to plunder and destroy. Babylon was occupied and the country reduced to vassalage. In the west the confederacy of Syrian princes headed by Benhadad of Damascus and including Ahab of Israel (see Jews, § 10) was shattered in 853 B.C., and twelve years later the forces of Hazael were annihilated and the ambassadors of Jehu of Samaria brought tribute to "the great king." The last few years of his life, however, were disturbed by the rebellion of his eldest son, which well-nigh proved fatal. Assur, Arbela and other places joined the pretender, and the revolt was with difficulty put down by Samsi-Raman (or Samsi-Hadad), Shalmaneser's second son, who soon afterwards succeeded him (824 B.C.). In 804 B.C. Damascus was captured by his successor Hadad-nirari IV., to whom tribute was paid by Samaria.

With Nabu-nazir, the Nabonassar of classical writers, the so-called Canon of Ptolemy begins. When he ascended the throne of Babylon in 747 B.C. Assyria was in the throes of a revolution. Civil war and pestilence were devastating the country, and its northern provinces had been wrested from it by Ararat. In 746 B.C. Calah joined the rebels, and on the 13th of Iyyar in the following year, Pulu or Pul, who took the name of Tiglath-pileser III., seized the crown and inaugurated a new and vigorous policy.

Second Assyrian Empire.—Under Tiglath-pileser III. arose the second Assyrian empire, which differed from the first in its greater consolidation. For the first time in history the idea of centralization was introduced into politics; the conquered provinces were organized under an elaborate bureaucracy at the head of which was the king, each district paying a fixed tribute and providing a military contingent. The Assyrian forces became a standing army, which, by successive improvements and careful discipline, was moulded into an irresistible fighting machine, and Assyrian policy was directed towards the definite object of reducing the whole civilized world into a single empire and thereby throwing its trade and wealth into Assyrian hands. With this object, after terrorizing Armenia and the Medes and breaking the power of the Hittites, Tiglath-pileser III. secured the high-roads of commerce to the Mediterranean together with the Phoenician seaports and then made himself master of Babylonia. In 729 B.C. the summit of his ambition was attained, and he was invested with the sovereignty of Asia in the holy city of Babylon. Two years later, in Tebet

Tiglath-pileser I.

Assur-nazir-pal III.

Shalmaneser II.

Nabu-nazir.

Tiglath-pileser III.

Shalmaneser I.



STELE OF VICTORY OF NARAM-SIN, KING OF AGADE. Louvre.



FIGURE OF GUDEA, PATESI OF LAGASH. Louvre.



FROM STELE ENGRAVED WITH KHAMMURABI CODE OF LAWS.



COPPER VOTIVE FIGURE OF ARAD-SIN, KING OF LARSA.



BOUNDARY-STONE SCULPTURED WITH EMBLEMS OF THE GODS; REIGN OF NEBUCHADREZZAR I.



COLOSSAL WINGED AND HUMAN-HEADED LION FROM THE PALACE OF ASSUR-NAZIR-PAL.



STATUE OF ASSUR-NAZIR-PAL, KING OF ASSYRIA.



RELIEF REPRESENTING ASSUR-BANI-PAL SPEARING A LION.



FIGURE OF A DYING LION, FROM THE LION-HUNT RELIEFS OF ASSUR-BANI-PAL.



STATUE OF THE GOD NEBO-NIRARI III.



SCULPTURED RELIEF OF THE REIGN OF ASSUR-NAZIR-PAL.



ARCHITECTURAL ORNAMENTS OF PAINTED TERRA-COTTA; FROM NIMRUD.



SCULPTURED RELIEF OF THE REIGN OF ASSUR-BANI-PAL.



IVORY PANELS WITH LINE ENGRAVING; FROM NIMRUD.



SECTION OF BRONZE SHEATHING FROM GATES OF SHALMANESER II.



PORTION OF SCULPTURED PAVING SLAB FROM A DOORWAY IN ASSUR-BANI-PAL'S PALACE AT KUYUNJIK (NINEVEH).



BRONZE LION-WEIGHT.



STAMPED BRICK-INSRIPTION OF PUR-SIN, KING OF UR.

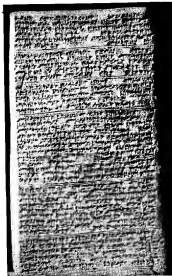

LETTER FROM TUSHRATTA, KING OF MITANI, TO AMENOPHIS III.



PRISM OF SENNACHERIB.



TABLET FROM ASSUR-BANI-PAL'S LIBRARY.

SPECIMENS OF BABYLONIAN AND ASSYRIAN WRITING.

Photos. Mansueti & Co.

727 B.C.; he died, but his successor Ululā, who took the name of Shalmaneser IV., continued the policy he had begun. Shalmaneser died suddenly in Tebet 722 B.C., while pressing the siege of Samaria, and the seizure of the throne by another general, Sargon, on the 12th of the month, gave the Babylonians an opportunity to revolt. In Nisan the Kaldā prince, Merodach (Marduk)-baladan, entered Babylon and was there crowned legitimate king. For twelve years he successfully resisted the Assyrians; but the failure of his allies in the west to act in concert with him, and the overthrow of the Elamites, eventually compelled him to fly to his ancestral domains in the marshes of southern Babylonia. Sargon, who meanwhile had crushed the confederacy of the northern nations, had taken (717 B.C.) the Hittite stronghold of Carchemish and had annexed the future kingdom of Ecbatana, was now accepted as king by the Babylonian priests and his claim to be the successor of Sargon of Akkad acknowledged up to the time of his murder in 705 B.C. His son Sennacherib, who succeeded him on the 12th of Ab, did not possess the military or administrative abilities of his father, and the success of his reign was not commensurate with the vanity of the ruler. He was never crowned at Babylon, which was in a perpetual state of revolt until, in 609 B.C., he shocked the religious and political conscience of Asia by razing the holy city of Babylon to the ground. His campaign against Hezekiah of Judah was as much a failure as his policy in Babylonia, and in his murder by his sons on the 20th of Tebet 681 B.C. both Babylonians and Jews saw the judgment of heaven.

Esar-haddon, who succeeded him, was of different calibre from his father. He was commanding the army in a campaign against Ararat at the time of the murder; forty-two days later the murderers fled from Nineveh and took refuge at the court of Ararat. But the Armenian army was utterly defeated near Malatia on the 12th of Iyyar, and at the end of the day Esar-haddon was saluted by his soldiers as king. He thereupon returned to Nineveh and on the 8th of Sivan formally ascended the throne.

One of his first acts was to restore Babylon, to send back the image of Bel-Merodach (Bel-Marduk) to its old home, and to re-people the city with such of the priests and the former population as had survived massacre. Then he was solemnly declared king in the temple of Bel-Merodach, which had again risen from its ruins, and Babylon became the second capital of the empire. Esar-haddon's policy was successful and Babylonia remained contentedly quiet throughout his reign. In February (764 B.C.) the Assyrians entered upon their invasion of Egypt (see also *EGYPT: History*), and in Nisan (or March) 670 B.C. an expedition on an unusually large scale set out from Nineveh. The Egyptian frontier was crossed on the 3rd of Tammuz (June), and Tirhaka, at the head of the Egyptian forces, was driven to Memphis after fifteen days of continuous fighting, during which the Egyptians were thrice defeated with heavy loss and Tirhaka himself was wounded. On the 22nd of the month Memphis was entered by the victorious army and Tirhaka fled to the south. A stele, commemorating the victory and representing Tirhaka with the features of a negro, was set up at Sinjirli (north of the Gulf of Antioch) and is now in the Berlin Museum. Two years later (668 B.C.) Egypt revolted, and while on the march to reduce it, Esar-haddon fell ill and died (on the 10th of Marchesvan or

October). Assur-bani-pal succeeded him as king of Assyria and its empire, while his brother, Samas-sum-yukin, was made viceroy of Babylonia. The arrangement was evidently intended to flatter the Babylonians by giving them once more the semblance of independence. But it failed to work. Samas-sum-yukin became more Babylonian than his subjects; the viceroy claimed to be the successor of the monarchs whose empire had once stretched to the Mediterranean; even the Sumerian language was revived as the official tongue, and a revolt broke out which shook the Assyrian empire to its foundations. After several years of struggle, during which Egypt recovered its independence, Babylon was starved into surrender, and the rebel viceroy and his supporters were put to death.

Egypt had already recovered its independence (660 B.C.) with the help of mercenaries sent by Gyges of Lydia, who had vainly solicited aid from Assyria against his Cimmerian enemies. Next followed the contest with Elam, in spite of the efforts of Assur-bani-pal to ward it off. Assyria, however, was aided by civil war in Elam itself; the country was wasted with fire and sword, and its capital Susa or Shushan levelled with the ground. But the long struggle left Assyria maimed and exhausted. It had been drained of both wealth and fighting population; the devastated provinces of Elam and Babylonia could yield nothing with which to supply the needs of the imperial exchequer, and it was difficult to find sufficient troops even to garrison the conquered populations. Assyria, therefore, was ill prepared to face the hordes of Scythians—or Manda, as they were called by the Babylonians—who now began to harass the frontiers. A Scythian power had grown up in the old kingdom of Ellip, to the east of Assyria, where Ecbatana was built by a "Manda" prince; Asia Minor was infested by the Scythian tribe of Cimmerians, and the death of the Scythian leader Dugdammē (the Lygdamis of Strabo i. 3. 16) was regarded by Assur-bani-pal as a special mark of divine favour.

When Assur-bani-pal died, his empire was fast breaking up. Under his successor, Assur-etil-ilani, the Scythians penetrated into Assyria and made their way as far as the borders of Egypt. Calah was burned, though the strong walls of Nineveh protected the relics of the Assyrian army which had taken refuge behind them; and when the raiders had passed on to other fields of booty, a new palace was erected among the ruins of the neighbouring city. But its architectural poverty and small size show that the resources of Assyria were at a low ebb. A contract has been found at Sippara, dated in the fourth year of Assur-etil-ilani, though it is possible that his rule in Babylonia was disputed by his Rab-shakch (vizier), Assur-sum-lisir, whose accession year as king of Assyria occurs on a contract from Nipper (Niffer). The last king of Assyria was probably the brother of Assur-etil-ilani, Sin-sar-iskun (Sin-sarra-uzur), who seems to have been the Sarakos (Sarakus) of Berossus. He was still reigning in Babylonia in his seventh year, as a contract dated in that year has been discovered at Erech, and an inscription of his, in which he speaks of restoring the ruined temples and their priests, couples Merodach of Babylon with Assur of Nineveh. Babylonia, however, was again restless. After the overthrow of Samas-sum-yukin, Kandalanu, the Chineladanos of Ptolemy's canon, had been appointed viceroy. His successor was Nabopolassar, between whom and the last king of Assyria war broke out. The Scythian king of Ecbatana, the Cyaxares of the Greeks, came to the help of the Babylonians. Nineveh was captured and destroyed by the Scythian army, along with those cities of northern Babylonia which had sided with Babylonia, and the Assyrian empire was at an end.

The seat of empire was now transferred to Babylonia. Nabopolassar was followed by his son Nebuchadrezzar II., whose reign of 43 years made Babylon once more the mistress of the civilized world. Only a small fragment of his annals has been discovered relating to his invasion of Egypt in 567 B.C., and referring to "Phut of the Ionians." Of the reign of the last Babylonian king, Nabonidus, however, and the conquest of Babylonia by Cyrus, we now have a fair amount of information.¹ This is chiefly derived from a chronological tablet containing the annals of Nabonidus, which is supplemented by an inscription of Nabonidus, in which he recounts his restoration of the temple of the Moon-god at Harran, as well as by a proclamation of Cyrus issued shortly after his formal recognition as king of Babylonia. It was in the sixth year of Nabonidus (549 B.C.)—or perhaps in 553—that Cyrus, "king of Anshan" in Elam, revolted against his suzerain Astyages, king of "the Manda" or Scythians, at Ecbatana. The army of Astyages betrayed him to his enemy, and Cyrus (*q.v.*) established himself at Ecbatana, thus putting an end to the empire of the Scythians,

which had taken refuge behind them; and when the raiders had passed on to other fields of booty, a new palace was erected among the ruins of the neighbouring city. But its architectural poverty and small size show that the resources of Assyria were at a low ebb. A contract has been found at Sippara, dated in the fourth year of Assur-etil-ilani, though it is possible that his rule in Babylonia was disputed by his Rab-shakch (vizier), Assur-sum-lisir, whose accession year as king of Assyria occurs on a contract from Nipper (Niffer). The last king of Assyria was probably the brother of Assur-etil-ilani, Sin-sar-iskun (Sin-sarra-uzur), who seems to have been the Sarakos (Sarakus) of Berossus. He was still reigning in Babylonia in his seventh year, as a contract dated in that year has been discovered at Erech, and an inscription of his, in which he speaks of restoring the ruined temples and their priests, couples Merodach of Babylon with Assur of Nineveh. Babylonia, however, was again restless. After the overthrow of Samas-sum-yukin, Kandalanu, the Chineladanos of Ptolemy's canon, had been appointed viceroy. His successor was Nabopolassar, between whom and the last king of Assyria war broke out. The Scythian king of Ecbatana, the Cyaxares of the Greeks, came to the help of the Babylonians. Nineveh was captured and destroyed by the Scythian army, along with those cities of northern Babylonia which had sided with Babylonia, and the Assyrian empire was at an end.

The seat of empire was now transferred to Babylonia. Nabopolassar was followed by his son Nebuchadrezzar II., whose reign of 43 years made Babylon once more the mistress of the civilized world. Only a small fragment of his annals has been discovered relating to his invasion of Egypt in 567 B.C., and referring to "Phut of the Ionians." Of the reign of the last Babylonian king, Nabonidus, however, and the conquest of Babylonia by Cyrus, we now have a fair amount of information.¹ This is chiefly derived from a chronological tablet containing the annals of Nabonidus, which is supplemented by an inscription of Nabonidus, in which he recounts his restoration of the temple of the Moon-god at Harran, as well as by a proclamation of Cyrus issued shortly after his formal recognition as king of Babylonia. It was in the sixth year of Nabonidus (549 B.C.)—or perhaps in 553—that Cyrus, "king of Anshan" in Elam, revolted against his suzerain Astyages, king of "the Manda" or Scythians, at Ecbatana. The army of Astyages betrayed him to his enemy, and Cyrus (*q.v.*) established himself at Ecbatana, thus putting an end to the empire of the Scythians,

¹ For the events leading up to the conquests of Cyrus, see *PERSEA: Ancient History*, § v. The chronology is not absolutely certain.

Merodach-baladan.

Sennacherib.

Esar-haddon.

Assur-bani-pal.

Scythian influence.

Nabopolassar.

Nabonidus.

which the Greek writers called that of the Medes, through a confusion of Madā or "Medes" with Manda. Three years later we find that Cyrus has become king of Persia and is engaged in a campaign in the north of Mesopotamia. Meanwhile Nabonidus has established a camp at Sippara, near the northern frontier of his kingdom, his son—probably the Belshazzar of the other inscriptions—being in command of the army.

Invasion by Cyrus. In 538 B.C. Cyrus invaded Babylonia. A battle was fought at Opis in the month of June, in which the Babylonians were defeated, and immediately afterwards Sippara surrendered to the invader. Nabonidus fled to Babylon, whither he was pursued by Gobryas, the governor of Kurdistan, and on the 16th of Tammuz, two days after the capture of Sippara, "the soldiers of Cyrus entered Babylon without fighting." Nabonidus was dragged out of his hiding-place, and Kurdish guards were placed at the gates of the great temple of Bel, where the services continued without intermission. Cyrus did not arrive till the 3rd of Marchesvan (October), Gobryas having acted for him in his absence. Gobryas was now made governor of the province of Babylon, and a few days afterwards the son of Nabonidus, according to the most probable reading, died. A public mourning followed, which lasted six days, and Cambyses accompanied the corpse to the tomb. Cyrus now claimed to be the legitimate successor of the ancient Babylonian kings and the avenger of Bel-Merodach, who was wrathful at the impiety of Nabonidus in removing the images of the local gods from their ancestral shrines to his capital Babylon. Nabonidus, in fact, had excited a strong feeling against himself by attempting to centralize the religion of Babylonia in the temple of Merodach (Marduk) at Babylon, and while he had thus alienated the local priesthoods the military party despised him on account of his antiquarian tastes. He seems to have left the defence of his kingdom to others, occupying himself with the more congenial work of excavating the foundation records of the temples and determining the dates of their builders. The invasion of Babylonia by Cyrus was doubtless facilitated by the existence of a disaffected party in the state, as well as by the presence of foreign exiles like the Jews, who had

¹The following is a list of the later dynasties and kings of Babylonia and Assyria so far as they are known at present. For the views of other writers on the chronology, see § viii., *Chronological Systems*.

The Babylonian Dynasties from cir. 2500 B.C.

<i>Dynasty of Ur.</i>	<i>Kassite Dynasty of 36 kings for</i>
Gungunu, cir. 2500 B.C.	576 years 9 months. 1780 B.C.
Ur-Gur.	Gandis, 16 years.
Dungi, more than 51 years.	Agum-sipak, 22 years.
Bur-Sin, more than 12 years.	Bitilyasu I., 22 years.
Gimil-Sin, more than 9 years.	Ussi (?), 9 years.
Ibi-Sin.	Adu-metas.
Ildin-Dagan.	Tazzi-gurime.
Sumu-ili.	Agum-kakrums.
<i>First Dynasty of Babylon. 2350 B.C.</i>	Kara-indas.
Sumu-abi, 14 years.	Kadashman-Bel, his son, corresponded with Amen-hotep (Amenophis) III. of Egypt (1400 B.C.)
Sumu-la-ili, 36 years.	Kuri-galzu II.
Zabium, 14 years.	Burna-buryas, his son, 22 years.
Abil-Sin, 18 years.	Kuri-galzu III., his son, 26 years.
Sin-muballith, 20 years.	Nazi-Maruttas, his son, 17 years.
Khammurabi, 43 years.	Kadashman-Turgu, his son, 13 years.
Samsu-iluna, 38 years.	Kudur-bel, 6 years.
Abesukh, 25 years.	Sagarakti-suryas, his son, 13 years.
Ammi-ditana, 25 years.	Bitilyasu II., 8 years.
Ammi-zadqa, 21 years.	Tukulti-In-aristi of Assyria (1272 B.C.) for 7 years, native valiant kings being—
Samsu-ditana, 31 years.	Bel-sum-iddin, 1½ years.
<i>Dynasty of Sisku (?) for 368 years. 2160 B.C.</i>	Kadashman-Bel II., 14 years.
Annan, 60 years.	Hadad-sum-iddin, 6 years.
Ki-Nigas, 56 years.	Hadad-sum-uzur, 30 years.
Damki-ilišu, 26 years.	Meli-sipak, 15 years.
Iskpal, 15 years.	Merodach-baladan I., his son, 13 years.
Susi, 27 years.	Zamama-sum-iddin, 1 year.
Gul-ki[sar], 55 years.	Bel-sum-iddin, 3 years.
Kingal-daramas, 50 years.	
A-dara-kalama, 28 years.	
Akur-duana, 26 years.	
Melamma-kurkura, 8 years.	
Ea-ga(mil), 9 years.	

been planted in the midst of the country. One of the first acts of Cyrus accordingly was to allow these exiles to return to their own homes, carrying with them the images of their gods and their sacred vessels. The permission to do so was embodied in a proclamation, in which the conqueror endeavoured to justify his claim to the Babylonian throne. The feeling was still strong that none had a right to rule over western Asia until he had been consecrated to the office by Bel and his priests; and from henceforth, accordingly, Cyrus assumed the imperial title of "king of Babylon." A year before his death, in 529 B.C., he associated his son Cambyses (*q.v.*) in the government, making him king of Babylon, while he reserved for himself the fuller title of "king of the (other) provinces" of the empire. It was only when Darius Hystaspis, the representative of the Aryan race and the Zoroastrian religion, had re-conquered the empire of Cyrus, that the old tradition was broken and the claim of Babylon to confer legitimacy on the rulers of western Asia ceased to be acknowledged (see DARIUS). Darius, in fact, entered Babylon as a conqueror; after the murder of the Magian it had recovered its independence under Nininta-Bel, who took the name of Nebuchadrezzar III., and reigned from October 521 B.C. to August 520 B.C., when the Persians took it by storm. A few years later, probably 514 B.C., Babylon again revolted under the Armenian Arakha; on this occasion, after its capture by the Persians, the walls were partly destroyed. E-Saggila, the great temple of Bel, however, still continued to be kept in repair and to be a centre of Babylonian patriotism, until at last the foundation of Seleucia diverted the population to the new capital of Babylonia and the ruins of the old city became a quarry for the builders of the new seat of government.¹

VI. Assyria and Babylonia contrasted.—The sister-states of Babylonia and Assyria differed essentially in character. Babylonia was a land of merchants and agriculturists; Assyria was an organized camp. The Assyrian dynasties were founded

<i>Dynasty of Isin of 11 kings for</i>	<i>Dynasty of Sape.</i>	
1325 years. 1203 B.C.	Yukin-zero or Chinziros, 3 years	B.C. 930
Merodach 18 years.	Pulu (Pul or Poros), called Tiglath-pleser III. in Assyria, 2 years	727
Nebuchadrezzar I.	Ululû, called Shalmaneser IV. in Assyria	725
Bel-nadin-pal.	Merodach-baladan II. the Chaldean	721
Nebuchad-nadin-akhi, 22 years.	Sargon of Assyria	709
Merodach 14 years.	Sennacherib, his son	705
Hadad-baladan, an usurper.	Merodach-zakir-sumi, 1 month	702
Merodach-sapik-zer-mati, 12 years.	Merodach-baladan III., 6 months	702
Nabu-nadin, 8 years.	Bel-eub of Babylon	702
<i>Dynasty of the Sea-coast. 1070 B.C.</i>	Assur-nadin-sumi, son of Sennacherib	700
Simbar-sipak, 18 years.	Nergal-yusezib	694
Ea-mukin-zeri, 5 months.	Musezib-Merodach	693
Kassu-nadin-akhi, 3 years.	Sennacherib destroys Babylon	689
<i>Dynasty of Bit-Bari. 1050 B.C.</i>	Esar-haddon, his son	681
E-Ulmas-sakin-sumi, 17 years.	Samas-sum-yukin, his son	668
Ninip-kudur-uzur I., 3 years.	Kandalanu (Kincladanos)	648
Silanim-Suqamuna, 3 months.	Nabopolassar	626
<i>Dynasty of Elam. 1030 B.C.</i>	Nabu-kudur-uzur (Nebuchadrezzar II.)	605
An Elamite, 6 years.	Amil-Marduk (Ebil-Merodach), his son	562
<i>Second Dynasty of Babylon. 1025 B.C.</i>	Nergal-sarra-uzur (Nergal-sharezur)	560
Nebo-kin-abdi, 36 years.	Labasi-Marduk, his son, 3 months	556
Ninip-kudur-uzur II. (?) 8 months 12 days.	Nabu-nahid (Nabonidus)	556
Probably 5 names missing. B.C.	Cyrus conquers Babylon	538
Samas-mudammiq cir. 920	Cambyses, his son	529
Nebo-sum-iskun cir. 900	Gomates, the Magian, 7 months	521
Nebo-baladan cir. 880	Dakuri cir. 760	521
Merodach-nadin-sumi cir. 860	Nabonassar, 14 years	514
Merodach-baladhu-iqbi cir. 830	Nebo-nadin-suma, his son, 2 years	521
Bau-akhi-iddin cir. 810	Darius, son of Hystaspes	520
Probably two names missing.	Nebo-nadin-yukin, his son, 1 month 12 days	514
Nebo-sum-iskun, son of Dakuri cir. 760	End of "the 22nd dynasty"	513
Nabonassar, 14 years	Darius restored	513
Nebo-nadin-suma, his son, 2 years		
Nebo-sum-yukin, his son, 1 month 12 days		
End of "the 22nd dynasty"		

by successful generals; in Babylonia it was the priests whom a revolution raised to the throne. The Babylonian king remained a priest to the last, under the control of a powerful hierarchy; the Assyrian king was the autocratic general of an army, at whose side stood in early days a feudal nobility, and from the reign of Tiglath-pileser III. onwards an elaborate bureaucracy. His palace was more sumptuous than the temples of the gods, from which it was quite separate. The people were soldiers and little else; even the sailor belonged to Babylonia. Hence the sudden collapse of Assyria when drained of its fighting population in the age of Assur-bani-pal.

VII. *Assyro-Babylonian Culture*.—Assyrian culture came from Babylonia, but even here there was a difference between the two countries. There was little in Assyrian literature that was original, and education, which was general in Babylonia, was in the northern kingdom confined for the most part to a single class. In Babylonia it was of very old standing. There were libraries in most of the towns and temples; an old Sumerian proverb averred that "he who would excel in the school of the scribes must rise with the dawn." Women as well as men learned to read and write, and in Semitic times this involved a knowledge of the extinct Sumerian as well as of a most complicated and extensive syllabary. A considerable amount of Semitic Babylonian literature was translated from Sumerian originals, and the language of religion and law long continued to be the old agglutinative language of Chaldea. Vocabularies, grammars and interlinear translations were compiled for the use of students as well as commentaries on the older texts and explanations of obscure words and phrases. The characters of the syllabary were all arranged and named, and elaborate lists of them were drawn up. The literature was for the most part inscribed with a metal stylus on tablets of clay, called *laterculæ cœciliæ* by Pliny; the papyrus which seems to have been also employed has perished. Under the second Assyrian empire, when Nineveh had become a great centre of trade, Aramaic—the language of commerce and diplomacy—was added to the number of subjects which the educated class was required to learn. Under the Seleucids Greek was introduced into Babylon, and fragments of tablets have been found with Sumerian and Assyrian (*i.e.* Semitic Babylonian) words transcribed in Greek letters.

Babylonian Literature and Science.—There were many literary works the titles of which have come down to us. One of the

most famous of these was the *Epic of Gilgamesh*, in twelve books, composed by a certain Sin-liqi-unninni, and arranged upon an astronomical principle. Each division contains the story of a single adventure in the career of Gilgamesh. The whole story is a composite product, and it is possible that some of the stories are artificially attached to the central figure. (See GILGAMESH, EPIC OF.)

Another epic was that of the Creation, the object of which was to glorify Bel-Merodach by describing his contest with Tiamat, the dragon of chaos. In the first book an account is given of the creation of the world out of the primeval deep and the birth of the gods of light. Then comes the story of the struggle between the gods of light and the powers of darkness, and the final victory of Merodach, who clove Tiamat asunder, forming the heaven out of one half of her body and the earth out of the other. Merodach next arranged the stars in order, along with the sun and moon, and gave them laws which they were never to transgress. After this the plants and animals were created, and finally man. Merodach here takes the place of Ea, who appears as the creator in the older legends, and is said to have fashioned man out of the clay.

The legend of Adapa, the first man, a portion of which was found in the record-office of the Egyptian king Amenophis IV. (Akhentaton) at Tell-el-Amarna, explains the origin of death. Adapa while fishing had broken the wings of the south wind, and was accordingly summoned before the tribunal of Anu in heaven. Ea counselled him not to eat or drink there. He followed the advice, and thus refused the food which would have made him and his descendants immortal.

Among the other legends of Babylonia may be mentioned those of Namtar, the plague-demon, of Urra, the pestilence, of Etanna and of Zu. Hades, the abode of Nin-erisgal or Allat, had been entered by Nergal, who, angered by a message sent to her by the gods of the upper world, ordered Namtar to strike off her head. She, however, declared that she would submit to any conditions imposed on her and would give Nergal the sovereignty of the earth. Nergal accordingly relented, and Allatu became the queen of the infernal world. Etanna conspired with the eagle to fly to the highest heaven. The first gate, that of Anu, was successfully reached; but in ascending still farther to the gate of Ishtar the strength of the eagle gave way, and Etanna was dashed to the ground. As for the storm-god Zu, we are told that he stole the tablets of destiny, and therewith the prerogatives of Bel. God after god was ordered to pursue him and recover them, but it would seem that it was only by a stratagem that they were finally regained.

Besides the purely literary works there were others of the most varied nature, including collections of letters, partly official, partly private. Among them the most interesting are the letters of Khammurabi, which have been edited by L. W. King. Astronomy and astrology, moreover, occupy a conspicuous place. Astronomy was of old standing in Babylonia, and the standard work on the subject, written from an astrological point of view, which was translated into Greek by Berossus, was believed to go back to the age of Sargon of Akkad. The zodiac was a Babylonian invention of great antiquity; and eclipses of the sun as well as of the moon could be foretold. Observatories were attached to the temples, and reports were regularly sent by the astronomers to the king. The stars had been numbered and named at an early date, and we possess tables of lunar longitudes and observations of the phases of Venus. In Seleucid and Parthian times the astronomical reports were of a thoroughly scientific character; how far the advanced knowledge and method they display may reach back we do not yet know. Great attention was naturally paid to the calendar, and we find a week of seven and another of five days in use. The development of astronomy implies considerable progress in mathematics; it is not surprising, therefore, that the Babylonians should have invented an extremely simple method of ciphering or have discovered the convenience of the duodecimal system. The *ner* of 600 and the *sar* of 3600 were formed from the *soos* or unit of 60, which corresponded with a degree of the equator. Tablets

Kings of Assyria.

Zullu "founder of the monarchy"		B.C.
Assur-rabi	Samsi-Hadad I., his brother	1070
Assur-nirari, his son	Assur-nazir-pal II., his son	1060
Assur-rim-niseus, his son	Assur-irbi	960
Erba-Hadad	Hadad-nirari II.	<i>cir.</i> 900
Assur-nadin-akhi I., his son	Tiglath-pileser III., his son	950
Assur-yubalidh I., his son	Assur-dan II., his son	930
	Hadad-nirari III., his son	911
	Tukulti-In-aristi, his son	889
	Assur-nazir-pal III., his son	883
Assur-bil-nisi-su	1450	858
Buzur-Assur	1440	
Assur-nadin-akhi II.	1410	
Assur-yubalidh, his son	1390	825
Bel-nirari, his son	1370	
Arik-en-tilu, his son	1350	823
Hadad-nirari I., his son	1330	810
Shalmaneser I., his son (built Calah)	1310	784
Tiglath-In-aristi I., his son, conquers Babylon	1280	771
Assur-nazir-pal I., his son	1260	753
Assur-narara and his son	Pulu, usurper, takes the name of Tiglath-pileser III.	745
Nebo-dan	1250	
Assur-sum-lisir	1235	727
In-aristi-tukulti-Assur	1225	722
Bel-kudur-uzur	1215	705
Assur-isti-pileser, descendant of Erba-Hadad	1200	681
Assur-dan I., his son	1185	668
Mutaggil-Nebo, his son	1160	?
Assur-ris-isi, his son	1140	?
Tiglath-pileser I., his son	1120	?
Assur-bil-kala, his son	1090	?
	Ululû, usurper, takes the name of Shalmaneser IV.	727
	Sargon, usurper	722
	Sennacherib, his son	705
	Esar-haddon, his son	681
	Assur-bani-pal, his son	668
	Assur-etil-iliani-yukin, his son	?
	Assur-sum-lisir	?
	Sin-sarra-uzur (Sarakos)	?
	Destruction of Nineveh	606

of squares and cubes, calculated from 1 to 60, have been found at Senkera, and a people who were acquainted with the sun-dial, the clepsidra, the lever and the pulley, must have had no mean knowledge of mechanics. A crystal lens, turned on the lathe, was discovered by Layard at Nimrud along with glass vases bearing the name of Sargon; this will explain the excessive minuteness of some of the writing on the Assyrian tablets, and a lens may also have been used in the observation of the heavens.

Art and Architecture.—The culture of Assyria, and still more of Babylonia, was essentially literary; we miss in it the artistic spirit of Egypt or Greece. In Babylonia the abundance of clay and want of stone led to the employment of brick; the Babylonian temples are massive but shapeless structures of crude brick, supported by buttresses, the rain being carried off by drains, one of which at Ur was of lead. The use of brick led to the early development of the pilaster and column, as well as of frescoes and enamelled tiles. The walls were brilliantly coloured, and sometimes plated with bronze or gold as well as with tiles. Painted terra-cotta cones were also embedded in the plaster. Assyria in this, as in other matters, the servile pupil of Babylonia, built its palaces and temples of brick, though stone was the natural building material of the country, even preserving the brick platform, so necessary in the marshy soil of Babylonia, but little needed in the north. As time went on, however, the later Assyrian architect began to shake himself free from Babylonian influences and to employ stone as well as brick. The walls of the Assyrian palaces were lined with sculptured and coloured slabs of stone, instead of being painted as in Chaldea. We can trace three periods in the art of these bas-reliefs; it is vigorous but simple under Assur-nazir-pal III., careful and realistic under Sargon, refined but wanting in boldness under Assur-bani-pal. In Babylonia, in place of the bas-relief we have the figure in the round, the earliest examples being the statues from Tello which are realistic but somewhat clumsy. The want of stone in Babylonia made every pebble precious and led to a high perfection in the art of gem-cutting. Nothing can be better than two seal-cylinders that have come down to us from the age of Sargon of Akkad. No remarkable specimens of the metallurgical art of an early period have been found, apart perhaps from the silver vase of Entemena, but at a later epoch great excellence was attained in the manufacture of such jewellery as ear-rings and bracelets of gold. Copper, too, was worked with skill; indeed, it is possible that Babylonia was the original home of copper-working, which spread westward with the civilization to which it belonged. At any rate the people were famous from an early date for their embroideries and rugs. The ceramic history of Babylonia and Assyria has unfortunately not yet been traced; at Susa alone has the care demanded by the modern methods of archaeology been as yet expended on examining and separating the pottery found in the excavations, and Susa is not Babylonia. We do not even know the date of the spirited terra-cotta reliefs discovered by Loftus and Rawlinson. The forms of Assyrian pottery, however, are graceful; the porcelain, like the glass discovered in the palaces of Nineveh, was derived from Egyptian originals. Transparent glass seems to have been first introduced in the reign of Sargon. Stone as well as clay and glass were employed in the manufacture of vases, and vases of hard stone have been disinterred at Tello similar to those of the early dynastic period of Egypt.

Social Life.—Castes were unknown in both Babylonia and Assyria, but the priesthood of Babylonia found its counterpart in the military aristocracy of Assyria. The priesthood was divided into a great number of classes, among which that of the doctors may be reckoned. The army was raised, at all events in part, by conscription; a standing army seems to have been first organized in Assyria. Successive improvements were introduced into it by the kings of the second Assyrian empire; chariots were superseded by cavalry; Tiglath-pileser III. gave the riders saddles and high boots, and Sennacherib created a corps of slingers. Tents, baggage-carts and battering-rams were carried on the march, and the *lartan* or commander-in-chief ranked next to the king. In both countries there was a large

body of slaves; above them came the agriculturists and commercial classes, who were, however, comparatively little numerous in Assyria. The scribes, on the other hand, formed a more important class in Assyria than in Babylonia. Both countries had their artisans, money-lenders, poets and musicians.

The houses of the people contained but little furniture; chairs, tables and couches, however, were used, and Assur-bani-pal is represented as reclining on his couch at a meal while his wife sits on a chair beside him. After death the body was usually partially cremated along with the objects that had been buried with it. The cemetery adjoined the city of the living and was laid out in streets through which ran rivulets of "pure" water. Many of the tombs, which were built of crude brick, were provided with gardens, and there were shelves or altars on which were placed the offerings to the dead. As the older tombs decayed a fresh city of tombs arose on their ruins. It is remarkable that thus far no cemetery older than the Seleucid or Parthian period has been found in Assyria.

Authorities.—See A. H. Layard, *Nineveh and Babylon* (1833); E. de Sarzec and L. Heuzey, *Découvertes en Chaldée* (1883, foll.); H. V. Hilprecht, *The Babylonian Expedition of the University of Pennsylvania* (1893 foll.); J. P. Peters, *Nippur* (1897); E. Schrader, *Keilschriftliche Bibliothek* (1889-1900); *Records of the Past* (new series, 1888-1892); Th. G. Pinches, "The Babylonian Chronicle," in *Journ. R. A. S.* (1887); H. Winckler, *Altorientalische Forschungen* (1893 foll.); and *The Tell-el-Amarna Letters* (1896); G. Maspero, *Dawn of Civilization* (1896), *Struggle of the Nations* (1897), and *Passing of the Empires* (1900); L. W. King, *Letters of Khammurabi* (1898-1900); H. Raab, *Early Babylonian History* (1900); R. W. Rogers, *History of Babylonia and Assyria* (1900); F. Hommel, *Grundriss der Geographie und Geschichte des alten Orients* (1904); *Mitteilungen der deutschen Orientgesellschaft* (1899). (A. H. S.)

VIII. Chronological Systems.—The extreme divergence in the chronological schemes employed by different writers on the history of Babylonia and Assyria has frequently caused no small perplexity to readers who have no special knowledge of the subject. In this section an attempt is made to indicate briefly the causes which have led to so great a diversity of opinion, and to describe in outline the principles underlying the chief schemes of chronology that have been suggested; a short account will then be given of the latest discoveries in this branch of research, and of the manner in which they affect the problems at issue. It will be convenient to begin with the later historical periods, and then to push our inquiry back into the earlier periods of Babylonian and Sumerian history.

Up to certain points no difference of opinion exists upon the dates to be assigned to the later kings who ruled in Babylon and in Assyria. The Ptolemaic Canon (see sect. II.) gives a list of the Babylonian, Assyrian and Persian kings who ruled in Babylon, together with the number of years each of them reigned, from the accession of Nabonassar in 747 B.C. to the conquest of Babylon by Alexander the Great in 331 B.C. The accuracy of this list is confirmed by the larger List of Kings and by the principal Babylonian Chronicle; the latter, like the Canon, begins with the reign of Nabonassar, who, it has been suggested, may have revised the calendar and have inaugurated a new epoch for the later chronology. The Ptolemaic Canon is further controlled and its accuracy confirmed by the Assyrian Eponym Lists, or lists of *limmi* (see sect. II.), by means of which Assyrian chronology is fixed from 911 B.C. to 666 B.C., the solar eclipse of June 15th, 763 B.C., which is recorded in the eponymy of Pur-Sagale, placing the dead reckoning for these later periods upon an absolutely certain basis.

Thus all historians are agreed with regard to the Babylonian chronology back to the year 747 B.C., and with regard to that of Assyria back to the year 911 B.C. It is in respect of the periods anterior to these two dates that different writers have propounded differing systems of chronology, and, as might be imagined, the earlier the period we examine the greater becomes the discrepancy between the systems proposed. This variety of opinion is due to the fact that the data available for settling the chronology often conflict with one another, or are capable of more than one interpretation.

Since its publication in 1884 the Babylonian List of Kings has furnished the framework for every chronological system that has

been proposed. In its original form this document gave a list, arranged in dynasties, of the Babylonian kings, from the First Dynasty of Babylon down to the Neo-Babylonian period. If the text were complete we should probably be in possession of the system of Babylonian chronology current in the Neo-Babylonian period from which our principal classical authorities (see sect. II.) derived their information. The principal points of uncertainty, due to gaps in the text, concern the length of Dynasties IV. and VIII.; for the reading of the figure giving the length of the former is disputed, and the summary at the close of the latter omits to state its length. This omission is much to be regretted, since Nabonassar was the last king but two of this dynasty, and, had we known its duration, we could have combined the information on the earlier periods furnished by the Kings' List with the evidence of the Ptolemaic Canon. In addition to the Kings' List, other important chronological data consist of references in the classical authorities to the chronological system of Berossus (*q.v.*); chronological references to earlier kings occurring in the later native inscriptions, such as Nabonidus's estimate of the period of Khammurabi (or Hammurabi); synchronisms, also furnished by the inscriptions, between kings of Babylon and of Assyria; and the early Babylonian date-lists.

	Dyn. I.	Dyn. II.	Dyn. III.
	B.C.	B.C.	B.C.
Oppert (1888)	2506-2202	2202-1834	1834-1257
Sayce (1899)	2478-(2174)	2174-(1806)	1806-(1229)
" (1902)	2460-(2174)	2174-(1806)	1806-(1229)
Rogers (1900)	2454-2151	2150-1783	1782-1207
Winckler (1894)	(2425-2120)	2120-1752	1752-1177
" (1892)	2403-2098	2098-1730	1729-1150
" (1905)	c. 2400-2100	c. 2100-1700	c. 1700-1150
Delitzsch (1907)	c. 2420-2120	c. 2120-(1752)	(1752-1176)
" (1891)	2399-2094	2094-1726	1726-1150
Maspero (1897)	2416-2082	2082-1714	1714-(1137)
Lehmann-Haupt (1898)	2360-2057	2056-1689	1688-1113
" (1903)	2296-2009/8	2008/7-1691	1690-1115
Marquart (1899)	2335-2051	2051/0-1694/3	1693/2-1118/7
Peiser (1891)	2251-1947	1947-1579	1579-1180
Rost (1897)	2232-1928	1928-1560	1560-1224
" (1900)	2231-1941	1940-1573	1572-1179
Hommel (1901)	2223-1923	(1923-1752)	1752-1175
" (1895)	2058-1754		1753-1178
" (1886)	2035-1731	2403-2035	1731-1154
" (1898)	1884-1580		1580-1180
Niebuhr (1896)	2193-1889	2114-1746	1746-1169

In view of the uncertainty regarding the length of Dynasties IV. and VIII. of the Kings' List, attempts have been made to ascertain the dates of the earlier dynasties by independent means. The majority of writers, after fixing the date at which Dynasty III. closed by means of the synchronisms and certain of the later chronological references, have accepted the figures of the Kings' List for the earlier dynasties, ignoring their apparent inconsistencies with the system of Berossus and with the chronology of Nabonidus. Others have attempted to reconcile the conflicting data by emendations of the figures and other ingenious devices. This will explain the fact that while the difference between the earliest and latest dates suggested for the close of Dynasty III. is only 144 years, the difference between the earliest and latest dates suggested for the beginning of Dynasty I. is no less than 622 years. A comparison of the principal schemes of chronology that have been propounded may be made by means of the preceding table. The first column gives the names of the writers and the dates at which their schemes were published, while the remaining columns give the dates they have suggested for Dynasties I., II. and III. of the Kings' List.¹ The systems with the highest dates are placed first in the list; where a writer has produced more than one system, these are grouped together, the highest dates proposed by him determining his place in the series.

¹ These three dynasties are usually known as the First Dynasty of Babylon, the Dynasty of Sisku or Uruku, and the Kassite Dynasty; see sect. v.

Omitting that of Oppert, which to some extent stands in a category by itself, the systems fall into three groups. The first group, comprising the second to the sixth names, obtains its results by selecting the data on which it relies and ignoring others. The second group, comprising the next four names, attempts to reconcile the conflicting data by emending the figures. The third group, consisting of the last two names, is differentiated by its proposals with regard to Dynasty II. It will be noted that the first group has obtained higher dates than the second, and the second group higher dates on the whole than the third.

Oppert's system² represents the earliest dates that have been suggested. He accepted the figures of the Kings' List and claimed that he reconciled them with the figures of Berossus, though he ignored the later chronological notices. But there is no evidence for his "cyclic date" of 2517 B.C., on which his system depended, and there is little doubt that the beginning of the historical period of Berossus is to be set, not in 2506 B.C., but in 2232 B.C. The two systems of Sayce,³ that of Rogers,⁴ the three systems of Winckler,⁵ both those of Delitzsch,⁶ and that of Maspero,⁷ may be grouped together, for they are based on the same principle. Having first fixed the date of the close of Dynasty III., they employed the figures of the Kings' List unemended for defining the earlier periods, and did not attempt to reconcile their results with other conflicting data. The difference of eighteen years in Sayce's two dates for the rise of Dynasty I. was due to his employing in 1902 the figures assigned to the first seven kings of the dynasty upon the larger of the two contemporary date-lists, which had meanwhile been published, in place of those given by the List of Kings. It should be noted that Winckler (1905) and Delitzsch (1907) gives the dates only in round numbers.

A second group of systems may be said to consist of those proposed by Lehmann-Haupt, Marquart, Peiser, and Rost, for these writers attempted to get over the discrepancies in the data by emending some of the figures furnished by the inscriptions. In 1891, with the object of getting the total duration of the dynasties to agree with the chronological system of Berossus and with the statement of Nabonidus concerning Khammurabi's date, Peiser proposed to emend the figure given by the Kings' List for the length of Dynasty III. The reading of "9 soss and 36 years," which gives the total 576 years, he suggested was a scribal error for "6 soss and 39 years"; he thus reduced the length of Dynasty III. by 177 years and effected a corresponding reduction in the dates assigned to Dynasties I. and II.⁸ In 1897 Rost followed up Peiser's suggestion by reducing the figure still further, but he counteracted to some extent the effects of this additional reduction by emending Sennacherib's date for *Maduku-nadin-akhe's* defeat of Tiglath-pileser I. as engraved on the rock at Bavian, holding that the figure "418," as engraved upon the rock, was a mistake for "478."⁹ Lehmann-Haupt's first system (1898) resembled those of Oppert, Sayce, Rogers, Winckler, Delitzsch and Maspero in that he accepted the figures of the Kings' List, and did not attempt to emend them. But he obtained his low date for the close of Dynasty III. by emending

² See Oppert, *Comptes rendus de l'Acad. des Inscr. et Belles-Lettres* (1888), xvii. pp. 218 ff., and *Bab. and Or. Rec.* ii. pp. 107 ff.

³ See Sayce, *Early Israel*, pp. 281 ff., and *Encyc. Brit.*, 10th ed., vol. xxvi. p. 45 (also his account above).

⁴ See Rogers, *History of Babylonia and Assyria* (1900).

⁵ See Winckler, *Geschichte Babylonien und Assyriens* (1892), *Altorientalische Forschungen*, i. Hft. 2 (1894), and *Auszug aus der Vorderasiatischen Geschichte* (1905).

⁶ See Delitzsch and Mürlter, *Geschichte Babylonien und Assyriens* (1891), and Delitzsch, *Mehr Licht* (1907).

⁷ See Maspero, *Histoire ancienne des peuples de l'Orient classique*, tome ii.

⁸ See Peiser, *Zeits. für Assyriol.* vi. pp. 264 ff.

⁹ See Rost, *Mittel. der Vorderas. Gesellschaft* (1897), ii.

Sennacherib's figure in the Bavian inscription; this he reduced by a hundred years,¹ instead of increasing it by sixty as Rost had suggested. Lehmann-Haupt's influence is visible in Marquart's system,² published in the following year;³ it may be noted that his slightly reduced figure for the beginning of Dynasty I. was arrived at by incorporating the new information supplied by the first date-list to be published. When revising his scheme of chronology in 1900, Rost abandoned his suggested emendation of Sennacherib's figure, but by decreasing his reduction of the length of Dynasty III., he only altered his date for the beginning of Dynasty I. by one year.⁴ In his revised scheme of chronology, published in 1903,⁵ Lehmann-Haupt retained his emendation of Sennacherib's figure, and was in his turn influenced by Marquart's method of reconciling the dynasties of Berossus with the Kings' List. He continued to accept the figure of the Kings' List for Dynasty III., but he reduced the length of Dynasty II. by fifty years, arguing that the figures assigned to some of the reigns were improbably high. His slight reduction in the length of Dynasty I. was obtained from the recently published date-lists, though his proposed reduction of Ammiduga's reign to ten years has since been disproved.

A third group of systems comprises those proposed by Hommel and Niebuhr, for their reductions in the date assigned to Dynasty I. were effected chiefly by their treatment of Dynasty II. In his first system, published in 1886,⁶ Hommel, mainly with the object of reducing Khammurabi's date, reversed the order of the first two dynasties of the Kings' List, placing Dynasty II. before Dynasty I. In his second and third systems (1895 and 1898),⁷ and in his second alternative scheme of 1901 (see below), he abandoned this proposal and adopted a suggestion of Halévy that Dynasty III. followed immediately after Dynasty I.; Dynasty II., he suggested, had either synchronized with Dynasty I., or was mainly apocryphal (*eine spätere Geschichtskonstruktion*). Niebuhr's system was a modification of Hommel's second theory, for, instead of entirely ignoring Dynasty II., he reduced its independent existence to 143 years, making it overlap Dynasty I. by 25 years.⁸ The extremely low dates proposed by Hommel in 1898 were due to his adoption of Peiser's emendation for the length of Dynasty III., in addition to his own elimination of Dynasty II. In 1901 Hommel abandoned Peiser's emendation and suggested two alternative schemes.⁹ According to one of these he attempted to reconcile Berossus with the Kings' List by assigning to Dynasty II. an independent existence of some 171 years, while as a possible alternative he put forward what was practically his theory of 1895.

Such are the principles underlying the various chronological schemes which had, until recently, been propounded. The balance of opinion was in favour of those of the first group of writers, who avoided emendations of the figures and were content to follow the Kings' List and to ignore its apparent discrepancies with other chronological data; but it is now admitted that the general principle underlying the third group of theories was actually nearer the truth. The publication of fresh chronological material in 1906 and 1907 placed a new complexion on the problems at issue, and enabled us to correct several preconceptions, and to reconcile or explain the apparently conflicting data.

From a Babylonian chronicle in the British Museum¹⁰ we now know that Dynasty II. of the Kings' List never occupied the throne of Babylon, but ruled only in the extreme south of

Babylonia on the shores of the Persian Gulf; that its kings were contemporaneous with the later kings of Dynasty I. and with the earlier kings of Dynasty III. of the Kings' List; that in the reign of Samsu-ditana, the last king of Dynasty I., Hittites from Cappadocia raided and captured Babylon, which in her weakened state soon fell a prey to the Kassites (Dynasty III.); and that later on southern Babylonia, till then held by Dynasty II. of the Kings' List, was in its turn captured by the Kassites, who from that time onward occupied the whole of the Babylonian plain. The same chronicle informs us that Ilu-shūma, an early Assyrian patesi, was the contemporary of Su-abu, the founder of Dynasty I. of the Kings' List, thus enabling us to trace the history of Assyria back beyond the rise of Babylon.

Without going into details, the more important results of this new information may be summarized: the elimination of Dynasty II. from the throne of Babylon points to a date not much earlier than 2000 or 2050 B.C. for the rise of Dynasty I., a date which harmonizes with the chronological notices of Shalmaneser I.; Nabonidus's estimate of the period of Khammurabi, so far from being centuries too low, is now seen to have been exaggerated, as the context of the passage in his inscription suggests; and finally the beginning of the historical period of Berossus is not to be synchronized with Dynasty I. of the Kings' List, but, assuming that his figures had an historical basis and that they have come down to us in their original form, with some earlier dynasty which may possibly have had its capital in one of the other great cities of Babylonia (such as the Dynasty of Isin).

New data have also been discovered bearing upon the period before the rise of Babylon. A fragment of an early dynastic chronicle from Nippur¹¹ gives a list of the kings of the dynasties of Ur and Isin. From this text we learn that the Dynasty of Ur consisted of five kings and lasted for 117 years, and was succeeded by the Dynasty of Isin, which consisted of sixteen kings and lasted for 225½ years. Now the capture of the city of Isin by Rim-Sin, which took place in the seventeenth year of Sin-muballit, the father of Khammurabi, formed an epoch for dating tablets in certain parts of Babylonia,¹² and it is probable that we may identify the fall of the Dynasty of Isin with this capture of the city. In that case the later rulers of the Dynasty of Isin would have been contemporaneous with the earlier rulers of Dynasty I. of the Kings' List, and we obtain for the rise of the Dynasty of Ur a date not much earlier than 2300 B.C.

These considerable reductions in the dates of the earlier dynasties of Babylonia necessarily react upon our estimate of the age of Babylonian civilization. The very high dates of 5000 or 6000 B.C., formerly assigned by many writers to the earliest remains of the Sumerians and the Babylonian Scimites,¹³ depended to a great extent on the statement of Nabonidus that 3200 years separated his own age from that of Narām-Sin, the son of Sargon of Agade; for to Sargon, on this statement alone, a date of 3800 B.C. has usually been assigned. But even by postulating the highest possible dates for the Dynasties of Babylon and Ur, enormous gaps occurred in the scheme of chronology, which were unrepresented by any royal name or record. In his valiant attempt to fill these gaps Radau was obliged to invent kings and even dynasties,¹⁴ the existence of which is now definitely disproved. The statement of Nabonidus has not, however, been universally accepted. Lehmann-Haupt suggested an emendation of the text, reducing the number by a thousand years;¹⁵ while Winckler has regarded the statement of Nabonidus as an uncritical exaggeration.¹⁶ Obviously the scribes of Nabonidus were not anxious to diminish the antiquity of the foundation-inscription of Narām-Sin, which their royal master had unearthed;

¹⁰ Published and discussed by Hilprecht, "Mathematical, Metrological and Chronological Texts" (*Bab. Exped.*, Ser. A, xx, 1, dated 1906 and 1907), pp. 46 ff.

¹¹ See L. W. King, *Letters and Inscriptions of Khammurabi*, vol. iii. pp. 28 ff.

¹² Cf., e.g., Hilprecht, *Old Babylonian Inscriptions*, pt. ii. p. 24.

¹³ See Radau, *Early Babylonian History* (1900).

¹⁴ See Lehmann-Haupt, *Zwei Hauptprobleme*, pp. 172 ff.

¹⁵ See Winckler in Schrader's *Keilschriften und das Alte-Testament* (3rd ed.), i. pp. 17 f., and cf. *Mitteil. der vorderas. Gesellschaft* (1906), i. p. 12, n.1.

¹ See Lehmann-Haupt, *Zwei Hauptprobleme* (1898).

² See Marquart, *Philologus*, Supplbd. vii. (1899), pp. 637 ff.

³ See Rost, *Orient. Lit.-Zeit.*, iii. (1900), No. 6.

⁴ See Lehmann-Haupt, *Beiträge zur alten Geschichte* (Klio), Bd. iii. Heft 1 (1903).

⁵ See Hommel, *Geschichte Babylonien und Assyriens*.

⁶ See *Ancient Hebrew Tradition*, p. 125, and Hastings' *Dictionary of the Bible*, i. p. 226 f.

⁷ See Niebuhr, *Chronologie* (1896).

⁸ See Hommel, "Sitzungsberichte der königl. böhmischen Gesellschaft der Wissenschaften," *Phil.-hist. Classe* (1901), v.

⁹ Published and discussed by L. W. King, "Chronicles concerning early Babylonian Kings" (*Studies in Eastern History*, vols. ii. and iii., 1907), and *History of Egypt*, vol. xiii. (published by the Grollier Society, New York, in the spring of 1906), pp. 244 ff.

and another reason for their calculations resulting in so high a figure is suggested by the recent discoveries; they may in all good faith have reckoned as consecutive a number of early dynasties which were as a matter of fact contemporaneous. But, though it may refuse to accept the accuracy of this figure of Nabonidus, it is not possible at present to fix a definite date for the early kings of Agade. All that can be said is that both archaeological and epigraphic evidence indicates that no very long interval separated the empire of the Semitic kings of Agade from that of the kings of Sumer and Akkad, whose rule was inaugurated by the founding of the Dynasty of Ur.¹

To use caution in accepting the chronological notices of the later kings is very far removed from suggesting emendations of their figures. The emenders postulate mechanical errors in the writing of the figures, but, equally with those who accept them, regard the calculations of the native scribes as above reproach. But that scribes could make mistakes in their reckoning is definitely proved by the discovery at Shergat of two totally conflicting accounts of the age and history of the great temple of Assur.² This discovery in itself suggests that all chronological data are not to be treated as of equal value and arranged mechanically like the pieces of a Chinese puzzle; and further, that no more than a provisional acceptance should be accorded any statement of the later native chronologists, until confirmed by contemporary records. On the other hand, the death-blow has been given to the principle of emendation of the figures, which for so long has found favour among a considerable body of German writers.

(L. W. K.)

IX. *Proper Names.*—In the early days of the decipherment of the cuneiform inscriptions, the reading of the proper names borne by Babylonians and Assyrians occasioned great difficulties; and though most of these difficulties have been overcome and there is general agreement among scholars as to the principles underlying both the formation and the pronunciation of the thousands of names that we encounter in historical records, business documents, votive inscriptions and literary productions, differences, though mostly of a minor character, still remain. Some time must elapse before absolute uniformity in the transliteration of these proper names is to be expected; and since different scholars still adopt varying spellings of Babylonian and Assyrian proper names, it has been considered undesirable in this work to ignore the fact in individual articles contributed by them. The better course seems to be to explain here the nature of these variations.

The main difficulty in the reading of Babylonian and Assyrian proper names arises from the preference given to the "ideographic" method of writing them. According to the developed cuneiform system of writing, words may be written by means of a sign (or combination of signs) expressive of the entire word, or they may be spelled out phonetically in syllables. So, for example, the word for "name" may be written by a sign MU, or it may be written out by two signs *shu-mu*, the one sign MU representing the "Sumerian" word for "name," which, however, in the case of a Babylonian or Assyrian text must be read as *shumu*—the Semitic equivalent of the Sumerian MU. Similarly the word for "clothing" may be written SIG-BA, which represents again the "Sumerian" word, whereas, the Babylonian-Assyrian equivalent being *lubashutu* it is so to be read in Semitic texts, and may therefore be also phonetically written *lu-bu-ush-tu*. This double method of writing words arises from the circumstance that the cuneiform syllabary is of non-Semitic origin, the system being derived from the non-Semitic settlers of the Euphrates valley, commonly termed Sumerians (or Sumer-Akkadians), to whom, as the earlier settlers, the origin of the cuneiform script is due. This script, together with the general Sumerian culture, was taken over by the Babylonians upon their settlement in the Euphrates valley and adapted to their language, which belonged to the Semitic group. In this transfer the Sumerian words—largely monosyllabic—were reproduced, but read as Semitic, and

at the same time the advance step was taken of utilizing the Sumerian words as means of writing the Babylonian words phonetically. In this case the signs representing Sumerian words were treated merely as syllables, and, without reference to their meaning, utilized for spelling Babylonian words. The Babylonian syllabary which thus arose, and which, as the culture passed on to the north—known as Assyria—became the Babylonian Assyrian syllabary,³ was enlarged and modified in the course of time, the Semitic equivalents for many of the signs being distorted or abbreviated to form the basis of new "phonetic" values that were thus of "Semitic" origin; but, on the whole, the "non-Semitic" character of the signs used as syllables in the phonetic method of writing Semitic words was preserved; and, furthermore, down to the latest days of the Babylonian and Assyrian empires the mixed method of writing continued, though there were periods when "purism" was the fashion, and there was a more marked tendency to spell out the words laboriously in preference to using signs with a phonetic complement as an aid in suggesting the reading desired in any given instance. Yet, even in those days, the Babylonian syllabary continued to be a mixture of ideographic and phonetic writing. Besides the conventional use of certain signs as the indications of names of gods, countries, cities, vessels, birds, trees, &c., which, known as "determinants," are the Sumerian signs of the terms in question and were added as a guide for the reader, proper names more particularly continued to be written to a large extent in purely "ideographic" fashion. The conservatism which is a feature of proper names everywhere, in consequence of which the archaic traits of a language are frequently preserved in them, just as they are preserved in terms used in the ritual and in poetic diction, is sufficient to account for the interesting fact that the Semitic settlers of the Euphrates valley in handing down their names from one generation to another retained the custom of writing them in "Sumerian" fashion, or, as we might also put it, in "ideographic" form. Thus the name of the deity, which enters as an element in a large proportion of the proper names,⁴ was almost invariably written with the sign or signs representing this deity, and it is only exceptionally that the name is spelled phonetically. Thus the name of the chief god of the Babylonian pantheon, Marduk, is written by two signs to be pronounced AMAR-UD, which describe the god as the "young bullock of the day"—an allusion to the solar character of the god in question. The moon-god Sin is written by a sign which has the force of "thirty," and is a distinct reference to the monthly course of the planet; or the name is written by two signs to be pronounced EN-ZU, which describe the god as the "lord of wisdom." The god Nebo appears as PA—the sign of the stylus, which is associated with this deity as the originator and patron of writing and of knowledge in general,—or it is written with a sign AK, which describes the god as a "creator."

Until, therefore, through parallel passages or through explanatory lists prepared by the Babylonian and Assyrian scribes in large numbers as an aid for the study of the language,⁵ the exact phonetic reading of these divine names was determined, scholars remained in doubt or had recourse to conjectural or provisional readings. Even at the present time there are many names of deities, as, e.g. Ninib, the phonetic reading of which is still unknown or uncertain. In most cases, however, these belong to the category of minor deities or represent old local gods assimilated to some more powerful god, who absorbed, as it were, the attributes and prerogatives of these minor ones. In many cases they will probably turn out to be descriptive epithets of gods

³ The Assyrian language is practically identical with the Babylonian, just as the Assyrians are the same people as the Babylonians with some foreign admixtures.

⁴ In many names the divine element is lopped off, but was originally present.

⁵ Aramaic endorsements on business documents repeating in Aramaic transliteration the names of parties mentioned in the texts have also been of service in fixing the phonetic readings of names. See e.g. Clay's valuable article, "Aramaic Endorsements on the Documents of Murashu Sons" (Persian period) in *Old Testament and Semitic Studies in Memory of William Rainey Harper* (Chicago, 1908, vol. i.), pp. 285-322.

¹ Cf. L. W. King, *Chronicles*, i. pp. 15 ff., 61 f.

² See *Mitteilungen der deutschen Orientgesellschaft*, Nos. 21 and 22, and cf. L. W. King, *Chronicles*, i. pp. 114 ff.

already known rather than genuine proper names. A peculiar difficulty arises in the case of the god of storms, who, written IM, was generally known in Babylonia as Ramman, "the thunderer," whereas in Assyria he also had the designation Adad. In many cases, therefore, we may be in doubt how the sign IM is to be read, more particularly since this same god appears to have had other designations besides Ramman and Adad.

Besides the divine element, proper names as a rule in the Babylonian-Assyrian periods had a verbal form attached and a third element representing an object. Even when the sign indicative of the verb is clearly recognised there still remains to be determined the form of the verb intended. Thus in the case of the sign KUR, which is the equivalent of *našūru*, "protect," there is the possibility of reading it as the active participle *nāšir*, or as an imperative *uššur*, or even the third person perfect *iššur*. Similarly in the case of the sign MU, which, besides signifying "name" as above pointed out, is also the Sumerian word for "give," and therefore may be read *iddin*, "he gave," from *naddinu*, or may be read *nādin*, "giver"; and when, as actually happens, a name occurs in which the first element is the name of a deity followed by MU-MU, a new element of doubt is introduced through the uncertainty whether the first MU is to be taken as a form of the verb *naddinu* and the second as the noun *shumu*, "name," or vice versa.

Fortunately, in the case of a large number of names occurring on business documents as the interested parties or as scribes or as witnesses—and it is through these documents that we obtain the majority of the Babylonian-Assyrian proper names—we have variant readings, the same name being written phonetically in whole or part in one instance and ideographically in another. Certain classes of names being explained in this way, legitimate and fairly reliable conclusions can be drawn for many others belonging to the same class or group. The proper names of the numerous business documents of the Khammurabi period, when phonetic writing was the fashion, have been of special value in resolving doubts as to the correct reading of names written ideographically. Thus names like *Sin-na-di-in-shu-mi* and *Bel-na-di-in-shu-mi*, i.e. "Sin is the giver of a name" (i.e. offspring), and "Bel is the giver of a name," form the model for names with deities as the first element followed by MU-MU, even though the model may not be consistently followed in all cases. In historical texts also variant readings occur in considerable number. Thus, to take a classic example, the name of the famous king Nebuchadrezzar occurs written in the following different manners:—(a) *Na-bi-um-ku-du-ur-ri-u-šu-ur*, (b) *AK-DU-u-šu-ur*, (c) *AK-ku-dur-ri-SHES*, and (d) *PA-GAR-DU-SHES*, from which we are permitted to conclude that PA or AK (with the determinative for deity AN) = *Na-bi-um* or Nebo, that GAR-DU or DU alone = *kuduri*, and that SHES = *uššur*. The second element signifies "boundary" or "territory"; the third element is the imperative of *našūru*, "protect"; so that the whole name signifies, "O, Nebo! protect my boundary" (or "my territory").

It is not the purpose of this note to set forth the principles underlying the formation of proper names among the Babylonians and Assyrians, but it may not be out of place to indicate that by the side of such full names, containing three elements (or even more), we have already at an early period the reduction of these elements to two through the combination of the name of a deity with a verbal form merely, or through the omission of the name of the deity. From such names it is only a step to names of one element, a characteristic feature of which is the frequent addition of an ending *-tum* (feminine), *ān*, *ā*, *um*, *atum*, *atija*, *sha*, &c., most of these being "hypocoristic affixes," corresponding in a measure to modern pet-names.

Lastly, a word about genuine or pseudo-Sumerian names. In the case of texts from the oldest historical periods we encounter hundreds of names that are genuinely Sumerian, and here in view of the multiplicity of the phonetic values attaching to the signs used it is frequently difficult definitely to determine the reading of the names. Our knowledge of the ancient Sumerian language

is still quite imperfect, despite the considerable progress made, more particularly during recent years. It is therefore not surprising that scholars should differ considerably in the reading of Sumerian names, where we have not helps at our command as for Babylonian and Assyrian names. Changes in the manner of reading the Sumerian names are frequent. Thus the name of a king of Ur, generally read Ur-Bau until quite recently, is now read Ur-Engur; for Lugal-zaggisi, a king of Erech, some scholars still prefer to read Ungal-zaggisi; the name of a famous political and religious centre generally read Shir-pur-la is more probably to be read Shir-gul-la; and so forth. There is reason, however, to believe that the uncertainty in regard to many of these names will eventually be resolved into reasonable certainty. A doubt also still exists in regard to a number of names of the older period because of the uncertainty whether their bearers were Sumerians or Semites. If the former, then their names are surely to be read as Sumerian, while, if they were Semites, the signs with which the names are written are probably to be read according to their Semitic equivalents, though we may also expect to encounter Semites bearing genuine Sumerian names. At times too a doubt may exist in regard to a name whose bearer was a Semite, whether the signs composing his name represent a phonetic reading or an ideographic compound. Thus, e.g. when inscriptions of a Semitic ruler of Kish, whose name was written Uru-mu-ush, were first deciphered, there was a disposition to regard this as an ideographic form and to read phonetically Alu-usharshid ("he founded a city," with the omission of the name of the deity), but scholarly opinion finally accepted Uru-mu-ush (Urumush) as the correct designation.

For further details regarding the formation of Sumerian and Babylonian-Assyrian proper names, as well as for an indication of the problems involved and the difficulties still existing, especially in the case of Sumerian names,¹ see the three excellent works now at our disposal for the Sumerian, the old Babylonian, and the neo-Babylonian periods respectively, by Huber, *Die Personennamen in den Keilschrifturkunden aus der Zeit der Könige von Ur und Nisin* (Leipzig, 1907); Ranke, *Early Babylonian Proper Names* (Philadelphia, 1905); and Tallqvist, *Neo-Babylonian Names* (Helsingfors, 1905).

BABYLONIAN AND ASSYRIAN RELIGION. The development of the religion of Babylonia, so far as it can be traced with the material at hand, follows closely along the lines of the periods to be distinguished in the history of the Euphrates valley. Leaving aside the primitive phases of the religion as lying beyond the ken of historical investigation, we may note the sharp distinction to be made between the pre-Khammurabi age and the post-Khammurabi age. While the political movement represented by Khammurabi may have been proceeding for some time prior to the appearance of the great conqueror, the period of c. 2250 B.C., when the union of the Euphratean states was effected by Khammurabi, marks the beginning of a new epoch in the religion as well as in the political history of the Euphrates valley. Corresponding to the states into which we find the country divided before 2250 B.C., we have a various number of religious centres such as Nippur, Erech, Kutha (Cuthah), Ur, Sippar (Sippar), Shirgulla (Lagash), Eridu and Agade, in each of which some god was looked upon as the chief deity around whom there were gathered a number of minor deities and with whom there was invariably associated a female consort. The jurisdiction of this chief god was, however, limited to the political extent or control of the district in which the main seat of the cult of the deity in question lay. Mild attempts, to be sure, to group the chief deities associated with the most important religious and political centres into a regular pantheon were made—notably in Nippur and later in Ur—but such attempts lacked the enduring policy which attaches to Khammurabi's avowed policy to raise Marduk—the patron deity of the future capital, Babylon—to the head of the entire Babylonian pantheon, as

¹ Even in the case of the "Semitic" name of the famous Sargon I. (g.v.), whose full name is generally read *Sharru-kīnu-sha-āli*, and interpreted as "the legitimate king of the city," the question has recently been raised whether we ought not to read "Sharru-kīnu-shar-ri" and interpret as "the legitimate king rules"—an illustration of the vacillation still prevailing in this difficult domain of research.

Babylon itself came to be recognized as the real centre of the entire Euphrates valley.

Associated with Marduk was his consort Sarpanit, and grouped around the pair as princes around a throne were the chief deities of the older centres, like Ea and Damkina of Eridu, Nebo and Tashmit of Borsippa, Nergal and Allatu of Kutha, Shamash and Ā of Sippar, Sin and Ningal of Ur, as well as pairs like Ramma (or Adad) and Shala whose central seat is unknown to us. In this process of accommodating ancient prerogatives to new conditions, it was inevitable that attributes belonging specifically to the one or the other of these gods should have been transferred to Marduk, who thus from being, originally, a solar deity becomes an eclectic power, taking on the traits of Bel, Ea, Shamash, Nergal, Adad and even Sin (the moon-god)—a kind of composite residuum of all the chief gods.

In the religious literature this process can be traced with perfect definiteness. The older incantations, associated with Ea, were re-edited so as to give to Marduk the supreme power over demons, witches and sorcerers; the hymns and lamentations composed for the cult of Bel, Shamash and of Adad were transformed into paeans and appeals to Marduk, while the ancient myths arising in the various religious and political centres underwent a similar process of adaptation to changed conditions, and as a consequence their original meaning was obscured by the endeavour to assign all mighty deeds and acts, originally symbolical of the change of seasons or of occurrences in nature, to the patron deity of Babylon—the supreme head of the entire Babylonian pantheon. Besides the chief deities and their consorts, various minor ones, representing likewise patron gods of less important localities and in most cases of a solar character were added at one time or the other to the court of Marduk, though there is also to be noted a tendency on the part of the chief solar deity, Shamash of Sippara, and for the chief moon-god to absorb the solar and lunar deities of less important sites, leading in the case of the solar gods to the differentiation of the functions of Shamash during the various seasons of the year and the various times of the day among these minor deities. In this way Ninib, whose chief seat appears to have been at Shirgulla (Lagash), became the sun-god of the springtime and of the morning, bringing joy and new life to the earth, while Nergal of Kutha was regarded as the sun of the summer solstice and of the noonday heat—the harbinger of suffering and death.

There were, however, two deities who appear to have retained an independent existence—Anu (*q.v.*), the god of heaven, and Ishtar (*q.v.*), the great mother-goddess, who symbolized fertility and vitality in general. There are some reasons for believing that the oldest seat, and possibly the original seat, of the Anu cult was in Erech, as it is there where the Ishtar cult that subsequently spread throughout Babylonia and Assyria took its rise. While Anu, with whom there was associated as a pale reflection a consort Antum, assigned to him under the influence of the widely prevalent view among the early Semites which conceived of gods always in pairs, remained more or less of an abstraction during the various periods of the Babylonian-Assyrian religion and taking little part in the active cult of the temples, his unique position as the chief god of the highest heavens was always recognized in the theological system developed by the priests, which found an expression in making him the first figure of a triad, consisting of Anu, Bel and Ea, among whom the priests divided the three divisions of the universe, the heavens, the earth with the atmosphere above it, and the watery expanse respectively.

Postponing the discussion of this triad, it is to be noted that the systematization of the pantheon after the days of Khammurabi did not seriously interfere with the independence of the goddess Ishtar. While frequently associated with Marduk, and still more closely with the chief god of Assyria, the god Assur (who occupies in the north the position accorded to Marduk in the south), so much so as to be sometimes spoken of as Assur's consort—the lady or *Belit par excellence*—the belief that as the source of all life she stands apart never lost its hold upon the

people and found an expression also in the system devised by the priests. By the side of the first triad, consisting of Anu, Bel and Ea—disconnected in this form entirely from all local associations—we encounter a second triad composed of Shamash, Sin and Ishtar. As the first triad symbolized the three divisions of the universe—the heavens, earth and the watery element—so the second represented the three great forces of nature—the sun, the moon and the life-giving power. According as the one or the other aspect of such a power is brought into the foreground, Ishtar becomes the mother of mankind, the fertile earth, the goddess of sexual love, and the creative force among animals, while at times she appears in hymns and myths as the general personification of nature.

We thus find in the post-Khammurabi period the pantheon assuming distinct shapes. The strong tendency towards concentrating in one deity—Marduk—the attributes of all others was offset by the natural desire to make the position of Marduk accord with the rank acquired by the secular rulers. As these emphasized their supremacy by grouping around them a court of loyal attendants dependent in rank and ready to do their master's bidding, so the gods of the chief centres and those of the minor local cults formed a group around Marduk; and the larger the group the greater was the reflected glory of the chief figure. Hence throughout the subsequent periods of Babylonian history, and despite a decided progress towards a monotheistic conception of divine government of the universe, the recognition of a large number of gods and their consorts by the side of Marduk remained a firmly embedded doctrine in the Babylonian religion as it did in the Assyrian religion, with the important variation, however, of transferring the rôle of the head of the pantheon from Marduk to Assur. Originally the patron god of the city of Assur (*q.v.*), when this city became the centre of a growing and independent district, Assur was naturally advanced to the same position in the north that Marduk occupied in the south. The religious predominance of the city of Babylon served to maintain for Marduk recognition even on the part of the Assyrian rulers, who, on the political side likewise, conceded to Babylonia the form at least of an independent district even when, as kings of Assyria, they exercised absolute control over it. They appointed their sons or brothers governors of Babylonia, and in the long array of titles that the kings gave themselves, a special phrase was always set aside to indicate their mastery over Babylonia. "To take the hand of Bel-Marduk" was the ceremony of installation which Assyrian rulers recognized equally with Babylonians as an essential preliminary to exercising authority in the Euphrates valley. Marduk and Assur became rivals only when Babylonia gave the Assyrians trouble; and when in 680 B.C. Sennacherib, whose patience had been exhausted by the difficulties encountered in maintaining peace in the south, actually besieged and destroyed the city of Babylon, he removed the statue of Marduk to Nineveh as a symbol that the god's rule had come to an end. His grandson Assur-bani-pal, with a view of re-establishing amicable relations, restored the statue to the temple E-Saggila in Babylon and performed the time-honoured ceremony of "taking the hand of Bel" as a symbol of his homage to the ancient head of the Babylonian pantheon.

But for the substitution of Assur for Marduk, the Assyrian pantheon was the same as that set up in the south, though some of the gods were endowed with attributes which differ slightly from those which mark the same gods in the south. The warlike nature of the Assyrians was reflected in their conceptions of the gods, who thus became little Assurs by the side of the great protector of arms, the big Assur. The cult and ritual in the north likewise followed the models set up in the south. The hymns composed for the temples of Babylonia were transferred to Assur, Calah, Harran, Arbela and Nineveh in the north; and the myths and legends also wandered to Assyria, where, to be sure, they underwent certain modifications. To all practical purposes, however, the religion of Assyria was identical with that practised in the south.

We thus obtain four periods in the development of the Babylonian-Assyrian religion: (1) the oldest period from

c. 3500 B.C. to the time of Khammurabi (c. 2250 B.C.); (2) the post-Khammurabic period in Babylonia; (3) the Assyrian period (c. 2000 B.C.) to the destruction of Nineveh in 606 B.C.; (4) the neo-Babylonian period beginning with Nabopolassar (625-604 B.C.), the first independent ruler under whom Babylonia inaugurates a new though short-lived era of power and prosperity, which ends with Cyrus's conquest of Babylon and Babylonia in 539 B.C., though since the religion proceeds on its undisturbed course for several centuries after the end of the political independence, we might legitimately carry this period to the Greek conquest of the Euphrates valley (331 B.C.), when new influences began to make themselves felt which gradually led to the extinction of the old cults.

In this long period of c. 3500 to c. 300 B.C., the changes introduced after the adjustment to the new conditions produced by Khammurabi's union of the Euphratean states are of a minor character. As already indicated, the local cults in the important centres of the south and north maintained themselves despite the tendency towards centralization, and while the cults themselves varied according to the character of the gods worshipped in each centre, the general principles were the same and the rites differed in minor details rather than in essential variations. An important factor which thus served to maintain the rites in a more or less stable condition was the predominance of what may be called the astral theology as the theoretical substratum of the Babylonian religion, and which is equally pronounced in the religious system of Assyria. The essential feature of this astral theology is the assumption of a close link between the movements going on in the heavens and occurrences on earth, which led to identifying the gods and goddesses with heavenly bodies—planets and stars, besides sun and moon—and to assigning the seats of all the deities in the heavens. The personification of the two great luminaries—the sun and the moon—was the first step in the unfolding of this system, and this was followed by placing the other deities where Shamash and Sin had their seats. This process, which reached its culmination in the post-Khammurabic period, led to identifying the planet Jupiter with Marduk, Venus with Ishtar, Mars with Nergal, Mercury with Nebo, and Saturn with Ninib. The system represents a harmonious combination of two factors, one of popular origin, the other the outcome of speculation in the schools attached to the temples of Babylonia. The popular factor is the belief in the influence exerted by the movements of the heavenly bodies on occurrences on earth—a belief naturally suggested by the dependence of life, vegetation and guidance upon the two great luminaries. Starting with this belief the priests built up the theory of the close correspondence between occurrences on earth and phenomena in the heavens. The heavens presenting a constant change even to the superficial observer, the conclusion was drawn of a connexion between the changes and the ever-changing movement in the fate of individuals and of nature as well as in the appearance of nature.

To read the signs of the heavens was therefore to understand the meaning of occurrences on earth, and with this accomplished it was also possible to foretell what events were portended by the position and relationship to one another of sun, moon, planets and certain stars. Myths that symbolized changes in season or occurrences in nature were projected on the heavens, which were mapped out to correspond to the divisions of the earth. All the gods, great and small, had their places assigned to them in the heavens, and facts, including such as fell within the domain of political history, were interpreted in terms of astral theology. So completely did this system in the course of time sway men's minds that the cult, from being an expression of animistic beliefs, took on the colour derived from the "astral" interpretation of occurrences and doctrines. It left its trace in incantations, omens and hymns, and it gave birth to astronomy, which was assiduously cultivated because a knowledge of the heavens was the very foundation of the system of belief unfolded by the priests of Babylonia and Assyria. "Chaldaean wisdom" became in the classical world the synonym of this science, which in its character was so essentially religious. The persistent

prominence which astrology (*q.v.*) continued to enjoy down to the border-line of the scientific movement of our own days, and which is directly traceable to the divination methods perfected in the Euphrates valley, is a tribute to the scope and influence attained by the astral theology of the Babylonian and Assyrian priests.

As an illustration of the manner in which the doctrines of the religion were made to conform to the all-pervading astral theory, it will be sufficient to refer to the modification undergone in this process of the view developed in a very early period which apportioned the control of the universe among the three gods Anu, Bel and Ea. Disassociating these gods from all local connexions, Anu became the power presiding over the heavens, to Bel was assigned the earth and the atmosphere immediately above it, while Ea ruled over the deep. With the transfer of all the gods to the heavens, and under the influence of the doctrine of the correspondence between the heavens and the earth, Anu, Bel and Ea became the three "ways" (as they are called) on the heavens. The "ways" appear in this instance to have been the designation of the ecliptic circle, which was divided into three sections or zones—a northern, a middle and a southern zone, Anu being assigned to the first, Bel to the second, and Ea to the third zone. The astral theology of the Babylonian-Assyrian religion, while thus bearing the ear-marks of a system devised by the priests, succeeded in assimilating the beliefs which represented the earlier attempts to systematize the more popular aspects of the religion, and in this way a unification of diverse elements was secured that led to interpreting the contents and the form of the religion in terms of the astral-theological system.

The most noteworthy outcome of this system in the realm of religious practice was, as already intimated, the growth of an elaborate and complicated method of divining the future by the observation of the phenomena in the heavens. It is significant that in the royal collection of cuneiform literature made by King Assur-bani-pal of Assyria (668-626 B.C.) and deposited in his palace at Nineveh, the omen collections connected with the astral theology of Babylonia and Assyria form the largest class. There are also indications that the extensive texts dealing with divination through the liver of sacrificial animals, which represents a more popular origin than divination through the observations of the heavens, based as it is on the primitive view which regarded the liver as the seat of life and of the soul, were brought into connexion with astral divination. Less influenced by the astral-theological system are the old incantation texts which were gathered together into series. In these series we can trace the attempt to gather the incantation formulae and prayers produced in different centres, and to make them conform to the tendency to centralize the cult in the worship of Marduk and his consort in the south, and of Assur and Ishtar in the north. Incantations originally addressed to Ea of Eridu, as the god of the watery element, and to Nusku, as the god of fire, were transferred to Marduk. This was done by making Ea confer on Marduk as his son the powers of the father, and by making Nusku a messenger between Ea and Marduk. At the same time, since the invoking of the divine powers was the essential element in the incantations, in order to make the magic formulae as effective as possible, a large number of the old local deities are introduced to add their power to the chief ones; and it is here that the astral system comes into play through the introduction of names of stars, as well as through assigning attributes to the gods which clearly reflect the conception that they have their seats in the heavens. The incantations pass over naturally into hymns and prayers. The connexion between the two is illustrated by the application of the term *shiptu*, "incantation," to the direct appeals to the gods, as well as by the introduction, on the one hand, of genuine prayers into the incantations and by the addition, on the other hand, of incantations to prayers and hymns, pure and simple. In another division of the religious literature of Babylonia which is largely represented in Assur-bani-pal's collection—the myths and legends—tales which originally symbolized the change of seasons, or in which historical occurrences are overcast with more or less copious

admixture of legend and myth, were transferred to the heavens, and so it happens that creation myths, and the accounts of wanderings and adventures of heroes of the past, are referred to movements among the planets and stars as well as to occurrences or supposed occurrences on earth.

The ritual alone which accompanied divination practices and incantation formulae and was a chief factor in the celebration of festival days and of days set aside for one reason or the other to the worship of some god or goddess or group of deities, is free from traces of the astral theology. The more or less elaborate ceremonies prescribed for the occasions when the gods were approached are directly connected with the popular elements of the religion. Animal sacrifice, libations, ritualistic purification, sprinkling of water, and symbolical rites of all kinds accompanied by short prayers, represent a religious practice which in the Babylonian-Assyrian religion, as in all religions, is older than any theology and survives the changes which the theoretical substratum of the religion undergoes.

On the ethical side, the religion of Babylonia more particularly, and to a less extent that of Assyria, advances to noticeable conceptions of the qualities associated with the gods and goddesses and of the duties imposed on man. Shamash the sun-god was invested with justice as his chief trait, Marduk is portrayed as full of mercy and kindness, Ea is the protector of mankind who is grieved when, through a deception practised upon Adapa, humanity is deprived of immortality. The gods, to be sure, are easily aroused to anger, and in some of them the dire aspects predominated, but the view becomes more and more pronounced that there is some cause always for the divine wrath. Though, in accounting for the anger of the gods, no sharp distinction is made between moral offences and a ritualistic oversight or neglect, yet the stress laid in the hymns and prayers, as well as in the elaborate atonement ritual prescribed in order to appease the anger of the gods, on the need of being clean and pure in the sight of the higher powers, the inculcation of a proper aspect of humility, and above all the need of confessing one's guilt and sins without any reserve—all this bears testimony to the strength which the ethical factor acquired in the domain of the religion.

This factor appears to less advantage in the unfolding of the views concerning life after death: Throughout all periods of Babylonian-Assyrian history, the conception prevailed of a large dark cavern below the earth, not far from the Apsu—the ocean encircling and flowing underneath the earth—in which all the dead were gathered and where they led a miserable existence of inactivity amid gloom and dust. Occasionally a favoured individual was permitted to escape from this general fate and placed in a pleasant island. It would appear also that the rulers were always singled out for divine grace, and in the earlier periods of the history, owing to the prevailing view that the rulers stood nearer to the gods than other mortals, the kings were deified after death, and in some instances divine honours were paid to them even during their lifetime.

The influence exerted by the Babylonian-Assyrian religion was particularly profound on the Semites, while the astral theology affected the ancient world in general, including the Greeks and Romans. The impetus to the purification of the old Semite religion to which the Hebrews for a long time clung in common with their fellows—the various branches of nomadic Arabs—was largely furnished by the remarkable civilization unfolded in the Euphrates valley and in many of the traditions, myths and legends embodied in the Old Testament; traces of direct borrowing from Babylonia may be discerned, while the indirect influences in the domain of the prophetic books, as also in the Psalms and in the so-called "Wisdom Literature," are even more noteworthy. Even when we reach the New Testament period, we have not passed entirely beyond the sphere of Babylonian-Assyrian influences. In such a movement as early Christian gnosticism, Babylonian elements—modified, to be sure, and transformed—are largely present, while the growth of an apocalyptic literature is ascribed with apparent justice by many scholars to the recrudescence of views the ultimate source of

which is to be found in the astral-theology of the Babylonian and Assyrian priests.

BIBLIOGRAPHY.—Morris Jastrow, jun., *Religion Babylonians and Assyrians* (Giessen, 1904), enlarged and re-written form of the author's smaller *Religion of Babylonia and Assyria* (Boston, 1898); A. H. Sayce, *The Religion of the Ancient Babylonians* (Hibbert Lectures, London, 1887), now superseded by the same author's *Religions of Ancient Egypt and Babylonia* (Gifford Lectures, Edinburgh, 1902); Friedrich Jeremias, *Die Babylonier und Assyrer*, in *de la Saussaye's Lehrbuch der Religionsgeschichte* (3rd ed., Tübingen, 1905), vol. i.; L. W. King, *Babylonian Religion and Mythology* (London, 1899); T. G. Pinches, *Religion of Babylonia and Assyria* (London, 1906). Of special texts and monographs bearing on the religion may be mentioned various volumes in the new series of cuneiform texts from Babylonian tablets, &c., in the British Museum (London, 1901-), especially parts v., xii., xv., xvii., xviii., xix. and xxi. and vol. iv. of the earlier series of *Selections from the Miscellaneous Inscriptions of Western Asia*, ed. by H. C. Rawlinson (2nd ed., London, 1891); H. Zimmern, *Beiträge zur Kenntnis der babylonischen Religion* (Leipzig, 1901); I. A. Craig, *Assyrian and Babylonian Religious Texts* (Leipzig, 1895-1897); L. W. King, *The Seven Tablets of Creation* (London, 1902); R. C. Thompson, *The Reports of the Magicians and Astrologers of Nineveh and Babylon* (London, 1900); A. Boissier, *Documents assyriens relatifs aux présages* (Paris, 1894-1897); and his *Choix de textes relatifs à la divination assyro-babylonienne* (Geneva, 1905-1906); Ch. Fossey, *La Magie assyrienne* (Paris, 1902); G. A. Reisner, *Sumerisch-babylonische Hymnen* (Berlin, 1896); L. W. King, *Babylonian Magic and Sorcery* (London, 1896); R. C. Thompson, *Devils and Evil Spirits of Babylonia* (London, 1903-1904); K. L. Tallqvist, *Die assyrische Beschwörungsmagie Magli* (Leipzig, 1895); J. A. Knudtzon, *Assyrische Gebete an den Sonnengott* (Leipzig, 1893); Vireolaud, *L'Astrologie chaldéenne* (Paris, 1906-); Craig, *Astrological-Astronomical Texts* (Leipzig, 1892); Martin, *Textes religieux assyriens et babyloniens* (Paris, 1900 and 1903); Paul Haupt, *Das babylonische Nimrodopos* (Leipzig, 1891); Friedrich Delitzsch, *Das babylonische Welterschöpfungspos* (Leipzig, 1896); P. Jensen, "Assyrisch-babylonische Mythen und Epen," in *Schrader's Keilschriftliche Bibliothek*, vol. vi, part 1 (Berlin, 1900); also his *Das Nationalepos der Babylonier*, in *Strassburg*, 1906; H. Zimmern in vol. II. of 3rd ed. of *Schrader's Keilschriftliche und assyrische Texte* (Berlin, 1903); Alfred Jeremias, *Die babylonisch-assyrische Vorstellung vom Leben nach dem Tode* (Leipzig, 1887); and his *Das Alte Testament im Lichte des Alten Orients* (2nd ed., Leipzig, 1906-1907); and *Babylonisches im Neuen Testament* (Leipzig, 1905). On the religious literature of Babylonia and Assyria, see also chapters xv. to xxiv. in Jastrow's work (German and English edition), Carl Bezold's *Ninive and Babylon* (Bielefeld, 1905), chapters vi. to xii., and the same author's monumental catalogue of the cuneiform tablets in the Kuyunjik collection of the British Museum (5 vols., London, 1899-1899). (M. J.)

BABYLONIAN CAPTIVITY, the name generally given to the deportation of the Jews to Babylon by Nebuchadnezzar. Three separate occasions are mentioned (Jer. lii. 28-30). The first was in the time of Jehoiachin in 597 B.C., when the temple of Jerusalem was partially despoiled and a number of the leading citizens removed. After eleven years (in the reign of Zedekiah) a fresh rising of the Judæans occurred; the city was razed to the ground, and a further deportation ensued. Finally, five years later, Jeremiah (*loc. cit.*) records a third captivity. After the overthrow of Babylonia by the Persians, Cyrus gave the Jews permission to return to their native land (537 B.C.), and more than forty thousand are said to have availed themselves of the privilege. (See JEHOIAKIM; JEHOIACHIN; ZEDEKIAH; EZRA-NEHEMIAH and JEWS: *History*.)

BABYLONIAN LAW. The material for the study of Babylonian law is singularly extensive without being exhaustive. The so-called "contracts," including a great variety of deeds, conveyances, bonds, receipts, accounts and, most important of all, the actual legal decisions given by the judges in the law courts, exist in thousands. Historical inscriptions, royal charters and rescripts, despatches, private letters and the general literature afford welcome supplementary information. Even grammatical and lexicographical works, intended solely to facilitate the study of ancient literature, contain many extracts or short sentences bearing on law and custom. The so-called "Sumerian Family Laws" are thus preserved. The discovery of the now celebrated Code of Khammurabi (Hammurabi)¹ (hereinafter simply termed

¹ For the transliteration of Babylonian and Assyrian names generally, see BABYLONIA AND ASSYRIA, section ix., *Proper Names*.

"the Code") has, however, made a more systematic study possible than could have resulted from the classification and interpretation of the other material. Some fragments of a later code exist and have been published; but there still remain many points upon which we have no evidence.

This material dates from the earliest times down to the commencement of our era. The evidence upon a particular point may be very full at one period and almost entirely lacking at another. The Code forms the backbone of the skeleton sketch which is here reconstructed. The fragments of it which have been recovered from Assur-bani-pal's library at Nineveh and later Babylonian copies show that it was studied, divided into chapters entitled *Ninu ilu šurum* from its opening words, and recopied for fifteen hundred years or more. The greater part of it remained in force, even through the Persian, Greek and Parthian conquests, which affected private life in Babylonia very little, and it survived to influence Syro-Roman and later Mahomedan law in Mesopotamia. The law and custom which preceded the Code we shall call "early," that of the New Babylonian empire (as well as the Persian, Greek, &c.) "late." The law in Assyria was derived from Babylonia but conserved early features long after they had disappeared elsewhere.

When the Semitic tribes settled in the cities of Babylonia, their tribal custom passed over into city law. The early history of the country is the story of a struggle for supremacy between the cities. A metropolis demanded tribute and military support from its subject cities but left their local cults and customs unaffected. The city rights and usages were respected by kings and conquerors alike.

As late as the accession of Assur-bani-pal and Samas-sum-yukin we find the Babylonians appealing to their city laws that groups of aliens to the number of twenty at a time were free to enter the city, that foreign women once married to Babylonian husbands could not be enslaved and that not even a dog that entered the city could be put to death untried.

The population of Babylonia was of many races from early times and intercommunication between the cities was incessant. Every city had a large number of resident aliens. This freedom of intercourse must have tended to assimilate custom. It was, however, reserved for the genius of Khammurabi to make Babylon his metropolis and weld together his vast empire by a uniform system of law.

Almost all trace of tribal custom has already disappeared from the law of the Code. It is state-law; alike self-help, blood-feud, marriage by capture, are absent; though family solidarity, district responsibility, ordeal, the *lex talionis*, are primitive features that remain. The king is a benevolent autocrat, easily accessible to all his subjects, both able and willing to protect the weak against the highest-placed oppressor. The royal power, however, can only pardon when private resentment is appeased. The judges are strictly supervised and appeal is allowed. The whole land is covered with feudal holdings, masters of the levy, police, &c. There is a regular postal system. The *pax Babylonica* is so assured that private individuals do not hesitate to ride in their carriage from Babylon to the coast of the Mediterranean. The position of women is free and dignified.

The Code did not merely embody contemporary custom or conserve ancient law. It is true that centuries of law-abiding and litigious habit had accumulated in the temple archives of each city vast stores of precedent in ancient deeds and the records of judicial decisions, and that intercourse had assimilated city custom. The universal habit of writing and perpetual recourse to written contract even more modified primitive custom and ancient precedent. Provided the parties could agree, the Code left them free to contract as a rule. Their deed of agreement was drawn up in the temple by a notary public, and confirmed by an oath "by god and the king." It was publicly sealed and witnessed by professional witnesses, as well as by collaterally interested parties. The manner in which it was thus executed may have been sufficient security that its stipulations were not impious or illegal. Custom or public opinion doubtless secured

that the parties would not agree to wrong. In case of dispute the judges dealt first with the contract. They might not sustain it, but if the parties did not dispute it, they were free to observe it. The judges' decision might, however, be appealed against. Many contracts contain the proviso that in case of future dispute the parties would abide by "the decision of the king." The Code made known, in a vast number of cases, what that decision would be, and many cases of appeal to the king were sent back to the judges with orders to decide in accordance with it. The Code itself was carefully and logically arranged and the order of its sections was conditioned by their subject-matter. Nevertheless the order is not that of modern scientific treatises, and a somewhat different order from both is most convenient for our purpose.

The Code contemplates the whole population as falling into three classes, the *amelu*, the *muskinu* and the *ardu*. The *amelu* was a patrician, the man of family, whose birth, marriage and death were registered, of ancestral estates and full civil rights. He had aristocratic privileges and responsibilities, the right to exact retaliation for corporal injuries, and liability to heavier punishment for crimes and misdemeanours, higher fees and fines to pay. To this class belonged the king and court, the higher officials, the professions and craftsmen. The term became in time a mere courtesy title but originally carried with it standing. Already in the Code, when status is not concerned, it is used to denote "any one." There was no property qualification nor does the term appear to be racial. It is most difficult to characterize the *muskinu* exactly. The term came in time to mean "a beggar" and with that meaning has passed through Aramaic and Hebrew into many modern languages; but though the Code does not regard him as necessarily poor, he may have been landless. He was free, but had to accept monetary compensation for corporal injuries, paid smaller fees and fines, even paid less offerings to the gods. He inhabited a separate quarter of the city. There is no reason to regard him as specially connected with the court, as a royal pensioner, nor as forming the bulk of the population. The rarity of any reference to him in contemporary documents makes further specification conjectural. The *ardu* was a slave, his master's chattel, and formed a very numerous class. He could acquire property and even hold other slaves. His master clothed and fed him, paid his doctor's fees, but took all compensation paid for injury done to him. His master usually found him a slave-girl as wife (the children were then born slaves), often set him up in a house (with farm or business) and simply took an annual rent of him. Otherwise he might marry a freewoman (the children were then free), who might bring him a dowry which his master could not touch, and at his death one-half of his property passed to his master as his heir. He could acquire his freedom by purchase from his master, or might be freed and dedicated to a temple, or even adopted, when he became an *amelu* and not a *muskinu*. Slaves were recruited by purchase abroad, from captives taken in war and by freemen degraded for debt or crime. A slave often ran away; if caught, the captor was bound to restore him to his master, and the Code fixes a reward of two shekels which the owner must pay the captor. It was about one-tenth of the average value. To detain, harbour, &c., a slave was punished by death. So was an attempt to get him to leave the city. A slave bore an identification mark, which could only be removed by a surgical operation and which later consisted of his owner's name tattooed or branded on the arm. On the great estates in Assyria and its subject provinces were many serfs, mostly of subject race, settled captives, or quondam slaves, tied to the soil they cultivated and sold with the estate but capable of possessing land and property of their own. There is little trace of serfs in Babylonia, unless the *muskinu* be really a serf.

The god of a city was originally owner of its land, which encircled it with an inner ring of irrigable arable land and an outer fringe of pasture, and the citizens were his tenants. The god and his viceregent, the king, had long ceased to disturb tenancy, and were content with fixed dues in *naturalia*, stock,

money or service. One of the earliest monuments records the purchase by a king of a large estate for his son, paying a fair market price and adding a handsome honorarium to the many owners in costly garments, plate, and precious articles of furniture. The Code recognizes complete private ownership in land, but apparently extends the right to hold land to votaries, merchants (and resident aliens?). But all land was sold subject to its fixed charges. The king, however, could free land from these charges by charter, which was a frequent way of rewarding those who deserved well of the state. It is from these charters that we learn nearly all we know of the obligations that lay upon land. The state demanded men for the army and the *corvée* as well as dues in kind. A definite area was bound to find a Bowman together with his linked pikeman (who bore the shield for both) and to furnish them with supplies for the campaign. This area was termed "a bow" as early as the 8th century B.C., but the usage was much earlier. Later, a horseman was due from certain areas. A man was only bound to serve so many (six?) times, but the land had to find a man annually. The service was usually discharged by slaves and serfs, but the *amelu* (and perhaps the *muskinu*) went to war. The "bows" were grouped in tens and hundreds. The *corvée* was less regular. The letters of Khammurabi often deal with claims to exemption. Religious officials and shepherds in charge of flocks were exempt. Special liabilities lay upon riparian owners to repair canals, bridges, quays, &c. The state claimed certain proportions of all crops, stock, &c. The king's messengers could commandeer any subject's property, giving a receipt. Further, every city had its own octroi duties, customs, ferry dues, highway and water rates. The king had long ceased to be, if he ever was, owner of the land. He had his own royal estates, his private property and dues from all his subjects. The higher officials had endowments and official residences. The Code regulates the feudal position of certain classes. They held an estate from the king consisting of house, garden, field, stock and a salary, on condition of personal service on the king's errand. They could not delegate the service on pain of death. When ordered abroad they could nominate a son, if capable, to hold the benefice and carry on the duty. If there was no son capable, the state put in a *locum tenens*, but granted one-third to the wife to maintain herself and children. The benefice was inalienable, could not be sold, pledged, exchanged, sublet, devised or diminished. Other land was held of the state for rent. Ancestral estate was strictly tied to the family. If a holder would sell, the family had the right of redemption and there seems to have been no time-limit to its exercise.

The temple occupied a most important position. It received from its estates, from tithes and other fixed dues, as well as from the sacrifices (a customary share) and other offerings of the faithful, vast amounts of all sorts of *naturalia*; besides money and permanent gifts. The larger temples had many officials and servants. Originally, perhaps, each town clustered round one temple, and each head of a family had a right to minister there and share its receipts. As the city grew, the right to so many days a year at one or other shrine (or its "gate") descended in certain families and became a species of property which could be pledged, rented or shared within the family, but not alienated. In spite of all these demands, however, the temples became great granaries and store-houses; as they also were the city archives. The temple had its responsibilities. If a citizen was captured by the enemy and could not ransom himself the temple of his city must do so. To the temple came the poor farmer to borrow seed corn or supplies for harvesters, &c.—advances which he repaid without interest. The king's power over the temple was not proprietary but administrative. He might borrow from it but repaid like other borrowers. The tithes seem to have been the composition for the rent due to the god for his land. It is not clear that all lands paid tithes, perhaps only such as once had a special connexion with the temple.

The Code deals with a class of persons devoted to the service of a god, as vestals or hierodules. The vestals were vowed to chastity, lived together in a great nunnery, were forbidden to

open or enter a tavern, and together with other votaries had many privileges.

The Code recognizes many ways of disposing of property—sale, lease, barter, gift, dedication, deposit, loan, pledge, all of which were matters of contract. Sale was the delivery of the purchase (in the case of real estate symbolized by a staff, a key, or deed of conveyance) in return for the purchase money, receipts being given for both. Credit, if given, was treated as a debt, and secured as a loan by the seller to be repaid by the buyer, for which he gave a bond. The Code admits no claim unsubstantiated by documents or the oath of witnesses. A buyer had to convince himself of the seller's title. If he bought (or received on deposit) from a minor or a slave without power of attorney, he would be executed as a thief. If the goods were stolen and the rightful owner reclaimed them, he had to prove his purchase by producing the seller and the deed of sale or witnesses to it. Otherwise he would be adjudged a thief and die. If he proved his purchase, he had to give up the property but had his remedy against the seller or, if he had died, could reclaim five-fold from his estate. A man who bought a slave abroad, might find that he had been stolen or captured from Babylonia, and he had to restore him to his former owner without profit. If he bought property belonging to a feudal holding, or to a ward in chancery, he had to return it and forfeit what he gave for it as well. He could repudiate the purchase of a slave attacked by the *bennu* sickness within the month (later, a hundred days), and had a female slave three days on approval. A defect of title or undisclosed liability would invalidate the sale at any time.

Landowners frequently cultivated their land themselves but might employ a husbandman or let it. The husbandman was bound to carry out the proper cultivation, raise an average crop and leave the field in good tilth. In case the crop failed the Code fixed a statutory return. Land might be let at a fixed rent when the Code enacted that accidental loss fell on the tenant. If let on share-profit, the landlord and tenant shared the loss proportionately to their stipulated share of profit. If the tenant paid his rent and left the land in good tilth, the landlord could not interfere nor forbid subletting. Waste land was let to reclaim, the tenant being rent-free for three years and paying a stipulated rent in the fourth year. If the tenant neglected to reclaim the land the Code enacted that he must hand it over in good tilth and fixed a statutory rent. Gardens or plantations were let in the same ways and under the same conditions; but for date-groves four years' free tenure was allowed. The metayer system was in vogue, especially on temple lands. The landlord found land, labour, oxen for ploughing and working the watering-machines, carting, threshing or other implements, seed corn, rations for the workmen and fodder for the cattle. The tenant, or steward, usually had other land of his own. If he stole the seed, rations or fodder, the Code enacted that his fingers should be cut off. If he appropriated or sold the implements, impoverished or sublet the cattle, he was heavily fined and in default of payment might be condemned to be torn to pieces by the cattle on the field. Rent was as contracted.

Irrigation was indispensable. If the irrigator neglected to repair his dyke, or left his runnel open and caused a flood, he had to make good the damage done to his neighbours' crops, or be sold with his family to pay the cost. The theft of a watering-machine, water-bucket or other agricultural implement was heavily fined.

Houses were let usually for the year, but also for longer terms, rent being paid in advance, half-yearly. The contract generally specified that the house was in good repair, and the tenant was bound to keep it so. The woodwork, including doors and door frames, was removable, and the tenant might bring and take away his own. The Code enacted that if the landlord would re-enter before the term was up, he must remit a fair proportion of the rent. Land was leased for houses or other buildings to be built upon it, the tenant being rent-free for eight or ten years; after which the building came into the landlord's possession.

Despite the multitude of slaves, hired labour was often needed, especially at harvest. This was matter of contract, and the hirer,

who usually paid in advance, might demand a guarantee to fulfil the engagement. Cattle were hired for ploughing, working the watering-machines, carting, threshing, &c. The Code fixed a statutory wage for sowers, ox-drivers, field-labourers, and hire for oxen, asses, &c.

There were many herds and flocks. The flocks were committed to a shepherd who gave receipt for them and took them out to pasture. The Code fixed him a wage. He was responsible for all care, must restore ox for ox, sheep for sheep, must breed them satisfactorily. Any dishonest use of the flock had to be repaid ten-fold, but loss by disease or wild beasts fell on the owner. The shepherd made good all loss due to his neglect. If he let the flock feed on a field of corn he had to pay damages four-fold; if he turned them into standing corn when they ought to have been folded he paid twelve-fold.

In commercial matters, payment in kind was still common, though the contracts usually stipulate for cash, naming the standard expected, that of Babylon, Larsa, Assyria, Carchemish, &c. The Code enacted, however, that a debtor must be allowed to pay in produce according to statutory scale. If a debtor had neither money nor crop, the creditor must not refuse goods.

Debt was secured on the person of the debtor. Distraint on a debtor's corn was forbidden by the Code; not only must the creditor give it back, but his illegal action forfeited his claim altogether. An unwarranted seizure for debt was fined, as was the distraint of a working ox. The debtor being seized for debt could nominate as mancipium or hostage to work off the debt, his wife, a child, or slave. The creditor could only hold a wife or child three years as mancipium. If the mancipium died a natural death while in the creditor's possession no claim could lie against the latter; but if he was the cause of death by cruelty, he had to give son for son, or pay for a slave. He could sell a slave-hostage, unless she were a slave-girl who had borne her master children. She had to be redeemed by her owner.

The debtor could also pledge his property, and in contracts often pledged a field, house or crop. The Code enacted, however, that the debtor should always take the crop himself and pay the creditor from it. If the crop failed, payment was deferred and no interest could be charged for that year. If the debtor did not cultivate the field himself he had to pay for the cultivation, but if the cultivation was already finished he must harvest it himself and pay his debt from the crop. If the cultivator did not get a crop this would not cancel his contract. Pledges were often made where the intrinsic value of the article was equivalent to the amount of the debt; but antichretic pledge was more common, where the profit of the pledge was a set-off against the interest of the debt. The whole property of the debtor might be pledged as security for the payment of the debt, without any of it coming into the enjoyment of the creditor. Personal guarantees were often given that the debtor would repay or the guarantor become liable himself.

Trade was very extensive. A common way of doing business was for a merchant to entrust goods or money to a travelling agent, who sought a market for his goods. The caravans travelled far beyond the limits of the empire. The Code insisted that the agent should inventory and give a receipt for all that he received. No claim could be made for anything not so entered. Even if the agent made no profit he was bound to return double what he had received, if he made poor profit he had to make up the deficiency; but he was not responsible for loss by robbery or extortion on his travels. On his return, the principal must give a receipt for what was handed over to him. Any false entry or claim on the agent's part was penalised three-fold, on the principal's part six-fold. In normal cases profits were divided according to contract, usually equally.

A considerable amount of forwarding was done by the caravans. The carrier gave a receipt for the consignment, took all responsibility and exacted a receipt on delivery. If he defaulted he paid five-fold. He was usually paid in advance. Deposit, especially warehousing of grain, was charged for at one-sixtieth. The warehouseman took all risks, paid double for all shortage, but no

claim could be made unless he had given a properly witnessed receipt. Water traffic on the Euphrates and canals was early very considerable. Ships, whose tonnage was estimated at the amount of grain they could carry, were continually hired for the transport of all kinds of goods. The Code fixes the price for building and insists on the builder's giving a year's guarantee of seaworthiness. It fixes the hire of ship and of crew. The captain was responsible for the freight and the ship; he had to replace all loss. Even if he refloated the ship he had to pay a fine of half its value for sinking it. In the case of collision the boat under way was responsible for damages to the boat at anchor. The Code also regulated the liquor traffic, fixing a fair price for beer and forbidding the connivance of the tavern-keeper (a female!) at disorderly conduct or treasable assembly, under pain of death. She was to hale the offenders to the palace, which implied an efficient and accessible police system.

Payment through a banker or by written draft against deposit was frequent. Bonds to pay were treated as negotiable. Interest was rarely charged on advances by the temple or wealthy landowners for pressing needs, but this may have been part of the metayer system. The borrowers may have been tenants. Interest was charged at very high rates for overdue loans of this kind. Merchants (and even temples in some cases) made ordinary business loans, charging from 20 to 30%.

Marriage retained the form of purchase, but was essentially a contract to be man and wife together. The marriage of young people was usually arranged between the relatives, the bridegroom's father providing the bride-price, which with other presents the suitor ceremonially presented to the bride's father. This bride-price was usually handed over by her father to the bride on her marriage, and so came back into the bridegroom's possession, along with her dowry, which was her portion as a daughter. The bride-price varied much, according to the position of the parties, but was in excess of that paid for a slave. The Code enacted that if the father does not, after accepting a man's presents, give him his daughter, he must return the presents doubled. Even if his decision was brought about by libel on the part of the suitor's friend this was done, and the Code enacted that the faithless friend should not marry the girl. If a suitor changed his mind, he forfeited the presents. The dowry might include real estate, but generally consisted of personal effects and household furniture. It remained the wife's for life, descending to her children, if any; otherwise returning to her family, when the husband could deduct the bride-price if it had not been given to her, or return it, if it had. The marriage ceremony included joining of hands and the utterance of some formula of acceptance on the part of the bridegroom, as "I am the son of nobles, silver and gold shall fill thy lap, thou shalt be my wife, I will be thy husband. Like the fruit of a garden I will give thee offspring." It must be performed by a freeman.

The marriage contract, without which the Code ruled that the woman was no wife, usually stated the consequences to which each party was liable for repudiating the other. These by no means necessarily agree with the Code. Many conditions might be inserted: as that the wife should act as maid-servant to her mother-in-law, or to a first wife. The married couple formed a unit as to external responsibility, especially for debt. The man was responsible for debts contracted by his wife, even before her marriage, as well as for his own; but he could use her as a mancipium. Hence the Code allowed a proviso to be inserted in the marriage contract, that the wife should not be seized for her husband's pre-nuptial debts; but enacted that then he was not responsible for her pre-nuptial debts, and, in any case, that both together were responsible for all debts contracted after marriage. A man might make his wife a settlement by deed of gift, which gave her a life interest in part of his property, and he might reserve to her the right to bequeath it to a favourite child, but she could in no case leave it to her family. Although married she always remained a member of her father's house—she is rarely named wife of A, usually daughter of B, or mother of C.

Divorce was optional with the man, but he had to restore the dowry and, if the wife had borne him children, she had the

custody of them. He had then to assign her the income of field, or garden, as well as goods, to maintain herself and children until they grew up. She then shared equally with them in the allowance (and apparently in his estate at his death) and was free to marry again. If she had no children, he returned her the dowry and paid her a sum equivalent to the bride-price, or a mina of silver, if there had been none. The latter is the forfeit usually named in the contract for his repudiation of her.

If she had been a bad wife, the Code allowed him to send her away, while he kept the children and her dowry; or he could degrade her to the position of a slave in his own house, where she would have food and clothing. She might bring an action against him for cruelty and neglect and, if she proved her case, obtain a judicial separation, taking with her her dowry. No other punishment fell on the man. If she did not prove her case, but was proved to be a bad wife, she was drowned. If she were left without maintenance during her husband's involuntary absence, she could cohabit with another man, but must return to her husband if he came back, the children of the second union remaining with their own father. If she had maintenance, a breach of the marriage tie was adultery. Wilful desertion by, or exile of, the husband dissolved the marriage, and if he came back he had no claim on her property; possibly not on his own.

As a widow, the wife took her husband's place in the family, living on in his house and bringing up the children. She could only remarry with judicial consent, when the judge was bound to inventory the deceased's estate and hand it over to her and her new husband in trust for the children. They could not alienate a single utensil. If she did not remarry, she lived on in her husband's house and took a child's share on the division of his estate, when the children had grown up. She still retained her dowry and any settlement decided to her by her husband. This property came to her children. If she had remarried, all her children shared equally in her dowry, but the first husband's gift fell to his children or to her selection among them, if so empowered.

Monogamy was the rule, and a childless wife might give her husband a maid (who was no wife) to bear him children, who were reckoned hers. She remained mistress of her maid and might degrade her to slavery again for insolence, but could not sell her if she had borne her husband children. If the wife did this, the Code did not allow the husband to take a concubine. If she would not, he could do so. The concubine was a wife, though not of the same rank; the first wife had no power over her. A concubine was a free woman, was often dowered for marriage and her children were legitimate. She could only be divorced on the same conditions as a wife. If a wife became a chronic invalid, the husband was bound to maintain her in the home they had made together, unless she preferred to take her dowry and go back to her father's house; but he was free to remarry. In all these cases the children were legitimate and legal heirs.

There was, of course, no hindrance to a man having children by a slave girl. These children were free, in any case, and their mother could not be sold, though she might be pledged, and she was free on her master's death. These children could be legitimized by their father's acknowledgment before witnesses, and were often adopted. They then ranked equally in sharing their father's estate, but if not adopted, the wife's children divided and took first choice.

Vestal virgins were not supposed to have children, yet they could and often did marry. The Code contemplated that such a wife would give a husband a maid as above. Free women might marry slaves and be dowered for the marriage. The children were free, and at the slave's death the wife took her dowry and half what she and her husband had acquired in wedlock for self and children; the master taking the other half as his slave's heir.

A father had control over his children till their marriage. He had a right to their labour in return for their keep. He might hire them out and receive their wages, pledge them for debt, even sell them outright. Mothers had the same rights in the absence of the father; even elder brothers when both parents were dead.

A father had no claim on his married children for support, but they retained a right to inherit on his death.

The daughter was not only in her father's power to be given in marriage, but he might dedicate her to the service of some god as a vestal or a hierodule; or give her as a concubine. She had no choice in these matters, which were often decided in her childhood. A grown-up daughter might wish to become a votary, perhaps in preference to an uncongenial marriage, and it seems that her father could not refuse her wish. In all these cases the father might dower her. If he did not, on his death the brothers were bound to do so, giving her a full child's share if a wife, a concubine or a vestal, but one-third of a child's share if she were a hierodule or a Marduk priestess. The latter had the privilege of exemption from state dues and absolute disposal of her property. All other daughters had only a life interest in their dowry, which reverted to their family, if childless, or went to their children if they had any. A father might, however, execute a deed granting a daughter power to leave her property to a favourite brother or sister. A daughter's estate was usually managed for her by her brothers, but if they did not satisfy her, she could appoint a steward. If she married, her husband managed it.

The son also appears to have received his share on marriage, but did not always then leave his father's house; he might bring his wife there. This was usual in child marriages.

Adoption was very common, especially where the father (or mother) was childless or had seen all his children grow up and marry away. The child was then adopted to care for the parents' old age. This was done by contract, which usually specified what the parent had to leave and what maintenance was expected. The real children, if any, were usually consenting parties to an arrangement which cut off their expectations. They even, in some cases, found the estate for the adopted child who was to relieve them of a care. If the adopted child failed to carry out the filial duty the contract was annulled in the law courts. Slaves were often adopted and if they proved unfilial were reduced to slavery again.

A craftsman often adopted a son to learn the craft. He profited by the son's labour. If he failed to teach his son the craft, that son could prosecute him and get the contract annulled. This was a form of apprenticeship, and it is not clear that the apprentice had any filial relation.

A man who adopted a son, and afterwards married and had a family of his own, could dissolve the contract but must give the adopted child one-third of a child's share in goods, but no real estate. That could only descend in the family to which he had ceased to belong. Vestals frequently adopted daughters, usually other vestals, to care for their old age.

Adoption had to be with consent of the real parents, who usually executed a deed making over the child, who thus ceased to have any claim upon them. But vestals, hierodules, certain palace officials and slaves had no rights over their children and could raise no obstacle. Foundlings and illegitimate children had no parents to object. If the adopted child discovered his true parents and wanted to return to them, his eye or tongue was torn out. An adopted child was a full heir, the contract might even assign him the position of eldest son. Usually he was residuary legatee.

All legitimate children shared equally in the father's estate at his death, reservation being made of a bride-price for an unmarried son, dower for a daughter or property deeded to favourite children by the father. There was no birthright attaching to the position of eldest son, but he usually acted as executor and after considering what each had already received equalized the shares. He even made grants in excess to the others from his own share. When there were two mothers, the two families shared equally in the father's estate until later times when the first family took two-thirds. Daughters, in the absence of sons, had sons' rights. Children also shared their own mother's property, but had no share in that of a stepmother.

A father could disinherit a son in early times without restriction, but the Code insisted upon judicial consent and that only for repeated unfilial conduct. In early times the son who denied his father had his front hair shorn, a slave-mark put on him, and

could be sold as a slave; while if he denied his mother he had his front hair shorn, was driven round the city as an example and expelled his home, but not degraded to slavery.

Adultery was punished with the death of both parties by drowning, but if the husband was willing to pardon his wife, the king might intervene to pardon the paramour. For incest with his own mother, both were burned to death; with a stepmother, the man was disinherited; with a daughter, the man was exiled; with a daughter-in-law, he was drowned; with a son's betrothed, he was fined. A wife who for her lover's sake procured her husband's death was gibbeted. A betrothed girl, seduced by her prospective father-in-law, took her dowry and returned to her family, and was free to marry as she chose.

In the criminal law the ruling principle was the *lex talionis*. Eye for eye, tooth for tooth, limb for limb was the penalty for assault upon an *amelu*. A sort of symbolic retaliation was the punishment of the offending member, seen in the cutting off the hand that struck a father or stole a trust; in cutting off the breast of a wet-nurse who substituted a changeling for the child entrusted to her; in the loss of the tongue that denied father or mother (in the *Elamite* contracts the same penalty was inflicted for perjury); in the loss of the eye that pried into forbidden secrets. The loss of the surgeon's hand that caused loss of life or limb; or the brander's hand that obliterated a slave's identification mark, are very similar. The slave, who struck a freeman or denied his master, lost an ear, the organ of hearing and symbol of obedience. To bring another into danger of death by false accusation was punished by death. To cause loss of liberty or property by false witness was punished by the penalty the perjurer sought to bring upon another.

The death penalty was freely awarded for theft and other crimes regarded as coming under that head; for theft involving entrance of palace or temple treasury, for illegal purchase from minor or slave, for selling stolen goods or receiving the same, for common theft in the open (in default of multiple restoration) or receiving the same, for false claim to goods, for kidnapping, for assisting or harbouring fugitive slaves, for detaining or appropriating same, for brigandage, for fraudulent sale of drink, for disorderly conduct of tavern, for delegation of personal service, for misappropriating the levy, for oppression of feudal holders, for causing death of a householder by bad building. The manner of death is not specified in these cases. This death penalty was also fixed for such conduct as placed another in danger of death. A specified form of death penalty occurs in the following cases:—gibbeting (on the spot where crime was committed) for burglary, later also for encroaching on the king's highway, for getting a slave-brand obliterated, for procuring husband's death; burning for incest with own mother, for vestal entering or opening tavern, for theft at fire (on the spot); drowning for adultery, rape of betrothed maiden, bigamy, bad conduct as wife, seduction of daughter-in-law.

A curious extension of the *talionis* is the death of creditor's son for his father's having caused the death of debtor's son as mancipium; of builder's son for his father's causing the death of house-owner's son by building the house badly; the death of a man's daughter because her father caused the death of another man's daughter.

The contracts naturally do not concern such criminal cases as the above, as a rule, but marriage contracts do specify death by strangling, drowning, precipitation from a tower or pinnacle of the temple or by the iron sword for a wife's repudiation of her husband. We are quite without evidence as to the executive in all these cases.

Exile was inflicted for incest with a daughter; disinheritance for incest with a stepmother or for repeated unfilial conduct. Sixty strokes of an ox-hide scourge were awarded for a brutal assault on a superior, both being *amelu*. Branding (perhaps the equivalent of degradation to slavery) was the penalty for slander of a married woman or vestal. Deprivation of office in perpetuity fell upon the corrupt judge. Enslavement befell the extravagant wife and unfilial children. Imprisonment was common, but is not recognized by the Code.

The commonest of all penalties was a fine. This is awarded by the Code for corporal injuries to a *muskinu* or slave (paid to his master); for damages done to property, for breach of contract. The restoration of goods appropriated, illegally bought, or damaged by neglect, was usually accompanied by a fine, giving it the form of multiple restoration. This might be double, treble, fourfold, fivefold, sixfold, tenfold, twelvefold, even thirtyfold, according to the enormity of the offence.

The Code recognized the importance of intention. A man who killed another in a quarrel must swear he did not do so intentionally, and was then only fined according to the rank of the deceased. The Code does not say what would be the penalty of murder, but death is so often awarded where death is caused that we can hardly doubt that the murderer was put to death. If the assault only led to injury and was unintentional, the assailant in a quarrel had to pay the doctor's fees. A brander, induced to remove a slave's identification mark, could swear to his ignorance and was free. The owner of an ox which gored a man on the street was only responsible for damages if the ox was known by him to be vicious, even if it caused death. If the mancipium died a natural death under the creditor's hand, the creditor was scot free. In ordinary cases responsibility was not demanded for accident or for more than proper care. Poverty excused bigamy on the part of a deserted wife.

On the other hand carelessness and neglect were severely punished, as in the case of the unskilful physician, if it led to loss of life or limb his hands were cut off, a slave had to be replaced, the loss of his eye paid for to half his value; a veterinary surgeon who caused the death of an ox or ass paid quarter value; a builder, whose careless workmanship caused death, lost his life or paid for it by the death of his child, replaced slave or goods, and in any case had to rebuild the house or make good any damages due to defective building and repair the defect as well. The boat-builder had to make good any defect of construction or damage due to it for a year's warranty.

Throughout the Code respect is paid to status.

Suspicion was not enough. The criminal must be taken in the act, e.g. the adulterer, ravisher, &c. A man could not be convicted of theft unless the goods were found in his possession.

In the case of a lawsuit the plaintiff preferred his own plea. There is no trace of professional advocates, but the plea had to be in writing and the notary doubtless assisted in the drafting of it. The judge saw the plea, called the other parties before him and sent for the witnesses. If these were not at hand he might adjourn the case for their production, specifying a time up to six months. Guarantees might be entered into to produce the witnesses on a fixed day. The more important cases, especially those involving life and death, were tried by a bench of judges. With the judges were associated a body of elders, who shared in the decision, but whose exact function is not yet clear. Agreements, declarations and non-contentious cases are usually witnessed by one judge and twelve elders.

Parties and witnesses were put on oath. The penalty for false witness was usually that which would have been awarded the convicted criminal. In matters beyond the knowledge of men, as the guilt or innocence of an alleged wizard or a suspected wife, the ordeal by water was used. The accused jumped into the sacred river, and the innocent swam while the guilty drowned. The accused could clear himself by oath where his own knowledge was alone available. The plaintiff could swear to his loss by brigands, as to goods claimed, the price paid for a slave purchased abroad or the sum due to him. But great stress was laid on the production of written evidence. It was a serious thing to lose a document. The judges might be satisfied of its existence and terms by the evidence of the witnesses to it, and then issue an order that whenever found it should be given up. Contracts annulled were ordered to be broken. The court might go a journey to view the property and even take with them the sacred symbols on which oath was made.

The decision given was embodied in writing, sealed and witnessed by the judges, the elders, witnesses and a scribe. Women might act in all these capacities. The parties swore an

oath, embodied in the document, to observe its stipulations. Each took a copy and one was held by the scribe to be stored in the archives.

Appeal to the king was allowed and is well attested. The judges at Babylon seem to have formed a superior court to those of provincial towns, but a defendant might elect to answer the charge before the local court and refuse to plead at Babylon.

Finally, it may be noted that many immoral acts, such as the use of false weights, lying, &c., which could not be brought into court, are severely denounced in the Omen Tablets as likely to bring the offender into "the hand of God" as opposed to "the hand of the king."

BIBLIOGRAPHY.—Contracts in general: Oppert and Menant, *Documents juridiques de l'Assyrie et de la Chaldée* (Paris, 1877); J. Kohler and F. E. Peiser, *Aus dem babylonischen Rechtsleben* (Leipzig, 1890 ff.); F. E. Peiser, *Babylonische Verträge* (Berlin, 1890), *Keilschriftliche Actenstücke* (Berlin, 1889); Br. Meissner, *Beiträge zur althebräischen Privatrecht* (Leipzig, 1893); F. E. Peiser, "Texte juristischen und geschäftlichen Inhalts," vol. iv. of Schrader's *Keilschriftliche Bibliothek* (Berlin, 1896); C. H. W. Johns, *Assyrian Deeds and Documents relating to the Transfer of Property* (3 vols., Cambridge, 1898); H. Radau, *Early Babylonian History* (New York, 1900); C. H. W. Johns, *Babylonian and Assyrian Laws, Contracts and Letters* (Edinburgh, 1904). For editions of texts and the innumerable articles in scientific journals see the bibliographies and references in the above works. "The Code of Hammurabi," *Éditio princeps*, by V. Schell in tome iv. of the *Textes Élamites-Sémittiques de la Mission de la délégation en Perse* (Paris, 1902); H. Winkler, "Die Gesetze Hammurabis Königs von Babylon um 2250 v. Chr.," *Der alte Orient*, iv. Jahrgang, Heft 4; D. H. Müller, *Die Gesetze Hammurabis* (Vienna, 1903); J. Kohler and F. E. Peiser, *Hammurabi Gesetze* (Leipzig, 1904); R. F. Harper, *The Code of Hammurabi, King of Babylon about 2250 B.C.* (Chicago, 1904); S. A. Cook, *The Laws of Moses and the Code of Hammurabi* (London, 1903). (C. H. W. J.)

BACAU, the capital of the department of Bacau, in Rumania; situated among the foothills of the Carpathian Mountains, and on the river Bistritza, which enters the river Sereth 5 m. S. Pop. (1900) 16,187, including 7850 Jews. Although of modern growth, Bacau is one of the chief commercial centres in Moldavia, possessing many large timber yards. It is on the main railway from Czernowitz, in Bukovina, to Galatz; and on two branch lines, one of which enters Transylvania through the Ghimes Pass, while both give access to the salt mines, petroleum wells and forests of the Carpathians.

BACCARAT, a gambling card-game (origin of name unknown), supposed to have been introduced into France from Italy during the reign of Charles VIII. There are two accepted varieties of the game—*baccarat chemin de fer* (railway) and *baccarat banque* (or *à deux tableaux*). In *baccarat chemin de fer* six full packs of cards are used. These are shuffled by a croupier and then by any of the players who wish to do so. From three to eleven players may play. Counters are generally used and are sold by the banker who afterwards redeems them. The croupier takes a number of cards from the top of the pack and passes them to the player on his right (sometimes left) who becomes banker, a position which he holds until he loses, when the deal passes to the player next in order. The other players are called *punters*. The banker places before him the sum he wishes to stake and the punters do likewise, unless a punter desires to *go bank*, signifying his intention by saying, *Banco!* In this case he plays against the entire stake of the banker. After the stakes have been made the dealer deals a card to his right for the punters, then one to himself, then a third to his left for the punters and, finally, another to himself, all face downwards. Court cards and tens count nothing; all others the number of their pips. Each punter looks at his cards, and any one having 8 or 9 turns his card up and announces it, the hand then being at an end. The player having the highest stake plays for both punters, and if the card turned is better than that of the banker, the latter pays each punter the amount of his stake. If not, the banker wins all stakes and the game proceeds as before. If no announcement is made, meaning that neither player holds 8 or 9, the banker deals another card to the player on his right, who, if his first card is 6 or 7, will refuse it, fearing to overrun. The second card is turned face upwards on the table. If his card is 5 he may, or may not, accept the

second card, according to his judgment. In case of his refusal the card is offered to the second punter. If the first card is *baccarat* (i.e. amounts to 0) or 1, 2, 3 or 4, a punter always accepts the second card. The banker then decides whether he will draw another card himself or expose his original ones, and when he has made his play pays or receives according as he wins or loses. Ties neither win nor lose but go over to the next deal. A player who has lost on *going bank* may go bank again, but no player may go bank more than twice in succession. In the variation *baccarat banque* (or *à deux tableaux*), three packs of cards are used and the banker is permanent; the player who offers to risk the largest amount occupying the position. A line is drawn across the table and any one wishing to do so may place his stake *à cheval*, i.e. on the line. Stakes so placed neither win nor lose if one side wins and the other loses, but win if both sides win and are lost if both sides lose. The laws of *baccarat* are complicated and no one code is accepted as authoritative, the different clubs making their own rules.

See Badoureaux, *Étude mathématique sur le jeu de baccarat* (Paris, 1881); L. Billard, *Breviaire du baccarat expérimental* (Paris, 1883).

BACCHANALIA, the Lat. name for the wild and mystic festivals of Bacchus (Dionysus). They were introduced into Rome from lower Italy by way of Etruria, and held in secret, attended by women only, on three days in the year in the grove of Simila (*Stimula, Semele*; Ovid, *Fasti*, vi. 503), near the Aventine hill. Subsequently, admission to the rites were extended to men and celebrations took place five times a month. The evil reputation of these festivals, at which the grossest debaucheries took place, and all kinds of crimes and political conspiracies were supposed to be planned, led in 186 B.C. to a decree of the senate—the so-called *Senatus consultum de Bacchanalibus*, inscribed on a bronze tablet discovered in Calabria (1640), now at Vienna—by which the Bacchanalia were prohibited throughout the whole of Italy, except in certain special cases, in which the senate reserved the right of allowing them, subject to certain restrictions. But, in spite of the severe punishment inflicted upon those who were found to be implicated in the criminal practices disclosed by state investigation, the Bacchanalia were not stamped out, at any rate in the south of Italy, for a very long time (Livy xxxix. 8-19, 41; xl. 19).

BACCHYLIDES, Greek lyric poet, was born at Iulis, in the island of Ceos. His father's name was probably Meidon; his mother was a sister of Simonides, himself a native of Iulis. Eusebius says that Bacchylides "flourished" (ἤκμασεν) in Ol. 78. 2 (467 B.C.). As the term ἤκμασεν refers to the physical prime, and was commonly placed at about the fortieth year, we may suppose that Bacchylides was born circa 507 B.C. Among his Odes the earliest that can be approximately dated is xii.¹ which may belong to 481 or 479 B.C.; the latest is vi., of which the date is fixed by the recently found fragment of the Olympic register to Ol. 82. 1 (452 B.C.). He would thus have been some forty-nine years younger than his uncle Simonides, and some fifteen years younger than Pindar. Elsewhere Eusebius states that Bacchylides "was of repute" (ἐπισημοῦσεν) in Ol. 87. 2 (431 B.C.); and Georgius Syncellus, using the same word, gives Ol. 88. (428-425 B.C.). The phrase would mean that he was then in the fulness of years and of fame. There is nothing improbable in the supposition that he survived the beginning of the Peloponnesian war.

Bacchylides, like Simonides and Pindar, visited the court of Hiero I. of Syracuse (478-467). In his fifth Ode (476 B.C.), the word *ἔξως* (v. 11) has been taken to mean that he had already been the guest of the prince; and, as Simonides went to Sicily in or about 477 B.C., that is not unlikely. Ode iii. (468 B.C.) was possibly written at Syracuse, as verses 15 and 16 suggest. He there pays a high compliment to Hiero's taste in poetry (ver. 3 ff.). A scholium on *Pylis*, ii. 90 (106) avers that Hiero preferred the Odes of Bacchylides to those of Pindar. The Alexandrian scholars interpreted a number of passages in Pindar as hostile allusions to Bacchylides or Simonides. If the scholiasts

¹ The references are given according to the numbering in Jebb's edition.

are right, it would appear that Pindar regarded the younger of the two Cean poets as a jealous rival, who disparaged him to their common patron (schol. *Pyth.* ii. 52 f.), and as one whose poetical skill was due to study rather than to genius (*Ol.* ii. 91-110). In *Olymp.* ii. 96 the dual *γαβηροσ*, if it does not refer to the uncle and nephew, remains mysterious; nor does it admit of probable emendation.¹ One would gladly reject this tradition, to which the scholia so frequently refer; yet it would be rash to assume that it rested merely on surmise. The Alexandrians may have possessed evidence on the subject which is now lost. It is tolerably certain that the three poets were visitors at Hiero's court at about the same time: Pindar and Bacchylides wrote odes of the same kind in his honour; and there was a tradition that he preferred the younger poet. There is thus no intrinsic improbability in the hypothesis that Pindar's haughty spirit had suffered, or imagined, some mortification. It is noteworthy that, whereas in 476 and 470 both he and Bacchylides celebrated Hiero's victories, in 468 (the most important occasion of all) Bacchylides alone was commissioned to do so; although in that year Pindar composed an ode (*Olymp.* vi.) for another Syracusean victor at the same festival. Nor is it difficult to conceive that a despot such as Hiero, whose constitutional position was ill-defined, and who was perhaps all the more exigent of deference on that account, may have found the genial Ionian a more agreeable courtier than Pindar, an aristocrat of the Boeoto-Aeolic type, not unmindful of "his father's Aegidae," and rather prone to link the praises of his patron with a lofty intimation of his own claims (see, e.g., *Olymp.* i. *ad fin.*). But, whatever may have been the true bearing of Pindar's occasional innuendoes, it is at any rate pleasant to find that in the extant work of Bacchylides there is not the faintest semblance of hostile allusion to any rival. Nay, one might almost imagine a compliment to Pindar, when, in mentioning Hesiod, he calls him *Βακχιδῶσ ἀντῖπῳ*.

Plutarch (*de Exilio*, p. 605 c) names Bacchylides in a list of writers, after they had been banished from their native cities, were active and successful in literature. It was Peloponnesus that afforded a new home to the exiled poet. The passage gives no clue to date or circumstance; but it implies that Peloponnesus was the region where the poet's genius ripened and where he did the work which established his fame. This points to a residence of considerable length; and it may be noted that some of the poems illustrate their author's intimate knowledge of Peloponnesus. Thus in *Ode viii.*, for Automedes of Phlius, he draws on the legends connected with the Phliasian river Asopus. In *Ode x.*, starting from the Argive legend of Proetus and Acrisius, he tells how the Arcadian cult of Artemis *Ἡμέρα* was founded. In one of his dithyrambs (xix.) he treated the legend of Idas (a Messenian hero) and Marpessa in the form of a *hymenaeus* sung by maidens of Sparta.

The Alexandrian scholars, who drew up select lists of the best writers in each kind, included Bacchylides in their "canon" of the nine lyric poets, along with Alcman, Sappho, Alcaeus, Stesichorus, Ibycus, Anacreon, Simonides and Pindar. The Alexandrian grammarian Didymus (*circ.* 30 B.C.) wrote a commentary on the epinician odes of Bacchylides. Horace, a poet in some respects of kindred genius, was a student of his works, and imitated him (according to Porphyry) in *Odes*, i. 15, where Nereus predicts the destruction of Troy. Quotations from Bacchylides, or references to him, occur in Dionysius of Halicarnassus, Strabo, Plutarch, Stobaeus, Athenaeus, Aulus Gellius, Zenobius, Hephaestion, Clement of Alexandria, and various grammarians or scholiasts. Ammianus Marcellinus (xxv. 4) says that the emperor Julian enjoyed reading Bacchylides. It is clear, then, that this poet continued to be popular during at least the first four centuries of our era. No inference adverse to his repute can fairly be drawn from the fact that no mention of him occurs in the extant work of any Attic writer. The only definite estimate of him by an ancient critic occurs in the treatise *Ἐπιτῶσ* commonly translated "On the Sublime," but meaning rather,

"On the Sources of Elevation in Style"; a work ambiguously ascribed to Cassius Longinus (*circ.* A.D. 260), but more probably due to some writer of the first century of our era. In chapter xxxiii. of that treatise, the author asks whether we ought to prefer "greatness" in literature, with some attendant faults, to flawless merit on a lower level, and of course replies in the affirmative. In tragedy, he asks, who would be Ion of Chios rather than Sophocles; or in lyric poetry, Bacchylides rather than Pindar? Yet Bacchylides and Ion are "faultless, with a style of perfect elegance and finish." In short, the essayist regards Bacchylides as a thoroughly finished poet of the second class, who never commits glaring faults, but never reaches the loftier heights.

The first and most general quality of style in Bacchylides is his perfect simplicity and clearness. Where the text is not corrupt, there are few sentences which are not lucid in meaning and simple in structure. This lucidity is partly due, no doubt, to the fact that he seldom attempts imagery of the bolder kind, and never has thoughts of a subtle or complex order. Yet it would be very unjust to regard such clearness as merely a compensatory merit of lyric mediocrity, or to ignore its intimate connexion with the man's native grace of mind, with the artist's feeling for expression, with the poet's delicate skill. How many readers, who could enjoy and appreciate Pindar if he were less difficult, are stopped on the threshold by the aspect of his style, and are fain to save their self-esteem by concluding that he is at once turgid and shallow! A pellucid style must always have been a source of wide, though modest, popularity for Bacchylides. If it be true that Hiero preferred him to Pindar, and that he was a favourite with Julian, those instances suggest the charm which he must always have had for cultivated readers to whom affairs did not leave much leisure for study, and who rejoiced in a poet with whom they could live on such easy terms.

Another prominent trait in the style of Bacchylides is his love of picturesque detail. This characteristic marks the fragment by which, before the discovery of the 1896 MS., he was best known—a passage, from one of his paean, on the blessings of peace (fr. 13, Bergk, 3, Jebb); and it frequently appears in the Odes, especially in the mythical narratives. Greater poets can make an image flash upon the mind, as Pindar sometimes does, by a magic phrase, or by throwing one or two salient points into strong relief. The method of Bacchylides is usually quieter; he paints cabinet pictures. Observation and elegance do more for him than grasp or piercing insight; but his work is often of very high excellence in its own kind. His treatment of simile is only a special phase of this general tendency. It is exemplified by the touches with which he elaborates the simile of the eagle in *Ode v.*, and that of the storm-tossed mariners in *Ode xii.* This full development of simile is Homeric in manner, but not Homeric in motive: Homer's aim is vividness; Bacchylides is rather intent on the decorative value of the details themselves. There are occasional flashes of brilliancy in his imagery, when it is lit up by his keen sense of beauty or splendour in external nature. A radiance, "as of fire," streams from the forms of the Nereids (xvi. 103 ff.). An athlete shines out among his fellows like "the bright moon of the mid-month night" among the stars (viii. 27 ff.). The sudden gleam of hope which comes to the Trojans by the withdrawal of Achilles is like a ray of sunshine "from beneath the edge of a storm-cloud" (xii. 105 ff.). The shades of the departed, as seen by Heracles on the banks of the Cocytus, are compared to the countless leaves fluttering in the wind on "the gleaming headlands of Ida" (v. 65 ff.)—an image not unworthy of Dante or of Milton.

Among the minor features of this poet's style the most remarkable is his use of epithets. A god or goddess nearly always receives some ornamental epithet; sometimes, indeed, two or even three (e.g. *καλοκοσμητῶσ σελῆσ . . . Ἀρεμῖδῶσ Λευκαλέων*, v. 98 f.). Such a trait is in unison with the epic manner, the straightforward narrative, which we find in some of the larger poems (as in v., x., and xvi.). On the other hand, the copious use of such ornament has the disadvantage that it sometimes gives a tinge of conventionality to his work. This impression is somewhat strengthened by the fact that many

¹ For other explanations suggested, see Jebb's edition, *Introd.* p. 18.

of the epithets are long compound words, not found elsewhere and (in some cases at least) probably invented by the poet; words which suggest a deliberate effort to vary the stock repertory.

The poems contained in the MS. of Bacchylides found (see below) in 1896 are of two classes: I. *Odes of Victory*; II. *Dithyrambs*. The Ode of Victory, *ἐπιπνίκιον* (*μῦθος*) or *ἐπιπνίος* (*ἄσμα*), is a form derived from the *ἔπος*, which was properly a song in praise of a deity. Stesichorus (c. 610 B.C.) seems to have been the first who composed hymns in honour, not of gods, but of heroes; the next step was to write hymns in celebration of victories by living men. This custom arose in the second half of the 6th century B.C., the age in which the games at the four great Greek festivals reached the fulness of their popularity. Simonides (b. c. 556 B.C.) was the earliest recorded writer of *epinikia*. His odes of this class are now represented only by a few very small fragments, some twenty lines in all. Two of these fragments, belonging to the description of a chariot-race, warrant the belief that Simonides, in his *epinikia*, differed from Pindar in dwelling more on the incidents of the particular victory. The same characteristic is found in the *epinikia* of Bacchylides. His fifth ode, and Pindar's first *Olympian*, alike celebrate the victory of the horse Phrenicus; but, while Pindar's reference to the race itself is slight and general (vv. 20-22), Bacchylides describes the running of the winner much more vividly and fully (vv. 37-49).

The MS. contains fourteen *epinikia*, or thirteen if Blass be right in supposing that Odes vi. and vii., as numbered by Kenyon in the *editio princeps*, are parts of a single ode (for Lachon of Ceos). Four (or on the view just stated, three) of the odes relate to the Olympian festival; two to the Pythian; three to the Isthmian; three to the Nemean; and one to a Thessalian festival called the *Περαία*. This comes last. The order in which the MS. arranges the other *epinikia* seems to be casual; at least it does not follow (1) the alphabetical sequence of the victors' names, or of the names of their cities; nor (2) chronological sequence; nor (3) classification by contests; nor (4) classification by festivals—except that the four great festivals precede the *Petraea*. The first ode, celebrating a victory of the Cean Argeios at the Isthmus, may possibly have been placed there for a biographical reason, viz., because the poet treated in it the early legends of his native island.

A mythical narrative, connected in some way with the victor or his city, usually occupies the central part of the Pindaric ode. It serves to lift the poem into an ideal region, and to invest it with more than a local or temporary significance. The method of Bacchylides in this department of the *epinikian* is best illustrated by the myth of Croesus in Ode iii., that of Hercules and Meleager in Ode v., and that of the Proetides in Ode x. Pindar's habit is to select certain moments or scenes of a legend, which he depicts with great force and vividness. Bacchylides, on the other hand, has a gentle flow of simple epic narrative; he relies on the interest of the story as a whole, rather than on his power of presenting situations. Another element, always present in the longer odes of victory, is that which may be called the "gnomic." Here, again, there is a contrast between the two poets. Pindar packs his *γνώμαι*, his maxims or moral sentiments, into terse and sometimes obscure epigrams; he utters them in a didactic tone, as of one who can speak with the commanding voice of Delphic wisdom. The moralizing of Bacchylides is rather an utterance of quiet meditation, sometimes recalling the strain of Ionian gnomic elegy.

The *epinikia* of Bacchylides are followed in the MS. by six compositions which the Alexandrians classed under the general name of *διδυράμβου*, and which we, too, must be content to describe collectively as *Dithyrambs*. The derivation of *διδυράμβου* is uncertain: *δι* may be the root seen in *διος* (cp. *διδύμια*), and *θύραμβος* another form of *θύραμβος*, a word by which Cratinus (c. 448 B.C.) denotes some kind of hymn to the wine-god. The "dithyramb," first mentioned by Archilochus (c. 670 B.C.), received a finished and choral form from Arion of Lesbos (c. 600 B.C.). His dithyrambs, produced at Corinth, belonged to the cult of Dionysus, and the members of his chorus (*τραγικός χορός*) personated satyrs. Originally concerned with the birth of the god, the dithyramb came to deal

with all his fortunes: then its scope became still larger; it might celebrate, not Dionysus alone, but any god or hero. This last development had taken place before the close of the 6th century B.C. Simonides wrote a dithyramb on Memnon and Tithonus; Pindar, on Orion and on Heracles. Hence the Alexandrian scholars used *διδυράμβου* in a wide sense, as denoting simply a lyric poem occupied with a mythical narrative. This Ode xvii. of Bacchylides (relating the voyage of Theseus to Crete), though it was clearly a *παῖον* for the Delian Apollo, was classed by the Alexandrians among his "dithyrambs"—as appears not only from its place in our MS., but also from the allusion of Servius (on *Aen. vi.* 21). The six dithyrambs of Bacchylides are arranged in (approximately) alphabetical order: *Ἀρρηγορίδαι*, *Ἡρακλῆος*, *Ἡΐθεα*, *τῶν ἑσπείων*, *Θησέως*, *Ἰδῶ*, *Ἰδῶος*. The principal feature, best exemplified by the first and third, is necessarily epic narrative,—often adorned with touches of picturesque detail, and animated by short speeches in the epic manner.

Several other classes of composition are represented by those fragments of Bacchylides, preserved in ancient literature, which were known before the discovery of the new MS. (1) *ἔμνημα*. Among these we hear of the *ἀποτραγωδικῶν*, hymns of pious farewell, speeding some god on his way at the season when he passed from one haunt to another. (2) *παῖνες*, represented by the well-known fragment on the blessings of peace. (3) *προσόδια*, choral odes sung during processions to temples. (4) *ἰσορχήματα*, lively dance-songs for religious festivals. (5) *ἐρωτικά*, represented by five fragments of a class akin to *σκόλια*, drinking-songs. Under this head come some lively and humorous verses on the power of wine, imitated by Horace (*Odes*, iii. 21. 13-20). It may be conjectured that the facile grace and bright fancy of Bacchylides were seen to especial advantage in light compositions of this kind. (6) The elegiacs of Bacchylides are represented by two *ἐπιγογγύσματα ἀναθηματικά*, each of four lines, in the Palatine Anthology. The first (*Anth. vi.* 313) is an inscription for an offering commemorative of a victory gained by a chorus with a poem written by Bacchylides. The second (*Anth. vi.* 53) is an inscription for a shrine dedicated to Zephyrus. Its authenticity has been questioned, but not disproved.

The papyrus containing the odes of Bacchylides was found in Egypt by natives, and reached the British Museum in the autumn of 1896. It was then in about 200 pieces. By the skill and industry of Mr F. G. Kenyon, the editor of the *editio princeps* (1897) the MS. was reconstructed from these lacerated members. As now arranged, the MS. consists of three sections. (1) The first section contains 22 columns of writing. It breaks off after the 8 opening verses of Ode xii. (2) The second section contains columns 23-29. Of these, column 23 is represented only by the last letters of two words. This section comprises what remains of Odes xiii. and xiv. It breaks off before the end of xiv., which is the last of the *epinikia*. (3) The third section comprises columns 30-39. It begins with the mutilated opening verses of Ode xv. (*Ἀρρηγορίδαι*, the first of the dithyrambs), and breaks off after verse 11 of the last dithyramb, *Ἰδῶος*. The number of lines in a column varies from 32 to 36, the usual number being 35, or (though less often) 34.

It is impossible to say how much has been lost between the end of column 29 and the beginning of column 30. Probably, however, Ode xiv., if not the last, was nearly the last of the *epinikia*. It concerns a festival of a merely local character, the Thessalian *Περαία*, and was therefore placed after the thirteen other *epinikia*, which are connected with the four great festivals. The same lacuna leaves it doubtful whether any collective title was prefixed to the *dithyramboi*. After the last column (39) of the MS., a good deal has probably been lost. Bacchylides seems to have written at least three other poems of this class (on Cassandra, Laocoon and Philoctetes); and these would have come, in alphabetical order, after the last of the extant six (*Idas*).

The writing of the MS. is a fine uncial. It presents some traits of a distinctly Ptolemaic type, though it lacks some features found in the earlier Ptolemaic MSS. (those of the 3rd and 2nd century B.C.). Among the characteristic forms of letters is the **τ**, with a shallow curve on the top of the upright; a form found in MSS. ascribed to the 1st century B.C., and different from the more fully formed upslon of the Roman period. Another very significant letter is the **ζ**, written as **ϛ**, a form which begins to go out after c. 50 B.C., giving place to the **η** in which the middle stroke is connected with the other two. From these and other indications it is probable that the MS. is not later than the middle of the 1st century B.C.

The scribe, though he sometimes corrected his own mistakes, was, on the whole, careless of the sense, as of the metre; he seems to have been a mechanical copyist, excellent in penmanship, but

intend only on the letters. The MS. has received corrections or small supplements from at least two different persons. One of them (Kenyon's A¹) was contemporary, or nearly so, with the scribe. The other (A²) was considerably later; he wrote a Roman curve which might belong to the end of the 1st century A.D., or to the early part of the 2nd. The correctors seem to be generally trustworthy; though, like the scribe, they were inattentive to metre, passing over many metrical faults which could easily have been removed. They appear to have compared their MS. with another, or others; but they sometimes made a bad use of such aid, intruding a false reading where their text had the true one.

Corrections are generally added, especially rough breathings; the form is usually square, but sometimes partially rounded. Accents are added, not to all words, but only, as a rule, to those which might cause doubt or difficulty to the reader. This was the Alexandrian practice, accents being regarded as aids to correct reading, and more liberally used when the dialect was not Attic. In accordance with the older system, the accent is not written on the last syllable of a word; when the accent falls there, a grave accent is written on the preceding syllable, or on two such syllables (e.g. *βῆλαρες, πῶδαλαρες*).

As Kenyon observes, no MS. of equal antiquity is so well supplied with accents. The MS. which comes nearest to it in this respect is the Alcanan fragment in the Louvre, which is of similar or slightly higher age, belonging perhaps to the early part of the 1st century A.D.; and in that MS. the comparatively frequent accents were doubtless designed to aid readers unfamiliar with Alcanan's Laconian Doric. With regard to other grammatical or metrical signs (*παρασημαία*) used in the Baccylides MS., there is not much that calls for special remark. The punctuation, whether by the scribe or by correctors, is very sparse, and certainly cannot always be regarded as authoritative. The signs denoting the end of a strophe or antistrophe (*στροφικὸς*), of an epode (*κορονίς*), or of an ode (*ἀστερίσκος*), are often omitted by the scribe, and, when employed, are sometimes placed incorrectly, or employed in an irregular manner.

EDITIONS.—F. G. Kenyon, *Ed. principes* (1897); F. Blass, 3rd ed. (1904); H. Jurenka (1898); N. Festa, text, translation and notes (1898). [The latest edition is by Sir Richard Jebb (1905), with introduction, notes, translation, and bibliography; text only (1906). See also T. Zanghieri, *Studi su Baccilide, Bibliografia Baccilidea, 1897-1905* (1905).] (R. C. J.)

BACCIO D'AGNOLO (c. 1460-1543), Florentine wood-carver, sculptor and architect, had the family name of Baglioni, but was always known by the abbreviation of Bartolommeo into Baccio and the use of d'Agnolo as meaning the son of Angelo, his father's name. He started as a wood-carver, and between 1491 and 1502 did much of the decorative carving in the church of Santa Maria Novella and the Palazzo Vecchio in Florence. Having made his reputation as a sculptor he appears to have turned his attention to architecture, and to have studied at Rome, though at what precise date is uncertain; but quite at the beginning of the 16th century he was engaged with Simon Pollajuolo in restoring the Palazzo Vecchio, and in 1506 he was commissioned to complete the drum of the cupola of the metropolitan church of Santa Maria del Fiore. The latter work, however, was interrupted on account of adverse criticisms from Michelangelo, and it remained unexecuted. Baccio d'Agnolo also planned the Villa Borghese and the Bartolini palace, with other fine palaces and villas. The Bartolini palace was the first house to be given frontispieces of columns to the door and windows, previously confined to churches; and he was ridiculed by the Florentines for his innovation. Another much-admired work by him was the campanile of the church of Santo Spirito. His studio was the resort of the most celebrated artists of the day, Michelangelo, Sansovino, the brothers Sangallo and the young Raphael. He died in 1543, leaving three sons, all architects, the best-known being Giuliano.

BACH, JOHANN SEBASTIAN (1685-1750), German musical composer. The Bach family was of importance in the history of music for nearly two hundred years. Four branches of it were known at the beginning of the 16th century, and in 1561 we hear of Hans Bach of Wechmar who is believed to be the father of Veit Bach (born about 1555). The family genealogy, drawn up by J. Sebastian Bach himself and completed by his son Philipp Emanuel, describes Veit Bach as the founder of the family, a baker and a miller, "whose zither must have sounded very pretty among the clattering of the mill-wheels." His son, Hans Bach, "der Spielmann," is the first professional musician of the family. Of Hans's large family the second son, Christoph, was the grandfather of Sebastian Bach. Another son,

Heinrich, of Arnstadt, had two sons, Johann Michael and Johann Christoph, who are among the greatest of J. S. Bach's fore-runners, Johann Christoph being now supposed (although this is still disputed) to be the author of the splendid motet, *Ich lasse dich nicht* ("I wrestle and pray"), formerly ascribed to Sebastian Bach. Another descendant of Veit Bach, Johann Ludwig, was admired more than any other ancestor by Sebastian, who copied twelve of his church cantatas and sometimes added work of his own to them.

The Bach family never left Thuringia until the sons of Sebastian went into a more modern world. Through all the misery of the peasantry at the period of the Thirty Years' War this clan maintained its position and produced musicians who, however local their fame, were among the greatest in Europe. So numerous and so eminent were they that in Erfurt musicians were known as "Bachs," even when there were no longer any members of the family in the town. Sebastian Bach thus inherited the artistic tradition of a united family whose circumstances had deprived them of the distractions of the century of musical fermentation which in the rest of Europe had destroyed polyphonic music.

Johann Sebastian Bach was baptized at Eisenach on the 23rd of March 1685. His parents died in his tenth year, and his elder brother, Johann Christoph, organist at Ohrdruf, took charge of him and taught him music. The elder brother is said to have been jealous of Sebastian's talent, and to have forbidden him access to a manuscript volume of works by Froberger, Buxtehude and other great organists. Every night for six months Sebastian got up, put his hand through the lattice of the bookcase, and copied the volume out by moonlight, to the permanent ruin of his eyesight (as is shown by all the extant portraits of him at a later age and by the blindness of his last years). When he had finished, his brother discovered the copy and took it away from him. In 1700 Sebastian, now fifteen and thrown on his own resources by the death of his brother, went to Lüneburg, where his beautiful soprano voice obtained him an appointment at the school of St Michael as chorister. He seems, however, to have worked more at instrumental than at vocal music. Apart from the choristers' routine, his position provided only for his general education, and we know little about his definite musical instructors. In any case he owed his musical development mainly to his own incessant study of classical and contemporary composers, such as Frescobaldi (c. 1587), Caspar Kerl (1628-1693), Buxtehude, Froberger, Muffat the elder, Pachelbel and probably Johann Joseph Fux (1660-1741), the author of the *Gradus ad Parnassum* on which all later classical composers were trained. A prettier and no less authentic story than that of his brother's forbidden organ-volume tells how, on his return from one of the many holiday expeditions which Bach made to Hamburg on foot to hear the great Dutch organist Reinken, he sat outside an inn longing for the dinner he could not afford, when two herring-heads were flung out of the window, and he found in each of them a ducat with which he promptly paid his way, not home, but back to Hamburg. At Hamburg, also, Keiser was laying the foundations of German opera on a splendid scale which must have fired Bach's imagination though it never directly influenced his style. On the other hand Keiser's church music was of immense importance in his development. In Celle the famous *Hofkapelle* brought the influence of French music to bear upon Bach's art, an influence which inspired nearly all his works in suite-form and to which his many autograph copies of Couperin's music bear testimony. Indeed, there is no branch of music, from Palestrina onwards, conceivably accessible in Bach's time, of which we do not find specimens carefully copied in his own handwriting. On the other hand, when Bach, at the age of nineteen, became organist at Arnstadt, he found Lübeck within easy distance, and there, in October 1705, he went to hear Buxtehude, whose organ works show so close an affinity to Bach's style that only their lack of coherence as wholes reveals to the attentive listener that with all their nobility they are not by Bach himself. Bach's enthusiasm for Buxtehude caused him to outstay his leave by three months, and this, together with his

habit of astonishing the congregation by the way he harmonized the chorales got him into trouble. But he was already too great an ornament to be lightly dismissed; and though his answers to the complaints of the authorities (every word of which makes amusing reading in the archives of the church) were spirited rather than satisfactory, and the *consistorium* had to add to their complaints the grave scandal of his allowing a "strange maiden" to sing in the church,¹ Bach was able to maintain his position at Arnstadt until he obtained the organistship of St Blasius in Mühlhausen in 1707. Here he married his cousin, easily identified with the "strange maiden" of Arnstadt; and here he wrote his first great church cantatas, *Aus der Tiefe, Gott ist mein König* and *Gottes Zeit*.

Bach's mastery of the keyboard attracted universal attention, and prevented his ever being unemployed. In 1708 he went to Weimar where his successes were crowned by his appointment, in 1714, at the age of twenty-nine, as *Hofkonzertmeister* to the duke of Weimar. Here the composition of sacred music was one of his most congenial duties, and the great cantata, *Ich hatte viel Bekümmerniss*, was probably the first work of his new office. In 1717 Bach visited Dresden in the course of a concert tour, and was induced to challenge the arrogant French organist, J. Louis Marchand, who was making himself thoroughly disliked by the German musicians who could not deny his powers. Bach was first given an opportunity of listening secretly to Marchand's playing, then a competition on the organ was proposed, and a day was fixed for the tournament at which all the court and all the musical celebrities of the town were to be present, to see nothing less than the issue between French and German music. Marchand took up the challenge contemptuously; but it would appear that he also was allowed to listen secretly to Bach's playing, for on the day of the tournament the only news of him was that he had left Dresden by the earliest coach.

This triumph was followed by Bach's appointment as *Kapellmeister* to the duke of Cöthen, a post which he held from 1717 to 1723. The Cöthen period is that of Bach's central instrumental works, such as the first book of the *Wohltemperiertes Klavier*, the solo violin and violoncello sonatas, the Brandenburg concertos, and the French and English suites.

In 1723, finding his position at Cöthen uninspiring for choral music, he removed to Leipzig, where he became cantor of the Thomasschule, being still able to retain his post as visiting *Kapellmeister* at Cöthen, besides a similar position at Weissenfels. His wife had died in 1720, leaving seven children, of whom Friedermann and Philipp Emanuel had a great future before them. (For his sons see BACH, K. P. E., below.) In December 1721 Bach married again, and for the beautiful soprano voice of his second wife he wrote many of his most inspired arias. She was a great help to him with all his work, and her musical handwriting soon became so like his own that her copies are difficult to distinguish from his autographs. In 1729 Bach heard that Handel was for a second time visiting Halle on his way back to London from Italy. A former attempt of Bach's to meet Handel had failed, and now he was too ill to travel, so he sent his son to Halle to invite Handel to Leipzig; but the errand was not successful, and much to Bach's disappointment he never met his only competitor. Bach so admired Handel that he made a manuscript copy of his *Passion nach Brookes*. This work, though almost unknown in England then as now, was, next to the oratorios of Keiser, incomparably the finest *Passion* then accessible, as Graun's beautiful masterpiece, *Der Tod Jesu*, was not composed until four years after Bach's death. The disgusting poem of Brookes (which was set by every German composer of the time) was transformed by Bach with real literary skill as the groundwork of the non-scriptural numbers in his *Passion according to St John*.

All Bach's most colossal achievements, such as the *Passion according to St Matthew* and the *B Minor Mass* (for discussion of which see ORATORIO and MASS), date from his cantorship at Leipzig. But, important and congenial as was his position there, and smooth as the course of his life seems to have been until

his death in 1750, he must have had quite as much experience as can have been good for him. He was often ruffled by the town councillors of Leipzig, who (like his earlier employers at Arnstadt) were shocked by the "uneclesiastical style" of his compositions and by his independent bearing. But he had more serious troubles. Of his seven children by his first wife only three survived him. By his second wife he had thirteen children, of whom he lost four of the six sons. For the head of so large a family his post was dignified rather than lucrative, and few documents tell a prouder tale of uncomplaining thrift than the inventory of his possessions made after his death. One can only be thankful that he did not live to see anything but the wonderful promise of his son Friedermann, who, in the words of the brilliantly successful K. Philipp Emanuel Bach, was more nearly capable of replacing his father than all the rest of the family together. The prospect of complete loss of the tradition of his own polyphonic art he faced with equanimity, saying of the new style, which in the hands of his own son, Philipp Emanuel, was soon to eclipse it for the next hundred years, "The art has advanced to great heights: the old style of music no longer pleases our modern ears." But it would have broken his heart if he had foreseen that Friedermann Bach was to attain a disreputable old age after a dissolute and unproductive life.

The brilliant successes of Philipp Emanuel led to his appointment as court-composer to the king of Prussia and hence, in 1747, to Sebastian's being summoned to visit Frederick the Great at Potsdam, an incident which Bach always regarded as the culmination of his career, much as Dr Johnson regarded his interview with George III. Bach had to play on the numerous newly invented pianofortes of Silbermann which the king had bought, and also to try the organs of the churches of Potsdam. Frederick, whose musical reputation rested on a genuine if narrow basis, gave him a splendid theme on which to extemporize; and on that theme Bach afterwards wrote *Das musikalische Opfer*. Two years after this event his sight began to fail, and before long he shared the fate of Handel in becoming perfectly blind.²

Bach died of apoplexy on the 28th of July 1750. His loss was deplored as that of one of the greatest organists and clavier players of his time. Of his compositions comparatively little was known. At his death his MS. works were divided amongst his sons, and many of them have been lost; only a small fraction of his greater works was recovered when, after the lapse of nearly a century, the verdict of his neglectful posterity was reversed by the modern upholders of polyphonic art. Even now some important works are still apparently irrecoverable.

The rediscovery of Bach is closely connected with the name of Mendelssohn, who was amongst the first to proclaim by word and deed the powers of a genius too gigantic to be grasped by three generations. By the enthusiastic **Work and Influence.** endeavours of Mendelssohn, Schumann and others, and in England still earlier by the performances and publications of Wesley and Crotch, the circle of Bach's worshippers rapidly increased. In 1850, a century after his death, a society was started for the correct publication of all Bach's remaining works. Robert Franz, the great song-writer, did good service in arranging some of Bach's finest works for modern performance, until the experience of a purer scholarship could prove not only the possibility but the incomparably greater beauty of a strict adherence to Bach's own scoring. The person of Bach-scholarship, however, is Wilhelm Rust (grandson of the interesting composer of that name who wrote polyphonic suites and fantasias early in the 19th century). During the fourteen years of his editorship of the *Bach-Gesellschaft* he displayed a steadily increasing insight into Bach's style which has never since been rivaled. In more than one case he has restored harmonies of priceless value from incomplete texts, by means of research and reasoning which he sums up in a modest footnote that reads as something self-evident. His prefaces to the *Bach-Gesellschaft* volumes are perhaps the most valuable contributions to the criticism of 18th-century music ever written, Spitta's great biography not excepted.

² The same surgeon operated unsuccessfully on both composers.

¹ Spitta points out that this cannot mean singing in the choir at a service, but making music in church privately.

Bach's importance in the history of music cannot be exaggerated. His art, neglected as old-fashioned and crabbed by his younger contemporaries, survived only in certain limited aspects as the subject of a desultory and unintelligent academic study, until its re-discovery by Mendelssohn. And yet, whatever disguise may have been foisted on it by corrupt traditions and ignorance of its idioms, whenever any fragment of it gained the inner ear of a true composer the effect on the history of music was immediate and profound. Indeed his influence is by no means chiefly manifested in the time when his work became known in its larger aspects, though the Bach-revival is very obviously connected with certain tendencies in the "Romantic" claim to music. But, however clear we may consider Bach's claim to the title of "the first of Romanticists," the full influence of his whole work has hardly yet begun to show itself. Schumann died before even such enthusiasts as the editors of the *Bach-Gesellschaft* began to find more beauty than extravagance in Bach's ordinary musical language (see, for example, Hauptmann's letters *passim*, *The Letters of a Leipzig Cantor*, trans. by A. D. Coleridge, London, Novello, Ewer, 1892), or, indeed, to grasp the main features of his designs.¹ The labours of the *Bach-Gesellschaft* have occupied more than fifty years, during which about four-fifths of Bach's choral works have been published for the first time; and it would be surprising if another fifty years sufficed to make these adequately known to the world at large. It is difficult to make an anthology of such bulky works as church-cantatas, nor does an anthology meet the purpose where the whole work so constantly attains that excellence for which the anthologist seeks. Except for practical difficulties (as when Bach writes for obsolete instruments) the only reason why some cantatas are better known than others is that a beginning must be made somewhere. Indeed, a cantata was recently selected, on the ground of its popularity, for a choral competition in a small English country town the year before it was performed as a novelty in Berlin!

It is clear, then, that the influence of Bach's art as an understood whole is still undeveloped. In the past history of music his part was hardly suspected except by the great composers themselves; and, to any one contemplating the art of the generation after him, it might have seemed that both he and Handel had worked in vain. Yet his was the most subtle and universal force in the development of music, even when his musical language seemed hopelessly forgotten. Mozart, when rapidly advancing to the height of his mastery, had but to read the Baron von Swieten's manuscript copies of the motets and of the *Wohltemperiertes Klavier*, and his style, quite apart from his immediate essays in the old art-forms, and apart also from the influence of his study of Handel, developed a new polyphonic richness and depth of harmony which steadily increased until his untimely death. Beethoven studied all the accessible works of Bach profoundly, and frequently quoted them in his sketch-books, often with a direct bearing on his own works. His rendering of the *Wohltemperiertes Klavier* is said to be recorded in the marks of expression and tempo given in Czerny's edition; and if that record is true, Beethoven must have been completely in the dark as to Bach's meaning in many important respects; but art is full of such illustrations of the way in which great minds influence each other in spite of every barrier which diversity of language and time can set. Beethoven's great Thirty-three Variations on a Waltz by Diabelli were actually described in the publisher's puff as worthy of their kinship with the "Goldberg Variations" of Bach; and that kinship is revealed in its truest light by a comparison between Beethoven's 31st variation and Bach's 25th; for here, just where the resemblance is most obvious, each composer utters his most intimate expression of feeling.

In the same way, Chopin is nowhere more characteristic than where he shows his love of the *Wohltemperiertes Klavier* in his Etudes and Preludes; and so subtle is the influence of poly-

phonic style even over a writer so little apt to make direct use of it as Chopin, that one of Schumann's few plagiarisms occurs in his use of a phrase from Chopin's F minor Etude (written for the *Méthode des méthodes*) as the subject of a fugue (Op. 72, No. 3). And, apart from fugues, which Schumann cultivated assiduously at a late stage in his career, the influence of Bach pervades the texture and rhythm of his work in more ways than can easily be followed.

In a more external, but not less significant way, the *Passion according to St Matthew* made its mark on Mendelssohn from the time when he discovered it at the age of twelve, and suggested to him many features in the general design of oratorios, by means of which he rescued that branch of art from the operatic influences that ruined Beethoven's *Mount of Olives*. Without the example of Bach, Wagner's schemes of *Leitmotif* would never in his lifetime have become woven into that close polyphonic texture which secures for his music a flow as continuous as that of drama itself;—and intimately connected with this is the whole subject of Wagner's harmonization, which in many of its boldest characteristics was foreshadowed by Bach. A close study of the texture of Brahms's work shows that he develops Bach's and Beethoven's artistic devices *pari passu*, and that the result is a complete unification of that opposition between polyphony and form which in the infancy of the sonata (as in every transitional stage in musical history) threatened to wreck the art as a false antithesis wrecks a philosophy. Perhaps the only great composers who escaped the direct influence of Bach are Gluck and Berlioz. Even Gluck reproduced in every detail of harmony and figure the first twelve bars of the *Gigue* of Bach's B flat Clavier-Partita in the aria "Je t'implore et je tremble" in *Iphigénie en Tauride*. But plagiarism, however unconscious, is a very different thing from that profound indebtedness which makes a great man attain his truest originality; and Gluck's training practically deprived him of Bach's direct influence, useful as that would have been to the attainment of his aims in harmonic and choral expression. The indirect influence no one could escape, for whatever in modern music is not traceable to Sebastian Bach is traceable to his sons, who were encouraged by their father in the cultivation of those infant art-forms which were so soon to dazzle the world into the belief that his own work was obsolete.

Bach's place in music is thus far higher than that of a reformer, or even of an inventor of new forms. He is a spectator of all musical time and existence, to whom it is not of the smallest importance whether a thing be new or old, so long as it is true. It is doubtful whether even the forms most peculiar to him (such as the arpeggio-prelude) are of his invention. Yet he left no form as he found it,—not even that most conventional of all, the Da Capo Aria, which he did not outwardly alter in the least. On the other hand, with every form he touched he said the last word. All the material that could be assimilated into a mature art he vitalized in his own way, and he had no imitators. The language of music changed at his death, and his influence became all-pervading just because he was not the prophet of the new art, but an unbiased seeker of truth. Whether so great a man becomes "progressive" or "reactionary" depends on the artistic resources of his time. He will always work at the kind of art that is most complete and consistent in all its aspects. The same spirit of truthfulness that makes Sebastian Bach hold himself aloof from the progressive art which he encourages in his sons, drives Beethoven to invent new forms and new means of expression with every work he writes. Gluck abolished the Da Capo Aria, because it was unfit for dramatic music. Bach did not abolish it, because he did not intend to write dramatic music in the strict sense of the term. Mature musical art in Bach's time could not be dramatic, except in the loose sense in which the term may be applied to an epic poem. Dramatic expression, properly so called, can only be attained in music by the full development of resources that do not blend with those of Bach's art at all. Meanwhile there are many things unsuitable for the stage which are nevertheless valuable on purely musical grounds; and the Da Capo Aria was one. Bach

¹ See the wild conjectures of the editor of the Four Short Masses as to the "displacing" of structure in the *Kyrie* of the G minor Mass (B.-G., *Jahr*. viii. preface, with Rust's answer in the preface to *Jahr*. xiii.).

developed it in a great variety of ways, while retaining even the minor details of what in other hands had long before become its conventional form; but the one thing he did not do was to abuse it according to time-honoured custom as the staple form for opera. For that he had too much dramatic insight. His treatment of other important art-forms is illustrated in the articles on CONTRAPUNTAL FORMS; CONCERTO and INSTRUMENTATION. Here we may attempt to illustrate his methods by such forms and characteristics as cannot be classified under those headings.

1. The toccatas of Buxtehude and his predecessors show how an effective musical scheme may be suggested by running over the keyboard of an organ as if to try (*toccare*) the touch, then bursting out into sustained and full harmony, and at last settling down to a fugue. But before Bach no one seemed able to keep the fugue in motion long enough to make a convincing climax. Very soon it collapsed and the process of quasi-extemporization began again, to culminate in a new fugue which often gave the whole work a happy but deceptive suggestion of organic unity by being founded on an ingenious variation of the subject of the first fugue. But in Bach's hands the toccata becomes one of the noblest and most plastic of forms. The introductory runs may be disjointed and exaggerated to grotesqueness, until the gaps between them gradually fill out, and they build themselves up into grand piles of musical architecture, as in the organ toccata in C; or they may be worked out on an enormous scale in long and smooth canonic passages with a definite theme, as in the greatest of all toccatas, that in F for organ, which is most artistically followed by a fugue unusually quiet for its size. In one instance, the toccata at the beginning of the E minor clavier-partita, the introductory runs, though retaining much of the extempore character from which the form derives its name, take shape in a highly organized and rounded-off group of contrasted themes. The fugue follows without change of time, and is developed in so leisurely a manner that it is fully as long as a normal fugue on a large scale by the time it reaches what sounds like its central episode. At this point some of the introductory matter quietly enters, and leads to a recapitulation of the whole introduction in the key now reached. The obvious sequel would be a counter-development of the fugue, at least as long as what has gone before, as in the clavier-tocatta in C minor; but Bach does not choose to weary the hearer and weaken the impression of breadth he has already made here. Instead, he expands this restatement of the introduction, and makes its harmonies deliberately return to the fundamental key, and thus in an astonishingly short time the toccata is brought to a close with the utmost effect of climax and finality. The same grasp of all the possible meanings of an artistic device shows itself in his treatment of the other features of toccata form. With his variety of proportion and flow he has no need to break off the fugue like earlier composers: but all the old devices by which the division into sections was managed are turned to account by him, and almost every toccata has its own scheme of contrasted movements, always based on the old natural idea of the growth of an organized music from a chaos of extemporization.

If this is Bach's treatment of a comparatively small and specialized art-form, it is obviously impossible to reduce the scantiest account of the rest of his work into practical limits here, nor is there as yet a sufficient body of accepted criticism of Bach for such an account to carry further conviction than an expression of individual opinion. Fortunately, however, Bach was constantly re-arranging his own compositions; indeed he evidently regards adaptability to fresh environment as the test of his finest work: and we cannot do better than review the evidence thus given to us,—evidence which only Beethoven's sketch-books surpass in significance.

2. The successful transplanting of a work of art to a fresh environment is obviously a convincing test of our definitions of the art-forms concerned, if only we take care to distinguish between the alterations produced by the change of environment

and those that imply the composer's dissatisfaction with the original version. In Bach's case this seldom causes much difficulty; his methods of adaptation are so logical and so varied as to form a scheme of musical morphology with all the interest and none of the imperfections of the geological record; and the few cases in which a work owes its changes to the need for improvement as well as adaptation cause no confusion, but rather form a link between the pure adaptations and the numerous revisions of his favourite works without change of medium. There is, for example, no difficulty in separating the element of corrective criticism from that of the impulse to give an already successful composition a larger or more permanent form, in such cases as the transformations undergone by the movements of the birthday cantata, *Was mir behagt ist nur die muntre Jagd*, during their distribution among the church cantatas, *Also hat Gott die Welt geliebt* and *Man singet mit Freuden vom Sieg*. The fine bass aria, "Ein Fürst ist seines Landes Pan," was obviously ill-proportioned, with its breakneck return to the tonic and its perfunctory close; and Bach's chief concern in adapting it for its place as the aria, "Du bist geboren mir zu Gute," in *Also hat Gott*, was to remedy this defect. On the other hand, the use of the delightful ritornello for violoncello from the little aria, "Weil die wollenreichen Heerden," in the birthday cantata, and the restoration of the rejected long instrumental *fugato* that was to follow, were obviously brought about by the conception of the entirely new material for the voice in the famous aria, "Mein gläubiges Herze." And when the last chorus of *Was mir behagt* became the first chorus of *Man singet mit Freuden*, it was expanded to the proportions necessary for a triumphant opening (as distinguished from a cheerful finale) by the adroit insertion of new material between every joint in the design. This material, being new, could not produce the effect of diffuseness that would result from the expansion of the old material already complete in its simplest form, and thus this instance does not imply criticism.

A highly interesting example of pure self-criticism is the *Passion according to St. John*, which was twice revised, and each time reduced to a smaller scale by the omission of some of its finest numbers. The final result was a work of perfect proportions, and of the rejected numbers one (a magnificent aria with chorale) remained unused, two were replaced by finer substitutes, others took shape as one of the most complete and remarkable of the church cantatas, *Du wahrer Gott*, while the greatest of the figured chorales was transferred to the *Passion according to St. Matthew*, of which it now crowns the first part.

3. Such instances of self-criticism might be paralleled in the works of other composers; but there is no parallel in music to Bach's power of reproducing already perfect works in different media. Here Bach reveals to us identities in difference which we should otherwise never have suspected. Of course it is possible to arrange works in different ways without illustrating any profound identities at all. Handel, for instance, collected several of his favourite choruses in an enormous instrumental concerto (see vol. 46 of the *Händel-Gesellschaft*), and the result in the case of a chorus like "Lift up your Heads" was ridiculous. Bach, however, does not arrange old work merely to please a court where it was already admired. He never leaves it in a state of mere make-shift, though he cannot always attain his evident aim of a new originality. His methods of orchestration and the profoundly significant identity of certain forms of chorus with certain concerto forms may better be described under their proper headings (see articles INSTRUMENTATION and CONCERTO). Here we will attempt first to show, by illustrations of Bach's power of adding parts to already complete harmonic and contrapuntal schemes, what was his conception of the nature of an art-form, and secondly, by means of a short analysis of cases in which he adapts the same music to different words, to define his range of expression.

Bach arranged all his violin concertos for clavier, including two that are lost in the original version. Here his power of providing new and apparently necessary material for the left hand of the cembalist (or, in the double concertos, two left

hands) without disturbing the already complete score, is astonishing; and it falls only in the slow movements, which he prefers to leave obviously in the condition of an arrangement rather than to spoil their broad cantabile style by a too polyphonic bass.

But these cases are insignificant compared with such transformations as that of the prelude of the E major partita for unaccompanied violin into the *sinfonia* for organ obligato accompanied by full orchestra (including three trumpets and a pair of drums) at the beginning of the church cantata, *Wir danken dir, Gott*. The original version is perhaps the most complete and natural of the violin solos, for its arpeggios produce full harmony without recourse to that constant attempt to play on all four strings at once, which makes the performance of the polyphonic movements a *tour de force* in which steady rhythm is nearly impossible. Yet in the *sinfonia* its proportions seem to reveal themselves for the first time. Not a bar is displaced and not a note of the new accompaniment is unnecessary. The whole is almost entirely without themes; for even this, the largest of all arpeggio-preludes, consists essentially of the gradual unfolding of a scheme of harmony in which rhythmic and melodic organization is reduced to a minimum. Only in the first line does the incisive initial figure persist a little longer in the new accompaniment than in the original solo, but on the last page it reappears and pervades the whole orchestra, even the drums thundering out its rhythm at the climax where the holding-notes of the trumpet span the torrent of harmony like a rainbow.

Deeper still is the thought that underlies the transformation of two movements of the great violin-concerto in D minor (unfortunately lost except in its splendid arrangement for clavier) into parts of the church cantata, *Wir müssen durch viel Trübsal in das Reich Gottes eingehen*. In both movements the violin is displaced by the organ an octave lower, the orchestral accompaniment remaining where it was. This treatment, with the addition of new and plaintive parts for wind instruments, turns the already very long and sombre first movement into an impressive idealization of the "much tribulation" that lies between us and the kingdom of heaven. The slow movement is still more solemn, and is arranged in the same way as regards the instruments; but from the first note to the last a four-part chorus sings, to the words of the title, a mass of quite new material (except for the bass and for numerous imitations of the solo-part), treated with every variety of vocal colouring and a grandeur of conception which is not dwarfed even by the *Passion according to St. Matthew*.

4. The four short masses, the Christmas oratorio and the B minor mass, contain every variety of adaptation from earlier work. The four short masses are indeed obviously compiled for use in a church where the orchestra was small. Only four movements in the whole collection are not traceable to other extant works; all the rest comes from church cantatas. The adaptations are not always significant; no attempt, for example, is made in the G minor mass to conceal how unfit for a *Kyrie eleison* is the tremendous denunciatory chorus, *Herr, deine Augen sehen nach dem Glauben*. But the F major and G major masses are very instructive; and the A major mass, except for the damage done to the instrumentation, is a work that no one would conceive to be not original. The *Kyrie* is one of Bach's most individual utterances and could surely never have fitted any other text, but we should say the same of the *Gloria* if we did not possess the church cantata, *Halt im Gedächtniss*. The *Gloria* begins with a triumphant polyphonic chorus accompanied by a spirited symphony for strings. At the words "et in terra pax" the time changes, and two flutes softly accompany a single solemn melody in the altos. At the "laudamus te" the material of the beginning returns, and is interrupted again by the calm slow movement, this time in another key and for another voice, at the words "adoramus te." Twice the "laudamus" and "adoramus" alternate in a finely proportioned design; at last the words "gratias agimus tibi propter magnam gloriam tuam" are set for the full chorus to the music of the slow movement, the strings join with the flutes, and this most appropriate setting of those words is finished. And yet it is quite impossible to

regard this as superseding the last chorus of *Halt im Gedächtniss*. Not one bar or harmony of the framework differs; yet the two versions are two independent works of art. In the cantata the beginning is for instruments only; when the slow movement (here adequately scored for a flute and two *oboe d' amore*) begins, the basses, permanently separated from the rest of the chorus, sing "Peace be unto you." The other voices then sing the triumph of the faithful helped by the Saviour in their battle against the world. The slow movement is, of course, set for bass alone throughout, and at the last recurrence of the *allegro* the bass continues to sing "Friede sei mit euch" through the rest of the chorus, as if leading the chorus of humanity through strife to the kingdom of heaven, and then the single voice of peace remains to the end. Hardly a bar of the chorus-material is on the same themes in the two versions.

The study of the sources of the Christmas oratorio will complete the evidence on which we support our estimate of Bach's methods and range of expression. It is certain that the occasional cantatas, from which all except the chorale-tune numbers and those set to words from the Bible were taken, date from shortly before the oratorio; and that Bach, being incapable of putting inferior work even into birthday odes, rescued it from oblivion by having the verses for the oratorio numbers built on the same rhythms as those of the odes in order that he might use those occasional works as a sketch (see *B-G., Jahr. xxxiv. preface*). Be this as it may, the alterations are confined to details even where an aria is transposed a fourth or fifth; but the effect of them is startling. Pleasure (*Wollust*) sings a lovely soprano aria to allure Hercules from the paths of Virtue, to which Hercules replies indignantly with an aria in a spirited staccato style. It is no doubt a shock to our feelings to find that *Wollust's* aria became the Virgin's cradle-song, while Hercules's reply became the alto aria in which Zion is bidden to "prepare for the Bridegroom." But it does not warrant the inference that Bach's music lacks definite characterization: on the contrary, these two arias are the best demonstration of his profound insight into the possibilities of musical expression within his range. It is no part of his conception of art that *Wollust* should be represented by a Wagnerian Venusberg-music; the obvious way to represent Pleasure was by writing pleasant music, and by Bach's ideas of pleasure the step from this to the solemn beauty of the sacred cradle-song was a mere matter of change of colour and tempo. The key is lowered from B flat to G, the strings are veiled with the tender reed tone of a group of *oboe d' amore*, the soprano becomes an alto whose notes are, as it were, surrounded with a nimbus by being doubled in the upper octave by a flute; and the aria becomes worthy of its new purpose, not by losing a grossness which it never possessed, but by gaining the richness which distinguishes the perfect work from the boldly executed draft.

As to the aria of Hercules the change is in manner, while the character, in the human sense of the term, is quite rightly the same. Both Hercules and the faithful Christian of the oratorio are renouncing pomps and vanities for the claims of a higher life; in the one case indignantly, in the other case inspired "mit zärtlichem Triebe." A change to a *legato* style, the substitution of a single *oboe d' amore* for tutti violins, the addition of delicate ornaments indicative of a slower pace, and the noble stream of melody preserve its identity while changing its aspect. Bach's larger designs react on their changing contents as a cathedral reacts on the impressiveness of the rites performed within it, or as nature reacts on a poet's thoughts; and in the same way Bach's melody is greater than any possible mood of the moment, not because of that vague and negative pseudo-classical quality misnamed "reserve," but because of its vital individuality. In their proper directions its changes are limitless; elsewhere change is inconceivable. No amount of "Umarbeitung" could, for instance, turn the aria of Hercules into the Virgin's cradle-song, or *Wollust's* aria into the exhortation of Zion to prepare for the Bridegroom. In short, Bach's melodies are characteristic, not like a mask with a set expression, but like a living face that is the more individual for the mobility of its features.

Within these limits, that is, short of dramatic expression in just so far as "the end of drama is not character but action," there is nothing good that Bach's art does not express. He has plenty of humour, if the term may be applied to art which is, so to speak, always literal,—art in which a jest is a jest and serious things are treated with familiar directness, and all, whether in jest or earnest, is primarily beautiful. In *Der Streit zwischen Phoebus und Pan* Bach answers the critics who censured him for his pedantry and provincial ignorance of the grand Italian operatic style, by making effective use of that style in Pan's prize-aria ("Zum Tanze, zum Sprunge, so wack-ack-ack-ackelt das Herz"), nobly representing his own style in Phoebus's aria, and promptly caricaturing it in the second part of Pan's ("Wenn der Ton zu mühsam klingt"). Midas votes for Pan—"denn nach meinen beiden Ohren singt er unvergleichlich schön." At the word "Ohren" the violins give a pianissimo "hee-haw" which is fully as witty in its musical aptness as Mendelssohn's clown-theme in the Overture to the *Midassummer Night's Dream*; and in the ensuing dialogue their prophecy is verified. As with many other great artists, Bach's playfulness occasionally showed itself inconveniently where little things shock little minds. The hilarious aria, "Ermuntre dich," in the church cantata, *Schmücke dich, o liebe Seele*, is one instance, and the quaint representation of the words "dimisit inanes" in the *Magnificat* is another. This great work, one of the most terse and profound things Bach ever wrote, contains, among many other subtle inspirations, one conception with which we may fitly end our survey, for it strongly suggests Bach himself and the destiny of all that work which he finished so lovingly, with no prospect of its becoming more than a family heirloom and a salutary tradition in his Leipzig choir-school. In the *Magnificat* he sets the words "quia respexit humilitatem ancillae suae" to a touchingly appropriate soprano solo accompanied by his favourite *oboe d'amore*. With the next sentence "ecce enim beatam me dicent" the tone brightens to a quiet joy, but Bach takes advantage of the syntax of the Latin in a way that defies translation, and the sentence is finished by the chorus. "Omnes generationes" seem indeed to pass before us in the crowded fugue which rises in perpetual stretto, the incessant entries of its subject now mounting the whole scale, each part a step higher than the last, and now collecting in unison with a climax of closeness and volume overwhelming in its impression of time and multitude.

SUMMARY OF BACH'S WORKS

No attempt is here made at chronological sequence. The changes in Bach's style, though clear and important, are almost impossible to describe in untechnical language; nor are they of such general interest as to make it worth while to expand this summary by an attempt to apportion its contents among the Arnstadt-Mühlhausen period, the Weimar period, the Cöthen period (chiefly remarkable for instrumental music and comparatively uninteresting in its easy-going choral music), and the last period (1733-1750) in which, while the choral works became at once more numerous and more terse (e.g. *Jesu, der du meine Seele*) the instrumental music, though never diffuse, shows an increasing preference for designs on a large scale. (Compare, for example, the second book of the *Wohltemperiertes Klavier*, 1744, with the first, 1722.)

I.—CHURCH MUSIC

A. With Orchestra

190 church cantatas: besides several which are only known from fragmentary sets of parts. Of the 190, 40 are for solo voices, about 60 (including some solo cantatas) are more or less founded on chorales, and the rest, though almost invariably containing a chorale (for congregational singing), are practically short oratorios and frequently so entitled by Bach himself.

3 wedding cantatas: the Easter oratorio (exactly like the above-mentioned oratorio-cantatas); and the Christmas oratorio (six similar cantatas forming a connected design for performance on six separate days).

The Passions according to St. Matthew and St. John. Funeral ode for the Duchess Eberhardine (now known to be arranged from portions of the lost Passion according to St. Mark).

4 short masses (i.e. Kyrie and Gloria only) mainly compiled from church cantatas.

Mass in B minor. Magnificat in D. A few other ecclesiastical Latin choruses.

B. Without Orchestra

5 motets a capella (but there is reason to believe that these, except *Komm Jesu komm*, were intended to be partly supported by the organ). A sixth motet has an obligato figured-bass-accompaniment.

A few early choruses, mostly turned to account in later works. A large collection of plain chorales, including several original melodies.

II.—SECLAR VOCAL MUSIC

Der Streit zwischen Phoebus und Pan and *Der zufriedene gestellte Acolus*; both entitled *Dramma per Musica*, but showing no more essential connexion with the stage than Handel's *Acis and Galatea*.

7 solo and 7 choral cantatas, of which latter three were almost entirely absorbed into the Christmas oratorio and the B minor mass. Of the solo cantatas two are Italian (one of these being Bach's only developed work for voice and clavier) and two are burlesque.

Several tunes with clavier bass, almost foreshadowing the modern song.

III.—INSTRUMENTAL MUSIC

A. Orchestral

7 clavier concertos arranged from violin concertos and other sources.

3 concertos for two claviers (two being arranged from concertos for two violins).

2 concertos for three claviers.

The 6 Brandenburg concertos, for various combinations. 2 violin concertos, and a colossal *torso* of a concerted violin-movement forming the prelude to a lost church cantata.

1 concerto for two violins.

4 orchestral suites. (The symphony in F in the same volume of the *B. G.* is only an earlier version of the first Brandenburg concerto.)

B. Chamber Music

3 sonatas for clavier and flute; a suite and 6 sonatas for clavier and violin, 3 for clavier and viola da gamba; 2 trios with figured bass; 2 flute-sonatas and a violin suite with figured bass; 6 sonatas (i.e. 3 sonatas and 3 partitas) for violin alone; 6 suites for violoncello alone.

C. Clavier and Organ Music

Bach's own collections are:—

1. *Das wohltemperierte Klavier* for clavier: two books each containing 24 preludes and fugues, one in each major and minor key; with the object of stimulating tuning by "equal temperament" instead of sacrificing the euphony of remoter keys to that of the more usual ones.

2. *Klavier-Übung* (chiefly for harpsichord) in four books comprising: (i) 15 two-part inventions and 15 three-part symphonies. (ii) 6 partitas. (iii) "The Goldberg" variations, 4 duets, and an important collection of organ choral-preludes, with the "St Anne" prelude and fugue in E flat. (iv.) The Italian concerto and French overture.

3. The 6 "French" and 6 "English" suites.

4. The other clavier works fill two *Jahrgänge* of the *B. G.*

Bach's collections of organ music are (besides that included in the third part of the *Klavier-Übung*):—(1) 6 sonatas. (2) 4 groups of 6 organ preludes and fugues. (3) *Das Orgelbüchlein*, a collection of short choral-preludes carefully planned—all the blank pages of the autograph being headed with the titles of the chorales intended for them—but not half executed. (The projected whole would have been a larger volume than the *Wohltemperiertes Klavier*.) (4) 18 larger chorale-preludes, including Bach's last composition. (5) The 6 "Schübler" chorales, all arranged from movements of cantatas.

Besides these there are the three great independent toccatas and the Passacaglia. The remaining choral-preludes fill one *Jahrgang*, and the other organ works two more.

D. Unclassified

Two important instrumental works cannot be classified, viz. *Das musikalische Opfer*, the volume of compositions (two great fugues, various puzzle-canon, and a splendid trio for flute, violin and figured bass) on the theme given to Bach by Frederick the Great; and *Die Kunst der Fuge*, a progressive series of fugues on one and the same subject, written in open score as if entirely abstract studies, but all (except the extreme contrapuntal *tours de force*) in admirable clavier style and of great musical value.

IV.—LOST WORKS

A. Choral

J. N. Forkel's statement that Bach wrote 5 *Jahrgänge* of church cantatas (i.e. enough to provide one for each Sunday and holy day for five years) would indicate that some 80 are lost, but there is reason to believe that this is a great exaggeration. Not more than six or seven cantatas are known to be lost, by the evidence of fragments, text-books, &c.

Forkel also says that Bach wrote five Passions. Besides the great Matthew and John Passions there is in an indisputable Bach autograph one according to St. Luke; but it is so worthless that the best plea for its authenticity offered by responsible critics is that only a personal interest could have induced Bach to make a copy of it.

The lost Passion according to St Mark must, judging by the movements preserved in the *Trauer-Ode*, have been larger than that according to St John.

Was there a *genuise* Lucas-Passion? If so, Forkel's report of five Passions would be explained. Several lost secular works are partly preserved in those portions of the Christmas oratorio of which the sources are not definitely known, but which, like the other duplicated numbers, are fair copies in the autograph.

B. Instrumental

Three violin concertos and one for two violins; known only from the wonderful clavier versions.

Most of the first movement of the A major sonata for clavier and flute which was written in the spare staves at the bottom of a larger score. Some of these have been cut off.

V.—ARRANGEMENTS OF WORKS BY OTHER COMPOSERS

Arrangements for harpsichord alone of 16 concertos, generally described as by Vivaldi, but including several by other composers. 4 Vivaldi concertos arranged for organ.

Many of these arrangements contain much original matter, such as entirely new slow movements, large cadenzas, &c. Concerto in A minor for 4 claviers and orchestra, from Vivaldi's B minor concerto for 4 violins. This, though the most faithful to its original, is the richest and most Bach-like of all these arrangements, and is well worth performing in public.

2 sonatas from the *Hortus Musicus* of Reinken, arranged for clavier. (The ends of the slow movements are Bach's.)

Finishing touches to cantatas by his uncle Johann Ludwig Bach. Also a very characteristic complete "Christe eleison" inserted in Kyrie of Johann Ludwig's.

VI.—DOUBTFUL AND SPURIOUS WORKS

Bach's autographs give the name of the composer on the outside sheet only. He was constantly making copies of all that interested him; and where the outside sheet is lost, only the music itself can tell us whether it is his or not. The above-mentioned *Passion according to St Luke* is the chief case in point. The little music-books he and his second wife wrote for their children are full of pieces in the most various styles, and the editors of the *Bach-Gesellschaft* have not completely identified them, even Couperin's well-known "Les Bergers" escaping their scrutiny. A sonata for two claviers by Bach's eldest son, Wilhelm Friedemann, was detected by the editors after its inclusion in *Jahrgang* xiv. The second of the 3 sonatas for clavier and flute is extremely suggestive of Bach's sons, but Philipp Emanuel ascribes it to his father. However, he might easily have docketed it wrongly while arranging copies of his father's works. It has a twin brother (*B.-G.* ix. Anh.ang. ii.) for which he has not vouched.

An absurd church cantata are printed for conscience' sake in *Jahrgang* xliii. More important than these, because by no means too obviously ridiculous to deceive a careless listener, is the well-known 8-part motet, *Lob, Ehr' und Weisheit* (blessing and glory and wisdom). A closer acquaintance shows that it is really very poor stuff; and it was finally crowned with absurdity by the discovery that its composer was a contemporary of Bach,—and that his name was Wagner.

The beautiful motet, *Ich lasse dich nicht*, has long been known to be by one of Bach's uncles (Johann Christoph).

EDITIONS

Almost the only works of Bach published during his lifetime were the instrumental collections, most of which he engraved himself. Of the church cantatas only one, *Gott ist mein König* (written when he was nineteen, but a very great work), was published in his lifetime.

Of modern editions that of the *Bach-Gesellschaft* is, of course, the only complete one. It is, inevitably, of very unequal merit. Its first editors could not realize their own ignorance of Bach's language; their immediate admiration of his larger choruses seemed to them proof of their competence to retain or dismiss details of ornamentation, figured bass, variants between score and parts, &c., without always stopping to see what light these might shed on questions of tempo and style—especially in the arias and recitatives, which they regarded as archaic almost in direct proportion to the depth of thought really displayed in them. In the 9th *Jahrgang* Wilhelm Rust introduced scholarly methods, with the happiest results. The *Wohlttemperiertes Klavier* (*Jahrgang* xiv.) was edited by Kroll, who also made this text accessible in the *Edition Peters* (which till then had only Czerny's—an amazing result of corrupt tradition, still widely accepted). Kroll's and Rust's volumes are far the best in the *B.-G.* On Rust's death the standard deteriorated; his immediate successor seems more interested in reprinting in full an early version of a work of which Rust had given only the variants, than in digesting his own materials (*Jahrgang* xxix.); and in his next volume (*Jahrgang* xxx. p. 109) the bass and violin are a bar apart for a whole line. The last ten volumes, however, are again satisfactory, and in *Jahrgang* xlv. the French and English suites are re-edited. Part of the B minor mass was also worked over again; and Kroll's text of the *Wohlttemperiertes Klavier* was supplemented by the evidence of the British Museum autograph. The

Steingraber edition of the clavier works, edited by Dr Hans Bischoff, is incomparably the best, giving all the variants in footnotes and clearly distinguishing the extremely intelligent *nuances* and phrasing signs of the editor from the rare but significant indications of Bach himself. Nor does this wealth of scholarship interfere with the presentation of a straightforward, single text; though in addition there is every necessary explanation of the ornaments and kindred matters.

We have seen no other editions that distinguish Bach's text from the editor's taste—the disappointing publications of the *Neue Bachgesellschaft*¹ by no means excepted. We may remark that the older vocal scores of cantatas in the *Edition Peters* are, though unfortunately but a selection, far better than the complete series issued by Breitkopf and Härtel in conformity with the *Bach-Gesellschaft*, and therefore accepted as authoritative (see INSTRUMENTATION). The English vocal scores published by Novello are generally very good though covering but small ground. The Novello score of the Christmas oratorio contains a fine analytic preface by Sir George Macfarren.

BIOGRAPHY.—J. N. Forkel, *Über Bach's Leben, Kunst und Kunstwerke*, translated (London, 1820); C. H. Bitter, *John Sebastian Bach* (Berlin, 1865); Ernest David, *La Vie et les œuvres de Bach* (Paris, 1882); P. Spitta, *Johann Sebastian Bach* (Leipzig, 1873 and 1880); E. Heinrich, *Sebastian Bach's Leben* (Berlin, 1885); A. Pirro, *L'Esthétique de Jean Sebastian Bach* (Paris, 1907); and *L'Orgue de Jean Sebastian Bach* (Paris, 1909); J. A. Schweitzer, *J. S. Bach: Le Musicien poète*. Spitta's biography superseded everything written before it and has not since been approached. With corrections in the light of Rust's *B.-G.* prefaces it contains everything worth knowing about Bach, except the music itself. (D. F. T.)

BACH, KARL PHILIPP EMANUEL (1714–1788), German musician and composer, the third son of Johann Sebastian Bach, was born at Weimar on the 14th of March 1714. When he was ten years old he entered the Thomasschule at Leipzig, of which in 1723 his father had become cantor, and continued his education as a student of jurisprudence at the universities of Leipzig (1731) and of Frankfurt on the Oder (1735). In 1738 he took his degree, but at once abandoned all prospects of a legal career and determined to devote himself to music. A few months later he obtained an appointment in the service of the crown prince of Prussia, on whose accession in 1740 he became a member of the royal household. He was by this time one of the first clavier-players in Europe, and his compositions, which date from 1731, included about thirty sonatas and concerted pieces for his favourite instrument. His reputation was established by the two sets of sonatas which he dedicated respectively to Frederick the Great (1742) and to the grand duke of Württemberg (1744): in 1746 he was promoted to the post of *Kammermusikus*, and for twenty-two years shared with Karl Heinrich, Graun, Johann Joachim, Quantz and Johann Gottlieb Naumann the continued favour of the king. During his residence at Berlin he wrote a fine setting of the *Magnificat* (1749), in which he shows more traces than usual of his father's influence, an Easter cantata (1756), several symphonies and concerted works, at least three volumes of songs,—*Geistliche Oden und Lieder*, to words by Gellert (1758), *Oden mit Melodien* (1762) and *Sing-Oden* (1766)—and a few secular cantatas and other *pièces d'occasion*. But his main work was concentrated on the clavier, for which he composed, at this time, nearly two hundred sonatas and other solos, including the set mit *veränderten Reprisen* (1760–1768) and a few of those *für Kenner und Liebhaber*. Meanwhile he placed himself in the forefront of European critics by his *Versuch über die wahre Art das Clavier zu spielen* (first part 1753, second, with the first reprinted, 1762), a systematic and masterly treatise which by 1780 had reached its third edition, and which laid the foundation for the methods of Clementi and Cramer. In 1768 Bach succeeded Georg Philipp Telemann as *Kapellmeister* at Hamburg, and in consequence of his new office began to turn his attention more towards church music. Next year he produced his oratorio *Die Israeliten in der Wüste*, a composition remarkable not only for its great beauty but for the resemblance of its plan to that of Mendelssohn's *Elijah*, and between 1769 and 1788 added over twenty settings of the Passion, a second oratorio *Der Aufseher*.

¹ The object of the *Neue Bachgesellschaft* is to render the completed results of the first *Bachgesellschaft* generally accessible by holding frequent Bach festivals and issuing cheap and practical editions. The activities of this society, together with the new movement to restore Bach's vocal music to its place in the Lutheran Church, cannot fail to have a salutary effect on the future of music.

und *Himmelfahrt Jesu* (1777), and some seventy cantatas, litanies, motets and other liturgical pieces. At the same time his genius for instrumental composition was further stimulated by the career of Haydn, to whom he sent a letter of high appreciation, and the climax of his art was reached in the six volumes of sonatas für *Kenner und Liebhaber*, to which he devoted the best work of his last ten years. He died at Hamburg on the 14th of December 1788.

Through the latter half of the 18th century the reputation of K. P. E. Bach stood very high. Mozart said of him, "He is the father, we are the children"; the best part of Haydn's training was derived from a study of his work; Beethoven expressed for his genius the most cordial admiration and regard. This position he owes mainly to his clavier sonatas, which mark an important epoch in the history of musical form. Lucid in style, delicate and tender in expression, they are even more notable for the freedom and variety of their structural design; they break away altogether from the exact formal antithesis which, with the composers of the Italian school, had hardened into a convention, and substitute the wider and more flexible outline which the great Viennese masters showed to be capable of almost infinite development. The content of his work, though full of invention, lies within a somewhat narrow emotional range, but it is not less sincere in thought than polished and felicitous in phrase. Again he was probably the first composer of eminence who made free use of harmonic colour for its own sake, apart from the movement of contrapuntal parts, and in this way also he takes rank among the most important pioneers of the school of Vienna. His name has now fallen into undue neglect, but no student of music can afford to disregard his *Sonaten für Kenner und Liebhaber*, his oratorio *Die Israeliten in der Wüste*, and the two concertos (in G major and D major) which have been republished by Dr Hugo Riemann.

A list of his voluminous compositions may be found in Eitner's *Quellen Lexikon*, and a critical account of them is given in Bitter's *C. P. E. und W. F. Bach und deren Brüder* (2 vols., Berlin, 1868), a mine of valuable though ill-arranged information.

Four more of Johann Sebastian Bach's sons grew to manhood and became musicians. The eldest of them, WILHELM FRIEDERMANN BACH (1710-1784) was by common repute the most gifted; a famous organist, a famous improviser and a complete master of counterpoint. But, unlike the rest of the family, he was a man of idle and dissolute habits, whose career was little more than a series of wasted opportunities. Educated at Leipzig, he was appointed in 1733 organist of the Sophienkirche at Dresden, and in 1747 became musical director of the Liebfrauenkirche at Halle. The latter office he was compelled to resign in 1764, and thenceforward he led a wandering life until, on the 1st of July 1784, he died in great poverty at Berlin. His compositions, very few of which were printed, include many church cantatas and instrumental works, of which the most notable are the fugues, polonaises and fantasias for clavier, and an interesting set of strings, clarinet and horns. Several of his manuscripts are preserved in the Royal library at Berlin; and a complete list of his works, so far as they are known, may be found in Eitner's *Quellen Lexikon*.

The fourth son, JOHANN GOTTFRIED BERNHARD BACH (1715-1739) was, like his elder brothers, born at Weimar and educated at Leipzig. From 1735 to 1738 he held successively the organistships at Mühlhausen and Sangerhausen; in 1738 he threw up his appointment and went to study law at Jena; in 1739 he died, aged 24.

JOHANN CHRISTOPH FRIEDRICH BACH (1732-1795), the ninth son, was born at Leipzig, studied at the Thomasschule and the university, and in 1750 was appointed *Kapellmeister* at Bübeckburg. He was an industrious composer, especially of church-music and opera, whose work reflects no discredit on the family name.

JOHANN CHRISTIAN BACH (1735-1782), the eleventh son, was born at Leipzig, and on the death of his father in 1750 became the pupil of his brother Emanuel at Berlin. In 1754 he went to Italy where he studied under Padre Martini, and from 1760 to 1762 held the post of organist at Milan cathedral, for which he

wrote two Masses, a *Requiem*, a *Te Deum* and other works. Having also gained some reputation as a composer of opera, he was in 1762 invited to London and there spent the rest of his life. For twenty years he was the most popular musician in England, his dramatic works, produced at the King's theatre, were received with great cordiality, he was appointed music-master to the queen, and his concerts, given in partnership with Abel at the Hanover Square rooms, soon became the most fashionable of public entertainments. He is of some historical interest as the first composer who preferred the pianoforte to the older keyed-instruments; but his works, though elegant and pleasing, were ephemeral in character and have been deservedly forgotten.

A full account of J. C. Bach's career is given in the fourth volume of Burney's *History of Music*, and a catalogue of his compositions in an article by Max Schwarz, published in the *Sammelbände of the Internationale Musik-Gesellschaft*, Jhrg. ii. p. 401. (W. H. Ha.)

BACHARACH, YAIR (1639-1702), German rabbi, was the author of *Harwoth Yair* (a collection of *Responsa*) and other works. Bacharach was a man of wide culture, and holds an honourable place among the pioneers of the Jewish Renaissance which was inaugurated towards the end of the 18th century.

BACHARACH, a town of Germany, in the Prussian Rhine Province, romantically situated on the left bank of the Rhine, 30 m. above Coblenz on the railway to Mainz. Pop. 2000. There is an interesting church, a basilica, dating from the beginning of the 13th century. There are also ruins of a Gothic church of the 13th and 15th centuries. The ruined castle of Stahleck, crowning the heights above the town, is celebrated in history as the scene of the marriage between Henry, eldest son of Henry the Lion (shortly before the latter's death in 1195) and Agnes of Hohenstaufen, which effected a temporary reconciliation between the houses of Welf and Hohenstaufen. Other ruined castles are those of Fürstenberg and Stahlberg. All three belonged to the counts palatine. The wines of Bacharach were once held in the greatest esteem, and it is still one of the chief markets of the Rhenish wine trade.

BACHAUMONT, LOUIS PETIT DE (1690-1771), French littérateur, was of noble family and was brought up at the court of Versailles. He passed his whole life in Paris as the centre of the *salon* of Madame Doublet de Persan (1677-1771), where criticism of art and literature took the form of malicious gossip. A sort of register of news was kept in a journal of the *salon*, which dealt largely in scandals and contained accounts of books suppressed by the censor. Bachaumont's name is commonly connected with the first volumes of this register, which was published anonymously under the title *Mémoires secrets pour servir à l'histoire de la République des Lettres*, but his exact share in the authorship is a matter of controversy. It was continued by Pidansat de Mairobert (1707-1799) and others, until it reached 36 volumes (1774-1799). It is of some value as a historical source, especially for prohibited literature. Extracts were published by P. Lacroix in one volume, 1859. An incomplete edition (4 vols.) was undertaken in 1830 by Ravenal.

See, in addition to the memoirs of the time, especially the *Correspondance littéraire* of Grimm, Diderot, d'Alembert and others (new ed., Paris, 1878, 17 vols.); Ch. Aubertin, *L'Esprit public au XVIII^e siècle* (Paris, 1872).

BACHE, ALEXANDER DALLAS (1806-1867), American physicist, great-grandson of Benjamin Franklin, was born at Philadelphia on the 19th of July 1806. After graduating at the United States Military Academy at West Point in 1825, he acted as assistant professor there for some time, and as a lieutenant in the corps of engineers he was engaged for a year or two in the erection of coast fortifications. He occupied the post of professor of natural philosophy and chemistry in the University of Pennsylvania in 1828-1841 and in 1842-1843. For the trustees of what in 1848 was to become Girard College, but had not yet been opened, he spent the years 1836-1838 in Europe, examining European systems of education, and on his return published a very valuable report. In 1843, on the death of Professor F. R. Hassler (1770-1843), he was appointed

superintendent of the United States coast survey. He succeeded in impressing Congress with a sense of the great value of this work, and by means of the liberal aid it granted, he carried out a singularly comprehensive plan with great ability and most satisfactory results. By a skilful division of labour, and by the erection of numerous observing stations, the mapping out of the whole coast proceeded simultaneously under the eye of the general director, and in addition a vast mass of magnetic and meteorological observations was collected. He died at Newport, Rhode Island, on the 17th of February 1867.

BACHE, FRANCIS EDWARD (1833-1888), English musical composer, was born in Birmingham on the 14th of September 1833. The pupil of Alfred Mellon for violin and Sterndale Bennett for composition, he afterwards went to Leipzig in 1853 and studied with Hauptmann and Plaidy. Considering the early age at which he died, his compositions are fairly numerous, and the best, a trio for piano and strings, is still held in high esteem. Two operettas, a piano concerto and a number of published pianoforte pieces and songs do little more than show how great was his promise. He died at Birmingham of consumption on the 24th of August 1858. His younger brother, **WALTER BACHE** (1842-1888), was born in Birmingham on the 19th of June 1842, and followed him to the Leipzig Conservatorium, where he became an excellent pianist. From 1862 to 1865 he studied with Liszt in Rome, and for many years devoted himself to the task of winning popularity for his master's works in England. At his annual concerts in London nearly all Liszt's larger works were heard for the first time in England, and on the occasion of Liszt's last visit to England in 1886, he was entertained by Bache at a memorable reception at the Grosvenor Gallery. Walter Bache was professor of the pianoforte at the Royal Academy of Music for some years before his death, and the foundation of the Liszt scholarship at that institution was mainly due to his efforts. He died in London on the 26th of March 1888.

An interesting memoir of the two brothers, by Miss Constance Bache, appeared in 1901 under the title *Brother Musicians*.

BACHELOR (from Med. Lat. *baccalarius*, with its late and rare variant *baccalarius*—cf. Ital. *baccalare*—through O. Fr. *bachelor*), in the most general sense of the word, a young man. The word, however, as it possesses several widely distinct applications, has passed through many meanings, and its ultimate origin is still involved in a certain amount of obscurity. The derivation from Welsh *bach*, little, is mentioned as "possible" by Skeat (*Etymological Dictionary*), but is "definitely discarded" by the *New English Dictionary*, and that given here is suggested as probable. The word *baccalarius* was applied to the tenant of a *baccalaria* (from *baccalia*, a herd of cows, *bacca* being a Low Latin variant of *vacca*), which was presumably at first a grazing farm and was practically the same as a *vascellaria*, i.e. the fief of a sub-vassal. Just, however, as the character and the size of the *baccalaria* varied in different ages, so the word *baccalarius* changed its significance; thus in the 8th century it was applied to the *rustici*, whether men or women (*baccalariæ*), who worked for the tenant of a *mansus*. Throughout all its meanings the word has retained the idea of subordination suggested in this origin. Thus it came to be applied to various categories of persons as follows.—

(1) Ecclesiastics of an inferior grade, e.g. young monks or even recently appointed canons (Severius, *de episcopis Lugdunensibus*, p. 577, in du Cange). (2) Those belonging to the lowest stage of knighthood. Knights bachelors were either poor vassals who could not afford to take the field under their own banner, or knights too young to support the responsibility and dignity of knights bannerets (see *KNIGHTHOOD* and *CHIVALRY*). (3) Those holding the preliminary degree of a university, enabling them to proceed to that of master (*magister*) which alone entitled them to teach. In this sense the word *baccalarius* or *baccalaureus* first appears at the university of Paris in the 13th century, in the system of degrees established under the auspices of Pope Gregory IX., as applied to scholars still in *statu pupillari*. Thus there were two classes of *baccalarii*: the *baccalarii cursores*, i.e. theological candidates passed for admission to the divinity course, and the *baccalarii dispositi*, who, having completed this

course, were entitled to proceed to the higher degrees. In modern universities the significance of the degree of bachelor, in relation to the others, varies; e.g. at Oxford and Cambridge the bachelor can proceed to his mastership by simply retaining his name on the books and paying certain fees; at other universities a further examination is still necessary. But in no case is the bachelor a full member of the university. The degree of bachelor (of arts, &c.) is borne by women also. (4) The younger or inferior members of a trade guild or city company, otherwise known as "yeomen" (now obsolete). (5) Unmarried men, since these presumably have their fortunes yet to make and are not full citizens. The word bachelor, now confined to men in this connotation, was formerly sometimes used of women also.

Bachelors, in the sense of unmarried men, have in many countries been subjected to penal laws. At Sparta, citizens who remained unmarried after a certain age suffered various penalties. They were not allowed to witness the gymnastic exercises of the maidens; and during winter they were compelled to march naked round the market-place, singing a song composed against themselves and expressing the justice of their punishment. The usual respect of the young to the old was not paid to bachelors (*Plut. Lyc.* 35). At Athens there was no definite legislation on this matter; but certain minor laws are evidently dictated by a spirit akin to the Spartan doctrine (see *Schömann, Gr. Alterth.* i. 548). At Rome, though there appear traces of some earlier legislation in the matter, the first clearly known law is that called the *Lex Julia*, passed about 18 B.C. It does not appear to have ever come into full operation; and in A.D. 9 it was incorporated with the *Lex Papia et Poppæa*, the two laws being frequently cited as one, *Lex Julia et Papia Poppæa*. This law, while restricting marriages between the several classes of the people, laid heavy penalties on unmarried persons, gave certain privileges to those citizens who had several children, and finally imposed lighter penalties on married persons who were childless. Isolated instances of such penalties occur during the middle ages, e.g. by a charter of liberties granted by Matilda I., countess of Nevers, to Auxerre in 1223, an annual tax of five *solidi* is imposed on any man *qui non habet uxorem et est baccalarius*. In Britain there has been no direct legislation bearing on bachelors; but, occasionally, taxes have been made to bear more heavily on them than on others. Instances of this are the act (6 and 7 Will. III.) passed in 1695; the tax on servants, 1785; and the income tax, 1798.

BACHIAN (Dutch *Batjan*), one of the Molucca Islands, in the residency of Ternate, Dutch East Indies, in the Molucca Sea, in 0°13'-0°55' S. and 127°22'-128°E. With its subordinate islands, Mandioli, Tawali and others, it lies west of the southern peninsula of the island of Halmahera or Jilolo, and has an area of 914 sq. m. It is of irregular form, consisting of two distinct mountainous parts, united by a low isthmus, which a slight subsidence would submerge. The island is in part of volcanic formation, and the existence of hot springs points to volcanic activity. There are, however, especially in the southern portion, ancient and non-volcanic rocks. The highest elevation occurs at the south of the island, the mountain of Labua reaching 6950 ft. Coal and other minerals have been discovered. A large portion of the island is richly wooded, and sago, cocoa-nuts and cloves (which are indigenous) are abundantly produced. Bachian is remarkable as the most eastern point on the globe inhabited by any of the *Quadrumana*, a black ape occurring here as in Celebes. The island is very rich in birds and insects. The interior of the island is uninhabited and none of the dwellers on the coast are indigenous. They consist of the Sirani or Christian descendants of the Portuguese, of Malays, with a Papuan element, Galela men from the north of Halmahera, immigrants from Celebes, with some Chinese and Arabs. The total number of inhabitants is about 13,000. The chief village, called Amasing by the inhabitants, but also called Bachian, is situated on the west side of the isthmus. Bachian is the most important island of a group formerly governed by a sultan, but since 1889 by a committee of chiefs under the control of a Dutch *contrôleurs*. From 1882 onwards a Batjan company attempted to exploit the island, but

unsuccessfully, owing to a deficient knowledge of the soil and its capabilities and a lack of labourers.

BACK-BOND, or BACK-LETTER, in Scots law, a deed qualifying the terms of another deed, or declaratory of the purposes for which another deed has been granted. Thus an *ex facie* absolute disposition, qualified by a back-bond expressing the limited nature of the right actually held by the person to whom the disposition is made, would constitute what in England is termed a deed of trust.

BACK-CHOIR, RETRO-CHOIR, a space behind the high altar in the choir of a church, in which there is, or was, a small altar standing back to back with the other.

BACKERGUNJE, or BAKARGANJ, a district of British India in the Dacca division of Eastern Bengal and Assam. It forms part of the joint delta of the Ganges and the Brahmaputra, and its area is 4542 sq. m. The general aspect of the district is that of a flat even country, dotted with clusters of bamboos and betel-nut trees, and intersected by a perfect network of dark-coloured and sluggish streams. There is not a hill or hillock in the whole district, but it derives a certain picturesque beauty from its wide expanses of cultivation, and the greenness and freshness of the vegetation. This is especially conspicuous in the rains, but at no time of the year does the district present a dried or burnt-up appearance. The villages, which are always walled round by groves of bamboos and betel-nut palms, have often a very striking appearance; and Backergunje has many beauties of detail which strike a traveller in passing through the country. The level of the country is low, forming as it does a part of the great Gangetic delta; and the rivers, streams and water-courses are so numerous that it is very difficult to travel except by boat at any season of the year. Every natural hollow is full of water, around the margin of which long grasses, reeds and other aquatic plants grow in the greatest profusion, often making it difficult to say where the land ends and the water begins. Towards the north-west the country is very marshy and nothing is to be seen for miles but tracts of unreclaimed swamps and rice lands, with a few huts scattered here and there and raised on mounds of earth. In the south of the district, along the coast of the Bay of Bengal, lie the forest tracts of the Sundarbans, the habitation of tigers, leopards and other wild beasts.

The principal rivers of the district are the Meghna, the Arial Khan and the Haringhata or Baleswar, with their numerous offshoots. The Meghna represents the accumulated waters of the Brahmaputra and Ganges. It flows along the eastern boundary of the district in a southerly direction for about 100 m. till it debouches into the Bay of Bengal. During the latter part of its course this noble river expands into a large estuary containing many islands, the principal of which is that of Dakshin Shabbazpur. The islands on the sea-front are exposed to devastation by cyclonic storm-waves. The Arial Khan, a branch of the Ganges, enters the district from the north, and flows generally in a south-easterly direction till it falls into the estuary of the Meghna. The main channel of the Arial Khan is about 1700 yds. in width in the dry season, and from 2000 to 3000 yds. in the rains. It receives a number of tributaries, sends off several offshoots, and is navigable throughout the year by native cargo boats of the largest size. The Haringhata, Baleswar, Madhumati and Garai are various local names for the same river in different parts of its course and represent another great offshoot of the Ganges. It enters Backergunje near the north-west corner of the district, whence it forms its western boundary, and runs south, but with great windings in its upper reaches, till it crosses the Sundarbans, and finally falls into the Bay of Bengal by a large and deep estuary, capable of receiving ships of considerable burden. In the whole of its course through the district the river is navigable by native boats of large tonnage, and by large sea-going ships as high up as Morrellganj, in the neighbouring district of Jessore. Among its many tributaries in Backergunje the most important is the Kacha, itself a considerable stream and navigable by large boats all the year round, which flows in a southerly direction for 20 m., when it falls into the Baleswar. Other rivers of minor importance are the Barisal, Bishkhali, Nihalganj, Khairabad,

Ghagar, Kumar, &c. All the rivers in the district are subject to tidal action from the Meghna on the north, and from the Bay of Bengal on the south, and nearly all of them are navigable at high tide by country boats of all sizes. The rise of the tide is very considerable in the estuary of the Meghna, and many of the creeks and water-courses in the island of Dakshin Shabbazpur, which are almost dry at ebb tide, contain 18 or 19 ft. of water at the flood. A very strong "bore" or tidal wave runs up the estuary of the Meghna at spring tides, and a singular sound like thunder, known as the "Barisal guns," is often heard far out at sea about the time it is coming in. There are numerous marshes in the district, of great size and depth, and abounding in fish.

The Mussulmans of Backergunje are among the worst of their creed, steeped in ignorance and prejudice, easily excited to violence and murder, very litigious and grossly immoral. On account of an epidemic of murders disarming had to be enforced in the district. The Farazis or Puritan sect of Mahomedans are exceedingly numerous in the district. The Buddhist population consists of Maghs or the people of Arakan, who first settled in Backergunje about 1800, and have made themselves very useful in the clearing of the Sundarbans. A gipsy-like tribe called the Bebijas are rather numerous in this district. They live principally in boats, travelling from place to place, profess Mahomedanism, and gain their subsistence by wood-cutting in the Sundarbans, fishing, fortune-telling and trading in trinkets. In 1901 the population was 2,291,752, showing an increase of 6% in the decade.

A number of small trading villages exist throughout the district, and each locality has its periodical fairs for purposes of traffic. The material condition of the people is good. Every inhabitant is a small landholder and cultivates sufficient rice and other necessaries for the support of his family. Owing to this reason, hired labour is very scarce. Rice is the great crop of the district, and three harvests are obtained annually—the *aman*, or winter rice; *aus*, or autumn crop; and *boro*, or spring rice. The climate of Backergunje is one of the healthiest in Eastern Bengal, owing to the strong south-west monsoon, which comes up directly from the Bay of Bengal, and keeps the atmosphere cool; but the heavy rainfall and consequent humidity of the atmosphere, combined with the use of bad water, are fruitful sources of disease. The average annual temperature varies from 78° to 85° F. The thermometer ranges from 62° to 98°.

Barisal, the headquarters station, situated on the west bank of the Barisal river, had a population in 1901 of 18,978. The next largest town is Pirojpur (14,110).

BACKGAMMON, a game played with draughtsmen and a special board, depending on the throw of dice. It is said to have been invented about the 10th century (Strutt). A similar game (*Ludus duodecim scriptorum*, the "twelve-line game") was known to the Romans, and Plato (*Republic*, bk. x.) alludes to a game in which dice were thrown and men were placed after due consideration. The etymology of the word "backgammon" is disputed; it is probably Saxon—*baec*, back, *gammen*, game; i.e. a game in which the players are liable to be sent back. Other derivations are, Dan. *bakke*, tray, *gammen*, game (Wedgwood); and Welsh *bach*, little, *cammann*, battle (Henry). Chaucer alludes to a game of "tables," played with three dice, in which "men" were moved from the opponent's "tables," the game (*ludus Anglicorum*) being described in the Harleian MSS. (1527). The French name for backgammon is *trictrac*, imitative of the rattle of the dice.

Backgammon is played by two persons. The "board" (see diagram) is divided into four "tables," each table being marked with six "points" coloured differently. The inner and outer tables are separated from each other by a projecting *bar*. The board (in the ordinary form of the game) is furnished with fifteen white and fifteen black men, "set" or arranged as in the diagram. It is usual to make the inner table the one nearest to the light. Two dice-boxes are required, one for each player, and a pair of dice, which are used by both players. The dice are marked with numbers on their six sides, from one to six, number one being called, "ace"; two, "deuce"; three, "trej." Formerly the

four was called "quatre" (pronounced "cater"); the five, "cinque" (pronounced either "sank" or "sink"); and the six, "six" (size).

For the right to start each player throws one or two dice; the one who throws the higher number has the right of playing first; and he may either adopt the numbers thrown or he may throw again, using both dice.

The men are moved on from point to point, according to the throws of the dice made by the players alternately. White moves from black's inner table to black's outer, and from this to white's outer table, and so on to white's inner table; and all black's moves must be in the contrary direction. A player may move any of his men a number of points corresponding to the numbers thrown by him, provided the point to which the move

BLACK
Black's Home or Inner Table. Black's Outer Table.

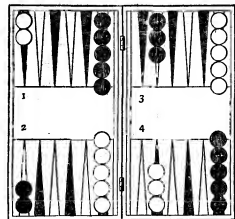

White's Home or Inner Table. White's Outer Table.

WHITE
Backgammon Board.

1. Black's ace-point. 3. Black's bar-point.
2. White's ace-point. 4. White's bar-point.

may move one of his men from the left-hand corner of the black's inner table to the left-hand corner of black's outer table for six; he may, again, move the same man five points farther on, when his move is completed; or he may move any other man five points. But white cannot move a man for five from the black's ace-point, because the six-point in that table is blocked. Any part of the throw which cannot be moved is of no effect, but it is compulsory for a player to move the whole throw unless blocked. Thus if the men were differently placed, and white could move a six, and having done so could not move a five, his move is completed. If, however, by moving the five first, he can afterwards move a six, he must make the move in that manner.

When a player so moves as to place two men on the same point, he is said to "make a point."

When there is only a single man on a point, it is called a "blot." When a blot is left, the man there may be taken up (technically the blot may be "hit") by the adversary if he throws a number which will enable him to place a man on that point. The man hit is placed on the bar, and has to begin again by entering the adversary's home table again at the next throw should it result in a number that corresponds to an unblocked point. The points in the home tables count for this purpose as 1, 2, 3, 4, 5, 6, beginning from the ace-point. A player is not allowed to move any other man while he has one to enter. It is, therefore, an advantage to have made all the points in your own board, so that your adversary, if you take a man up, cannot enter; and you can then continue throwing until a point is opened.

The game proceeds until one of the players gets all his men into his inner table or home. Then he begins to take his men off the board, or to bear them, i.e. to remove a man from any point that corresponds in number with his throw. If such a point is unoccupied, a move must be made, if there is room for it, and a move may be taken, instead of bearing a man, at any time; but

when six is empty, if six is thrown a man may be borne from five and so on. If, after a player has commenced throwing off his men, he should be hit on a blot, he must enter on his adversary's inner table and must bring the man taken up into his own inner table before he can bear further.

Whoever first takes off all his men wins the game:—a single game (a "hit") if his adversary has begun bearing; a double game (a "gammon") if the adversary has not borne a man; and a triple game (a "backgammon") if, at the time the winner bears his last man, his adversary, not having borne a man, has one in the winner's inner table, or has a man up. When a series of games is played, the winner of a hit has the first throw in the succeeding game; but if a gammon is won, the players each throw a single die to determine the first move of the next game.

In order to play backgammon well, it is necessary to know all the chances on two dice and to apply them in various ways. The number of different throws that can be made is thirty-six. By taking all the combinations of these throws which include given numbers, it is easily discovered where blots may be left with the least probability of being hit. For example, to find the chance of being hit where a blot can only be taken up by an ace, the adversary may throw two aces, or ace in combination with any other number up to six, and he may throw each of these in two different ways, so that there are in all eleven ways in which an ace may be thrown. This, deducted from thirty-six (the total number of throws), leaves twenty-five; so that it is 25 to 11 against being hit on an ace. It is very important to bear in mind the chance of being hit on any number. The following table gives the odds against being hit on any number within the reach of one or two dice:—

It is 25 to 11, or about 9 to 4, against being hit on 1	2
" 24 " 12, or 2 " 1, " "	3
" 22 " 14, or about 3 " 2, " "	4
" 21 " 15, or 7 " 5, " "	5
" 21 " 15, " 7 " 5, " "	6
" 19 " 17, " 9 1/2 " 8, " "	7
" 30 " 6, " 5 " 1, " "	8
" 30 " 6, " 5 " 1, " "	9
" 31 " 5, or about 6 " 1, " "	10
" 33 " 3, or 11 " 1, " "	11
" 34 " 2, " 17 " 1, " "	12
" 33 " 3, " 11 " 1, " "	

The table shows that if a blot must be left within the reach of one die, the nearer it is left to the adversary's man the less probability there is of its being hit. Also, that it is long odds against being hit on a blot which is not to be reached with double dice, and that, in that case (on any number from 7 to 11), the farther off the blot is, the less chance there is of its being hit.

The table assumes that the board is open for every possible throw. If part of the throw is blocked by an intervening point being held by adverse men, the chance of being hit is less.

Two principles, then, have to be considered in moving the men:—(1) To make points where there is the best chance of obstructing the opponent. (2) When obliged to leave blots, to choose the position in which they are least likely to be hit.

The best points to secure are the five-point in your own inner table and the five-point in your adversary's inner table. The next best is your own bar-point; and the next best the four in your own inner table.

The best move for some throws at the commencement of a game is as follows:—Aces (the best of all throws), move two on your bar-point and two on your five-point. This throw is often given to inferior players by way of odds.

Ace, trey: make the five-point in your inner table.

Ace, six: make your bar-point.

Deuce, four: move two on the four-point in your own inner table, and two on the five-point in your opponent's inner table.

Deuce, four: make the four-point in your own table.

Threes: play two on the five-point in your own inner table, and two on the four-point of your adversary's inner table, or make your bar-point.

Trey, five: make the trey-point in your own table.

Trey, six: bring a man from your adversary's ace-point as far as he will go.

Fours: move two on the five-point in your adversary's inner table, and two from the five in his outer table.

Four, five and four, six: carry a man from your adversary's ace-point as far as he will go.

Fives: move two men from the five in your adversary's outer table to the trey-point in your inner table.

Five, six: move a man from your adversary's ace-point as far as he will go.

Sixes (the second-best throw): move two on your adversary's bar-point and two on your own bar-point.

In carrying the men home carry the most distant man to your adversary's bar-point, to the six-point in your outer table, and then to the six-point in your inner table. By following this rule as nearly

as the throws admit, you will carry the men to your inner table in the fewest number of throws.

Avoid carrying many men upon the troy or deuce-point in your own tables, as these men are out of play.

Whenever you have taken two of your adversary's men, and two or more points made in your inner table, spread your other men in the hope of making another point in your tables, and of hitting the man your adversary enters.

Always take up a man if the blot you leave in making the move can only be hit with double dice, but if you already have two of your opponent's men in your tables it is unwise to take up a third.

In entering a man which it is to your adversary's advantage to hit, leave the blot upon the lowest point you can, e.g. ace-point in preference to deuce-point.

When your adversary is bearing his men, and you have two men in his table, say, on his ace-point, and several men in the outer table, it is to your advantage to leave one man on the ace-point, because it prevents his bearing his men to the greatest advantage, and gives you the chance of his leaving a blot. But if you find that you can probably save the gammon by bringing both your men out of his table, do not wait for a blot. Eight points is the average throw.

The laws of backgammon (as given by Hoyle) are as follows:—

1. When a man is touched by the caster it must be played if possible; if impossible no penalty. 2. A man is not played till it is placed upon a point and quitted. 3. If a player omits a man from the board there is no penalty. 4. If he bears any number of men before he has entered a man taken up, men so borne must be entered again. 5. If he has mistaken his throw and played it, and his adversary has thrown, it is not in the choice of either of the players to alter it, unless they both agree to do so. 6. If one or both dice are "cocked," i.e. do not lie fairly and squarely on the table, a fresh throw is imperative.

Russian Backgammon varies from the above game in that the men, instead of being set as in the diagram, are entered in the same table by throws of the dice, and both players move in the same direction round to the opposite table. There are various rules for this game. By some a player is not obliged to enter all his men before he moves any; he can take up blots at any time on entering, but while he has a man up, he must enter it before entering any more or moving any of those already entered. If he cannot enter the man that is up, he loses the benefit of the throw.

A player who throws doublets must play or enter not only the number thrown, but also doublets of the number corresponding to the opposite side of the dice; thus, if he throws sixes, he must first enter or move the sixes, as the case may be, and then aces, and he also has another throw. Some rules allow him to play either doublets first, but he must always complete one set before playing the other. If a player cannot play the whole of his throw, his adversary is sometimes allowed to play the unplayed portion, in which cases the caster is sometimes allowed to come in and complete his moves, if he can, and in the event of his having thrown deuce-ace or doublets to throw again. If he throws doublets a second time, he moves and throws again, and so on. The privilege is sometimes restricted by not allowing this advantage to the first doublets thrown by each player. It is sometimes extended by allowing the thrower of the deuce-ace to choose any doublets he likes on the opposite side of the dice, and to throw again. The restriction with regard to the first doublets thrown does not apply to deuce-ace, nor does throwing it remove the restriction with regard to first doublets. A player must first be able to complete the doublets thrown. If the player cannot move the whole throw he cannot take the corresponding doublets, and he is not allowed another throw if he cannot move all the points to which he is entitled.

BACKHUUSEN, or BAKHUISEN, LUDOLF (1631-1708), Dutch painter, was born at Emden, in Hanover. He was brought up as a merchant at Amsterdam, but early discovered so strong a genius for painting that he relinquished business and devoted himself to art. He studied first under Allart van Everdingen and then under Hendrik Dubbels, two eminent masters of the time, and soon became celebrated for his sea-pieces. He was an ardent student of nature, and frequently exposed himself on the sea in an open boat in order to study the effects of tempests. His compositions, which are very numerous, are nearly all variations of one subject, and in a style peculiarly his own, marked by intense realism or faithful imitation of nature. In his later years Backhuusen employed his time in etching and calligraphy. He died in Amsterdam on the 17th of November 1708.

BACKNANG, a town of Germany, in the kingdom of Württemberg, 19 m. by rail N.E. from Stuttgart. Pop. (1900) 7650. It has an interesting church, dating from the 12th century, and notable tanneries and leather factories, woollen and cloth mills. In 1325 Backnang was ceded to Württemberg by Baden. In the vicinity is the Wilhelmsheim sanatorium for consumptives.

BACKSCRATCHER, a long slender rod of wood, whalebone, tortoiseshell, horn or cane, with a carved human hand, usually of ivory, mounted at the extremity. Its name suggests the primary use of the implement, but little is known of its history, and it was unquestionably also employed as a kind of rake to keep in order the huge "heads" of powdered hair worn by ladies during a considerable portion of the 18th and the early part of the 19th centuries. The backscratcher varies in length from 12 to 20 in., and the more elaborate examples, which were occasionally hung from the waist, are silver-mounted, and in rare instances the ivory fingers bear carved rings. The hand is sometimes outstretched, and sometimes the fingers are flexed; the modelling is frequently good, the fingers delicately formed and the nails well defined. As a rule the rod is finished off with a knob. The hand was now and again replaced by a rake or a bird's claw. The hand was indifferently dexter or sinister, but the Chinese variety usually bears a right hand. Like most of the obsolete appliances of daily life, the backscratcher, or scratch-back, as it is sometimes called, has become scarce, and it is one of the innumerable objects which attract the attention of the modern collector.

BACK'S RIVER (*Thlewachodiyeth*, or "Great Fish"), a river in Mackenzie and Keewatin districts, Canada, rising in Sussex lake, a small body of water in 108° 20' W. and 64° 25' N., and flowing with a very tortuous course N.E. to an inlet of the Arctic Ocean, passing through several large lake-expansions—Pelly, Garry, MacDougall and Franklin. Like the Coppermine, the only other large river of this part of Canada, it is rendered unnavigable by a succession of rapids and rocks. It was discovered and explored by Sir George Back in 1834. Its total length is 560 m.

BACKWARDATION, or, as it is more often called for brevity, **BAC**, a technical term employed on the London Stock Exchange to express the amount charged for the loan of stock from one account to the other, and paid to the purchaser by the seller on a bear account (see **ACCOUNT**) in order to allow the seller to defer the delivery of the stock. The seller, having sold for delivery on a certain date, stocks or shares which probably he does not possess, in the hope that he may be able, before the day fixed for delivery, to buy them at a cheaper price and so earn a profit, finds on settling-day that the prices have not gone down according to his expectation, and therefore pays the purchaser an agreed amount of interest (*backwardation*) for the privilege of deferring the delivery, either in order to procure the stock, or else in the hope that there will be a shrinkage in the price which will enable him to gain a profit. (See also **STOCK EXCHANGE**).

BACON, FRANCIS (**BARON VERULAM, VISCOUNT ST ALBANS**) (1561-1626), English philosopher, statesman and essayist, was born at York House in the Strand, London, on the 22nd of January 1560/1. He was the youngest son of Sir Nicholas Bacon (*q.v.*). His mother, the second wife of Sir Nicholas, was a daughter of Sir Anthony Cooke, formerly tutor to Edward VI. She was a woman of considerable culture, well skilled in the classical studies of the period, and a warm adherent of the Reformed or Puritan Church. Very little is known of Bacon's early life and education. His health being then, as always, extremely delicate, he probably received much of his instruction at home. In April 1573 he was entered at Trinity College, Cambridge, where for three years he resided with his brother Anthony. At Cambridge he applied himself diligently to the several sciences as then taught, and came to the conclusion that the methods employed and the results attained were alike erroneous. Although he preserved a reverence for Aristotle (of whom, however, he seems to have known but little), he learned to despise the current Aristotelian philosophy. It yielded no fruit, was serviceable only for disputation, and the end it proposed to itself was a mistaken one. Philosophy must be taught its true purpose, and for this purpose a new method must be devised. With the

first germs of this great conception in his mind, Bacon left the university.

On the 27th of June 1576 he and his brother Anthony were entered *de societate magistrorum* at Gray's Inn, and a few months later he was sent abroad with Sir Amyas Paulet, the English ambassador at Paris. The disturbed state of government and society in France at that time afforded him valuable political instruction. It was formerly supposed that certain *Notes on the State of Christendom*, usually printed in his works, contain the results of his observations, but Spedding has shown that there is no reason for ascribing these *Notes* to him, and that they may be attributed with more probability to one of his brother Anthony's correspondents.

The sudden death of his father in February 1578/9 necessitated Bacon's return to England, and exercised a very serious influence on his fortunes. A considerable sum of money had been laid up by Sir Nicholas for the purchase of an estate for his youngest son, the only one otherwise unprovided for. Owing to his sudden death, this intention was not carried out, and a fifth only of the money descended to Francis. This was one of the gravest misfortunes of his life; he started with insufficient means, acquired a habit of borrowing and was never afterwards out of debt. As it had become necessary that he should adopt some profession, he selected that of law, and took up his residence at Gray's Inn in 1579.

In the fragment *De Interpretatione Naturae Prooemium* (written probably about 1603) Bacon analyses his own mental character and lays before us the objects he had in view when he entered on public life. If his opening sentence, "Ego cum me ad utilitates humanas natum existimarem" ("since I thought myself born to be of advantage to mankind"), seems at first sight a little arrogant, it must be remembered that it is the arrogance of Aristotle's *μεγαλόψυχος*; who thinks himself worthy of great things, and is worthy. The ideal of production of good to the human race through the discovery of truth, was combined in him with the practical desire to be of service to his country. He purposed, therefore, to obtain, if possible, some honourable post in the state which would give him the means of realizing these projects, and would enable him to do somewhat for the church, the third of the objects whose good he had at heart. The constant striving after these three ends is the key to Bacon's life. His qualifications for accomplishing the task were not small. His intellect was far-seeing and acute, quick and yet cautious, meditative, methodical and free from prejudice. If we add to this account that he seems to have been of an unusually amiable disposition we have a fairly complete picture of his mental character at this critical period of his life.

In 1580 he appears to have taken the first step in his career by applying, through his uncle, Burghley, the lord treasurer, for some post at court. His suit, though well received by the queen, was unsuccessful; the particulars are totally unknown. For two years after this disappointment he worked quietly at Gray's Inn, and in 1582 was admitted an outer barrister. In 1584 he took his seat in parliament for Melcombe in Dorsetshire, but the notes for the session do not disclose what reputation he gained. About the same time he made another application to Burghley, apparently with a view to expediting his progress at the bar. His uncle, who appears to have "taken his zeal for ambition," wrote him a severe letter, taking him to task for arrogance and pride, qualities which Bacon vehemently disclaimed. As his advancement at the bar was unusually rapid, his uncle's influence may have been exerted in his behalf. In 1589 he received the first substantial piece of patronage from his powerful kinsman, the reversion of the clerkship of the Star Chamber. The office was worth about £1600 a year; but it did not become vacant for nearly twenty years. A considerable period of his life thus slipped away, and his affairs had not prospered. He had written on the condition of parties in the church; he had set down his thoughts on philosophical reform in the lost tract, *Temporis Partus Maximus*; but he had failed in obtaining the position which he looked upon as an indispensable condition

¹ See *Nic. Eth.* iv. 3. 3. 1123b.

of success. A long and eloquent letter to Burghley² throws additional light upon his character, and gives a hint as to the cause of his uncle's slackness in promoting him.

Some time before this, perhaps as early as 1588, Bacon appears to have become acquainted with the earl of Essex, Elizabeth's favourite. At the close of 1591 he was acting as the earl's confidential adviser, and exerted himself, together with his brother Anthony, diligently in the earl's service. In February 1593 parliament was called, and Bacon took his seat for Middlesex. The special occasion for which the House had been summoned was the discovery of one of the numerous popish plots that distracted Elizabeth's reign.

As Bacon's conduct in this emergency seriously affected his fortunes and has been much misunderstood, it is necessary to state, as briefly as possible, the whole facts of the case. The House having been duly informed of the state necessities, assented to a double subsidy and appointed a committee to draw up the requisite articles. Before this was completed, a message arrived from the House of Lords requesting a conference, which was granted. The committee of the Commons were then informed that the crisis demanded a triple subsidy to be collected in a shorter time than usual, that the Lords could not assent to less than this, and that they desired to confer on the matter. This proposal of the Lords to discuss supply infringed upon the privileges of the Commons; accordingly, when the report of committee was read to the Lower House, Bacon spoke against the proposed conference, pointing out at the same time that a communication from the Lords might be received, but that the actual deliberation on it must be taken by themselves alone. His motion, after some delay, was carried and the conference was rejected. The Lords upon this lowered their demands, and desired merely to make a communication, which, being legitimate, was at once assented to. The House had then before them the proposal for a triple subsidy, to be collected in three, or, as the motion ultimately was shaped, in four years, instead of in six, as the ordinary custom would have been. Bacon, who approved of the increased subsidy, was opposed to the short period in which it was proposed to raise it. He suggested that it would be difficult or impossible for the people to meet such heavy demands, that discontent and trouble would arise, and that the better method of procedure was to raise money by levy or imposition. His motion appears to have received no support, and the four years' subsidy was passed unanimously. Bacon, as it turned out, had been mistaken in thinking that the country would be unable to meet the increased taxation, and his conduct, though prompted by a pure desire to be of service to the queen, gave deep and well-nigh ineradicable offence. He was accused

² "I wax now somewhat ancient; one-and-thirty years is a great deal of sand in the hour-glass. . . I ever bare a mind (in some middle place that I could discharge) to serve her majesty; not as a man born under Sol, that loveth honour; nor under Jupiter, that loveth business (for the contemplative planet carrieth me away wholly); but as a man born under an excellent sovereign, that deserveth the dedication of all men's abilities. . . Again, the meanness of my estate doth somewhat move me; for though I cannot accuse myself that I am either prodigal or slothful, yet my health is not to spend, nor my course to get. Lastly, I confess that I have as vast contemplative ends as I have moderate civil ends; for I have taken all knowledge to be my province; and if I could purge it of two sorts of rovers, whereof the one with frivolous disputations, confutations and verborities, the other with blind experiments and auricular traditions and impostures, hath committed so many spoils, I hope I should bring in industrious observations, grounded conclusions and profitable inventions and discoveries—the best state of that province. This, whether it be curiosity, or vain-glorious, or nature, or (if one take it favourably) *philanthropia*, is so fixed in my mind as it cannot be removed. And I do easily see, that place of any reasonable commandment doth bring commandment of more wits than of a man's own. . . . And if your lordship shall find now, or at any time, that I do seek or affect any place whereunto any that is nearer to your lordship shall be convenient, say then that I am a most dishonest man. And if your lordship will not carry on me, . . . this I will do. I will sell the inheritance that I have, and purchase some lease of quick revenue, or some office of gain that shall be executed by deputy, and so give over all care of service, and become some sorry bookmaker, or a true pioneer in that mine of truth."—Spedding, *Letters and Life*, i. 108-109.

of seeking popularity, and was for a time excluded from the court. His letter to Burghley,¹ who had told him of the queen's displeasure with his speech, offers no apology for what he had said, but expresses regret that his motives should have been misunderstood. He soon felt that the queen's anger was not to be appeased by such a justification. The attorney-generalship had fallen vacant and Bacon became a candidate for the office, his most formidable rival being his life-long antagonist, Edward Coke, who was then solicitor. Essex warmly espoused Bacon's cause and earnestly pressed his claims upon the queen; but his impetuous, pettish pleading tended to retard the cause. Burghley, on the other hand, in no way promoted his nephew's interest; he would recommend him for the solicitorship, but not for the attorney-generalship; and it is not improbable that Sir Robert Cecil secretly used his influence against his cousin. The queen delayed the appointment, and Bacon's fortunes, as they then stood, could ill brook delay. He was harassed with debt and at times so disheartened that he contemplated retirement from public life. In March 1594 it was at last understood that Coke was to be attorney-general. Essex, though bitterly mortified, at once threw all his energies into the endeavour to procure for Bacon the solicitorship; but in this case also, his method of dealing, which was wholly opposed to Bacon's advice,² seemed to irritate the queen. The old offence was not yet forgiven, and after a tedious delay, the office was given, in October 1595, to Serjeant Thomas Fleming. Burghley and Sir John Puckering seem to have assisted Bacon honestly, if not over-warmly, in this second application; but the conduct of Cecil had roused suspicions which were not perhaps without foundation. Essex, to compensate in some degree for Bacon's disappointment, insisted on presenting him with a piece of land, worth about £1800, and situated probably near Twickenham Park. Nor did his kindness cease there; before sailing on the expedition to Cadiz, in the beginning of 1596, he addressed letters to Buckhurst, Fortescue and Egerton, earnestly requesting them to use their influence towards procuring for Bacon the vacant office of master of the rolls. Before anything came of this application, the Cadiz expedition had resulted in a brilliant success, and Essex became the idol of the army and the people. Bacon saw clearly that such a reputation would assuredly alienate the affections of the queen, who loved not to have a subject too powerful or too popular. He therefore addressed an eloquent and imploring letter to the earl, pointing out the dangers of his position and urging upon him what he judged to be the only safe course of action, to seek and secure the favour of the queen alone; above all things dissuading him from the appearance of military popularity. His advice, however, was unpalatable and proved ineffectual. The earl still continued his usual course of dealing with the queen, depending solely upon her supposed affection for him, and insanely jealous of any other whom she might seem to favour. His unskilful and unlucky management of the sea expedition to Ferrol and the Azores in no way lowered his popularity with the people, but undoubtedly weakened his influence with the queen.

Bacon's affairs in the meantime had not been prospering. He had increased his reputation by the publication in 1597 of his *Essays*, along with which were the *Colours of Good and Evil* and the *Meditationes Sacrae*; but his private fortunes were in a bad condition. No public office apparently could be found for him; a scheme for retrieving his position by a marriage with the wealthy widow, Lady Elizabeth Hatton, failed, and in 1598 he was arrested for debt. He seems, however, to have been growing in favour with the queen. Some years previously (perhaps about 1594), he had begun to be employed by her in crown affairs, and he gradually acquired the standing of one of the learned counsel, though he had no commission or warrant, and received no salary. At the same time he was no longer on the former friendly terms with Essex, a certain estrangement

¹ Spedding, *Letters and Life*, i. 234-235, cf. i. 362. This letter, with those to Puckering or Essex and the queen, i. 240-241, should be compared with what is said of them by Macaulay in his *Essay on Bacon*, and by Campbell, *Lives*, ii. 287.

² See *Letters and Life*, i. 289, ii. 314.

having sprung up between them, caused no doubt by the earl's dislike of his friend's advice. The earl's affairs were then at a somewhat critical stage, and as our judgment upon a most important episode in Bacon's life depends upon our knowledge of the events of the ensuing year, it will be requisite to enter somewhat minutely into proceedings with which Bacon himself had nothing to do.

Ireland was then in a rebellious and discontented condition, and it was difficult for the English government to decide either on a definite course of policy with regard to it, or on a leader by whom that policy might be carried out. A violent quarrel took place between the queen and Essex, who for some months retired from court and refused to be reconciled. At last he came forth from his seclusion, and it was soon understood that he was in person to undertake the subjugation of the rebels in Ireland, with a larger force than had ever before been sent into that country. Into the obscure details of this unhappy campaign it is unnecessary to enter; one fact stands out clearly, that Essex endeavoured to carry out a treasonable design. His jealousy and ill-temper had been so roused that the only course open to him seemed to be the obtaining a powerful military force, the possession of which would compel the queen to reinstate him in her favour. Whether or not this plan was in contemplation before he undertook the Irish expedition is not evident, though even outsiders at that time entertained some suspicions, but there can be no doubt of the treasonable character of the negotiations carried on in Ireland. His plans, probably not very definite, were disturbed by an imperative message from the queen, ordering him not to return to England without her permission. He at once set off, and, trusting apparently to her affection for him, presented himself suddenly before her. He was, for the moment, received kindly, but was soon afterwards ordered to keep his chamber, and was then given into the custody of the lord keeper at York House, where he remained till March 1600. His great popularity, and the general ignorance of the reasons for his imprisonment, stirred up a strong feeling against the queen, who was reported to be influenced by Bacon, and such indignation was raised against the latter that his friends feared his life would be in danger. It was at last felt necessary that the queen should in some way vindicate her proceedings, and this she at first did, contrary to Bacon's advice, by a declaration from the Star Chamber. This, however, gave little or no satisfaction, and it was found expedient to do what Bacon had always recommended, to have a fair trial, yet not one in which the sentence must needs be damaging to the earl. The trial accordingly took place before a body of her majesty's councillors, and Bacon had a subordinate and unimportant part in the accusation. Essex does not seem to have been at all hurt by his action in this matter, and shortly after his release they were again on friendly terms, Bacon drawing up letters as if to or from the earl with the design of having them brought before the queen. But Bacon did not know the true character of the transactions in which Essex had been engaged. The latter had been released from all custody in August, but in the meantime he had been busily engaged in treasonable correspondence with James of Scotland, and was counting on the Irish army under his ally, Charles Blount, Baron Mountjoy (afterwards earl of Devonshire), the new deputy. But Mountjoy had apparently come to see how useless the attempt would be to force upon the queen a settlement of the succession and declined to go farther in the matter. Essex was thus thrown upon his own resources, and his anger against the queen being roused afresh by the refusal to renew his monopoly of sweet wines, he formed the desperate project of seizing her person and compelling her to dismiss from her council his enemies Raleigh, Cobham, and Cecil. As some pretext, he intended to affirm that his life was in danger from these men, who were in league with the Spaniards. The plot was forced on prematurely by the suspicions excited at court, and the rash attempt to rouse the city of London (8th of February 1601), proved a complete *fiasco*. The leaders were arrested that night and thrown into prison. Although the actual rising might have appeared a mere outbreak of frantic passion, the private examinations of the most prominent

conspirators disclosed to the government a plot so widely spread, and involving so many of the highest in the land, that it would have been perilous to have pressed home accusations against all who might be implicated. Essex was tried along with the young earl of Southampton, and Bacon, as one of her majesty's counsel, was present on the occasion. Coke, who was principal spokesman, managed the case with great want of skill, incessantly allowing the thread of the evidence to escape, and giving the prisoners opportunity to indulge in irrelevant justifications and protestations which were not ineffectual in distracting attention from the real question at issue. On the first opportunity Bacon rose and briefly pointed out that the earl's plea of having done nothing save what was absolutely necessary to defend his life from the machinations of his enemies was weak and worthless, inasmuch as these enemies were purely imaginary; and he compared his case to that of Peisistratus, who had made use of a somewhat similar stratagem to cloak his real designs upon the city of Athens. He was thereupon interrupted by the earl, who proceeded to defend himself, by declaring that in one of the letters drawn up by Bacon, and purporting to be from the earl to Anthony Bacon, the existence of these rumours, and the dangers to be apprehended from them, had been admitted; and he continued, "If these reasons were then just and true, not counterfeit, how can it be that now my pretences are false and injurious?" To this Bacon replied, that "the letters, if they were there, would not blush to be seen for anything contained in them, and that he had spent more time in vain in studying how to make the earl a good servant to the queen than he had done in anything else." It seems to be forgotten in the general accounts of this matter, not only that Bacon's letters bear out what he said, but that the earl's excuses were false. A second time Bacon was compelled to interfere in the course of the trial, and to recall to the minds of those present the real question at issue. He animadverted strongly upon the puerile nature of the defence, and in answer to a remark by Essex, that if he had wished to stir up a rebellion he would have had a larger company with him, pointed out that his dependence was upon the people of London, and compared his attempt to that of the duke of Guise at Paris. To this the earl made little or no reply. Bacon's use of this illustration and of the former one of Peisistratus, has been much commented on, and in general it seems to have been thought that had it not been for his speeches Essex might have escaped, or, at all events, have been afterwards pardoned. But this view of the matter depends on the supposition that Essex was guilty only of a rash outbreak.¹ That this was not the case was well known to the queen and her council. Unfortunately, prudential motives hindered the publication of the whole evidence; the people, consequently, were still ignorant of the magnitude of the crime, and, till recently, biographers of Bacon have been in a like ignorance.² The earl himself, before execution, confessed his guilt and the thorough justice of his sentence, while, with singular lack of magnanimity, he incriminated several against whom accusations had not been brought, among others his sister Lady Rich. After his execution it was thought necessary that some account of the facts should be drawn up and circulated, in order to remove the prejudice against the queen's action in the matter. This was entrusted to Bacon, who drew up a *Declaration of the Practices and Treasons attempted and committed by Robert, late Earl of Essex*, his first draft being extensively altered and corrected by the queen and council. Nothing is known with certainty of the reception given to this official explanation, but the ill-feeling against Bacon was not wholly removed, and some years later, in 1604, he published, in the form of a letter to Mountjoy, an *Apology* for his action in the case. This *Apology* gives a most fair and temperate history of the relations between Bacon and Essex, shows how the prudent counsel of the one had been rejected by the other, and brings out very clearly what we conceive to be the true explanation of the matter. Everything

that Bacon could do was done by him, until the real nature of Essex's design was made apparent, and then, as he had repeatedly told the earl, his devotion and respect were for the queen and state, not for any subject; friendship could never take rank above loyalty. Those who blame Bacon must acquit Essex of all wrong-doing.

Bacon's private fortunes, during the period after the death of Essex, were not in a flourishing condition. He had obtained a grant of £1200 from the fines imposed on Catesby, one of the conspirators, but his debts were sufficient to swallow up this and much more. And, though he was trusted by Elizabeth, and on good terms with her, he seems to have seen that he had no chance of advancement. But her death in 1603, followed by the undisputed succession of James, gave him new hopes. He used every means in his power to bring himself under James's notice, writing to all his friends at the Scottish court and to the king himself. He managed to obtain a personal interview with the king, but does not seem to have been much satisfied with it. In fact, while the king confirmed in their situations those who had held crown offices under Elizabeth, Bacon, not holding his post by warrant, was practically omitted. He was, however, continued, by special order of the king, as learned counsel extraordinary, but little or no law business appears to have been entrusted to him. He procured, through his cousin Cecil, the dignity of knighthood, which, contrary to his inclination, he received along with about 300 others, on the 23rd of July 1603. Between this time and the opening of James's first parliament he was engaged in literary work, and sent to the king two pamphlets—one on the Union, the other on measures for the pacification of the church. Shortly after he published his *Apology*. In March 1604 parliament met, and during their short session Bacon's hands seem to have been full of work. It was a busy and stirring time, and events occurred during it which carried within them the seeds of much future dissension. Prerogative and privilege came more than once into collision, the abuses of purveyance and wardship were made matters of conference, though the thorough discussion of them was deferred to a succeeding session; while James's temper was irritated by the objections brought against his favourite scheme of the Union, and by the attitude taken up by the House with regard to religious affairs. The records are barely full enough to enable us to judge of the share taken by Bacon in these discussions; his name generally appears as the reporter of the committees on special subjects. We can occasionally, however, discern traces of his tact and remarkable prudence; and, on the whole, his attitude, particularly with regard to the Union question, recommended him to James. He was shortly afterwards formally installed as learned counsel, receiving the salary of £40, and at the same time a pension of £60 yearly. He was also appointed one of the commission to treat of the conditions necessary for the Union; and the admirable manner in which the duties of that body were discharged must be attributed mainly to his influence and his complete mastery of the subject. During the recess he published his *Advancement of Learning*, dedicated to the king.

He was now brought into relations with James, and his prospects began to improve. It is important for us to know what were his ideas upon government, upon parliaments, prerogative, and so forth, since a knowledge of this will clear up much that would seem inexplicable in his life. It seems quite evident³ that Bacon, from position, early training and, one might almost think, natural inclination, held as his ideal of government the Elizabethan system. The king was the supreme power, the centre of law and justice, and his prerogative must not be infringed. Parliament was merely a body called to consult with the king on emergencies (*circa ardua regni*) and to grant supplies. King and parliament together make up the state, but the former is first in nature and importance. The duty of a statesman was, therefore, to carry out the royal will in as prudent a manner as possible; he was the servant of the king, and stood or fell according to his pleasure. He was not singular in his opinions and he was undoubtedly sincere; and it is only

¹ See Macaulay's *Essay on Bacon*.

² The whole story of Essex is given in Spedding's *Letters and Life*. It is vigorously told by J. Bruce in the introduction to his *Correspondence of James VI. with Sir Robert Cecil* (Camden Society, 1861).

³ See *Letters and Life*, iv. 177, vi. 38, vii. 116, 117.

by keeping them constantly in mind that we can understand his after relations with the king.

In the second parliament there was not so much scope for the exercise of his powers. The Gunpowder Plot had aroused in the Commons warmer feelings towards the king; they passed severe laws against recusants, and granted a triple subsidy. At the same time they continued the collection of the grievances concerning which they were to move. In the course of this session Bacon married Alice Barnham "the alderman's daughter, an handsome maiden, to my liking," of whom he had written some years before to his cousin Cecil. Little or nothing is known of their married life.

The third parliament was chiefly occupied with the commercial and legal questions rising out of the proposed Union, in particular, with the dispute as to the naturalization of the *Post Nati*. Bacon argued ably in favour of this measure, but the general feeling was against it. The House would only pass a bill abolishing hostile laws between the kingdoms; but the case of the *Post Nati*, being brought before the law courts, was settled as the king wished. Bacon's services were rewarded in June 1607 by the office of solicitor.¹ Several years passed before he gained another step. Meantime, though circumstances had thrown him too much into active life, he had not forgotten his cherished project of reorganizing natural science. A survey of the ground had been made in the *Advancement*, and some short pieces not published at the time were probably written in the subsequent two or three years. Towards the close of 1607 he sent to his friends a small tract, entitled *Cogitata et Viso*, probably the first draft of what we have under that title. In 1609 he wrote the noble panegyric, *In felicem memoriam Elizabethae*, and the curiously learned and ingenious work, *De Sapientia Veterum*; and completed what seems to have been the *Redargutio Philosophiarum*, or treatise on the "idols of the theatre."

In 1610 the famous fourth parliament of James met. Pre-rogative, despite Bacon's advice and efforts, clashed more than once with liberty; Salisbury's bold schemes for relieving the embarrassment caused by the reckless extravagance of the king proved abortive, and the House was dissolved in February 1611. Bacon took a considerable share in the debates, consistently upheld the prerogative, and seemed yet to possess the confidence of the Commons. The death of Salisbury, occurring soon after, opened a position in which Bacon thought his great political skill and sagacity might be made more immediately available for the king's service. How far he directly offered himself for the post of secretary is uncertain, but we know that his hopes were disappointed, the king himself undertaking the duties of the office. About the same time he made two ineffectual applications for the mastership of the wards; the first, on Salisbury's death, when it was given to Sir George Carey; the second, on the death of Carey. It is somewhat hard to understand why so little favour was shown by the king to one who had proved himself able and willing to do good service, and who, in spite of his disappointments, still continued zealously to offer advice and assistance. At last in 1613, a fair opportunity for promotion occurred. The death of Sir Thomas Fleming made a vacancy in the chief justiceship of the king's bench, and Bacon, after some deliberation, proposed to the king that Coke should be removed from his place in the court of common pleas and transferred to the king's bench. He gives several reasons for this in his letter to the king, but in all probability his chief motive was that pointed out by Spedding, that in the court of king's bench there would be less danger of Coke coming into collision with the king on questions of prerogative, in handling which Bacon was always very circumspect and tender. The vacancy caused by Coke's promotion was then filled up by Hobart, and Bacon, finally, stepped into the place of attorney-general. The fact of this advice being offered and followed in all essentials, illustrates very clearly the close relations between the king and Bacon, who had become a confidential adviser on most occasions of difficulty. That his adherence to the royal party was already noticed and commented on appears from the significant remark

¹ In October 1608 he became treasurer of Gray's Inn. The tercentenary was celebrated in 1908.

of Chamberlain, who, after mentioning the recent changes among the law officials, says, "There is a strong apprehension that . . . Bacon may prove a dangerous instrument."

Further light is thrown upon Bacon's relations with James, and upon his political sympathies, by the letter to the king advocating the calling of a parliament,² and by the two papers of notes on which his letter was founded.³ These documents, even after due weight is given to all considerations urged in their favour,⁴ seem to confirm the view already taken of Bacon's theory of government, and at the same time show that his sympathies with the royal party tended to blind him to the true character of certain courses of action, which can only be justified by a straining of political ethics. The advice he offered, in all sincerity, was most prudent and sagacious, and might have been successfully carried out by a man of Bacon's tact and skill; but it was intensely one-sided, and exhibited a curious want of appreciation of what was even then beginning to be looked on as the true relation of king, parliament and people. Unfortunately for James, he could neither adopt nor carry out Bacon's policy. The parliament which met in April 1614, in which Bacon sat for Cambridge University, and was dissolved in June, after a stormy session, was by no means in a frame of mind suitable for the king's purposes. The House was enraged at the supposed project (then much misunderstood) of the "Undertakers"; objection was taken to Bacon being elected or serving as a member while holding office as attorney-general; and, though an exception was made in his favour, it was resolved that no attorney-general should in future be eligible for a seat in parliament. No supply was granted, and the king's necessities were increased instead of diminished. The emergency suggested to some of the bishops the idea of a voluntary contribution, which was eagerly taken up by the noblemen and crown officials. The scheme was afterwards extended so as to take in the whole kingdom, but lost something of its voluntary character, and the means taken to raise the money, which were not what Bacon would have recommended,⁵ were calculated to stir up discontent. The general dissatisfaction received a somewhat unguarded and intemperate expression in a letter sent to the justices of Marlborough by a gentleman of the neighbourhood, named Oliver St John,⁶ in which he denounced the attempt to raise funds in this way as contrary to law, reason and religion, as constituting in the king personally an act of perjury, involving in the same crime those who contributed, and thereby subjecting all parties to the curses levelled by the church at such offences. St John was summoned before the Star Chamber for slander and treasonable language; and Bacon, *ex officio*, acted as public prosecutor. The sentence pronounced (a fine of £5000 and imprisonment for life) was severe, but it was not actually inflicted, and probably was not intended to be carried out, the success of the prosecution being all that was desired. St John remained a short time in prison, and was then released, after making a full apology and submission. The fine was remitted. It seems incredible that Bacon's conduct on this occasion should have been censured by his biographers. The offence was clear; the law was undoubted; no particular sympathy was excited for the culprit; the sentence was not carried out; and Bacon did only what any one in his place would naturally and necessarily have done. The nature of his office involved him in several trials for treason occurring about the same time, and one of these is of interest sufficient to require a somewhat longer examination. Edmund Spacham⁷ had been

² *Letters and Life*, iv. 380.

³ *Ibid.* iv. 365-373.

⁴ *Ibid.* iv. 375-378.

⁵ *Ibid.* v. 81-83.

⁶ Not to be confounded with any of those of the same name who held the title of Baron St John of Bletsho (see *Dict. of Nat. Biog.* vol. 1, p. 150 ad fin.).

⁷ Circa 1554-1616; educated at Cambridge; ordained priest 1581; vicar of Ridge, Herts. 1581; rector of Hinton St George, Somerset, 1587; eventually condemned to death at the Taunton Assizes (7th August 1615). The sentence was not carried out, and Peacham is said to have died in gaol (March 1616). See Gardiner's *Hist. of England*, ii. 272-283; *State Trials*, ii. 869; *Calendar of State Papers* (1603-1606); Hallam's *Constitutional Hist.* i. 343; T. P. Taswell-Langmead, *English Constitutional History* (5th ed., 1896), p. 425. Nearly all works on constitutional law and history discuss the case.

committed to custody for a libel on his superior, James Montagu (1568-1618), bishop of Bath and Wells. In searching his house for certain papers, the officers came upon some loose sheets stitched together in the form of a sermon, the contents of which were of such a nature that it was judged right to lay them before the council. As it was at first suspected that the writing of this book had been prompted by some disaffected persons, Peacham was interrogated, and after he had declined to give any information, was subjected to torture. Bacon, as one of the learned counsel, was ordered by the council to take part in this examination, which was undoubtedly warranted by precedent, whatever may now be thought of it. Nothing, however, was extracted from Peacham in this way, and it was resolved to proceed against him for treason. Now, in the excited state of popular feeling at that period, the failure of government to substantiate an accusation of treason would have been a serious matter. The king, with whom the council agreed, seems therefore to have thought it desirable to obtain beforehand the opinions of the four chief judges as to whether the alleged offence amounted to treason. In this there was nothing unusual or illegal, and no objection would at that time have been made to it, but James introduced a certain innovation; he proposed that the opinions of the four judges should be given separately and in private. It may be reasonably inferred that his motive for this was the suspicion, or it may be the knowledge, that Coke did not consider the matter treasonable. At all events when Coke, who as a councillor already knew the facts of the case, was consulted regarding the new proposal of the king, he at once objected to it, saying that "this particular and auricular taking of opinions" was "new and dangerous," and "not according to the custom of the realm." He at last reluctantly assented, and proposed that Bacon should consult with him, while the other law officers addressed themselves to the three puisne judges. By Bacon's directions the proposal to the three judges to give their opinions separately was made suddenly and confidently, and any scruples they might have felt were easily overcome. The first step was thus gained, and it was hoped that if "infusion" could be avoided, if the papers bearing on the case were presented to the judges quickly, and before their minds could be swayed by extraneous influence, their decision on the case would be the same as that of the king. It is clear that the extraneous influence to be feared was Coke, who, on being addressed by Bacon, again objected to giving his opinion separately, and even seemed to hope that his brother judges after they had seen the papers would withdraw their assent to giving their decisions privately. Even after the discussion of the case with Bacon, he would not give his opinion until the others had handed in theirs. What the other judges thought is not definitely known, but Bacon appears to have been unable to put in operation the plan he had devised for swaying Coke's judgment,¹ or if he did attempt it, he was unsuccessful, for Coke finally gave an opinion consistent with what he seems to have held at first, that the book was not treasonable, as it did not disable the king's title. Although the opinions of the judges were not made public, yet as we learn, not only from Bacon, but from a sentence in one of Carleton's letters,² a rumour had got about that there was doubt as to the book being treasonable. Under these circumstances, Bacon, who feared that such a report might incite other people to attempt a similar offence, proposed to the king that a second rumour should be circulated in order to destroy the impression caused by the first. "I do think it necessary," he says, "that because we live in an age in which no counsel is kept, and that it is true there is some bruit abroad that the judges of the king's bench do doubt of the case that it should not be treason, that it be given out constantly, and yet as it were in secret, and so a fame to slide, that the doubt was only upon the publication, in that it was never published. For that (if your majesty marketh it) taketh away or at least qualifyeth the danger of the example; for that will be no man's case."³ Bacon's conduct in this matter has been curiously misrepresented. He has been accused of

torturing the prisoner, and of tampering with the judges⁴ by consulting them before the trial; nay, he is even represented as selecting this poor clergyman to serve for an example to terrify the disaffected, as breaking into his study and finding there a sermon never intended to be preached, which merely encouraged the people to resist tyranny.⁵ All this lavish condemnation rests on a complete misconception of the case. If any blame attaches to him, it must arise either from his endeavour to force Coke to a favourable decision, in which he was in all probability prompted by a feeling, not uncommon with him, that a matter of state policy was in danger of being sacrificed to some senseless legal quibble or precedent, or from his advice to the king that a rumour should be set afloat which was not strictly true.

Bacon's share in another great trial which came on shortly afterwards, the Overbury and Somerset case, is not of such a nature as to render it necessary to enter upon it in detail.⁶ It may be noted, however, that his letters about this time show that he had become acquainted with the king's new favourite, the brilliant Sir George Villiers, and that he stood high in the king's good graces. In the early part of 1616, when Thomas Egerton, Baron Ellesmere (c. 1540-1617), the lord chancellor, was dangerously ill, Bacon wrote a long and careful letter to the king, proposing himself for the office, should it fall vacant, and stating as frankly as possible of what value he considered his services would be. In answer, he appears to have received a distinct promise of the reversion of the office; but, as Ellesmere recovered, the matter stood over for a time. He proposed, however, that he should be made a privy councillor, in order to give him more weight in his almost recognized position of adviser to the king, and on the 9th of June 1616 he took the oaths and his seat at the council board.

Meanwhile, his great rival Coke, whose constant tendency to limit the prerogative by law and precedent had made him an object of particular dislike to James, had on two points come into open collision with the king's rights. The first case was an action of *procurator* against the court of chancery, evidently instigated by him, but brought at the instance of certain parties whose adversaries had obtained redress in the chancellor's court after the cause had been tried in the court of king's bench. With all his learning and ingenuity Coke failed in inducing or even forcing the jury to bring in a bill against the court of chancery, and it seems fairly certain that on the technical point of law involved he was wrong. Although his motive was, in great measure, a feeling of personal dislike towards Ellesmere, yet it is not improbable that he was influenced by the desire to restrict in every possible way the jurisdiction of a court which was the direct exponent of the king's wishes. The other case, that of the *commendams*, was more important in itself and in the circumstances connected with it. The general question involved in a special instance was whether or not the king's prerogative included the right of granting at pleasure livings in *commendam*, i.e. to be enjoyed by one who was not the incumbent. Bacon, as attorney-general, delivered a speech, which has not been reported; but the king was informed that the arguments on the other side had not been limited to the special case, but had directly impugned the general prerogative right of granting livings. It was necessary for James, as a party interested, at once to take measures to see that the decision of the judges should not be given on the general question without due consultation. He accordingly wrote to Bacon, directing him to intimate to the judges his pleasure that they should delay judgment until after discussion of the matter with himself. Bacon communicated first with Coke, who in reply desired that similar notice should be given to the other judges. This was done by Bacon, though he seems to hint that in so doing he was

¹ Macaulay's *Essay*. ⁶ Campbell, *Lives*, ii. 344.

² The mysterious crimes supposed to be concealed under the obscure details of this case have cast a shadow of vague suspicion on all who were concerned in it. The minute examination of the facts by Spedding (*Letters and Life*, v. 208-347) seems to show that these secret crimes exist nowhere but in the heated imaginations of romantic biographers and historians.

¹ *Letters and Life*, v. 101.

² *Ibid.* v. 124.

³ *Ibid.* v. 121, n.

going a little beyond his instructions. The judges took no notice of the intimation, proceeded at once to give judgment, and sent a letter in their united names to the king announcing what they had done, and declaring that it was contrary to law and to their oath for them to pay any attention to a request that their decision should be delayed. The king was indignant at this encroachment, and acting partly on the advice of Bacon, held a council on the 6th of June 1616, at which the judges attended. James then entered at great length into the case, censuring the judges for the offensive form of their letter, and for not having delayed judgment upon his demand, which had been made solely because he was himself a party concerned. The judges, at the conclusion of his speech, fell on their knees, and implored pardon for the manner of their letter; but Coke attempted to justify the matter contained in it, saying that the delay required by his majesty was contrary to law. The point of law was argued by Bacon, and decided by the chancellor in favour of the king, who put the question to the judges individually, "Whether, if at any time, in a case depending before the judges, which his majesty conceived to concern him either in power or profit, and thereupon required to consult with them, and that they should stay proceedings in the meantime, they ought not to stay accordingly?" To this all gave assent except Coke, who said that "when the case should be, he would do that should be fit for a judge to do." No voice was taken by the king of this famous, though somewhat evasive, reply, but the judges were again asked what course they would take in the special case now before them. They all declared that they would not decide the matter upon general grounds affecting the prerogative, but upon special circumstances incident to the case; and with this answer they were dismissed. Bacon's conduct throughout the affair has been blamed, but apparently on wrong grounds. As attorney he was merely fulfilling his duty in obeying the command of the king; and in laying down the law on the disputed point, he was, we may be sure, speaking his own convictions. Censure might more reasonably be bestowed on him because he deliberately advised a course of action than which nothing can be conceived better calculated to strengthen the hands of an absolute monarch.¹ This appeared to Bacon justifiable and right, because the prerogative would be defended and preserved intact. Coke certainly stands out in a better light, not so much for his answer, which was rather indefinite, and the force of which is much weakened by his assent to the second question of the king, but for the general spirit of resistance to encroachment exhibited by him. He was undeniably troublesome to the king, and it is no matter for wonder that James resolved to remove him from a position where he could do so much harm. On the 26th June he was called before the council to answer certain charges, one of which was his conduct in the *proemune* question. He acknowledged his error on that head, and made little defence. On the 30th he was suspended from council and bench, and ordered to employ his leisure in revising certain obnoxious opinions in his reports. He did not perform the task to the king's satisfaction, and a few months later he was dismissed from office.

Bacon's services to the king's cause had been most important; and as he had, at the same time, acquired great favour with Villiers, his prospects looked brighter than before. According to his custom, he strove earnestly to guide by his advice the conduct of the young favourite. His letters, in which he analyses the various relations in which such a man must stand, and prescribes the course of action suitable for each, are valuable and deserving of attention.² Very striking, in view of future events, are the words³ in which he gives him counsel as to his dealing with judges: "By no means be you persuaded to interpose yourself by word or letter in any cause depending, or like to be depending, in any court of justice, nor suffer any man to do it where you can hinder it; and by all means dissuade the king himself from it, upon the importunity of any, either for their friends or themselves. If it should prevail, it perverts justice;

but if the judge be so just, and of so undaunted a courage (as he ought to be) as not to be inclined thereby, yet it always leaves a taint of suspicions and prejudice behind it."⁴ It is probable that Villiers at this time had really a sense of the duties attaching to his position⁵ and was willing to be guided by a man of approved wisdom. It was not long before an opportunity occurred for showing his gratitude and favour. Ellesmere resigned the chancellorship on the 5th of March 1616/7, and on the 7th the great seal was bestowed upon Bacon, with the title of lord keeper. Two months later he took his seat with great pomp in the chancery court, and delivered a weighty and impressive opening discourse. He entered with great vigour on his new labours, and in less than a month he was able to report to Buckingham that he had cleared off all outstanding chancery cases. He seemed now to have reached the height of his ambition; he was the first law officer in the kingdom, the accredited minister of his sovereign, and on the best terms with the king and his favourite. His course seemed perfectly prosperous and secure, when a slight storm arising opened his eyes to the frailty of the tenure by which he held his position.

Coke was in disgrace but not in despair; there seemed to be a way whereby he could reconcile himself to Buckingham, through the marriage of his daughter, who had an ample fortune, to Sir John Villiers, brother of the marquess, who was penniless or nearly so. The match was distasteful to Lady Hatton and to her daughter; a violent quarrel was the consequence, and Bacon, who thought the proposed marriage most unsuitable, took Lady Hatton's part. His reasons for disapproval he explained to the king and Buckingham, but found to his surprise that their indignation was strongly roused against him. He received from both bitter letters of reproof; it was rumoured that he would be disgraced, and Buckingham was said to have compared his present conduct to his previous unfaithfulness to Essex. Bacon, who seems to have acted from a simple desire to do the best for Buckingham's own interests, at once changed his course, advanced the match by every means in his power, and by a humble apology appeased the indignation that had been excited against him. It had been a sharp lesson, but things seemed to go on smoothly after it, and Bacon's affairs prospered.

On the 4th of January 1617/8 he received the higher title of lord chancellor; in July of the same year he was made Baron Verulam and in January 1620/1 he was created Viscount St Albans. His fame, too, had been increased by the publication in 1620 of his most celebrated work, the *Novum Organum*. He seemed at length to have made satisfactory progress towards the realization of his cherished aims; the method essential for his Instauration was partially completed; and he had attained as high a rank in the state as he had ever contemplated. But his actions in that position were not calculated to promote the good of his country.

Connected with the years during which he held office is one of the weightiest charges against his character. Buckingham, notwithstanding the advice he had received from Bacon himself, was in the habit of addressing letters to him recommending the causes of suitors. In many cases these seem nothing more than letters of courtesy, and, from the general tone, it might fairly be concluded that there was no intention to sway the opinion of the judge illegally, and that Bacon did not understand the letters in that sense. This view is supported by consideration of the few answers to them which are extant.⁶ One outstanding case, however, that of Dr Steward,⁷ casts some suspicion on all the others. The terms of Buckingham's note⁸ concerning it might easily have aroused doubts; and we find that the further course of the action was to all appearances exactly accommodated to Dr Steward, who

¹ "A position which Bacon in some respects approved. See *Essays*, "Of Ambition." "It is counted by some a weakness in princes to have favourites; but it is of all others the best remedy against ambitious great ones; for when the way of pleasing and displeasing lieth by the favourite, it is impossible any other should be over great."

² *Letters and Life*, vi. 278, 294-296, 313.

³ A somewhat similar case is that of the writ *De Rege inconstituto* brought forward by Bacon. See *Letters and Life*, v. 233-236.

⁴ *Ibid.* vi. 6, 7, 13-26, 27-56. ⁵ *Ibid.* vi. 33.

⁶ *Ibid.* vii. 579-588, analysis of the case by D. D. Heath, who expresses a strong opinion against Bacon's action in the matter.

⁷ *Ibid.* vi. 444.

had been so strongly recommended. It is, of course, dangerous to form an extreme judgment on an isolated and partially understood case, of which also we have no explanation from Bacon himself, but if the interpretation advanced by Heath be the true one, Bacon certainly suffered his first, and, so far as we can see, just judgment on the case to be set aside, and the whole matter to be reopened in obedience to a request from Buckingham.

It is somewhat hard to understand Bacon's position with regard to the king during these years. He was the first officer of the crown, the most able man in the kingdom, prudent, sagacious and devoted to the royal party. Yet his advice was followed only when it chimed in with James's own will; his influence was of a merely secondary kind; and his great practical skill was employed simply in carrying out the measures of the king in the best mode possible. We know indeed that he sympathized cordially with the home policy of the government; he had no objection to such monopolies or patents as seemed advantageous to the country, and for this he is certainly not to be blamed.¹ The opinion was common at the time, and the error was merely ignorance of the true principles of political economy. But we know also that the patents were so numerous as to be oppressive, and we can scarcely avoid inferring that Bacon more readily saw the advantages to the government than the disadvantages to the people. In November 1620, when a new parliament was summoned to meet on January following, he earnestly pressed that the most obnoxious patents, those of alehouses and inns, and the monopoly of gold and silver thread, should be given up, and wrote to Buckingham, whose brothers were interested, advising him to withdraw them from the impending storm. This prudent advice was unfortunately rejected. But while he went cordially with the king in domestic affairs, he was not quite in harmony with him on questions of foreign policy. Not only was he personally in favour of a war with Spain for the recovery of the Palatinate, but he foresaw in such a course of action the means of drawing together more closely the king and his parliament. He believed that the royal difficulties would be removed if a policy were adopted with which the people could heartily sympathize, and if the king placed himself at the head of his parliament and led them on. But his advice was neglected by the vacillating and peace-loving monarch, his proffered proclamation was put aside, and a weak, featureless production substituted in its place. Nevertheless the new parliament seemed at first more responsive than might have been looked for. A double subsidy was granted, which was expressly stated to be "not on any consideration or condition for or concerning the Palatinate." The session, however, was not far advanced when the question of patents was brought up; a determined attack was made upon the very ones of which Bacon had been in dread, and it was even proposed to proceed against the referees (Bacon and Montagu) who had certified that there was no objection to them in point of law. This proposal, though pressed by Coke, was allowed to drop; while the king and Buckingham, acting under the advice of Williams, afterwards lord keeper, agreed to give up the monopolies. It was evident, however, that a determined attack was about to be made upon Bacon, and that the proceeding against the referees was really directed against him. It is probable that this charge was dropped because a more powerful weapon had in the meantime been placed in his enemies' hands. This was the accusation of bribery and corrupt dealings in chancery suits, an accusation apparently wholly unexpected by Bacon, and the possibility of which he seems never to have contemplated until it was actually brought against him. At the beginning of the session a committee had been appointed for inquiring into abuses in the courts of justice. Some illegal practices of certain chancery officials had been detected and punished by the court itself, and generally there was a disposition to overhaul its affairs, while Coke and Lionel Cranfield, earl of Middlesex (1575-1645) directly attacked some parts of the chancellor's administration. But on the 14th of March one

Christopher Aubrey appeared at the bar of the House, and charged Bacon with having received from him a sum of money while his suit was going on, and with having afterwards decided against him. Bacon's letter² on this occasion is worthy of serious attention; he evidently thought the charge was but part of the deliberate scheme to ruin him which had already been in progress. A second accusation (Edward Egerton's case) followed immediately after, and was investigated by the House, who, satisfied that they had just matter for reprobation, appointed the 10th for a conference with the Lords. On that day Bacon, as he had feared, was too ill to attend. He wrote³ to the Lords excusing his absence, requesting them to appoint a convenient time for his defence and cross-examination of witnesses, and imploring them not to allow their minds to be prejudiced against him, at the same time declaring that he would not "trick up an innocency with cavillations, but plainly and ingeniously declare what he knew or remembered." The charges rapidly accumulated, but Bacon still looked upon them as party moves, and was in hopes of defending himself.⁴ Nor did he seem to have lost his courage, if we are to believe the common reports of the day,⁵ though certainly they do not appear worthy of very much credit.

The notes⁶ bearing upon the interview which he obtained with the king show that he had begun to see more clearly the nature and extent of the offences with which he was charged, and that he now felt it impossible altogether to exculpate himself, and that his hopes were directed towards obtaining some mitigation of his sentence. The long roll of charges made upon the 10th of April finally decided him; he gave up all idea of defence, and wrote to the king begging him to show him favour in this emergency.⁷ The next day he sent in a general confession to the Lords,⁸ trusting that this would be considered satisfactory. The Lords, however, decided that it was not sufficient as a ground for their censure, and demanded a detailed and particular confession. A list of twenty-eight charges was then sent him, to which an answer by letter was required. On the 30th of April his "confession and humble submission"⁹ was handed in. In it, after going over the several instances, he says, "I do again confess, that on the points charged upon me, although they should be taken as myself have declared them, there is a great deal of corruption and neglect; for which I am heartily and penitently sorry, and submit myself to the judgment, grace, and mercy of the court."¹⁰ On the 3rd of May, after considerable discussion, the Lords decided upon the sentence, which was,¹¹ That he should undergo fine and ransom of £40,000; that he should be imprisoned in the Tower during the king's pleasure; that he should be for ever incapable of any office, place or employment in the state or commonwealth; that he should never sit in parliament, or come within the verge of the court. This heavy sentence was

¹ *Letters and Life*, vi. 213: "I know I have clean hands and a clean heart, and I hope a clean house for friends or servants. But Job himself, or whosoever was the justest judge, by such hunting for matters against him as hath been used against me, may for a time seem foul, specially in a time when greatness is the mark and accusation is the game." ² *Ibid.* vii. 215-216.

³ *Ibid.* vii. 225-226. From the letter to the king (March 25, 1621): "When I enter into myself, I find not the materials of such a tempest as is comen upon me. I have been (as your majesty knoweth best) never author of any immoderate counsel, but always desired to have things carried *suavis modis*. I have been no avaricious oppressor of the people. I have been no haughty or intolerable or hateful man in my conversation or carriage. I have inherited no hatred from my father, but am a good patriot born. Whence should this be? For these are the things that use to raise dislikes abroad. . . . And for the briberies and gifts wherewith I am charged, when the book of hearts shall be opened, I hope I shall not be found to have the troubled fountain of a corrupt heart in a depraved habit of taking rewards to pervert justice, howsoever I may be frail, and partake of the abuse of the times."

⁴ *Ibid.* vii. 227, and Gardiner, *Prince Charles*, &c. i. 450.

⁵ *Letters and Life*, vii. 236, 238. ⁶ *Ibid.* vii. 241.

⁷ *Ibid.* vii. 242-244; "It resteth therefore that, without fig-leaves, I do ingeniously confess and acknowledge, that having understood the particulars of the charge, not formally from the House but enough to inform my conscience and memory, I find matter sufficient and full, both to move me to desert the defence, and to move your lordships to condemn and censure me."

⁸ *Ibid.* vii. 252-262. ⁹ *Ibid.* vii. 261. ¹⁰ *Ibid.* vii. 270.

¹ For a full discussion of Bacon's connexion with the monopolies, see Gardiner, *Prince Charles*, &c. ii. 355-373. For his opinion of monopolies in general, see *Letters and Life*, vi. 49.

only partially executed. The fine was in effect remitted by the king; imprisonment in the Tower lasted for about four days; a general pardon (not of course covering the parliamentary censure) was made out, and though delayed at the seal for a time by Lord Keeper Williams, was passed probably in November 1621. The cause of the delay seems to have lain with Buckingham, whose friendship had cooled, and who had taken offence at the fallen chancellor's unwillingness to part with York House. This difference was finally smoothed over, and it was probably through his influence that Bacon received the much-desired permission to come within the verge of the court. He never again sat in parliament.

So ends this painful episode, which has given rise to the most severe condemnation of Bacon, and which still presents great and perhaps insuperable difficulties. On the whole, the tendency of the most recent and thorough researches has been towards the opinion that Bacon's own account of the matter (from which, indeed, our knowledge of it is chiefly drawn) is substantially correct. He distinguishes three ways in which bribes may be given,¹ and ingenuously confesses that his own acts amounted to corruption and were worthy of condemnation. Now, corruption strictly interpreted would imply the deliberate sale of justice, and this Bacon explicitly denies, affirming that he never "had bribe or reward in his eye or thought when he pronounced any sentence or order." When we analyse the specific charges against him, with his answers to them, we find many that are really of little weight. The twenty-eighth and last, that of negligence in looking after his servants, though it did him much harm, may fairly be said to imply no moral blame. The majority of the others are instances of gratuities given after the decision, and it is to be regretted that the judgment of the peers gives us no means of determining how such gifts were looked upon, whether or not the acceptance of them was regarded as a "corrupt" practice. In four cases specifically, and in some others by implication, Bacon confesses that he had received bribes from suitors *pendente lite*. Yet he affirms, as we said before, that his intention was never swayed by a bribe; and so far as any of these cases can be traced, his decisions, often given in conjunction with some other official, are to all appearance thoroughly just. In several cases his judgment appears to have been given against the party bestowing the bribe, and in at least one instance, that of Lady Wharton, it seems impossible to doubt that he must have known when accepting the present that his opinion would be adverse to her cause. Although, then, he felt that these practices were really corrupt, and even rejoiced that his own fall would tend to purify the courts from them,² he did not feel that he was guilty of perverting justice for the sake of reward. How far, then, is such defence or explanation admissible and satisfactory? It is clear that two things are to be considered: the one the guilt of taking bribes or presents on any consideration, the other the moral guilt depending upon the wilful perversion of justice. The attempt has sometimes been made to defend the whole of Bacon's conduct on the ground that he did nothing that was not done by many of his contemporaries. Bacon himself disclaims a defence of this nature, and we really have no direct evidence which shows to what extent the offering and receiving of such bribes then prevailed. That the practice was common is indeed implied by the terms in which Bacon speaks of it, and it is not improbable that the fact of these gifts being taken by officials was a thing fairly well known, although all were aware of their illegal character, and it was plain that any public exposure of such dealings would be fatal to the individual against whom the charge was made out.³ Bacon knew all this;

¹ *Letters and Life*, vii. 235-236: "The first, of bargain and contract for reward to pervert justice, *pendente lite*. The second, where the judge conceives the cause to be at an end, by the information of the party or otherwise, and useth not such diligence as he ought to inquire of it. And the third, where the cause is really ended, and it is *sine fraude* without relation to any precedent promise. . . . For the first of them I take myself to be as innocent as any born upon St Innocent's Day, in my heart. For the second, I doubt on some particulars I may be faulty. And for the last, I conceived it to be no fault, but therein I desire to be better informed, that I may be twice penitent, once for the fact and again for the error." ² *Ibid.* vii. 242.

he was well aware that the practice was in itself indefensible,⁴ and that his conduct was therefore corrupt and deserving of censure. So far, then, as the mere taking of bribes is concerned, he would permit no defence, and his own confession and judgment on his action contain as severe a condemnation as has ever been passed upon him. Yet in the face of this he does not hesitate to call himself "the justest chancellor that hath been in the five changes since Sir Nicholas Bacon's time";⁵ and this on the plea that his intentions had always been pure, and had never been affected by the presents he received. His justification has been set aside by modern critics, not on the ground that the evidence demonstrates its falsity,⁶ but because it is inconceivable or unnatural that any man should receive a present from another, and not suffer his judgment to be swayed thereby. It need hardly be said that such an *a priori* conviction is not a sufficient basis on which to found a sweeping condemnation of Bacon's integrity as an administrator of justice. On the other hand, even if it be admitted to be possible and conceivable that a present should be given by a suitor simply as seeking favourable consideration of his cause, and not as desirous of obtaining an unjust decree, and should be accepted by the judge on the same understanding, this would not entitle one absolutely to accept Bacon's statement. Further evidence is necessary in order to give foundation to a definite judgment either way; and it is extremely improbable, nay, almost impossible, that such can ever be produced. In these circumstances, due weight should be given to Bacon's own assertions of his perfect innocence and purity of intention; they ought not to be put out of court unless found in actual contradiction to the facts, and the reverse of this is the case, so far as has yet appeared.⁷

The remaining five years of his life, though he was still harassed by want of means, for James was not liberal, were spent in work far more valuable to the world than anything he had accomplished in his high office. In March 1622 he presented to Prince Charles his *History of Henry VII.*; and immediately, with unwearied industry, set to work to complete some portions of his great work. In November 1622 appeared the *Historia Ventorum*; in January 1622/3, the *Historia Vitae et Mortis*; and in October of the same year, the *De Augmentis Scientiarum*, a Latin translation, with many additions, of the *Advancement*. Finally, in December 1624, he published his *Apophtegms, and Translations of some of the Psalms*, dedicated to George Herbert; and, in 1625, a third and enlarged edition of the *Essays*.

Busily occupied with these labours, his life now drew rapidly to a close. In March 1626 he came to London, and when driving one day near Highgate, was taken with a desire to discover whether snow would act as an antiseptic. He stopped his carriage, got out at a cottage, purchased a fowl, and with his own hands assisted to stuff it with snow. He was seized with a sudden chill, and became so seriously unwell that he had to be conveyed to Lord Arundel's house, which was near at hand. Here his illness increased, the cold and chill brought on bronchitis and he died, after a few days' suffering, on the 9th of April 1626.

are *vitia temporis* as well as *vitia hominis*, and that the beginning of reformations hath the contrary power to the pool of Bethesda, for that had strength to cure only him that was first cast in, and this hath commonly strength to hurt him only that is first cast in."

⁴ See, among many other passages, *Essays*, "Of Great Place": "For corruptions do not only bind thine own hands or thy servant's hands from taking, but bind the hands of suitors also from offering; for integrity useth doth the one; but integrity professed, and with a manifest detestation of bribery, doth the other; and avoid not only the fault but the suspicion."

⁵ Cf. *Letters and Life*, vii. 560: "I was the justest judge that was in England these fifty years; but it was the justest censure in Parliament that was these two hundred years."

⁶ Or on the ground that there was a distinct rule forbidding chancellors and the like officials to take presents. This does not seem to have been the case, if we may judge from what Bacon says *Letters and Life*, vii. 233.

⁷ Not only do the cases, so far as they are known, support Bacon's plea of innocence, but it is remarkable that no attempt at a reversal of any of his numerous decrees appears to have been successful. Had his decrees been wilful perversions of justice, it is scarcely conceivable that some of them should not have been overturned. See *Letters and Life*, vii. 555-562.

Bacon's Works and Philosophy.

A complete survey of Bacon's works and an estimate of his place in literature and philosophy are matters for a volume. It is here proposed merely to classify the works, to indicate their general character and to enter somewhat more in detail upon what he himself regarded as his great achievement,—the re-organization of the sciences and the exposition of a new method by which the human mind might proceed with security and certainty towards the true end of all human thought and action.

Putting aside the letters and occasional writings, we may conveniently distribute the other works into three classes, *Professional, Literary, Philosophical*. The Professional works include the *Reading on the Statute of Uses*, the *Maxims of Law* and the treatise (possibly spurious) on the *Use of the Law*. "I am in good hope," said Bacon himself, "that when Sir Edward Coke's reports and my rules and decisions shall come to posterity, there will be (whatsoever is now thought) question who was the greater lawyer." If Coke's reports show completer mastery of technical details, greater knowledge of precedent, and more of the dogged grasp of the letter than do Bacon's legal writings, there can be no dispute that the latter exhibit an infinitely more comprehensive intelligence of the abstract principles of jurisprudence, with a richness and ethical fullness that more than compensate for their lack of dry legal detail. Bacon seems indeed to have been a lawyer of the first order, with a keen scientific insight into the bearings of isolated facts and a power of generalization which admirably fitted him for the self-imposed task, unfortunately never completed, of digesting or codifying the chaotic mass of the English law.

Among the literary works are included all that he himself designated moral and historical pieces, and to these may be added some theological and minor writings, such as the *Apothegms*. Of the moral works the most valuable are the *Essays*, which have been so widely read and universally admired. The matter is of the familiar, practical kind, that "comes home to men's bosoms." The thoughts are weighty, and even when not original have acquired a peculiar and unique tone or cast by passing through the crucible of Bacon's mind. A sentence from the *Essays* can rarely be mistaken for the production of any other writer. The short, pithy sayings have become popular mottoes and household words. The style is quaint, original, abounding in allusions and witticisms, and rich, even to gorgeousness, with piled-up analogies and metaphors.¹ The first edition contained only ten essays, but the number was increased in 1612 to thirty-eight, and in 1625 to fifty-eight. The short tract, *Colours of Good and Evil*, which with the *Meditationes Sacrae* originally accompanied the *Essays*, was afterwards incorporated with the *De Augmentis*. Along with these works may be classed the curiously learned piece, *De Sapientia Veterum*, in which he works out a favourite idea, that the mythological fables of the Greeks were allegorical and concealed the deepest truths of their philosophy. As a scientific explanation of the myths the theory is of no value, but it affords fine scope for the exercise of Bacon's unrivalled power of detecting analogies in things apparently most dissimilar. The *Apothegms*, though hardly deserving Macaulay's praise of being the best collection of jests in the world, contain a number of those significant anecdotes which Bacon used with such effect in his other writings. Of the historical works, besides a few fragments of the projected history of Britain there remains the *History of Henry VII.*, a valuable work, giving a clear and animated narrative of the reign, and characterizing Henry with great skill. The style is in harmony with the matter, vigorous and flowing, but naturally with less of the quaintness and richness suitable to more thoughtful and original writings.

The peculiarities of Bacon's style were noticed very early by his contemporaries. (See *Letters and Life*, i. 268.) Raleigh and Jonson have both recorded their opinions of it, but no one has characterized it more happily than his friend, Sir Tobie Matthews, "A man so rare in knowledge, of so many several kinds, ended with the facility and felicity of expressing it all in so elegant, significant, so abundant, and yet so choice and ravishing a way of words, of metaphors, of allusions, as perhaps the world hath not seen since it was a world." — "Address to the Reader" prefixed to *Collection of English Letters* (1660).

The series of the literary works is completed by the minor treatises on theological or ecclesiastical questions. Some of the latter, included among the occasional works, are sagacious and prudent and deserve careful study. Of the former, the principal specimens are the *Meditationes Sacrae* and the *Confession of Faith*. The *Paradoxes* (Characters of a believing Christian in paradoxes, and seeming contradictions), which was often and justly suspected, has been conclusively proved by Grosart to be the work of another author.

Philosophical Works.—The great mass of Bacon's writings consists of treatises or fragments, which either formed integral parts of his grand comprehensive scheme, or were closely connected with it. More exactly they may be classified under three heads: (A) Writings originally intended to form parts of the *Instauratio*, but which were afterwards superseded or thrown aside; (B) Works connected with the *Instauratio*, but not directly included in its plan; (C) Writings which actually formed part of the *Instauratio Magna*.

(A) This class contains some important tracts, which certainly contain little, if anything, that is not afterwards taken up and expanded in the more elaborate works, but are not undeserving of attention, from the difference in the point of view and method of treatment. The most valuable of them are: (1) The *Advancement of Learning*, of which no detailed account need be given, as it is completely worked up into the *De Augmentis*, and takes its place as the first part of the *Instauratio*. (2) *Valerius Terminus*, a very remarkable piece, composed probably about 1603, though perhaps retouched at a later period. It contains a brief and somewhat obscure outline of the first two parts in the *Instauratio*, and is of importance as affording us some insight into the gradual development of the system in Bacon's own mind. (3) *Temporis Partus Masculus*, another curious fragment, remarkable not only from its contents, but from its style, which is arrogant and offensive, in this respect unlike any other writing of Bacon's. The adjective *masculus* points to the power of bringing forth fruit possessed by the new philosophy, and perhaps indicates that all previous births of time were to be looked upon as feminine or imperfect; it is used in a somewhat similar sense in *Letters and Life*, vi. 183, "In verbis masculis, no flourishing or painted words, but such words as are fit to go before deeds." (4) *Redargutio Philosophiarum*, a highly finished piece in the form of an oration, composed probably about 1608 or 1609, and containing in pretty full detail much of what afterwards appears in connexion with the *Idola Theatri* in book i. of the *Novum Organum*. (5) *Cogitata et Visa*, perhaps the most important of the minor philosophical writings, dating from 1607 (though possibly the tract in its present form may have been to some extent altered), and containing in weighty and sonorous Latin the substance of the first book of the *Organum*. (6) The *Descriptio Globi Intellectualis*, which is to some extent intermediate between the *Advancement* and the *De Augmentis*, goes over in detail the general classification of the sciences, and enters particularly on some points of minor interest. (7) The brief tract *De Interpretatione Naturae Sententiae Duodecim* is evidently a first sketch of part of the *Novum Organum*, and in phraseology is almost identical with it. (8) A few smaller pieces, such as the *Inquisitio de Motu*, the *Calor et Frigus*, the *Historia Soni et Auditus* and the *Phaenomena Universi*, are early specimens of his *Natural History*, and exhibit the first tentative applications of the new method.

(B) The second group consists of treatises on subjects connected with the *Instauratio*, but not forming part of it. The most interesting, and in many respects the most remarkable, is the philosophic romance, the *New Atlantis*, a description of an ideal state in which the principles of the new philosophy are carried out by political machinery and under state guidance, and where many of the results contemplated by Bacon are in imagination attained. The work was to have been completed by the addition of a second part, treating of the laws of a model commonwealth, which was never written. Another important tract is the *De Principiis atque Originibus secundum Fabulas Cupidinis et Caeli*, where, under the disguise of two old mythological stories, he (in the manner of the *Sapientia Veterum*) finds the deepest truths

concealed. The tract is unusually interesting, for in it he discusses at some length the limits of science, the origin of things and the nature of primitive matter, giving at the same time full notices of Democritus among the ancient philosophers and of Teslio among the modern. Deserving of attention are also the *Cogitationes de Natura Rerum*, probably written early, perhaps in 1605, and the treatise on the theory of the tides, *De Fluxu et Refluxu Maris*, written probably about 1616.

(C) The philosophical works which form part of the *Instauratio* must of course be classed according to the positions which they respectively hold in that scheme of the sciences.

The great work, the reorganization of the sciences, and the restoration of man to that command over nature which he had lost by the fall, consisted in its final form of six divisions.

I. *Partitiones Scientiarum*, a survey of the sciences, either such as then existed or such as required to be constructed afresh—in fact, an inventory of all the possessions of the human mind. The famous classification¹ on which this survey proceeds is based upon an analysis of the faculties and objects of human knowledge. This division is represented by the *De Augmentis Scientiarum*.

II. *Interpretatio Naturae*.—After the survey of all that has yet been done in the way of discovery or invention, comes the new method, by which the mind of man is to be trained and directed in its progress towards the renovation of science. This division is represented, though only imperfectly, by the *Novum Organum*, particularly book ii.

III. *Historia Naturalis et Experimentalis*.—The new method is valueless, because inapplicable, unless it be supplied with materials duly collected and presented—in fact, unless there be found a competent natural history of the *Phaenomena Universi*. A short introductory sketch of the requisites of such a natural history, which, according to Bacon, is essential, necessary, the *basis totius negotii*, is given in the tract *Parascève*, appended to the *Novum Organum*. The principal works intended to form portions of the history, and either published by himself or left in manuscript, are *Historia Ventorum*, *Historia Vitae et Mortis*, *Historia Densit et Rari*, and the extensive collection of facts and observations entitled *Sylva Sylvarum*.

IV. *Scala Intellectus*.—It might have been supposed that the new philosophy could now be inaugurated. Materials had been supplied, along with a new method by which they were to be treated, and naturally the next step would be the finished result. But for practical purposes Bacon interposed two divisions between the preliminaries and the philosophy itself. The first was intended to consist of types or examples of investigations conducted by the new method, serviceable for keeping the whole process vividly before the mind, or, as the title indicates, such that the mind could run rapidly up and down the several steps or grades in the process. Of this division there seems to be only one small fragment, the *Filum Labyrinthi*, consisting of but two or three pages.

V. *Prodromi*, forerunners of the new philosophy. This part, strictly speaking, is quite extraneous to the general design. According to the *Distributio Operis*,² it was to contain certain speculations of Bacon's own, not formed by the new method, but by the unassisted use of his understanding. These, therefore, form temporary or uncertain anticipations of the new philosophy. There is extant a short preface to this division of the work, and according to Spedding, some of the miscellaneous treatises, such as *De Principiis*, *De Fluxu et Refluxu*, the *Cogitationes de Natura Rerum*, may probably have been intended to be included under this head. This supposition receives some support from the manner in which the fifth part is spoken of in the *Novum Organum*, i. 116.

VI. The new philosophy, which is the work of future ages, and the result of the new method.

Bacon's grand motive in his attempt to found the sciences anew was the intense conviction that the knowledge man

¹ The division of the sciences adopted in the great French *Encyclopédie* was founded upon this classification of Bacon's. See Diderot's *Prospectus* (*Œuvres*, iii.) and d'Alembert's *Discours* (*Œuvres*, i.) The scheme should be compared with later attempts of the same nature by Ampère, Cournot, Comte and Herbert Spencer.

² See also "Letter to Fulgentio," *Letters and Life*, vii. 533.

possessed was of little service to him. "The knowledge whereof the world is now possessed, especially that of nature, extendeth not to magnitude and certainty of works."³ Man's sovereignty over nature, which is founded on knowledge alone, had been lost, and instead of the free relation between things and the human mind, there was nothing but vain notions and blind experiments. To restore the original commerce between man and nature, and to recover the *imperium hominis*, is the grand object of all science. The want of success which had hitherto attended efforts in the same direction had been due to many causes, but chiefly to the want of appreciation of the nature of philosophy and its real aim. Philosophy is not the science of things divine and human; it is not the search after truth. "I find that even those that have sought knowledge for itself, and not for benefit or ostentation, or any practical enablement in the course of their life, have nevertheless propounded to themselves a wrong mark, namely, satisfaction (which men call Truth) and not operation."⁴ "Is there any such happiness as for a man's mind to be raised above the confusion of things, where he may have the prospect of the order of nature and error of man? But is this a view of delight only and not of discovery? of contentment and not of benefit? Shall he not as well discern the riches of nature's warehouse as the beauty of her shop? Is truth ever barren? Shall he not be able thereby to produce worthy effects, and to endow the life of man with infinite commodities?"⁵ Philosophy is altogether practical; it is of little matter to the fortunes of humanity what abstract notions one may entertain concerning the nature and the principles of things.⁶ This truth, however, has never yet been recognized;⁷ it has not yet been seen that the true aim of all science is "to endow the condition and life of man with new powers or works,"⁸ or "to extend more widely the limits of the power and greatness of man."⁹ Nevertheless, it is not to be imagined that by this being proposed as the great object of search there is thereby excluded all that has hitherto been looked upon as the higher aims of human life, such as the contemplation of truth. Not so, but by following the new aim we shall also arrive at a true knowledge of the universe in which we are, for without knowledge there is no power; truth and utility are in ultimate aspect the same; "works themselves are of greater value as pledges of truth than as contributing to the comforts of life."¹⁰ Such was the conception of philosophy with which Bacon started, and in which he felt himself to be thoroughly original. As his object was new and hitherto unproposed, so the method he intended to employ was different from all modes of investigation hitherto attempted.

"It would be," as he says, "an unsound fancy and self-contradictory, to expect that things which have never yet been done can be done except by means which have never yet been tried."¹¹ There were many obstacles in his way, and he seems always to have felt that the first part of the new scheme must be a *pars destruens*, a destructive criticism of all other methods. Opposition was to be expected, not only from previous philosophies, but especially from the human mind itself. In the first place, natural antagonism might be looked for from the two opposed sects, the one of whom, in despair of knowledge, maintained that all science was impossible; while the other, resting on authority and on the learning that had been handed down from the Greeks, declared that science was already completely known, and consequently devoted their energies to methodizing and elaborating it. Secondly, within the domain of science itself, properly so called, there were two "kind of rovers" who must be dismissed. The first were the speculative or logical philosophers, who construe the universe *ex analogia hominis*, and not *ex analogia mundi*, who fashion nature according to preconceived ideas, and who employ in their investigations syllogism and abstract reasoning. The second class, who were equally offensive, consisted of those who practised blind experience, which is mere

³ *Fil. Lab.*; *Cog. et Visa. i.*; cf. Pref. to *Ins. Mag.*

⁴ *Val. Ter.* 232; cf. *N. O. i.* 124.

⁵ *Letters*, i. 123. ⁶ *N. O. i.* 116.

⁷ *Fil. Lab.* 5; cf. *N. O. i.* 81; *Val. Ter.* (*Works*, iii. 235); *Advancement*, bk. i. (*Works*, iii. 294).

⁸ *Fil. Lab.* 5; cf. *N. O. i.* 81; *Val. Ter.* (*Works*, iii. 222-233); *New Atlantis* (*Works*, iii. 156).

⁹ *N. O. i.* 116. ¹⁰ *Ibid.* i. 124. ¹¹ *Ibid.* i. 6.

groping in the dark (*vaga experientia mera palpatio est*), who occasionally hit upon good works or inventions, which, like Adalanta's apples, distracted them from further steady and gradual progress towards universal truth. In place of these straggling efforts of the unassisted human mind, a graduated system of helps was to be supplied, by the use of which the mind, when placed on the right road, would proceed with unerring and mechanical certainty to the invention of new arts and sciences.

Such were to be the peculiar functions of the new method, though it has not definitely appeared what that method was, or to what objects it could be applied. But, before proceeding to unfold his method, Bacon found it necessary to enter in considerable detail upon the general subject of the obstacles to progress, and devoted nearly the whole of the first book of the *Organum* to the examination of them. This discussion, though strictly speaking extraneous to the scheme, has always been looked upon as a most important part of his philosophy, and his name is perhaps as much associated with the doctrine of Idols (*Idola*) as with the theory of induction or the classification of the sciences.

The doctrine of the kinds of fallacies or general classes of errors into which the human mind is prone to fall, appears in many of the works written before the *Novum Organum*, and the treatment of them varies in some respects. The classification in the *Organum*, however, not only has the author's sanction, but has received the stamp of historical acceptance; and comparison of the earlier notices, though a point of literary interest, has no important philosophic bearing. The *Idola* (*Nov. Org.* i. 39)¹ false notions of things, or erroneous ways of looking at nature, are of four kinds: the first two innate, pertaining to the very nature of the mind and not to be eradicated; the third creeping insensibly into men's minds, and hence in a sense innate and inseparable; the fourth imposed from without. The first kind are the *Idola Tribus*, idols of the tribe, fallacies incident to humanity or the race in general. Of these, the most prominent are—the proneness to suppose in nature greater order and regularity than there actually is; the tendency to support a preconceived opinion by affirmative instances, neglecting all negative or opposed cases; and the tendency to generalize from few observations, or to give reality to mere abstractions, figments of the mind. Manifest errors also result from the weakness of the senses, which affords scope for mere conjecture; from the influence exercised over the understanding by the will and passions; from the restless desire of the mind to penetrate to the ultimate principles of things; and from the belief that "man is the measure of the universe," whereas, in truth, the world is received by us in a distorted and erroneous manner. The second kind are the *Idola Specus*, idols of the cave, or errors incident to the peculiar mental or bodily constitution of each individual, for according to the state of the individual's mind is his view of things. Errors of this class are innumerable, because there are numberless varieties of disposition; but some very prominent specimens can be indicated. Such are the tendency to make all things subservient to, or take the colour of some favourite subject, the extreme fondness and reverence either for what is ancient or for what is modern, and excess in noting either differences or resemblances amongst things. A practical rule for avoiding these is also given: "In general let every student of nature take this as a rule, that whatever his mind seizes and dwells upon with particular satisfaction is to be held in suspicion."² The third class are the *Idola Fori*, idols of the market-place, errors arising from the influence exercised over the mind by mere words. This, according to

¹The word *Idola* is manifestly borrowed from Plato. It is used twice in connexion with the Platonic Ideas (*N. O.* i. 23, 124) and is contrasted with them as the false appearance. The *εἰδωλόν* with Plato the fleeting, transient image of the real thing, and the passage evidently referred to by Bacon is that in the *Rep.* vii. 516 A, *καὶ πρῶτον μὲν τὰς εἰδῶν ἢ ἀληθῆ καθεστῶν, καὶ μετὰ τοῦτο ἐν τοῖς ὄψεσιν τὰ τε τῶν ἀσθρόνων καὶ τὰ τῶν ἄλλων εἰδῶν, ὑπερῶν δὲ αὐτῶν.* It is explained well in the *Advancement*, bk. i. (*Works*, iii. 287). (For valuable notes on the *Idola*, see T. Fowler's *Nov. Org.* i. 38 notes; especially for a comparison of the *Idola* with Roger Bacon's *Offendicula*.)

²*N. O.* i. 58.

Bacon, is the most troublesome kind of error, and has been especially fatal in philosophy. For words introduce a fallacious mode of looking at things in two ways: first, there are some words that are really merely names for non-existent things, which are yet supposed to exist simply because they have received a name; secondly, there are names hastily and unskillfully abstracted from a few objects and applied recklessly to all that has the faintest analogy with these objects, thus causing the grossest confusion. The fourth and last class are the *Idola Theatri*, idols of the theatre, i.e. fallacious modes of thinking resulting from received systems of philosophy and from erroneous methods of demonstration. The criticism of the demonstrations is introduced later in close connexion with Bacon's new method; they are the rival modes of procedure, to which his own is definitely opposed. The philosophies which are "redargued" are divided into three classes, the sophistical, of which the best example is Aristotle, who, according to Bacon, forces nature into his abstract schemata and thinks to explain by definitions; the empirical, which from few and limited experiments leaps at once to general conclusions; and the superstitious, which corrupts philosophy by the introduction of poetical and theological notions.

Such are the general causes of the errors that infest the human mind; by their exposure the way is cleared for the introduction of the new method. The nature of this method cannot be understood until it is exactly seen to what it is to be applied. What idea had Bacon of science, and how is his method connected with it? Now, the science¹ which was specially and invariably contemplated by him was natural philosophy, the great mother of all the sciences; it was to him the type of scientific knowledge, and its method was the method of all true science. To discover exactly the characteristics and the object of natural philosophy it is necessary to examine the place it holds in the general scheme furnished in the *Advancement* or *De Augmentis*. All human knowledge, it is there laid down, may be referred to man's memory or imagination or reason. In the first, the bare facts presented to sense are collected and stored up; the exposition of them is *history*, which is either natural or civil. In the second, the materials of sense are separated or divided in ways not corresponding to nature but after the mind's own pleasure, and the result is *poetry* or feigned history. In the third, the materials are worked up after the model or pattern of nature, though we are prone to err in the progress from sense to reason; the result is *philosophy*, which is concerned either with God, with nature or with man, the second being the most important. Natural philosophy is again divided into speculative or theoretical and operative or practical, according as the end is contemplation or works. Speculative or theoretical natural philosophy has to deal with natural substances and qualities and is subdivided into physics and metaphysics. Physics inquires into the efficient and material causes of things; metaphysics, into the formal and final causes. The principal objects of physics are concrete substances, or abstract though physical qualities. The research into abstract qualities, the fundamental problem of physics, comes near to the metaphysical study of *forms*, which indeed differs from the first only in being more general, and in having as its results a *form* strictly so called, i.e. a nature or quality which is a limitation or specific manifestation of some higher and better-known genus.² Natural philosophy is, therefore, in ultimate resort the study of *forms*, and, consequently, the fundamental problem of philosophy in general is the discovery of these *forms*.

¹"On a given body to generate or superinduce a new nature or natures, is the work and aim of human power. . . . Of a given nature to discover the form or true specific difference, or nature-engendering nature (*natura naturans*) or source of emanation (for these are the terms which are nearest to a description of the thing), is the work and aim of human knowledge."²

The questions, then, whose answers give the key to the whole Baconian philosophy, may be put briefly thus—What are

²*N. O.* i. 79, 80, 98, 108.

³On the meaning of the word *form* in Bacon's theory see also Fowler's *N. O.* introd. § 8. ⁴*N. O.* ii. 1.

forms? and how is it that knowledge of them solves both the theoretical and the practical problem of science? Bacon himself, as may be seen from the passage quoted above, finds great difficulty in giving an adequate and exact definition of what he means by a form. As a general description, the following passage from the *Novum Organum*, ii. 4, may be cited:—

"The form of a nature is such that given the form the nature infallibly follows. . . . Again, the form is such that if it be taken away the nature infallibly vanishes. . . . Lastly, the true form is such that it deduces the given nature from some source of being which is inherent in more natures, and which is better known in the natural order of things than the form itself."¹

From this it would appear that, since by a nature is meant some sensible quality, superinduced upon, or possessed by, a body, so by a form we are to understand the cause of that nature, which cause is itself a determinate case or manifestation of some general or abstract quality inherent in a greater number of objects. But all these are mostly marks by which a form may be recognized, and do not explain what the form really is. A further definition is accordingly attempted in Aph. 13:—

"The form of a thing is the very thing itself, and the thing differs from the form no otherwise than as the apparent differs from the real, or the external from the internal, or the thing in reference to the man from the thing in reference to the universe."²

This throws a new light on the question, and from it the inference at once follows, that the forms are the permanent causes or substances underlying all visible phenomena, which are merely manifestations of their activity. Are the forms, then, forces? At times it seems as if Bacon had approximated to this view of the nature of things, for in several passages he identifies forms with laws of activity. Thus, he says—

"When I speak of forms I mean nothing more than those laws and determinations of absolute actuality which govern and constitute any simple nature, as heat, light, weight, in every kind of matter and subject that is susceptible of them. Thus the form of heat or the form of light is the same thing as the law of heat or the law of light."³ "Matter rather than forms should be the object of our attention, its configurations and changes of configuration, and simple action, and law of action or motion; for forms are figments of the human mind, unless you will call those laws of action forms."⁴ "Forms or true differences of things, which are in fact laws of pure act."⁵ "For though in nature nothing really exists besides individual bodies, performing pure individual acts according to a fixed law, yet in philosophy this very law, and the investigation, discovery and explanation of it, is the foundation as well of knowledge as of operation. And it is this law, with its clauses, that I mean when I speak of forms."⁶

Several important conclusions may be drawn from these passages. In the first place, it is evident that Bacon, like the Atomical school, of whom he highly approved, had a clear perception and a firm grasp of the physical character of natural principles; his forms are no ideas or abstractions, but highly general physical properties. Further, it is hinted that these general qualities may be looked upon as the modes of action of simple bodies. This fruitful conception, however, Bacon does not work out; and though he uses the word *cause*, and identifies form with formal cause, yet it is perfectly apparent that the modern notions of cause as dynamical, and of nature as in a process of flow or development, are foreign to him, and that in his view of the ultimate problem of science, cause meant *causa immanens*, or underlying substance, effects were not consequences but manifestations, and nature was regarded in a purely statical aspect. That this is so appears even more clearly when we examine his general conception of the unity, gradation and function of the sciences. That the sciences are organically connected is a thought common to him and to his distinguished predecessor Roger Bacon. "I that hold it for a great impediment towards the advancement and further invention of knowledge, that particular arts and sciences have been discontinued from general knowledge, do not understand one

¹ This better known in the order of nature is nowhere satisfactorily explained by Bacon. Like his classification of causes, and in some degree his notion of form itself, it comes from Aristotle. See *An. Post.* 71 b 33; *Topic.* 141 b 5; *Eth. Nic.* 1095 a 30. It should be observed that many writers maintain that the phrase should be *notiora natura*; others, *notiora naturae*. See Fowler's *N. O. p.* 199 note.

² *N. O.* q. 17. ³ *Ibid.* i. 51. ⁴ *Ibid.* i. 75. ⁵ *Ibid.* ii. 2.

and the same thing which Cicero's discourse and the note and conceit of the Grecians in their word *circle learning* do intend. For I mean not that use which one science hath of another for ornament or help in practice; but I mean it directly that use by way of supply of light and information, which the particulars and instances of one science do yield and present for the framing or correcting of the axioms of another science in their very truth and notion."⁶ In accordance with this, Bacon placed at the basis of the particular sciences which treat of God, nature and man, one fundamental doctrine, the *Prima Philosophia*, or first philosophy, the function of which was to display the unity of nature by connecting into one body of truth such of the highest axioms of the subordinate sciences as were not special to one science, but common to several.⁷ This first philosophy had also to investigate what are called the adventitious or transcendental conditions of essences, such as Much, Little, Like, Unlike, Possible, Impossible, Being, Nothing, the logical discussion of which certainly belonged rather to the laws of reasoning than to the existence of things, but the physical or real treatment of which might be expected to yield answers to such questions as, why certain substances are numerous, others scarce; or why, if like attracts like, iron does not attract iron. Following this summary philosophy come the sciences proper, rising like a pyramid in successive stages, the lowest floor being occupied by natural history or experience, the second by physics, the third, which is next the peak of unity, by metaphysics.⁸ The knowledge of the peak, or of the one law which binds nature together, is perhaps denied to man. Of the sciences, physics, as has been already seen, deals with the efficient and material, *i.e.* with the variable and transient, causes of things. But its inquiries may be directed either towards concrete bodies or towards abstract qualities. The first kind of investigation rises little above mere natural history; but the other is more important and paves the way for metaphysics. It handles the configurations and the appetites or motions of matter. The configurations, or inner structure of bodies, include dense, rare, heavy, light, hot, cold, &c.,—in fact, what are elsewhere called simple natures. Motions⁹ are either simple or compound, the latter being the sum of a number of the former. In physics, however, these matters are treated only as regards their material or efficient causes, and the result of inquiry into any one case gives no general rule, but only facilitates invention in some similar instance. Metaphysics, on the other hand, treats of the formal or final cause¹⁰ of these same substances and qualities, and results in a general rule. With regard to forms, the investigation may be directed either towards concrete bodies or towards qualities. But the forms of substances "are so perplexed and complicated, that it is either vain to inquire into them at all, or such inquiry as is possible should be put off for a time, and not entered upon till forms of a more simple nature have been rightly investigated and discussed."¹¹ "To inquire into the form of a lion, of an oak, or gold, nay, even of water or air, is a vain pursuit; but to inquire the form of dense, rare, hot, cold, &c., as well configurations as motions, which in treating of physics I have in

⁶ *Valerius Terminus*, iii. 228-229.

⁷ *Cf. N. O.* ii. 27. Bacon nowhere enters upon the questions of how such a science is to be constructed, and how it can be expected to possess an independent method while it remains the mere receptacle for the generalizations of the several sciences, and consequently has a content which varies with their progress. His whole conception of the *Prima Philosophia* should be compared with such a modern work as the *First Principles* of Herbert Spencer.

⁸ It is to be noticed that this scale of nature corresponds with the scale of ascending axioms.

⁹ *Cf.* also for motions, *N. O.* ii. 48.

¹⁰ The knowledge of final causes does not lead to works, and the consideration of them must be rigidly excluded from physics. Yet there is no opposition between the physical and final causes; in ultimate resort the mind is compelled to think the universe as the work of reason, to refer facts to God and Providence. The idea of final cause is also fruitful in sciences which have to do with human action. (*Cf. De Aug.* iii. cc. 4; *Nov. Org.* i. 48, ii. 2.)

¹¹ *De Aug.* iii. 4. In the *Advancement (Works, iii. 355)* it is distinctly said that they are not to be inquired into. One can hardly see how the Baconian method could have applied to concrete substances.

great part enumerated (I call them forms of the first class), and which (like the letters of the alphabet) are not many, and yet make up and sustain the essences and forms of all substances—this, I say, it is which I am attempting, and which constitutes and defines that part of metaphysics of which we are now inquiring." Physics inquires into the same qualities, but does not push its investigations into ultimate reality or reach the more general causes. We thus at last attain a definite conclusion with regard to forms, and it appears clear that in Bacon's belief the true function of science was the search for a few fundamental physical qualities, highly abstract and general, the combinations of which give rise to the simple natures and complex phenomena around us. His general conception of the universe may therefore be called mechanical or statical; the cause of each phenomenon is supposed to be actually contained in the phenomenon itself, and by a sufficiently accurate process could be sifted out and brought to light. As soon as the causes are known man regains his power over nature, for "whosoever knows any form, knows also the utmost possibility of superinducing that nature upon every variety of matter, and so is less restrained and tied in operation either to the basis of the matter or to the condition of the efficient."

Nature thus presented itself to Bacon's mind as a huge congeries of phenomena, the manifestations of some simple and primitive qualities, which were hid from us by the complexity of the things themselves. The world was a vast labyrinth, amid the windings of which we require some clue or thread whereby we may track our way to knowledge and thence to power. This thread, the *filum labyrinthi*, is the new method of induction. But, as has been frequently pointed out, the new method could not be applied until facts had been observed and collected. This is an indispensable preliminary. "Man, the servant and interpreter of nature, can do and understand so much, and so much only, as he has observed in fact or in thought of the course of nature; beyond this he neither knows anything nor can do anything." The proposition that our knowledge of nature necessarily begins with observation and experience, is common to Bacon and many contemporary reformers of science, but he laid peculiar stress upon it, and gave it a new meaning. What he really meant by observation was a competent natural history or collection of facts. "The firm foundations of a purer natural philosophy are laid in natural history."¹ "First of all we must prepare a natural and experimental history, sufficient and good; and this is the foundation of all."² The senses and the memory, which collect and store up facts, must be assisted; there must be a *ministration* of the senses and another of the memory. For not only are instances required, but these must be arranged in such a manner as not to distract or confuse the mind, *i.e.* tables and arrangements of instances must be constructed. In the preliminary collection the greatest care must be taken that the mind be absolutely free from preconceived ideas; nature is only to be conquered by obedience; man must be merely receptive. "All depends on keeping the eye steadily fixed upon the facts of nature, and so receiving their images simply as they are; for God forbid that we should give out a dream of our own imagination for a pattern of the world; rather may He graciously grant to us to write an apocalypse or true vision of the footsteps of the Creator imprinted on his creatures."³ Concealed among the facts presented to sense are the causes or forms, and the problem therefore is so to analyse experience,⁴ so to break it up into pieces, that we shall with certainty and mechanical ease arrive at a true conclusion. This process, which forms the essence of the new method, may in its entirety, as a ministration to the reason, be called a logic; but it differs widely from the ordinary or school logic in end, method and form. Its aim is to acquire command over nature by knowledge, and to invent new arts, whereas the old logic strove only after dialectic victories and the

¹ Thus the last step in the theoretical analysis gives the first means for the practical operation. Cf. Aristotle, *Eth.* Nic. iii. c. 12, *ἡ τοῦ λογισμοῦ τῆ ἀνάγκη πρῶτον εἶναι ἐν τῆ φύσει.* Cf. also *Ἠθ.* i. 103.

² *Cogitationes* (Works, iii. 187).

³ Pref. to *Instaur.* Cf. *Valerius Term.* (Works, iii. 224), and *N. O.* i. 68, 124.

⁴ *N. O.* ii. 10.

⁵ Pref. to *Inst.*

discovery of new arguments. In method the difference is even more fundamental. Hitherto the mode of demonstration had been by the syllogism; but the syllogism is, in many respects, an incompetent weapon. It is compelled to accept its first principles on trust from the science in which it is employed; it cannot cope with the subtlety of nature; and it is radically vitiated by being founded on hastily and inaccurately abstracted notions of things. For a syllogism consists of propositions, propositions of words, and words are the symbols of notions. Now the first step in accurate progress from sense to reason, or true philosophy, is to frame a *bona notio* or accurate conception of the thing; but the received logic never does this. It flies off at once from experience and particulars to the highest and most general propositions, and from these descends, by the use of middle terms, to axioms of lower generality. Such a mode of procedure may be called *anticipatio naturae* (for in it reason is allowed to prescribe to things), and is opposed to the true method, the *interpretatio naturae*, in which reason follows and obeys nature, discovering her secrets by obedience and submission to rule. Lastly, the very form of induction that has been used by logicians in the collection of their instances is a weak and useless thing. It is a mere enumeration of a few known facts, makes no use of exclusions or rejections, concludes precariously, and is always liable to be overturned by a negative instance.⁶ In radical opposition to this method the Baconian induction begins by supplying helps and guides to the senses, whose unassisted information could not be relied on. Notions were formed carefully, and not till after a certain process of induction was completed.⁷ The formation of axioms was to be carried on by a gradually ascending scale. "Then and only then may we hope well of the sciences, when in a just scale of ascent and by successive steps, not interrupted or broken, we rise from particulars to lesser axioms; and then to middle axioms, one above the other; and last of all to the most general."⁸ Finally the very form of induction itself must be new. "The induction which is to be available for the discovery and demonstration of sciences and arts must analyse nature by proper rejections and exclusions; and then, after a sufficient number of negatives, come to a conclusion on the affirmative instances, which has not yet been done, or even attempted, save only by Plato.⁹ . . . And this induction must be used not only to discover axioms, but also in the formation of notions."¹⁰ This view of the function of exclusion is closely connected with Bacon's doctrine of forms,

⁶ Bacon's summary is valuable. "In the whole of the process which leads from the senses and objects to axioms and conclusions, the demonstrations which we use are deceptive and incompetent. The process consists of four parts, and has as many faults. In the first place, the impressions of the sense itself are faulty, for the sense both fails us and deceives us. But its shortcomings are to be supplied and its deceits to be corrected. Secondly, notions are all drawn from the impressions of the sense, and are indefinite and confused, whereas they should be definite and distinctly bounded. Thirdly, the induction is amiss which infers the principles of sciences by simple enumeration, and does not, as it ought, employ exclusions and solutions (or separations) of nature. Lastly, that method of discovery and proof according to which the most general principles are first established, and then intermediat axioms are tried and proved by them, is the parent of error and the cause of all science."—*N. O.* i. 69.

⁷ *N. O.* i. 105.

⁸ *Ibid.*, i. 104; cf. i. 19-26.

⁹ This exact gives an answer to the objection sometimes raised that Bacon is not original in his theory of induction. He certainly admits that Plato has used a method somewhat akin to his own; but it has frequently been contended that his induction is nothing more than the *ἐπαγωγή* of Aristotle (see *Rémusat's Bacon, &c.*, pp. 310-315, and for a criticism, Waddington, *Essais de Logique*, p. 261, sq.). This seems a mistake. Bacon did not understand by induction the argument from particulars to a general proposition; he looked upon the exclusion and rejection, or upon *elimination*, as the essence of induction. To this process he was led by his doctrine of forms, of which it is the necessary consequence; it is the infallible result of his view of science and its problem, and is as original as that is. Whoever accepts Bacon's doctrine of cause must accept at the same time his theory of the way in which the cause may be sifted out from among the phenomena. It is evident that the Socratic search for the essence by an analysis of instances—an induction ending in a definition—has a strong resemblance to the Baconian inductive method.

¹⁰ *N. O.* i. 105.

and is in fact dependent upon that theory. But induction is neither the whole of the new method, nor is it applicable to forms only. There are two other grand objects of inquiry: the one, the transformation of concrete bodies; the other, the investigation of the latent powers and the latent schematism or configuration. With regard to the first, in ultimate result it depends upon the theory of forms; for whenever the compound body can be regarded as the sum of certain simple natures, then our knowledge of the forms of these natures gives us the power of super-inducing a new nature on the concrete body. As regards the latent process (*latens processus*) which goes on in all cases of generation and continuous development or motion, we examine carefully, and by quantitative measurements, the gradual growth and change from the first elements to the completed thing. The same kind of investigation may be extended to many cases of natural motion, such as voluntary action or nutrition; and though inquiry is here directed towards concrete bodies, and does not therefore penetrate so deeply into reality as in research for forms, yet great results may be looked for with more confidence. It is to be regretted that Bacon did not complete this portion of his work, in which for the first time he approaches modern conceptions of change. The latent configuration (*latens schematismus*) or inward structure of the parts of a body must be known before we can hope to superinduce a new nature upon it. This can only be discovered by analysis, which will disclose the ultimate constituents (natural particles, not atoms) of bodies, and lead back the discussion to forms or simple natures, whereby alone can true light be thrown on these obscure questions. Thus, in all cases, scientific explanation depends upon knowledge of forms; all phenomena or secondary qualities are accounted for by being referred to the primary qualities of matter.

The several steps in the inductive investigation of the form of any nature flow readily from the definition of the form itself. For that is always and necessarily present when the nature is present, absent when it is absent, decreases and increases according as the nature decreases and increases. It is therefore requisite for the inquiry to have before us instances in which the nature is present. The list of these is called the table of *Essence and Presence*. Secondly, we must have instances in which the nature is absent; only as such cases might be infinite, attention should be limited to such of them as are most akin to the instances of presence.¹ The list in this case is called table of *Absence in Proximity*. Thirdly, we must have a number of instances in which the nature is present in different degrees, either increasing or decreasing in the same subject, or variously present in different subjects. This is the table of *Degrees, or Comparison*. After the formation of these tables, we proceed to apply what is perhaps the most valuable part of the Baconian method, and that in which the author took most pride, the process of exclusion or rejection. This elimination of the non-essential, grounded on the fundamental propositions with regard to forms, is the most important of Bacon's contributions to the logic of induction, and that in which, as he repeatedly says, his method differs from all previous philosophies. It is evident that if the tables were complete, and our notions of the respective phenomena clear, the process of exclusion would be a merely mechanical *counting out*, and would infallibly lead to the detection of the cause or form. But it is just as evident that these conditions can never be adequately fulfilled. Bacon saw that his method was impracticable (though he seems to have thought the difficulties not insuperable), and therefore set to work to devise new helps, *adminicula*. These he enumerates in ii., *Aph. 21*:—*Prerogative Instances, Supports of Induction, Rectification of Induction, Varying the Investigation according to the Nature of the Subject, Prerogative Natures, Limits of Investigation, Application to Practice, Preparations for Investigation, the Ascending and Descending Scale of Axioms*. The remainder of the *Organum* is devoted to a consideration of the twenty-seven classes of Prerogative Instances, and though it contains much that is both luminous and helpful, it adds little to our knowledge of what constitutes the Baconian method.

¹ That is to say, differing in nothing save the absence of the nature under investigation.

On the other heads we have but a few scattered hints. But although the rigorous requirements of science could only be fulfilled by the employment of all these means, yet in their absence it was permissible to draw from the tables and the exclusion a hypothetical conclusion, the truth of which might be verified by the use of the other processes; such an hypothesis is called fantastically the First Vintage (*Vindemiatio*). The inductive method, so far as exhibited in the *Organum*, is exemplified by an investigation into the nature of heat.

Such was the method devised by Bacon, and to which he ascribed the qualities of absolute certainty and mechanical simplicity. But even supposing that this method were accurate and completely unfolded, it is evident that it could only be made applicable and produce fruit when the phenomena of the universe have been very completely tabulated and arranged. In this demand for a complete natural history, Bacon also felt that he was original, and he was deeply impressed with the necessity for it;² in fact, he seems occasionally to place an even higher value upon it than upon his *Organum*. Thus, in the preface to his series of works forming the third part of the *Instauratio*, he says: "It comes, therefore, to this, that my *Organum*, even if it were completed, would not without the *Natural History* much advance the *Instauratio of the Sciences*, whereas the *Natural History* without the *Organum* would advance it not a little."³ But a complete natural history is evidently a thing impossible, and in fact a history can only be collected by attending to the requirements of the *Organum*. This was seen by Bacon, and what may be regarded as his final opinion on the question is given in the important letter to Jean Antoine Branzano⁴ ("Redemptus": 1590-1622):—"With regard to the multitude of instances by which men may be deterred from the attempt, here is my answer. First, what need to dissemble? Either store of instances must be procured, or the business must be given up. All other ways, however enticing, are impassable. Secondly, the prerogatives of instances, and the mode of experimenting upon experiments of light (which I shall hereafter explain), will diminish the multitude of them very much. Thirdly, what matter, I ask, if the description of the instances should fill six times as many volumes as Pliny's *History*? . . . For the true natural history is to take nothing except instances, connections, observations and canons."⁵ The *Organum* and the *History* are thus correlative, and form the two equally necessary sides of a true philosophy; by their union the new philosophy is produced.

Summary.—Two questions may be put to any doctrine which professes to effect a radical change in philosophy or science. Is it original? Is it valuable? With regard to the first, it has been already pointed out that Bacon's induction or inductive method is distinctly his own, though it cannot and need not be maintained that the general spirit of his philosophy was entirely new.⁶

The value of the method is the separate and more difficult question. It has been assailed on the most opposite grounds. Macaulay, while admitting the *accuracy* of the process, denied its efficiency, on the ground that an operation performed naturally was not rendered more easy or efficacious by being subjected to analysis.⁷ This objection is curious when confronted with Bacon's reiterated assertion that the *natural* method pursued by the unassisted human reason is distinctly opposed to his; and it is besides an argument that tells so strongly against many sciences, as to be comparatively worthless when applied to any one. There are, however, more formidable objections against the method. It has been pointed out,⁸ and with perfect justice,

² *Distrib. Op. (Works, iv. 28)*; *Parasceve (ibid. 251, 252, 255-256)*; *Descrip. Glob. Intel. ch. 3*.

³ *Works, ii. 16*; cf. *N. O. i. 130*.

⁴ A Barnabite monk, professor of mathematics and philosophy at Anney.

⁵ *Letters and Life, vii. 377*.

⁶ For a full discussion of Bacon's relation to his predecessors and contemporaries, see Fowler's *N. O. introd. § 13*.

⁷ Cf. what Bacon says, *N. O. i. 70*.

⁸ Brewster, *Life of Newton (1855)* (see particularly vol. ii. 403, 405); Lasson, *Über Bacon von Verulam's wissenschaftliche Principien*

that science in its progress has not followed the Baconian method, that no one discovery can be pointed to which can be definitely ascribed to the use of his rules, and that men the most celebrated for their scientific achievements, while paying homage to the name of Bacon, practically set at naught his most cherished precepts. The reason of this is not far to seek, and has been pointed out by logicians the most diametrically opposed schools. The mechanical character both of the natural history and of the logical method applied to it, resulted necessarily from Bacon's radically false conception of the nature of cause and of the causal relation. The whole logical or scientific problem is treated as if it were one of co-existence, to which in truth the method of exclusion is scarcely applicable, and the assumption is constantly made that each phenomenon has one and only one cause.¹ The inductive formation of axioms by a gradually ascending scale is a route which no science has ever followed, and by which no science could ever make progress. The true scientific procedure is by hypothesis followed up and tested by verification; the most powerful instrument is the deductive method, which Bacon can hardly be said to have recognized. The power of framing hypothesis points to another want in the Baconian doctrine. If that power form part of the true method, then the mind is not wholly passive or recipient; it anticipates nature, and moulds the experience received by it in accordance with its own constructive ideas or conceptions; and yet further, the minds of various investigators can never be reduced to the same dead mechanical level.² There will still be room for the scientific use of the imagination and for the creative flashes of genius.³

If, then, Bacon himself made no contributions to science, if no discovery can be shown to be due to the use of his rules, if his method be logically defective, and the problem to which it was applied one from its nature incapable of adequate solution, it may not unreasonably be asked, How has he come to be looked upon as the great leader in the reformation of modern science? How is it that he shares with Descartes the honour of inaugurating modern philosophy? To this the true answer seems to be that Bacon owes his position not only to the general spirit of his philosophy, but to the manner in which he worked into a con- (1866); Liebig, *Über Francis Bacon von Verulam, &c.* (1863). Although Liebig points out how little science proceeds according to Bacon's rules, yet his other criticisms seem of extremely little value. In a very offensive and quite unjustifiable tone, which is severely commented on by Sigwart and Fischer, he attacks the Baconian methods and its results. These results he claims to find in the *Sylva Sylvarum*, entirely ignoring what Bacon himself has said of the nature of that work (*N. O.* i. 117; cf. Rawley's Pref. to the *S. S.*), and thus putting a false interpretation on the experiments there noted. It is not surprising that he should detect many flaws, but he never fails to exaggerate an error, and seems sometimes completely to miss the point of what Bacon says. (See particularly his remarks on *S. S.* 33; 336.) The method he explains in such a way as to show he has not a glimpse of its true nature. He brings against Bacon, of all men, the accusations of making induction start from the undetermined perceptions of the senses, of using imagination, and of putting a quite arbitrary interpretation on phenomena. He crowns his criticism by expounding what he considers to be the true scientific method, which, as has been pointed out by Fischer, is simply that Baconian doctrine against which his attack ought to have been directed. (See his account of the method, *Über Bacon*, 47-49; K. Fischer, *Bacon*, pp. 499-502.)

¹ Mill, *Logic*, pp. 115, 116, 320, 330.

² Whewell, *Phil. of Ind. Sc.* ii. 390, 402-403; Ellis, *Int. to Bacon's Works*, i. 39, 61; Brewster, *Newton*, ii. 404; Jevons, *Princ. of Science* ii. 220. A severe judgment on Bacon's method is given in Dühring's able but one-sided *Kritische Gesch. d. Phil.*, in which the merits of Roger Bacon are brought prominently forward.

³ Although it must be admitted that the Baconian method is fairly open to the above-mentioned objections, it is curious and significant that Bacon was not thoroughly ignorant of them, but with deliberate consciousness preferred his own method. We do not think, indeed, that any one of which he speaks in any way ("compared to what Whewell and Ellis would call "conceptions or ideas furnished by the mind of the thinker"; nor do we imagine that Bacon would have admitted these as necessary elements in the inductive process. But he was certainly not ignorant of what may be called a deductive method, and of a kind of hypothesis. This is clear from the use he makes of the *Vindemiatio*, from certain hints as to the testing of axioms, from his admission of the syllogism into physical reasoning, and from what he calls *Experientia Literata*. The function of the

connected system the new mode of thinking, and to the incomparable power and eloquence with which he expounded and enforced it. Like all epoch-making works, the *Novum Organum* gave expression to ideas which were already beginning to be in the air. The time was ripe for a great change; scholasticism, long decaying, had begun to fall; the authority not only of school doctrines but of the church had been discarded; while here and there a few devoted experimenters were turning with fresh zeal to the unwithered face of nature. The fruitful thoughts which lay under and gave rise to these scattered efforts of the human mind, were gathered up into unity, and reduced to system in the new philosophy of Bacon.⁴ It is assuredly little matter for wonder that this philosophy should contain much that is now inapplicable, and that in many respects it should be vitiated by radical errors. The details of the logical method on which its author laid the greatest stress have not been found of practical service;⁵ yet the fundamental ideas on which the theory rested, the need for rejecting rash generalization, and the necessity for a critical analysis of experience, are as true and valuable now as they were then. Progress in scientific discovery is made mainly, if not solely, by the employment of hypothesis, and for that no code of rules can be laid down such as Bacon had devised.⁶ Yet the framing of hypothesis is no mere random guesswork; it is left not to the imagination alone, but to the *scientific imagination*. There is required in the process not merely a preliminary critical induction, but a subsequent experimental comparison, verification or proof, the canons of which can be laid down with precision. To formulate and show grounds for these laws is to construct a philosophy of induction, and it must not be forgotten that the first step towards the accomplishment of the task was made by Bacon when he introduced and gave prominence to the powerful logical instrument of exclusion or elimination.

It is curious and significant that in the domain of the moral and metaphysical sciences his influence has been perhaps more powerful, and his authority has been more frequently appealed to, than in that of the physical. This is due, not so much to his expressed opinion that the inductive method was applicable to all the sciences,⁶ as to the generally practical, or, one may say, *Vindemiatio* has been already pointed out; with regard to axioms, he says (*N. O.* i. 106). "In establishing axioms by this kind of induction, we must also examine and try whether the axiom so established be framed to the measure of these particulars, from which it is derived, or whether it be larger or wider. And if it be larger and wider, we must observe whether, by indicating to us new particulars, it confirm that wideness and largeness as by a collateral security, that we may not either stick fast in things already known, or loosely grasp at shadows and abstract forms, not at things solid and realized in matter." (Cf. also the passage from *Valerius Terminus*, quoted in Ellis's note on the above aphorism.) "Of the syllogism," he says, "I do not propose to give up the syllogism altogether. S. is incompetent for the principal things rather than useless for the generality. In the mathematics there is no reason why it should not be employed. It is the flux of matter and the inconstancy of the physical body which requires induction, that thereby it may be fixed as it were, and allow the formation of notions well defined. In physics you wisely note, and therein I agree with you, that after the notions of the first class and the axioms concerning them have been by induction well made out and defined, syllogism may be applied safely; only it must be restrained from leaping at once to the most general notions, and progress must be made through a fit succession of steps." ("Letter to Baranzano," *Letters and Life*, vii. 377). And this with may be compared what he says of mathematics (*Nov. Org.* ii. 8; *Parascene*, vii.). In his account of *Experientia Literata* (*De Aug. v. 2*) he comes very near to the modern mode of experimental research. It is, he says, the procedure from one experiment to another, and it is not a science but an art or learned sagacity (resembling in this Aristotle's ἀρχιλογία), which may, however, be enlightened by the precepts of the *Interpretatio*. Eight varieties of such experiments are enumerated, and a comparison is drawn between this and the inductive method; "Of the rational method of inquiry by the Organon promises far greater things in the end, yet this sagacity, proceeding by learned experience, will in the meantime present mankind with a number of inventions which lie near at hand." (Cf. *N. O.* i. 103.)

⁴ See the vigorous passage in Herschel, *Discourse on the Study of Natural Philosophy*, § 105; cf. § 96 of the same work.

⁵ Bacon himself seems to anticipate that the progress of science would of itself render his method antiquated (*Nov. Org.* i. 130).

⁶ *Nov. Org.* i. 127.

positive spirit of his system. Theological questions, which had tortured the minds of generations, are by him relegated from the province of reason to that of faith. Even reason must be restrained from striving after ultimate truth; it is one of the errors of the human intellect that it will not rest in general principles, but must push its investigations deeper. Experience and observation are the only remedies against prejudice and error. Into questions of metaphysics, as commonly understood, Bacon can hardly be said to have entered, but a long line of thinkers have drawn inspiration from him, and it is not without justice that he has been looked upon as the originator and guiding spirit of what is known as the empirical school.

Bacon's Influence.—It is impossible within our limits to do more than indicate the influence which Bacon's views have had on subsequent thinkers. The most valuable and complete discussion of the subject is contained in T. Fowler's edition of the *Novum Organum* (introd. § 14). It is there argued that, both in philosophy and in natural science, Bacon's influence was immediate and lasting. Under the former head it is pointed out (i.) that the fundamental principle of Locke's *Essay*, that all our ideas are product of sensation and reflection, is briefly stated in the first aphorism of the *Novum Organum*, and (ii.) that the whole atmosphere of that treatise is characteristic of the *Essay*. Bacon is, therefore, regarded by many as the father of what is most characteristic in English psychological speculation. As he himself said, he "rang the bell which called the wits together." In the sphere of ethics he is similarly regarded as a forerunner of the empirical method. The spirit of the *De Augustinis* (bk. vii.) and the inductive method which is discussed in the *Novum Organum* are at the root of all theories which have constructed a moral code by an inductive examination of human consciousness and the results of actions. Among such theories utilitarianism especially is the natural result of the application to the phenomenon of conduct of the Baconian experimental method. In this connexion, however, it is important to notice that Hobbes, who had been Bacon's secretary, makes no mention of Baconian induction, nor does he in any of his works make any critical reference to Bacon himself. It would, therefore, appear that Bacon's influence was not immediate.

In the sphere of natural science, Bacon's importance is attested by references to his work in the writings of the principal scientists, not only English, but French, German and Italian. Fowler (*op. cit.*) has collected from Descartes, Gassendi, S. Sorbière, Jean Baptiste du Hamel, quotations which show how highly Bacon was regarded by the leaders of the new scientific movement. Sorbière, who was by no means partial to things English, definitely speaks of him as "celuy qui a le plus puissamment sollicité les intérêts de la physique, et excité le monde à faire des expériences" (*Relation d'un voyage en Angleterre*, Cologne, 1666, pp. 63-64). It was, however, Voltaire and the encyclopaedists who raised Bacon to the pinnacle of his fame in France, and hailed him as "le père de la philosophie expérimentale" (*Lettres sur les Anglois*). Condillac, in the same spirit, says of him, "personne n'a mieux connu que lui la cause de nos erreurs." So the *Encyclopédie*, besides giving a eulogistic article "Baconisme," speaks of him (in d'Alembert's preliminary discourse) as "le plus grand, le plus universel, et le plus éloquent des philosophes." Among other writers, Leibnitz and Huygens give testimony which is the more valuable as being critical. Leibnitz speaks of Bacon as "divini ingenii vir," and, like several other German authors, classes him with Campanella; Huygens refers to his "bonnes méthodes." If, however, we are to attach weight to English writers of the latter half of the 17th century, we shall find that one of Bacon's greatest achievements was the impetus given by his *New Atlantis* to the foundation of the Royal Society (q.v.). Dr Thomas Sprat (1635-1713), bishop of Rochester and first historian of the society, says that Bacon of all others "had the true imagination of the whole extent" of the enterprise, and that in his works are to be found the best arguments for the experimental method of natural philosophy (*Hist. of the Royal Society*, pp. 35-36, and Thomas Tenison's *Baconiana*, pp. 264-266). In this connexion reference should be made also to Cowley's

Ode to the Royal Society, and to Dr John Wallis's remarks in Hearne's *Preface to P. Langtoft's Chronicle* (appendix, num. xi.). Joseph Glanville, in his *Scep sis Scientifica* (dedication) says, "Solomon's house in the *New Atlantis* was a prophetic scheme of the Royal Society"; and Henry Oldenburg (c. 1615-1677), one of the first secretaries of the society, speaks of the new eagerness to obtain scientific data as "a work begun by the single care and conduct of the excellent Lord Verulam." Boyle, in whose works there are frequent eulogistic references to Bacon, regarded himself as a disciple and was indeed known as a second Bacon. The predominating influence of Bacon's philosophy is thus clearly established in the generation which succeeded his own. There is abundant evidence to show that in the universities of Oxford and Cambridge (especially the latter) the new spirit had already modified the old curricula. Bacon has frequently been disparaged on the ground that his name is not mentioned by Sir Isaac Newton. It can be shown, however, that Newton was not ignorant of Bacon's works, and Dr Fowler explains his silence with regard to them on three grounds: (1) that Bacon's reputation was so well established that any definite mention was unnecessary, (2) that it was not customary at the time to acknowledge indebtedness to contemporary and recent writers, and (3) that Newton's genius was so strongly mathematical (whereas Bacon's great weakness was in mathematics) that he had no special reason to refer to Bacon's experimental principles.

If the foregoing examples are held sufficient to establish the influence of Bacon on the intellectual development of his immediate successors, it follows that the whole trend of typically English thought, not only in natural science, but also in mental, moral and political philosophy, is the logical fulfilment of Baconian principles. He argued against the tyranny of authority, the vagaries of unfettered imagination and the academic aims of unpractical dialectic; the vital energy and the reasoned optimism of his language entirely outweigh the fact that his contributions to the stock of actual scientific knowledge were practically inconsiderable. It may be freely admitted that in the domain of logic there is nothing in the *Organum* that has not been more instructively analysed either by Aristotle himself or in modern works; at the same time, there is probably no work which is a better and more stimulating introduction to logical study. Its terse, epigrammatic phrases sink into the fibre of the mind, and are a healthy warning against crude, immature generalization.

While, therefore, it is a profound mistake to regard Bacon as a great constructive philosopher, or even as a lonely pioneer of modern thought, it is quite unfair to speak of him as a trifler. His great work consists in the fact that he summed up the faults which the widening of knowledge had disclosed in medieval thought, and in this sense he stands high among those who were in many parts of 16th-century Europe striving towards a new intellectual activity.

BIBLIOGRAPHY. Editions.—The classical edition is that of R. L. Ellis, J. Spedding and D. D. Heath, 1st ed., 1857; 2nd ed., 1870 (vols. I-III, philosophical writings; IV-V, translations; VI-VII, literary and professional works). B. Montagu's edition (17 vols., 1825-1834) is full but unscholarly. An extremely useful reprint (in one volume) of the philosophical works (with a few not strictly philosophical), based on the first Ellis-Spedding edition, was published by J. M. Robertson (London, 1905); besides the original introductions, it contains a useful summary by the editor of the various problems of Bacon's life and thought. Numerous cheap editions have lately been published, e.g. in the "World's Classics" (1901), and "New Universal Library" series (1905); Sidney Lee, *English Works of Francis Bacon* (London, 1905).

Of particular works there are numerous editions in all the chief languages. The following are the most important:—T. Fowler, *Novum Organum* (Oxford, 1878; ed. 1889), with notes, full introduction on Bacon's philosophy in all its relations, and a most valuable bibliography. This superseded the edition of G. W. Kitchen (Oxford, 1855). The *Essays* have been edited more than twenty times since 1870; the following editions may be mentioned:—Archbishop Whately (6th ed., 1864); W. Aldis Wright (Lond., 1862); F. Storr and Gibson (Lond., 1886); E. A. Abbott (Lond., 1879); John Buchan (Lond., 1879); A. S. West (Cambridge, 1897); W. Evans (Edinburgh, 1897). A facsimile reprint of the 1st edition was published in New York (1904). *Advancement of Learning.*—W. Aldis

Wright (Camb., 1866; 5th ed., 1900); F. G. Selby (1892-1895); H. Morley (1905); and, with the *New Atlantis*, in the "World's Classics" series (introduction by Prof. T. Case, Lond., 1906). *Wisdom of the Ancients and New Atlantis*, in "Cassell's National Library" (1886 and 1903). G. C. M. Smith, *New Atlantis* (1900). J. Fürstenhagen, *Kleinere Schriften* (Leipzig, 1884).

Biography.—J. Spedding, *The Life and Letters of Lord Bacon* (1861), *Life and Times of Francis Bacon* (1878); also Dr Rawley's *Life* in the Ellis-Spedding editions, and J. M. Robertson's reprint (above); W. Hepworth Dixon, *Personal History of Lord Bacon* (Lond., 1861), and *Story of Lord Bacon's Life* (ib., 1862); John Campbell, *Lives of the Chancellors* (Lond., 1845), ii. 51; P. Wood, *Early Life of Lord Bacon* (1902); T. Fowler, *Francis Bacon*, in "English Philos." series (Lond., 1881); R. W. Church's *Bacon*, in "Men of Letters" series (1884).

Philosophy.—Beside the introductions in the Ellis-Spedding and T. Fowler editions, and general histories of philosophy, see:—Kuno Fischer, *Fr. Bacon* (1856, 2nd ed., 1875, Eng. trans. by John Oxenford, Lond., 1857); Ch. de Rémusat, *Bacon, sa vie . . . et son influence* (1857, ed. 1858 and 1877); G. L. Craik, *Lord Bacon, his Writings and his Philosophy* (3 vols., 1846-1847, ed. 1860); A. Dörner, *De Baconis Philosophia* (Berlin, 1867; Lond., 1886); J. v. Liebig, *Über Fr. B. v. Verulam* (Mannheim, 1863); Ad. Lasson, *Über Fr. v. Verulam's wissenschaftliche Principien* (Berl., 1860); E. H. Böhmner, *Über Fr. B. v. Verulam* (Erlangen, 1864); Ch. Adam, *Philos. de Francis Bacon* (Paris, 1890); Barthélemy St Hilaire, *Étude sur Francis Bacon* (Paris, 1890); R. W. Church, *op. cit.*; H. Heussler, *F. Bacon und seine geschichtliche Stellung* (Breslau, 1889); H. Höffding, *History of Modern Philosophy* (Eng. trans., 1900); J. M. Robertson, *Short History of Free Thought* (Lond., 1906); Sidney Lee, *Great Englishmen of the 16th century* (Lond., 1904). For the relations between Bacon and Ben Jonson see *The Tale of the Shakespeare Epitaphs by Francis Bacon* (New York, 1888); for Bacon's poetical gifts see an article in the *Fortnightly Review* (March 1905).

For the Bacon-Shakespeare controversy see SHAKESPEARE.
(R. Ad.; J. M. M.)

BACON, JOHN (1740-1799), British sculptor, was born in Southwark on the 24th of November 1740, the son of Thomas Bacon, a cloth-worker, whose forefathers possessed a considerable estate in Somersetshire. At the age of fourteen he was bound apprentice in Mr Crispe's manufactory of porcelain at Lambeth, where he was at first employed in painting the small ornamental pieces of china, but by his great skill in moulding he soon attained the distinction of being modeller to the work. While engaged in the porcelain works his observation of the models executed by different sculptors of eminence, which were sent to be burned at an adjoining pottery, determined the direction of his genius; he devoted himself to the imitation of them with so much success that in 1758 a small figure of Peace sent by him to the Society for the Encouragement of Arts received a prize, and the highest premiums given by that society were adjudged to him nine times between the years 1763 and 1776. During his apprenticeship he also improved the method of working statues in artificial stone, an art which he afterwards carried to perfection. Bacon first attempted working in marble about the year 1763, and during the course of his early efforts in this art was led to improve the method of transferring the form of the model to the marble (technically "getting out the points") by the invention of a more perfect instrument for the purpose. This instrument possessed many advantages above those formerly employed; it was more exact, took a correct measurement in every direction, was contained in a small compass, and could be used upon either the model or the marble. In the year 1769 he was adjudged the first gold medal for sculpture given by the Royal Academy, his work being a bas-relief representing the escape of Aeneas from Troy. In 1770 he exhibited a figure of Mars, which gained him the gold medal of the Society of Arts and his election as A.R.A. As a consequence of this success he was engaged to execute a bust of George III., intended for Christ Church, Oxford. He secured the king's favour and retained it throughout life. Considerable jealousy was entertained against him by other sculptors, and he was commonly charged with ignorance of classic style. This charge he repelled by the execution of a noble head of Jupiter Tonans, and many of his emblematical figures are in perfect classical taste. He died on the 4th of August 1799 and was buried in Whitfield's Tabernacle. His various productions which may be studied in St Paul's cathedral, London, Christ Church and Pembroke College, Oxford, the Abbey church, Bath,

and Bristol cathedral, give ample testimony to his powers. Perhaps his best works are to be found among the monuments in Westminster Abbey.

See Richard Cecil, *Memoirs of John Bacon, R.A.* (London, 1801); and also vol. i. of R. Cecil's works, ed. J. Pratt (1811).

BACON, LEONARD (1802-1881), American Congregational preacher and writer, was born in Detroit, Michigan, on the 19th of February 1802, the son of David Bacon (1771-1817), missionary among the Indians in Michigan and founder of the town of Tallmadge, Ohio. The son prepared for college at the Hartford (Conn.) grammar school, graduated at Yale in 1820 and at the Andover Theological Seminary in 1823, and from 1825 until his death on the 24th of December 1881 was pastor of the First Church (Congregational) in New Haven, Connecticut, occupying a pulpit which was one of the most conspicuous in New England, and which had been rendered famous by his predecessors, Moses Stuart and Nathaniel W. Taylor. In 1866, however, though he was never dismissed by a council from his connexion with that church, he gave up the active pastorate. He was, from 1826 to 1838, an editor of the *Christian Spectator* (New Haven); was one of the founders (1843) of the *New Englander* (later the *Yale Review*); founded in 1848 with Dr R. S. Storrs, Joshua Leavitt, Dr Joseph P. Thompson and Henry C. Bowen, primarily to combat slavery extension, the *Independent*, of which he was an editor until 1863; and was acting professor of didactic theology in the theological department of Yale University from 1866 to 1871, and lecturer on church polity and American church history from 1871 until his death. Gradually, after taking up his pastorate, he gained greater and greater influence in his denomination, until he came to be regarded as perhaps the most prominent Congregationalist of his time, and was sometimes popularly referred to as "The Congregational Pope of New England." In all the heated theological controversies of the day, particularly the long and bitter one concerning the views put forward by Dr Horace Bushnell, he was conspicuous, using his influence to bring about harmony, and in the councils of the Congregational churches, over two of which, the Brooklyn councils of 1874 and 1876, he presided as moderator, he manifested great ability both as a debater and as a parliamentarian. In his own theological views he was broad-minded and an advocate of liberal orthodoxy. In all matters concerning the welfare of his community or the nation, moreover, he took a deep and constant interest, and was particularly identified with the temperance and anti-slavery movements, his services to the latter constituting probably the most important work of his life. In this, as in most other controversies, he took a moderate course, condemning the abolitionists and defenders of slavery on the one hand and the Garrisonian extremists on the other. His *Slavery Discussed in Occasional Essays from 1833 to 1846* (1846) exercised considerable influence upon Abraham Lincoln, and in this book appears the sentence, which, as rephrased by Lincoln, was widely quoted: "If that form of government, that system of social order is not wrong—if those laws of the Southern States, by virtue of which slavery exists there, and is what it is, are not wrong—nothing is wrong." He was early attracted to the study of the ecclesiastical history of New England and was frequently called upon to deliver commemorative addresses, some of which were published in book and pamphlet form. Of these, his *Thirteen Historical Discourses* (1839), dealing with the history of New Haven, and his *Four Commemorative Discourses* (1866) may be especially mentioned. The most important of his historical works, however, is his *Genesis of the New England Churches* (1874). He published *A Manual for Young Church Members* (1833); edited, with a biography, the *Select Practical Writings of Richard Baxter* (1831); and was the author of a number of hymns, the best-known of which is the one beginning,

"O God, beneath Thy guiding hand
Our exiled fathers crossed the sea."

There is no good biography, but there is much biographical material in the commemorative volume issued by his congregation, *Leonard Bacon, Pastor of the First Church in New Haven* (New Haven, 1882), and there is a good sketch in Williston Walker's *Ten New England Leaders* (New York, 1901).

Leonard Bacon's sister DELIA BACON (1811-1859), born in Tallmadge, Ohio, on the 2nd of February 1811, was a teacher in schools in Connecticut, New Jersey and New York, and then, until about 1852, conducted in various eastern cities, by methods devised by herself, classes for women in history and literature. She wrote *Tales of the Puritans* (1831), *The Bride of Fort Edward* (1830), based on the story of Jane Mc'Crea, partly in blank verse, and *The Philosophy of the Plays of Shakespeare Unfolded* (1857), for which alone she is remembered. This book, in the preparation of which she spent several years in study in England, where she was befriended by Thomas Carlyle and especially by Nathaniel Hawthorne, was intended to prove that the plays attributed to Shakespeare were written by a coterie of men, including Francis Bacon, Sir Walter Raleigh and Edmund Spenser, for the purpose of inculcating a philosophic system, for which they felt that they themselves could not afford to assume the responsibility. This system she professed to discover beneath the superficial text of the plays. Her devotion to this one idea, as Hawthorne says, "had thrown her off her balance," and while she was in England she lost her mind entirely. She died in Hartford, Connecticut, on the 2nd of September 1859.

There is a biography by her nephew, Theodore Bacon, *Delia Bacon: A Sketch* (Boston, 1888), and an appreciative chapter, "Recollections of a Gifted Woman," in Nathaniel Hawthorne's *Our Old Home* (Boston, 1863).

Leonard Bacon's son LEONARD WOOLSEY BACON (1830-1907), graduated at Yale in 1850, was pastor of various Congregational and Presbyterian churches, and published *Church Papers* (1876); *A Life Worth Living: Life of Emily Bliss Gould* (1878); *Irenics and Polemics and Sundry Essays in Church History* (1893); *History of American Christianity* (1898); and *The Congregationalists* (1904). (W. Wr.)

BACON, SIR NICHOLAS (1509-1579), lord keeper of the great seal of England during the reign of Queen Elizabeth, was the second son of Robert Bacon of Drinkstone, Suffolk, and was born at Chislehurst. He was educated at Corpus Christi College, Cambridge, graduating B.A. in 1527, and afterwards spent some time in Paris. Having returned to England and entered Gray's Inn, he was called to the bar in 1533, and four years later began his public life as solicitor of the court of augmentations. Quickly becoming a person of importance he obtained a number of estates, principally in the eastern counties, after the dissolution of the monasteries, and in 1545 became member of parliament for Dartmouth. In 1546 he was made attorney of the court of wards and liveries, an office of both honour and profit; in 1550 became a bencher and in 1552 treasurer of Gray's Inn. Although his sympathies were with the Protestants, he retained his office in the court of wards during Mary's reign, but an order was issued to prevent him from leaving England. The important period in Bacon's life began with the accession of Elizabeth in 1558. Owing largely to his long and close friendship with Sir William Cecil, afterwards Lord Burghley, his brother-in-law, he was appointed lord keeper of the great seal in December of this year, and was soon afterwards made a privy councillor and a knight. He was instrumental in securing the archbishopric of Canterbury for his friend Matthew Parker, and in his official capacity presided over the House of Lords when Elizabeth opened her first parliament. In opposition to Cecil, he objected to the policy of making war on France in the interests of the enemies of Mary queen of Scots, on the ground of the poverty of England; but afterwards favoured a closer union with foreign Protestants, and seemed quite alive to the danger to his country from the allied and aggressive religious policy of France and Scotland. In 1559 he was authorized to exercise the full jurisdiction of lord chancellor. In 1564 he fell temporarily into the royal disfavour and was dismissed from court, because Elizabeth suspected he was concerned in the publication of a pamphlet, "A Declaration of the Succession of the Crowne Imperiaall of England," written by John Hales (q.v.), and favouring the claim of Lady Catherine Grey to the English throne. Bacon's innocence having been admitted he was restored to favour, and replied to a writing by Sir Anthony

Browne, who had again asserted the rights of the house of Suffolk to which Lady Catherine belonged. He thoroughly distrusted Mary queen of Scots; objected to the proposal to marry her to the duke of Norfolk; and warned Elizabeth that serious consequences for England would follow her restoration. He seems to have disliked the proposed marriage between the English queen and Francis, duke of Anjou, and his distrust of the Roman Catholics and the French was increased by the massacre of St Bartholomew. As a loyal English churchman he was ceaselessly interested in ecclesiastical matters, and made suggestions for the better observation of doctrine and discipline in the church. He died in London on the 20th of February 1579 and was buried in St Paul's cathedral, his death calling forth many tributes to his memory. He was an eloquent speaker, a learned lawyer, a generous friend; and his interest in education led him to make several gifts and bequests for educational purposes, including the foundation of a free grammar school at Redgrave. His figure was very corpulent and ungainly. Elizabeth visited him several times at Gorhambury, and had previously visited him at Redgrave. He was twice married and by his first wife, Jane, had three sons and three daughters. His second wife was Anne (d. 1610), daughter of Sir Anthony Cooke, by whom he had two sons. Bacon's eldest son, Nicholas (c. 1540-1624), was member of parliament for the county of Suffolk and in 1611 was created premier baronet of England. This baronetcy is still held by his descendants. His second and third sons, Nathaniel (c. 1550-1622) and Edward (c. 1550-1618), also took some part in public life, and through his daughter, Anne, Nathaniel was an ancestor of the marquesses Townshend. His sons by his second wife were Anthony (1558-1601), a diplomatist of some repute, and the illustrious Francis Bacon (q.v.).

See G. Whetstone, "Remembrance of the life of Sir N. Bacon," in the *Frondes Cadiacæ* (London, 1816); J. A. Froude, *History of England*, passim (London, 1881 f.).

BACON, ROGER (c. 1214-c. 1294), English philosopher and man of science, was born near Ilchester in Somerset. His family appears to have been in good circumstances, but in the stormy reign of Henry III. their property was despoiled and several members of the family were driven into exile. Roger completed his studies at Oxford, though not, as current traditions assert, at Merton or at Brasenose, neither of which had then been founded. His abilities were speedily recognized by his contemporaries, and he enjoyed the friendship of such eminent men as Adam de Marisco and Robert Grosseteste, bishop of Lincoln.

Very little is known of Bacon's life at Oxford; it is said he took orders in 1233, and this is not improbable. In the following year, or perhaps later, he crossed over to France and studied at the university of Paris, then the centre of intellectual life in Europe. The two great orders, Franciscans and Dominicans, were in the vigour of youth, and had already begun to take the lead in theological discussion. Alexander of Hales was the oracle of the Franciscans, while the rival order rejoiced in Albertus Magnus and Thomas Aquinas.

The scientific training which Bacon had received, mainly from the study of the Arab writers, showed him the manifold defects in the systems reared by these doctors. Aristotle was known but in part, and that part was rendered well-nigh unintelligible through the vileness of the translations; yet not one of those professors would learn Greek. The Scriptures read, if at all, in the erroneous versions were being deserted for the *Sentences* of Peter Lombard. Physical science, if there was anything deserving that name, was cultivated, not by experiment in the Aristotelian way, but by arguments deduced from premises resting on authority or custom. Everywhere there was a show of knowledge concealing fundamental ignorance. Bacon, accordingly, withdrew from the scholastic routine and devoted himself to languages and experimental research. The only teacher whom he respected was a certain Petrus de Maharnacia Picardus, or of Picardy, probably identical with a certain mathematician, Petrus Pregrinus of Picardy, who is perhaps the author of a MS. treatise, *De Magnete*, contained in the Bibliothèque Impériale at Paris. The contrast between the obscurity of such a man and

the fame enjoyed by the fluent young doctors roused Bacon's indignation. In the *Opus Minus* and *Opus Tertium* he pours forth a violent tirade against Alexander of Hales, and another professor, not mentioned by name, but spoken of as alive, and blamed even more severely than Alexander. This anonymous writer,¹ he says, acquired his learning by teaching others, and adopted a dogmatic tone, which has caused him to be received at Paris with applause as the equal of Aristotle, Avicenna, or Averroes.

Bacon, during his stay in Paris, acquired considerable renown. He took the degree of doctor of theology, and seems to have received the complimentary title of *doctor mirabilis*. In 1250 he was again at Oxford, and probably about this time entered the Franciscan order. His fame spread at Oxford, though it was mingled with suspicions of his dealings in the black arts and with some doubts of his orthodoxy. About 1257, Bonaventura, general of the order, interdicted his lectures at Oxford, and commanded him to place himself under the superintendence of the body at Paris. Here for ten years he remained under supervision, suffering great privations and strictly prohibited from writing anything for publication. But his fame had reached the ears of the papal legate in England, Guy de Foulques, who in 1265 became pope as Clement IV. In the following year he wrote to Bacon, ordering him notwithstanding any injunctions from his superiors, to write out and send to him a treatise on the sciences which he had already asked of him when papal legate. Bacon, whose previous writings had been mostly scattered tracts, *capitula quaedam*, took fresh courage from this command of the pope. He set at naught the jealousy of his superiors and brother friars, and despite the want of funds, instruments, materials for copying and skilled copyists, completed in about eighteen months three large treatises, the *Opus Majus*, *Opus Minus* and *Opus Tertium*, which, with some other tracts, were despatched to the pope. We do not know what opinion Clement formed of them, but before his death he seems to have bestirred himself on Bacon's behalf, for in 1268 the latter was permitted to return to Oxford. Here he continued his labours in experimental science and also in the composition of complete treatises. The works sent to Clement he regarded as preliminaries, laying down principles which were afterwards to be applied to the sciences. The first part of an encyclopaedic work probably remains to us in the *Compendium Studii Philosophiae* (1271). In this work Bacon makes a vehement attack upon the ignorance and vices of the clergy and monks, and generally upon the insufficiency of the existing studies. In 1278 his books were condemned by Jerome de Ascoli, general of the Franciscans, afterwards Pope Nicholas IV., and he himself was thrown into prison for fourteen years. During this time, it is said, he wrote the small tract *De Retardandis Senectutis Accidentibus*, but this is merely a tradition. In 1292, as appears from what is probably his latest composition, the *Compendium Studii Theologiae*, he was again at liberty. The exact time of his death cannot be determined; 1294 is probably as accurate a date as can be fixed upon.

Works and Editions.—Leland said that it is easier to collect the leaves of the Sibyl than the titles of the works written by Roger Bacon; and though the labour has been somewhat lightened by the publications of Brewer and Charles, referred to below, it is no easy matter even now to form an accurate idea of his actual productions. An enormous number of MSS. are known to exist in British and French libraries, and probably

not all have yet been discovered. Many are transcripts of works or portions of works already published and, therefore, require no notice.²

The works hitherto printed (neglecting reprints) are the following:—(1) *Speculum Alchimiae* (1541)—translated into English (1597); French, A. Poisson (1890); (2) *De Mirabili Poteestate Artium et Naturae* (1542)—English translation (1659); (3) *Libellus de Retardandis Senectutis Accidentibus* (1590)—translated as the "Cure of Old Age," by Richard Brown (London, 1683); (4) *Senioris Medicinæ Magistri D. Rogeri Baconis Anglici de Arte Chymiae Scripta* (Frankfort, 1603)—a collection of small tracts containing *Excerpta de Libro Avicennae de Anima, Breve Breviarium, Verbum Abbreuiatum, Secretum Secretorum, Tractatus Trium Verborum, and Speculum Secretorum*; (5) *Perspectiva* (1614), which is the fifth part of the *Opus Majus*; (6) *Specula Mathematica*, which is the fourth part of the same; (7) *Opus Majus ad Clementem IV.*, edited by S. Jebb (1733) and J. H. Bridges (London, 1897); (8) *Opera hactenus inedita*, by J. S. Brewer (1859), containing the *Opus Tertium, Opus Minus, Compendium Studii Philosophiae* and the *De Secretis Operibus Naturae*; (9) *De Morali Philosophia* (Dublin, 1860, see below); (10) *The Greek Grammar of R. Bacon and a Fragment of his Hebrew Grammar*, edited with introduction and notes by E. S. Nolan and S. A. Hirsch (1902); (11) *Metaphysica Fratris Rogeri*, edited by R. Steele, with a preface (1905); (12) *Opera hactenus inedita*, by Robert Steele (1905).

How these works stand related to one another can only be determined by internal evidence. The smaller works, chiefly on alchemy, are unimportant, and the dates of their composition cannot be ascertained. It is known that before the *Opus Majus* Bacon had already written some tracts, among which an unpublished work, *Computus Naturalium*, on chronology, belongs probably to the year 1263; while, if the dedication of the *De Secretis Operibus* be authentic, that short treatise must have been composed before 1249.

It is, however, with the *Opus Majus* that Bacon's real activity begins. It has been called by Whewell at once the Encyclopaedia and the Organum of the 13th century.

Part I. (pp. 1-22), which is sometimes designated *De Utilitate Scientiarum*, treats of the four *offendicula*, or causes of error. These are, authority, custom, the opinion of the unskilled many, and the concealment of real ignorance with pretence of knowledge. The last error is the most dangerous, and is, in a sense, the cause of all the others. The *offendicula* have sometimes been looked upon as an anticipation of Francis Bacon's *Idola*, but the two classifications have little in common. In the summary of this part, contained in the *Opus Tertium*, Bacon shows very clearly his perception of the unity of science and the necessity of encyclopaedic treatment.

Part II. (pp. 23-43) treats of the relation between philosophy and theology. All true wisdom is contained in the Scriptures, at least implicitly; and the true end of philosophy is to rise from the imperfect knowledge of created things to a knowledge of the Creator. Ancient philosophers, who had not the Scriptures, received direct illumination from God, and only thus can the brilliant results attained by them be accounted for.

Part III. (pp. 44-57) treats of the utility of grammar, and the necessity of a true linguistic science for the adequate comprehension either of the Scriptures or of books on philosophy.

¹ Brewer thinks this unknown professor is Richard of Cornwall, but the little we know of Richard is not in harmony with the terms in which he is elsewhere spoken of by Bacon. Erdmann conjectures Thomas Aquinas, which is extremely improbable, as Thomas was unquestionably not the first of his order to study philosophy. Cousin and Charles think that Albertus Magnus is aimed at, and certainly much of what is said applies with peculiar force to him. But some things do not at all cohere with what is otherwise known of Albert. It is worth pointing out that Brewer, in transcribing the passage bearing on this (*Op. Ined.* p. 327), has the words *fratrum puerulus*, which in his marginal note he interprets as applying to the Franciscan order. In this case, of course, Albert could not be the person referred to, as he was a Dominican. But Charles, in his transcription, entirely omits the important word *fratrum*.

² The more important MSS. are:—(1) The extensive work on the fundamental notions of physics, called *Communium Naturalium*, which is found in the Mazarin library at Paris, in the British Museum, and in the Bodleian and University College libraries at Oxford; (2) on the fundamental notions of mathematics, *De Communibus Mathematicis*, part of which is in the Sloane collection, part in the Bodleian; (3) *Baconis Physica*, contained among the additional MSS. in the British Museum; (4) the fragment called *Quinta Pars Compendii Theologiae*, in the British Museum; (5) the *Compendium Studii Theologiae*, in the British Museum; (6) the logical fragments, such as the *Summulae Dialecticae*, in the Bodleian, and the glosses upon Aristotle's physics and metaphysics in the library at Amiens. See Little, *The Grey Friars in Oxford* (1892).

³ At the close of the *Verb. Abbr.* is a curious note, concluding with the words, "*ipse Rogerus fuit discipulus fratris Alberti!*"

The necessity of accurate acquaintance with any foreign language and of obtaining good texts, is a subject Bacon is never weary of descanting upon. A translator should know thoroughly the language he is translating from, the language into which he is translating, and the subject of which the book treats.

Part IV. (pp. 57-255) contains an elaborate treatise on mathematics, "the alphabet of philosophy," maintaining that all the sciences rest ultimately on mathematics, and progress only when their facts can be subsumed under mathematical principles. This fruitful thought he illustrates by showing how geometry is applied to the action of natural bodies, and demonstrating by geometrical figures certain laws of physical forces. He also shows how his method may be used to determine some curious and long-discussed problems, such as the light of the stars, the ebb and flow of the tide, the motion of the balance. He then proceeds to adduce elaborate and sometimes slightly grotesque reasons tending to prove that mathematical knowledge is essential in theology, and closes this section of his work with two comprehensive sketches of geography and astronomy. That on geography is particularly good, and is interesting as having been read by Columbus, who lighted on it in Petrus de Alliaco's *Imago Mundi*, and was strongly influenced by its reasoning.

Part V. (pp. 256-357) treats of perspective. This was the part of his work on which Bacon most prided himself, and in it, we may add, he seems to owe most to the Arab writers Kindi and Alhazen. The treatise opens with an able sketch of psychology, founded upon, but in some important respects varying from, Aristotle's *De Anima*. The anatomy of the eye is next described; this is done well and evidently at first hand, though the functions of the parts are not given with complete accuracy. Many other points of physiological optics are touched on, in general erroneously. Bacon then discusses vision in a right line, the laws of reflection and refraction, and the construction of mirrors and lenses. In this part of the work, as in the preceding, his reasoning depends essentially upon his peculiar view of natural agents and their activities. His fundamental physical maxims are matter and force; the latter he calls *virtus, species, imago agentis*, and by numberless other names. Change, or any natural phenomenon, is produced by the impression of a *virtus* or species on matter—the result being the thing known. Physical action is, therefore, *impression*, or transmission of force in lines, and must accordingly be explained geometrically. This view of nature Bacon considered fundamental, and it lies, indeed, at the root of his whole philosophy. To the short notices of it given in the 4th and 5th parts of the *Opus Majus*, he subjoined two, or perhaps three, extended accounts of it. We possess at least one of these in the tract *De Multiplicatione Specierum*, printed as part of the *Opus Majus* by Jebb (pp. 358-444). We cannot do more than refer to Charles for discussions as to how this theory of nature is connected with the metaphysical problems of force and matter, with the logical doctrine of universals, and in general with Bacon's theory of knowledge.

Part VI. (pp. 445-477) treats of experimental science, *domina omnium scientiarum*. There are two methods of knowledge: the one by argument, the other by experience. Mere argument is never sufficient; it may decide a question, but gives no satisfaction or certainty to the mind, which can only be convinced by immediate inspection or intuition. Now this is what experience gives. But experience is of two sorts, external and internal; the first is that usually called experiment, but it can give no complete knowledge even of corporeal things, much less of spiritual. On the other hand, in inner experience the mind is illuminated by the divine truth, and of this supernatural enlightenment there are seven grades.

Experimental science, which in the *Opus Tertium* (p. 46) is distinguished from the speculative sciences and the operative arts in a way that forcibly reminds us of Francis Bacon, is said to have three great prerogatives over all other sciences:—(1) It verifies their conclusions by direct experiment; (2) It discovers truths which they could never reach; (3) It investigates the secrets of nature, and opens to us a knowledge of past and future. As an instance of his method, Bacon gives an investigation into

the nature and cause of the rainbow, which is really a very fine specimen of inductive research.

The seventh part of the *Opus Majus* (*De Morali Philosophia*), not given in Jebb's edition, is noticed at considerable length in the *Opus Tertium* (cap. xiv.). Extracts from it are given by Charles (pp. 339-348).

As has been seen, Bacon had no sooner finished this elaborate work than he began to prepare a summary to be sent along with it. Of this summary, or *Opus Minus*, part has come down and is published in Brewer's *Op. Ined.* (313-389), from what appears to be the only MS. The work was intended to contain an abstract of the *Opus Majus*, an account of the principal vices of theology, and treatises on speculative and practical alchemy. At the same time, or immediately after, Bacon began a third work as a pre-amble to the other two, giving their general scope and aim, but supplementing them in many points. The part of this work, generally called *Opus Tertium*, is printed by Brewer (pp. 1-310), who considers it to be a complete treatise. Charles, however, has given good grounds for supposing that it is merely a preface, and that the work went on to discuss grammar, logic (which Bacon thought of little service, as reasoning was innate), mathematics, general physics, metaphysics and moral philosophy. He finds his argument mainly on passages in the *Communio Naturalium*, which indeed prove distinctly that it was sent to Clement, and cannot, therefore, form part of the *Compendium*, as Brewer seems to think. It must be confessed, however, that nothing can well be more confusing than the references in Bacon's works, and it seems well-nigh hopeless to attempt a complete arrangement of them until the texts have been collated and carefully printed.

All these large works Bacon appears to have looked on as preliminaries, introductions, leading to a great work which should embrace the principles of all the sciences. This great work, which is perhaps the frequently-referred-to *Liber Sex Scientiarum*, he began, and a few fragments still indicate its outline. First appears to have come the treatise now called *Compendium Studii Philosophiæ* (Brewer pp. 303-519), containing an account of the causes of error, and then entering at length upon grammar. After that, apparently, logic was to be treated; then, possibly, mathematics and physics; then speculative alchemy and experimental science. It is, however, very difficult, in the present state of our knowledge of the MSS., to hazard even conjectures as to the contents and nature of this last and most comprehensive work.

Bacon's fame in popular estimation has always rested on his mechanical discoveries. Careful research has shown that very little can with accuracy be ascribed to him. He certainly describes a method of constructing a telescope, but not so as to lead one to conclude that he was in possession of that instrument. Burning-glasses were in common use, and spectacles it does not appear he made, although he was probably acquainted with the principle of their construction. His wonderful predictions (in the *De Secretis*) must be taken *cum grano salis*; he believed in astrology, in the doctrine of signatures, and in the philosopher's stone, and *knew* that the circle had been squared. For his work in connexion with gunpowder, the invention of which has been claimed for him on the ground of a passage in his *De mirabili potestate artis et nature*, see GUNPOWDER.

Summary.—The 13th century, an age peculiarly rich in great men, produced few, if any, who can take higher rank than Roger Bacon. He is in every way worthy to be placed beside Albertus Magnus, Bonaventura, and Thomas Aquinas. These had an infinitely wider renown in their day, but modern criticism has restored the balance in his favour, and is even in danger of erring in the opposite direction. Bacon, it is now said, was not appreciated by his age because he was in advance of it; he is no schoolman, but a modern thinker, whose conceptions of science are more just and clear than are even those of his more celebrated namesake.¹ In this view there is certainly some truth, but it is much exaggerated. As a general rule, no man can be completely disverred from his national antecedents and

¹ See Dühring, *Kritische Ges. d. Phil.* 192, 249-251.

surroundings, and Bacon is not an exception. Those who take up such an extreme position regarding his merits have known too little of the state of contemporary science, and have limited their comparison to the works of the scholastic theologians. We never find in Bacon himself any consciousness of originality; he is rather a keen and systematic thinker, working in a well-beaten track, from which his contemporaries were being drawn by theology and metaphysics.

BIBLIOGRAPHY.—The best work on Roger Bacon is perhaps that of E. Charles, *Roger Bacon, sa vie, ses ouvrages, ses doctrines d'après des textes inédits* (1861). Against the somewhat enthusiastic estimate of a modern interpretation given in this work, are Schneider in his *Roger Bacon, Eine Monographie* (Augsburg, 1873); K. Werner, *Die Psychol. . . des Roger Bacon und Die Kosmologie . . . des Roger Bacon* (Vienna, 1879); S. A. Hirsch, *Early English Hebraists* (1899); *Book of Essays* (London, 1905), deals with Bacon as a Hebraist. The new matter contained in the publications of Charles and Brewer was summarized by H. Siebert, *Roger Bacon: Inaugural Dissertation* (Marburg, 1861). Cf. also J. K. Ingram, *On the Opus Majus of Bacon* (Dublin, 1858); Cousin, "Fragments phil. du moyen âge" (reprinted from *Journal des Savans*, 1848); E. Saisset, "Précursus et disciples de Descartes," pp. 1-58 (reprinted from *Revue de deux mondes*, 1861); K. Prantl, *Gesch. der Logik*, iii. 120-129 (a severe criticism of Bacon's logical doctrines); Held, *Roger Bacon's philosophische Philosophie* (Jena, 1881); K. Böhler, *Das Verhältnis d. Philos. zur Theol. bei Roger Bacon* (Neustadt, 1893); articles in *Westminster Review*, hxxi. 1 and 512; A. Pacrot, *Roger Bacon et ses contemporains* (1894); E. Flugel, *Roger Bacon's Stellung in d. Gesch. d. Philos.* (1902); S. Vogl, *Die Physik Roger Bacon's* (1906). For the popular legend see *Famous Historic of Fryer Bacon* (London, 1615); reproduced in Thoms, *Early Prose Romances*, iii.; R. Greene's *Friar Bacon and Friar Bungay* (1878 or 1888), and in publication of the Percy Society, vol. xv. 1844, *A Piece of Friar Bacon's Brazen Heade's Prophecie* (1604). For Bacon as a classical scholar see J. E. Sandys, *Hist. of Class. Schol.* (2nd ed., 1906), cxxxi. (R. Ad.; X.)

BACON (through the O. Fr. *bacon*, Low Lat. *baco*, from a Teutonic word cognate with "back," e.g. O. H. Ger. *pacho*, M. H. Ger. *backe*, buttock, flitch of bacon), the flesh of the sides and back of the pig, cured by salting, drying, pickling and smoking.

BACONTHORPE (BACON, BACO, BACCONIUS), **JOHN** (d. 1346), known as "the Resolute Doctor," a learned Carmelite monk, was born at Baconthorpe in Norfolk. He seems to have been the grandnephew of Roger Bacon (Brit. Mus. Adm. MS. 19. 116). Brought up in the Carmelite monastery of Blakeney, near Walsingham, he studied at Oxford and Paris, where he was known as "Princes" of the Averroists. Renan, however, says that he merely tried to justify Averroism against the charge of heterodoxy. In 1329 he was chosen twelfth provincial of the English Carmelites. He appears to have anticipated Wycliffe in advocating the subordination of the clergy to the king. In 1333 he was sent for to Rome, where, we are told, he first maintained the pope's authority in cases of divorce; but this opinion he retracted. He died in London in 1346. His chief work, *Doctoris resoluti Joannis Baconis Anglici Carmelita radiantissimi opus super quatuor sententiarum libris* (published 1510), has passed through several editions. Nearly three centuries later, it was still studied at Padua, the last home of Averroism, and Lucilio Vanini speaks of him with great veneration.

See Brucker, *Hist. Crit.* iii. 865; Strükel, *Phil. d. Mittel.* ii. 1044-1045; Haureau, *Phil. Scol.* ii. 476; K. Prantl, *Ges. d. Logik*, iii. 318. For information as to his life, not found otherwise and of doubtful accuracy, see J. B. de Lezana's *Annales Sacri*, iv.

BACSANYI, JANOS (1763-1845), Hungarian poet, was born at Tapolca on the 11th of May 1763. In 1785 he published his first work, a patriotic poem, *The Valour of the Magyars*. In the same year he obtained a situation as clerk in the treasury at Kaschau, and there, in conjunction with other two Hungarian patriots, edited the *Magyar Museum*, which was suppressed by the government in 1792. In the following year he was deprived of his clerkship; and in 1794, having taken part in the conspiracy of Bishop Martinovich, he was thrown into the state prison of the Spielberg, near Brünn, where he remained for two years. After his release he took a considerable share in the *Magyar Minerva*, a literary review, and then proceeded to Vienna, where he obtained a post in the bank, and married. In 1809 he translated Napoleon's proclamation to the Magyars, and, in consequence of this anti-Austrian act, had to take refuge in Paris.

After the fall of Napoleon he was given up to the Austrians, who allowed him to reside at Linz, on condition of never leaving that town. He published a collection of poems at Pest, 1827 (2nd ed. Buda, 1835), and also edited the poetical works of Anyos and Faludi. He died at Linz on the 12th of May 1845.

BACTERIOLOGY. The minute organisms which are commonly called "bacteria"¹ are also known popularly under other designations, e.g. "microbes," "micro-organisms," "microphytes," "bacilli," "micrococci." All these terms, including the usual one of bacteria, are unsatisfactory; for "bacterium," "bacillus" and "micrococcus" have narrow technical meanings, and the other terms are too vague to be scientific. The most satisfactory designation is that proposed by Nägeli in 1857, namely "schizomycetes," and it is by this term that they are usually known among botanists; the less exact term, however, is also used and is retained in this article since the science is commonly known as "bacteriology." The first part of this article deals with the general scientific aspects of the subject, while a second part is concerned with the medical aspects.

I. THE STUDY OF BACTERIA

The general advances which have been made of late years in the study of bacteria are clearly brought to mind when we reflect that in the middle of the 19th century these organisms were only known to a few experts and in a few forms as curiosities of the microscope, chiefly interesting for their minuteness and motility. They were then known under the name of "animalcules," and were confounded with all kinds of other small organisms. At that time nothing was known of their life-history, and no one dreamed of their being of importance to man and other living beings, or of their capacity to produce the profound chemical changes with which we are now so familiar. At the present day, however, not only have hundreds of forms or species been described, but our knowledge of their biology has so extended that we have entire laboratories equipped for their study, and large libraries devoted solely to this subject. Furthermore, this branch of science has become so complex that the bacteriological departments of medicine, of agriculture, of sewage, &c., have become more or less separate studies.

The schizomycetes or bacteria are minute vegetable organisms devoid of chlorophyll and multiplying by repeated bipartitions. They consist of single cells, which may be spherical, oblong or cylindrical in shape, or of filamentous or other aggregates of cells. They are characterized by the absence of ordinary sexual reproduction and by the absence of an ordinary nucleus. In the two last-mentioned characters and in their manner of division the bacteria resemble Schizophyceae (Cyanophyceae or blue-green algae), and the two groups of Schizophyceae and Schizomycetes are usually united in the class Schizophyta, to indicate the generally received view that most of the typical bacteria have been derived from the Cyanophyceae. Some forms, however, such as "Sarcina," have their algal analogues in Palmellaceae among the green algae, while Thaxter's group of Myxobacteriaceae suggests a relationship with the Myxomycetes. The existence of ciliated micrococci together with the formation of endospores—structures not known in the Cyanophyceae—reminds us of the flagellate Protozoa, e.g. *Monas*, *Chromulina*. Resemblances also exist between the endospores and the spore-formations in the Saccharomycetes, and if *Bacillus infatus*, *B. ventriculus*, &c., really form more than one spore in the cell, these analogies are strengthened. Schizomycetes such as *Clostridium*, *Plectridium*, &c., where the sporiferous cells enlarge, bear out the same argument, and we must not forget that there are extremely minute "yeasts," easily mistaken for Micrococci, and that yeasts occasionally form only one spore in the cell.

Nor must we overlook the possibility that the endospore-formation in non-motile bacteria more than merely resembles the development of azygospores in the Conjugatae, and some Ulothricaceae, if reduced in size, would resemble them. Meyer regards them as chlamydo-spores, and Klebs as "carpospores" or possibly chlamydo-spores similar to the endospores of yeast.

¹ Gr. *βακτηριον*, Lat. *bacillus*, little rod or stick.

The former also looks on the ordinary disjointing bacterial cell as an oidium, and it must be admitted that since Brefeld's discovery of the frequency of minute oidia and chlamydozooids among the fungi, the probability that some so-called bacteria—and this applies especially to the branching forms accepted by some bacteriologists—are merely reduced fungi is increased. Even the curious one-sided growth of certain species which form sheaths and stalks—e.g. *Bacterium vermiforme*, *B. pediculatum*—can be matched by Algae such as *Oocardium*, *Hydrurus*, and some Diatoms. It is clear then that the bacteria are very possibly a heterogeneous group, and in the present state of our knowledge their phylogeny must be considered as very doubtful.

Nearly all bacteria, owing to the absence of chlorophyll, are saprophytic or parasitic forms. Most of them are colourless, but

liquid (blood, urine, milk, beer, &c.) containing organic matter, or any solid food-stuff (meat preserves, vegetables, &c.), allowed to stand exposed to the air soon swarms with bacteria, if moisture is present and the temperature not abnormal. Though they occur all the world over in the air and on the surface of exposed bodies, it is not to be supposed that they are by any means equally distributed, and it is questionable whether the bacteria suspended in the air ever exist in such enormous quantities as was once believed. The evidence to hand shows that on heights and in open country, especially in the north, there may be few or even no Schizomycetes detected in the air, and even in towns their distribution varies greatly; sometimes they appear to exist in minute clouds, as it were, with interspaces devoid of any, but in laboratories and closed spaces where their cultivation has been promoted the air may be considerably laden with them. Of course the distribution of bodies so light and small is easily influenced by movements, rain, wind, changes of temperature, &c. As parasites, certain Schizomycetes inhabit and prey upon the organs of man and animals in varying degrees, and the conditions for their growth and distribution are then very complex. Plants appear to be less subject to their attacks—possibly, as has been suggested, because the acid fluids of the higher vegetable organisms are less suited to the development of Schizomycetes; nevertheless some are known to be parasitic on plants. Schizomycetes exist in every part of the alimentary canal of animals, except, perhaps, where acid secretions prevail; these are by no means necessarily harmful, though, by destroying the teeth for instance, certain forms may incidentally be the forerunners of damage which they do not directly cause.

Little was known about these extremely minute organisms before 1860. A. van Leeuwenhoek figured bacteria as far back as the 17th century, and O. F. Müller knew several important forms in 1773, while Ehrenberg in 1830 had advanced to the commencement of a scientific separation and grouping of them, and in 1838 had proposed at least sixteen species, distributing them into four genera. Our modern more accurate though still fragmentary knowledge of the forms of Schizomycetes, however, dates from F. J. Cohn's brilliant researches, the chief results of which were published at various periods between 1853 and 1872; Cohn's classification of the bacteria, published in 1872 and extended in 1875, has in fact dominated the study of these organisms almost ever since. He proceeded in the main on the assumption that the forms of bacteria as met with and described by him are practically constant, at any rate within limits which are not wide: observing that a minute spherical micrococcus or a rod-like bacillus regularly produced similar micrococci and bacilli respectively, he based his classification on what may be considered the constancy of forms which he called species and genera. As to the constancy of form, however, Cohn maintained certain reservations which have been ignored by some of his followers. The fact that Schizomycetes produce spores appears to have been discovered by Cohn in 1857, though it was expressed dubiously in 1872; these spores had no doubt been observed previously. In 1876, however, Cohn had seen the spores germinate, and Koch, Brefeld, Pratzmowski, van Tieghem, de Bary and others confirmed the discovery in various species.

The supposed constancy of forms in Cohn's species and genera received a shock when Lankester in 1873 pointed out that his *Bacterium rubescens* (since named *Beggiatoa roseo-persicina*, Zopf) passes through conditions which would have been described by most observers influenced by the current doctrine as so many separate "species" or even "genera,"—that in fact forms known as *Bacterium*, *Micrococcus*, *Bacillus*, *Leptothrix*, &c., occur as phases in one life-history. Lister put forth similar ideas about the same time; and Billroth came forward in 1874 with the extravagant view that the various bacteria are only different states of one and the same organism which he called *Cocco-bacteria septica*. From that time the question of the pleomorphism (mutability of shape) of the bacteria has been hotly discussed: but it is now generally agreed that, while a



FIG. 1.—Preparations showing various forms of bacteria and the various types of cilia and their arrangement.

- | | |
|---|--|
| A. <i>Bacillus subtilis</i> , Cohn, and <i>Spirillum undula</i> , Ehrenb. | F. <i>Bacillus typhi</i> , Gaffky. |
| B. <i>Planococcus citreus</i> (Menge), Migula. | G. <i>B. vulgaris</i> (Hauser), Migula. |
| C. <i>Pseudomonas pyocyanea</i> (Gesd.) | H. <i>Microspira Comma</i> (Koch), Schroeter. |
| D. <i>P. macrosetis</i> , Migula. | J. <i>K. Spirillum rubrum</i> , Es-marsch. |
| E. <i>P. syncyanea</i> (Ehrenb.), Migula. | L, M. <i>S. undula</i> (Müller), Ehrenb. (All after Migula.) |

a few secrete colouring matters other than chlorophyll. In size their cells are commonly about 0.001 mm. (1 micromillimetre or 1 μ) in diameter, and from two to five times that length, but smaller ones and a few larger ones are known. Some of the shapes assumed by the cells are shown in fig. 1.

That bacteria have existed from very early periods is clear from their presence in fossils; and although we cannot accept all the conclusions drawn from the imperfect records of the rocks, and may dismiss as absurd the statements that geologically immature forms have been found still living, the researches of Renault and van Tieghem have shown pretty clearly that large numbers of bacteria existed in Carboniferous and Devonian times, and probably earlier.

Schizomycetes are ubiquitous as saprophytes in still ponds and ditches, in running streams and rivers, and in the sea, and especially in drains, bogs, refuse heaps, and in the soil, and wherever organic infusions are allowed to stand for a short time. Any

*Distrib-
tion in
time.*

certain number of forms may show different types of cell during the various phases of the life-history,¹ yet the majority of forms are uniform, showing one type of cell throughout their life-history. The question of species in the bacteria is essentially the same as in other groups of plants; before a form can be placed in a satisfactory classificatory position its whole life-history must be studied, so that all the phases may be known. In the meantime, while various observers were building up our knowledge of the morphology of bacteria, others were laying the foundation of what is known of the relations of these organisms to fermentation and disease—that ancient will-o'-the-wisp "spontaneous generation" being revived by the way. When Pasteur in 1857 showed that the lactic fermentation depends on the presence of an organism, it was already known from the researches of Schwann (1837) and Helmholtz (1843) that fermentation and putrefaction are intimately connected with the presence of organisms derived from the air, and that the preservation of putrescible substances depends on this principle. In 1862 Pasteur placed it beyond reasonable doubt that the ammoniacal fermentation of urea is due to the action of a minute Schizomycete; in 1864 this was confirmed by van Tieghem, and in 1874 by Cohn, who named the organism *Micrococcus ureae*. Pasteur and Cohn also pointed out that putrefaction is but a special case of fermentation, and before 1872 the doctrines of Pasteur were established with respect to Schizomycetes. Meanwhile two branches of inquiry had arisen, so to speak, from the above. In the first place, the ancient question of "spontaneous generation" received fresh impetus from the difficulty of keeping such minute organisms as bacteria from reaching and developing in organic infusions; and, secondly, the long-suspected analogies between the phenomena of fermentation and those of certain diseases again made themselves felt, as both became better understood. Needham in 1745 had declared that heated infusions of organic matter were not deprived of living beings; Spallanzani (1777) had replied that more careful heating and other precautions prevent the appearance of organisms in the fluid. Various experiments by Schwann, Helmholtz, Schultz, Schroeder, Dusch and others led to the refutation, step by step, of the belief that the more minute organisms, and particularly bacteria, arose *de novo* in the special cases quoted. Nevertheless, instances were adduced where the most careful heating of yolk of egg, milk, hay-infusions, &c., had failed,—the boiled infusions, &c., turning putrid and swarming with bacteria after a few hours.

In 1862 Pasteur repeated and extended such experiments, and paved the way for a complete explanation of the anomalies; Cohn in 1872 published confirmatory results; and it became clear that no putrefaction can take place without bacteria or some other living organism. In the hands of Brefeld, Burdon-Sanderson, de Bary, Tyndall, Roberts, Lister and others, the various links in the chain of evidence grew stronger and stronger, and every case adduced as one of "spontaneous generation" fell to the ground when examined. No case of so-called "spontaneous generation" has withstood rigid investigation; but the discussion contributed to more exact ideas as to the ubiquity, minuteness, and high powers of resistance to physical agents of the spores of Schizomycetes, and led to more exact ideas of antiseptic treatments. Methods were also improved, and the application of some of them to surgery at the hands of Lister, Koch and others has yielded results of the highest value.

Long before any clear ideas as to the relations of Schizomycetes to fermentation and disease were possible, various thinkers at different times had suggested that resemblances existed between the phenomena of certain diseases and those of fermentation, and the idea that a virus or contagium might be something of the nature of a minute organism capable of spreading and

reproducing itself had been entertained. Such vague notions began to take more definite shape as the ferment theory of Cagniard de la Tour (1828), Schwann (1837) and Pasteur made way, especially in the hands of the last-named savant. From about 1870 onwards the "germ theory of disease" has passed into acceptance. P. F. O. Rayer in 1850 and Davaine had observed the bacilli in the blood of animals dead of anthrax (splenic fever), and Pollender discovered them anew in 1855. In 1863, imbued with ideas derived from Pasteur's researches on fermentation, Davaine reinvestigated the matter, and put forth the opinion that the anthrax bacilli caused the splenic fever; this was proved to result from inoculation. Koch in 1876 published his observations on Davaine's bacilli, placed beyond doubt their causal relation to splenic fever, discovered the spores and the saprophytic phase in the life-history of the organism, and cleared up important points in the whole question (figs. 7 and 9). In 1870 Pasteur had proved that a disease of silkworms was due to an organism of the nature of a bacterium; and in 1871 Oertel showed that a *Micrococcus* already known to exist in diphtheria is intimately concerned in producing that disease. In 1872, therefore, Cohn was already justified in grouping together a number of "pathogenous" Schizomycetes. Thus arose the foundations of the modern "germ theory of disease;" and, in the midst of the wildest conjectures and the worst of logic, a nucleus of facts was won, which has since grown, and is growing daily. Septicaemia, tuberculosis, glanders, fowl-cholera, relapsing fever, and other diseases are now brought definitely within the range of biology, and it is clear that all contagious and infectious diseases are due to the action of bacteria or, in a few cases, to fungi, or to protozoa or other animals.

Other questions of the highest importance have arisen from the foregoing. About 1880 Pasteur first showed that *Bacillus anthracis* cultivated in chicken broth, with plenty of oxygen and at a temperature of 42-43° C., lost its virulence after a few "generations," and ceased to kill even the mouse; Toussaint and Chauveau confirmed, and others have extended the observations. More remarkable still, animals inoculated with such "attenuated" bacilli proved to be curiously resistant to the deadly effects of subsequent inoculations of the non-attenuated form. In other words, animals vaccinated with the cultivated bacillus showed immunity from disease when re inoculated with the deadly wild form. The questions as to the causes and nature of the changes in the bacillus and in the host, as to the extent of immunity enjoyed by the latter, &c., are of the greatest interest and importance. These matters, however, and others such as phagocytosis (first described by Metchnikoff in 1884), and the epoch-making discovery of the opsonins of the blood by Wright, do not here concern us (see II. below).

MORPHOLOGY.—*Sizes, forms, structure, &c.*—The Schizomycetes consist of single cells, or of filamentous or other groups of cells, according as the divisions are completed at once or not. While some unicellular forms are less than *Form and structure.* 1 μ (100 mm.) in diameter, others have cells measuring 4 μ or 5 μ or even 7 μ or 8 μ in thickness, while the length may vary from that of the diameter to many times that measurement. In the filamentous forms the individual cells are often difficult to observe until reagents are applied (e.g. fig. 14), and the length of the rows of cylindrical cells may be many hundred times greater than the breadth. Similarly, the diameters of flat or spheroidal colonies may vary from a few times to many hundred times that of the individual cells, the divisions of which have produced the colony. The shape of the individual *Cell-wall.* cell (fig. 1) varies from that of a minute sphere to that of a straight, curved, or twisted filament or cylinder, which is not necessarily of the same diameter throughout, and may have flattened, rounded, or even pointed ends. The rule is that the cells divide in one direction only—i.e. transverse to the long axis—and therefore produce aggregates of long cylindrical shape; but in rarer cases iso-diametric cells divide in two or three directions, producing flat, or spheroidal, or irregular colonies, the size of which is practically unlimited. The bacterial

¹ *Cladothrix dichotoma*, for example, which is ordinarily a branched, filamentous, sheathed form, at certain seasons breaks up into a number of separate cells which develop a tuft of cilia and escape from the sheath. Such a behaviour is very similar to the production of zoospores which is so common in many filamentous algae.

cell is always clothed by a definite cell-membrane, as was shown by the plasmolysing experiments of Fischer and others. Unlike **Cell-wall.** the cell-wall of the higher plants, it gives usually no reactions of cellulose, nor is chitin present as in the fungi, but it consists of a proteid substance and is apparently a modification of the general protoplasm. In some cases, however, as in *B. tuberculosis*, analysis of the cell shows a large amount of cellulose. The cell-walls in some forms swell up into a gelatinous mass so that the cell appears to be surrounded in the unstrained condition by a clear, transparent space. When the swollen wall is dense and regular in appearance the term "capsule" is applied to the sheath as in *Leuconostoc*. Secreted pigments (red, yellow, green and blue) are sometimes deposited in the wall, and some of the iron-bacteria have deposits of oxide of iron in the membranes.

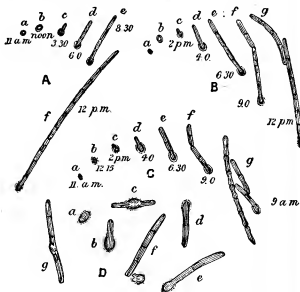

FIG. 2.—The various phases of germination of spores of *Bacillus romovus* (Fraenkel), as actually observed in hanging drops under very high powers.

A. The spore shown at 11 A.M., as shown at *a*, had swollen (*b*) perceptibly by noon, and had germinated by 3.30 P.M., as shown at *c*; in *d* at 6 P.M., and *e* at 8.30 P.M.; the resulting filament is segmenting into bacilli as it elongates, and at midnight (*f*) consisted of twelve such segments.

B. C. Similar series of phases in the order of the small letters in each case, and with the times of observation attached. At *f* and *g* occurs the breaking up of the filament into rodlets.

D. Germinating spores in various stages, more highly magnified, and showing the different ways of escape of the filament from the spore-membrane. (H. M. W.)

The substance of the bacterial cell when suitably prepared and stained shows in the larger forms a mass of homogeneous protoplasm containing irregular spaces, the vacuoles, which enclose a watery fluid. Scattered in the protoplasm are usually one or more deeply-staining granules. The protoplasm itself may be tinged with colouring matter, bright red, yellow, &c., and may occasionally contain substances other than the deeply-staining granules. The occurrence of a starch-like substance which stains deep blue with iodine has been clearly shown in some forms even where the bacterium is growing on a medium containing no starch, as shown by Ward and others. In other forms a substance (probably glycogen or amylo-dextrin) which turns brown with iodine has been observed. Oil and fat drops have also been shown to occur, and in the sulphur-bacteria numerous fine granules of sulphur.

The question of the existence of a nucleus in the bacteria is one that has led to much discussion and is a problem of some difficulty. In the majority of forms it has not hitherto been possible to demonstrate a nucleus of the type which is so characteristic of the higher plants. Attention has

accordingly been directed to the deeply-staining granules mentioned above, and the term chromatin-granules has been applied to them, and they have been considered to represent a rudimentary nucleus. That these granules consist of a material similar to the chromatin of the nucleus of higher forms is very doubtful, and the comparison with the nucleus of more highly organized cells rests on a very slender basis. The most recent works (Vejdovsky, Mcncl), however, appear to show that nuclei of a structure and mode of division almost typical are to be found in some of the largest bacteria. It is possible that a similar structure has been overlooked or is invisible in other forms owing to their small size, and that there may be another type of nucleus—the diffuse nucleus—such as Schaudinn believed to be the case in *B. butschlii*. Many bacteria when suspended in a fluid exhibit a power of independent movement which is, of course, quite distinct from the Brownian movement—a non-vital phenomenon common to all finely-divided particles suspended in a fluid. Independent movement is effected by special motile organs, the cilia or flagella. These structures are invisible, with ordinary illumination in living cells or unstained preparations, and can only

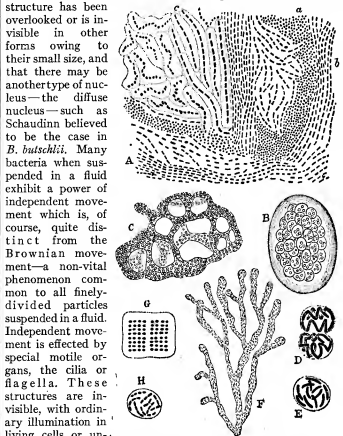

FIG. 3.—Types of Zoogloea. (After Zopf.)

A. Mixed zoogloea found as a pellicle on the surface of vegetable infusions, &c.; it consists of various forms, and contains cocci (*a*) and rodlets, in series (*b* and *c*), &c.

B. Egg-shaped mass of zoogloea of *Beggiatoa roseo-persicina* (*Bacterium rubescens* of Lankester); the gelatinous swollen walls of the large crowded cocci are fused into a common gelatinous envelope.

C. Reticulate zoogloea of the same.

D. E. H. Colonies of *Myconostoc* enveloped in diffused matrix.

F. Branched fruticose zoogloea of *Cladothrix* (slightly magnified).

G. Zoogloea of *Bacterium merismopedioides*, Zopf, containing cocci arranged in tablets.

These cilia appear to be attached to the cell-wall, being unaffected by plasmolysis, but Fischer states that they really are derived from the central protoplasm and pass through minute pores in the wall. The cilia may be present during a short period only in the life of a Schizomycete, and their number may vary according to the medium on which the organism is growing. Nevertheless, there is more or less constancy in the type of distribution, &c., of the cilia for each species when growing at its best. The chief results may be summed up as follows: some species, e.g. *B. anthracis*, have no cilia; others have only one flagellum at one pole (*Monotrichous*), e.g. *Bacillus pyocyaneus* (fig. 1, C, D), or one at each pole; others again have a tuft of several cilia

at one pole (*Lophotrichous*), e.g. *B. syncyanus* (fig. 1, E), or at each pole (*Amphitrichous*) (fig. 1, J, K, L); and, finally, many actively motile forms have the cilia springing all round (*Peritrichous*), e.g. *B. vulgaris* (fig. 1, G). It is found, however, that strict reliance cannot be placed on the distinction between the *Monotrichous*, *Lophotrichous* and *Amphitrichous* conditions, since one and the same species may have one, two or more cilia at one or both poles; nevertheless some stress may usually be laid on the existence of one or two as opposed to several—e.g. five or six or more—at one or each pole.

In *Beggiata*, a filamentous form, peculiar, slow, oscillatory movements are to be observed, reminding us of the movements of *Oscillatoria* among the *Cyanophyceae*. In these cases no cilia have been observed, and there is a firm cell-wall, so the movement remains quite unexplained.

Vegetative state.

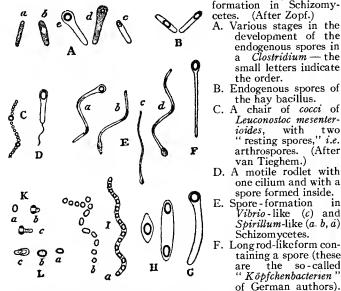

G. *Vibrio* form with spore. (After Prazmowski.)
 H. *Clostridium*—one cell contains two spores. (After Prazmowski.)
 I. *Spirillum* containing many spores (a), which are liberated at b by the breaking up of the parent cells.
 K. Germination of the spore of the hay bacillus (*B. subtilis*)—the axis of growth of the germinal rodlet is at right angles to the long axis of the spore.
 L. Germination of spore of *Clostridium butyricum*—the axis of growth coincides with the long axis of the spore.

While many forms are fixed to the substratum, others are free, being in this condition either motile or immotile. The chief of these forms are described below.

Cocci: spherical or spheroidal cells, which, according to their relative (not very well defined) sizes are spoken of as *Micrococci*, *Macrococci*, and perhaps *Monas* forms.

Rods or rodlets: slightly or more considerably elongated cells which are cylindrical, biscuit-shaped or somewhat fusiform. The cylindrical forms are short, i.e. only three or four times as long as broad (*Bacterium*), or longer (*Bacillus*); the biscuit-shaped ones are *Bacteria* in the early stages of division. *Clostridia*, &c., are spindle-shaped.

Filaments really consist of elongated cylindrical cells which remain united end to end after division, and they may break up later into elements such as those described above. Such filaments are not always of the same diameter throughout, and their segmentation varies considerably. They may be free or attached at one (the 'basal') end. A distinction is made between *simple filaments* (e.g. *Leptothrix*) and such as exhibit a false branching (e.g. *Cladotrix*).

Curved and spiral forms. Any of the elongated forms described above may be curved or sinuous or twisted into a corkscrew-like spiral instead of straight. If the sinuosity is slight we have the *Vibrio* form; if pronounced, and the spiral winding well marked, the forms are known as *Spirillum*, *Spirochaete*, &c. These and similar terms have been applied partly to individual cells, but more often to filaments consisting of several cells; and much confusion has arisen from the difficulty of defining the terms themselves.

In addition to the above, however, certain Schizomycetes present

aggregates in the form of plates, or solid or hollow and irregular branched colonies. This may be due to the successive divisions occurring in two or three planes instead of only across the long axis (*Sarcina*), or to displacements of the cells after division.

Growth and Division.—Whatever the shape and size of the individual cell, cell-filament or cell-colony, the immediate visible results of active nutrition are elongation of the cell and its division into two equal halves, the

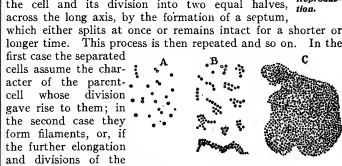

Reproduction. across the long axis, by the formation of a septum, which either splits at once or remains intact for a shorter or longer time. This process is then repeated and so on. In the first case the separated cells assume the character of the parent-cell whose division gave rise to them; in the second case they form filaments, or, if the further elongation and divisions of the cells proceed in different directions, plates or spheroidal or other shaped colonies. It not unfrequently happens, however, that

groups of cells break away from their former connexion as longer or shorter straight or curved filaments, or as solid masses. In some filamentous forms this 'fragmentation' into multicellular pieces of equal length or nearly so is a normal phenomenon, each partial filament repeating the growth, division and fragmentation as before (cf. figs. 2 and 6). By rapid division hundreds of thousands of cells may be produced in a few hours; and, according to the species and the conditions (the medium, temperature, &c.), enormous collections of isolated cells may cloud the fluid in which they are cultivated, or form deposits below or films on its surface; valuable characters are sometimes obtained from these appearances. When these dense 'swarms' of vegetative cells become fixed in a matrix of their own swollen contiguous cell-walls, they pass over into a sort of resting state as a so-called zoogloea (fig. 3).

One of the most remarkable phenomena in the life-history of the Schizomycetes is the formation of this zoogloea stage, which corresponds to the 'palmella' condition of the lower *Algae*. This occurs as a membrane on the surface of the medium, or as irregular clumps or branched masses (sometimes several inches across) submerged in it, and consists of more or less gelatinous matrix enclosing innumerable 'cocci,' 'bacteria,' or other elements of the Schizomycete concerned. Formerly regarded as a distinct genus—the natural fate of all the various

Brefeld has observed that a bacterium may divide once every half-hour, and its progeny repeat the process in the same time. One bacterium might thus produce in twenty-four hours a number of segments amounting to many millions of millions.

Fig. 6.—*Bacillus megaterium*. (After de Bary.)

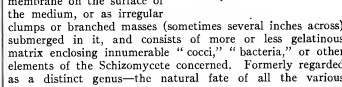

Fig. 6.—*Bacillus megaterium*. (After de Bary.)

forms—the zoogloea is now known to be a sort of resting condition of the Schizomycetes, the various elements being glued together, as it were, by their enormously swollen and diffuent cell-walls becoming contiguous. The zoogloea is formed by active division of single or of several mother-cells, and the progeny appear to go on secreting the cell-wall substance, which then absorbs many times its volume of water, and remains as a consistent matrix, in which the cells come to rest. The matrix—i.e. the swollen cell-walls—in some cases consists mainly of cellulose, in others chiefly of a proteid substance; the matrix in some cases is horny and resistant, in others more like a thick solution of gum. It is intelligible from the mode of formation that foreign bodies may become entangled in the gelatinous matrix, and compound zoogloea may arise by the apposition of several distinct forms, a common event in macerating troughs (fig. 3, A). Characteristic forms may be assumed by the young zoogloea of different species,—spherical, ovoid, reticular, filamentous, fruticose, lamellar, &c.—but these vary considerably as the mass increases or comes in contact with others. Older

active along the whole length; (2) there are optimum, minimum and maximum temperatures, other conditions remaining constant, at which growth begins, runs at its best and is soon exhausted, respectively; (3) that the most rapid cell-division and maximum growth do not necessarily accord with the best conditions for the life of the organism; and (4) that any sudden alteration of temperature brings about a check, though a slow rise may accelerate growth (fig. 8). It was also shown that exposure to light, dilution or exhaustion of the food-media, the presence of traces of poisons or metabolic products check growth or even bring it to a standstill; and the death or injury of any single cell in the filamentous series shows its effect on the curve by lengthening the doubling period, because its potential progeny have been put out of play. Hardy has shown that such a destruction of part of the filament may be effected by the attacks of another organism.

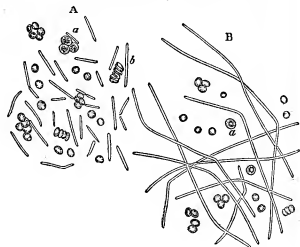

FIG. 7.—*Bacillus anthracis*. (After Koch.)

A. Bacilli mingled with blood-corpuscles from the blood of a guinea-pig; some of the bacilli dividing.

B. The rodlets after three hours' culture in a drop of aqueous humour. They grow out into long leptothrix-like filaments, which become septate later, and spores are developed in the segments.

zoogloea may precipitate oxide of iron in the matrix, if that metal exists in small quantities in the medium. Under favourable conditions the elements in the zoogloea again become active, and move out of the matrix, distribute themselves in the surrounding medium, to grow and multiply as before. If the zoogloea is formed on a solid substratum it may become firm and horny; immersion in water softens it as described above.

The growth of an ordinary bacterium consists in uniform elongation of the rodlet until its length is doubled, followed by division by a median septum, then by the simultaneous doubling in length of each daughter cell, again followed by the median division, and so on (figs. 13, 14).

If the cells remain connected the resulting filament repeats these processes of elongation and subsequent division uniformly so long as the conditions are maintained, and very accurate measurements have been obtained on such a form, e.g. *B. ramosus*. If a rodlet in a hanging drop of nutrient gelatine is fixed under the microscope and kept at constant temperature, a curve of growth can be obtained recording the behaviour during many hours or days. The measured lengths are marked off on ordinates erected on an abscissa, along which the times are noted. The curve obtained on joining the former points then brings out a number of facts, foremost among which are (1) that as long as the conditions remain constant the doubling periods—i.e. the times taken by any portion of the filament to double its length—are constant, because each cell is equally

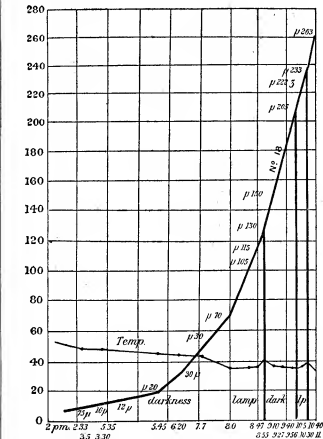

FIG. 8.—Curve of growth of a filament of *Bacillus ramosus* (Fraenkel), constructed from data such as in fig. 4. The abscissae represent intervals of time, the ordinates the measured lengths of the growing filament. Thus, at 2.33 P.M. the length of the filament was 6 μ; at 5.45, 20 μ; at 8 P.M., 70 μ and so on. Such curves show differences of steepness according to the temperature (see temp. curve), and to alterations of light (lamp) and darkness. (H. M. W.)

A very characteristic method of reproduction is that of spore-formation, and these minute reproductive bodies, which represent a resting stage of the organism, are now known in many forms. Formerly two kinds of spores were described, *arthrospores* and *endospores*. An arthrospore, however, is not a true spore but merely an ordinary vegetative cell which separates and passes into a condition of rest, and such may occur in forms which form endospores, e.g. *B. subtilis*, as well as in species not known to form endospores. The true spore or endospore begins with the appearance of a minute granule in the protoplasm of a vegetative cell; this granule enlarges and in a few hours has taken to itself all the protoplasm, secreted a thin but very resistive envelope, and is a ripe ovoid spore, smaller than the mother-cell and lying loosely in it (cf. figs. 6, 9, 10, and 11). In the case of the simplest and most minute Schizomycetes

(*Micrococcus*, &c.) no definite spores have been discovered; any one of the vegetative micrococci may commence a new series of cell by growth and division. We may call these forms "asporous," at any rate provisionally.

The spore may be formed in short or long segments, the cell-wall of which may undergo change of form to accommodate itself to the contents. As a rule only one spore is formed in a cell, and the process usually takes place in a bacillar segment. In some cases the spore-forming protoplasm gives a blue reaction with iodine solutions. The spores may be developed in cells

which are actively swarming, the movements not being interfered with by the process (fig. 4, D). The so-called "Köpfchenbacterien" of older writers are simply bacterioid segments with a spore at one end, the mother cell-wall having adapted itself to the outline of the spore (fig. 4, F). The ripe spores of Schizomycetes are spherical, ovoid or long-ovoid in shape and extremely minute (e.g. those of *Bacillus subtilis* measure 0.0012 mm. long by 0.0006 mm. broad according to Zopf), highly refractive and colourless (or very dark, probably owing to the high index of refraction and minute size). The membrane may be relatively thick, and even exhibit shells or strata.

The germination of the spores has now been observed in several forms with care. The spores are capable of germination at once, or they may be kept for months and even years, and are very resistant against desiccation, heat and cold, &c. In a suitable medium and at a proper temperature the germination is completed in a few hours.

The spore swells and elongates and the contents grow forth to a cell like that which produced it, in some cases clearly breaking through the membrane, the remains of which may be seen attached to the young germinal rodlet (figs. 5, 9 and 11); in other cases the surrounding membrane of the spore swells and dissolves. The germinal cell then grows forth into the forms typical for the particular Schizomycete concerned.

The conditions for spore-formation differ. Anaerobic species usually require little oxygen, but aerobic species a free supply. Each species has an optimum temperature and many are known to require very special food-media. The systematic interference with these conditions has enabled bacteriologists to induce the development of so-called asporogenous races, in which the formation of spores is indefinitely postponed, changes in vigour, virulence and other properties being also involved, in some cases

at any rate. The addition of minute traces of acids, poisons, &c., leads to this change in some forms; high temperature has also been used successfully.

The difficult subject of the classification¹ of bacteria dates from the difficulties presented by such minute and simple organisms as the Schizomycetes are due partly to the few "characters" which they possess and partly to the dangers of error in manipulating them; it is anything but an easy matter either to trace the whole development of a single form or to recognize with certainty any one stage in the development unless the others are known. This being the case, and having regard to the minuteness and ubiquity of these organisms, we should be very careful in accepting evidence as to the continuity or otherwise of any two forms which falls short of direct and uninterrupted observation. The outcome of all these considerations is that, while recognizing that the "genera" and "species" as defined by Cohn must be recast, we are not warranted in uniting any forms the continuity of which has not been directly

from the year 1872, when Cohn published his system, which was extended in 1875; this scheme has in fact dominated the study of bacteria ever since. Zopf in 1885 proposed a scheme based on the acceptance of extreme views of pleomorphism; his system, however, was extraordinarily

Classification.

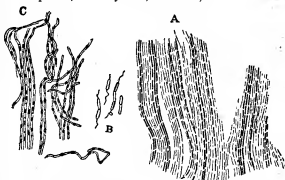

FIG. 10.—*Bacillus subtilis*. (After Strasburger.) A. Zoogloea pellicle. B. Motile rodlets. C. Development of spores.

impracticable and was recognized by him as provisional only. Systems have also been brought forward based on the formation of arthrospores and endospores, but as explained above this is eminently unsatisfactory, as arthrospores are not true spores and both kinds of reproductive bodies are found in one and the same form. Numerous attempts have been made to construct schemes of classification based on the power of growing colonies

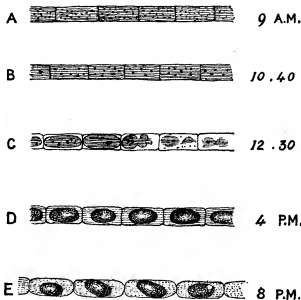

FIG. 11.—Stages in the development of spores of *Bacillus ramosus* (Fraenkel), in the order and at the times given, in a hanging drop culture, under a very high power. The process begins with the formation of brilliant granules (A, B); these increase, and the brilliant substance gradually balls together (C) and forms the spores (D), one in each segment, which soon acquire a membrane and ripen (E). (H. M. W.)

to liquefy gelatine, to secrete coloured pigments, to ferment certain media with evolution of carbon dioxide or other gases, or to induce pathological conditions in animals. None of these systems, which are chiefly due to the medical bacteriologists, has maintained its position, owing to the difficulty of applying the characters and to the fact that such properties are physiological and liable to great fluctuations in culture, because a given organism may vary greatly in such respects according to its degree of vitality at the time, its age, the mode of nutrition observed; or, at any rate, the strictest rules should be followed in accepting the evidence adduced to render the union of any forms probable.

and the influence of external factors on its growth. Even when used in conjunction with purely morphological characters, these physiological properties are too variable to aid us in the discrimination of species and genera, and are apt to break down at critical periods. Among the more characteristic of these schemes adopted at various times may be mentioned those of Miquel (1891), Eisenberg (1891), and Lehmann and Neumann (1897). Although much progress has been made in determining the value and constancy of morphological characters, we are still in need of a sufficiently comprehensive and easily applied scheme of classification, partly owing to the existence in the literature of imperfectly described forms the life-history of which is not yet known, or the microscopic characters of which have not been examined with sufficient accuracy and thoroughness. The principal attempts at morphological classifications recently brought forward are those of de Toni and Trevisan (1889), Fischer (1897) and Migula (1897). Of these systems, which alone are available in any practical scheme of classification, the two most important and most modern are those of Fischer and Migula. The extended investigations of the former on the number and distribution of cilia (see fig. 1) led him to propose a scheme of classification based on these and other morphological characters, and differing essentially from any preceding one. This scheme may be tabulated as follows:—

Fischer's scheme.

I. ORDER—**Haplobacterinae**. Vegetative body unicellular; spheroidal, cylindrical or spirally twisted; isolated or connected in filamentous or other growth series.

1. Family—COCCACEAE. Vegetative cells spheroidal.

(a) Sub-family—ALLOCOCCACEAE. Division in all or any planes, colonies indefinite in shape and size, of cells in short chains, irregular clumps, pairs or isolated:—*Micrococcus* (Cohn), cells non-motile; *Planococcus* (Migula), cells motile.

(b) Sub-family—HOMOCOCCACEAE. Division planes regular and definite:—*Sarcina* (Goods.), cells non-motile; growth and division in three successive planes at right angles, resulting in packet-like groups; *Planococcus* (Migula), as before, but motile; *Pediococcus* (Lindner), division planes at right angles in two successive planes, and cells in tablets of four or more; *Streptococcus* (Billr.), divisions in one plane only, resulting in chains of cells.

2. Family—BACILLACEAE. Vegetative cells cylindrical (rodlets), ellipsoid or ovoid, and straight. Division planes always perpendicular to the long axis.

(a) Sub-family—BACILLAE. Sporogenous rodlets cylindrical, not altered in shape:—*Bacillus* (Cohn), non-motile; *Bacitrium* (Fischer), motile, with one polar flagellum (monotrichous); *Bacitrium* (Fischer), motile, with a terminal tuft of cilia (lophotrichous); *Bacitrium* (Fischer), motile, with cilia all over the surface (peritrichous).

(b) Sub-family—CLOSTRIDIACE. Sporogenous rodlets, spindle-shaped:—*Clostridium* (Frazm.), motile (peritrichous).

(c) Sub-family—PLECTRIDIAE. Sporogenous rodlets, drumstick-shaped:—*Plectridium* (Fischer), motile (peritrichous).

3. Family—SPIRILLACEAE. Vegetative cells, cylindrical but curved more or less spirally. Divisions perpendicular to the long axis:—*Vibrio* (Müller-Löffler), comma-shaped, motile, monotrichous; *Spirillum* (Ehrenb.), more strongly curved in open spirals, (Ehrenb.), lophotrichous; *Spirochaete* (Ehrenb.), spirally coiled in numerous close turns, motile, but apparently owing to flexible movements, as no cilia are found.

II. ORDER—**Trichobacterinae**. Vegetative body of branched or unbranched cell-filaments, the segments of which separate as swarm-cells (*Gonidia*).

1. Family—TRICHOBACTERIAE. Characters those of the Order.

(a) Filaments rigid, non-motile, sheathed:—*Crenothrix* (Cohn), filaments unbranched and devoid of sulphur particles; *Thiothrix* (Winogr.), as before, but with sulphur particles; *Cladothrix* (Cohn), filaments branched in a pseudo-dichotomous manner.

(b) Filaments showing slow pendulous and creeping movements, and with no distinct sheath:—*Beggiatoa* (Trev.), with sulphur particles.

The principal objections to this system are the following:—(1) The extraordinary difficulty in obtaining satisfactory preparations showing the cilia, and the discovery that these motile organs are not formed on all substrata, or are only developed during short periods of activity while the organism is young and vigorous, render this character almost nugatory. For instance, *B. megatherium* and *B. subtilis* pass in a few hours after commencement of growth from a motile stage with peritrichous cilia, into one of filamentous growth preceded by casting of the cilia. (2) By far the majority of the described species (over 1000) fall into the three genera—*Micrococcus* (about 400), *Bacillus* (about 200) and *Bacitrium* (about 150), so that only a quarter or so of the forms are selected out by the other genera. (3) The monotrichous and lophotrichous conditions are by no means constant even in the motile stage; thus *Pseudomonas roosa* (Mig.) may have 1, 2 or 3 cilia at either end, and would be distributed by Fischer's classification between *Bacitrium* and *Bacitrium*, according to which state was observed. In Migula's scheme the attempt is made to avoid some of these difficulties, but others are introduced by his otherwise clever devices for dealing with these puzzling little organisms.

The question, What is an individual? has given rise to much difficulty, and around it many of the speculations regarding pleomorphism have centred without useful result. If a tree fall apart into its constituent cells periodically we should have the same difficulty with a larger and more complex scale. The fact that every bacterial cell in a species in most cases appears equally capable of performing all the physiological functions of the species has led most authorities, however, to regard it as the individual—a view which cannot be consistent in those cases where a simple or branched filamentous series exhibits differences between free apex and fixed base and so forth. It may be doubted whether the discussion is profitable, though it appears necessary in some cases—e.g. concerning pleomorphism—to adopt some definition of individual.

Myxobacteriaceae.—To the two divisions of bacteria, Haplobacterinae and Trichobacterinae, must now be added a third division, Myxobacterinae. One of the first members of this group, *Chondromyces crocatus*, was described as long ago as 1857 by Berkeley, but its nature was not understood and it was ascribed to the Hyphomycetes.

In 1892, however, Thaxter rediscovered it and showed its bacterial nature, founding for it and some allied forms the group Myxobacteriaceae. Another form, which he described as *Myxobacter*, was shown later to be the same as *Polyangium vitellinum* described by Link in 1795, the 'exact nature of which had hitherto been in doubt. Thaxter's observations and conclusions were called in question by some botanists, but his later observations and those of Baur have established firmly the position of the group. The peculiarity of the group lies in the fact that the bacteria form plasmodium-like aggregations and build themselves up into sporogenous structures of definite form superficially similar to the cysts of the Mycetozoa (fig. 12). Most of the forms in question are found growing on the dung of herbivorous animals, but the bacteria occur not only in the alimentary canal of the animal but also free in the air. The Myxobacterinae are most easily obtained by keeping at a temperature of 30–35° C. in the dark dung which has lain exposed to the air for at least eight days. The high temperature is favourable to the growth of the bacteria but

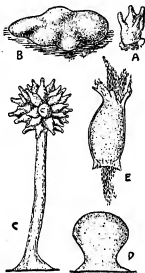

FIG. 12.

- A. *Myxococcus digelatus*, bright red fructification occurring on dung.
 B. *Polyangium primigenum*, red fructification on dog's dung.
 C. *Chondromyces apicalatus*, orange fructification on antelope's dung.
 D. Young fructification.
 E. Single cyst germinating.

(A, B, after Quehl; C, E, after Thaxter.) From Strasburger's *Lehrbuch der Botanik*, by permission of Gustav Fischer.

free in the air. The Myxobacterinae are most easily obtained by keeping at a temperature of 30–35° C. in the dark dung which has lain exposed to the air for at least eight days. The high temperature is favourable to the growth of the bacteria but

inimical to that of the fungi which are so common on this substratum.

The discoveries that some species of nitrifying bacteria and perhaps pigmented forms are capable of carbon-assimilation, that others can fix free nitrogen and that a number of decompositions hitherto unsuspected are accomplished by Schizomycetes, have put the questions of nutrition and fermentation in quite new lights. Apart from numerous fermentation processes such as rotting, the soaking of skins for tanning, the preparation of indigo and of tobacco, hay, ensilage, &c., in all of which bacterial fermentations are concerned, attention may be especially directed to the following evidence of the supreme importance of Schizomycetes in agriculture and daily life. Indeed, nothing marks the attitude of modern bacteriology more clearly than the increasing attention which is being paid to useful fermentations. The vast majority of these organisms are not pathogenic, most are harmless and

Function and life of bacteria.

forms are termed by Fischer *Metatrophic*, because they require various kinds of organic materials obtained from the dead remains of other organisms or from the surfaces of their bodies, and can utilize and decompose them in various ways (*Polytrophic*) or, if *monotrophic*, are at least unable to work them up. The true parasites—obligate parasites of de Bary—are placed by Fischer in a third biological group, *Paratrophic* bacteria, to mark the importance of their mode of life in the interior of living organisms where they live and multiply in the blood, juices or tissues.

When we reflect that some hundreds of thousands of tons of urea are daily deposited, which ordinary plants are unable to assimilate until considerable changes have been undergone, the question is of importance, What happens in the meantime? In effect the urea first becomes carbonate of ammonia by a simple hydrolysis brought about by bacteria, more and more definitely known since Pasteur, van Tieghem and Cohn first described them. Lea and Miquel further proved that the hydrolysis is due to an enzyme—urase—separable with difficulty from the bacteria concerned. Many farms in rivers, soil, manure heaps, &c., are capable of bringing about this change to ammonium carbonate, and much of the loss of volatile ammonia on farms is preventable if the facts are apprehended. The excreta of urea alone thus afford to the soil enormous stores of nitrogen combined in a form which can be rendered available by bacteria, and there are in addition the supplies brought down in rain from the atmosphere, and those due to other living debris. The researches of later years have demonstrated that a still more inexhaustible supply of nitrogen is made available by the nitrogen-fixing bacteria of the soil. There are in all cultivated soils forms of bacteria which are capable of forcing the inert free nitrogen to combine with other elements into compounds assimilable by plants. This was long asserted as probable before Winogradsky showed that the conclusions of M. P. E. Berthelot, A. Laurent and others were right, and that *Clostridium pasteurianum*, for instance, if protected from access of free oxygen by an envelope of aerobic bacteria or fungi, and provided with the carbohydrates and minerals necessary for its growth, fixes nitrogen in proportion to the amount of sugar consumed. This interesting case of symbiosis is equalled by yet another case. The work of numerous observers has shown that the free nitrogen of the atmosphere is brought into combination in the soil in the nodules filled with bacteria on the roots of Leguminosae, and since these nodules are the morphological expression of a symbiosis between the higher plant and the bacteria, there is evidently here a case similar to the last.

Nitrogen bacteria.

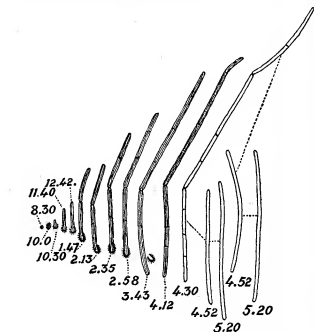

FIG. 13.—A series of phases of germination of the spore of *B. ramosus* sown at 8.30 (to the extreme left), showing how the growth can be measured. If we place the base of the filament in each case on a base line in the order of the successive times of observation recorded, and at distances apart proportional to the intervals of time filaments, the proportional length of each of which is here given for each period, a line joining the tips of the filaments gives the curve of growth. (H. M. W.)

many are indispensable aids in natural operations important to man.

Fischer has proposed that the old division into saprophytes and parasites should be replaced by one which takes into account other peculiarities in the mode of nutrition of bacteria. The nitrifying, nitrogen-fixing, sulphur- and iron-bacteria he regards as *monotrophic*, i.e. as able to carry on one particular series of fermentations or decompositions only, and since they require no organic food materials, or at least are able to work up nitrogen or carbon from inorganic sources, he regards them as primitive forms in this respect and terms them *Prototrophic*. They may be looked upon as the nearest existing representatives of the primary forms of life which first obtained the power of working up non-living into living materials, and as playing a correspondingly important rôle in the evolution of life on our globe. The vast majority of bacteria, on the other hand, which are ordinarily termed saprophytes, are *saprogenic*, i.e. bring organic material to the putrefactive state—or *saprophilous*, i.e. live best in such putrefying materials—or become *zymogenic*, i.e. their metabolic products may induce blood-poisoning or other toxic effects (facultative parasites) though they are not true parasites. These

As regards the ammonium carbonate accumulating in the soil from the conversion of urea and other sources, we know from Winogradsky's researches that it undergoes oxidation in two stages owing to the activity of the so-called "nitrifying" bacteria (an unfortunate term inasmuch as "nitrification" refers merely to a particular phase of the cycle of changes undergone by nitrogen). It had long been known that under certain conditions large quantities of nitrate (saltpetre) are formed on exposed heaps of manure, &c., and it was supposed that direct oxidation of the ammonia, facilitated by the presence of porous bodies, brought this to pass. But research showed that this process of nitrification is dependent on temperature, aeration and moisture, as is life, and that while nitre-beds can infect one another, the process is stopped by sterilization. R. Warington, J. T. Schloessing, C. A. Müntz and others had proved that nitrification was promoted by some organism, when Winogradsky hit on the happy idea of isolating the organism by using gelatinous silica, and so avoiding the difficulties which Warington had shown to exist with the organism in presence of organic nitrogen, owing to its refusal to nitrify on gelatine or other nitrogenous media. Winogradsky's investigations resulted in the discovery that two kinds of bacteria are concerned in nitrification; one of these, which he terms the *Nitroso-bacteria*, is only capable of bringing about the oxidation of the ammonia to nitrous acid, and the astonishing result was obtained that

this can be done, in the dark, by bacteria to which only pure mineral salts—e.g. carbonates, sulphates and chlorides of ammonium, sodium and magnesium—were added. In other words these bacteria can build up organic matter from purely mineral sources by assimilating carbon from carbon dioxide in the dark and by obtaining their nitrogen from ammonia. The energy liberated during the oxidation of the nitrogen is regarded as splitting the carbon dioxide molecule,—in green plants it is the energy of the solar rays which does this. Since the supply of free oxygen is dependent on the activity of green plants the process is indirectly dependent on energy derived from the sun, but it is none the less an astounding one and outside the limits of our previous generalizations. It has been suggested that urea is formed by polymerization of ammonium carbonate, and formic aldehyde is synthesized from CO_2 and OH_2 . The *Nitro-bacteria* are smaller, finer and quite different from the nitroso-bacteria, and are incapable of attacking and utilizing ammonium carbonate. When the latter have oxidized ammonia to nitrite, however, the former step in and oxidize it still further to nitric acid. It is probable that important consequences of these actions result from the presence of nitrifying bacteria in rotten stone,

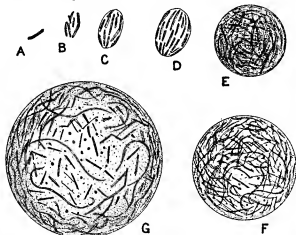

FIG. 14.—Stages in the formation of a colony of a variety of *Bacillus* (*Proteus*) *vulgaris* (Hauser), observed in a hanging drop. At 11 A.M. a rodlet appeared (A); at 4 P.M. it had grown and divided and broken up into eight rodlets (B); C shows further development at 8 P.M., D at 9.30 P.M.—all under a high power. At E, F, and G further stages are drawn, as seen under much lower power. (H. M. W.)

decaying bricks, &c., where all the conditions are realized for preparing primitive soil, the breaking up of the mineral constituents being a secondary matter. That "soil" is thus prepared on barren rocks and mountain peaks may be concluded with some certainty.

In addition to the bacterial actions which result in the oxidation of ammonia to nitrous acid, and of the latter to nitric acid, the reversal of such processes is also brought about by numerous bacteria in the soil, rivers, &c. Warington showed some time ago that many species are able to reduce nitrates to nitrites, and such reduction is now known to occur very widely in nature. The researches of Gayon and Dupetit, Giltay and Aberson and others have shown, moreover, that bacteria exist which carry such reduction still further, so that ammonia or even free nitrogen may escape. The importance of these results is evident in explaining an old puzzle in agriculture, viz. that it is a wasteful process to put nitrates and manure together on the land. Fresh manure abounds in de-nitrifying bacteria, and these organisms not only reduce the nitrates to nitrites, even setting free nitrogen and ammonia, but their effect extends to the undoing of the work of what nitrifying bacteria may be present also, with great loss. The combined nitrogen of dead organisms, broken down to ammonia by putrefactive bacteria, the ammonia of urea and the results of the fixation of free nitrogen, together with traces of nitrogen salts due to meteoric activity, are thus seen to undergo various vicissitudes in the soil, rivers and surface of

the globe generally. The ammonia may be oxidized to nitrites and nitrates, and then pass into the higher plants and be worked up into proteids, and so be handed on to animals, eventually to be broken down by bacterial action again to ammonia; or the nitrates may be degraded to nitrites and even to free nitrogen or ammonia, which escapes.

That the Leguminosae (a group of plants including peas, beans, vetches, lupins, &c.) play a special part in agriculture was known even to the ancients and was mentioned by Pliny (*Historia Naturalis*, viii.). These plants will not only grow on poor sandy soil without any addition of nitrogenous manure, but they actually enrich the soil on which they are grown. Hence leguminous plants are essential in all rotation of crops. By analysis it was shown by Schulz-Lupitz in 1881 that the way in which these plants enrich the soil is by increasing the nitrogen-content. Soil which had been cultivated for many years as pasture was shown with lupins for fifteen years in succession; an analysis then showed that the soil contained more than three times as much nitrogen as at the beginning of the experiment. The only possible source for this increase was the atmospheric nitrogen. It had been, however, an axiom with botanists that the green plants were unable to use the nitrogen of the air. The apparent contradiction was explained by the experiments of H. Hellriegel and Wilfarth in 1888. They showed that, when grown on sterilized sand with the addition of mineral salts, the Leguminosae were no more able to use the atmospheric nitrogen than other plants such as oats and barley. Both kinds of plants required the addition of nitrates to the soil. But if a little water in which arable soil had been shaken up was added to the sand, then the leguminous plants flourished in the absence of nitrates and showed an increase in nitrogenous material. They had clearly made use of the nitrogen of the air. When these plants were examined they had small swellings or nodules on their roots, while those grown in sterile sand without soil-extract had no nodules. Now these peculiar nodules are a normal characteristic of the roots of leguminous plants grown in ordinary soil. The experiments above mentioned made clear for the first time the nature and activity of these nodules. They are clearly the result of infection (if the soil extract was boiled before addition to the sand no nodules were produced), and their presence enabled the plant to absorb the free nitrogen of the air.

The work of recent investigators has made clear the whole process. In ordinary arable soil there exist motile rod-like bacteria, *Bacterium radicicola*. These enter the root-hairs of leguminous plants, and passing down the hair in the form of a long, slimy (zoogloea) thread, penetrate the tissues of the root. As a result the tissues become hypertrophied, producing the well-known nodule. In the cells of the nodule the bacteria multiply and develop, drawing material from their host. Many of the bacteria exhibit curious involution forms ("bacteroids"), which are finally broken down and their products absorbed by the plant. The nitrogen of the air is absorbed by the nodules, being built up into the bacterial cell and later handed on to the host-plant. It appears from the observations of Mazé that the bacterium can even absorb free nitrogen when grown in cultures

Bacteria and Leguminosae.

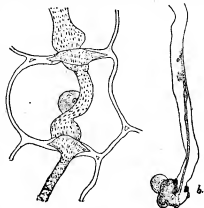

FIG. 15.—Invasion of leguminous roots by bacteria.

a, cell from the epidermis of root of Pea with "infection thread" (zoogloea) pushing its way through the cell-walls. (After Prazmowski.)
b, free end of a root-hair of Pea; at the right are particles of earth and on the left a mass of bacteria. Inside the hair the bacteria are pushing their way up in a thin stream.

(From Fischer's *Vorlesungen über Bakterien*.)

(From Fischer's *Vorlesungen über Bakterien*.) It appears from the observations of Mazé that the bacterium can even absorb free nitrogen when grown in cultures

outside the plant. We have here a very interesting case of symbiosis as mentioned above. The green plant, however, always keeps the upper hand, restricting the development of the bacteria to the nodules and later absorbing them for its own use. It should be mentioned that different genera require different races of the bacterium for the production of nodules.

The important part that these bacteria play in agriculture led to the introduction in Germany of a commercial product (the so-called "nitragin") consisting of a pure culture of the bacteria, which is to be sprayed over the soil or applied to the seeds before sowing. This material was found at first to have a very uncertain effect, but later experiments in America, and the use of a modified

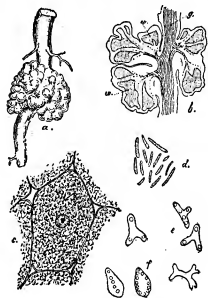

FIG. 16.

- a, root nodule of the lupin, nat. size. (From Woronov.)
 b, longitudinal section through root and nodule.
 c, fibro-vascular bundle.
 w, bacterial tissue. (After Woronov.)
 c, cell from bacterial tissues showing nucleus and protoplasm filled with bacteria.
 d, bacteria from nodule of lupin, normal undegenerate form.
 e and f, bacteroids from *Vicia villosa* and *Lupinus albus*. (After Morck.)

(From Fischer's *Vorlesungen über Bakterien*.)

commercially, the importance to agriculture of the discovery cannot be overestimated; each plant will provide, like the bean and vetch, its own nitrogenous manure, and larger crops will be produced at a decreased cost.

Another important advance is in our knowledge of the part played by bacteria in the circulation of carbon in nature.

The enormous masses of cellulose deposited annually on the earth's surface are, as we know, principally the

result of chlorophyll action on the carbon dioxide of the atmosphere decomposed by energy derived from the sun; and although we know little as yet concerning the magnitude of other processes of carbon-assimilation—e.g. by nitrifying bacteria—it is probably comparatively small. Such cellulose is gradually reconverted into water and carbon dioxide, but for some time nothing positive was known as to the agents which thus break up the paper, rags, straw, leaves and wood, &c., accumulating in cesspools, forests, marshes and elsewhere in such abundance. The work of van Tieghem, van Senus, Friebes, Omeliansky and others has now shown that while certain anaerobic bacteria decompose the substance of the middle lamella—chiefly pectin compounds—and thus bring about the isolation of the cellulose fibres when, for instance, flax is steeped or "retted," they are

unable to attack the cellulose itself. There exist in the mud of marshes, rivers and cloacae, &c., however, other anaerobic bacteria which decompose cellulose, probably hydrolysing it first and then splitting the products into carbon dioxide and marsh gas. When calcium sulphate is present, the nascent methane induces the formation of calcium carbonate, sulphuretted hydrogen and water. We have thus an explanation of the occurrence of marsh gas and sulphuretted hydrogen in bogs, and it is highly probable that the existence of these gases in the intestines of herbivorous animals is due to similar putrefactive changes in the undigested cellulose remains.

Cohn long ago showed that certain glistening particles observed in the cells of *Beggiaria* consist of sulphur, and Winogradsky and Beyerinck have shown that a whole series of sulphur bacteria of the genera *Thiothrix*, *Chromatium*, *Spirillum*, *Monas*, &c., exist, and play important parts in the circulation of this element in nature, e.g. in marshes, estuaries, sulphur springs, &c. When cellulose bacteria set free

Sulphur bacteria.

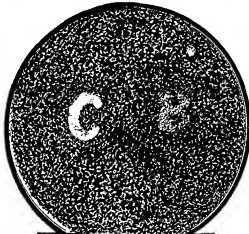

FIG. 17.—A plate-culture of a bacillus which had been exposed for a period of four hours behind a zinc stencil-plate, in which the letters C and B were cut. The light had to traverse a screen of water before passing through the C, and one of aesculin (which filters out the blue and violet rays) before passing the B. The plate was then incubated, and, as the figure shows, the bacteria on the C-shaped area were all killed, whereas they developed elsewhere on the plate (traces of the B are just visible to the right) and covered it with an opaque growth. (H. M. W.)

marsh gas, the nascent gas reduces sulphates—e.g. gypsum—with liberation of SH_2 , and it is found that the sulphur bacteria thrive under such conditions by oxidizing the SH_2 and storing the sulphur in their own protoplasm. If the SH_2 runs short they oxidize the sulphur again to sulphuric acid, which combines with any calcium carbonate present and forms sulphate again. Similarly nascent methane may reduce iron salts, and the black mud in which these bacteria often occur owes its colour to the FeS formed. Beyerinck and Jegunow have shown that some partially anaerobic sulphur bacteria can only exist in strata at a certain depth below the level of quiet waters where SH_2 is being set free below by the bacterial decompositions of vegetable mud and rises to meet the atmospheric oxygen coming down from above, and that this zone of physiological activity rises and falls with the variations of partial pressure of the gases due to the rate of evolution of the SH_2 . In the deeper parts of this zone the bacteria absorb the SH_2 , and, as they rise, oxidize it and store up the sulphur; then ascending into planes more highly oxygenated, oxidize the sulphur to SO_2 . These bacteria therefore employ SH_2 as their respiratory substance, much as higher plants employ carbohydrates—instead of liberating energy as heat by the respiratory combustion of sugars, they do it by oxidizing hydrogen sulphide. Beyerinck has shown that *Spirillum desulphuricans*, a definite anaerobic form, attacks and reduces sulphates, thus undoing the work of the sulphur bacteria as certain de-nitrifying bacteria reverse the operations of nitro-bacteria. Here again, therefore, we have sulphur, taken

into the higher plants as sulphates, built up into proteids, decomposed by putrefactive bacteria and yielding SH_2 which the sulphur bacteria oxidize; the resulting sulphur is then again oxidized to SO_3 and again combined with calcium to gypsum, the cycle being thus complete.

Chalybeate waters, pools in marshes near ironstone, &c., abound in bacteria, some of which belong to the remarkable genera *Crenothrix*, *Cladothrix* and *Lepithrix*, and contain ferric oxide, i.e. rust, in their cell-walls.

Iron bacteria. This iron deposit is not merely mechanical but is due to the physiological activity of the organism which, according to Winogradsky, liberates energy by oxidizing ferrous and ferric oxide in its protoplasm—a view not accepted by H. Molesch. The iron must be in certain soluble conditions, however, and the soluble bicarbonate of the protoxide of chalybeate springs seems most favourable; the hydrocarbonate absorbed by the cells is oxidized, probably thus—

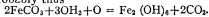

The ferric hydroxide accumulates in the sheath, and gradually passes into the more insoluble ferric oxide. These actions are of extreme importance in nature, as their continuation results in the enormous deposits of bog-iron ore, ochre, and—since Molesch has shown that the iron can be replaced by manganese in some bacteria—of manganese ores.

Considerable advances in our knowledge of the various chromogenic bacteria have been made by the studies of Beyerinck, Lankester, Engelmann, Ewart and others, and have assumed exceptional importance owing to the discovery that *Bacteriopurpurin*—the red colouring matter contained in certain sulphur bacteria—absorbs certain rays of solar energy, and enables the organism to utilize the energy for its own life-purposes. Engelmann showed, for instance, that these red-purple bacteria collect in the ultra-red, and to a less extent in the orange and green, in bands which agree with the absorption spectrum of the extracted colouring matter. Not only so, but the evident parallelism between this absorption of light and that by the chlorophyll of green plants, is completed by the demonstration that oxygen is set free by these bacteria—i.e. by means of radiant energy trapped by their colour-screens the living cells are in both cases enabled to do work, such as the reduction of highly oxidized compounds.

The most recent observations of Molesch seem to show that bacteria possessing bacteriopurpurin exhibit a new type of assimilation—the assimilation of organic material under the influence of light. In the case of these red-purple bacteria the colouring matter is contained in the protoplasm of the cell, but in most chromogenic bacteria it occurs as excreted pigment on and between the cells, or is formed by their action in the medium. Ewart has confirmed the principal conclusions concerning these purple, and also the so-called chlorophyll bacteria (*B. viride*, *B. chlorinum*, &c.), the results going to show that these are, as many authorities have held, merely minute algae. The pigment itself may be soluble in water, as is the case with the blue-green fluorescent body formed by *B. pyocyanus*, *B. fluorescens* and a whole group of fluorescent bacteria. Neelson found that the pigment of *B. cyanogenus* gives a band in the yellow and strong lines at E and F in the solar spectrum—an absorption spectrum almost identical with that of triphenyl-rozaniline. In the case of the scarlet and crimson red pigments of *B. prodigiosus*, *B. ruber*, &c., the violet of *B. violaceus*, *B. janthinus*, &c., the red-purple of the sulphur bacteria, and indeed most bacterial pigments, solution in water does not occur, though alcohol extracts the colour readily. Finally, there are a few forms which yield their colour to neither alcohol nor water, e.g. the yellow *Micrococcus cereus-flavus* and the *B. berolinensis*. Much work is still necessary before we can estimate the importance of these pigments. Their spectra are only imperfectly known in a few cases, and the bearing of the absorption on the life-history is still a mystery. In many cases the colour-production is dependent on certain definite conditions—temperature, presence of oxygen, nature of the food-medium, &c. Ewart's important discovery that some of these lipochrome pigments occlude

oxygen, while others do not, may have bearings on the facultative anaerobism of these organisms.

A branch of bacteriology which offers numerous problems of importance is that which deals with the organisms so common in milk, butter and cheese. Milk is a medium not only admirably suited to the growth of bacteria, but, as a matter of fact, always contaminated with these organisms in the ordinary course of supply. F. Lafar has stated that 20% of the cows in Germany suffer from tuberculosis, which also affected 17.7% of the cattle slaughtered in Copenhagen between 1891 and 1893, and that one in every thirteen samples of milk examined in Paris, and one in every nineteen in Washington, contained tubercle bacilli. Hence the desirability of sterilizing milk used for domestic purposes becomes imperative.

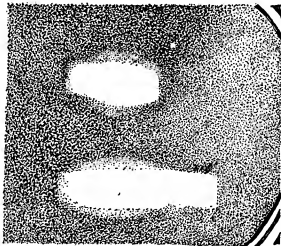

FIG. 18.—A similar preparation to fig. 17, except that two slit-like openings of equal length allowed the light to pass, and that the light was that of the electric arc passed through a quartz prism and casting a powerful spectrum on the plate. The upper slit was covered with glass, the lower with quartz. The bacteria were killed over the clear areas shown. The left-hand boundary of the clear area corresponds to the line F (green end of the blue), and the beginning of the ultra-violet was at the extreme right of the upper (short) area. The lower area of bactericidal action extends much farther to the right, because the quartz allows more ultra-violet rays to pass than does glass. The red-yellow-green to the left of F were without effect. (H. M. W.)

No milk is free from bacteria, because the external orifices of the milk-ducts always contain them, but the forms present in the normal fluid are principally those which induce such changes as the souring or "turning" so frequently observed in standing milk (these were examined by Lord Lister as long ago as 1873–1877, though several other species are now known), and those which bring about the various changes and fermentations in butter and cheese made from it. The presence of foreign germs, which may gain the upper hand and totally destroy the flavours of butter and cheese, has led to the search for those particular forms to which the approved properties are due. A definite bacillus to which the peculiarly fine flavour of certain butters is due, is said to be largely employed in pure cultures in American dairies, and in Denmark certain butters are said to keep fresh much longer owing to the use of pure cultures and the treatment employed to suppress the forms which cause rancidity. Quite distinct is the search for the germs which cause undesirable changes, or "diseases"; and great strides have been made in discovering the bacteria concerned in rendering milk "ropy," butter "oily" and "rancid," &c. Cheese in its numerous forms contains myriads of bacteria, and some of these are now known to be concerned in the various processes of ripening and other changes affecting the product, and although little is known as to the exact part played by any species, practical applications of the discoveries of the decade 1800–1900 have been made, e.g. Edam cheese. The Japanese have cheeses resulting from the bacterial fermentation of boiled Soja beans.

That bacterial fermentations are accompanied by the evolution of heat is an old experience; but the discovery that the "spontaneous" combustion of sterilized cotton-waste does not occur simply if moist and freely exposed to oxygen, but results when the washings of fresh waste are added, has led to clearer proof that the heating of hay-stacks, hops, tobacco and other vegetable products is due to the vital activity of bacteria and fungi, and is physiologically a consequence of respiratory processes like those in malting. It seems fairly established that when the preliminary heating process of fermentation is drawing to a close, the cotton, hay, &c., having been converted into a highly porous friable and combustible mass, may then ignite in certain circumstances by the occlusion of oxygen, just as ignition is induced by finely divided metals. A remarkable point in this connexion has always been the necessary conclusion that the living bacteria concerned must be exposed to temperatures of at least 70° C. in the hot heaps. Apart from the resolution of doubts as to the power of spores to withstand such temperatures for long periods, the discoveries of Miquel, Globig and others have shown that there are numerous bacteria which will grow and divide at such temperatures, e.g. *B. thermophilus*, from sewage, which is quite active at 70° C., and *B. Ludwigii* and *B. illudensis*, &c., from hot springs, &c.

The bodies of sea fish, e.g. mackerel and other animals, have long been known to exhibit phosphorescence. This phenomenon is due to the activity of a whole series of marine bacteria of various genera, the examination and cultivation of which have been successfully carried out by Cohn, Beyerinck, Fischer and others.

The cause of the phosphorescence is still a mystery. The suggestion that it is due to the oxidation of a body excreted by the bacteria seems answered by the failure to filter off or extract any such body. Beyerinck's view that it occurs at the moment peptones are worked up into the protoplasm cannot be regarded as proved, and the same must be said of the suggestion that the phosphorescence is due to the oxidation of phosphoretted hydrogen. The conditions of phosphorescence are, the presence of free oxygen, and, generally, a relatively low temperature, together with a medium containing sodium chloride, and peptones, but little or no carbohydrates. Considerable differences occur in these latter respects, however, and interesting results were obtained by Beyerinck with mixtures of species possessing different powers of enzyme action as regards carbohydrates. Thus, a form termed *Photobacterium phosphorescens* by Beyerinck will absorb maltose, and will become luminous if that sugar is present, whereas *P. Pflugeri* is indifferent to maltose. If then we prepare densely inseminated plates of these two bacteria in gelatine food-medium to which starch is added as the only carbohydrate, the bacteria grow but do not phosphoresce. If we now streak these plates with an organism, e.g. a yeast, which saccharifies starch, it is possible to tell whether maltose or levulose and fructose are formed; if the former, only those plates containing *P. phosphorescens* will become luminous; if the latter, only those containing *P. Pflugeri*. The more recent researches of Molisch have shown that the luminosity of ordinary butcher's meat under appropriate conditions is quite a common occurrence. Thus of samples of meat bought in Prague and kept in a cool room for about two days, luminosity was present in 52% of the samples in the case of beef, 50% for veal, and 39% for liver. If the meat was treated previously with a 3% salt solution, 89% of the samples of beef and 65% of the samples of horseflesh were found to exhibit this phenomenon. The cause of this luminosity is *Micrococcus phosphorens*, an immotile round, or almost round organism. This organism is quite distinct from that causing the luminosity of marine fish.

It has long been known that the production of vinegar depends on the oxidation of the alcohol in wine or beer to acetic acid, the chemical process being probably carried out in two stages, viz. the oxidation of the alcohol leading to the formation of aldehyde and water, and the further oxidation of the aldehyde to acetic acid. The process may even go farther, and the acetic acid be oxidized to CO₂ and OH₂;

the art of the vinegar-maker is directed to preventing the accomplishment of the last stage. These oxidations are brought about by the vital activity of several bacteria, of which four—*Bacterium aceti*, *B. pasteurianum*, *B. hüttingianum*, and *B. xylinum*—have been thoroughly studied by Hansen and A. Brown. It is these bacteria which form the zoogloea of the "mother of vinegar," though this film may contain other organisms as well. The idea that this film of bacteria oxidizes the alcohol beneath by merely condensing atmospheric oxygen in its interstices, after the manner of spongy platinum, has long been given up; but the explanation of the action as an incomplete combustion, depending on the peculiar respiration of these organisms—much as in the case of nitrifying and sulphur bacteria—is not clear, though the discovery that the acetic bacteria will not only oxidize alcohol to acetic acid, but further oxidize the latter to CO₂ and OH₂ supports the view that the alcohol is absorbed by the organism and employed as its respirable substance. Promise of more light on these oxidation fermentations is afforded by the recent discovery that not only bacteria and fungi, but even the living cells of higher plants, contain peculiar enzymes which possess the remarkable property of "carrying" oxygen—much as it is carried in the sulphuric acid chamber—and which have therefore been termed oxydases. It is apparently the presence of these oxydases which causes certain wines to change colour and alter in taste when poured from bottle to glass, and so exposed to air.

Much as the decade from 1880 to 1890 abounded with investigations on the reactions of bacteria to heat, so the following decade was remarkable for discoveries regarding the effects of other forms of radiant energy. The observations of Downes and Blunt in 1877 left it uncertain whether the bactericidal effects in broth cultures exposed to solar rays were due to thermal action or not. Further investigations, in

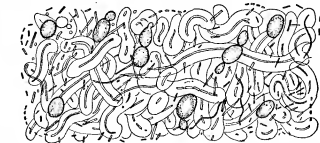

FIG. 19.—Ginger-beer plant, showing yeast (*Saccharomyces pyruformis*) entangled in the meshes of the bacterium (*B. vermiforme*). (H. M. W.)

which Arlring, Buchner, Chmelewski, and others took part, have led to the proof that rays of light alone are quite capable of killing these organisms. The principal questions were satisfactorily settled by Marshall Ward's experiments in 1892-1893, when he showed that even the spores of *B. anthracis*, which withstand temperatures of 100° C. and upwards, can be killed by exposure to rays of reflected light at temperatures far below anything injurious, or even favourable to growth. He also showed that the bactericidal action takes place in the absence of food materials, thus proving that it is not merely a poisoning effect of the altered medium. The principal experiments also indicate that it is the rays of highest refrangibility—the blue-violet and ultra-violet rays of the spectrum—which bring about the destruction of the organisms (figs. 17, 18). The practical effect of the bactericidal action of solar light is the destruction of enormous quantities of germs in rivers, the atmosphere and other exposed situations, and experiments have shown that it is especially the pathogenic bacteria—anthrax, typhoid, &c.—which thus succumb to light-action; the discovery that the electric arc is very rich in bactericidal rays led to the hope that it could be used for disinfecting purposes in hospitals, but mechanical difficulties intervene. The recent application of the action of bactericidal rays to the cure of lupus is, however, an extension of the same discovery. Even when the light is not sufficiently intense, or the exposure is too short to kill the spores, the experiments show that attenuation of virulence,

may result, a point of extreme importance in connexion with the lighting and ventilation of dwellings, the purification of rivers and streams, and the general diminution of epidemics in nature.

As we have seen, thermophilous bacteria can grow at high temperatures, and it has long been known that some forms develop on ice. The somewhat different question of the resistance of ripe spores or cells to extremes of heat and cold has received attention. Ravenel, Macfadyen and Rowland have shown that several bacilli will bear exposure for seven days to the temperature of liquid air (-192°C . to -183°C .) and again grow when put into normal conditions. More recent experiments have shown that even ten hours' exposure to the temperature of liquid hydrogen -252°C . (21° on the absolute scale) failed to kill them. It is probable that all these cases of resistance of seeds, spores, &c., are to be connected with the fact that completely dry albumin does not lose its coagulability on heating to 110°C . for some hours, since it is well known that completely ripe spores and dry heat are the conditions of extreme experiments.

No sharp line can be drawn between pathogenic and non-pathogenic Schizomycetes, and some of the most marked steps

in the progress of our modern knowledge of these organisms depend on the discovery that their pathogenicity or virulence can be modified—diminished or increased—by definite treatment, and, in the natural course of epidemics, by alterations in the environment. Similarly we are unable to divide Schizomycetes sharply into parasites and saprophytes, since it is well proved that a number of species—facultative parasites—can become one or the other according to circumstances. These facts, and the further knowledge that many bacteria never observed as parasites, or as pathogenic forms, produce toxins or poisons as the result of their decompositions and fermentations of organic substances, have led to important results in the applications of bacteriology to medicine.

Bacterial diseases in the higher plants have been described, but the subject requires careful treatment, since several points

suggest doubts as to the organism described being the cause of the disease referred to their agency. Until

recently it was urged that the acid contents of plants explained their immunity from bacterial diseases, but it is now known that many bacteria can flourish in acid media. Another objection was that even if bacteria obtained access through the stomata, they could not penetrate the cell-walls bounding the intercellular spaces, but certain anaerobic forms are known to ferment cellulose, and others possess the power of penetrating the cell-walls of living cells, as the bacteria of Leguminosae first described by Marshall Ward in 1887, and confirmed by Miss Dawson in 1898. On the other hand a long list of plant-diseases has been of late years attributed to bacterial action. Some, e.g. the Sereh disease of the sugar-cane, the slime fluxes of oaks and other trees, are not only very doubtful cases, in which other organisms such as yeasts and fungi play their parts, but it may be regarded as extremely improbable that the bacteria are the primary agents at all; they are doubtless saprophytic forms which have gained access to rotting tissues injured by other agents. Saprophytic bacteria can readily make their way down the dead hypha of an invading fungus, or into the punctures made by insects, and Aphides have been credited with the bacterial infection of carnations, though more recent researches by Woods go to show the correctness of his conclusion that Aphides alone are responsible for the carnation disease. On the other hand, recent investigation has brought to light cases in which bacteria are certainly the primary agents in diseases of plants. The principal features are the stoppage of the vessels and consequent wilting of the shoots; as a rule the cut vessels on transverse sections of the shoots appear brown and choked with a dark yellowish slime in which bacteria may be detected, e.g. cabbages, cucumbers, potatoes, &c. In the carnation disease and in certain diseases of tobacco and other plants the seat of bacterial action appears to be the parenchyma, and it may be that Aphides or other piercing insects infect the plants, much as insects convey pollen from plant to plant, or

(though in a different way) as mosquitoes infect man with malaria. If the recent work on the cabbage disease may be accepted, the bacteria make their entry at the water pores at the margins of the leaf, and thence via the glandular cells to the tracheids. Little is known of the mode of action of bacteria on these plants, but it may be assumed with great confidence that they excrete enzymes and poisons (toxins), which diffuse into the cells and kill them, and that the effects are in principle the same as those of parasitic fungi. Support is found for this opinion in Beyerinck's discovery that the juices of tobacco plants affected with the disease known as "leaf mosaic," will induce this disease after filtration through porcelain.

In addition to such cases as the kephir and ginger-beer plants (figs. 19, 20), where anaerobic bacteria are associated with yeasts, several interesting examples of symbiosis among bacteria are now known. *Bacillus chalayae* ferments cane-sugar solutions in such a way that normal butyric acid, inactive lactic acid, carbon dioxide, and

Symbiosis.

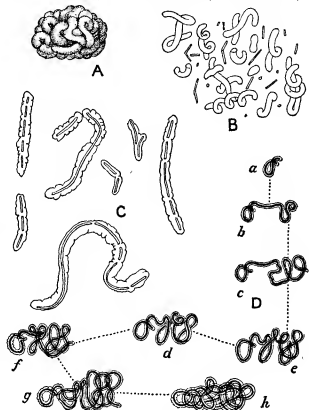

FIG. 20.—The ginger-beer plant.

A. One of the brain-like gelatinous masses into which the mature "plant" condenses.

B. The bacterium with and without its gelatinous sheaths (cf. fig. 10).

C. Typical filaments and rodlets in the slimy sheaths.

D. Stages of growth of a sheathed filament—d at 9 A.M., b at 3 P.M., c at 9 P.M., d at 11 A.M. next day, e at 3 P.M., f at 9 P.M., g at 10.30 A.M. next day, h at 24 hours later. (H. M. W.)

hydrogen result; *Micrococcus acidi-paralactici*, on the other hand, ferments such solutions to optically active paralactic acid. Nencki showed, however, that if both these organisms occur together, the resulting products contain large quantities of normal butyl alcohol, a substance neither bacterium can produce alone. Other observers have brought forward other cases. Thus neither *B. coli* nor the *B. dentrificans* of Burri and Stutzer can reduce nitrates, but if acting together they so completely undo the structure of sodium nitrate that the nitrogen passes off in the free state. Van Senus showed that the concurrence of two bacteria is necessary before his *B. amylobacter* can ferment cellulose, and the case of mud bacteria which evolve sulphuretted hydrogen below which is utilized by sulphur bacteria above has already been quoted, as also that of Winogradsky's *Clostridium*

pasteurianum, which is anaerobic, and can fix nitrogen only if protected from oxygen by aerobic species. It is very probable that numerous symbiotic fermentations in the soil are due to this co-operation of oxygen-protecting species with anaerobic ones, e.g. *Tetanus*.

Astonishment has been frequently expressed at the powerful activities of bacteria—their rapid growth and dissemination, the extensive and profound decompositions and fermentations induced by them, the resistance of their spores to desiccation, heat, &c.—but it is worth while to ask how far these properties are really remarkable when all the data for comparison with other organisms are considered. In the first place, the extremely small size and isolation of the vegetative cells place the protoplasmic contents in peculiarly favourable circumstances for action, and we may safely conclude that, weight for weight and molecule for molecule, the protoplasm of bacteria is brought into contact with the environment at far more points and over a far larger surface than is that of higher organisms, whether—as in plants—it is distributed in thin layers round the sap-vacuoles, or—as in animals—is bathed in fluids brought by special mechanisms

Activity of bacteria.

to irrigate it. Not only so, the isolation of the cells facilitates the exchange of liquids and gases, the passage in of food materials and out of enzymes and products of metabolism, and thus each unit of protoplasm obtains opportunities of immediate action, the results of which are removed with equal rapidity, not attainable in more complex multicellular organisms. To put the matter in another way, if we could imagine all the living cells of a large oak or of a horse, having given up the specializations of function impressed on them during evolution and simply carrying out the fundamental functions of nutrition, growth, and multiplication which mark the generalized activities of the bacterial cell, and at the same time rendered as accessible to the environment by isolation and consequent extension of surface, we should doubtless find them exerting changes in the fermentable fluids necessary to their life similar to those exerted by an equal mass of bacteria, and that in proportion to their approximation in size to the latter. Ciliary movements, which undoubtedly contribute in bringing the surface into contact with larger supplies of oxygen and other fluids in unity of time, are not so rapid or so extensive when compared with other standards than the apparent dimensions of the microscopic field. The microscope magnifies the distance traversed as well as the organism, and although a bacterium which covers 9–10 cm. or more in 15 minutes—say 0.1 mm. or 100 μ per second—appears to be darting across the field with great velocity, because its own small size—say 5 \times 1 μ —comes into comparison, it should be borne in mind that if a mouse 2 in. long only, travelled twenty times its own length, i.e. 40 in., in a second, the distance traversed in 15 minutes at that rate, viz. 1000 yards, would not appear excessive. In a similar way we must be careful, in our wonder at the marvellous rapidity of cell-division and growth of bacteria, that we do not exaggerate the significance of the phenomenon. It takes any ordinary rodlet 30–40 minutes to double its length and divide into two equal daughter cells when growth is at its best; nearer the minimum it may require 3–4 hours or even much longer. It is by no means certain that even the higher rate is greater than that exhibited by a tropical bamboo which



FIG. 21.—A plate-culture colony of a species of *Bacillus-Proteus* (Hauser) on the fifth day. The flame-like processes and outliers are composed of writhing filaments, and the contours are continually changing while the colony moves as a whole. Slightly magnified. (H. M. W.)

will grow over a foot a day, or even common grasses, or asparagus, during the active period of cell-division, though the phenomenon is here complicated by the phase of extension due to intercalation of water. The enormous extension of surface also facilitates the absorption of energy from the environment, and, to take one case only, it is impossible to doubt that some source of radiant energy must be at the disposal of those prototrophic forms which decompose carbonates and assimilate carbonic acid in the dark and oxidize nitrogen in dry rocky regions where no organic materials are at their disposal, even could they utilize them. It is usually stated that the carbon dioxide molecule is here.

will grow over a foot a day, or even common grasses, or asparagus, during the active period of cell-division, though the phenomenon is here complicated by the phase of extension due to intercalation of water. The enormous extension of surface also facilitates the absorption of energy from the environment, and, to take one case only, it is impossible to doubt that some source of radiant energy must be at the disposal of those prototrophic forms which decompose carbonates and assimilate carbonic acid in the dark and oxidize nitrogen in dry rocky regions where no organic materials are at their disposal, even could they utilize them. It is usually stated that the carbon dioxide molecule is here.

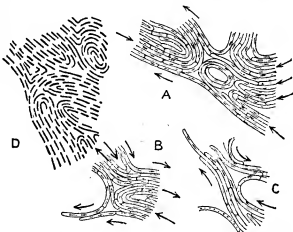

FIG. 22.—Portions of a colony such as that in fig. 21, highly magnified, showing the kinds of changes brought about in a few minutes, from A to B, and B to C, by the growth and ciliary movements of the filaments. The arrows show the direction of motion. (H. M. W.)

split by means of energy derived from the oxidation of nitrogen, but apart from the fact that none of these processes can proceed until the temperature rises to the minimum cardinal point, Engelmann's experiment shows that in the purple bacteria rays are used other than those employed by green plants, and especially ultra-red rays not seen in the spectrum, and we may probably conclude that "dark rays"—i.e. rays not appearing in the visible spectrum—are absorbed and employed by these and other colourless bacteria. The purple bacteria have thus two sources of energy, one by the oxidation of sulphur and another by the absorption of "dark rays." Stoney (*Scient. Proc. R. Dub. Soc.*, 1893, p. 154) has suggested yet another source of energy, in the bombardment of these minute masses by the molecules of the environment, the velocity of which is sufficient to drive them well into the organism, and carry energy in of which they can avail themselves.

AUTHORITIES.—General: Fischer, *The Structure and Functions of Bacteria* (Oxford, 1900, 2nd ed.); German (Jena, 1903); Migula, *System der Bakterien* (Jena, 1897); and in Engler and Prantl, *Die natürlichen Pflanzenfamilien*, I. Th. 1. Abt. a; Lafar, *Technical Mycology* (vol. 1. London, 1898); Mace, *Traité pratique de bactériologie* (5th ed. 1904). Fossil bacteria: Renault, "Recherches sur les Bactéries fossiles," *Ann. des Sc. Nat.*, 1806, p. 275. Bacteria in Water: Frankland and Marshall Ward. "Reports on the Bacteriology of Water," *Proc. R. Soc. vol. li. p. 183, vol. liii. p. 245; vol. lvi. p. 1; Marshall Ward*, "On the Biology of *B. ramosus*," *Proc. R. Soc.*, vol. lviii. p. 1; and papers on Bacteria of the river Thames in *Ann. of Bot.* vol. xii. pp. 59 and 287, and vol. xiii. p. 107. Cell-membrane, &c.: Bütschli, *Weitere Ausführungen über den Bau der Cyanophyceen und Bakterien* (Leipzig, 1896); Fischer, *Unters. über den Bau der Cyanophyceen und Bakterien* (Jena, 1897); Rowland, "Observations upon the Structure of Bacteria," *Trans. Jenner Institute*, 2nd ser. 1899, p. 143, with literature. Cilia: Fischer, "Unters. über Bakterien," *Pringsh. Jahrb.* vol. xviii.; also the works of Migula and Fischer already cited. Nucleus: Wager in *Ann. Bot.* vol. lvi. p. 699; also Migula and Fischer, *l.c.*; Vejdovsky, "Über den Kern der Bakterien und seine Teilung," *Cent. f. Bakt.* Abt. II. Bd. xi. (1904) p. 481; *ibid.*; "Cytologisches über die Bakterien der Prager Wasserleitung," *Cent. f. Bakt.* Abt. II. Bd. xv. (1905); Mencl, "Nachträge zu den Strukturverhältnissen von Bakterium gammari" in *Archiv f. Protistenkunde*, Bd. viii. (1907), p. 257. Spores, &c.: Marshall Ward, "On the Biology of *B. ramosus*," *Proc. R. Soc.*, 1895, vol. lviii. p. 1; Sturgis, "A Soil Bacillus of the type of de Bary's *B. megatherium*," *Phil. Trans.*

vol. cxi. p. 147; Klein, L., *Ber. d. deutschen bot. Gesellsch.* (1889), Bd. vii.; and *Cent. f. Bakt. und Par.* (1889), Bd. vi. Classification: Marshall Ward, "On the Characters or Marks employed for classifying the Schizomycetes," *Ann. of Bot.* 1892, vol. vi.; Lehmann and Neumann, *Atlas and Essentials of Bacteriology*; also the works of Migula and Fischer already cited. Mycobacteriaceae: Berkeley, *Introductio Cryptogamica Botany* (1857), p. 313; Thaxter, "A New Order of Schizomycetes," *Bot. Gaz.* vol. xvii. (1892), p. 389; and "Further Observations on the Mycobacteriaceae," *ibid.* vol. xxiii. (1897), p. 395; and "Notes on the Mycobacteriaceae," *ibid.* vol. xxvii. (1904), p. 405; Baur, "Mycobakterienstudien," *Arch. f. Protistenkunde*, Bd. v. (1904), p. 92; Smith, "Mycobacteria," *Jour. of Botany*, 1901, p. 69; Quehl, *Cent. f. Bakt. xvii.* (1896), p. 9. Growth: Marshall Ward, "On the Biology of *B. ramosus*," *Proc. R. Soc. vol. lviii.* p. 1 (1895). Fermentation, &c.: Warrington, *The Chemical Action of some Micro-organisms* (London, 1888); Winogradsky, "Recherches sur les organismes de la nitrification," *Ann. de l'Inst. Past.*, 1890, pp. 213, 257, 760, 1891, pp. 92 and 577; "Sur l'assimilation de l'azote gazeux, &c.," *Compt. Rend.*, 12 Feb. 1894; "Zur Microbiologie des Nitrificationsprozesses," *Cent. f. Bakt.* Abt. II, Bd. ii. (1896), p. 415; "Ueber Schwefel-Bakterien," *Bot. Zeitg.* 1887, Nos. 31-37; *Beitr. zur Morph. u. Phys. der Bakterien*, H. 1 (1888); "Ueber Eisenbakterien," *Bot. Zeitg.*, 1888, p. 261; Omeliansky, "Ueber den Einfluss der organischen Substanzen auf die Arbeit der nitrifizierenden Organismen," *Cent. f. Bakt.* Abt. II, Bd. v. (1896); Schorler, "Beitr. zur Kenntnis der Eisenbakterien," *Cent. f. Bakt.* Abt. II, Bd. xii. (1904), p. 681; Marshall Ward, "On the Tubercular Swellings on the Roots of *Vicia Faba*," *Phil. Trans.*, 1877, p. 539; Hellriegel and Wilfarth, "Unters. über die Stickstoffnahrung der Gramineen u. Leguminosen," *Beit. Zeit. d. Vereins für die Rübensuckerindustrie* (Berlin, 1888); Nobbe and Hiltner, *Landw. Versuchsstationen* (1899), Bd. 51, p. 241, and Bd. 52, p. 455; Mazé, *Annales de l'Institut Pasteur*, 1897, vol. xxi. p. 12; "1897"; Przymusiński, *Landw. Versuchsstationen*, Bd. 37 (1898), p. 161; Bd. 38 (1891), p. 5; Frank, *Landw. Jahrb.* Bd. 17 (1888), p. 441; Omeliansky, "Sur la fermentation de la cellulose," *Compt. Rend.*, 4 Nov. 1895; van Senus, *Beitr. zur Kenntn. der Cellulosegährung* (Leiden, 1890); van Tieghem, "Sur la fermentation de la cellulose," *Bull. de la soc. bot. de Fr.* t. xxvii. (1879), p. 28; Bevernick, "Ueber Spirillum desulphuricans, &c.," *Cent. f. Bakt.* Abt. II, Bd. i. (1895), p. 1; Molisch, *Die Pflanze in ihren Beziehungen zum Eisen* (Jena, 1892). Pigment Bacteria: Ewart, "On the Evolution of Oxygen from Coloured Bacteria," *Limn. Journ.*, 1897, vol. xxxii. p. 123; Molisch, *Die Farne und Flechten* (Jena, 1907). Oxidases and Enzymes: Gray, *The Soluble Ferments and Fermentation* (Cambridge, 1899). Action of Light, &c.: Marshall Ward, "The Action of Light on Bacteria," *Phil. Trans.*, 1893, p. 961, and literature. Resistance to Cold, &c.: Ravenel, *Med. News*, 1899, vol. lxxiv.; Macfadyen and Rowland, *Proc. R. Soc. vol. lxxi.* pp. 180, 339, and 488; Farmer, "Observations on the Effect of Desiccation of Albumin upon its Coagulability," *ibid.* p. 329. Pathogenic Bacteria: Baumgarten, *Pathologische Mykologie* (1890); Kolle and Wassermann, *Handbuch der pathogenen Mikroorganismen* (1902-1904); and numerous special works in medical literature. Immunity: Ehrlich, "On Immunity with Special Reference to Cell-life," *Proc. R. Soc. vol. lxxi.* p. 424; Calcar, "Die Fortschritte der Immunitäts- und Spezifitätslehre seit 1870," *Progressus Rei Botanicae*, Bd. I, Heft 3 (1907). Bacteriosis: Migula, *l.c.* p. 322, has collected the literature; see also Sorauer, *Handbuch der Pflanzenkrankheiten*, I. (1905), pp. 18-93, for later literature. Symbiosis: Marshall Ward, "Symbiosis," *Ann. of Bot.* vol. xiii. p. 549, and literature.

(H. M. W.; V. H. B.)

II. PATHOLOGICAL IMPORTANCE

The action of bacteria as pathogenic agents is in great part merely an instance of their general action as producers of chemical change, yet bacteriology as a whole has become so extensive, and has so important a bearing on subjects widely different from one another, that division of it has become essential. The science will accordingly be treated in this section from the pathological standpoint only. It will be considered under the three following heads, viz. (1) the methods employed in the study; (2) the modes of action of bacteria and the effects produced by them; and (3) the facts and theories with regard to immunity against bacterial disease.

The demonstration by Pasteur that definite diseases could be produced by bacteria, proved a great stimulus to research in the etiology of infective conditions, and the result was a rapid advance in human knowledge. An all-important factor in this remarkable progress was the introduction by Koch of solid culture media, of the "plate-method," &c., an account of which he published in 1881. By means of these the modes of cultivation, and especially of separation, of bacteria were greatly simplified. Various modifications

have since been made, but the routine methods in bacteriological procedure still employed are in great part those given by Koch. By 1876 the anthrax bacillus had been obtained in pure culture by Koch, and some other pathogenic bacteria had been observed in the tissues, but it was in the decade 1880-1890 that the most important discoveries were made in this field. Thus the organisms of suppurative, tubercle, glanders, diphtheria, typhoid fever, cholera, tetanus, and others were identified, and their relationship to the individual diseases established. In the last decade of the 19th century the chief discoveries were of the bacillus of influenza (1892), of the bacillus of plague (1894) and of the bacillus of dysentery (1898). Immunity against diseases caused by bacteria has been the subject of systematic research from 1880 onwards. In producing active immunity by the attenuated virus, Duguid and J. S. Burdon-Sanderson and W. S. Greenfield in Great Britain, and Pasteur, Toussaint and Chauveau in France, were pioneers. The work of Metchnikoff, dating from about 1884, has proved of high importance, his theory of phagocytosis (*vide infra*) having given a great stimulus to research, and having also contributed to important advances. The modes by which bacteria produce their effects also became a subject of study, and attention was naturally turned to their toxic products. The earlier work, notably that of L. Brieger, chiefly concerned ptomaines (*vide infra*), but no great advance resulted. A new field of inquiry was, however, opened up when, by filtration a bacterium-free toxic fluid was obtained which produced the important symptoms of the disease—in the case of diphtheria by P. P. E. Roux and A. Yersin (1888), and in the case of tetanus a little later by various observers. Research was thus directed towards ascertaining the nature of the toxic bodies in such a fluid, and Brieger and Fraenkel (1890) found that they were proteids, to which they gave the name "toxalbumins." Though subsequent researches have on the whole confirmed these results, it is still a matter of dispute whether these proteids are the true toxins or merely contain the toxic bodies precipitated along with them. In the United Kingdom the work of Sidney Martin, in the separation of toxic substances from the bodies of those who have died from certain diseases, is also worthy of mention. Immunity against toxins also became a subject of investigation, and the result was the discovery of the antitoxic action of the serum of animals immunized against tetanus toxin by E. Behring and Kitazato (1890), and by Tizzoni and Cattani. A similar result was also obtained in the case of diphtheria. The facts with regard to passive immunity were thus established and were put to practical application by the introduction of diphtheria antitoxin as a therapeutic agent in 1894. The technique of serum preparation has become since that time greatly elaborated and improved, the work of P. Ehrlich in this respect being specially noteworthy. The laws of passive immunity were shown to hold also in the case of immunity against living organisms by R. Pfeiffer (1894), and various anti-bacterial sera have been introduced. Of these the anti-streptococcal serum of A. Marmorek (1895) is one of the best known. The principles of protective inoculation have been developed and practically applied on a large scale, notably by W. M. W. Hafkine in the case of cholera (1893) and plague (1896), and more recently by Wright and Semple in the case of typhoid fever. One other discovery of great importance may be mentioned, viz. the agglutinative action of the serum of a patient suffering from a bacterial disease, first described in the case of typhoid fever independently by Widal and by Grünbaum in 1896, though led up to by the work of Pfeiffer, Gruber and Durham and others. Thus a new aid was added to medical science, viz. serum diagnosis of disease. The last decade of the 19th century will stand out in the history of medical science as the period in which serum therapeutics and serum diagnosis had their birth.

In recent years the relations of toxin and antitoxin, still obscure, have been the subject of much study and controversy. It was formerly supposed that the injection of attenuated cultures or dead organisms—vaccines in the widest sense—was only of service in producing immunity as a preventive measure against the corresponding organism, but the work of

Sir Almroth Wright has shown that the use of such vaccines may be of service even after infection has occurred, especially when the resulting disease is localized. In this case a general reaction is stimulated by the vaccine which may aid in the destruction of the invading organisms. In regulating the administration of such vaccines he has introduced the method of observing the *opsonic index*, to which reference is made below. Of the discoveries of new organisms the most important is that of the *Spirochaete pallida* in syphilis by Schaudinn and Hoffmann in 1905; and although proof that it is the cause of the disease is not absolute, the facts that have been established constitute very strong presumptive evidence in favour of this being the case. It may be noted, however, that it is still doubtful whether this organism is to be placed amongst the bacteria or amongst the protozoa.

The methods employed in studying the relation of bacteria to disease are in principle comparatively simple, but considerable experience and great care are necessary in applying them and in interpreting results. In any given disease there are three chief steps, viz. (1) the discovery of a bacterium in the affected tissues by means of the microscope;

Methods of study.

(2) the obtaining of the bacterium in pure culture; and (3) the production of the disease by inoculation with a pure culture. By means of microscopic examination more than one organism may sometimes be observed in the tissues, but one single organism by its constant presence and special relations to the tissue changes can usually be selected as the probable cause of the disease, and attempts towards its cultivation can then be made. Such microscopic examination requires the use of the finest lenses and the application of various *staining* methods. In these latter the basic aniline dyes in solution are almost exclusively used, on account of their special affinity for the bacterial protoplasm. The methods vary much in detail, though in each case the endeavour is to colour the bacteria as deeply, and the tissues as faintly, as possible. Sometimes a simple watery solution of the dye is sufficient, but very often the best result is obtained by increasing the staining power, e.g. by addition of weak alkali, application of heat, &c., and by using some substance which acts as a mordant and tends to fix the stain to the bacteria. Excess of stain is afterwards removed from the tissues by the use of decolorizing agents, such as acids of varying strength and concentration, alcohol, &c. Different bacteria behave very differently to stains; some take them up rapidly, others slowly, some resist decolorization, others are easily decolorized. In some instances the stain can be entirely removed from the tissues, leaving the bacteria alone coloured, and the tissues can then be stained by another colour. This is the case in the methods for staining the tubercle bacillus and also in Gram's method, the essential point in which latter is the treatment with a solution of iodine before decolorizing. In Gram's method, however, only some bacteria retain the stain, while others lose it. The tissues and fluids are treated by various histological methods, but, to speak generally, examination is made either in films smeared on thin cover-glasses and allowed to dry, or in thin sections cut by the microtome after suitable fixation and hardening of the tissue. In the case of any bacterium discovered, observation must be made in a long series of instances in order to determine its invariable presence.

In cultivating bacteria outside the body various media to serve as food material must be prepared and sterilized by heat.

Cultivation. The general principle in their preparation is to supply the nutriment for bacterial growth in a form as nearly similar as possible to that of the natural habitat of the organisms—in the case of pathogenic bacteria, the natural fluids of the body. The media are used either in a fluid or solid condition, the latter being obtained by a process of coagulation, or by the addition of a gelatinizing agent, and are placed in glass tubes or flasks plugged with cotton-wool. To mention examples, blood serum solidified at a suitable temperature is a highly suitable medium, and various media are made with extract of meat as a basis, with the addition of gelatine or agar as solidifying agents and of non-coagulable proteids (commercial "pep-

tone") to make up for proteids lost by coagulation in the preparation. The reaction of the media must in every case be carefully attended to, a neutral or slightly alkaline reaction being, as a rule, most suitable; for delicate work it may be necessary to standardize the reaction by titration methods. The media from the store-flasks are placed in glass test-tubes or small flasks, protected from contamination by cotton-wool plugs, and are sterilized by heat. For most purposes the solid media are to be preferred, since bacterial growth appears as a discrete mass and accidental contamination can be readily recognized. Cultures are made by transferring by means of a sterile platinum wire a little of the material containing the bacteria to the medium. The tubes, after being thus inoculated, are kept at suitable temperatures, usually either at 37° C., the temperature of the body, or at about 20° C., a warm summer temperature, until growth appears. For maintaining a constant temperature incubators with regulating apparatus are used. Subsequent cultures or, as they are called, "subcultures," may be made by inoculating fresh tubes, and in this way growth may be maintained often for an indefinite period. The simplest case is that in which only one variety of bacterium is present, and a "pure culture" may then be obtained at once. When, however, several species are present together, means must be adopted for separating them. For this purpose various methods have been devised, the most important being the *plate-method* of Koch. In this method the bacteria are distributed in a gelatine or agar medium liquefied by heat, and the medium is then poured out on sterile glass plates or in shallow glass dishes, and allowed to solidify. Each bacterium capable of growth gives rise to a colony visible to the naked eye, and if the colonies are sufficiently apart, an inoculation can be made from any one to a tube of culture-medium and a pure culture obtained. Of course, in applying the method means must be adopted for suitably diluting the bacterial mixture. Another important method consists in inoculating an animal with some fluid containing the various bacteria. A pathogenic bacterium present may invade the body, and may be obtained in pure culture from the internal organs. This method applies especially to pathogenic bacteria whose growth on culture media is slow, e.g. the tubercle bacillus.

The full description of a particular bacterium implies an account not only of its microscopic characters, but also of its growth characters in various culture media, its biological properties, and the effects produced in animals by inoculation. To demonstrate readily its action on various substances, certain media have been devised. For example, various sugars—lactose, glucose, saccharose, &c.—are added to test the fermentative action of the bacterium on these substances; litmus is added to show changes in reaction, specially standardized media being used for estimating such changes; peptone solution is commonly employed for testing whether or not the bacterium forms indol; sterilized milk is used as a culture medium to determine whether or not it is curdled by the growth. Sometimes a bacterium can be readily recognized from one or two characters, but not infrequently a whole series of tests must be made before the species is determined. As our knowledge has advanced it has become abundantly evident that the so-called pathogenic bacteria are not organisms with special features, but that each is a member of a group of organisms possessing closely allied characters. From the point of view of evolution we may suppose that certain races of a group of bacteria have gradually acquired the power of invading the tissues of the body and producing disease. In the acquisition of pathogenic properties some of their original characters have become changed, but in many instances this has taken place only to a slight degree, and, furthermore, some of these changes are not of a permanent character. It is to be noted that in the case of bacteria we can only judge of organisms being of different species by the stability of the characters which distinguish them, and numerous examples might be given where their characters become modified by comparatively slight change in their environment. The cultural as well as the microscopical

characters of a pathogenic organism may be closely similar to other non-pathogenic members of the same group, and it thus comes to be a matter of extreme difficulty in certain cases to state what criterion should be used in differentiating varieties. The tests which are applied for this purpose at present are chiefly of two kinds. In the first place, such organisms may be differentiated by the chemical change produced by them in various culture media, e.g. by their fermentative action on various sugars, &c., though in this case such properties may become modified in the course of time. And in the second place, the various serum reactions to be described below have been called into requisition. It may be stated that the introduction of a particular bacterium into the tissues of the body leads to certain properties appearing in the serum, which are chiefly exerted towards this particular bacterium. Such a serum may accordingly within certain limits be used for differentiating this organism from others closely allied to it (*vide infra*).

The modes of cultivation described apply only to organisms which grow in presence of oxygen. Some, however—the strictly anaerobic bacteria—grow only in the absence of oxygen; hence means must be adopted for excluding this gas. It is found that if the inoculation be made deep down in a solid medium, growth of an anaerobic organism will take place, especially if the medium contains some reducing agent such as glucose. Such cultures are called "deep cultures." To obtain growth of an anaerobic organism on the surface of a medium, in using the plate method, and also for cultures in fluids, the air is displaced by an indifferent gas, usually hydrogen.

In testing the effects of bacteria by inoculation the smaller rodents, rabbits, guinea-pigs, and mice, are usually employed.

One great drawback in certain cases is that such animals are not susceptible to a given bacterium, or that the disease is different in character from that in the human subject. In some cases, e.g. Malta fever and relapsing fever, monkeys have been used with success, but in others, e.g. leprosy, none of the lower animals has been found to be susceptible. Discretion must therefore be exercised in interpreting negative results in the lower animals. For purposes of inoculation young vigorous cultures must be used. The bacteria are mixed with some indifferent fluid, or a fluid culture is employed. The injections are made by means of a hypodermic syringe into the subcutaneous tissue, into a vein, into one of the serous sacs, or more rarely into some special part of the body. The animal, after injection, must be kept in favourable surroundings, and any resulting symptoms noted. It may die, or may be killed at any time desired, and then a post-mortem examination is made, the conditions of the organs, &c., being observed and noted. The various tissues affected are examined microscopically and cultures made from them; in this way the structural changes and the relation of bacteria to them can be determined.

Though the causal relationship of a bacterium to a disease may be completely established by the methods given, another very important part of bacteriology is concerned with the poisons or toxins formed by bacteria. These toxins may become free in the culture fluid, and the living bacteria may then be got rid of by filtering the fluid through a filter of unglazed porcelain, whose pores are sufficiently small to retain them. The passage of the fluid is readily effected by negative pressure produced by an ordinary water exhaust-pump. The effects of the filtrate are then tested by the methods used in pharmacology. In other instances the toxins are retained to a large extent within the bacteria, and in this case the dead bacteria are injected as a suspension in fluid. Methods have been introduced for the purpose of breaking up the bodies of bacteria and setting free the intracellular toxins. For this purpose Koch ground up tubercle bacilli in an agate mortar and treated them with distilled water until practically no deposit remained. Rowland and Macfadyen for the same purpose introduced the method of grinding the bacilli in liquid air. At this temperature the bacterial bodies are extremely brittle, and are thus readily broken up. The study of the nature of toxins requires, of course, the various methods of organic chemistry. Attempts

to obtain them in an absolutely pure condition have, however, failed in important cases. So that when a "toxin" is spoken of, a mixture with other organic substances is usually implied. Or the toxin may be precipitated with other organic substances, purified to a certain extent by re-solution, re-precipitation, &c., and desiccated. A "dry toxin" is thus obtained, though still in an impure condition. Toxic substances have also been separated by corresponding methods from the bodies of those who have died of certain diseases, and the action of such substances on animals is in some cases an important point in the pathology of the disease. Another auxiliary method has been applied in this department, viz. the separation of organic substances by filtration under high pressure through a colloidal membrane, gelatine supported in the pores of a porcelain filter being usually employed. It has been found, for example, that a toxin may pass through such a filter while an antitoxin may not. The methods of producing immunity are dealt with below.

The fact that in anthrax, one of the first diseases to be fully studied, numerous bacilli are present in the blood of infected animals, gave origin to the idea that the organisms might produce their effect by using up the oxygen of the blood. Such action is now known to be quite a subsidiary matter. And although effects may sometimes be produced in a mechanical manner by bacteria plugging capillaries of important organs, e.g. brain and kidneys, it may now be stated as an accepted fact that all the important results of bacteria in the tissues are due to poisonous bodies or toxins formed by them. Here, just as in the general subject of fermentation, we must inquire whether the bacteria form the substances in question directly or by means of non-living ferments or enzymes. With regard to toxin formation the following general statements may be made. In certain instances, e.g. in the case of the tetanus and diphtheria bacilli, the production of soluble toxins can be readily demonstrated by filtering a culture in bouillon germ-free by means of a porcelain filter, and then injecting some of the filtrate into an animal. In this way the characteristic features of the disease can be reproduced. Such toxins being set free in the culture medium are often known as *extracellular*. In many cases, however, the filtrate, when injected, produces comparatively little effect, whilst toxic action is observed when the bacteria in a dead condition are used; this is the case with the organisms of tubercle, cholera, typhoid and many others. The toxins are here manifestly contained within the bodies of the bacteria, i.e. are *intracellular*, though they may become free on disintegration of the bacteria. The action of these intracellular toxins has in many instances nothing characteristic, but is merely in the direction of producing fever and interfering with the vital processes of the body generally, these disturbances often going on to a fatal result. In other words, the toxins of different bacteria are closely similar in their results on the body and the features of the corresponding diseases are largely regulated by the vital properties of the bacteria, their distribution in the tissues, &c. The distinction between the two varieties of toxins, though convenient, must not be pushed too far, as we know little regarding their mode of formation. Although the formation of toxins with characteristic action can be shown by the above methods, yet in some cases little or no toxic action can be demonstrated. This, for example, is the case with the anthrax bacillus; although the effect of this organism in the living body indicates the production of toxins which diffuse for a distance around the bacteria. This and similar facts have suggested that some toxins are only produced in the living body. A considerable amount of work has been done in connexion with this subject, and many observers have found that fluids taken from the living body in which the organisms have been growing, contain toxic substances, to which the name of *aggressins* has been applied. Fluid containing these aggressins greatly increases the toxic effect of the corresponding bacteria, and may produce death at an earlier stage than ever occurs with the bacteria alone. They also appear to have in certain cases a paralytic action on the cells which act as phagocytes. The

Inoculation.

Separation of toxins.

Bacteria as agents of disease.

work on this subject is highly suggestive, and opens up new possibilities with regard to the investigation of bacterial action within the body. Not only are the general symptoms of poisoning in bacterial disease due to toxic substances, but also the tissue changes, many of them of inflammatory nature, in the neighbourhood of the bacteria. Thus, to mention examples, diphtheria toxin produces inflammatory oedema which may be followed by necrosis; dead tubercle bacilli give rise to a tubercle-like nodule, &c. Furthermore, a bacillus may give rise to more than one toxic body, either as stages in one process of change or as distinct products. Thus paralysis following diphtheria is in all probability due to a different toxin from that which causes the acute symptoms of poisoning or possibly to a modification of it sometimes formed in specially large amount. It is interesting to note that in the case of the closely analogous example of snake venoms, there may be separated from a single venom a number of toxic bodies which have a selective action on different animal tissues.

Regarding the chemical nature of toxins less is known than regarding their physiological action. Though an enormous amount of work has been done on the subject, no important bacterial toxin has as yet been obtained in a pure condition, and, though many of them are probably of proteid nature, even this cannot be asserted with absolute certainty. Brieger, in his earlier work, found that alkaloids were formed by bacteria in a variety of conditions, and that some of them were poisonous. These alkaloids he called *ptomaines*. The methods used in the investigations were, however, open to objection, and it is now recognized that although organic bases may sometimes be formed, and may be toxic, the important toxins are not of that nature. A later research by Brieger along with Fraenkel pointed to the extracellular toxins of diphtheria, tetanus and other diseases being of proteid nature, and various other observers have arrived at a like conclusion. The general result of such research has been to show that the toxic bodies are, like proteids, precipitable by alcohol and various salts; they are soluble in water, are somewhat easily dialysable, and are relatively unstable both to light and heat. Attempts to get a pure toxin by repeated precipitation and solution have resulted in the production of a whitish amorphous powder with highly toxic properties. Such a powder gives a proteid reaction, and is no doubt largely composed of albumoses, hence the name *toxalbumoses* has been applied. The question has, however, been raised whether the toxin is really itself a proteid, or whether it is not merely carried down with the precipitate. Brieger and Boer, by precipitation with certain salts, notably of zinc, obtained a body which was toxic but gave no reaction of any form of proteid. There is of course the possibility in this case that the toxin was a proteid, but was in so small amount that it escaped detection. These facts show the great difficulty of the problem, which is probably insoluble by present methods of analysis; the only test, in fact, for the existence of a toxin is its physiological effect. It may also be mentioned that many toxins have now been obtained by growing the particular organism in a proteid-free medium, a fact which shows that if the toxin is a proteid it may be formed synthetically by the bacterium as well as by modification of proteid already present. With regard to the nature of intracellular toxins, there is even greater difficulty in the investigation and still less is known. Many of them, probably also of proteid nature, are much more resistant to heat; thus the intracellular toxins of the tubercle bacillus retain certain of their effects even after exposure to 100° C. Like the extracellular toxins they may be of remarkable potency; for example, fever is produced in the human subject by the injection into the blood of an extremely minute quantity of dead typhoid bacilli.

We cannot as yet speak definitely with regard to the part played by enzymes in these toxic processes. Certain toxins resemble enzymes as regards their conditions of precipitation and relative instability, and the fact that in most cases a considerable period intervenes between the time of injection and the occurrence of symptoms has been adduced in support of the view that enzymes are present. In the case of

diphtheria Sidney Martin obtained toxic albumoses in the spleen, which he considered were due to the digestive action of an enzyme formed by the bacillus in the membrane and absorbed into the circulation. According to this view, then, a part at least of the directly toxic substance is produced in the living body by enzymes present in the so-called toxin obtained from the bacterial culture. Recent researches go to show that enzymes play a greater part in fermentation by living ferments than was formerly supposed, and by analogy it is likely that they are also concerned in the processes of disease. But this has not been proved, and hitherto no enzyme has been separated from a pathogenic bacterium capable of forming, by digestive or other action, the toxic bodies from proteids outside the body. It is also to be noted that, as in the case of poisons of known constitution, each toxin has a minimum lethal dose which is proportionate to the weight of the animal and which can be ascertained with a fair degree of accuracy.

The action of toxins is little understood. It consists in all probability of disturbance, by means of the chemical affinities of the toxin, of the highly complicated molecules of living cells. This disturbance results in disintegration to a varying degree, and may produce changes visible on microscopic examination. In other cases such changes cannot be detected, and the only evidence of their occurrence may be the associated symptoms. The very important work of Ehrlich on diphtheria toxin shows that in the molecule of toxin there are at least two chief atom groups—one, the "haptophorous," by which the toxin molecule is attached to the cell protoplasm; and the other the "toxophorous," which has a ferment-like action on the living molecule, producing a disturbance which results in the toxic symptoms. On this theory, susceptibility to a toxin will imply both a chemical affinity of certain tissues for the toxin molecule and also sensitiveness to its actions, and, furthermore, non-susceptibility may result from the absence of either of these two properties.

A bacterial infection when analysed is seen to be of the nature of an intoxication. There is, however, another all-important factor concerned, viz. the multiplication of the living organisms in the tissues; this is essential to, and regulates, the supply of toxins. It is important that these two essential factors should be kept clearly in view, since the means of defence against any disease may depend upon the power either of neutralizing toxins or of killing the organisms producing them. It is to be noted that there is no fixed relation between toxin production and bacterial multiplication in the body, some of the organisms most active as toxin producers having comparatively little power of invading the tissues.

We shall now consider how bacteria may behave when they have gained entrance to the body, what effects may be produced, and what circumstances may modify the disease in any particular case. The extreme instance of bacterial invasion is found in some of the septicaemias in the lower animals, e.g. anthrax septicaemia in guinea-pigs, pneumococcus septicaemia in rabbits. In such diseases the bacteria, when introduced into the subcutaneous tissue, rapidly gain entrance to the blood stream and multiply freely in it, and by means of their toxins cause symptoms of general poisoning. A widespread toxic action is indicated by the lesions found—cloudy swelling, which may be followed by fatty degeneration, in internal organs, capillary haemorrhages, &c. In septicaemia in the human subject, often due to streptococci, the process is similar, but the organisms are found especially in the capillaries of the internal organs and may not be detectable in the peripheral circulation during life. In another class of diseases, the organisms first produce some well-marked local lesion, from which secondary extension takes place by the lymph or blood stream to other parts of the body, where corresponding lesions are formed. In this way secondary abscesses, secondary tubercle glanders and nodules, &c., result; in typhoid fever there is secondary invasion of the mesenteric glands, and clumps of bacilli are also found in internal organs, especially the spleen, though there may be little tissue change around them. In all such cases there is seen a selective character in the distribution of the lesions, some organs being in any disease much more liable to infection than others. In still

Nature of toxins.

Bacterial infection.

The production of disease.

another class of diseases the bacteria are restricted to some particular part of the body, and the symptoms are due to toxins which are absorbed from it. Thus in cholera the bacteria are practically confined to the intestine, in diphtheria to the region of the false membrane, in tetanus to some wound. In the last-mentioned disease even the local multiplication depends upon the presence of other bacteria, as the tetanus bacillus has practically no power of multiplying in the healthy tissues when introduced alone.

The effects produced by bacteria may be considered under the following heads: (1) tissue changes produced in the vicinity of the bacteria, either at the primary or secondary foci; (2) tissue changes produced at a distance by absorption of their toxins; (3) symptoms. The changes in the vicinity of bacteria are to be regarded partly as the *direct result* of the action of toxins on living cells, and partly as indicating a *reaction* on the part of the tissues. (Many such changes are usually grouped together under the heading of "inflammation" of varying degree—acute, subacute and chronic.) Degeneration and death of cells, haemorrhages, serous and fibrinous exudations, leucocyte emigration, proliferation of connective tissue and other cells, may be mentioned as some of the fundamental changes. Acute inflammation of various types, supuration, granulation-tissue formation, &c., represent some of the complex resulting processes. The changes produced at a distance by distribution of toxins may be very manifold—cloudy swelling and fatty degeneration, serous effusions, capillary haemorrhages, various degenerations of muscle, hyaline degeneration of small blood-vessels, and, in certain chronic diseases, waxy degeneration, all of which may be widespread, are examples of the effects of toxins, rapid or slow in action. Again, in certain cases the toxin has a special affinity for certain tissues. Thus in diphtheria changes in both nerve cells and nerve fibres have been found, and in tetanus minute alterations in the nucleus and protoplasm of nerve cells.

The lesions mentioned are in many instances necessarily accompanied by functional disturbances or clinical symptoms, varying according to site, and to the nature and degree of the affection. In addition, however, there occur in bacterial diseases symptoms to which the correlated structural changes have not yet been demonstrated. Amongst these the most important is fever with increased protein metabolism, attended with disturbances of the circulatory and respiratory systems. Nervous symptoms, somnolence, coma, spasms, convulsions and paralysis are of common occurrence. All such phenomena, however, are likewise due to the disturbance of the molecular constitution of living cells. Alterations in metabolism are found to be associated with some of these, but with others no corresponding physical change can be demonstrated. The action of toxins on various glands, producing diminished or increased functional activity, has a close analogy to that of certain drugs. In short, if we place aside the outstanding exception of tumour growth, we may say that practically all the important phenomena met with in disease may be experimentally produced by the injection of bacteria or of their toxins.

The result of the entrance of a virulent bacterium into the tissues of an animal is not a disease with hard and fast characters, but varies greatly with circumstances. With regard to the subject of infection the chief factor is susceptibility; with regard to the bacterium virulence is all-important. Susceptibility, as is well recognized, varies much under natural conditions in different species, in different races of the same species, and amongst individuals of the same race. It also varies with the period of life, young subjects being more susceptible to certain diseases, e.g. diphtheria, than adults. Further, there is the very important factor of acquired susceptibility. It has been experimentally shown that conditions such as fatigue, starvation, exposure to cold, &c., lower the general resisting powers and increase the susceptibility to bacterial infection. So also the local powers of resistance may be lowered by injury or depressed vitality. In this way conditions formerly

believed to be the causes of disease are now recognized as playing their part in predisposing to the action of the true causal agent, viz. the bacterium. In health the blood and internal tissues are bacterium-free; after death they offer a most suitable pabulum for various bacteria; but between these two extremes lie states of varying liability to infection. It is also probable that in a state of health organisms do gain entrance to the blood from time to time and are rapidly killed off. The circumstances which alter the virulence of bacteria will be referred to again in connexion with immunity, but it may be stated here that, as a general rule, the virulence of an organism towards an animal is increased by sojourn in the tissues of that animal. The increase of virulence becomes especially marked when the organism is inoculated from animal to animal in series, the method of *passage*. This is chiefly to be regarded as an adaptation to surroundings, though the fact that the less virulent members of the bacterial species will be liable to be killed off also plays a part. Conversely, the virulence tends to diminish on cultivation on artificial media outside the body, especially in circumstances little favourable to growth.

By immunity is meant non-susceptibility to a given disease, or to experimental inoculation with a given bacterium or toxin. The term must be used in a relative sense, and account must always be taken of the conditions present. An animal may be readily susceptible to a disease on experimental inoculation, and yet rarely or never suffer from it naturally, because the necessary conditions of infection are not supplied in nature. That an animal possesses natural immunity can only be shown on exposing it to such conditions, this being usually most satisfactorily done in direct experiment. Further, there are various degrees of immunity, and in this connexion conditions of local or general diminished vitality play an important part in increasing the susceptibility. Animals naturally susceptible may acquire immunity, on the one hand by successfully passing through an attack of the disease, or, on the other hand, by various methods of inoculation. Two chief varieties of artificial immunity are now generally recognized, differing chiefly according to the mode of production. In the first—*active immunity*—a reaction or series of reactions is produced in the body of the animal, usually by injections of bacteria or their products. The second—*passive immunity*—is produced by the transfusion of a quantity of the serum of an animal actively immunized to a fresh animal; the term is applied because there is brought into play no active change in the tissues of the second animal. The methods of active immunity have been practically applied in *preventive inoculation* against disease; those of passive immunity have given us *serum therapeutics*. The chief facts with regard to each may now be stated.

1. *Active Immunity*.—The key to the artificial establishment of active immunity is given by the fact long established that recovery from an attack of certain infective diseases is accompanied by protection for varying periods of time against a subsequent attack. Hence follows the idea of producing a modified attack of the disease as a means of prevention—a principle which had been previously applied in inoculation against smallpox. Immunity, however, probably results from certain substances introduced into the system during the disease rather than from the disease itself; for by properly adjusted doses of the poison (in the widest sense), immunity may result without any symptoms of the disease occurring. Of the chief methods used in producing active immunity the first is by inoculation with bacteria whose virulence has been diminished, i.e. with an "attenuated virus." Many of the earlier methods of attenuation were devised in the case of the anthrax bacillus, an organism which is, however, somewhat exceptional as regards the relative stability of its virulence. Many such methods consist, to speak generally, in growing the organism outside the body under somewhat unsuitable conditions, e.g. at higher temperatures than the optimum, in the presence of weak antiseptics, &c. The virulence of many organisms, however, becomes diminished when they are grown on the ordinary artificial media, and the diminution is sometimes accelerated by passing a current

of air over the surface of the growth. Sometimes also the virulence of a bacterium for a particular kind of animal becomes lessened on passing it through the body of one of another species. Cultures of varying degree of virulence may be obtained by such methods, and immunity can be gradually increased by inoculation with vaccines of increasing virulence. The immunity may be made to reach a very high degree by ultimately using cultures of intensified virulence, this "supervirulent" character being usually attained by the method of *passage* already explained. A second method is by injection of the bacterium in the dead condition, whereby immunity against the living organism may be produced. Here manifestly the dose may be easily controlled, and may be gradually increased in successive inoculations. This method has a wide application. A third method is by injections of the separated toxins of a bacterium, the resulting immunity being not only against the toxin, but, so far as present knowledge shows, also against the living organism. In the development of toxin-immunity the doses, small at first, are gradually increased in successive inoculations; or, as in the case of very active toxins, the initial injections are made with toxin modified by heat or by the addition of various chemical substances. Immunity of the same nature can be acquired in the same way against snake and scorpion poisons, and against certain vegetable toxins, *e.g.* ricin, abrin, &c.

In order that the immunity may reach a high degree, either the bacterium in a very virulent state or a large dose of toxin must ultimately be used in the injections. In such cases the immunity is, to speak generally, specific, *i.e.* applies only to the bacterium or toxin used in its production. A certain degree of non-specific immunity or increased tissue resistance may be produced locally, *e.g.* in the peritoneum, by injections of non-pathogenic organisms, peptone, nucleic acid and various other substances. In these cases the immunity is without specific character, and cannot be transferred to another animal. Lastly, in a few instances one organism has an antagonistic action to another; for example, the products of *B. pyocyaneus* have a certain protective action against *B. anthracis*. This method has, however, not yielded any important practical application.

2. *Passive Immunity: Anti-sera.*—The development of active immunity by the above methods is essentially the result of a reactive process on the part of the cells of the body, though as yet we know little of its real nature. It is, however, also accompanied by the appearance of certain bodies in the blood serum of the animal treated, to which the name of *anti-substances* is given, and these have been the subject of extensive study. It is by means of them that immunity (passive) can be transferred to a fresh animal. The development of anti-substances is, however, not peculiar to bacteria, but occurs also when alien cells of various kinds, proteins, ferments, &c., are injected. In fact, organic molecules can be divided into two classes according as they give rise to anti-substances or fail to do so. Amongst the latter, the vegetable poisons of known constitution, alkaloids, glucosides, &c., are to be placed. The molecules which lead to the production of anti-substances are usually known as antigens, and each antigen has a specific combining affinity for its corresponding anti-substance, fitting it as a lock does a key. The antigens, as already indicated, may occur in bacteria, cells, &c., or they may occur free in a fluid. Anti-substances may be arranged, as has been done by Ehrlich, into three main groups. In the first group, the anti-substance simply combines with the antigen, without, so far as we know, producing any change in it. The antitoxins are examples of this variety. In the second group, the anti-substance, in addition to combining with the antigen, produces some recognizable physical change in it; the precipitins and agglutinins may be mentioned as examples. In the third group, the anti-substance, after it has combined with the antigen, leads to the union of a third body called *complement* (*alexine* or *cytase* of French writers), which is present in normal serum. As a result of the union of the three substances, a dissolving or digestive action is often to be observed. This is the mode of action of the anti-substances in the case of a haemolytic or bacteriolytic serum. So far as bacterial immunity

is concerned, the anti-serum exerts its action either on the toxin or on the bacterium itself; that is, its action is either antitoxic or anti-bacterial. The properties of these two kinds of serum may now be considered.

The term "antitoxic" signifies that serum has the power of neutralizing the action of the toxin, as is shown by mixing them together outside the body and then injecting them into an animal. The antitoxic serum when injected previously to the toxin also confers immunity (passive) against it; when injected after the toxin it has within certain limits a curative action, though in this case its dose requires to be large. The antitoxic property is developed in a susceptible animal by successive and gradually increasing doses of the toxin. In the earlier experiments on smaller animals the potency of the toxin was modified for the first injections, but in preparing antitoxin for therapeutical purposes the toxin is used in its unaltered condition, the horse being the animal usually employed. The injections are made subcutaneously and afterwards intravenously; and, while the dose must be gradually increased, care must be taken that this is not done too quickly, otherwise the antitoxic power of the serum may fall and the health of the animal suffer. The serum of the animal is tested from time to time against a known amount of toxin, *i.e.* is standardized. The unit of antitoxin in Ehrlich's new standard is the amount requisite to antagonize 100 times the minimum lethal dose of a particular toxin to a guinea-pig of 250 grm. weight, the indication that the toxin has been antagonized being that a fatal result does not follow within five days after the injection. In the case of diphtheria the antitoxic power of the serum may reach 800 units per cubic centimetre, or even more. The laws of antitoxin production and action are not confined to bacterial toxins, but apply also to other vegetable and animal toxins, resembling them in constitution, *viz.* the vegetable toxalbumoses and the snake-venom group referred to above.

The production of antitoxin is one of the most striking facts of biological science, and two important questions with regard to it must next be considered, *viz.* how does the antitoxin act? and how is it formed within the body? Theoretically there are two possible modes of action: antitoxin may act by means of the cells of the body, *i.e.* indirectly or physiologically; or it may act directly on the toxin, *i.e.* chemically or physically. The second view may now be said to be established, and, though the question cannot be fully discussed here, the chief grounds in support of a direct action may be given. (a) The action of antitoxin on toxin, as tested by neutralization effects, takes place more quickly in concentrated than in weak solutions, and more quickly at a warm (within certain limits) than at a cold temperature. (b) Antitoxin acts more powerfully when injected along with the toxin than when injected at the same time in another part of the body; if its action were on the tissue-cells one would expect that the site of injection would be immaterial. For example, the amount necessary to neutralize five times the lethal dose being determined, twenty times that amount will neutralize a hundred times the lethal dose. In the case of physiological antagonism of drugs this relationship does not hold. (c) It has been shown by C. J. Martin and Cherry, and by A. A. Kantack and Cobbett, that in certain instances the toxin can be made to pass through a gelatine membrane, whereas the antitoxin cannot, its molecules being of larger size. If, however, toxin be mixed with antitoxin for some time, it can no longer be passed through, presumably because it has become combined with the antitoxin.

Lastly it may be mentioned that when a toxin has some action which can be demonstrated in a test-tube experiment, for example, a dissolving action on red corpuscles, this action may be annulled by previously adding the antitoxin to toxin; in such a case the intervention of the living tissues is excluded. In view of the fact that antitoxin has a direct action on toxin, we may say that theoretically this may take place in one of two ways. It may produce a disintegration of the toxin molecule, or it may combine with it to produce a body whose combining affinities are satisfied. The latter view, first advocated by

Antitoxic serum.

Action of antitoxin.

Ehrlich, harmonizes with the facts established with regard to toxic action and the behaviour of antitoxins, and may now be regarded as established. His view as to the dual composition of the toxin molecule has already been mentioned, and it is evident that if the haptophorous or combining group has its affinity satisfied by union with antitoxin, the toxin will no longer combine with living cells, and will thus be rendered harmless. One other important fact in support of what has been stated is that a toxin may have its toxic action diminished, and may still require the same amount of antitoxin as previously for neutralization. This is readily intelligible on the supposition that the toxophorous group is more labile than the haptophorous. There is, however, still dispute with regard to the exact nature of the union of toxin and antitoxin. Ehrlich's view is that the two substances form a firm combination like a strong acid and a base. He found, however, that if he took the largest amount of toxin which was just neutralized by a given amount of antitoxin, much more than a single dose of toxin had to be added before a single dose was left free. For example, if 100 doses of toxin were neutralized by a unit of antitoxin (*v. supra*) it might be that 125 doses would need to be added to the same amount of antitoxin before the mixture produced a fatal result when it was injected. This result, which is usually known now as the "Ehrlich phenomenon," was explained by him on the supposition that the "toxin" does not represent molecules which are all the same, but contains molecules of different degrees of combining affinity and of toxic action. Accordingly, the most actively toxic molecules will be neutralized first, and those which are left over, that is, uncombined with antitoxin, will have a weaker toxic action. This view has been assailed by Thorvald Madsen and S. A. Arrhenius, who hold that the union of toxin and antitoxin is comparatively loose, and belongs to the class of reversible reactions, being comparable in fact with the union of a weak acid and base. If such were the condition there would always be a certain amount both of free toxin and of free antitoxin in the mixture, and in this case also considerably more than a dose of toxin would have to be added to a "neutral mixture" before the amount of free toxin was increased by a dose, that is, before the mixture became lethal. It may be stated that while in certain instances the union of toxin and antitoxin may be reversible, all the facts established cannot be explained on this simple hypothesis of reversible action. Still another view, advocated by Bordet, is that the union of toxin and antitoxin is rather of physical than of strictly chemical nature, and represents an interaction of colloidal substances, a sort of molecular deposition by which the smaller toxin molecule becomes entangled in the larger molecule of antitoxin. Sufficient has been said to show that the subject is one of great intricacy, and no simple statement with regard to it is as yet possible. We are probably safe in saying, however, that the molecules of a toxin are not identical but vary in the degree of their combining affinities, and also in their toxic action, and that, while in some cases the combination of anti-substances has been shown to be reversible, we are far from being able to say that this is a general law.

The origin of antitoxin is of course merely a part of the general question regarding the production of anti-substances in general, as these all combine in the same way with their homologous substances and have the same character of specificity. As, however, most of the work has been done with regard to antitoxin production we may consider here the theoretical aspect of the subject. There are three chief possibilities: (a) that the antitoxin is a modification of the toxin; (b) that it is a substance normally present, but produced in excess under stimulation of the toxin; (c) that it is an entirely new product. The first of these, which would imply a process of a very remarkable nature, is disproved by what is observed after bleeding an animal whose blood contains antitoxin. In such a case it has been shown that, without the introduction of fresh toxin, new antitoxin appears, and therefore must be produced by the living tissues. The second theory is the more probable *a priori*, and if established removes the

necessity for the third. It is strongly supported by Ehrlich, who, in his so-called "side-chain" (*Seitenkette*) theory, explains antitoxin production as an instance of regeneration after loss. Living protoplasm, or in other words a biogen molecule, is regarded as consisting of a central atom group (*Leistungskern*), related to which are numerous secondary atom groups or side-chains, with unsatisfied chemical affinities. The side-chains constitute the means by which other molecules are added to the living molecule, e.g. in the process of nutrition. It is by means of such side-chains that toxin molecules are attached to the protoplasm, so that the living molecules are brought under the action of the toxophorous groups of the toxins. In antitoxin production this combination takes place, though not in sufficient amount to produce serious toxic symptoms. It is further supposed that the combination being of somewhat firm character, the side-chains thus combined are lost for the purposes of the cell and are therefore thrown off. By the introduction of fresh toxin the process is repeated and the regeneration of side-chains is increased. Ultimately the regeneration becomes an over-regeneration and free side-chains produced in excess are set free and appear in the blood as antitoxin molecules. In other words the substances, which when forming part of the cells fix the toxin to the cells, constitute antitoxin molecules when free in the serum. This theory, though not yet established, certainly affords the most satisfactory explanation at present available. In support of it there is the remarkable fact, discovered by A. Wassermann and Takaki in the case of tetanus, that there do exist in the nervous system molecules with combining affinity for the tetanus toxin. If, for example, the brain and spinal cord removed from an animal be bruised and brought into contact with tetanus toxin, a certain amount of the toxicity disappears, as shown by injecting the mixture into another animal. Further, these molecules in the nervous system present the same susceptibility to heat and other physical agencies as does tetanus antitoxin. There is therefore strong evidence that antitoxin molecules do exist as part of the living substance of nerve cells. It has, moreover, been found that the serum of various animals has a certain amount of antitoxic action, and thus the basis for antitoxin production, according to Ehrlich's theory, is afforded. The theory also supplies the explanation of the power which an animal possesses of producing various antitoxins, since this depends ultimately upon susceptibility to toxic action. The explanation is thus carried back to the complicated constitution of biogen molecules in various living cells of the body. It may be added that in the case of all the other kinds of anti-substances, which are produced by a corresponding reaction, we have examples of the existence of traces of them in the blood serum under normal conditions. We are, accordingly, justified in definitely concluding that their appearance in large amount in the blood, as the result of active immunization, represents an increased production of molecules which are already present in the body, either in a free condition in its fluids or as constituent elements of its cells.

In preparing anti-bacterial sera the lines of procedure correspond to those followed in the case of antitoxins, but the bacteria themselves in the living or dead condition or their maceration products are always used in the injections. Sometimes dead bacteria, living virulent bacteria, and living supervirulent bacteria, are used in succession, the object being to arrive ultimately at a high dosage, though the details vary in different instances. The serum of an animal thus actively immunized has powerful protective properties towards another animal, the amount necessary for protection being sometimes almost inconceivably small. As a rule it has no action on the corresponding toxin, i.e. is not antitoxic. In addition to the protective action, such a serum may possess activities which can be demonstrated outside the body. Of these the most important are (a) bacteriolytic or lysogenic action, (b) agglutinative action, and (c) opsonic action.

The first of these, lysogenic or bacteriolytic action, consists in

"Side-chain" theory.

Anti-bacterial serum.

Formulation of antitoxin.

the production of a change in the corresponding bacterium whereby it becomes granular, swells up and ultimately may undergo dissolution. Pfeiffer was the first to show that this occurred when the bacterium was injected into the peritoneal cavity of the animal immunized against it, and also when a little of the serum of such an animal was injected with the bacterium into the peritoneum of a fresh, *i.e.* non-immunized animal. Metchnikoff and Bordet subsequently devised means by which a similar change could be produced *in vitro*, and analysed the conditions necessary for its occurrence. It has been completely established that in this phenomenon of lysogenesis there are two substances concerned, one specially developed or developed in excess, and the other present in normal serum. The former (*Immunkörper* of Ehrlich, *substance sensibilisatrice* of Bordet) is the more stable, resisting a temperature of 60° C., and though giving the specific character to the reaction cannot act alone. The latter is ferment-like and much more labile than the former, being readily destroyed at 60° C. It may be added that the protective power is not lost by exposure to the temperature mentioned, this apparently depending upon a specific anti-substance. Furthermore, lysogenic action is not confined to the case of bacteria but obtains also with other organized structures, *e.g.* red corpuscles (Bordet, Ehrlich and Morgenroth), leucocytes and spermatozoa (Metchnikoff). That is to say, if an animal be treated with injections of these bodies, its serum acquires the power of dissolving or of producing some disintegrative effect in them. The development of the immune body with specific combining affinity thus presents an analogy to antitoxin production, the difference being that in lysogenesis another substance is necessary to complete the process. It can be shown that in many cases when bacteria are injected the serum of the treated animal has no bacteriolytic effect, and still an immune body is present, which leads to the fixation of complement; in this case bacteriolysis does not occur, because the organism is not susceptible to the action of the complement. In all cases the important action is the binding of complement to the bacterium by means of the corresponding immune body; whether or not death of the bacterium occurs, will depend upon its susceptibility to the action of the particular complement, the latter acting like a toxin or digestive ferment. It is to be noted that in the process of immunization complement does not increase in amount; accordingly the immune serum comes to contain immune body much in excess of the amount of complement necessary to complete its action. An important point with regard to the therapeutic application of an anti-bacterial serum, is that when the serum is kept *in vitro* the complement rapidly disappears, and accordingly the complement necessary for the production of the bactericidal action must be supplied by the blood of the patient treated. This latter complement may not suit the immune body, that is, may not be fixed to the bacterium by means of it, or if the latter event does occur, may fail to bring about the death of the bacteria. These circumstances serve, in part at least, to explain the fact that the success attending the use of anti-bacterial sera has been much inferior to that in the case of antitoxic sera.

Another property which may be possessed by an anti-bacterial serum is that of agglutination. By this is meant the aggregation into clumps of the bacteria uniformly distributed in an indifferer fluid; if the bacterium is motile its movement is arrested during the process. The process is of course observed by means of the microscope, but the clumps soon settle in the fluid and ultimately form a sediment, leaving the upper part clear. This change, visible to the naked eye, is called *sedimentation*. B. J. A. Charrin and G. E. H. Roger first showed in the case of *B. pyocyaneus* that when a small quantity of the homologous serum (*i.e.* the serum of an animal immunized against the bacterium) was added to a fluid culture of this bacillus, growth formed a sediment instead of a uniform turbidity. Gruber and Durham showed that sedimentation occurred when a small quantity of the homologous serum was added to an emulsion of the bacterium in a small test-tube, and

found that this obtained in all cases where Pfeiffer's lysogenic action could be demonstrated. Shortly afterwards Widal and also Grönbaum showed that the serum of patients suffering from typhoid fever, even at an early stage of the disease, agglutinated the typhoid bacillus—a fact which laid the foundation of serum diagnosis. A similar phenomenon has been demonstrated in the case of Malta fever, cholera, plague, infection with *B. coli*, "meat-poisoning" due to Gärtner's bacillus, and various other infections. As regards the mode of action of agglutinins, Gruber and Durham considered that it consists in a change in the envelopes of the bacteria, by which they swell up and become adhesive. The view has various facts in its support, but F. Kruse and C. Nicolle have found that if a bacterial culture be filtered germ-free, an agglutinating serum still produces some change in it, so that particles suspended in it become gathered into clumps. E. Duclaux, for this reason, considers that agglutinins are coagulative ferments.

The phenomenon of agglutination depends essentially on the union of molecules in the bacteria—the agglutinogens—with the corresponding agglutinins, but another essential is the presence of a certain amount of salts in the fluid, as it can be shown that when agglutinated masses of bacteria are washed salt-free the clumps become resolved. The fact that agglutinins appear in the body at an early stage in a disease has been taken by some observers as indicating that they have nothing to do with immunity, their development being spoken of as a reaction of infection. This conclusion is not justified, as we must suppose that the process of immunization begins to be developed at an early period in the disease, that it gradually increases, and ultimately results in cure. It should also be stated that agglutinins are used up in the process of agglutination, apparently combining with some element of the bacterial structure. In view of all the facts it must be admitted that the agglutinins and immune bodies are the result of corresponding reactive processes, and are probably related to one another. The development of all antagonistic substances which confer the special character on antimicrobial sera, as well as antitoxins, may be expressed as the formation of bodies with specific combining affinity for the organic substance introduced into the system— toxin, bacterium, red corpuscle, &c., as the case may be. The bacterium, being a complex organic substance, may thus give rise to more than one antagonistic or combining substance.

By opsonic action is meant the effect which a serum has on bacteria in making them more susceptible to phagocytosis by the white corpuscles of the blood (*q.v.*). Such an effect may be demonstrated outside the body by making a (c) *Opsonic action*. suitable mixture of (a) a suspension of the particular bacterium, (b) the serum to be tested, and (c) leucocytes of a normal animal or person. The mixture is placed in a thin capillary tube and incubated at 37° C. for half an hour; a film preparation is then made from it on a glass slide, stained by a suitable method and then examined microscopically. The number of bacteria contained within a number of, say fifty, leucocytes can be counted and the average taken. In estimating the opsonic power of the serum in cases of disease a control with normal serum is made at the same time and under precisely the same conditions. The average number of bacteria contained within leucocytes in the case tested, divided by the number given by the normal serum, is called the *phagocytic index*. Wright and Douglas showed that under these conditions phagocytosis might occur when a small quantity of normal serum was present, whereas it was absent when normal salt solution was substituted for the serum; the latter thus contained substances which made the organisms susceptible to the action of the phagocytosis. They further showed that this substance acted by combining with the organisms and apparently producing some alteration in them; on the other hand it had no direct action on the leucocytes. This opsonin of normal serum is very labile, being rapidly destroyed at 55° C.; that is, a serum heated at this temperature has practically no greater effect in aiding phagocytosis than normal salt solution has. Various observers had previously found that the serum of an animal immunized against

(a) *Lysogenic action.*

(b) *Agglutination.*

(c) *Opsonic action.*

a particular bacterium had a special action in bringing about phagocytosis of that organism, and it had been found that this property was retained when the serum was heated at 55° C. It is now generally admitted that at least two distinct classes of substances are concerned in opsonic action, that thermostable immune opsonins are developed as a result of active immunization and these possess the specific properties of anti-substances in general, that is, act only on the corresponding bacterium. On the contrary the labile opsonins of normal serum have a comparatively general action on different organisms. It is quite evident that the specific immune-opsonins may play a very important part in the phenomena of immunity, as by their means the organisms are taken up more actively by the phagocytic cells, and thereafter may undergo rapid disintegration.

The opsonic action of the serum has been employed by Sir A. Wright and his co-workers to control the treatment of bacterial infections by vaccines; that is, by injections of varying amounts of a dead culture of the corresponding bacterium. The object in such treatment is to raise the opsonic index of the serum, this being taken as an indication of increased immunity. The effect of the injection of a small quantity of vaccine is usually to produce an increase in the opsonic index within a few days. If then an additional quantity of vaccine be injected there occurs a fall in the opsonic index (negative phase) which, however, is followed later by a rise to a higher level than before. If the amounts of vaccine used and the times of the injection are suitably chosen, there may thus be produced by a series of steps a rise of the opsonic index to a high level. One of the chief objects in registering the opsonic power in such cases is to avoid the introduction of additional vaccine when the opsonic index is low, that is, during the negative phase, as if this were done a further diminution of the opsonic action might result. The principle in such treatment by means of vaccines is to stimulate the general production of anti-substances throughout the body, so that these may be carried to the sites of bacterial growth, and aid the destruction of the organisms by means of the cells of the tissues. A large number of favourable results obtained by such treatment controlled by the observation of the opsonic index have already been published, but it would be unwise at present to offer a decided opinion as to the ultimate value of the method.

Active immunity has thus been shown to be associated with the presence of certain anti-substances in the serum. After these substances have disappeared, however, as they always do in the course of time, the animal still possesses immunity for a varying period. This apparently depends upon some alteration in the cells of the body, but its exact nature is not known.

The destruction of bacteria by direct cellular agency both in natural and acquired immunity must not be overlooked.

Phagocytosis. The behaviour of certain cells, especially leucocytes, in infective conditions led Metchnikoff to place great importance on phagocytosis. In this process there are two factors concerned, viz. the ingestion of bacteria by the cells, and the subsequent intracellular digestion. If either of these is wanting or interfered with, phagocytosis will necessarily fail as a means of defence. As regards the former, leucocytes are guided chiefly by chemiotaxis, *i.e.* by sensitiveness to chemical substances in their surroundings—a property which is not peculiar to them but is possessed by various unicellular organisms, including motile bacteria. When the cell moves from a less to a greater degree of concentration, *i.e.* towards the focus of production, the chemiotaxis is termed positive; when the converse obtains, negative. This apparently purposive movement has been pointed out by M. Verworn to depend upon stimulation to contraction or the reverse. Metchnikoff showed that in animals immune to a given organism phagocytosis is present, whereas in susceptible animals it is deficient or absent. He also showed that the development of artificial immunity is attended by the appearance of phagocytosis; also, when an anti-serum is injected into an animal, the phagocytes which formerly were indifferent might move towards and destroy the bacteria. In the light of all the facts, however, especially those

with regard to anti-bacterial sera, the presence of phagocytosis cannot be regarded as the essence of immunity, but rather the evidence of its existence. The increased ingestion of bacteria in active immunity would seem to depend upon the presence of immune opsonins in the serum. These, as already explained, are true anti-substances. Thus the apparent increased activity of the leucocytes is due to a preliminary effect of the opsonins on the bacteria. We have no distinct proof that there occurs in active immunity any education of the phagocytes, in Metchnikoff's sense, that is, any increase of the inherent ingestive or digestive activity of these cells. There is some evidence that in certain cases anti-substances may act upon the leucocytes, and to these the name of "stimulins" has been given. We cannot, however, say that these play an important part in immunity, and even if it were so, the essential factor would be the development of the substances which act in this way. While in immunity there probably occurs no marked change in the leucocytes themselves, it must be admitted that the increased destruction of bacteria by these cells is of the highest importance. This, as already pointed out, depends upon the increase of opsonins, though it is also to be noted that in many infective conditions there is another factor present, namely leucocytosis, that is, an increase of the leucocytes in the blood, and the defensive powers of the body are thereby increased. Evidence has been brought forward within recent years that the leucocytes may constitute an important source of the antagonistic substances which appear in the serum. Much of such evidence possesses considerable weight, and seeing that these cells possess active digestive powers it is by no means improbable that substances with corresponding properties may be set free by them. To ascribe such powers to them exclusively is, however, not justifiable. Probably the lining endothelium of the blood-vessels as well as other tissues of the body participate in the production of anti-substances.

The subject of artificial immunity has occupied a large proportion of bacteriological literature within recent years, and our endeavour has been mainly to indicate the general laws which are in process of evolution. When the facts of natural immunity are examined, we find that **Natural Immunity.** no single explanation is possible. Natural immunity against toxins must be taken into account, and, if Ehrlich's view with regard to toxic action be correct, this may depend upon either the absence of chemical affinity of the living molecules of the tissues for the toxic molecule, or upon insensitiveness to the action of the toxophorous group. It has been shown with regard to the former, for example, that the nervous system of the fowl, which possesses immunity against tetanus toxin, has little combining affinity for it. The non-sensitiveness of a cell to a toxic body when brought into immediate relationship cannot, however, be explained further than by saying that the disintegrative changes which underlie symptoms of poisoning are not brought about. Then as regards natural powers of destroying bacteria, phagocytosis aided by chemiotaxis plays a part, and it can be understood that an animal whose phagocytes are attracted by a particular bacterium will have an advantage over one in which this action is absent. Variations in chemiotaxis towards different organisms probably depend in natural conditions, as well as in active immunity, upon the opsonic content of the serum. Whether bacteria will be destroyed or not after they have been ingested by the leucocytes will depend upon the digestive powers of the latter, and these probably vary in different species of animals. The blood serum has a direct bactericidal action on certain bacteria, as tested outside the body, and this also varies in different animals. Observations made on this property with respect to the anthrax bacillus at first gave the hope that it might explain variations in natural immunity. Thus the serum of the white rat, which is immune to anthrax, kills the bacillus; whereas the serum of the guinea-pig, which is susceptible, has no such effect. Further observations, however, showed that this does not hold as a general law. The serum of the susceptible rabbit, for example, is bactericidal to this organism, whilst the serum of the immune dog is not. In the case of the latter animal the serum

contains an opsonin which leads to phagocytosis of the bacillus, and the latter is then destroyed by the leucocytes. It is quite evident that bactericidal action as tested *in vitro* outside the body does not correspond to the degree of immunity possessed by the animal under natural conditions. We may say, however, that there are several factors concerned in natural immunity, of which the most important may be said to be the three following, viz. variations in the bactericidal action of the serum *in vivo*, variations in the chemiotactic or opsonic properties of the serum *in vivo*, and variations in the digestive properties of the leucocytes of the particular animal. It is thus evident that the explanation of natural immunity in any given instance may be a matter of difficulty and much complexity.

AUTHORITIES.—Bacteriological literature has become so extensive that it is impossible to give here references to original articles, even the more important. A number of these, giving an account of classical researches, were translated from French and German, and published by the New Sydenham Society under the title *Micro-parasites in Disease: Selected Essays*, in 1886. The following list contains some of the more important books published within recent years. Abbott, *Principles of Bacteriology* (7th ed., London, 1905); Crookshank, *Bacteriology and Infective Diseases* (with bibliography, 4th ed., London, 1896); Duclaux, *Traité de microbiologie* (Paris, 1899-1900); Eyre, *Bacteriological Technique* (Philadelphia and London, 1902); Flügel, *Die Mikroorganismen* (3rd ed., Leipzig, 1896); Fischer, *Vorlesungen über Bakterien* (2nd ed., Jena, 1902); Günther, *Einführung in das Studium der Bakteriologie* (6th ed., Leipzig, 1906); Hewlett, *Manual of Bacteriology* (2nd ed., London, 1902); Hueppe, *Principles of Bacteriology* (translation, London, 1899); Klein, *Micro-organisms and Disease* (3rd ed., London, 1896); Kollé and Wassermann, *Handbuch der pathogenen Mikroorganismen* (Jena, 1904) (supplements are still being published; this is the most important work on the subject); Löffler, *Vorlesungen über die geschichtliche Entwicklung der Lehre von der Bakterien* (Leipzig, 1887); M'Farland, *Text-book upon the Pathogenic Bacteria* (5th ed., London, 1906); Muir and Ritchie, *Manual of Bacteriology* (with bibliography, 4th ed., Edin. and Lond., 1908); Park, *Pathogenic Micro-organisms* (London, 1906); Sternberg, *Manual of Bacteriology* (with full bibliography, 2nd ed., New York, 1896); Woodcock, *Bacteria and their products* (with bibliography, London, 1891). The bacteriology of the infective diseases (with bibliography) is fully given in the *System of Medicine*, edited by Clifford Allbutt, (2nd ed., London, 1907). For references consult *Centraltbl. für Bakter. u. Parasitenk.* (Jena); also *Index Medicus*. The most important works on immunity are: Ehrlich, *Studies in Immunity* (English translation, New York, 1906), and Metchnikoff, *Immunity in Infective Diseases* (English translation, Cambridge, 1905). (R. M. *)

BACTRIA (*Bacriana*), the ancient name of the country between the range of the Hindu Kush (Paropamisus) and the Oxus (Amu Darya), with the capital Bactra (now Balkh); in the Persian inscriptions Bākhtri. It is a mountainous country with a moderate climate. Water is abundant and the land is very fertile. Bactria was the home of one of the Iranian tribes (see PERSIA: *Ancient History*). Modern authors have often used the name in a wider sense, as the designation of the whole eastern part of Iran. As there can be scarcely any doubt that it was in these regions, where the fertile soil of the mountainous country is everywhere surrounded and limited by the Turanian desert, that the prophet Zoroaster preached and gained his first adherents, and that his religion spread from here over the western parts of Iran, the sacred language in which the Avesta, the holy book of Zoroastrianism, is written, has often been called "old Bactrian." But there is no reason for this extensive use of the name, and the term "old Bactrian" is, therefore, at present completely abandoned by scholars. Still less foundation exists for the belief, once widely spread, that Bactria was the cradle of the Indo-European race; it was based on the supposition that the nations of Europe had immigrated from Asia, and that the Aryan languages (Indian and Iranian) stood nearest to the original language of the Indo-Europeans. It is now acknowledged by all linguists that this supposition is quite wrong, and that the Aryans probably came from Europe. The eastern part of Iran seems to have been the region where the Aryans lived as long as they formed one people, and whence they separated into Indians and Iranians.

The Iranian tradition, preserved in the Avesta and in Firdousi's *Shahname*, localizes a part of its heroes and myths in the east of Iran, and has transformed the old gods who fight with the great

snake into kings of Iran who fight with the Turanians. Many modern authors have attempted to make history out of these stories, and have created an old Bactrian empire of great extent, the kings of which had won great victories over the Turanians: But this historical aspect of the myth is of late origin: it is nothing but a reflex of the great Iranian empire founded by the Achaemenids and restored by the Sassanids. The only historical fact which we can learn from the Iranian tradition is that the contrast and the feud between the peasants of Iran and the nomads of Turan was as great in old times as it is now: it is indeed based upon the natural geographical conditions, and is therefore eternal. But a great Bactrian empire certainly never existed; the Bactrians and their neighbours were in old times ruled by petty local kings, one of whom was Vishtaspa, the protector of Zoroaster. Ctesias in his history of the Assyrian empire (Diodor. Sic. ii. 6 ff.) narrates a war waged by Ninus and Scmiran, against the king of Bactria (whom some later authors, e.g. Justin i. 1, call Zoroaster). But the whole Assyrian history of Ctesias is nothing but a fantastic fiction; from the Assyrian inscriptions we know that the Assyrians never entered the eastern parts of Iran.

Whether Bactria formed part of the Median empire, we do not know; but it was subjugated by Cyrus and from then formed one of the satrapies of the Persian empire. When Alexander had defeated Darius III., his murderer Bessus, the satrap of Bactria, tried to organize a national resistance in the east. But Bactria was conquered by Alexander without much difficulty; it was only farther in the north, beyond the Oxus, in Sogdiana, that he met with strong resistance. Bactria became a province of the Macedonian empire, and soon came under the rule of Seleucus, king of Asia (see SELEUCID DYNASTY and HELLENISM). The Macedonians (and especially Seleucus I. and his son Antiochus I.) founded a great many Greek towns in eastern Iran, and the Greek language became for some time dominant there. The many difficulties against which the Seleucid kings had to fight and the attacks of Ptolemy II., gave to Diodotus, satrap of Bactria, the opportunity of making himself independent (about 255 B.C.) and of conquering Sogdiana. He was the founder of the Graeco-Bactrian kingdom. Diodotus and his successors were able to maintain themselves against the attacks of the Seleucids; and when Antiochus III., "the Great," had been defeated by the Romans (190 B.C.), the Bactrian king Euthydemus and his son Demetrius crossed the Hindu Kush and began the conquest of eastern Iran and the Indus valley. For a short time they wielded great power; a great Greek empire seemed to have arisen far in the East. But this empire was torn by internal dissensions and continual usurpations. When Demetrius advanced far into India one of his generals, Eucratides, made himself king of Bactria, and soon in every province there arose new usurpers, who proclaimed themselves kings and fought one against the other. Most of them we know only by their coins, a great many of which are found in Afghanistan and India. By these wars the dominant position of the Greeks was undermined even more quickly than would otherwise have been the case. After Demetrius and Eucratides, the kings abandoned the Attic standard of coinage and introduced a native standard; at the same time the native language came into use by the side of the Greek. On the coins struck in India, the well-known Indian alphabet (called Brahmi by the Indians, the older form of the Devanagari) is used; on the coins struck in Afghanistan and in the Punjab the Kharoshthi alphabet, which is derived directly from the Aramaic and was in common use in the western parts of India, as is shown by one of the inscriptions of Asoka and by the recent discovery of many fragments of Indian manuscripts, written in Kharoshthi, in eastern Turkestan (formerly this alphabet has been called Aric or Bactrian Pali; the true name is derived from Indian sources).

The weakness of the Graeco-Bactrian kingdoms was shown by their sudden and complete overthrow. In the west the Arsacid empire had risen, and Mithradates I. and Phraates II. began to conquer some of their western districts, especially Areia (Herat). But in the north a new race appeared, Mongolian tribes, called

Scythians by the Greeks, amongst which the Tochari, identical with the Yue-chi (*q.v.*) of the Chinese, were the most important. In 150 B.C., according to Chinese sources, they entered Sogdiana, in 139 they conquered Bactria, and during the next generation they had made an end to the Greek rule in eastern Iran. Only in India the Greek conquerors (Menander, Apollodotus) maintained themselves some time longer. But in the middle of the 1st century B.C. the whole of eastern Iran and western India belonged to the great "Indo-Scythian" empire. The ruling dynasty had the name Kushan (Kushana), by which they are called on their coins and in the Persian sources. The most famous of these kings is Kanishka (*ca.* 123-153), the great protector of Buddhism. The principal seat of the Tochari and the Kushan dynasty seems to have been Bactria; but they always maintained the eastern parts of modern Afghanistan and Baluchistan, while the western regions (Aria, *i.e.* Herat, Seistan and part of the Helmund valley) were conquered by the Arsacids. In the 3rd century the Kushan dynasty began to decay; about A.D. 320 the Gupta empire was founded in India. Thus the Kushanas were reduced to eastern Iran, where they had to fight against the Sassanids. In the 5th century a new people came from the east, the Ephthalites (*q.v.*) or "white Huns," who subjected Bactria (about 450); and they were followed by the Turks, who first appear in history about A.D. 560 and subjugated the country north of the Oxus. Most of the small principalities of the Tochari or Kushan became subject to them. But when the Sassanian empire was overthrown by the Arabs, the conquerors immediately advanced eastwards, and in a few years Bactria and the whole Iran to the banks of the Jaxartes had submitted to the rule of the caliph and of Islam.

BIBLIOGRAPHY.—For the earlier times see PERSIA. For the Graeco-Bactrian and Indo-Scythian kingdoms see (beside articles on the separate kings):—H. H. Wilson, *Ariana Antiqua* (1841); Cunningham, "The Greeks of Bactriana, Ariana and India" in *Nusimatic Chronicle*, N. Ser. viii-xii.; A. von Sallet, *Die Nachfolger Alexanders des Grossen in Baktrien und Indien* (1879); P. Gardner, *The Coins of the Great and Scythic Kings of India* (1886, Catalogue of Coins in the British Museum, x.); A. von Gutschmid, *Geschichte Irans und seiner Nachbarländer von Alexander dem Grossen bis zum Untergang der Arsaciden* (1888); A. Stein, "Zoroastrian Deities on Indo-Scythian Coins," *Babylonian and Oriental Record*, I. 1887 (cf. Cunningham, *ib. id.* 1888); Vincent A. Smith, "The Kushan or Indo-Scythian Period of Indian History," *Journal of the R. Asiatic Soc.*, 1903 (cf. his *Early History of India*, 2nd ed. 1908); W. W. Tarn, "Notes on Hellenism in Bactria and India" in *Journal of Hellenic Studies*, xxii, 1902. For the history and character of the Indian alphabet cf. J. Bühler, "Indische Paläographie" in *Grundriss der indo-irischen Philologie*, Bd. I.). From the Greek authors only a few notices have been preserved, especially by Justin (and in the prologues of Trogus) and Strabo; for the later times we get some information from the Byzantine authors and from Persian and Armenian sources; cf. Th. Nöldeke's translation of Tabari (*Geschichte der Perser und Araber zur Zeit der Sasaniden*, 1890) and J. Marquart, "Eränsahr" (*Abhandlungen der königlichen Ges. d. Wissenschaften zu Göttingen*, 1901). The Chinese sources are given by Deguignes, "Recherches sur quelques événements qui concernent l'histoire des rois grecs de la Bactriane," *Mém. de l'Acad. des inscriptions*, xxv. A. E. Specht, "Eudes sur l'Asie centrale d'après les historiens chinois," in *Journal asiatique*, 8^e série, ii, 1883, 9^e série, x. 1897; Sylvain Lévi, "Notes sur les Indo-scythiens," *Journal asiatique*, 9^e série ix, x, and others. (Ed. M.)

BACUP, a market town and municipal borough in the Rossendale parliamentary division of Lancashire, England, on the river Irwell, 203 m. N.N.W. from London, and 22 N. by E. from Manchester, on the Lancashire & Yorkshire railway. Pop. (1901) 22,505. It is finely situated in a narrow valley, surrounded by wild, high-lying moorland. It is wholly of modern growth, and contains several handsome churches and other buildings, while among institutions the chief is the mechanics' institute and library. The recreation grounds presented in 1893 by Mr. J. H. Maden, M.P., are beautifully laid out. Cotton spinning and power-loom weaving are the chief of numerous manufacturing industries, and there are large collieries in the vicinity. The principle of co-operation is strongly developed, and a large and handsome store contains among other departments a free library for members. The borough was incorporated in 1882, and the corporation consists of a mayor, 6 aldermen and 17 councillors. Area, 6120 acres. In 1841 the population of the chapelry was only 1526.

One of the hills in the vicinity is fortified with a great ancient earthwork and ditch.

BADAGAS (literally "a Telugu man"), a tribe inhabiting the Nilgiri Hills, in India, by some authorities declared not to be an aboriginal or jungle race. They are probably Dravidian by descent, though they are in religion Hindus of the Saiva sect. They are supposed to have migrated to the Nilgiris from Mysore about A.D. 1600, after the breaking up of the kingdom of Vijayanagar. They are an agricultural people and far the most numerous and wealthy of the hill tribes. They pay a tribute in grain, &c., to the Todys. Their language is a corrupt form of Kanarese. At the census of 1901 they numbered 34,178.

See J. W. Breeks, *An Account of the Primitive Tribes of the Nilgiris* (1873); *Nilgiri Manual*, vol. i. pp. 218-228; *Madras Journ. of Sci. and Lit. vol. viii.* pp. 103-105; *Madras Museum Bulletin*, vol. ii., no. 1, pp. 1-7.

BADAJOZ (formerly sometimes written Badajos), a frontier province of western Spain, formed in 1833 of districts taken from the province of Estremadura (*q.v.*), and bounded on the N. by Cáceres, E. by Cordova and Ciudad Real, S. by Seville and Huelva, and W. by Portugal. Pop. (1900) 520,246; area, 8451 sq. m. Badajoz is thus the largest province of the whole kingdom. Although in many districts there are low ranges of hills, the surface is more often a desolate and monotonous plain, flat or slightly undulating. Its one large river is the Guadiana, which traverses the north of the province from east to west, fed by many tributaries; but it is only at certain seasons that the river-beds fill with any considerable volume of water, and the Guadiana may frequently be forded without difficulty. The climate shows great extremes of heat in summer and of cold in winter, when fierce north and north-west winds blow across the plains. In the hot months intermittent fevers are prevalent in the Guadiana valley. The rainfall is scanty in average years, and only an insignificant proportion of the land is irrigated, while the rest is devoted to pasture, or covered with thin bush and forest. Agriculture, and the cultivation of fruit, including the vine and olive, are thus in a very backward condition; but Badajoz possesses more livestock than any other Spanish province. Its acorn-fed swine are celebrated throughout Spain for their hams and bacon, and large herds of sheep and goats thrive where the pasture is too meagre for cattle. The exploitation of the mineral resources of Badajoz is greatly hindered by lack of water and means of communication; in 1903, out of nearly 600 mines registered only 26 were at work. Their output consisted of lead, with very small quantities of copper. The local industries are not of much importance; they comprise manufactures of woollen and cotton stuffs of a coarse description, soaps, oils, cork and leather. The purely commercial interests are more important than the industrial, because of the transit trade to and from Portugal through no less than seven custom-houses. Many parts of the province are inaccessible except by road, and the roads are ill-made, ill-kept and wholly insufficient. The main line of the Madrid-Lisbon railway passes through Villanueva de la Serena, Mérida and Badajoz; at Mérida it is joined by the railways going north to Cáceres and south to Zafrá, where the lines from Huelva and Seville unite. After Badajoz, the capital (pop. (1900) 30,899), the principal towns are Almedrales (12,587), Azuaga (14,192), Don Benito (16,565), Jerez de los Caballeros (10,271), Mérida (11,168) and Villanueva de la Serena (13,489); these, and also the historically interesting village of Albuera, are described in separate articles. Other small towns, chiefly important as markets for agricultural produce, are Albuquerque (9030), Cabeza del Buey (7566), Campanario (7450), Fregenal de la Sierra (9615), Fuente de Cantos (8483), Fuente del Maestre (6934), Llerena (7049), Montijo (7644), Oliva de Jerez (8348), Olivenza (9066), San Vicente de Alcántara (7722), and Villafraña de los Barros (9954). Very few inhabitants emigrate from this province, where the birth-rate considerably exceeds the death-rate. Education, even primary, is in a very backward condition.

BADAJOZ, the capital of the Spanish province described above; situated close to the Portuguese frontier, on the left

bank of the river Guadiana, and the Madrid-Lisbon railway. Pop. (1900) 30,809. Badajoz is the see of a bishop, and the official residence of the captain-general of Estremadura. It occupies a slight eminence, crowned by the ruins of a Moorish castle, and overlooking the Guadiana. A strong wall and bastions, with a broad moat and outworks, and forts on the surrounding heights, give the city an appearance of great strength. The river, which flows between the castle-hill and the powerfully armed fort of San Cristóbal, is crossed by a magnificent granite bridge, originally built in 1460, repaired in 1597 and rebuilt in 1833. The whole aspect of Badajoz recalls its stormy history; even the cathedral, built in 1258, resembles a fortress, with massive embattled walls. Badajoz was the birthplace of the statesman Manuel de Godoy, duke of Alcúdia (1767-1851), and of the painter Luis de Morales (1509-1586). Two pictures by Morales, unfortunately retouched in modern times, are preserved in the cathedral. Owing to its position the city enjoys a considerable transit trade with Portugal; its other industries include the manufacture of linen, woollen and leather goods, and of pottery. It is not mentioned by any Roman historian, and first rose to importance under Moorish rule. In 1031 it became the capital of a small Moorish kingdom, and, though temporarily held by the Portuguese in 1168, it retained its independence until 1220, when it was captured by Alphonso IX. of Leon. As a frontier fortress it underwent many sieges. It was beleaguered by the Portuguese in 1660, and in 1705 by the Allies in the War of the Spanish Succession. During the Peninsular War Badajoz was unsuccessfully attacked by the French in 1808 and 1809; but on the 10th of March 1811, the Spanish commander, José Imaz, was bribed into surrendering to the French force under Marshal Soult. A British army, commanded by Marshal Beresford, endeavoured to retake it, and on the 16th of May defeated a relieving force at Albuera, but the siege was abandoned in June. The fortress was finally stormed on the 6th of April 1812, by the British under Lord Wellington, and carried with terrible loss. It was then delivered up to a two day's pillage. A military and republican rising took place here in August 1883, but completely failed.

BADAKSHAN, including **WAKHAN**, a province on the north-east frontier of Afghanistan, adjoining Russian territory. Its north-eastern boundaries were decided by the Anglo-Russian agreement of 1873, which expressly acknowledged "Badakshan with its dependent district Wakhan" as "fully belonging to the amir of Kabul," and limited it to the left or southern bank of the Oxus. Much of the interior of the province is still unexplored. On the west, Badakshan is bounded by a line which crosses the Turkestan plains southwards from the junction of the Kunduz and Oxus rivers till it touches the eastern water-divide of the Tashkurgan river (here called the Koh-i-Chungar), and then runs south-east, crossing the Sarkhab affluent of the Khanabad (Kunduz), till it strikes the Hindu Kush. The southern boundary is carried along the crest of the Hindu Kush as far as the Khawak pass, leading from Badakshan into the Panjshir valley. Beyond this it is indefinite. It is known that the Kafirs occupy the crest of the Hindu Kush eastwards of the Khawak, but how far they extend north of the main watershed is not ascertainable. The southern limits of Badakshan become definite again at the Dorah pass. The Dorah connects Zebak and Ishkashim at the elbow, or bend, of the Oxus with the Lutku valley leading to Chitral. From the Dorah eastwards the crest of the Hindu Kush again becomes the boundary till it effects a junction with the Muztagh and Sarikol ranges, which shut off China from Russia and India. Skirting round the head of the Tagdumbash Pamir, it finally merges into the Pamir boundary, and turns westwards, following the course of the Oxus, to the junction of that river and the Khanabad (Kunduz). So far as the northern boundary follows the Oxus stream, under the northern slopes of the Hindu Kush, it is only separated by the length of these slopes (some 8 or 10 m.) from the southern boundary along the crest. Thus Badakshan reaches out an arm into the Pamirs eastwards—bottle-shaped—narrow at the neck (represented by the northern slopes of the Hindu Kush), and

swelling out eastwards so as to include a part of the great and little Pamirs. Before the boundary settlement of 1873 the small states of Roshan and Shignan extended to the left bank of the Oxus, and the province of Darwaz, on the other hand, extended to the right bank. Now, however, the Darwaz extension northwards is exchanged for the Russian Pamir extension westwards, and the river throughout is the boundary between Russian and Afghan territory; the political boundaries of those provinces and those of Wakhan being no longer coincident with their geographical limits.

The following are the chief provincial subdivisions of Badakshan, omitting Roshan and Shignan:—On the west Rustak, Kataghan, Ghor, Narin and Anderab; on the north Darwaz, Ragh and Shiwa; on the east Charan, Ishkashim, Zebak and Wakhan; and in the centre Faizabad, Farkhar, Minjan and Kishm. There are others, but nothing certain is known about these minor subdivisions.

The conformation of the mountain districts, which comprise all the southern districts of Badakshan and the northern hills and valleys of Kafirstan, is undoubtedly analogous to that of the rest of the Hindu Kush westwards. The water-divide of the Hindu Kush from the Dorah to the Khawak pass, i.e. through the centre of Kafirstan, has never been accurately traced; but its topographical conformation is evidently a continuation of that which has been observed in the districts of Badakshan to the west of the Khawak. The Hindu Kush represents the southern edge of a great central upheaval or plateau. It breaks up into long spurs southwards, deep amongst which are hidden the valleys of Kafirstan, almost isolated from each other by the rugged and snow-capped altitudes which divide them. To the north the plateau gradually slopes away towards the Oxus, falling from an average altitude of 15,000 ft. to 4,000 ft. about Faizabad, in the centre of Badakshan, but falling off to 1,100 at Kunduz, in Kataghan, where it merges into the flat plains bordering the Oxus.

The Kokcha river traverses Badakshan from south-east to north-west, and, with the Kunduz, drains all the northern slopes of the Hindu Kush west of the Dorah pass. Some of its sources are near Zebak, close to the great bend of the Oxus northwards, so that it cuts off all the mountainous area included within that bend from the rest of Badakshan. Its chief affluent is the Minjan, which Sir George Robertson found to be a considerable stream where it approaches the Hindu Kush close under the Dorah. Like the Kunduz, it probably drains the northern slopes of the Hindu Kush by deep lateral valleys, more or less parallel to the crest, reaching westwards towards the Khawak pass. From the Oxus (1000 ft.) to Faizabad (4000 ft.) and Zebak (8500 ft.) the course of the Kokcha offers a high road across Badakshan; between Zebak and Ishkashim, at the Oxus bend, there is but an insignificant pass of 900 ft.; and from Ishkashim by the Panja, through the Pamirs, is the continuation of what must once have been a much-traversed trade route connecting Afghan Turkestan with Kashgar and China. It is undoubtedly one of the great continental high-roads of Asia. North of the Kokcha, within the Oxus bend, is the mountainous district of Darwaz, of which the physiography belongs rather to the Pamir type than to that of the Hindu Kush.

A very remarkable meridional range extends for 100 m. northwards from the Hindu Kush (it is across this range that the route from Zebak to Ishkashim lies), which determines the great bend of the Oxus river northwards from Ishkashim, and narrows the valley of that river into the formation of a trough as far as the next bend westwards at Kala Wamar. The western slopes of this range drain to the Oxus either north-westwards, by the Kokcha and the Ragh, or else they twist their streams into the Shiwa, which runs due north across Darwaz. Here again we find the main routes which traverse the country following the rivers closely. The valleys are narrow, but fertile and populous. The mountains are rugged and difficult; but there is much of the world-famous beauty of scenery, and of the almost phenomenal agricultural wealth of the valleys of Bokhara and Ferghana to be found in the as yet half-explored recesses of Badakshan.

The principal domesticated animal is the yak. There are also large flocks of sheep, cows, goats, ponies, fine dogs and Bactrian camels. The more important wild animals are a large wild sheep (*Ovis poli*), foxes, wolves, jackals, bears, boars, deer and leopards; amongst birds, there are partridges, pheasants, ravens, jays, sparrows, larks, a famous breed of hawks, &c.

Badakshan proper is peopled by Tajiks, Turks and Arabs, who speak the Persian and Turki languages, and profess the orthodox doctrines of the Mahomedan law adopted by the Sunnite sect; while the mountainous districts are inhabited by Tajiks, professing the Shi'ite creed and speaking distinct dialects in different districts.

History.—Badakshan, part of the Greek Bactria, was visited by Hsüan Tsang in 630 and 644. The Arabian geographers of the 10th century speak of its mines of ruby and lapis lazuli, and give notices of the flourishing commerce and large towns of Waksh and Khotl, regions which appear to have in part corresponded with Badakshan. In 1272-1273 Marco Polo and his companions stayed for a time in Badakshan. During this and the following centuries the country was governed by kings who claimed to be descendants of Alexander the Great. The last of these kings was Shah Mahommed, who died in the middle of the 15th century, leaving only his married daughters to represent the royal line. Early in the middle of the 16th century the Usbeks obtained possession of Badakshan, but were soon expelled, and then the country was generally governed by descendants of the old royal dynasty by the female line. About the middle of the 18th century the present dynasty of Mirs established its footing in the place of the old one which had become extinct. In 1765 the country was invaded and ravaged by the ruler of Kabul. During the first three decades of the 19th century it was overrun and depopulated by Kohan Beg and his son Murad Beg, chiefs of the Kataghan Usbeks of Kunduz. When Murad Beg died, the power passed into the hands of another Usbek, Mahommed Amir Khan. In 1850 the Kataghan Usbeks were expelled; and Mir Jahander Shah, the representative of the modern royal line, was reinstated at Faizabad under the supremacy of the Afghans. In 1867 he was expelled by Abdur Raliman and replaced by Mir Mahommed Shah, and other representatives of the same family. (T. H. H.)*

BADALOCCHIO, SISTO, surnamed ROSA (1581-1647), Italian painter and engraver, was born at Parma. He was of the school of Annibale Carracci, by whom he was highly esteemed for design. His principal engravings are the series known as Raphael's Bible, which were executed by him in conjunction with Lanfranco, another pupil of Carracci. The best of his paintings, which are few in number, are at Parma. He died at Bologna.

BADALONA (anc. *Baetulo*), a town of north-eastern Spain, in the province of Barcelona; 6 m. N.E. of the city of Barcelona, on the left bank of the small river Besós, and on the Mediterranean Sea. Pop. (1900) 10,240. Badalona has a station on the coast railway from Barcelona to Perpignan in France, and a small harbour, chiefly important for its fishing and boat-building trades. There are gas, chemical and mineral-oil works in the town, which also manufactures woollen and cotton goods, glass, biscuits, sugar and brandy; while the surrounding fertile plains produce an abundance of grain, wine and fruit. Badalona thus largely contributes to the export trade of Barcelona, and may, in fact, be regarded as its industrial suburb.

BADBY, JOHN (d. 1410), one of the early Lollard martyrs, was a tailor (or perhaps a blacksmith) in the west Midlands, and was condemned by the Worcester diocesan court for his denial of transubstantiation. Badby bluntly maintained that when Christ sat at supper with his disciples he had not his body in his hand to distribute, and that "if every host consecrated at the altar were the Lord's body, then there be 20,000 Gods in England." A further court in St Paul's, London, presided over by Archbishop Arundel, condemned him to be burned at Smithfield, the tournament ground just outside the city walls. It is said that the prince of Wales (afterwards Henry V.) witnessed the execution and offered the sufferer both life and a pension if he would recant; but in Walsingham's words, "the abandoned villain declined the prince's advice, and chose rather to be burned than

to give reverence to the life-giving sacrament. So it befell that this mischievous fellow was burnt to ashes, and died miserably in his sin."

BADDELEY, ROBERT (c. 1732-1794), English actor, is said to have been first a cook to Samuel Foote, "the English Aristophanes," and then a valet, before he appeared on the stage. In 1761, described as "of Drury Lane theatre," he was seen at the theatre in Smock Alley, Dublin, as Gomez in Dryden's *Spanish Friar*. Two years later he was a regular member of the Drury Lane company in London, where he had a great success in the low comedy and servants' parts. He remained at this theatre and the Haymarket until his death. He was the original Moses in the *School for Scandal*. Baddeley died on the 20th of November 1794. He bequeathed property to found a home for decayed actors, and also £3 per annum to provide wine and cake in the green-room of Drury Lane theatre on Twelfth Night. The ceremony of the Baddeley cake has remained a regular institution.

His wife SOPHIA BADDELEY (1745-1786), an actress and singer, was born in London, the daughter of a sergeant-trumpeter named Snow. She was a woman of great beauty, but excessive vanity and notorious conduct. At the age of eighteen she ran away with Baddeley, then acting at Drury Lane, and she herself made her first appearance on the stage there on the 27th of April 1765, as Ophelia. Later, as a singer, she obtained engagements at Ranelagh and Vauxhall. Though separated from her husband on account of her misconduct, she still played several years in the same company. Her beauty and her extravagance rendered her celebrated, but the money which she made in all sorts of ways was so freely squandered that she was obliged to take refuge from her creditors in Edinburgh, where she made her last appearance on the stage in 1784.

See *Memoirs of Mistress Sophia Baddeley*, by Mrs Elizabeth Steele, 6 vols. (1781).

BADEN, a town and watering-place of Austria, in lower Austria, 17 m. S. of Vienna by rail. Pop. (1900) 12,447. It is beautifully situated at the mouth of the romantic Helenthal, on the banks of the Schwechat, and has become the principal summer resort of the inhabitants of the neighbouring capital. It possesses a new *Kurhaus*, fifteen bathing-establishments, a parish church in late Gothic style, and a town-hall, which contains interesting archives. The warm baths, which gave name to the town, are thirteen in number, with a temperature of from 72° F. to 97° F., and contain, as chief ingredient, sulphate of lime. They rise for the most part at the foot of the Calvarienberg (1070 ft.), which is composed of dolomitic limestone, and are mostly used for bathing purposes. Several members of the Austrian imperial family have made Baden their summer residence and have built here beautiful villas. There are about 20,000 visitors annually. Baden possesses several parks and is surrounded by lovely and interesting spots, of which the most frequented is the picturesque valley of the Helenthal, which is traversed by the Schwechat. Not far from Baden, the valley is crossed by the magnificent aqueduct of the Vienna waterworks. At the entrance to the valley, on the right bank of the river, lie the ruins of the 12th-century castle of Rauhenneck, and at its foot stands the Château Weilburg, built in 1820-1825 by Archduke Charles, the victor of Aspern. On the left bank, just opposite, stands the ruined castle of Rauchenstein, dating also from the 12th century. About 4 m. up the valley is Mayerling, a hunting-lodge, where the crown prince Rudolph of Austria was found dead in 1889. Farther up is Alland, where a road leads to the old and well-preserved abbey of Heligenkreuz. It possesses a church, in Romanesque style, dating from the 11th century, with fine cloisters and the tombs of several members of the Babenberg family. The highest point in the neighbourhood of Baden is the peak of the Hoher Lindkogel (2825 ft.), popularly called the Eiserne Thor, which is ascended in about three hours.

The celebrity of Baden dates back to the days of the Romans, who knew it by the name of *Therma Pannonica*, and remains of their occupation still exist. It received its charter as a town

in 1480, and although sacked at various times by Hungarians and Turks, it soon flourished again.

See J. Schwarz, *Die Heilquellen von Baden bei Wien* (Vienna, 3rd ed., 1900).

BADEN, or **BADEN-BADEN** (to distinguish it from other places of the name), a town and fashionable watering-place of Germany, in the grand-duchy of Baden, 23 m. S. by W. of Karlsruhe, with which it is connected by a branch of the Mannheim and Basel railway. Its situation—on a hill 600 ft. high, in the beautiful valley of the Black Forest—its extensive pleasure-grounds, gardens and promenades, and the brilliancy of the life that is led during the season, have long attracted crowds of visitors from all parts of the world. The resident population was in 1885, 12,779; in 1895, 14,862; and in 1905, 16,238; but the number of visitors exceeds 70,000 annually. Until the war of 1870, the prevailing nationality was French, but of late years Americans, Russians and English are the more numerous. The hot springs are twenty-nine in number, and vary in temperature from 37° to 54° R., i.e. from 115° to 153° Fahr. They flow from the castle rock at the rate of 90 gallons per minute, and the water is conveyed through the town in pipes to supply the different baths. There are two chief bathing-establishments, accounted the most elegant in Europe. The waters of Baden-Baden are specific in cases of chronic rheumatism and gout, paralysis, neuralgia, skin diseases and various internal complaints, such as stone and uric acid. The town proper is on the right bank of the Oos, but the principal resorts of the visitors are on the left. A *Conversationshaus* and a *Trinkhalle* or pump-room, a theatre and a picture-gallery, library and reading-room are among the chief buildings. The public gaming-tables, which for so many years were a striking feature, are now abolished. The only building of much antiquarian interest, with the exception of the castles, is the parish church, which dates from the 15th century, and contains the tombs of several of the margraves. The churches include a Lutheran, an English, in the Norman style of architecture, and a Russian, with beautiful frescoes; while on the Michaelsberg is the Greek chapel, with a gilded dome, which was erected over the tomb of a son of the Rumanian prince Michel Stourdzá, who died here in 1863.

The springs of Baden were known to the Romans, and the foundation of the town is referred to the emperor Hadrian by an inscription of somewhat doubtful authenticity. The name of *Aurelia Aquensis* was given to it in honour of Aurelius Severus, in whose reign it would seem to have been well known. Fragments of its ancient sculptures are still to be seen, and in 1847 remains of Roman vapour baths, well preserved, were discovered just below the New Castle. From the 14th century down to the close of the 17th, Baden was the residence of the margraves, to whom it gave its name. They first dwelt in the Old Castle, the ruins of which still occupy the summit of a hill above the town, but in 1479 they removed to the New Castle, which is situated on the hill-side nearer to the town, and is remarkable for its subterranean dungeons. During the Thirty Years' War Baden suffered severely from the various combatants, but especially from the French, who pillaged it in 1643, and laid it in ashes in 1689. The margrave Louis William removed to Rastatt in 1706. Since the beginning of the 19th century the government has greatly fostered the growth of the town.

See Wettendorfer, *Der Kurort Baden-Baden* (2nd ed., 1898); Schwarz, *Die Heilquellen von Baden-Baden* (4th ed., 1902).

BADEN, a town in the Swiss canton of Aargau, on the left bank of the river Limmat, 14 m. by rail N.W. of Zürich. It is now chiefly visited by reason of its hot sulphur springs, which are mentioned by Tacitus (*Hist. l. cap. 67*) and were very fashionable in the 15th and 16th centuries. They are especially efficacious in cases of gouty and rheumatic affections, and are much frequented by Swiss invalids, foreign visitors being but few in number. They lie a little north of the old town, with which they are now connected by a fine boulevard. Many Roman remains have been found in the gardens of the Kursaal. The town is very picturesque, with its steep and narrow streets, and its one surviving gateway, while it is dominated on the west by the ruined castle of Stein,

formerly a stronghold of the Habsburgs, but destroyed in 1415 and again in 1712. In 1415 Baden (with the Aargau) was conquered by the Eight Swiss Confederates, whose bailiff inhabited the other castle, on the right bank of the Limmat, which defends the ancient bridge across that river. As the conquest of the Aargau was the first made by the Confederates, their delegates (or the federal diet) naturally met at Baden, from 1426 to about 1712, to settle matters relating to these subject lands, so that during that period Baden was really the capital of Switzerland. The diet sat in the old town-hall or *Rathaus*, where was also signed in 1714 the treaty of Baden which put an end to the war between France and the Empire, and thus completed the treaty of Utrecht (1713). Baden was the capital of the canton of Baden, from 1798 to 1803, when the canton of Aargau was created. To the N.W. of the baths a new industrial quarter has sprung up of late years, the largest works being for electric engineering. In 1900 the permanent population of Baden was 6050 (German-speaking, mainly Romanists, with many Jews), but it is greatly swelled in summer by the influx of visitors.

One mile S. of Baden, on the Limmat, is the famous Cistercian monastery of Wettingen (1227-1841—the monks are now at Mehreuer near Brezgen), with splendid old painted glass in the cloisters and magnificent early 17th-century carved stalls in the choir of the church. Six miles W. of Baden is the small town of Brugg (2345 inhabitants) in a fine position on the Aar, and close to the remains of the Roman colony of *Vindonissa* (Windisch), as well as to the monastery (founded 1310) of Königsfelden, formerly the burial-place of the early Habsburgs (the castle of Habsburg is but a short way off), still retaining much fine painted glass.

See Bartn. Fricker, *Geschichte der Stadt und Bäder zu Baden* (Aarau, 1880). (W. A. B. C.)

BADEN, GRAND DUCHY OF, a sovereign state of Germany, lying in the south-west corner of the empire, bounded N. by the kingdom of Bavaria and the grand-duchy of Hesse-Darmstadt; W. and practically throughout its whole length by the Rhine, which separates it from the Bavarian Palatinate and the imperial province of Alsace-Lorraine; S. by Switzerland, and E. by the kingdom of Württemberg and part of Bavaria. The country has an area of 5823 sq. m. and consists of a considerable portion of the eastern half of the fertile valley of the Rhine and of the mountains which form its boundary. The mountainous part is by far the most extensive, forming, indeed, nearly 80% of the whole area. From the Lake of Constance in the south to the river Neckar in the north is a portion of the Black Forest or *Schwarzwald*, which is divided by the valley of the Kinzig into two districts of different elevation. To the south of the Kinzig the mean height is 3100 ft., and the loftiest summit, the Feldberg, reaches about 4898 ft., while to the north the mean height is only 2100 ft., and the Belchen, the culminating point of the whole, does not exceed 4480 ft. To the north of the Neckar is the Odenwald Range, with a mean of 1440 ft., and in the Katzenbuckel, an extreme of 1980 ft. Lying between the Rhine and the Dreisam is the Kaiserstuhl, an independent volcanic group, nearly 10 m. in length and 5 in breadth, the highest point of which is 1760 ft. The greater part of Baden belongs to the basin of the Rhine, which receives upwards of twenty tributaries from the highlands; the north-eastern portion of the territory is also watered by the Main and the Neckar. A part, however, of the eastern slope of the Black Forest belongs to the basin of the Danube, which there takes its rise in a number of mountain streams. Among the numerous lakes which belong to the duchy are the Mummel, Wilder, Eichener and Schluch, but none of them is of any size. The Lake of Constance (*Boden-See*) belongs partly to Bavaria and Switzerland.

Owing to its physical configuration Baden presents great extremes of heat and cold. The Rhine valley is the warmest district in Germany, but the higher elevations of the Black Forest record the greatest degrees of cold experienced in the south. The mean temperature of the Rhine valley is approximately 50° F. and that of the high table-land, 43° F. July is the hottest and January the coldest month in the year.

The mineral wealth of Baden is not great; but iron, coal, zinc and lead of excellent quality are produced, and silver, copper, gold, cobalt, vitriol and sulphur are obtained in small quantities. Peat is found in abundance, as well as gypsum, china-clay, potters' earth and salt. The mineral springs of Baden are very numerous and have acquired great celebrity, those of Baden-Baden, Badenweiler, Antogast, Griesbach, Freiersbach and Peterstal being the most frequented.

In the valleys the soil is particularly fertile, yielding luxuriant crops of wheat, maize, barley, spelt, beans, potatoes, flax, hemp, hops, beetroot and tobacco; and even in the more mountainous parts rye, wheat and oats are extensively cultivated. There is a considerable extent of pasture land, and the rearing of cattle, sheep, pigs and goats is largely practised. Of game, deer, wild boars, hares, snipe and partridges are fairly abundant, while the mountain streams yield trout of excellent quality. The culture of the vine increases, and the wines, which are characterized by a mildness of flavour, are in good demand. The gardens and orchards supply great abundance of fruits, especially almonds and walnuts; and bee-keeping is common throughout the country. A greater proportion of Baden than of any other of the south German states is occupied by forests. In these the predominant trees are the fir and pine, but many others, such as the chestnut, are well represented. A third, at least, of the annual supply of timber is exported.

Population.—At the beginning of the 19th century Baden was only a margraviate, with an area little exceeding 1300 sq. m., and a population of 270,000. Since then it has from time to time acquired additional territory, so that its area now amounts to 5823 sq. m., and its population (1905) to 2,009,320, of whom about 60% are Roman Catholics, 37% Protestants, 1½% Jews, and the remainder of other confessions. Of the population, about one-half may be classified as rural, i.e., living in communities of less than 2000 inhabitants; while the density of the population is about 330 to the square mile. The country is divided into the following districts, with the respective chief towns and populations as shown:—

District.	Chief towns.	Pop. (1905).
(1) Mannheim	Mannheim	162,607
(2) Karlsruhe	Heidelberg	49,439
	Karlsruhe	111,200
	Pforzheim	59,307
(3) Freiburg-im-Breisgau	Freiburg	74,102
(4) Constance	Constance	24,818

The capital of the duchy is Karlsruhe, and among important towns other than the above are Rastatt, Baden-Baden, Bruchsal and Lahr. The population is most thickly clustered in the north and in the neighbourhood of the Swiss town of Basel. The inhabitants of Baden are of various origin—those to the north of the Murg being descended from the Alemanni and those to the south from the Franks, while the Swabian plateau derives its name and its population from another race. (See WÜRTTEMBERG.)

Industries.—Of the area, 56·8% is cultivated and 38% forest, but the agricultural industry, which formerly yielded the bulk of the wealth of the country, is now equalled, if not surpassed, by the industrial output, which has attained very considerable dimensions. The chief articles of manufacture are machinery, woollen and cotton goods, silk ribbons, paper, tobacco, leather, china, glass, clocks, jewellery and chemicals. Beet sugar is also largely manufactured, and the inhabitants of the Black Forest have long been celebrated for their dexterity in the manufacture of wooden ornaments and toys, musical boxes and organs.

The exports of Baden, which coincide largely with the industries just mentioned, are of considerable importance, but the bulk of its trade consists in the transit of goods. The country is well furnished with roads and railways, the greater proportion of the latter being in the hands of the state. A line runs the whole length of the land, for the most part parallel with the Rhine, while branches cross obliquely from east to west. Mannheim is the great emporium for the export of goods down the Rhine and has a large river traffic. It is also the chief manu-

facturing town of the duchy and the seat of administrative government for the northern portion of the country.

Education and Religion.—The educational establishments of Baden are numerous and flourishing, and public education is entirely in the hands of the government. There are two universities, the Protestant at Heidelberg and the Roman Catholic at Freiburg-im-Breisgau, and a celebrated technical college at Karlsruhe. The grand-duke is a Protestant; under him the Evangelical Church is governed by a nominated council and a synod consisting of the "prelate," 48 elected, and 7 nominated lay and clerical members. The Roman Catholic archbishop of Freiburg is metropolitan of the Upper Rhine.

Constitution and Government.—The government of Baden is an hereditary monarchy, with the executive power vested in the grand-duke, while the legislative authority is shared by him with a representative assembly (*Landtag*) consisting of two chambers. The upper chamber is composed of all the princes of the reigning family who are of full age; the chiefs of the mediatized families; the archbishop of Freiburg; the president of the Protestant Evangelical church; a deputy from each of the universities and from the technical high school, eight members elected by the territorial nobility for four years, three representatives of the chamber of commerce, two of that of agriculture, one of that of trades, two mayors of municipalities; one burgo-master of lesser towns, one member of a district council, and eight members (two of them legal functionaries) nominated by the grand-duke. The lower chamber consists of 73 popular representatives, of whom 24 are elected by the burgesses of certain towns and 49 by the rural communities. Every citizen of 25 years of age, who has not been convicted and is not a pauper, has a vote. The elections are, however, indirect; the citizens nominating the *Wahlmänner* (deputy electors) and the latter electing the representatives. The chambers meet at least every two years. The members of the lower chamber are elected for four years, half the number retiring at the expiration of every two years. The executive consists of four departments of state—those of the interior, of foreign affairs and of the grand-ducal house, of finance, and of justice, ecclesiastical affairs and education. The chief sources of revenue are direct and indirect taxes, domains and railways. The last are worked by the state, and the sole public debt, amounting to about 22 millions sterling, is attributable to this head. The supreme courts of justice of the duchy are in Karlsruhe, Freiburg, Offenburg, Heidelberg, Mosbach, Waldshut, Constance and Mannheim, whence appeals lie to the *Reichsgericht* (supreme tribunal of the empire) in Leipzig. By virtue of a convention with Prussia, of 1871, the Baden army forms a portion of the Prussian army.

History.—During the middle ages the district which now forms the grand-duchy of Baden was ruled by various counts, prominent among whom were the counts and dukes of Zähringen. In 1112 Hermann, a son of Hermann, margrave of Verona (d. 1074), and grandson of Bertold, duke of Carinthia and count of Zähringen, having inherited some of the German estates of his family, called himself margrave of Baden, and from this date the separate history of Baden may be said to begin. Hermann appears to have called himself by the title of margrave, and not the more usual title of count, owing to the connexion of his family with the margraviate of Verona. His son and grandson, both named Hermann, added to their territories, which about 1200 were divided, and the lines of Baden-Baden and Baden-Hochberg were founded, the latter of which was divided about a century later into the branches of Baden-Hochberg and Baden-Sausenberg. The family of Baden-Baden was very successful in increasing the area of its possessions, which after several divisions were united by the margrave Bernard I. in 1391. Bernard, a soldier of some renown, continued the work of his predecessors, and obtained other districts, including Baden-Hochberg, the ruling family of which died out in 1418.

During the 15th century a war with the count palatine of the Rhine deprived Margrave Charles I. (d. 1475) of a part of his territories, but these losses were more than repaired by his son and successor, Christopher I. In 1503 the family of Baden-

Sausenberg became extinct, and the whole of Baden was united by Christopher, who divided it, however, before his death in 1527 among his three sons. One of these died childless in 1533, and in 1535 his remaining sons, Bernard and Ernest, having shared their brother's territories, made a fresh division and founded the lines of Baden-Baden and Baden-Pforzheim, called after 1565 Baden-Durlach. Further divisions followed, and the weakness caused by these partitions was accentuated by a rivalry, between the two main branches of the family. This culminated in open warfare, and from 1584 to 1622 Baden-Baden was in the possession of one of the princes of Baden-Durlach. Religious differences added to this rivalry. During the period of the Reformation some of the rulers of Baden adhered to the older and some adopted the newer faith, and the house was similarly divided during the Thirty Years' War. Baden suffered severely during this struggle, and both branches of the family were exiled in turn. The treaty of Westphalia in 1648 restored the *status quo*, and the family rivalry gradually died out. During the wars of the reign of Louis XIV. the margravate was ravaged by the French troops, and the margrave of Baden-Baden, Louis William (d. 1707), was prominent among the soldiers who resisted the aggressions of France. In 1771 Augustus George of Baden-Baden died without sons, and his territories passed to Charles Frederick of Baden-Durlach, who thus became ruler of the whole of Baden.

Although in 1771 Baden was united under a single ruler it did not form a compact territory, and its total area was only about 1350 sq. m. Consisting of a number of isolated districts lying on either bank of the upper Rhine, it was the work of Charles Frederick to acquire the intervening stretches of land, and so to give territorial unity to his country. Beginning to reign in 1738 and coming of age in 1746, this prince is the most notable of the rulers of Baden. He was interested in the development of agriculture and commerce; sought to improve education and the administration of justice, and was in general a wise and liberal ruler. His opportunity for territorial aggrandizement came during the Napoleonic wars. When war broke out between France and Austria in 1792 the Badenese fought for Austria; consequently their country was devastated and in 1796 the margrave was compelled to pay an indemnity, and to cede his territories on the left bank of the Rhine to France. Fortune, however, soon returned to his side. In 1803, largely owing to the good offices of Alexander I., emperor of Russia, he received the bishopric of Constance, part of the Rhenish Palatinate, and other smaller districts, together with the dignity of a prince elector. Changing sides in 1805 he fought for Napoleon, with the result that by the peace of Pressburg in that year he obtained the Breisgau and other territories at the expense of the Habsburgs. In 1806 he joined the Confederation of the Rhine, declared himself a sovereign prince, became a grand-duke, and received other additions of territory. The Baden contingent continued to assist France, and by the peace of Vienna in 1809 the grand-duke was rewarded with accessions of territory at the expense of the kingdom of Württemberg. Having quadrupled the area of Baden, Charles Frederick died in June 1811, and was succeeded by his grandson, Charles, who was married to Stephanie de Beauharnais (d. 1860), an adopted daughter of Napoleon. Charles fought for his father-in-law until after the battle of Leipzig in 1813, when he joined the Allies.

In 1815 Baden became a member of the Germanic confederation established by the Act of the 8th of June, annexed to the Final Act of the congress of Vienna of the 9th of June. In the hurry of the winding-up of the congress, however, the vexed question of the succession to the grand-duchy had not been settled. This was soon to become acute. By the treaty of the 16th of April 1816, by which the territorial disputes between Austria and Bavaria were settled, the succession to the Baden Palatinate was guaranteed to Maximilian I., king of Bavaria, in the expected event of the extinction of the line of Zähringen. As a counterblast to this the grand-duke Charles issued in 1817 a pragmatic sanction (*Hausgesetz*) declaring the counts of Hochberg, the issue of a morganatic marriage between the grand-duke Charles

Frederick and Luise Geyer von Meyersberg (created Countess Hochberg), capable of succeeding to the crown. A controversy between Bavaria and Baden resulted, which was only decided in favour of the Hochberg claims by the treaty signed by the four great powers and Baden at Frankfurt on the 10th of July 1819. Meanwhile the dispute had produced important effects in Baden. In order to secure popular support for the Hochberg heir, Charles in 1818 granted to the grand-duchy, under article xiii. of the Act of Confederation, a liberal constitution, under which two chambers were constituted and their assent declared necessary for legislation and taxation. The outcome was of importance far beyond the narrow limits of the duchy; for all Germany watched the constitutional experiments of the southern states. In Baden the conditions were not favourable to success. The people, belonging to the "Celtic fringe" of Germany, had fallen during the revolutionary period completely under the influence of French ideas, and this was sufficiently illustrated by the temper of the new chambers, which tended to model their activity on the proceedings of the Convention in the earlier days of the French Revolution. On the other hand, the new grand-duke Louis, who had succeeded in 1818, was unpopular, and the administration was in the hands of hide-bound and inefficient bureaucrats. The result was a deadlock; and, even before the promulgation of the Carlsbad decrees in October 1819 the grand-duke had prorogued the chambers, after three months of sterile debate. The reaction that followed was as severe in Baden as elsewhere in Germany, and culminated in 1823, when, on the refusal of the chambers to vote the military budget, the grand-duke dissolved them and levied the taxes on his own authority. In January 1825, owing to official pressure, only three Liberals were returned to the chamber; a law was passed making the budget presentable only every three years, and the constitution ceased to have any active existence.

In 1830 Louis was succeeded as grand-duke by his half-brother Leopold, the first of the Hochberg line. The July Revolution led to no disturbances in Baden; but the new grand-duke from the first showed liberal tendencies. The elections of 1830 were not interfered with; and the result was the return of a Liberal majority. The next few years saw the introduction, under successive ministries, of Liberal reforms in the constitution, in criminal and civil law, and in education. In 1832 the adhesion of Baden to the Prussian *Zollverein* did much for the material prosperity of the country. With the approach of the revolutionary year 1848, however, Radicalism once more began to lift up its head. At a popular demonstration held at Offenburg on the 12th of September 1847, resolutions were passed demanding the conversion of the regular army into a national militia which should take an oath to the constitution, a progressive income-tax and a fair adjustment of the interests of capital and labour.

The news of the revolution of February 1848 in Paris brought this agitation to a head. Numerous public meetings were held at which the Offenburg programme was adopted, and on the 4th of March, under the influence of the popular excitement, it was accepted almost unanimously by the lower-chamber. As in other German states, the government bowed to the storm, proclaimed an amnesty and promised reforms. The ministry was remodelled in a more Liberal direction; and a new delegate was sent to the federal diet at Frankfurt, empowered to vote for the establishment of a parliament for united Germany. The disorders, fomented by republican agitators, none the less continued; and the efforts of the government to suppress them with the aid of federal troops led to an armed insurrection. For the time this was mastered without much difficulty; the insurgents were beaten at Kandern on the 20th of April; Freiburg, which they held, fell on the 24th; and on the 27th a Franco-German "legion," which had invaded Baden from Strassburg, was routed at Dossenbach.

At the beginning of 1849, however, the issue of a new constitution, in accordance with the resolutions of the Frankfurt parliament, led to more serious trouble. It did little to satisfy the Radicals, who were angered by the refusal of the second chamber to agree to their proposal for the summoning of a

constituent assembly (10th of February 1849). The new insurrection that now broke out was a more formidable affair than the first. A military mutiny at Rastatt on the 11th of May showed that the army sympathized with the revolution, which was proclaimed two days later at Offenburg amid tumultuous scenes. On the same day (13th of May) a mutiny at Karlsruhe forced the grand-duke to take to flight, and the next day he was followed by the ministers, while a committee of the diet under Lorenz Brentano (1813-1891), who represented the more moderate Radicals as against the republicans, established itself in the capital to attempt to direct affairs pending the establishment of a provisional government. This was accomplished on the 1st of June, and on the 10th the "constituent diet," consisting entirely of the most "advanced" politicians, assembled. It had little chance of doing more than make speeches; the country was in the hands of an armed mob of civilians and mutinous soldiers; and, meanwhile, the grand-duke of Baden had joined with Bavaria in requesting the armed intervention of Prussia, which was granted on the condition that Baden should join the League of the Three Kings.

From this moment the revolution in Baden was doomed, and with it the revolution in all Germany. The Prussians, under Prince William (afterwards emperor), invaded Baden in the middle of June. The insurgent forces were under the command of the Pole, Ludwig von Mieroslawski (1814-1878), who reduced them to some semblance of order. On the 20th he met the Prussians at Waghäusel, and was completely defeated; on the 25th Prince William entered Karlsruhe; and at the end of the month the members of the provisional government, who had taken refuge at Freiburg, dispersed. Such of the insurgent leaders as were caught, notably the ex-officers, suffered military execution; the army was dispersed among Prussian garrison towns; and Baden was occupied for the time by Prussian troops. The grand-duke returned on the 10th of August, and at once dissolved the diet. The elections resulted in a majority favourable to the new ministry, and a series of laws were passed of a reactionary tendency with a view to strengthening the government.

The grand-duke Leopold died on the 24th of April 1852, and was succeeded by his second son, Frederick, as regent, the eldest, Louis (d. 22nd of January 1858), being incapable of ruling.¹ The internal affairs of Baden during the period that followed have comparatively little general interest. In the greater politics of Germany, Baden, between 1850 and 1866, was a consistent supporter of Austria; and in the war of 1866 her contingents, under Prince William, had two sharp engagements with the Prussian army of the Main. Two days before the affair of Werbach (24th of July), however, the second chamber had petitioned the grand-duke to end the war and enter into an offensive and defensive alliance with Prussia. The grand-duke had from the first been opposed to the war with Prussia, but had been forced to yield owing to popular resentment at the policy of Prussia in the Schleswig-Holstein question (*q.v.*). The ministry, now at one, resigned; Baden announced her withdrawal from the German confederation; and on the 17th of August a treaty of peace and alliance was signed with Prussia. The adhesion of Baden to the North German confederation was prevented by Bismarck himself, who had no wish to give Napoleon III. so good an excuse for intervention; but it was the opposition of Baden to the formation of a South German confederation that made the ultimate union inevitable. The troops of Baden took a conspicuous share in the war of 1870; and it was the grand-duke of Baden, who, in the historic assembly of the German princes at Versailles, was the first to hail the king of Prussia as German emperor.

The internal politics of Baden, both before and after 1870, centre in the main round the question of religion. The signing on the 28th of June 1850 of a concordat with the Holy See, by which education was placed under the oversight of the clergy and the establishment of religious orders was facilitated, led to a constitutional struggle, which ended in 1863 with the victory

¹ Frederick assumed the title of grand-duke on the 5th of September 1856.

of Liberal principles, the communes being made responsible for education, though the priests were admitted to a share in the management. The quarrel between Liberalism and Clericalism was, however, not ended. In 1867, on the accession to the premiership of Julius von Jolly (1823-1891), several constitutional changes in a Liberal direction were made; responsibility of ministers, freedom of the press, compulsory education. In the same year (6th of September) a law was passed to compel all candidates for the priesthood to pass the government examinations. The archbishop of Freiburg resisted, and, on his death in April 1868, the see was left vacant. In 1869 the introduction of civil marriage did not tend to allay the strife, which reached its climax after the proclamation of the dogma of papal infallibility in 1870. The "Kulturkampf" raged in Baden, as in the rest of Germany; and here as elsewhere the government encouraged the formation of Old Catholic communities. Not till 1880, after the fall of the ministry of Jolly, was a reconciliation with Rome effected; in 1882 the archbishopric of Freiburg was again filled up. The political tendency of Baden, meanwhile, mirrored that of all Germany. In 1891 the National Liberals had but a majority of one in the diet; but in 1893 they could maintain themselves only with the aid of the Conservatives; and in 1897 a coalition of Ultramontanans, Socialists, Social-democrats and Radicals (*Freisinnige*), won a majority for the opposition in the chamber.

Amid all these contests the wise and statesmanlike moderation of the grand-duke Frederick won him universal esteem. By the treaty under which Baden had become an integral part of the German empire, he had reserved only the exclusive right to tax beer and spirits; the army, the post-office, railways and the conduct of foreign relations were placed under the effective control of Prussia. In his relations with the German empire, too, Frederick proved himself rather a great German noble than a sovereign prince actuated by particularist ambitions; and his position as husband of the emperor William I.'s only daughter, Louise (whom he had married in 1856), gave him a peculiar influence in the councils of Berlin. When, on the 20th of September 1906, the grand-duke celebrated at once the jubilee of his reign and his golden wedding, all Europe combined to do him honour. King Edward VII. sent him, by the hands of the duke of Connaught, the order of the Garter. But more significant, perhaps, was the tribute paid by the *Temps*, the leading Parisian paper. "Nothing more clearly demonstrates the sterile paradox of the Napoleonic work," it wrote, "than the history of the grand-duchy. It was Napoleon, and he alone, who created this whole state in 1803 to reward in the person of the little margrave of Baden a relative of the emperor of Russia. It was he who after Austerlitz aggrandized the margravate at the expense of Austria; transformed it into a sovereign principality and raised it to a grand-duchy. It was he too who, by the secularization on the one hand and by the dismemberment of Württemberg on the other, gave the grand-duke 500,000 new subjects. He believed that the recognition of the prince and the artificial ethnical formation of the principality would be pledges of security for France. But in 1813 Baden joined the coalition, and since then that nation created of odds and ends (*de bric et de brac*) and always handsomely treated by us, had not ceased to take a leading part in the struggles against our country. The grand-duke Frederick, grand-duke by the will of Napoleon, has done France all the harm he could. But French opinion itself renders justice to the probity of his character and to the ardour of his patriotism, and nobody will feel surprise at the homage with which Germany feels bound to surround his old age." He died at Mainau on the 28th of September 1907, and was succeeded by his son, the grand-duke Frederick II.

BIBLIOGRAPHY.—*Das Grossherzogtum Baden in geographischer Hinsicht dargestellt* (Karlsruhe, 1885); Wielandt, *Das Staatsrecht des Grossherzogtums Baden* (Freiburg, 1892); F. von Weech, *Badische Geschichte* (Karlsruhe, 1890); *Die Zähringer in Baden* (Karlsruhe, 1881); *Baden unter den Grossherzögen Karl Friedrich, Karl Ludwig* (Freiburg, 1863); *Geschichte der badischen Verfassung* (Karlsruhe, 1868); and *Baden in den Jahren 1852 bis 1877* (Karlsruhe, 1877); C. F. Nebenius and F. von Weech, *Karl Friedrich von Baden* (Karlsruhe, 1868); L. H. Häusser, *Denkwürdigkeiten zur Geschichte der badischen Revolution* (Heidelberg, 1851); L. Müller,

Badische Landtagsgeschichte (Berlin, 1899-1902); E. von Chrismar, *Genealogie des Gesamthauses Baden vom 16. Jahrhundert bis heute* (Gotha, 1892); E. H. Meyer, *Badisches Volkseleben im 19. Jahrhundert* (Strassburg, 1900); F. J. Monc, *Quellensammlung zur badischen Landesgeschichte* (Karlsruhe, 1848-1867); *Badische Biographien*, edited by F. von Weech (Karlsruhe, 1875-1891).

BADENOCH, a district of south-east Inverness-shire, Scotland, bounded on the N. by the Monadhliath mountains, on the E. by the Cairngorms and Braemar, on the S. by Atholl and the Grampians, and on the W. by Lochaber. Its area is somewhat undefined, but it may be estimated to measure 36 m. from N.E. to S.W. and 15 m. from N. to S. Excepting the valley of the Spey and the great glens, it is almost entirely a wild mountainous tract, many hills exceeding 3000 ft. in height, and contains in the forests of Alder, Drumochter, Gaick and Feshie some of the best deer country in the Highlands. Loch Laggan and Loch Erich are the principal lakes, and the district is abundantly watered by the Spey and its numerous tributaries. It is traversed, from Dalnaspald to Boat of Garten, by the Highland railway. There are very few industries, and population groups itself at Kingussie and other places on or near the Spey. From 1229 to 1313 the lordship of Badenoch was owned by the Comyns. In 1371 Robert II. granted it to his son Alexander Stewart, 1st earl of Buchan (1343-1405), the "Wolf of Badenoch." Reverting to the crown, it was bestowed in 1452 upon the 1st earl of Huntly, and still gives the title of lord of Badenoch to the marquis of Huntly.

BADENWEILER, a health resort and watering place of the grand-duchy of Baden, Germany, 28 m. N. by E. by rail from Basel, at the western edge of the Black Forest. It is sheltered by the Blauen (3820 ft.) and the climate is excellent. Its new parish (Evangelical) church (1897) is built at the foot of the 11th-century castle which belonged to the margraves of Baden, and was destroyed by the French during the wars of Louis XV. The place is visited by 5000 people annually, partly for its warm mineral springs (70° F.), partly for its wchey cure, and partly on account of its equable climate and picturesque surroundings. There are a *Kurhaus*, built in 1853, and a park of 15 acres; also a grand-ducal castle, refitted in 1887-1888. In 1784 well-preserved Roman baths were discovered here. The permanent population is about 600.

BADGER, the common name for any animal of the Musteline subfamily *Melinae* or the typical genus *Meles* (see CARNIVORA). The name is probably derived from "badge," device, on account of the marks on the head; or it may be identical with the term separately noticed below, the French *blaireau* being used in both senses. The members of the typical genus have the lower jaw so articulated to the upper, by means of a transverse condyle firmly locked into a long cavity of the cranium, that dislocation of the jaw is all but impossible, and this enables those creatures to maintain their hold with the utmost tenacity. The European badger (*Meles taxus* or *M. meles*) is from 25 in. to 29 in. long, with a tail of about 8 in.; the general hue of the fur is grey above and black on the under parts; the head is white, with a black stripe on each side. In habits it may be taken as typical of the subfamily. It is nowhere abundant, but is found over the northern parts of Europe and Asia, and is a quiet, inoffensive animal, nocturnal and solitary in its habits, sleeping by day in its burrow, and issuing forth at night to feed on roots, beech-mast, fruits, the eggs of birds, small quadrupeds, frogs and insects. It is said also to dig up the nests of wasps in order to eat the larvae, as the ratel—a closely allied South African form—is said to rob the bees of their honey. The male and female are seldom seen together, and are supposed to trace each other by the odour of the secretion in the anal glands. Fossil remains of the badger have been found in England in deposits of Pleistocene age. In eastern Persia this species is replaced by the Persian badger (*M. canescens*); two species—the white-tailed badger (*M. leucurus*) and the Chinese badger (*M. chinensis*) occur in eastern Asia; and another (*M. anacuma*) is found in Japan. The American badger (*Taxidea americana*) ranges over the greater part of the United States, and in habits closely resembles the European species, but seems to be more carnivorous. When badgers were more

abundant than they now are, their skins, dressed with the hair attached, were commonly used for pistol furniture. They are now chiefly valued for the hair, that of the European badger being used in the manufacture of the best shaving-brushes while the softer hair of the American species is employed for the same purpose, and also for painters' pencils, and the fur is used for articles of ladies' apparel and trimmings. The Malay badger (*Mydas meliceps*) is confined to the mountains of Java (where it is called the teledu), Sumatra and Borneo. The head and body are about 15 in. long, and the tail no more than an inch; the fur is dark brown, with the top of the head, neck and a broad dorsal stripe, white. Like the skunk, this animal can eject the foetid secretion of the anal glands. The sand-badgers (*Arctonyx*) are Asiatic; the best-known species (*A. collaris*) ranges from the eastern Himalayas to Burma; the smaller *A. taxoides* is found in Assam, Arakan and perhaps in China; and there is probably another in Tibet. In these the tail is much longer in proportion to the body than in the rest of the group.

The badger does not usually seek to attack, but, when driven to bay, its great muscular power and tough hide render it a formidable antagonist. The cruel sport of *badger-drawing* was formerly popular throughout Great Britain, but was prohibited about the middle of the 19th century, together with bear-baiting and bull-baiting. The badger-ward, who was usually attached to a bear-garden, kept his badger in a large box. Whenever a drawing was arranged, bets were made as to how many times the dog, usually a bull-terrier, would *draw* the badger, i.e. pull it out of its box, within a given number of minutes. As soon as the dog succeeded in doing this the animals were parted, often by the attendants biting their tails, and the badger was again shut up in his box, which, at a signal from the time-keeper, was again opened. Another method of baiting this animal is thus described in the *Encyclopædia of Sport*: "They dig a place in the earth about a yard long, so that one end is four feet deep. At this end a strong stake is driven down. Then the badger's tail is split, a chain put through it, and fastened to the stake with such ability that the badger can come up to the other end of the place. The dogs are brought and set upon the poor animal who sometimes destroys several dogs before it is killed." The colloquial "to badger" (i.e. worry or tease) is a metaphorical derivative, and "drawing a badger" is similarly used in a figurative sense.

BADGER, a term of uncertain derivation (possibly derived from *bagger*, in allusion to the hawk's bag) for a dealer in food, such as corn or victuals (more expressly, fish, butter or cheese), which he has purchased in one place and brought for sale to another place; an itinerant dealer, corresponding to the modern hawk or huckster. An English statute of 1552 which summarized, and prescribed penalties against, the offences of engrossing, forestalling and regrating, specially exempted badgers from these penalties, but required them to be licensed by three justices of the peace for the county in which they dwelt. A statute of 1562-1563, after declaring that many people took up the trade of badgering "seeking only to live easily and to leave their honest labour," enacted that badgers should be licensed for a year only, should be householders of three years' standing in the county in which they were licensed, and should enter into recognizances not to engross or forestall. An act of 1844 abolished the offence of badgering, and repealed the statutes passed in relation to it. The word is still in common use in country districts.

BADGHIS ("home of the winds"), a district on the north-west of Afghanistan, between the Murghab and Hari Rud rivers, extending as far northward as the edge of the desert of Sarakhs. It includes the Chul formations through which the Russo-Afghan boundary runs. This region was surveyed by the boundary commission of 1885. Since that date it has been largely settled by the amir with purely Afghan tribes.

BADHAM, CHARLES (1813-1884), English scholar, was born at Ludlow, in Shropshire, on the 18th of July 1813. His father, Charles Badham, translator of Juvenal and an excellent classical scholar, was regius professor of physic at Glasgow; his mother was a cousin of Thomas Campbell, the poet. When about seven

years old, Badham was sent to Switzerland, where he became a pupil of Pestalozzi. He was afterwards transferred to Eton, and in 1830 was elected to a scholarship at Wadham College, Oxford, but only obtained a third class in classics (1836), a failure which may have been due to his dislike of the methods of study then in fashion at Oxford, at a time when classical scholarship was in a very unsatisfactory condition. Shortly after taking his degree in 1837 Badham went to Italy, where he occupied himself in the study of ancient MSS., in particular those of the Vatican library. It was here that he began a life-long friendship with G. C. Cobet. He afterwards spent some time in Germany, and on his return to England was incorporated M.A. at Peterhouse, Cambridge, in 1847. Having taken holy orders, he was appointed headmaster of Louth grammar school, Lincolnshire (1851-1854), and subsequently headmaster of Edgbaston proprietary school, near Birmingham. In the interval he had taken the degree of D.D. at Cambridge (1852). In 1860 he received the honorary degree of doctor of letters at the university of Leiden. In 1866 he left England to take up the professorship of classics and logic in Sydney University, which he held until his death on the 26th of February 1884. He was twice married. Dr Badham's classical attainments were recognized by the most famous European critics, such as G. C. Cobet, Ludwig Preller, W. Dindorf, F. W. Schneidewin, J. A. F. Meineke, A. Ritschl and Tischendorf. Like many schoolmasters who are good scholars and even good teachers, he was not a professional success; and his hasty temper and dislike of anything approaching disingenuousness may have stood in the way of his advancement. But it is strange that a scholar and textual critic of his eminence and of European reputation should have made comparatively little mark in his native country. He published editions of Euripides, *Helena* and *Iphigenia in Tauris* (1851), *Ion* (1851); Plato's *Philebus* (1855, 1878); *Laches* and *Euthydemus* (1865); *Phaedrus* (1851), *Symposium* (1866) and *De Platoni et Alisto* (1866). He also contributed to *Mnemosyne* (Cobet's journal) and other classical periodicals. His *Adhortatio ad Discipulos Academiae Sydniensis* (1869) contains a number of eulogiums of Thucydides and other classical authors. He also published an article on "The Text of Shakespeare" in *Cambridge Essays* (1856); *Criticism applied to Shakespeare* (1846); *Thoughts on Classical and Commercial Education* (1864).

A collected edition of his *Speeches and Lectures delivered in Australia* (Sydney, 1890) contains a memoir by Thomas Butler.

BADIUS, JODOCUS or **JOSSE** (1462-1535), sometimes called **BADIUS ASCENSIVS** from the village of Asche, near Brussels, where he was born, an eminent printer at Paris, whose establishment was celebrated under the name of *Prelum Ascensianum*. He was himself a scholar of considerable repute, had studied at Brussels and Ferrara, and before settling in Paris, had taught Greek for several years at Lyons. He illustrated with notes several of the classics which he printed, and was the author of numerous pieces, amongst which are a life of Thomas à Kempis, and a satire on the follies of women, entitled *Navicula Stultarum Mulierum*.

BADLESMERE, BARTHOLOMEW, **BARON** (1275-1322), English nobleman, was the son and heir of Gunselm de Badlesmere (d. 1301), and fought in the English army both in France and Scotland during the later years of the reign of Edward I. In 1307 he became governor of Bristol Castle, and afterwards Edward II. appointed him steward of his household; but these marks of favour did not prevent him from making a compact with some other noblemen to gain supreme influence in the royal council. Although very hostile to Earl Thomas of Lancaster, Badlesmere helped to make peace between the king and the earl in 1318, and was a member of the middle party which detested alike Edward's minions, like the Despencers, and his violent enemies like Lancaster. The king's conduct, however, drew him to the side of the earl, and he had already joined Edward's enemies when, in October 1321, his wife, Margaret de Clare, refused to admit Queen Isabella to her husband's castle at Leeds in Kent. The king captured the castle, seized and imprisoned Lady Badlesmere, and civil war began. After the

defeat of Lancaster at Boroughbridge, Badlesmere was taken and hanged at Canterbury on the 14th of April 1322. His son and heir, Giles, died without children in 1338.

BADMINTON, or **GREAT BADMINTON**, a village in the southern parliamentary division of Gloucestershire, England, 100 m. W. of London by the Great Western railway (direct line to south Wales). Here is Badminton House, the seat of the dukes of Beaufort, standing in a park some 10 m. in circumference. The manor of Badminton was acquired in 1608 from Nicolas Boteler (to whose family it had belonged for several centuries) by Thomas, Viscount Somerset (d. 1650 or 1651), third son of Edward, 4th earl of Worcester, and was given by his daughter and heiress Elizabeth to Henry Somerset, 3rd marquis of Worcester and 1st duke of Beaufort (1620-1699), who built the present mansion (1682) on the site of the old manor house. It is a stone building in Palladian style, and contains a number of splendid paintings and much fine wood-carving. The parish church of St. Michael stands close to it. This is a Grecian building (1785), with a richly ornamented ceiling and inlaid altarpavement; it also contains much fine sculpture in the memorials to former dukes, and is the burial-place of Field Marshal Lord Raglan, who was the youngest son of the 5th duke of Beaufort. Raglan Castle, near Monmouth, now a beautiful ruin, was the seat of the earls and the 1st marquis of Worcester, until it was besieged by the Parliamentarians in 1646, and after its capitulation was dismantled.

BADMINTON, a game played with rackets and shuttlecocks, its name being taken from the duke of Beaufort's seat in Gloucestershire. The game appears to have been first played in England about 1873, but before that time it was played in India, where it is still very popular. The Badminton Association in England was founded in 1895, and its laws were framed from a code of rules drawn up in 1887 for the Bath Badminton Club and based on the original Poona (1876) rules. In England the game is almost always played in a covered court. The All England championships for gentlemen's doubles, ladies' doubles, and mixed doubles were instituted in 1890, and for gentlemen's singles and ladies' singles in 1900; and the first championship between England and Ireland was played in 1904. Badminton may be played by daylight or by artificial light, either with two players on each side (the four-handed or double game) or with one player on each side (the two-handed or single game). The game consists entirely of volleying and is extremely fast, a single at Badminton being admitted to require more staying power than a single at lawn tennis. There is much scope for judgment and skill, e.g. in "dropping" (hitting the shuttle

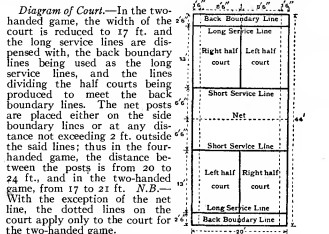

gently just over the net) and in "smashing" (hitting the shuttle with a hard downward stroke). The measurements of the court are shown on the accompanying plan.

The Badminton hall should be not less than 18 ft. high. Along the net line is stretched a net 30 in. deep, from 17 to 24 ft. long according to the position of the posts, and edged on the top with white tape 3 in. wide. The top of the net should be 5 ft. from

the ground at the centre and 5 ft. 1 in. at the posts. The shuttlecock (or shuttle) has 16 feathers from $2\frac{1}{2}$ to $2\frac{3}{4}$ in. long, and weighs from 73 to 85 grains. The racket (which is of no specified size, shape or weight) is strung with strong line gut and weighs as a rule about 6 oz.

The game is for 15 or, rarely, for 21 aces, except in ladies' singles, when it is for 11 aces; and a rubber is the best of three games. Games of 21 aces are played only and always in matches decided by a single game, and generally in handicap contests. The right to choose ends or to serve first in the first game of the rubber is decided by tossing. If the side which wins the toss chooses first service, the other side chooses ends, and vice versa; but the side which wins the toss may call upon the other side to make first choice. The sides change ends at the beginning of the second game, and again at the beginning of the third game, if a third game is necessary. In the third game the sides change ends when the side which is leading reaches 8 in a game of 15 aces, and 6 in a game of 11 aces, or, in handicap games, when the score of either side reaches half the number of aces required to win the game. In matches of one game (21 aces) the sides change ends when the side which is leading has scored 11 aces. The side winning a game serves first in the next game, and, in the four-handed game, either player on the side that has won the last game may take first service in the next game.

In a game of 15 aces, when the score is "13 all" the side which first reaches 13 has the option of "setting" the game to 5, and when the score is "14 all" the side which first reaches 14 has the option of "setting" the game to 3, i.e. the side which first scores 5 or 3 aces, according as the game has been "set" at "13 all" or "14 all," wins. In ladies' singles, when the score is "9 all" the side first reaching 9 may "set" the game to 5, and when the score is "10 all" the side which first reaches 10 may "set" the game to 3. In games of 21 aces, the game may be "set" to 5 at "19 all" and to 3 at "20 all." There is no "setting" in handicap games.

In the four-handed game, the player who serves first stands in his right-hand half court and serves to the player who is standing in the opposite right-hand half court, the other players meanwhile standing anywhere on their side of the net. As soon as the shuttle is hit by the server's racket, all the players may stand anywhere on their side of the net. If the player served to returns the shuttle, i.e. hits it into any part of his opponents' court before it touches the ground, it has to be returned by one of the "in" (serving) side, and then by one of the "out" (non-serving) side, and so on, until a "fault" is made or the shuttle ceases to be "in play."¹ If the "in" side makes a "fault," the server loses his "hand" (serve), and the player served to becomes the server; but no score accrues. If the "out" side makes a "fault," the "in" side scores an ace, and the players on the "in" side change half courts, the server then serving from his left half court to the player in the opposite left half court, who has not yet been served to. Only the player served to may take the service, and only the "in" side can score an ace. The first service in each innings is made from the right-hand half court. The side that starts a game has only one "hand" in its first innings; in every subsequent innings each player on each side has a "hand," the partners serving consecutively. While a side remains "in," service is made alternately from each half court into the half court diagonally opposite, the change of half courts taking place whenever an ace is scored. If, in play, the shuttle strikes the net but still goes over, the stroke is good; but if this happens in service and the service is otherwise good, it is a "let," i.e. the stroke does not count, and the server must serve again, even if the shuttle has been struck by the player served to, in which case it is assumed that the shuttle would have fallen into the proper half court. It is a "let," too, if the server, in attempting to serve, misses the shuttle altogether. It is a good stroke, in service or in play, if the shuttle falls on a line, or, in play, if it is followed

over the net with the striker's racket, or passes outside either of the net posts and then drops inside any of the boundary lines of the opposite court. *Mutatis mutandis*, the above remarks apply to the two-handed game, the main points of difference being that, in the two-handed game, both sides change half courts after each ace is scored and the same player takes consecutive serves, whereas in the double game only the serving side changes half courts at an added ace and a player may not take two consecutive serves in the same game.

It is a "fault" (a) if the service is overland, i.e. if the shuttle when struck is higher than the server's waist; (b) if, in serving, the shuttle does not fall into the half court diagonally opposite that from which service is made; (c) if, before the shuttle is struck by the server, both feet of the server and of the player served to are not inside their respective half courts, a foot on a line being deemed out of court; (d) if, in play, the shuttle falls outside the court, or, in service or play, passes through or under the net, or hangs in the net, or touches the roof or side walls of the hall or the person or dress of any player; (e) if the shuttle "in play" is hit before it reaches the striker's side; (f) if, when the shuttle is "in play," a player touches the net or its supports with his racket, person or dress; (g) if the shuttle is struck twice successively by the same player, or if it is struck by a player and his partner successively, or if it is not distinctly hit, i.e. if it is merely caught on the racket and spooned over the net; (h) if a player wilfully obstructs his opponent.

For full information on the laws of the game the reader is referred to the *Laws of Badminton and the Rules of the Badminton Association*, published annually (London). See also an article by S. M. Massey in the *Badminton Magazine* (February 1907), reprinted in a slightly revised form in the *Badminton Gazette* (November 1907). Until October 1907 *Laws Tennis and Badminton* was the official organ of the Badminton Association; in November 1907 the *Badminton Gazette* became the official organ.

BADNUR, a town of British India, the headquarters of the district of Betul in the Central Provinces. It consists, besides the European houses, of two bazaars. Pop. (1901) 5766. There is a good *serai* or inn for native travellers, and a *dak bungalow* or resting-place for Europeans. Not far from Badnur is Kherla, the former residence of the Gond rajas, where there is an old fort, now in ruins, which used to be held by them.

BADRINATH, a village and celebrated temple in British India, in the Garhwal district of the United Provinces. It is situated on the right bank of the Vishnuganga, a tributary of the Alaknanda river, in the middle of a valley nearly 4 m. in length and 1 in breadth. The village is small, containing only twenty or thirty huts, in which reside the Brahmans and the attendants of the temple. This building, which is considered a place of high sanctity, is by no means equal to its great celebrity. It is about 40 or 50 ft. in height, built in the form of a cone, with a small cupola, on the top of which is a gilt ball and spire, and contains the shrine of Badrinath, dedicated to an incarnation of Vishnu. The principal idol is of black stone and is 3 ft. in height. Badrinath is a favourite resort of pilgrims from all parts of India. In ordinary years the number varies from 7000 to 10,000; but every twelfth year, when the festival of Kumbh-mela is celebrated, the concourse of persons is said to be 50,000. In addition to the gifts of votaries, the temple enjoys a further source of revenue from the rents of villages assigned by former rajas. Successive temples have been shattered by avalanches, and the existing building is modern. It is situated among mountains rising 23,000 ft. above the level of the sea. Elevation of the site of the temple, 10,294 ft.

BADULLA, the capital of the province of Uva, Ceylon, 54 m. S. E. of Kandy. It is the seat of a government agent and district judge, besides minor courts. It was in Kandyan times the home of a prince who ruled Uva as a principality. Badulla stands 2222 ft. above sea-level; the average annual rainfall is 70½ in.; the average temperature, 73°. The population of the town in 1901 was 5924; of the Badulla district, 186,674. There is a botanic garden; and the town, being almost encircled by a river—the Badullaeya—and overshadowed by the Naminacooly Kande range of mountains (highest peak 6680 ft.), is very

¹ The shuttle is "in play" from the time it is struck by the server's racket until it touches the ground, or touches the net without going over, or until a "fault" is made.

picturesquely situated. The railway terminus at Bandarawella is 18 m. from Badulla. Tea is cultivated by the planters, and rice, fruit and vegetables by the natives in the district.

BAEDEKER, KARL (1801–1850), German publisher, was born at Essen on the 3rd of November 1801. His father had a printing establishment and book-shop there, and Karl followed the same business independently in Coblenz. Here he began to issue the first of the series of guide-books with which his name is associated. They followed the model of the English series instituted by John Murray, but developed in the course of years so as to cover the greater part of the civilized world, and later were issued in English and French as well as German. Baedeker's son Fritz carried on the business, which in 1872 was transferred to Leipzig.

BAEHR, JOHANN CHRISTIAN FELIX (1798–1872), German philologist, was born at Darmstadt on the 13th of June 1798. He studied at the university of Heidelberg where he was appointed professor of classical philology in 1823, chief librarian in 1832, and on the retirement of G. F. Creuzer became director of the philological seminary. He died at Heidelberg on the 20th of November 1872. His earliest works were editions of Plutarch's *Alcibiades* (1822), *Philopoemen, Flaminius, Pyrrhus* (1826), the fragments of Ctesias (1824), and Herodotus (1830–1835, 1855–1862). But most important of all were his works on Roman literature and humanistic studies in the middle ages: *Geschichte der römischen Literatur* (4th ed., 1868–1870), and the supplementary volumes, *Die christlichen Dichter und Geschichtschreiber Roms* (2nd ed., 1872), *Die christlich-römische Theologie* (1837), *Geschichte der römischen Literatur im karolingischen Zeitalter* (1840).

BAEL FRUIT (*Aegle marmelos*). *Aegle* is a genus of the botanical natural order Rutaceae, containing two species in tropical Asia and one in west tropical Africa. The plants are trees bearing strong spines, with alternate, compound leaves each with three leaflets and panicles of sweet-scented white flowers. *Aegle marmelos*, the bael- or bel-fruit tree (also known as Bengal quince), is found wild or cultivated throughout India. The tree is valued for its fruit, which is oblong to pyriform in shape, 2–5 in. in diameter, and has a grey or yellow rind and a sweet, thick orange-coloured pulp. The unripe fruit is cut up in slices, sun-dried and used as an astringent; the ripe fruit is described as sweet, aromatic and cooling. The wood is yellowish-white, and hard but not durable. The name *Aegle* is from one of the Hesperides, in reference to the golden fruit; *marmelos* is Portuguese for quince.

BAENA, a town of southern Spain, in the province of Cordova; 32 m. by road S.E. of the city of Cordova. Pop. (1900) 14,539. Baena is picturesquely situated near the river Marbella, on the slope of a hill crowned with a castle, which formerly belonged to the famous captain Gonzalo de Cordova. Farming, horse-breeding, linen-weaving and the manufacture of olive-oil are the chief local industries. The nearest railway station is Luque (pop. 4972), 4 m. S.E. on the Jaén-Lucena line. The site of the Roman town (Baniana or Biniana) can still be traced, and various Roman antiquities have been disinterred. In 1202 the Moors under Mahomed II. of Granada vainly besieged Baena, which was held for Sancho IV. of Castile; and the five Moorish heads in its coat-of-arms commemorate the defence.

BAER, KARL ERNST VON (1792–1876), German biologist, was born at Piep, in Esthonia, on the 29th of February 1792. His father, a small landowner, sent him to school at Reval, which he left in his eighteenth year to study medicine at Dorpat University. The lectures of K. F. Burdach (1776–1847) suggested research in the wider field of life-history, and as at that time Germany offered more facilities for, and greater encouragement to, scientific work, von Baer went to Würzburg, where J. J. Döllinger (1770–1841), father of the Catholic theologian, was professor of anatomy. In teaching von Baer, Döllinger gave a direction to his studies which secured his future pre-eminence in the science of organic development. He collaborated with C. H. Pander (1794–1865) in researches on the evolution of the chick, the results of which were first published in Burdach's treatise on physiology. Continuing his investigations alone, von Baer extended them to the evolution of organisms generally, and after a

sojourn at Berlin he was invited by his old teacher Burdach, who had become professor of anatomy at Königsberg, to join him as prosector and chief of the new zoological museum (1817). Von Baer's great discovery of the human ovum is the subject of his *Epistola de Ovo Mammalium et Hominis Genesi* (Leipzig, 1827), and in the following year he published the first part of his *History of the Evolution of Animals (Ueber die Entwicklungsgeschichte der Thiere)*, the second part following in 1837. In this work he demonstrated first, that the Graafian follicles in the ovary are not the actual eggs, but that they contain the spherical vesicle, which is the true ovum, a body about the one hundred and twentieth of an inch in diameter, wherein lie the properties transmitting the physical and mental characteristics of the parent or grandparent, or even of more remote ancestors. He next showed that in all vertebrates the primary stage of cleavage of the fertilized egg is followed by modification into leaf-like germ-layers—skin, muscular, vascular and mucous—whence arise the several organs of the body by differentiation. He further discovered the gelatinous, cylindrical cord, known as the *chorda dorsalis*, which passes along the body of the embryo of vertebrates, in the lower types of which it is limited to the entire inner skeleton, while in the higher the backbone and skull are developed round it. His "law of corresponding stages" in the development of vertebrate embryos was exemplified in the fact recorded by him about certain specimens preserved in spirit to which he had omitted to label. "I am quite unable to say to what class they belong. They may be lizards, or small birds, or very young mammalia, so complete is the similarity in the mode of formation of the head and trunk in these animals. The extremities are still absent, but even if they had existed in the earliest stage of the development we should learn nothing, because all arise from the same fundamental form." Again, in his *History of Evolution* he suggests, "Are not all animals in the beginning of their development essentially alike, and is there not a primary form common to all?" (i. p. 223). Notwithstanding this, the "telic" idea, with the archetypal theory which it involved, possessed von Baer to the end of his life, and explains his inability to accept the theory of unbroken descent with modification when it was propounded by Charles Darwin and A. R. Wallace in 1858. The influence of von Baer's discoveries has been far-reaching and abiding. Not only was he the pioneer in that branch of biological science to which Francis Balfour, gathering up the labours of many fellow-workers, gave coherence in his *Comparative Embryology* (1881), but the impetus to T. H. Huxley's researches on the structure of the *medusae* came from him (*Life*, i. 163), and Herbert Spencer found in von Baer's "law of development" the "law of all development" (*Essays*, i. 30). In 1834 von Baer was appointed librarian of the Academy of Sciences of St Petersburg. In 1835 he published his *Development of Fishes*, and as the result of collection of all available information concerning the fauna and flora of the Polar regions of the empire, he was appointed leader of an Arctic expedition in 1837. The remainder of his active life was occupied in divers fields of research, geological as well as biological, an outcome of the latter being his fine monograph on the fishes of the Baltic and Caspian Seas. One of the last works from his prolific pen was an interesting autobiographical published at the expense of the Esthonian nobles on the celebration of the jubilee of his doctorate in 1864. Three years afterwards he received the Copley medal. He died at Dorpat on the 28th of November 1876. (E. CL.)

BAER, WILLIAM JACOB (1860–), American painter, was born on the 29th of January 1860 in Cincinnati, Ohio. He studied at Munich in 1880–1884. He had much to do with the revival in America of the art of miniature-painting, to which he turned in 1892 and was the first president of the Society of Painters in Miniature, New York. Among his miniatures are "The Golden Hour," "Daphne," "In Arcadia" and "Madonna with the Auburn Hair."

BAETYLUS (Gr. *βαetylus, βαetylion*), a word of Semitic origin (= bethel) denoting a sacred stone, which was supposed to be endowed with life. These fetich objects of worship were meteoric stones, which were dedicated to the gods or revered as symbols of the gods themselves (Pliny, *Nat. Hist.* xvii. 9; Photius, *Cod.* 242).

In Greek mythology the term was specially applied to the stone supposed to have been swallowed by Cronus (who feared misfortune from his own children) in mistake for his infant son Zeus, for whom it had been substituted by Uranus and Gaëa, his wife's parents (*Etymologicum Magnum*, s.v.). This stone was carefully preserved at Delphi, anointed with oil every day and on festal occasions covered with raw wool (Pausanias x. 24). In Phœnician mythology, one of the sons of Uranus is named Baetylus. Another famous stone was the effigy of Rhea Cybele, the holy stone of Pessinus, black and of irregular form, which was brought to Rome in 204 B.C. and placed in the mouth of the statue of the goddess. In some cases an attempt was made to give a more regular form to the original shapeless stone: thus Apollo Aegyus was represented by a conical pillar with pointed end, Zeus Melichius in the form of a pyramid. Other famous baetylic idols were those in the temples of Zeus Casius at Seleucia, and of Zeus Telcius at Tegea. Even in the declining years of paganism, these idols still retained their significance, as is shown by the attacks upon them by ecclesiastical writers.

See Muntzer, *Über die vom Himmel gefallenen Steine* (1805); Bösenigk, *De Baetyliis* (1854); and the exhaustive article by F. Lenormant in Daremberg and Saglio's *Dictionary of Antiquities*.

BAEYER, JOHANN FRIEDRICH WILHELM ADOLF VON (1835—), German chemist, was born at Berlin on the 31st of October 1835, his father being Johann Jacob von Baeyer (1794-1885), chief of the Berlin Geodetical Institute from 1870. He studied chemistry under R. W. Bunson and F. A. Kekulé, and in 1858 took his degree as Ph.D. at Berlin, becoming privat-docent a few years afterwards and assistant professor in 1866. Five years later he was appointed professor of chemistry at Strassburg, and in 1875 he migrated in the same capacity to Munich. He devoted himself mainly to investigations in organic chemistry, and in particular to synthetical studies by the aid of "condensation" reactions. The Royal Society of London awarded him the Davy medal in 1881 for his researches on indigo, the nature and composition of which he did more to elucidate than any other single chemist, and which he also succeeded in preparing artificially, though his methods were not found commercially practicable. To celebrate his seventieth birthday his scientific papers were collected and published in two volumes (*Gesammelte Werke*, Brunswick, 1905), and the names of the headings under which they are grouped give some idea of the range and extent of his chemical work:—(1) organic arsenic compounds, (2) uric acid group, (3) indigo, (4) papers arising from indigo researches, (5) pyrrol and pyridine bases, (6) experiments on the elimination of water and on condensation, (7) the phthaleins, (8) the hydro-aromatic compounds, (9) the terpenes, (10) nitroso compounds, (11) furfural, (12) acetylene compounds and "strain" (*Spannungs*) theory, (13) peroxides, (14) basic properties of oxygen, (15) dibenzalacetone and triphenylamine, (16) various researches on the aromatic and (17) the alphabetic series.

BAÉZA (anc. *Beitia*), a town of southern Spain, in the province of Jaén; in the Loma de Ubeda, a mountain range between the river Guadalquivir on the S. and its tributary the Guadalimar on the N. Pop. (1900) 14,379. Baéza has a station 3 m. S.W. on the Lináres-Almería railway. Its chief buildings are those of the university (founded in 1533, and replaced by a theological seminary), the cathedral and the Franciscan monastery. The Cordova and Ubeda gates, and the arch of Baéza, are among the remains of its old fortifications, which were of great strength. The town has little trade except in farm-produce; but its red dye, made from the native cochineal, was formerly celebrated. In the middle ages Baéza was a flourishing Moorish city, said to contain 50,000 inhabitants; but it was sacked in 1230 by Ferdinand III. of Castile, who in 1248 transferred its bishopric to Jaén. It was the birthplace of the sculptor and painter, Gaspar Becerra.

BAFFIN, WILLIAM (1584-1622), English navigator and discoverer. Nothing is known of his early life, but it is conjectured that he was born in London of humble origin, and gradually raised himself by his diligence and perseverance. The earliest mention of his name occurs in 1612, in connexion with

an expedition in search of a North-West Passage, under the orders of Captain James Hall, whom he accompanied as chief pilot. Captain Hall was murdered in a fight with the natives on the west coast of Greenland, and during the two following years Baffin served in the Spitsbergen whale-fishery, at that time controlled by the Muscovy Company. In 1615 he entered the service of the Company for the discovery of the North-West Passage, and accompanied Captain Robert Bylot as pilot of the little ship "Discovery," and now carefully examined Hudson Strait. The accuracy of Baffin's tidal and astronomical observations on this voyage was confirmed in a remarkable manner by Sir Edward Parry, when passing over the same ground, two centuries later (1821). In the following year Baffin again sailed as pilot of the "Discovery," and passing up Davis Strait discovered the fine bay to the north which now bears his name, together with the magnificent series of straits which radiate from its head and were named by him Lancaster, Smith and Jones Sounds, in honour of the generous patrons of his voyages. On this voyage he had sailed over 300 m. farther north than his predecessor Davis, and for 236 years his farthest north (about lat. 77° 45') remained unsurpassed in that sea. All hopes, however, seemed now ended of discovering a passage to India by this route, and in course of time even Baffin's discoveries came to be doubted until they were re-discovered by Captain Ross in 1818. Baffin next took service with the East India Company, and in 1617-1619 performed a voyage to Surat in British India, and on his return received the special recognition of the Company for certain valuable surveys of the Red Sea and Persian Gulf which he had made in the course of the voyage. Early in 1620 he again sailed to the East, and in the Anglo-Persian attack on Kishm in the Persian Gulf, preparatory to the reduction of Ormuz, he received his death-wound and died on the 23rd of January 1622. Besides the importance of his geographical discoveries, Baffin is to be remembered for the importance and accuracy of his numerous scientific and magnetic observations, for one of which (the determination of longitude at sea by lunar observation) the honour is claimed of being the first of its kind on record.

BAFFIN BAY AND BAFFIN LAND, an arctic sea and an insular tract named after the explorer William Baffin. Baffin or Baffin's Bay is part of the long strait which separates Baffin Land from Greenland. It extends from about 69° to 78° N. and from 54° to 76° W. From the northern end it is connected (1) with the polar sea northward by Smith Sound, prolonged by Kane Basin and Kennedy and Robeson Channels; (2) with the straits which ramify through the archipelago to the north-west by narrow channels at the head of Jones Sound, from which O. Sverdrup and his party conducted explorations in 1900-1902; (3) with the more southerly part of the same archipelago by Lancaster Sound. Baffin Bay was explored very fully in 1616 by Baffin. The coasts are generally high, precipitous and deeply indented. The most important island on the east side is Disco, to the north of Disco Bay, Greenland. During the greater part of the year this sea is frozen, but, while hardly ever free of ice, there are normally navigable channels along the coasts from the beginning of June to the end of September connected by transverse channels. The bay is noted as a centre of the whale and seal fishery. At more than one point a depth exceeding 1000 fathoms has been ascertained.

Baffin Land is a barren insular tract, included in Franklin district, Canada, with an approximate area of 236,000 sq. m., situated between 61° and 90° W. and 62° and 74° N. The eastern and northern coasts are rocky and mountainous, and are deeply indented by large bays including Frobisher and Home Bays, Cumberland Sound and Admiralty Inlet. Baffin Land is separated from Greenland by Baffin Bay and Davis Strait, from Ungava by Hudson Strait, from Keewatin and Melville Peninsula by Fox Channel and Fury-and-Hecla Strait, from Boothia Peninsula and North Somerset by the Gulf of Boothia and Prince Regent Inlet, and from North Devon by Lancaster Sound. Various names are given to various parts of the land—thus the north-western part is called Cockburn Land, farther

east is North Galloway; on the extreme eastern peninsula are Cumberland and Penny Lands, while the southern is called Meta Incognita; in the west is Fox Land. In the southern part of the interior are two large lakes, Amadjuak, which lies at an altitude of 289 ft., and Nettiung or Kennedy.

BAGAMOYO, a seaport of German East Africa in 6° 22' S., 38° 55' E. Pop. about 18,000, including a considerable number of British Indians. Being the port on the mainland nearest the town of Zanzibar, 26 m. distant, Bagamoyo became the starting-point for caravans to the great lakes, and an entrepôt of trade with the interior of the continent. It possesses no natural harbour. The beach slopes gently down and ships anchor about 2 m. off the coast. The town is oriental in character. The buildings include the residence of the administrator, barracks, a government school for natives, a mosque and Hindu temple, and the establishment of the *Mission du Sacré Cœur*, which possesses a large plantation of coco-nut palms. Bagamoyo is in telegraphic communication with Zanzibar and with the other coast towns of German East Africa, and has regular steamship communication with Zanzibar. Of the explorers who made Bagamoyo the starting-point for their journeys to the interior of Africa, the most illustrious were Sir Richard Burton, J. H. Speke, J. A. Grant and Sir H. M. Stanley.

BAGATELLE (French, from Ital. *bagatella*, *bagata*, a trifle), primarily a thing of trifling importance. The name, though French, is given to a game which is probably of English origin, though its connexion with the *shovel-board* of Cotton's *Complete Gamester* is very doubtful. Strutt does not mention it. The game is very likely a modification of billiards, and is played on an oblong board or table varying in size from 6 ft. by 1½ ft. to 10 ft. by 3 ft. The bed of the table is generally made of slate, although, in the smaller sizes, wood covered with green cloth is often used. The sides are cushioned with india-rubber. The head is semi-circular and fitted with 9 numbered cups set into the bed, their numbers showing the amount scored by putting a ball into them. An ordinary billiard-cue and nine balls, one black, four red and four white, are used. The black ball is placed upon a spot about 9 in. in front of hole 1, and about 18 in. from the player's end of the board a line (the baulk) is drawn across it, behind which is another spot for the player's ball. (These measurements of course differ according to the size of the table.) Some modern tables have pockets as well as cups.

Bagatelle Proper.—The black ball having been placed on the upper spot, the players "string" for the lead, the winner being that player who plays his ball into the highest hole. Any number may play, either separately, or in sides. Each player in turn plays all eight balls up the table, no score being allowed until a ball has touched the black ball, the object being to play as many balls as possible into the holes, the black ball counting double. Balls missing the black at the beginning, those rolling back across the baulk-line, and those forced off the table are "dead" for that round and removed. The game is decided by the aggregate score made in an agreed number of rounds.

Sans Égal.—This is a French form of the game. Two players take part, one using the red and one the white balls. After stringing for lead, the leader plays at the black, forfeiting a ball if he misses. His opponent then plays at the black if it has not been touched, otherwise any way he likes, and each then plays alternately, the object being to hole the black and his own balls, the winner being the one who scores the highest number of points. If a player holes one of his opponent's balls it is scored for his opponent. The game is decided by a certain number of rounds, or by points, usually 21 or 31. In other matters the rules of bagatelle apply.

The Cannon Game.—This is usually considered the best and most scientific of bagatelle varieties. Tables without cups are sometimes used. As in billiards three balls are required, the white, spot-white and black, the last being spotted and the non-striker's ball placed midway between holes 1 and 9. The object of the game is to make cannons (caroms), balls played into holes, at the same time counting the number of the holes, but if a ball falls into a hole during a play in which no cannon

is made the score counts for the adversary. If the striker's ball is holed he plays from baulk; if an object-ball, it is spotted as at the beginning of the game. A cannon counts 2; missing the white object-ball scores 1 to the adversary; missing the black, 5 to the adversary. If there are pockets, the striker scores 2 for holing the white object-ball and 3 for holing the black, but a cannon must be made by the same stroke; otherwise the score counts for the adversary.

The Irish Cannon Game.—The rules of the *cannon game* apply, except that in all cases pocketed balls count for the adversary.

Mississippi.—This variation is played with a bridge pierced with 9 or more arches, according to the size of the table, the arches being numbered from 1 upwards. All nine balls are usually played, though the black is sometimes omitted, each player having a round, the object being to send the balls through the arches. This may not be done directly, but the balls must strike a cushion first, the black, if used, counting double the arch made. If a ball is played through an arch, without first striking a cushion, the score goes to the adversary, but another ball, lying in front of the bridge, may be sent through by the cue-ball if the latter has struck a cushion. If a ball falls into a cup the striker scores the value of the cup as well as of the arch.

Trou Madame.—This is a game similar to *Mississippi*, with the exceptions that the ball need not be played on to a cushion, and that, if a ball falls into a cup, the opponent scores the value of the cup and not the striker.

Bell-Bagatelle is played on a board provided with cups, arches from which bells hang, and stalls each marked with a number. The ball is played up the side and rolls down the board, which is slightly inclined, through the arches or into a cup or stall, the winner scoring the highest with a certain number of balls.

BAGDAD, or BAGHDAD, a vilayet of Asiatic Turkey, situated between Persia and the Syrian desert, and including the greater part of ancient Babylonia. The original vilayet extended from Mardin on the N. to the Persian Gulf on the S., and from the river Khabor on the W. to the Persian frontier on the E. From the middle of the 17th century, when this region was annexed by the Turks, until about the middle of the 19th century, the vilayet of Bagdad was the largest province of the Turkish empire, constituting at times an almost independent principality. Since then, however, it has lost much of its importance and all of its independence. The first reduction in size occurred in 1857, when some of the western portion of the vilayet was added to the newly created sanjak of Zor. In 1878 the Mosul vilayet was created out of its northern, and in 1884 the Basra vilayet out of its southern sanjaks. At the present time it extends from a point just below Kut el-Amara to a point somewhat above Tekrit on the Tigris, and from a point somewhat below Samawa to a point a little above Anah on the Euphrates. It is still, territorially, the largest province of the empire, and includes some of the most fertile lands in the Euphrates-Tigris valleys; but while possessing great possibilities for fertility, by far the larger portion of the vilayet is to-day a desert, owing to the neglect of the irrigation canals on which the fertility of the valley depends. From the latitude of Bagdad northward the region between the two rivers is an arid, waterless, limestone steppe, inhabited only by roving Arabs. From the latitude of Bagdad southward the country is entirely alluvial soil, deposited by the rivers Tigris and Euphrates, possessing great possibilities of fertility, but absolutely flat and subject to inundations at the time of flood of the two rivers. At that season much of the country, including the immediate surroundings of Bagdad, is under water. During the rest of the year a large part of the country is a parched and barren desert, and much of the remainder swamps and lagoons. Wherever there is any pretence at irrigation, along the banks of the two great rivers and by the few canals which are still in existence, the yield is enormous, and the shores of the Tigris and Euphrates in the neighbourhood of Bagdad and Hilla seem to be one great palm garden. Sultan Abd-ul-Hamid II. personally acquired large tracts of land in various parts of the vilayet. These so-called *seniicks* are

well farmed and managed, in conspicuous contrast with the surrounding territory. Canals and dikes have been constructed to control and distribute the much-needed water, and the officials are housed in new buildings of substantial appearance. Indeed, wherever one finds a new and prosperous-looking village, it may be assumed to belong to the sultan. These *semmehs* are an advantage to the country in that they give security to their immediate region and certain employment to some part of its population. On the other hand, they withdrew large tracts of fertile and productive land from taxation (one-half of the cultivated land of the vilayet was said to be administered for the sultan's privy purse), and thus greatly reduced the revenue of the vilayet.

The chief city of the vilayet is its capital, Bagdad. Between the Euphrates and the Arabian plateau lie the sacred cities of Kerbela or Meshed-Hosain, and Nejeef or Meshed Ali, with a population of 20,000 to 60,000 each, while a number of towns, varying in population from 3000 to 10,000, are found along the Euphrates (Anah, Hit, Ramadieh, Musseyib, Hilla, Diwanieh and Samawa) and the Tigris (Tekrit, Samarra and Kut el-Amara). The settled population lies entirely along the banks of these streams and the canals and lagoons westward of the Euphrates, between Kerbela and Nejeef. Away from the banks of the rivers, between the Euphrates and the Tigris and between the latter and the Persian mountains, are tribes of wandering Arabs, some of whom possess great herds of horses, sheep, goats, asses and camels, while in and by the marshes other tribes, in the transition stage from the nomadic to the settled life, own great herds of buffaloes. Of the wandering Arab tribes, the most powerful is the great tribe of Shammar, which ranges over all Mesopotamia. In January and February they descend as low as the neighbourhood of Diwanieh in such numbers that even Bagdad is afraid. Here and there are regions occupied by a semi-sedentary population, called *Mudan*, occupying reed huts huddled around mud castles, called *mestul*. These, like the Bedouin Arabs, are practically independent, waging constant warfare among themselves and paying an uncertain tribute to the Turkish government. In general, Turkish rule is confined to the villages, towns and cities along the river banks, in and by which garrisons are located. Since the time (1868-1872) of Midhat Pasha, who did much to bring the independent Arab tribes under control, the Turkish government has been, however, gradually strengthening its grip on the country and extending the area of conscription and taxation. But from both the racial and religious standpoint, the Arab and Persian Shi'as, who constitute the vast bulk of the population, regard the Turks as foreigners and tyrants.

Of crops the vilayet produces wheat (which is indigenous), rice, barley (which takes the place of oats as food for horses), durra (a coarse, maize-like grain), sesame, cotton and tobacco; of fruits, the date, orange, lemon, fig, banana and pomegranate. The country is naturally treeless, except for the tamarisk, which grows by the swamps and along the river-beds. Here and there one sees a solitary *sifsaif* tree, or a small plantation of poplars or white mulberries, which trees, with the date-palm, constitute the only timber of the country. The willows reported by some travellers are in reality a narrow-leaved variety of poplar.

Besides the buffaloes and a few humped Indian oxen, there are no cattle in the country. Of wild animals, the pig, hyena, jackal, antelope and hare are extremely numerous; lions are still found, and wolves and foxes are not uncommon. Snipe and various species of wild fowl are found in the marshes, and pelicans and storks abound along the banks of the Euphrates and Tigris. Fish are caught in great numbers in the rivers and marshes, chiefly barbel and carp, and the latter attain so great a size that one is a sufficient load for an ass. The principal exports of the province are coarse wool, hides, dates and horses. At various points, especially at Hit, and from Hit southward along the edge of the Arabian plateau occur bitumen, naphtha and white petroleum springs, all of which remain undeveloped. The climate is very hot in summer, with a mean temperature of 97° F. From April to November no rain falls; in November the rains commence, and during the winter the thermometer falls to 46° F.

Cholera is endemic in some parts of the vilayet, and before 1875 the same was true of the bubonic plague. At that date this disease was stamped out by energetic measures on the part of the government, but it has reappeared again in recent years, introduced apparently from India or Persia by pilgrims. There are four great centres of pilgrimage for Shi'ite Moslems in the vilayet, Samarra, Kazemain, a suburb of Bagdad, Kerbela and Nejeef. These are visited annually by tens of thousands of pilgrims, not only from the surrounding regions, but also from Persia and India; many of whom bring their dead to be buried in the neighbourhood of the sacred tombs.

Unpleasant, but not dangerous, is another disease, the so-called "Bagdad date-mark," known elsewhere as the "Aleppo button," &c. This disease extends along the rivers Tigris and Euphrates, and the country adjacent from Aleppo and Diarbekr to the Persian Gulf, although there are individual towns and regions in this territory which seem to be exempt. It shows itself as a boil, attacking the face and extremities. It appears in two forms, known to the natives as male and female respectively. The former is a dry scaly sore, and the latter a running, open boil. It is not painful but leaves ugly scars. The natives all carry somewhere on their face, neck, hands, arms or feet the scars of these boils which they have had as children. European children born in the country are apt to be seriously disfigured, as in their case the boils almost invariably appear on the face, and whereas native children have as a rule but one boil, those born of European parents will have several. Adult foreigners visiting the country are also liable to be attacked, and women, especially, rarely escape disfigurement if they stay in the country for any length of time. The boils last for about a year, after which there is no more likelihood of a recurrence of the trouble than in the case of smallpox.

The area of the vilayet is 54,480 sq. m. The population is estimated at 852,000; Christians, 8000, principally Nestorians or Chaldaeans; Jews, 54,000; Moslems, 790,000, of whom the larger part are Shi'as.

See G. le Strange, *Baghdad under the Abbasid Caliphate* (1901); *The Lands of the Eastern Caliphate* (Cambridge, 1905); V. Cuienet, *La Turquie d'Asie* (Paris, 1890); J. P. Peters, *Nippur* (New York and London, 1897); Ed. Sachau, *Am Euphrat und Tigris* (Leipzig, 1900); A. V. Geere, *By Nile and Euphrates* (Edinburgh, 1904). (J. P. Pe.)

BAGDAD, or BAGHDAD, the capital of the Turkish vilayet of the same name. It is the headquarters of the VI. Army Corps, which garrisons also the Basra and Mosul vilayets. It lies on both sides of the river Tigris, in an extensive desert plain which has scarcely a tree or village throughout its whole extent, in latitude 33° 20' N., longitude 44° 24' E. At this point the Tigris and the Euphrates approach each other most nearly, the distance between them being little more than 25 m. At this point also the two rivers are connected by a canal, the northernmost of a series of canals which formerly united the two great waterways, and at the same time irrigated the intervening plain. This canal, the Sakhlawieh (formerly Isa), leaves the Euphrates a few miles above Felujah and the bridge of boats, near the ruins of the ancient Anbar. As it approaches Bagdad it spreads out in a great marsh, and finally, through the Masudi canal, which encircles western Bagdad, enters the Tigris below the town. At the time of Chesney's survey of the Euphrates in 1838 this canal was still navigable for craft of some size. At present it serves no other purpose than to increase the floods which periodically turn Bagdad into an island city, and sometimes threaten to overwhelm the dikes which protect it and to submerge it entirely.

The original city of Bagdad was built on the western bank of the Tigris, but this is now, and has been for centuries, little more than a suburb of the larger and more important city on the eastern shore, the former containing an area of only 146 acres within the walls, while the latter extends over 501 acres. Both the eastern and the western part of the city were formerly enclosed by brick walls, with large round towers at the principal angles and smaller towers intervening at shorter distances, the whole surrounded by a deep fosse. There were three gates in the

western city and four in the eastern; one of the latter, however, on the north side, called "Gate of the Talisman" from an Arabic inscription bearing the date A.D. 1220, has remained closed since the capture of the city by Murad IV. in 1638. These walls all fell into decay long since; at places they were used as brick quarries, and finally the great reforming governor, (1868-1872), Midhat Pasha, following the example set by many European cities, undertook to destroy them altogether and utilize the free space thus obtained as a public park and esplanade. His plans were only partially carried out. At present fragments of the walls exist here and there, with the great ditch about them, while elsewhere a line of mounds marks their course. A great portion of the ground within the wall lines is not occupied by buildings, especially in the north-western quarter; and even in the more populous parts of the city, near the river, a considerable space between the houses is occupied by gardens, where pomegranates, figs, oranges, lemons and date-palms grow in great abundance, so that the city, when seen at a distance, has the appearance of rising out of the midst of trees.

Along the Tigris the city spreads out into suburbs, the most important of which is Kazemain, on the western side of the river northward, opposite which on the eastern side lies Muazzam. The former of these is connected with western Bagdad by a very primitive horse-tramway, also a relic of Midhat Pasha's reforms. The two parts of the city are joined by pontoon bridges, one in the suburbs and one in the main city. The Tigris is at this point some 275 yds. wide and very deep. Its banks are of mud, with no other retaining walls than those formed by the foundations of the houses, which are consequently always liable to be undermined by the action of the water. The western part of the city, which is very irregular in shape, is occupied entirely by Shi'as. It has its own shops, bazaars, mosques, &c., and constitutes a quarter by itself. Beyond the wall line on that side vestiges of ancient buildings are visible in various directions, and the plain is strewn with fragments of bricks, tiles and rubbish. A burying-ground has also extended itself over a large tract of land, formerly occupied by the streets of the city. The form of the new or eastern city is that of an irregular oblong, about 1500 paces in length by 800 in breadth. The town has been built without the slightest regard to regularity; the streets are even more intricate and winding than those in most other Eastern towns, and with the exception of the bazaars and some open squares, the interior is little else than a labyrinth of alleys and passages. The streets are unpaved and in many places so narrow that two horsemen can scarcely pass each other; as it is seldom that the houses have windows facing the thoroughfares, and the doors are small and mean, they present on both sides the gloomy appearance of dead walls. All the buildings, both public and private, are constructed of furnace-burnt bricks of a yellowish-red colour, (particularly) derived from the ruins of other places, chiefly Madain (Ctesiphon), Wasit and Babylon, which have been plundered at various times to furnish materials for the construction of Bagdad.

The houses of the richer classes are regularly built about an interior court. The ground floor, except for the *serdab*, is given up to kitchens, store-rooms, servants' quarters, stables, &c. The principal rooms are on the first floor and open directly from a covered veranda, which is reached by an open staircase from the court. These constitute the winter residence of the family, reception rooms, &c. The roofs of the houses are all flat, surrounded by parapets of sufficient height to protect them from the observation of the dwellers opposite, and separate them from their neighbours. In the summer the population sleeps and dines upon the roofs, which thus constitute to all intents a third storey. The remainder of the day, so far as family life is concerned, is spent in the *serdab*, a cellar sunk somewhat below the level of the courtyard, damp from frequent wettings, with its half windows covered with hurdles thatched with camel thorn and kept dripping with water. Occasionally the *serdabs* are provided with punkahs.

Sometimes, in the months of June, July and August, when the *sherkhi* or south wind is blowing, the thermometer at break

of day is known to stand at 112° F., while at noon it rises to 119° and a little before two o'clock to 122°, standing at sunset at 114°, but this scale of temperature is exceptional. Ordinarily during the summer months the thermometer averages from about 75° at sunrise to 107° at the hottest time of the day. Owing to the extreme dryness of the atmosphere and the fact that there is always a breeze, usually from the N.W., this heat is felt much less than a greatly lower temperature in a more humid atmosphere. Moreover, the nights are almost invariably cool.

Formerly Bagdad was intersected by innumerable canals and aqueducts which carried the water of both the Euphrates and the Tigris through the streets and into the houses. To-day these have all vanished, with the exception of one aqueduct which still conveys the water of the Tigris to the shrine of Abd al-Qadir (ul-Kadir). The present population draws its water directly from the Tigris, and it is distributed through the city in goat-skins carried on the backs of men and asses. There is, of course, no sewerage system, the surfaces of the streets serving that purpose, and what garbage and refuse is not consumed by the dog scavengers washes down into the Tigris at the same place from which the water for drinking is drawn. As a consequence of these insanitary conditions the death-rate is very high, and in case of epidemics the mortality is enormous. At such times a large part of the population leaves the city and encamps in the desert northward.

The principal public buildings of the city, such as they are, lie in the eastern section along the river bank. To the north, just within the old wall line, stands the citadel, surrounded by a high wall, with a lofty clock-tower which commands an excellent view. To the south of this, also on the Tigris, is the *serai* or palace of the Turkish governor, distinguished rather for extent than grandeur. It is comparatively modern, built at different periods, a large and confused structure without proportion, beauty or strength. Somewhat farther southward, just below the pontoon bridge, stands the custom house, which occupies the site and is built out of the material of the medreseh or college of Mostansir (A.D. 1233). Of the original building of the caliph Mostansir all that remains is a minaret and a small portion of the outer walls. Farther down are the imposing buildings of the British residency. The German consulate also is on the river-front. As in all Mahomedan cities, the mosques are conspicuous objects. Of these very few are old. The Marjanieh mosque, not far from the minaret of Mostansir, although its body is modern, has some remains of old and very rich arabesque work on its surface, dating from the 14th century. The door is formed by a lofty arch of the pointed form guarded on both sides with red bands exquisitely sculptured and having numerous inscriptions. The mosque of Khaseki, supposed to have been an old Christian church, is chiefly distinguished for its prayer niche, which, instead of being a simple recess, is crowned by a Roman arch, with square pedestals, spirally fluted shafts and a rich capital of flowers, with a fine fan or shell-top in the Roman style. The building in its present form bears the date of A.D. 1682, but the sculptures which it contains belong probably to the time of the caliphate. The minaret of Suk el-Ghazl, in the south-eastern part of the city, dates from the 13th century. The other mosques, of which there are about thirty within the walls, excluding the chapels and places of prayer, are all of recent erection. Most of them are surmounted by bright-coloured cupolas and minarets. The Mosque of the Vizier, on the eastern side of the Tigris, near the pontoon bridge, has a fine dome and a lofty minaret, and the Great Mosque in the square of el Meidan, in the neighbourhood of the *serai*, is also a noble building.

The other mosques do not merit any particular attention, and in general it may be said that Bagdad architecture is neither distinctive nor imposing. Such attractions as the buildings possess are due rather to the richly coloured tiles with which many of them are adorned, or to inscriptions, like the Kufic inscription, dated A.D. 944, on the ruined *tebbe* of the Bektash dervishes in western Bagdad. More important than the mosques

proper are the tomb mosques. Of these, the most important and most imposing is that of Kazemain, in the northern suburb of the western city. Here are buried the seventh and ninth of the successors of Ali, recognized by Shi'as, namely Musa Ibn Ja'far el-Kazim, and his grandson, Mohammed Ibn Ali el-Jawad. In its present form this mosque dates from the 10th century. The two great domes above the tombs, the four lofty minarets and part of the façade of this shrine, are overlaid with gold, and from whatever direction the traveler approaches Bagdad, its glittering domes and minarets are the first objects which meet his eye. It is one of the four great shrines of the Shi'ite Moslems in the vilayet of Bagdad. Christians are not allowed to enter its precincts, and the population of the Kazemain quarter is so fanatical that it is difficult and even dangerous to approach it.

In the suburb of Muazzam, on the western side of the river, is the tomb of Abū Hanifa (q.v.), the canon lawyer. There is a large mosque with a painted dome connected with this tomb, which is an object of veneration to the Sunni Moslems, but it seems cheap and unworthy in comparison with the magnificent shrine of Kazemain. On the same side of the river, lower down, is the shrine of Abd al-Qadir al-Jilani (of Jilan), founder of the Qādirite (Kadaria) sect of dervishes, also a noted place of pilgrimage. The original tomb was erected about A.D. 1253, but the present fine dome above the grave is later by at least two or three centuries. The possessor or controller of this wealthy mosque is the *nakib*, locally pronounced *najeb*, or marshal of the nobles, whose office is to determine who are Se'ids, i.e. entitled to wear the green turban. He is second only to the governor or vali pasha in power, and indeed his influence is often greater than that of the official ruler of the vilayet. Just outside of the wall of the western city lies the tomb and shrine of Ma'ruf Karkhi, dating from A.D. 1215, which also is a place of pilgrimage. Close to this stands the so-called tomb of Sitte Zobeide (Zobaida), with its octagonal base and pineapple dome, one of the most conspicuous and curious objects in the neighbourhood of Bagdad. Unfortunately it is rapidly falling into decay. K. Niebuhr reports that in his day (A.D. 1750) this tomb bore an inscription setting forth that Ayesha Khanum, the wife of the governor of Bagdad, was buried here in 1488, her grave having been made in the ancient sepulchre of the lady Zobeide (Zobaida), granddaughter of Caliph Mansur and wife of Harun al-Rashid, who died in A.D. 831. The tomb was restored at the time of her burial, at which date it was already ancient, and it was evidently believed to be the tomb of Zobeide. Contemporary historians, however, state that Zobeide was actually buried in Kazemain, and moreover, early writers, who describe the neighbouring tomb and shrine of Ma'ruf Karkhi, make no reference to this monument.

About 3 m. west of Bagdad, on the Euphrates road, in or by a grove of trees, stands the shrine and tomb of Nabi Yusha or Kohen Yusha, a place of monthly pilgrimage to the Jews, who believe it to be the place of sepulture of Joshua, son of Josedech, the high priest at the close of the exilic period. This is one of four similar Jewish shrines in Irak; the others being the tomb of Ezra on the Shatt el-Arab near Korna, the tomb of Ezekiel in the village of Keifl near Kufa, and the well of Daniel near Hillah. This shrine is also venerated by Moslems, who call it the tomb of Yusuf (Joseph). The Jews bury here their chief priests, a right the Moslems at times contest, and in 1889 a serious conflict between Jews and Moslems resulted from an attempt of the former to exercise this right.

There are said to be about thirty *khans* or caravanserais in Bagdad for the reception of pilgrims and merchants and their goods, none of which is of any importance as a building, with the single exception of the khan el-Aurtmeih adjoining the Marjanieh mosque, to which it formerly belonged. This dates from A.D. 1356, and is said to occupy the site of an ancient Christian church. Its vaulted roof is a fine specimen of Saracenic brickwork. In recent years the demands of modern travel have led to the establishment of a hotel, which affords comfortable accommodation according to European methods. There is

also an English club-house. There are said to be about fifty baths in Bagdad, but in general they are inferior in construction and accommodation. The bazaars of Bagdad are extensive and well stocked, and while not so fine in construction as those of some other Eastern cities, they are more interesting in their contents and industries, because Bagdad has on the whole been less affected by foreign innovations. Several of the bazaars are vaulted over with brickwork, but the greater number are merely covered with flat beams which support roofs of dried leaves or branches of trees and grass. The streets of the entire business section of the city are roofed over in this manner, and in the summer months the shelter from the sun is very grateful, but in the winter these streets are extremely trying to the foreign visitor, owing to their darkness and their damp and chilly atmosphere.

Bagdad is about 500 m. from the Persian Gulf, following the course of the river. It maintains steam communication with Basra, its port, which is situated on the Shatt el-Arab, somewhat more than 50 m. from the Persian Gulf, by means of two lines of steamers, one English and one Turkish. British steamers were first placed upon the Tigris as a result of the expedition of Colonel F. R. Chesney, in 1836. Since that time, a British gunboat has been stationed before the residency, and British steamers have been allowed to navigate the river. Only two of these, however, maintain a weekly connexion with Basra, and they are quite inadequate to the freight traffic between the two cities. The more numerous vessels of the Turkish service are so small, so inadequately equipped and so poorly handled, that they are used for either passenger or freight transport only by those who cannot secure the services of the British steamers. The navigation of the Tigris during the greater party of its course from Bagdad to Korna is slow and uncertain. The river, running through an absolutely flat country, composed entirely of alluvial soil, is apt to change its channel. In flood time the country at places becomes a huge lake, through which it is extremely difficult to find the channel. In the dry season, the autumn and winter, on the other hand, there is danger of grounding on the constantly shifting flats and shoals. To add to the uncertainties of navigation, the inhabitants along the eastern bank of the stream frequently dig new canals for irrigation purposes, which both reduces the water of the river and tends to make it shift its channel. Above Bagdad there are no steamers on the Tigris, but sailing vessels of 30 tons and more navigate the river to Samarra and beyond. The characteristic craft for local service in the immediate environment of Bagdad is the *kufa*, a circular boat of basket-work covered with bitumen, often of a size sufficient to carry five or six horses and a dozen men. These boats have been employed from the remotest antiquity through all this region, and are often depicted on the old Assyrian monuments. Equally ancient are the rafts called *kellek*, constructed of inflated goat-skins, covered with a framework of wood, often supporting a small house for passengers, which descend the Tigris from above Diarbekr. The wood of these rafts is sold in Bagdad, and constitutes, in fact, the chief supply of wood in that city.

Bagdad also lies on a natural line of communication between Persia and the west, the ancient caravan route from Khorasan debouching from the mountains at this point, while another natural caravan route led up the Euphrates to Syria and the Mediterranean and still another up the Tigris to Armenia and the Black Sea. It was its situation at the centre of the lines of communication between India and Persia and the west, both by land and water, which gave the city its great importance in early times. With the change of the methods of transportation, its importance has naturally declined. The trade of Persia with the west now passes either through the ports of the Persian Gulf or northward over Trebizond, while India communicates with the west directly through the Suez Canal. Bagdad is, therefore, a decayed city. Money is scarce among all classes, and the wages of common labourers are scarcely half what is paid in Syria. It is still, however, the centre of distribution for a very large, if scantily populated, country, and it also derives much profit from pilgrims, lying as it does on the route which Shi'ite

pilgrims from Persia must take on their way to the sacred cities. It also possesses important shrines of its own which cause many pilgrims to linger there, and wealthy Indians not infrequently choose Bagdad as a suitable spot in which to end their days in the odour of sanctity. There has also sprung up of late years considerable direct trade between the European and American markets and Bagdad, and several foreign houses, especially English, have established themselves there. Germany also has invaded this market.

The staple articles of export are hides, wool and dates. The export trade of Bagdad amounts to about £750,000 annually, and the import trade to about £2,000,000. The imports consist of oil, cheap cottons, shoes and other similar goods, which are taking the place of the picturesque native manufactures. Even the Bedouin Arabs wear headresses of cheap European cotton stuff purchased in Bagdad or thereabouts, while the common water vessels throughout the country are five-gallon petroleum tins, which also furnish metal for the manufacture of various utensils in the native bazaars.

Bagdad is in communication with Europe by means of two lines of telegraph, one British and one Turkish, and two postal services. There is a British consul-general, who is also political agent to the Indian government. His state is second only to that of the British ambassador at Constantinople. Besides the gunboat in the river, he has a guard of sepoy, and there is an Indian post-office in the residency. Formerly the British government maintained a camel-post across the desert to Damascus. This was abandoned about 1880 when the Turks established a similar service. By means of the Turkish camel-post letters reached Damascus in nine days. There is also a Russian consul-general at Bagdad, and French, Austrian and American consuls.

The Euphrates Valley (or Bagdad) railway scheme, which had previously been discussed, was brought forward prominently in 1899, and Russian proposals to undertake it were rejected. British proposals followed, but were opposed by the Germans, who, as controlling the line to Konia in Asia Minor, claimed preference in the matter. A provisional convention was granted to a German company by the Porte, and an iradé was obtained in 1902. In 1903 there was considerable discussion as to the placing of the line under international control, and the question aroused special interest in England in view of the short route which the line would provide to India, in connexion with fast steamship services in the Mediterranean and the Persian Gulf. It was decided by the British government that the proposals made to this effect did not offer sufficient security. The financial arrangement as finally agreed upon was that German financiers should control 40% of the capital of the line; French (through the Imperial Ottoman Bank), 30%; Austrian, Swiss, Italian and Turkish, 20%; and the Anatolian Railway Company, 10%. In 1904 the line was completed from Konia through Ereğli to Bulğurlu. In 1908 an iradé sanctioned the extension across the Taurus to Adana, and so to Helif near Mardin (522 m.).

The population of Bagdad is estimated variously from 70,000 to 200,000; perhaps halfway between may represent approximately the reality. More than two-thirds of the population are Moslems, mostly Shi'as, with the exception of the official classes. There are about 34,000 Jews occupying a quarter of their own in the north-western part of the city; while in a neighbouring quarter dwell upwards of 6000 Christians, chiefly so-called Chaldeans or Nestorians. The Carmelites maintain a mission in Bagdad, as does also the (English) Church Missionary Society. The Jews are the only part of the population who are provided with schools. A school for boys was established by the *Alliance Israélite* in 1865, and one for girls in 1899. Besides these, there is also an apprentice school for industrial training.

The Jews constitute the wealthiest and most intelligent portion of the population. A large part of the foreign trade is in their hands, and at the season of the sheep-shearing their agents and representatives are found everywhere among the Bedouins and *Madian* Arabs of the interior, purchasing the wool and selling various commodities in return. They are the bankers of the country, and it is through their communications that the traveller

is able to obtain credit. They are also the dealers in antiquities, both genuine and fraudulent. Next to them in enterprise and prosperity are the Persians. The porters of the town are all Kurds, the river-men Chaldaean Christians. Every nation retains its peculiar dress. The characteristic, but by no means attractive, street dress of the Moslem women of the better class comprises a black horse-hair visor completely covering the face and projecting like an enormous beak, the nether extremities being encased in yellow boots reaching to the knee and fully displayed by the method of draping the garments in front.

Bagdad is governed by a pasha, assisted by a council. The pasha and the higher officials in general come from Constantinople, but a very large portion of the other Turkish officials seem to come from the town of Kerkuk. They constitute a class quite distinct from the native Arab population, and they and the Turkish government in general are intensely unpopular among the Arabs, an unpopularity increased by their religious differences, the Arabs being as a rule Shi'ites, the Turks Sunnites. Besides the court of superior officers, which assists the pasha in the general administration of the province, there is also a *mejlis* or mixed tribunal for the settlement of municipal and commercial affairs, to which both Christian and Jewish merchants are admitted. Besides these, there are the religious heads of the community, especially the *nakib* and Jewish high priest, who possess an undefined and extensive authority in their own communities. The Jewish chief priest may be said to be the successor of the *exilarch* or *resh galutha* of the earlier period.

History.—There are in or near Bagdad a few remains of a period antedating Islam, the most conspicuous of which are the ruins of the palace of Chosroes at Ctesiphon or Madain, about 15 m. below Bagdad on the east side of the river. Almost equally conspicuous, and a landmark through the whole region, is the ruin called Akerkuf, in the desert, about 9 m. westward of Bagdad. This consists of a huge tower of unburned brick resting on a small hill of debris, the whole rising to a height of 100 ft. or more above the plain, in the centre of a network of ancient canals. Inscribed bricks found in the neighbourhood seem to connect this ruin with Kurigalzu, king of Babylon about 1300 B.C. Under substantially its present name, Akukafa, it is mentioned as a place of importance in connexion with the canals as late as the Abbasid caliphate. Within the limits of the city itself, on the west bank of the Tigris, are the remains of a quay, first observed by Sir Henry Rawlinson, at a period of low water, in 1849, built of bricks laid in bitumen, and bearing an inscription of Nebuchadrezzar, king of Babylon. *Baghdadu* was an ancient Babylonian city, dating back perhaps as far as 2000 B.C., the name occurring in lists in the library of Assur-bani-pal. It is also mentioned on the Michaux stone, found on the Tigris near the site of the present city, and dating from the time of Tiglath-Pileser I. (1100 B.C.) The quay of Nebuchadrezzar, mentioned above, establishes the fact that this ancient city of *Baghdadu* was located on the site of western or old Bagdad (see further under CALIPHATE: *Abbasids*, sections 2 foll.). References in the Jewish *Talmud* show that this city still continued to exist at and after the commencement of our era; but according to Arabian writers, at the time when the Arab city of Bagdad was founded by the caliph Mansur, there was nothing on that site except an old convent. One may venture to doubt the literal accuracy of this statement. It is clear that the ancient name, at least, still held firm possession of the site and was hence inherited by the new city.

The Arab city, the old or round city of Bagdad, was founded by the caliph Mansur of the Abbasid dynasty on the west side of the Tigris just north of the Isa canal in A.D. 762. It was a mile in diameter, built in concentric circles, with the mosque and palace of the caliph in the centre, and had four gates toward the four points of the compass. It grew with great rapidity. The suburb of Rusafa, on the eastern bank, sprang up almost immediately, and after the siege and capture of the round city by Mamun, in 814, this became the most important part of the capital. The period of the greatest prosperity of Bagdad was the period from its foundation until the death of Mamun, the

successor of Harun, in 833. During this period the city, including both sides of the river, was 5 m. across within the walls, and it is said to have had a population of 2,000,000 souls. In literature, art and science, it divided the supremacy of the world with Cordova; in commerce and wealth it far surpassed that city. How its splendour impressed the imagination may be seen from the stories of the *Arabian Nights*. It was the religious capital of all Islam, and the political capital of the greater part of it, at a time when Islam bore the same relation to civilization which Christendom does to-day. As in Spanish Islam, so in the lands of the eastern caliphate, the Jews were treated relatively with favour. The seat of the *exilarch* or *resh galutha* was transferred from Pumbedita (Pumbeditha or Pombethida) in Babylonia to Bagdad, which thus became the capital of oriental Judaism; from then to the present day the Jews have played no mean part in Bagdad.

Situated in a region where there is no stone, and practically no timber, Bagdad was built, like all the cities of the Babylonian plain, of brick and tiles. Its buildings depended for their effect principally on mass and gorgeous colouring. Like old Babylon, also, Bagdad was celebrated throughout the world for its brilliant-coloured textile fabrics. So famous was the silk of Bagdad, manufactured in the Attabieh quarter (named after Attab, a contemporary of the Prophet), that the place-name passed over into Spanish, Italian, French and finally into English in the form of "tabby," as the designation of a rich-coloured watered silk. Depending on coloured tiles and gorgeous fabrics for their rich effects, nothing of the buildings of the times of Harun al-Rashid or Mamun, once counted so magnificent, have come down to us. All have perished in the numerous sieges and inundations which have devastated the city.

With the rise of the Turkish body-guard under Mamun's successor, Mo'tassim, began the downfall of the Abbasid dynasty, and with it of the Abbasid capital, Bagdad. Mo'tassim founded Samarra, and for fifty-eight years caliph and court deserted Bagdad (see CALIPHATE, sect. C). Then, in A.D. 865, Mosta'in, attempting to escape from the tyranny of the Turkish guard, fled back again to Bagdad. The attempt was futile, Bagdad was besieged and taken, and from that time until their final downfall the Abbasid caliphs were mere puppets, while the real rulers were successively the Turkish guard, the Buyids and the Seljuks. But during all this period the caliphs continued to be the religious heads of Islam and their residence its capital. Bagdad, accordingly, although fallen from its first eminence, continued to be a city of the first rank, and during most of that period still the richest and most splendid city in the world. Its religious importance is attested by the number of its great shrines dating from those times; as for its wealth and size, while, as stated above, few remains of the actual buildings of that period survive, we still have abundant records describing their character, their size and their position. With the last century of the caliphates began a more rapid decline. From the records of that period it seems that the present city is identical in the position of its walls and the space occupied by the town proper with Bagdad at the close of the 12th century, the period when this rapid decline had already advanced so far that the western city is described by travellers as almost in ruins, and the eastern half as containing large uninhabited spaces. With the capture of the city by the Mongols, under Hulagu (Hulaku), the grandson of Jenghiz Khan, in 1258, and the extinction of the Abbasid caliphate of Bagdad, its importance as the religious centre of Islam passed away, and it ceased to be a city of the first rank, although the glamour of its former grandeur still clung to it, so that even to-day in Turkish official documents it is called the "glorious city."

The Tatars retained possession of Bagdad for a century and a half, until about A.D. 1400. Then it was taken by Timur, from whom the sultan Ahmed Ben Avis fled, and, finding refuge with the Greek emperor, contrived later to repossess himself of the city, whence he was finally expelled by Kara Yusuf of the Kara-Kuyunli ("Black Sheep") Mongols in 1417. About 1468 the descendants of the latter were driven out by Uzun Hasan or Cassim of the Ak-Kuyunli ("White Sheep") Mongols. He and

his descendants reigned in Bagdad until Shah Ismail I., the founder of the Safawid royal house of Persia, made himself master of the place (c. 1502 or 1508). From that time it continued for a long period an object of contention between the Turks and the Persians. It was taken by Suleiman I. the Magnificent and retaken by Shah Abbas the Great, in 1620. Eighteen years later, in 1638, it was besieged by Sultan Murad IV., with an army of 300,000 men and, after an obstinate resistance, forced to surrender, when, in defiance of the terms of capitulation, most of the inhabitants were massacred.

Since that period it has remained nominally a part of the Turkish empire; but with the decline of Turkish power, and the general disintegration of the empire, in the first half of the 18th century, a then governor-general, Ahmed Pasha, made it an independent pashalick. Nadir Shah, the able and energetic usurper of the Persian throne, attempting to annex the province once more to Persia, besieged the city, but Ahmed defended it with such courage that the invader was compelled to raise the siege, after suffering great loss. Turkish authority over the pashalick was again restored in the first part of the 19th century.

AUTHORITIES.—Allen's *Indian Mail* (1874); J. S. Buckingham, *Travels in Mesopotamia* (1827); Sir R. K. Porter, *Travels in Georgia, Persia, Armenia and Ancient Babylonia* (1821-1822); J. M. Kinneir, *Geographical Memoir of the Persian Empire* (1813); F. R. Chesney, *Expedition* (1850); J. B. L. J. Rousseau, *Description du pachalik de Bagdad* (1809); J. R. Wellsted, *City of the Caliphs*; A. N. Groves, *Residence in Bagdad* (1830-1832); *Transactions of Bombay Geog. Soc.* (1856); G. le Strange, *Description of Mesopotamia and Bagdad* (about A.D. 900); "Greek Embassy to Bagdad in A.D. 917," in *Journal Royal Asiatic Society*, 1895, 1897; *Bagdad under the Abbasid Caliphate* (1901).

BAGÉ, a town and municipality of the state of Rio Grande do Sul, Brazil, about 176 m. by rail W.N.W. of the city of Rio Grande do Sul. Pop. of the municipality (1890) 22,692. It is situated in a hilly region 774 ft. above sea-level, and is the commercial centre of a large district on the Uruguayan border in which pastoral occupations are largely predominant. This region is the watershed for southern Rio Grande do Sul, from which streams flow E. and S.E. to the Atlantic coast, and N.W. and S.W. to the Uruguayan river. The town dates from colonial times, and has always been considered a place of military importance because of its nearness to the Uruguay frontier, only 25 m. distant. It was captured by the Argentine general Lavalle in 1827, and figured conspicuously in most of the civil wars of Argentina. It is also much frequented by Uruguayan revolutionists.

BAGEHOT, WALTER (1826-1877), English publicist and economist, editor of the *Economist* newspaper from 1860 to his death, was born at Langport, Somerset, on the 3rd of February 1826, his father being a banker at that place. Bagehot was altogether a remarkable personality, his writings on different subjects exhibiting the same bent of mind and characteristics,—philosophic reflectiveness, practical common-sense, a bright and buoyant humour, brilliant wit and always a calm and tolerant judgment of men and things. Though he belonged to the Liberal party in politics he was essentially of conservative disposition, and often spoke with sarcastic boastfulness to his Liberal friends of the stupidity and tenacity of the English mind in adhering to old ways, as displayed in city and country alike. His life was comparatively uneventful, as he early gave up to literature the energies which might have gained him a large fortune in business or a great position in the political world. He took his degree at the London University in 1848, and was called to the bar in 1852, but from an early date he joined his father in the banking business of Stuckey & Co. in the west of England, and during a great part of his life, while he was editor of the *Economist*, he managed the London agency of the bank, lending its surplus money in "Lombard Street," and otherwise attending to its London affairs. He became also an underwriter at Lloyd's, taking no part, however, in the active detailed business, which was done for him by proxy.

Bagehot's connexion with the *Economist* began in 1858, about which time he married a daughter of the first editor, the Right Hon. James Wilson, at that time secretary of the treasury, and afterwards secretary of finance in India. Partly through this

connexion he was brought into the inside of the political life of the time. He was an intimate friend of Sir George Cornewall Lewis, and was afterwards in constant communication with many of the political chiefs, especially with Gladstone, Robert Lowe and Grant Duff, and with the permanent heads of the great departments of state. In the city in the same way he was intimate with the governor and directors of the Bank of England, and with leading magnates in the banking and commercial world; while his connexion with the Political Economy Club brought him into contact in another way with both city and politics. His active life in business and politics, however, was not of so absorbing a kind as to prevent his real devotion to literature, but the literature largely grew out of his activities, and of no one can it be said more truly than of Bagehot that the atmosphere in which he lived gave tone and colour and direction to his studies, one thing of course acting and reacting on another. The special note of his books, apart from his remarkable gift of conversational epigrammatic style, which gives a peculiar zest to the writing, is the quality of scientific dispassionate description of matters which were hardly thought of previously as subjects of scientific study. This is specially the case with the two books which perhaps brought him the most reputation, *The English Constitution* (1867) and *Lombard Street* (1873). They are both books of observation and description. The English constitution is described, not from law books and as a lawyer would describe it, but from the actual working, as Bagehot himself had witnessed it, in his contact with ministers and the heads of government departments, and with the life of the society in which the politicians moved. The true springs and method of action are consequently described with a vivid freshness which gives the book a wonderful charm, and makes it really a new departure in the study of politics. It is the same with *Lombard Street*. The money market is there pictured as it really was in 1850-1870, and as Bagehot saw it with philosophic eyes. Beginning with the sentence, "The objects which you see in Lombard Street are the Bank of England, the joint stock banks, the private banks and the discount houses," he describes briefly and clearly the respective functions of these different bodies in the organism of the city, according to his own close observation as a banker himself, knowing the ways and thoughts of the men he describes, and as a man of business likewise in other ways, knowing at first hand the relation of banking to the trade and commerce of the country. *Lombard Street* is perhaps a riper work than *The English Constitution*, as its foundation was really laid in 1858 in a series of articles which Bagehot then wrote in the *Economist*, though it was not published till the early 'seventies, after it had been twice rewritten and revised with infinite labour and care. *Lombard Street*, like *The English Constitution* in political studies, is thus a new departure in economic and financial studies, applying the same sort of keen observation which Adam Smith used in the analysis of business generally to the special business of banking and finance in the complex modern world. It is, perhaps, not going too far to say that the whole theory of a one-reserve system of banking and how to work it, and of the practical means of fixing an "apprehension minimum" below which the reserve should not fall, originated in *Lombard Street* and the articles which were the foundation of it; and the subsequent conduct of banking in England and throughout the world has been infinitely better and safer in consequence. A like note is also struck in *Physics and Politics* (1869), which is a description of the evolution of communities of men. The materials here are derived mainly from books, the surface to be observed being so extensive, but the attitude is precisely the same, that of a scientific observer. To a certain extent the *Physics and Politics* had even a more remarkable influence on opinion, at least on foreign opinion, than *The English Constitution* or *Lombard Street*. It "caught on" as a development of the theory of evolution in a new direction, and Darwin himself was greatly interested, while one of the pleasures of Bagehot's later years was to receive a translation of the book into the Russian language. In *Literary Studies* (1879) and *Economic Studies* (1880), published after his death, there is more scope than in the books already mentioned

for other characteristics besides those of the scientific observer, but observation always comes to the front, as in the account of Ricardo, whom Bagehot describes as often, when he is most theoretical, really describing what a first-rate man of business would do and think in actual transactions. The observation, of course, is that of a type of business man in the city to which Ricardo as well as Bagehot belonged, though Ricardo could hardly look at it from the outside as Bagehot was able to do.

Bagehot had great city, political and literary influence, to which all his activities contributed, and much of his influence was lasting. In politics and economics especially his habit of scientific observation affected the tone of discussion, and both the English constitution and the money market have been better understood generally because he wrote and talked and diffused his ideas in every possible way. He was unsuccessful in two or three attempts to enter parliament, but he had the influence of far more than an ordinary member, as director of the *Economist* and as the adviser behind the scenes of the ministers and permanent heads of departments who consulted him. His death, on the 24th of March 1877, occurred at Langport very suddenly, when he was in the fullest mental vigour and might have looked forward to the accomplishment of much additional work and the exercise of even wider influence.

It is impossible to give a full idea of the brightness and style of Bagehot's conversation, although the conversational style of his writing may help those who did not know him personally to understand it. With winged words he would transfix a fallacy or stamp a true idea so that it could not be forgotten. He was certainly greater than his books and always full of ideas. The present writer recalls two notions he had, not for writing new books himself, but as something that might be done. One was that there might be a history of recent politics with new lights if some one were to do it who knew the family connexions and history of English politicians. This was *apropos* of the passage of a certain bill through parliament, when the head of the department in the House of Commons failed and the management of the measure was taken by the chancellor of the exchequer himself, a relative of the permanent head of the department concerned, who was thus able to carry his own ideas in legislation notwithstanding the failure of his political chief. Another book he wished to see written was an account of the differences in the administrative systems of England and Scotland, by which he had been greatly impressed, and the differences not being in detail, but in fundamental idea and in form, so that no judicial or other officers in the one were represented in the other by corresponding functionaries. Many other illustrations might be given of his fulness of ideas which helped to make him an ideal editor. Reference must also be made to the assistance which Bagehot gave as a journalist to the study of statistics. From the manipulation of figures he was most averse, and he rather boasted that he was unable to add up. But he was a most excellent mathematician, and no one could be so careful as he was about the logic of the figures got together for his articles, which he always most carefully scrutinized. He would frequently point out that his figures were argumentative merely, and did not by themselves establish an argument. He was always anxious, again, to impress on those about him that a subject could not be studied with the help of figures and accounts alone. Whether it was insurance, or banking, or underwriting, or shipowning, he insisted that some one who knew the business should see the writing before it was published. Knowing so many departments of business from actual experience, he was a host in himself as referee, but when in doubt he would always consult some one who knew the facts; and he used his great influence so well that in subsequent years it inspired indirectly not a few who were hardly aware of his claims to be a statistician at all. (R. G. N.)

BAGELKHAND, or BAGHELKHAND, a tract of country in central India, occupied by a collection of native states. The Bagelkhand agency is under the political superintendence of the governor-general's agent for central India, and under the direct jurisdiction of a political agent who is also superintendent

of the Rewa state, residing ordinarily at Sutna or Rewa. The agency consists of Rewa state and eleven minor states and estates, of which the more important are Maihar, Nagode and Sohawal. The total area is 14,323 sq. m., and the population in 1901 was 1,555,024, showing a decrease of 11% in the decade, due to the results of famine. The rainfall was very deficient in 1895-1897, causing famine in 1897; and in 1899-1900 there was drought in some sections. The agency was established in March 1871. Until that date Bagelkhand was under the Bundelkhand agency, with which it is geographically and historically connected; a general description of the country will be found under that heading. According to Wilson, in his *Glossary of Indian Terms*, the Baghelas, who give their name to this tract of country, are a branch of the Sisodhya Rajputs who migrated eastward and once ruled in Gujarat.

BAGGĀRA ("Cowherds"), African "Arabs" of Semitic origin, so called because they are great cattle owners and breeders. They occupy the country west of the White Nile between the Shilluk territory and Dar Nuba, being found principally in Kordofan. They are true nomad Arabs, having intermarried little with the Nuba, and have preserved most of their national characteristics. The date of their arrival in the Sudan is uncertain: they appear to have drifted up the Nile valley and to have dispersed the original Nuba population. A purely pastoral people, they move from pasture to pasture, as food becomes deficient. The true Baggāra tribesmen employ oxen as saddle and pack animals, carry no shield, and though many possess firearms the customary weapons are lance and sword. They have always had the reputation of being resolute fighters. Engaged from the earliest times in the slave trade, they were among the first, as they were certainly the most fervent, supporters of the mahdi when he rose in revolt against the Egyptians (1882). They constituted his real fighting force, and to their fanatical courage his victories were due. Their decision to follow him out of their own country to Khartoum brought about the fall of that city. The mahdi's successor, the khalifa Abdullah, was a Baggāra, and throughout his rule the tribe held the first place in his favour. They have been described as "men who look the fends they really are—of most sinister expression, with murder and every crime speaking from their savage eyes. Courage is their only good quality." They are famous, too, as hunters of big game, attacking even elephants with sword and spear. G. A. Schweinfurth declares them the best-looking of the Nile nomads, and the men are types of physical beauty, with fine heads, erect athletic bodies and sinewy limbs. There is little that is Semitic in their appearance. Their skins vary in colour from a dark red-brown to a deep black; but their features are regular and free of negro characteristics. In mental power they are much superior to the indigenous races around them. They have a passion for fine clothes and ornaments, tricking themselves out with glass trinkets, rings and articles of ivory and horn. Their mode of hair-dressing (mop-fashion) earned them, in common with the Hadendoa, the name of "Fuzzy-wuzzies" among the British soldiers in the campaigns of 1884-98.

See G. A. Schweinfurth, *Heart of Africa* (1874); Sir F. R. Wingate, *Mahdism and the Egyptian Sudan* (1891); *Anglo-Egyptian Sudan*, edited by Count Gleichen (1905); A. H. Keane, *Ethnology of the Egyptian Sudan* (1884).

BAGGENSEN, JENS IMMANUEL (1764-1826), Danish poet, was born on the 15th of February 1764 at Korsør. His parents were very poor, and before he was twelve he was sent to copy documents at the office of the clerk of the district. He was a melancholy, feeble child, and before this he had attempted suicide more than once. By dint of indomitable perseverance, he managed to gain an education, and in 1782 entered the university of Copenhagen. His success as a writer was coeval with his earliest publication; his *Comical Tales* in verse, poems that recall the *Broad Girths* that Colman the younger brought out a decade later, took the town by storm, and the struggling young poet found himself a popular favourite at twenty-one. He then tried serious lyrical writing, and his tact, elegance of

manner and versatility, gained him a place in the best society. This sudden success received a blow in 1780, when a very poor opera, *Holse Danske*, which he had produced, was received with mockery and a reaction against him set in. He left Denmark in a rage and spent the next years in Germany, France and Switzerland. He married at Berne in 1790, began to write in German and published in that language his next poem, *Alpenlied*. In the winter of the same year he returned to his mother-country, bringing with him as a peace-offering his fine descriptive poem, the *Labyrinth*, in Danish, and was received with unbounded homage. The next twenty years were spent in incessant restless wanderings over the north of Europe, Paris latterly becoming his nominal home. He continued to publish volumes alternately in Danish and German. Of the latter the most important was the idyllic epos in hexameters called *Parthenais* (1803). In 1806 he returned to Copenhagen to find the young Öhlenschläger installed as the great poet of the day, and he himself beginning to lose his previously unbounded popularity. Until 1820 he resided in Copenhagen, in almost unceasing literary feud with some one or other, abusing and being abused; the most important feature of the whole being Baggensen's determination not to allow Öhlenschläger to be considered a greater poet than himself. He then left Denmark for the last time and went back to his beloved Paris, where he lost his second wife and youngest child in 1822, and after the miseries of an imprisonment for debt, fell at last into a state of hopeless melancholy madness. In 1826, having slightly recovered, he wished to see Denmark once more, but died in the freedmen's hospital at Hamburg on his way, on the 3rd of October, and was buried at Kiel. His many-sided talents achieved success in all forms of writing, but his domestic, philosophical and critical works have long ceased to occupy attention. A little more power of restraining his egotism and passion would have made him one of the wittiest and keenest of modern satirists, and his comic poems are deathless. The Danish literature owes Baggensen a great debt for the firmness, polish and form which he introduced into it—his style being always finished and elegant. With all his faults he stands as the greatest figure between Holberg and Öhlenschläger. Of all his poems, however, the loveliest and best is a little simple song, *There was a time when I was very little*, which every Dane, high or low, knows by heart, and which is matchless in its simplicity and pathos. It has outlived all his epics. (E. G.)

BAGGING, the name given to the textile stuff used for making bags (see also SACKING and TARPULIN). The material used was originally Baltic hemp, while in the beginning of the 19th century Sann hemp or India hemp was also employed. Modern requirements call for so many different types of bagging that it is not surprising to find all kinds of fibres used for this purpose. Most bagging is now made from yarns of the jute fibre. The cloth is, in general, woven with the plain weave, and the warp threads run in pairs, but large quantities of bags are made from cloths with single warp threads. In both cases the weave used for the cloth is that shown at A in the figure, but when double threads of warp are used, the arrangement is equivalent to the weave shown at B. The interlacings of the two sets of warp and weft for single and double warp are shown respectively at C and D, the black marks indicating the warp threads, and the white or blanks showing the weft. The particular style of bagging depends, naturally, upon the kind of material it is intended to hold. The coarsest type of bagging is perhaps that known as "cotton bagging," which derives its name from the fact that it is used in the manufacture of bags for transporting raw cotton from the United States of America. It is a heavy fabric 42 in. wide, and weighs from 2 to 2½ lb per yard. A similar, but rather finer make, is used for Sea Island and other fine cotton, and for any species of fibrous material; but for grain, spices, sugar, flour, coffee, manure, &c., the threads of warp and weft must lie closer, and the warp is usually single. For transporting such



B



substances as sugar, it is not uncommon to line the bag with paper, which excludes foreign matter, and minimizes the loss. Although there are large quantities of seamless bags woven in the loom, the greater part of the cloth is woven in the ordinary way. It is then cut up into the required sizes by hand and by special machines, and afterwards sewn by one of the chain-stitch or straight-stitch bag sewing-machines.

BAGHAL, a small native state in the Punjab, India. It is one of the group known as the Simla Hill states, and has an area of 124 sq. m.; pop. (1901) 25,720, showing an increase of 5% in the decade; a revenue £3300.

BAGHERIA, a town of the province of Palermo, Sicily, 8 m. by rail E. by S. of Palermo. Pop. (1901) 18,218. It contains many villas of the aristocracy of Palermo, the majority of which were erected in the 18th century, but have now fallen into decay.

BAGILLT, a town of Flintshire, North Wales, 1½ m. from Chester, on the London & North Western railway, in the ancient parish of Holywell. Pop. (1901) 2637. Its importance is due to its zinc, lead, iron, alkali and kindred works, and its collieries. Above Bagillt is Bryn Dychwelch, "Hill of Retreat," so called from the retreat effected by Owen Gwynedd, when pursued by Henry II., with superior numbers. Near is Mostyn Hall, dating from the time of Henry VI., the seat of one of the oldest Welsh families. Here are antiquities and MSS. (old British history and Welsh, brought from Gloddaeth), a harp dated 1568, torques (*torchas*), &c. Henry VII., then earl of Richmond, is said to have been concealed here in the reign of Richard III., when the lord of Mostyn was Richard ap Howell.

BAGIMOND'S ROLL. In 1274 the council of Lyons imposed a tax of a tenth part of all church revenues during the six following years for the relief of the Holy Land. In Scotland Pope Gregory X. entrusted the collection of this tax to Master Boiamund (better known as Bagimund) de Vita, a canon of Asti, whose roll of valuation formed the basis of ecclesiastical taxation for some centuries. Boiamund proposed to assess the tax, not according to the old conventional valuation but on the true value of the benefices at the time of assessment. The clergy of Scotland objected to this innovation, and, having held a council at Perth in August 1275, prevailed upon Boiamund to return to Rome for the purpose of persuading the pope to accept the older method of taxation. The pope insisted upon the tax being collected according to the true value, and Boiamund returned to Scotland to superintend its collection. A fragment of Bagimond's Roll in something very like its original form is preserved at Durham, and has been printed by James Raine in his *Priory of Coldingham* (Publications of the Surtees Society, vol. xii.). It gives the real values in one column and tenth parts in another column of each of the benefices in the archdeaconry of Lothian: The actual taxation to which this fragment refers was not the tenth collected by Boiamund but the tenth of all ecclesiastical property in England, Scotland, Wales and Ireland granted by Pope Nicholas IV. to Edward I. of England in the year 1288. The fragment should therefore be regarded as supplementary to the *Taxatio Ecclesiastica Angliæ et Walliæ* printed by the Record Commissioners in 1802. Although no contemporary copy of Bagimond's Roll is known to exist, at least three documents give particulars of the taxation of the Church of Scotland in the 16th century, which are based upon the original roll.

See *Statuta Ecclesiæ Scotticæ* (Bannatyn Club, Edinburgh, 1866).

BAGIRMI, a country of north-central Africa, lying S.E. of Lake Chad and forming part of the Chad circumscription of French Congo. It extends some 240 m. north to south and has a breadth of about 150 m., with an area of 20,000 sq. m. The population in 1903 was estimated at 100,000, having been greatly reduced as the result of wars and slave-raiding. By including districts S. and S.E. occupied by former vassal states, the area and population of Bagirmi would be more than doubled. The surface of the country, which lies about 1000 ft. above sea-level, is almost flat with a very slight inclination N. to Lake Chad. It forms part of what seems to be the basin of an immense lake, of which Chad is the remnant. The soil is clay. The river Shari

(q.v.) forms the western boundary. Numerous tributaries of the Shari flow through the country, but much of the water is absorbed by swamps and sand-obstructed channels, and seasons of drought are recurrent. The southern part of the country is the most fertile. Among the trees the acacia and the dum-palm are common. Various kinds of rubber vine are found. The fauna includes the elephant, hippopotamus, lion and several species of antelope. Ants are very numerous. Millet and sesame are the principal grains cultivated. Rice grows wild, and several kinds of Poa grass are used as food by the natives. Cotton and indigo are grown to a considerable extent, especially by Bornu immigrants. The capital is Chekna, on a tributary of the Shari, the former capital, Massenia, having been destroyed in 1808. Fort Lamy at the confluence of the Logone and Shari, and Fort de Coiteat on the middle Shari, are French posts round which towns have grown. Trade is chiefly with Yola, a town on the Benue in British Nigeria, and with Khartoum via Wadai. There is also an ancient caravan route which runs through Kanem and across the Sahara to Tripoli.

The population of Bagirmi is mixed. Negroid peoples predominate, but there are many pastoral Fula and Arabs. The Bagirmese proper are a vigorous, well-formed race of Negroid-Arab blood, who, according to their own traditions, came from the eastward several centuries ago, a tradition borne out by their language, which resembles those spoken on the White Nile. On their arrival they appear to have taken the place of the Bulala dynasty. They subdued the Fula and Arabs already settled in the district, and after being converted to Islam under Abdullah, their fourth king (about 1600), they extended their authority over a large number of tribes living to the south and east. The most important of these tribes are the Saras, Gaberi, Somrai, Gulla, Nduka, Nuba and Sokoro. These pagan tribes were repeatedly raided by the Bagirmese for slaves. Most of them are of a primitive type and appear to be dying out. The Saras are remarkable for their herculean stature, and are one of the most promising of African races. Tree worship is prevalent among the Somrai and the Gaberi. All the tribes believe in a supreme being whose voice is the thunder. Polygamy is general in upper Bagirmi, where some traces of a matriarchal stage of society linger, one small state being called Beled-el-Mra, "Women's Land," because its ruler is always a queen.

Bagirmi was made known to Europe by the travels of Dixon Denham (1823), Heinrich Barth (1852), who was imprisoned by the Bagirmese for some time, Gustav Nachtigal (1872), and P. Matteucci and A. M. Massari (1881). The country in 1871 had been conquered by the sultan of Wadai, and about 1890 was over-run by Rabah Zobeir (q.v.) who subsequently removed farther west to Bornu. About this time French interest in the countries surrounding Lake Chad was aroused. The first expedition led thither through Bagirmi met with disaster, its leader, Paul Crampel, being killed by order of Rabah. Subsequent missions were more fortunate, and in 1897 Emile Gentil, the French commissioner for the district, concluded a treaty with the sultan of Bagirmi, placing his country under French protection. A resident was left at the capital, Massenia, but on Gentil's withdrawal Rabah descended from Bornu and forced sultan and resident to flee. It was not until after the death of Rabah in battle and the rout of his sons (1901) that French authority was firmly established. Kanem, a country north of Bagirmi and subject in turn to it and to Wadai, was at the same time brought under French control. So far as its European rivals are concerned, the French right to these regions is based on the Franco-German convention of the 15th of March 1894 and the Anglo-French declaration of the 21st of March 1899.

See H. Barth, *Travels and Discoveries in North and Central Africa* (London, 1857-1858); G. Nachtigal, *Sahara and Sudan* (Berlin, 1879-1880); E. Gentil, *La Côte de l'Empire de Rabah* (Paris, 1902). Also FRENCH CONGO.

BAGNACAVALLO, BARTOLOMEO (1484-1542), Italian painter. His real name was RAMENGI, but he received the cognomen Bagnacavallo from the little village where he was born. He studied first under Francia, and then proceeded to

Rome, where he became a pupil of Raphael. While studying under him he worked along with many others at the decoration of the gallery in the Vatican, though it is not known what portions are his work. On his return to Bologna he quickly took the leading place as an artist, and to him were due the great improvements in the general style of what has been called the Bolognese school. His works were considered to be inferior in point of design to some other productions of the school of Raphael, but they were distinguished by rich colouring and graceful delineation. They were highly esteemed by Guido Reni and the Carracci, who studied them carefully and in some points imitated them. The best specimens of Bagnacavallo's works, the "Dispute of St Augustine," and a "Madonna and Child," are at Bologna.

BAGNÈRES-DE-BIGORRE, a town of south-western France, capital of an arrondissement in the department of Hautes-Pyrénées, 13 m. S.S.E. of Tarbes on a branch line of the Southern railway. Pop. (1906) 6661. It is beautifully situated on the left bank of the Adour, at the northern end of the valley of Campan, and the vicinity abounds in picturesque mountain scenery. The town is remarkably neat and clean and many of the houses are built or ornamented with marble. It is one of the principal watering-places in France, and has some fifty mineral springs, characterized chiefly by the presence of sulphate of lime or iron. Their temperature ranges approximately from 50° to 122° Fahr., and they are efficacious in cases of rheumatism, nervous affections, indigestion and other maladies. The season begins in May and terminates about the end of October, during which time the population is more than doubled. The Promenade des Coustous is the centre of the life of Bagnères. Close by stands the church of St Vincent of the 14th and 15th centuries. The old quarter of the town, in which there are several old houses, contains a graceful octagonal tower of the 15th century, the remains of a Jacobin monastery. The Néothermes, occupying part of the casino, and the Thermes (dating from 1824), which has a good library, are the principal bathing-establishments; both are a town property. The other chief buildings include the Carmelite church, remains of the old church of St Jean, a museum and the town-hall. Bagnères has tribunals of first instance and of commerce, and a communal college. The manufacture of *barège*, a light fabric of silk and wool, and the weaving and knitting of woollen goods, wood-turning and the working of marble found in the neighbourhood and imported from elsewhere, are among the industries, and there are also slate quarries. Bagnères was much frequented by the Romans, under whom it was known as *Vicus Aquensis*, but afterwards lost its renown. It begins to appear again in history in the 12th century when Centulle III., count of Bigorre, granted it a liberal charter. The baths rose into permanent importance in the 16th century, when they were visited by Jeanne d'Albret, mother of Henry IV., and by many other distinguished persons.

BAGNÈRES-DE-LUCHON, a town of south-western France, in the department of Haute-Garonne, 87 m. S.S.W. of Toulouse, on a branch line of the Southern railway from Montréjeau. Pop. (1906) 3448. The town is situated at the foot of the central Pyrenees in a beautiful valley at the confluence of the One and the Pique. It is celebrated for its thermal springs and as a fashionable resort. Of the promenades the finest and most frequented are the Allées d'Etigny, an avenue planted with lime-trees, at the southern extremity of which is the Thermes, or bathing-establishment, one of the most complete in existence. The springs, which number 48, vary in composition, but are chiefly impregnated with sulphate of sodium, and range in temperature from 62° to 150°. A large casino was opened in the town in 1877. The discovery of numerous Roman remains attests the antiquity of the baths, which are identified with the *Onestiorum Thermae* of Strabo. Their revival in modern times dates from the latter half of the 18th century, and was due to Antoine Mègret d'Etigny, *intendant* of Auch.

BAGOAS, a Persian name (*Bagoi*), a shortened form of names like Bagadāta, "given by God," often used for eunuchs. The best-known of these ("Bagoses" in Josephus) became the confidential minister of Artaxerxes III. He threw in his lot with the

Rhodian condottiere Mentor, and with his help succeeded in subjecting Egypt again to the Persian empire (probably 342 B.C.). Mentor became general of the maritime provinces, suppressed the rebels, and sent Greek mercenaries to the king, while Bagoas administered the upper satrapies and gained such power that he was the real master of the kingdom (Diod. xvi. 50; cf. Didymus, *Comm. in Demosth. Phil.* vi. 5). He became very wealthy by confiscating the sacred writings of the Egyptian temples and giving them back to the priests for large bribes (Diod. xvi. 51). When the high priest of Jerusalem, Jesus, murdered his brother Johannes in the temple, Bagoas (who had supported Johannes) put a new tax on the Jews and entered the temple, saying that he was purer than the murderer who performed the priestly office (Joseph. *Ant. xi.* 7.1). In 338 Bagoas killed the king and all his sons but the young Arses (*q.v.*), whom he raised to the throne; two years later he murdered Arses and made Darius III. king. When Darius attempted to become independent of the powerful vizier (*χυλάρχο*), Bagoas tried to poison him too; but Darius was warned and forced him to drink the poison himself (Diod. xvii. 5; Johann. Antioch. p. 38, 39 ed. Müller; Arrian. ii. 14, 5; Curt. vi. 4, 10). A later story, that Bagoas was an Egyptian and killed Artaxerxes III. because he had killed the sacred Apis (Aelian, *Var. Hist.* vi. 8), is without historical value. Bagoas' house in Susa, with rich treasures, was presented by Alexander to Parmenio (Plut. *Alex.* 39); his gardens in Babylon, with the best species of palms, are mentioned by Theophrastus (*Hist. Plant.* ii. 6; Plin. *Nat. Hist.* xiii. 41). Another eunuch, Bagoas, was a favourite of Alexander the Great (Dicaearchus in Athen. xiii. 603b; Plut. *Al.* 67; Aelian, *Var. Hist.* 3.23; Curt. vi. 5, 23; x. 1, 25 ff.). (ED.M.)

BAG-PIPE (*Celt. piob-mala, ullan-piob, cuislean, cuislin; Fr. cornemuse, chalemie, musette, sordeline, chevrette, loure; Ger. Sackpfeife, Dudelsack; M. H. Ger. Suedgbalch¹; Ital. cornamusa, piva, zampogna, surdellina; Gr. ἄραυλος(?)*; Lat. *asculus(?)*, *tibia utricularis, utricularium*; med. Lat. *chorus*), a complex reed instrument of great antiquity. The bag-pipe forms the link between the syrinx (*q.v.*) and the primitive organ, by furnishing the principle of the reservoir for the wind-supply, combined with a simple method of regulating the sound-producing pressure by means of the arm of the performer. The bag-pipes consists of an air-tight leather bag having three to five apertures, each of which contains a fixed stock or short tube. The stocks act as sockets for the reception of the pipes, and as air-chambers for the accommodation and protection of the reeds. The pipes are of three kinds: (1) a simple valved insufflation tube or "blow-pipe," by means of which the performer fills the bag reservoir; (2) the "chaunter" (chanter) or the melody-pipe, having according to the variety of the bag-pipe a conical or a cylindrical bore, lateral holes, and in some cases keys and a bell; the "chaunter" is invariably made to speak by means of a double-reed; (3) the "drones," jointed pipes with cylindrical bore, generally terminating in a bell, but having no lateral holes and being capable, therefore, of producing but one fixed note.

The main characteristic of the bag-pipe is the drone ground bass which sounds without intermission. Each drone is fitted with a beating-reed resembling the primitive "squeaker" known to all country lads; it is prepared by making a cut partly across a piece of cane or reed, near the open end, and splitting back from this towards a joint or knot, thus raising a tongue or flap. The beating-reed is then fixed in a socket of the drone, which fits into the stock. The sound is produced by the stream of air forced from the bag into the drone-pipe by the pressure of the performer's arm, causing the tongue of reed to vibrate over the aperture, thus setting the whole column of air in vibration. The drone-pipe, like all cylindrical tubes with reed mouth-pieces, has the acoustic properties of the closed pipe and produces the note of a pipe twice its length. The drones are tuned by means of sliding-joints.

¹ See E. G. Graff, *Deutsche Interlinearenversionen der Psalmen* (from a 12th-cent. Windberg MS. at Munich), p. 384, Ps. lxxx. 2. "nemiet den Sulmen unde gebet den Suedgbalch."

The blow-pipe and the chanter occupy positions at opposite extremities of the bag, which rests under the arm of the performer while the drones point over his shoulder. These are the main features in the construction of the bag-pipe, whose numerous varieties fall into two classes according to the method of inflating the bag: (1) by means of the blow-pipe described above; (2) by means of a small bellows connected by a valved feed-pipe with the bag and worked by the other arm or elbow to which it is attached by a ribbon or strap.

Class I. comprises: (a) the Highland bag-pipe; (b) the old Irish bag-pipe; (c) the cornemuse; (d) the bignou or binou (Breton bag-pipe); (e) the Calabrian bag-pipe; (f) the ascaculus of the Greeks and Romans; (g) the tibia ulularis; (h) the chorus. To Class II. belong: (a) the musette; (b) the Northumbrian or border bag-pipe; (c) the Lowland bag-pipe; (d) the union pipes of Ireland; (e) the surdelina of Naples.

I. *The Highland Bag-pipe.*—The construction of the Highland pipes is practically that given above. The chanter consists of a conical wooden tube terminating in a bell and measuring from 14 to 16 in. including the reed. There are seven holes in front and one at the back for the thumb of the left hand, which fingers the upper holes while the right thumb merely supports the instrument. The holes are stopped by the under part of the joints of the fingers. There is in addition a double hole near the bell, which is never covered, and merely serves to regulate the pitch. As the double reed is not manipulated by the lips of the performer, only nine notes are obtained from the chanter, as shown:—



The notes do not form any known diatonic scale, for in addition to the C and F being too sharp, the diatones are not strictly in tune with each other. Donald MacDonald, in his treatise on the bag-pipe³ states that "the piper is to pay no attention to the flats and sharps marked on the clef, as they are not used in pipe music; yet the pipe imitates several different keys which are real, but ideal on the bag-pipe, as the music cannot be transposed for it into any other key than that in which it is first played or marked." Mr Glen, the great dealer in bag-pipes, gave it as his opinion "that if the chanter were to be made perfect in any one scale, it would not go well with the drones." Also, there would not be nearly so much music produced (if you take into consideration that it has only nine invariable notes) as at present it adapts itself to the keys of A maj., D maj., B min., G maj., E min. and A min. Of course we do not mean that it has all the intervals necessary to form scales in all those keys, but that we find it playing tunes that are in one or other of them."⁴ Mr Ellis considers that the natural scale of the chanter of the bag-pipe corresponds most nearly with the Arab scale of Zalzal, a celebrated luttist who died c. A. D. 800.

The three drones are usually tuned to A, the two smallest one octave below the A of the chanter, and the largest two octaves below. The three principal methods of tuning the drones are shown as follows:—

A. J. ELLIS. Chanter.	DAVID GLEN. ⁵ Chanter.	ANGUS MACKAY. ⁶ Chanter.

The excessive use of ornamental notes on the Highland bag-pipe has arisen from a technical peculiarity of the instrument, which makes a repetition of the same note difficult without the interpolation of what is known among pipers as "cuts" or "warblers," i.e. grace notes fingered with great rapidity (see below for an example). These warblers, which consist not only of single notes but of groups of

¹ These harmonics may be obtained by good performers by what is known as "pinching" or only partially covering the B and C holes and increasing the wind pressure.

² The notes marked with asterisks are approximately a quarter of a tone sharp.

³ Complete Tutor for attaining a thorough knowledge of the pipe music, prefixed to *A Collection of the Ancient Martial Music of Caledonia called Piobaireachd, as performed on the Great Highland Bag-pipe*, Edinburgh, c. 1805.

⁴ Paper on "The Musical Scales of Various Nations," by Alex. J. Ellis, F.R.S., *Jrnl. Soc. Arts*, 1885, vol. xxxiii, p. 499.

⁵ Tutor for the Highland Bag-pipe, by David Glen (Edinburgh, 1890).

⁶ Tutor for the Highland Bag-pipe, by Angus Mackay (Edinburgh, 1839).

from three to seven notes, not consecutive but in leaps, assist in relieving the constant discord with the drone bass. Skillful pipers have been known to introduce warblers of as many as eleven notes between two beats in a bar.

The use of musical notation for the Highland pipe tunes is a recent innovation; the pipers used verbal equivalents for the notes; for instance, the piobaireachd *Coghiegh nna Shie*, "War of peace," which opens as shown here, was taken down by Capt. Niel MacLeod



from the piper John M'Crummen of Skye as verbally taught to apprentices as follows:—

"Hodroho, hodroho, haninin, hiechin,
Hodroho, hodroho, hodroho, hiechin,
Hodroho, hodroho, haninin, hiechin," &c.

The conclusion of the tune is thus expressed:

"Hiundratateriri, hiendatateriri, hiundratata-
teriri, hiundratateriri."

Written down this seems a mere unintelligible jumble, but could we hear it, as sounded by the pipers, with due regard for the rhythmic value of notes, it would be a very different matter. Alexander Campbell⁷ relates that a melody had to be taken down or translated "from the syllabic jargon of illiterate pipers into musical characters, which, when correctly done, he found to his astonishment to coincide exactly with musical notation."

A Highland bag-pipe of the 15th century, dated MCCCXC., in the possession of Messrs J. & R. Glen of Edinburgh, was exhibited at the Royal Military Exhibition in London in 1890⁸ (see fig. 1 (4)). There were two drones, inserted in a single stock in the form of a wide-spread fork, and tuned to A in unison with the lowest note of the chanter, which had seven finger-holes in front and a thumb-hole at the back.

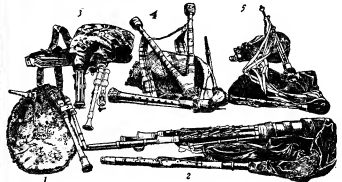

FIG. 1.—(1) Cornemuse. (2) Irish Bag-pipe. (3) Musette. (4) Highland bag-pipe, A. D. 1409. (5) Border bag-pipe.

(From Capt. C. R. Day's *Descriptive Catalogue of Musical Instruments exhibited at the Royal Military Exhibition*, by permission of Eyre & Spottiswoode.)

The old Irish Bag-pipe.—Very little is known about this instrument. It is mentioned in the ancient Brehon Laws, said to date from the 5th century (they are cited in compilations of the 10th century), in describing the order of precedence of the king's bodyguard and household in the *Crith Gabhlach*: "Poets, harpers, pipers, horn-blowers and jugglers have their place in the south-east part of the house."⁹ The word used for (bag-) pipers is *Cuisle-nigh*, a word associated with reed instruments (*cuisle-nigh* = reeds; O'Reilly's *Irish-English Dictionary*, Dublin, 1864). The old Irish bag-pipe, of which we possess an illustration dated 1581,¹⁰ had a long conical chanter with a bell and apparently seven holes in front and a thumb-hole behind; there were two drones of different lengths—one very long—both set in the same stock. It is exceedingly difficult to procure any accurate information concerning the development of the bag-pipe in Ireland until it assumed the present form, known as the union-pipes, which belong to Class II.

⁷ *A Collection of Ancient Piobaireachd or Highland Pipe Music* by Angus Mackay (Edinburgh, 1839), p. 128.

⁸ *A Collection of Piobaireachd or Pipe Tunes as verbally taught by the M'Crummen Pipers on the Isle of Skye to their apprentices*, as taken from John M'Crummen (or Crimmon) by Niel MacLeod of Gesto, Skye (Edinburgh, 1880).

⁹ *Albyn's Anthology*, vol. i, p. 90.

¹⁰ *Descriptive Catalogue of the Musical Instruments exhibited at the Royal Military Exhibition, London, 1890*, Eyre & Spottiswoode, 1891, pl. ix, A, and description, p. 57.

¹¹ *Ancient Laws of Ireland, Brehon Law Tracts*, published by the Commissioners for relieving the Ancient Laws and Institutions of Ireland (Dublin, 1879), vol. iv, pp. 338 and 339.

¹² John Derrick, *Image of Ireland and Discoverie of Woodkarne* (London, 1581), pl. ii.

The *cornemuse* and *chalemie* were the bag-pipes in use in France, Italy and the Netherlands before the advent of the *musette*, to which they bear the same relation as the old Irish bag-pipe does to the union-pipes, or the *cornemuse* or *piva* to the *sampogna* or *surdulina* in Italy. Two kinds of cornemuses were known in France during the 16th and 17th centuries, differing in one important structural detail, which affected the *timbre* of the instruments. Père Marin Mersenne¹ has given a detailed description of these varieties and of the *musette*, with very clear illustrations of the instruments and all their parts. The *cornemuse* or *chalemie* used by shepherds, and as a solo instrument (see fig. 1 (1)), was similar to the Highland bag-pipe; it consisted of a leather bag, inflated by means of

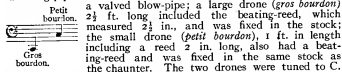

valved blow-pipe; a large drone (*gros bourdon*) $2\frac{1}{2}$ ft. long included the beating-reed, which measured $2\frac{1}{2}$ in., and was fixed in the stock; the small drone (*petit bourdon*), 1 ft. in length including a reed 2 in. long, also had a beating-reed and was fixed in the same stock as the chaunter. The two drones were tuned to C. The chaunter had a conical bore and a double reed like an oboe, but hidden within the stock; it could be taken out and played separately, when the compass given by the eight holes (seven in front and a thumb-hole) C to C' could be increased by a third to E, by overblowing the D and E an octave by pressure of the breath and lips on the reed, now taken directly into the mouth. The second kind of cornemuse was played only in concert with a family of instruments known as *Hautbois de Poitou*, a *hautbois* having the reed enclosed in an air-chamber, just as in the case with the reeds of the bag-pipe. This cornemuse had but one drone which could, like the others, be lengthened for tuning by drawing out the joint; the reed was not a beating-reed but a double reed like that of the chaunter; this constitutes the main difference between the two cornemuses. The chaunter had eight holes, the lowest of which was covered by a key enclosed in a perforated box.

The *Sackpfeife* or *Dudelsack* of Germany was an instrument of some importance made in no less than five sizes, all described and illustrated by Michael Praetorius.² They consist of the *Grosser Bock* or double-bass bag-pipe, a formidable-looking instrument with a single cylindrical drone of a great length, terminating, as did the chaunter also, in a curved ram's horn (to which the name was due). The chaunter had seven finger-holes and a vent-hole in front, and a thumb-hole at the back. The drone was tuned to G, an octave below the chaunter.

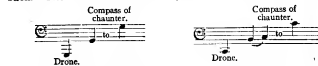

Sackpfeife or Dudelsack. The *Bock*, of similar construction, was pitched a fourth higher in C. The *Schäferpfeife* had two drones in B \flat and F. Praetorius explains that the upper notes of the chaunter of this sackpfeife had a faulty intonation which could not be corrected owing to the absence of the thumb-hole, usual in all other varieties of the instrument.

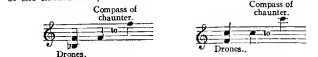

Schäferpfeife. The *Hümmelchen* had two drones tuned to F and C. The *Dudey* or treble sackpfeife was the smallest of the family, and had three drones tuned to Eb, B \flat and Eb, and a chaunter with a compass ranging from F to C or C or D.

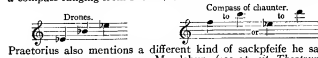

Praetorius also mentions a different kind of sackpfeife he saw in Magdeburg (see *op. cit.* *Theatrum*, pl. v., No. 4), which was somewhat larger than the *schäferpfeife* and pitched a third lower. There were two chaunters mounted in one stock, each having three holes in front and one for the thumb at the back. The right-hand chaunter sounded the five notes D, E, F, G, A, and the left-hand chaunter, G, A, B, C, D. The performer was thus able to play simple two-part melodies on the Magdeburg bag-pipe. Praetorius mentions in addition the French bag-pipe (*musette*), similar in pitch to the *hümmelchen*, but inflated by means of the bellows.

¹ *L'Harmonie universelle*, vol. ii. bk. v. pp. 282-287 and 305 (Paris, 1636-1637).

² *Synagoga Musicum*, part ii. *De Organographia* (Wolfenbüttel, 1618); republished in Band xii. of the *Publication der Gesellschaft für Musikforschung* (Berlin, 1884), chap. xix. and pl. v., xi., xiii.

The *Calabrian bag-pipe* has a bag of goatskin with the hair left on, and is inflated by means of a blow-pipe. There are two drones and two chaunters, all fixed in one stock. Each chaunter has three or four finger-holes and the right-hand pipe has the fourth covered by a key enclosed in a perforated box; both drones and chaunter have double reeds.

The ancient Greek bag-pipe (see ASKAULES), and the Roman *tibia ulularis*, belonged to this class of instrument, inflated by the mouth, but it is not certain that they had drones (see below, *History*).

The second class of instruments, inflated by means of a small bellows worked by the arm, has as prototype the *musette* (see fig. 1 (3)), which is said to have been evolved during the 15th century³ from the end of the 15th century there were always *musette* players⁴ at the French court, and we find the instrument fully developed at the beginning of the 17th century when Mersenne⁵ gives a full description of all its parts. The chief characteristic of the *musette* was a certain rustic Watteau-like grace. The face of the performer was no longer distorted by inflating the bag; for the long cumbersome drones was substituted a short barrel drone, containing the necessary lengths of tubing for four or five drones, reduced to the smallest and most compact form. The bores were pierced longitudinally through the thickness of the wood in parallel channels, communicating with each other in twos or threes and providing the requisite length for each drone. The reeds were double "hautbois" reeds all set in a wooden stock or box within the bag; by means of regulators or slides, called *layettes*, moving up and down in longitudinal grooves round the circumference of the barrel, the length of the drone pipes could be so regulated that a simple harmonic bass, consisting mainly of the common chord, could be obtained. The chaunter of narrow cylindrical bore, was also furnished with a double reed and had eleven holes, four of which had keys, giving a compass of twelve notes from F to C. This number of holes was not invariable. After Mersenne's time, Jean Hotterterre (d. 1678), a court musician, belonging to the band known as the *Musique de la Grande Écurie*,⁶ in which he played the *dessus de hautbois*, introduced certain improvements in the drones of the *musette*.⁷ His son Martin Hotterterre (d. 1712) added a second chaunter to the *musette*, shorter than the first, to which it was attached instead of being inserted into the stock. The Hotterterre chaunter, known as the *petit chalumeau*, had six keys, whereas the *grand chalumeau* had seven, besides eight finger-holes and a vent-hole in the bell. All these keys were actuated by the little finger of the left hand and the thumb of the right hand, which were not added to stop holes on the large chaunter. The *grand* and *petit chalumeaux* are figured in detail with keys and holes in a rare and anonymous work by Borjon (or Bourgeon), who gives much interesting information concerning one of the most popular instruments of his day. The bellows, he states, borrowed from the organ, were added to the *musette* about forty or fifty years before he wrote his treatise. The compass of the improved *musette* of Hotterterre was as shown:—

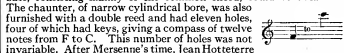

the eight holes of the grand chalumeau.

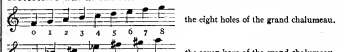

the seven keys of the grand chalumeau.

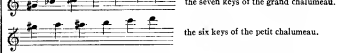

the six keys of the petit chalumeau.

The four or five drones were usually tuned thus:

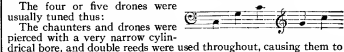

The chaunters and drones were pierced with a very narrow cylindrical bore, and double reeds were used throughout, causing them to speak as closed pipes, which accounts for the deep pitch of these relatively short pipes (see AULOS). Martin Hotterterre was hardly the first to introduce the second chaunter for the bag-pipe, since

³ See E. Thoinan, *Les Hotterterre et les Chédévile, célèbres facteurs de flûtes, hautbois, bassons et musettes* (Paris, 1894), p. 23. It is probable, however, that M. Thoinan, who makes this statement, has not considered the possibility of the word *musette* applying in this case to the small rustic hautbois or *dessus de bombarde*, also written *muse*, *musel*, *muselle*, which occurs in many ballads of the 13th, 14th and 15th centuries. See Fr. Godéroy, *Dictionnaire de l'ancienne langue française du IX^e au XV^e siècle* (Paris, 1888).

⁴ *Musettes de Poitou*; probably the cornemuses used in concert with the Hautbois de Poitou.

⁵ *Op. cit.* vol. ii. bk. v. pp. 287-292.

⁶ See Ernest Thoinan, *op. cit.* pp. 15 et seq. (cf. Jules Ecorcheville, "Quelques documents sur la musique de la Grande Écurie du Roi" in *Intern. Mus. Ges.*, Sammelband ii. 4, p. 625 and table 2, "Grands Hautbois").

⁷ *Méthode pour la musette, &c.*, by Hotterterre le Romain (Paris, 1737), 4to, chap. xvi.

⁸ *Méthode pour la musette avec une nouvelle méthode, &c.* (Lyon, 1672), pp. 25-27 and plate. A copy of this work is in the British Museum.

Praetorius in 1618 figures and describes the Magdeburg *sackpfeife* with two chaunters, but without keys and with a conical bore.

The *surdeline* or *sampogna* is described and illustrated by Mersenne¹ as the *musette de Naples*; its construction was very complicated. Mersenne states that the instrument was invented by Jean Baptiste Riva (who was living in Paris in 1620), Dom Julio and Vincenze; but Mersenne seems to have made alterations himself in the original instrument, which are not very clearly explained. There were two chaunters with narrow cylindrical bore and having both finger-holes and keys; and two drones each having ten keys. The four pipes were fixed in the same stock, and double reeds were used throughout; the bag was inflated by means of bellows. Passenti of Venice published a collection of melodies for the *sampogna* in 1628, under the title of *Canora Sampogna*.

The modern Lowland *bag-pipe* differs from the Highland *bag-pipe* mainly in that it is blown by bellows instead of by the mouth.

The Northumbrian or Border *bag-pipe*, also blown by means of bellows, is chiefly distinguished by having a chaunter stopped at the lower end so that when all the holes are closed, the pipe is silent. There are seven finger-holes, one for the thumb, and a varying number of keys. The four drones are fixed in one stock and are tuned by means of stoppers, so that, as in the *musette*, any one of them may be silenced. A fine Northumbrian *bag-pipe*² from the collection of the Rev. F. W. Galpin is illustrated (fig. 1. (5)).

The union pipes of the 18th century, or modern Irish *bag-pipe*, blown by bellows (see fig. 1. (2)), had one chaunter with seven finger-holes, one thumb-hole and eight keys, which together gave the chromatic scale in two octaves. The drones were tuned to A in different octaves, and three regulators or drones with keys, played by the elbow, produced a kind of harmony; the regulators correspond to the sliders on the drone-barrel of the *musette*.

History of the Bag-pipe.—There is reason to believe that the origin of the bag-pipe must be sought in remote antiquity. No instrument in any degree similar to it is represented on any of the monuments of Egypt or Assyria known at the present day; we are, nevertheless, able to trace it in ancient Persia and by inference in Egypt, in Chaldea and in ancient Greece. The most characteristic feature of the bag-pipe is not the obvious bag or air-reservoir from which the instrument derives its name in most languages, but the fixed harmony of the buzzing drones. The principle of the drone, *i.e.* the beating-reed sunk some three inches down the pipe, was known to the ancient Egyptians. In a pipe discovered in a mummy-case and now in the museum at Turin, was found a straw beating-reed in position. The argiloid (*q.v.*), a modern Egyptian instrument, possesses the characteristic feature of drone and chaunter without the bag. The same instrument occurs once in the hieroglyphs, being sounded *as-it*, and once on a mural painting preserved in the Musée Guimet and reproduced by Victor Loret.³ During Jacques de Morgan's excavations in Persia some terra-cotta figures of musicians, dating from the 8th century B.C., were discovered in a *tell* (mound) at Susa,⁴ two of which appear to be playing bag-pipes; the chaunter, curved in the shape of a hook from the stock, is clearly visible, the bag under the arm is indicated, and the lips are pursed as if in the act of blowing, but the insufflation tube is absent; a round hole in one of the figures suggests its presence formerly.

Among the names of musical instruments in Daniel iii. 5 and 15, the sixth, generally but wrongly rendered "dulcimer," is thought by many scholars to signify a kind of bag-pipe (see commentaries on *Daniel* and the theological encyc.). This belief is based on the supposition that the Aramaic *sumpōnyā* is a loan-word from the Greek, being a mispronunciation of *συνφωνία*. The argument is, however, exceedingly weak. In the first place, the date of the book of Daniel is matter of controversy, hingeing partly on precisely such questions as the true significance and derivation of *sumpōnyā*. Second, it is possible that the word *sumpōnyā* is a late interpolation. Third, its exact form is uncertain; in verse 10, *sipōnyā* is used of the same instrument, suggesting a derivation from the Gr. *σίφων* (tube or pipe). Fourth, even if *συνφωνία* is the source of the word, there is very little evidence that it was used for any particular

instrument. The original natural sense of *συνφωνία* is "concord of sound," "a concordant interval," and the evidence of its use for a particular instrument is of the 2nd century B.C., and, even so, very slight. Only one passage (Polyb. xxvi. 10. 5) really bears on the question, and there the translation of the word depends on a context the reading of which is uncertain (see *ΣΥΜΦΩΝΙΑ*). It is, however, curious that the bag-pipe was known in Italy and Spain during the middle ages, the two countries through which Eastern culture was introduced into Europe, by the name of *sampogna* or *sampogna*, which strongly recall the Chaldaean *sumpōnyā*; and further that in the same countries the word *sinfonia* should be co-existent with *sampogna* and have the original meaning attached to the classical *συνφωνία*, "a concord of sound." A single passage only in Dion Chrysostom (see *ASKAULES*) is enough to prove that the instrument was known in Greece in A.D. 100.⁵ The Greeks had undoubtedly received some kind of bag-pipe from Egypt (in the form of the *as-it*), or from Chaldea, but it remained a rustic instrument used only by shepherds and peasants. This conclusion is supported by allusions in Aristophanes and in Plato's *Crito*, which undoubtedly refer to the drone: "This, dear Crito, is the voice which I seem to hear murmuring in my ears like the sound of the flute (*aulos*) in the ears of the mystic; that voice, I say, is humming in my ears."⁶ Aristophanes, in his play *The Acharnians*, indulges in a flight of satire at the expense of the musical Boeotians, by making a band of Theban pipers play a Boeotian merchant and his slave into town. The musicians are dubbed "bumblebee pipers" (*βομβυβαῖλος*, l. 866) by the exasperated inhabitants. The verb used here for "blowing" is *φώνω*, the very word applied to blowing or inflating the bellows (*φώνω*), and not the usual verb *αὐλάω*, to play the *aulos*. L. 1242 and 1245, mentioned by Aristophanes in *Lysistrata* (ll. 1242 and 1245), which was probably a kind of bag-pipe, is also derived from *φώνω*, *i.e.* *physallis*, the "concrete," and *physalteria*,⁷ the "collective" form of the instrument. We leave the realm of inference for that of certainty when we reach the reign of Nero, who had a passion for the *Hydraulus* (see *ORGAN: History*) and the *tibia utricularis*.⁸

That the bag-pipe was introduced by the Romans into the British Isles is a conclusion supported by the discovery in the foundations of the praetorian camp at Richborough of a small bronze figure of a Roman soldier playing the *tibia utricularis*. The Rev. Stephen Weston, who made a communication on the subject to *Archaeologia*,⁹ points out further the interesting fact in connexion with the instrument, that the Romans had instituted colleges for training pipers on the bag-pipe, a practice followed in the Highlands in the 18th century and notably in Skye. Gruterus¹⁰ mentions among the fraternities a *Corpus et Collegium Utriculariorum*, and Spon¹¹ also quotes the *Collegio Utricularum*. The bag-pipe in question appears to have two drones in front pointing towards the right shoulder, and although no chaunter is shown in the design, both hands are held in correct positions over the spot where it ought to be; it may have been broken off. The bronze figure has been reproduced from drawings by Edward King in three positions.¹² The statement made by several writers on music that a bag-pipe is represented on a cornucopia of Nero is erroneous, as a verification of certain references will show.¹³ The error is due in the first place to

¹ Dion Chrysostom, ed. Adolphus Emperius (Brunswick, 1834), p. 728 or lxxi. (R) 381. See Pauly-Wissowa, *Realencyclopädie*, s.v. "Askaules."

² S. B. Jowett's Eng. translation (Oxford, 1892).

³ A suggestion the writer owes to Mr G. Barwick of the British Museum.

⁴ See "Researches into the Origin of the Organs of the Ancients," by Kathleen Schlesinger, *Sammelband ii. Intern. Musik. Ges.* vol. ii, 1901, pp. 188-202.

⁵ Suetonius, *Nero*, 54 (S. Clarke's translation and text).

⁶ *Archaeologia*, vol. xvii, pp. 176-179 (London, 1814).

⁷ *Inscriptiones antiquae Iolius orbis romani* (Heidelberg, 1602-1603).

⁸ *Miscell. erudit. antiquitatis*.

⁹ *Munimenta antiqua*, vol. ii. (London, 1799), p. 22, pl. xx. fig. 3.

¹⁰ See Montfaucon, *Suppl. de l'antiqu. expliquée*, vol. iii. pl. lxxiii., Nos. 1 and 2, and explanation p. 189; Francesco Bianchini, *ed.*

¹ *Op. cit.* bk. v. p. 293.

² Illustrated and described by Capt. C. R. Day, *Descriptive Catalogue*, pl. ix. fig. C. p. 62.

³ *L'Égypte au temps des Pharaons—la vie, la science et l'art; avec Photographies*, &c. (Paris, 1899) 12mo, p. 139.

⁴ See *Délégation en Perse*, by J. de Morgan (Paris, 1900), vol. i. pl. viii., Nos. 10 and 14.

Montfaucon, who misunderstood the explanation of Bianchini's drawing which he reproduced. The contorniate referred to is one containing the hydraulic organ, and the legend *Laurentinus Aug.*, but no bag-pipe. Bianchini gives a drawing of a bag-pipe with two long drones, which, he says, was copied from a marble relief over the gateway of the palace of the prince of Santa Croce in Rome, near the church of San Carlo ad Catinarios. If the drawing be accurate and the sculpture of classical Roman period, it would corroborate the details of the instrument held by the little bronze figure of the Roman soldier.

From England the bag-pipe spread to Caledonia and Ireland, where it took root, identifying itself with the life of the people, as a military instrument held in great esteem by the Celtic races. The bag-pipe was used at weddings and funerals, and at all festivals; to lighten labour, during the 18th century, as for instance in Skye, in 1786, when the inhabitants were engaged in roadmaking, and each party of labourers had its bag-piper. It was used in old mysteries at Coventry in 1534. Readers who wish to follow closely the history of the bag-pipe in the British Isles should consult Sir John Graham Dalryell's *Musical Memoirs of Scotland* (London, 1849, with illustrative plates).

On the downfall of the Roman empire, the bag-pipe, sharing the fate of other instruments, probably lingered for a time



FIG. 2.—Ancient Persian bag-pipe.

(From Sir Robert Porter's *Traité de Géographie, Poésie, &c.*, vol. ii. p. 177, pl. lxxv.)

during the fourteen centuries which elapsed between the moulding of the figurine found in the *tell* at Susa, mentioned above, and the carving in the rock at Takht-i-Bostan, the instrument had survived. The reign of Chosroes was noted for its high standard of musical culture. The fault probably lies with the draughtsman, who drew the sculptures on the arch for the book. Nothing more is heard henceforth of the tibia utricularis. If the drawings of the early medieval bag-pipes, which are by no means rare in MSS. and monuments of the 9th to the 13th century, are to be trusted, it seems hard to understand the *raison d'être* of the instrument shorn of its drones, to see how it justified its existence except as an ill-understood reminiscence. What could be the object of laboriously inflating a bag for the purpose of making a single chaunter speak, which could be done so much more satisfactorily by taking the reed itself into the mouth, as was the practice of the Greeks and Romans? There is a fine psalter in the library of University Court, Glasgow,¹ belonging to the Hunterian collection, in which King David is represented, as usual in the 12th century, playing or rather tuning a harp, surrounded by musicians playing bells, rebec, guitar fiddle (in 'cello position), quadruple pipes or ganistrum, and a bag-pipe with long chaunter having a well-defined stock. The insufflation tube appears to be seen left out, and there are no drones to be seen.

There are interesting specimens of bag-pipes in Spanish illuminated MSS. such as the magnificent volume of the *Cantigas de Santa Maria*, in the Escorial, compiled for King Alphonso the Wise (13th century). There are fifty-one separate figures of instrumentalists forming a kind of introduction to the canticles, and among the instruments are three bag-pipes, one of which is a remarkable instrument having no less than four long drones and two chaunters which by an error of the draughtsman are represented *generibus mss. veterum*, Romae, 1742, pl. ii., Nos. 12 and 13, and p. 11; Suetonius, *Vitas Neronatis*, ed. Charles Patin, cap. 41, p. 304, where the contorniate in question, whose musical instrument differs essentially from Bianchini's and Montfaucon's, is figured.

¹ See Catalogue of the Exhibition of Illuminated MSS. at the Burlington Fine Arts Club, 1908, No. 31.

ented as being blown from the piper's mouth. The fifty-two musicians have been reproduced in black and white by Juan F. Riaño² and also by Don F. Aznar.³ Another fine Spanish MS. in the British Museum, Add. MS. 18,851, of the end of the 15th century, illustrated by Flemish artists for presentation to Queen Isabella, displays a profusion of musical instruments in innumerable concert scenes; there are bag-pipes on f. 13,412^b and 419; one of these has two drones, one conical, the other cylindrical, bound together, and a curved chaunter.

The most trustworthy evidence we have of the medieval bag-pipe is the fine Highland bag-pipe dated 1400, and belonging to Messrs J. & R. Glen, described above. Edward Buhle⁴ points out that from the 13th century the bag-pipe became a court instrument played by minnesingers and troubadours, as seen in literature and in the MSS. and monuments. It was about 1250 that the human or animals' heads were used as stocks and as bells for the chaunters. The opinion advanced that the bellows were first added to the bag-pipe in Ireland seems untenable and is quite unsupported by facts; the bellows were in all probability added to the union-pipes in imitation of the musette. In the *Image of Ireland and Discoverie of Woodkarne*, by John Derrick, 1581, the Irish insurgents are portrayed in pictures full of life and character, as led to rebellion and pillage by a piper armed with a bag-pipe, similar to the Highland bag-pipe. The cradle of the musette is inconceivable anywhere but in France, among the courtiers and elegant world, turning from the pomps and luxuries of court life to an artificial admiration and cult of Nature, idealized to harmonize with silks and satins. The cornemuse of shepherds and rustic swains became the fashionable instrument, but as inflating the bag by the breath distorted the performer's face, the bellows were substituted, and the whole instrument was refined in appearance and tone-quality to fit for its more exalted position. The Hotteterre family and that of Chédeville were past masters of the art of making the musette and of playing upon it; they counted among their pupils the highest and noblest in the land. The cult of the musette continued throughout the 17th and 18th centuries until the 'seventies, when its popularity was on the wane and musettes figured largely in sales.⁵ Lully introduced the musette into his operas, and in 1758 the list of instruments forming the orchestra at the Opéra includes one musette.⁶

Illustrations of bag-pipes are found in the miniatures of the following MSS. in the British Museum.—2 B. VII. i. 192 and 197; Add. MS. 34,294 (the *Sforza Book*), f. 62, vol. i.; Burney, 275, f. 715; Add. MS. 17,280, f. 238^b; Add. MS. 24,686 (*Tennyssor Psalter*), f. 17^a; Add. MS. 17,280, f. 82^a; Add. MS. 24,681, f. 44; Add. MS. 32,454; Add. MS. 11,867, f. 38; &c. &c. (K. S.)

BAGRATION, PETER, PRINCE (1765-1812), Russian general descended from the noble Georgian family of the **Bagratides**, was born in 1765. He entered the Russian army in 1782, and served for some years in the Caucasus. He was engaged in the siege of Ochakov (1788), and in the Polish campaign of 1794, being present at the taking of Praga and Warsaw. His merits were recognized by Suvarov, whom he accompanied in the Italian and Swiss campaign of 1799, winning particular distinction by the capture of the town of Brescia. In the wars of 1803 his achievements were even more brilliant. With a small rearguard he successfully resisted the repeated attacks of forces five times his own numbers (Hollabrunn), and though half his men fell, the retreat of the main army under Kutusov was thereby secured. At Austerlitz he was engaged against the left wing of the French army, under Murat and Lannes, and at Eylau, Heilsberg and Friedland he fought with the most resolute and stubborn courage. In 1808 by a daring march across the frozen Gulf of Finland he captured the Åland Islands, and in 1809 he commanded against the Turks at the battles of Rassowa and Tataritza. In 1812 he

² *Notes of Early Spanish Music* (London, 1887), pp. 120 and 121.

³ *Idem*, *Instrumentos Españoles* (Madrid, 1880).

⁴ *Die musikalischen Instrumente in den Miniaturen des frühen Mittelalters*, p. 50 (Leipzig, 1903).

⁵ An interesting pamphlet by Eugène de Bricqueville, *Les Musettes* (Paris, 1894), p. 36, with illustrations.

⁶ See Antoine Vidal, *Les Instruments à archet* (Paris, 1871), vol. i. p. 81, note 1.

commanded the 2nd army of the West, and though defeated at Mogilev (23rd July), rejoined the main army under Barclay, and led the left wing at Borodino (7th Sept.), where he received a mortal wound. A monument was erected in his honour by the tsar Nicholas I. on the battlefield of Borodino.

BAGSHOT BEDS, in geology, a series of sands and clays of shallow-water origin, some being fresh-water, some marine. They belong to the upper Eocene formation of the London and Hampshire basins (England), and derive their name from Bagshot Heath in Surrey; but they are also well developed in Hampshire and the Isle of Wight. The following divisions are generally accepted:—

Upper Bagshot Beds	Barton sand, and Barton clay.
Middle " "	Bracklesham beds.
Lower " "	Bournemouth beds, Alum Bay beds, and Bovey Tracey beds (?).

The lower division consists of pale-yellow, current-bedded sand and loam, with layers of pipeclay and occasional beds of flint pebbles. In the London basin, wherever the junction of the Bagshot beds with the London clay is exposed, it is clear that no sharp line can be drawn between these formations. The Lower Bagshot beds may be observed at Brentwood, Billericay and Highbeech in Essex; outliers, capping hills of London clay, occur at Hempstead, Highgate and Harrow. In Surrey considerable tracts of London clay are covered by heath-bearing Lower Bagshot beds, as at Weybridge, Aldershot, Woking, &c. The "Ramsdell clay," N.W. of Basingstoke, belongs to this formation. In the Isle of Wight the lower division is well exposed at Alum Bay (660 ft.) and White Cliff Bay (140 ft.); here it consists of unfossiliferous sands (white, yellow, brown, crimson and every intermediate shade), and clays with layers of lignite and ferruginous sandstone. Similar beds are visible at Bournemouth, and in the neighbourhood of Poole, Wareham, Corfe and Studland.

The leaf-bearing clays of Alum Bay and Bournemouth are well known, and have yielded a large and interesting series of plant remains, including *Eucalyptus*, *Caesalpinia*, *Populus*, *Platanus*, *Sequoia*, *Aralia*, *Polypodium*, *Osmunda*, *Nipadietes* and many others. The sands and clays of Bovey Tracey (see BOVEY BEDS) are probably of the same age. The clays of this formation are of great value for pottery manufacture; they are extensively mined in the vicinity of Wareham and Corfe, whence they are shipped from Poole and are consequently known as "Poole clays"; similarly, "Teignmouth clay" is obtained from the Bovey beds. Alum was formerly obtained from the clays of Alum Bay; and the lignites have been used as fuel near Corfe and at Bovey.

The Bracklesham beds (*q.v.*) are sometimes classed with the overlying Barton clay as Middle Bagshot. In the London basin the Barton beds are unknown. In Surrey and Berkshire the Bracklesham beds are from 20 to 50 ft. thick; in Alum Bay they are 100 ft., with beds of lignite in the lower portion; and about here they are sharply marked off from the Barton clay by a bed of conglomerate formed of flint pebbles. The Upper Bagshot beds, Barton sand and Barton clay, are from 140 to 200 ft. thick in the Isle of Wight.

The Agglestone (or Haggerstone) rock and Puckstone rock, near Studland in Dorsetshire, are formed of large indurated masses of the Lower Bagshot beds that have resisted the weather; Creechbarrow near Corfe is another striking feature due to the same beds. Many of the sarsen stones or greywethers of S.E. England have been derived from Bagshot strata.

See *Memoirs of the Geological Survey* (England):—"Geology of the Isle of Wight," new edition (1889); "The Geology of London and Part of the Thames Valley," vol. i. (1889); and "The Geology of the Country around Bournemouth" (1898).

BAHADUR KHEL, an Indian salt-mine in the Kohat district of the North-West Frontier Province, in the range of hills south of the village of Bahadur Khel between Kohat and Bannu. For a space of 4 m. in length by a quarter of a mile in breadth there exists an exposed mass of rock-salt with several large hillocks of salt on either side. The quarries extend over an area 1 m. long by half a mile broad, and the salt is hewn out in large blocks with picks and wedges. The Indian government

formerly maintained a large preventive establishment for the preservation of the revenue, but it was withdrawn in 1898. Consumption of Kohat salt is restricted, on account of its paying less duty, to the tracts lying to the north of the Indus and to the frontier tribes. In 1903 the rate was fixed at R.1½ per maund, against R.2 for the rest of India. The mines are under the control of the Northern India Salt Department.

BAHADUR SHAH I., a Mogul emperor of Hindustan, A.D. 1707-1712, the son and successor of Aurangzeb. At the time of the latter's death his eldest surviving son, Prince Muazim, was governor of Kabul, and in his absence the next brother, Azam Shah, assumed the functions of royalty. Muazim came down from Kabul, and with characteristic magnanimity offered to share the empire with his brother. Azam would not accept the proposal and was defeated and slain on the plains of Agra. Muazim then ascended the throne under the title of Bahadur Shah. He was a man of 64 and died five years later. During his lifetime the empire was already falling to pieces before the inroads of the Sikhs and Maharrattas, and through internal dissensions.

BAHADUR SHAH II., the last of the Mogul emperors of Hindustan, 1837-1857. He was a titular emperor only, since from the time of the defeat of Shah Alam at Buxar in 1764 all real power had resided with the East India Company; but all proclamations were still worded under "The King's Realm and the Company's rule." His sole importance is due to the use made of his name during the Mutiny of 1857. Always feeble in character, he was at that time old, and, from the first, was wholly at the mercy of the mutinous soldiery in Delhi, who were controlled by a council called the Barah Topi, or Twelve Heads. His papers, seized after the fall of Delhi, are full of senile complaint of the disrespect and discourtesy which he suffered from them. At the time of the assault he fled to the Tomb of Humayun, 6 m. from Delhi, where he was captured by Major Hodson. In January 1858 he was brought to trial for rebellion and for complicity in the murder of Europeans. The trial lasted more than two months. The substance of the king's defence was that he had been a mere instrument in the hands of the mutineers. On the 29th of March he was found guilty and sentenced to imprisonment for life. He was transported to Rangoon, and died there on the 7th of November 1862.

BAHAMAS (*Lucayos*), an archipelago of the British West Indies. It is estimated to consist of 29 islands, 661 cays and 2387 rocks, and extends along a line from Florida on the north-west to Haiti on the south-east, between Cuba and the open Atlantic, over a distance of about 630 m., from 80° 50' to 72° 50' W., and 22° 25' to 26° 40' N. The total land area is estimated at 5450 sq. m., of which the main islands occupy 4224 sq. m., and the population was 43,521 in 1881 and 53,735 in 1901. Some 12,000 of these are whites, the remainder coloured. The main islands and groups, beginning from the north-west, are as follows: Little and Great Abaco, with Great Bahama to the west; Eleuthera (a name probably corrupted: from the Spanish *Isle de Tierra*), Cat, Watling, or Guanahani, and Rum Cay on the outer line towards the open ocean, with New Providence, the Exuma chain and Long Island forming an inner line to the west, and still farther west Andros (named, from Sir Edmund Andros, governor of Massachusetts, &c.), at the close of the 17th century; often spoken of as one island, but actually divided into several by narrow straits; and finally the Crooked Islands, Mayaguana and Inagua. The Turks and Caicos islands continue the outer line, and belong geographically to the archipelago, but not politically. The surrounding seas are shallow for the most part, but there are three well-defined channels—the Florida or New Bahama channel, between the north-western islands and Florida, followed by the Gulf Stream, the Providence channels (north-east and north-west) from which a depression known as the Tongue of Ocean extends southward along the east side of Andros, and the Old Bahama channel, between the archipelago and Cuba. The Andros islands have a length of 95 m. and an area of 1600 sq. m.; Great Abaco is 70 m. long and its area is 680 sq. m.; Great Inagua is 34 m. long with an area of 530 sq. m.,

and Grand Bahama 66 m., with an area of 430 sq. m. But the most important island, as containing the capital, Nassau, is New Providence, which is only 10½ m. in length, with an area of 85 sq. m. This island supported a population in 1901 of 12,534. In point of population the next most important islands Eleuthera (8733), followed by the Andros Islands (5347) and Cat Island (4658). The Abaco and Exuma groups and Long Island each support populations exceeding 3000, and there are smaller populations on Grand Bahama, the Crooked Islands, Inagua, Mayaguana, Watling, Rum Cay and the Biminis, though these last, which are two very small north-western islands, are relatively densely populated with 545 persons.

Physical Geography.—The islands are of coral formation and low-lying. The rock on the surface is as hard as flint, but underneath it gradually softens and furnishes an admirable stone for building which can be sawn into blocks of any size, hardening on exposure to the atmosphere. The highest hill in the whole range of the islands (in Cat Island) is only 400 ft. high. It is a remarkable fact that, except in the island of Andros, no streams of running water are to be found in the whole group. The inhabitants derive their water supply from wells. As a result of the porosity of the rock, many of the wells feel the influence of the sea and exhibit an ebb and flow. There is an extensive swampy lagoon in Eleuthera, the water of which is fresh or nearly so; and brackish lagoons also occur, as in Watling Island. An artificial lake in New Providence, constructed for the use of the turtle-catchers, is noted as exhibiting an extraordinary degree of phosphorescence. A remarkable natural phenomenon is that of the so-called "banana holes," which frequently occur in the limestone. Their formation has been attributed to the effect of rotting vegetation on the rock, but without certainty. These holes are of various depths up to about 40 ft., and of curiously regular form. The Mermaid's Pool in New Providence, which is deeper still, is partly filled with water.

Geology.—The Bahamas consist almost entirely of aeolian deposits (cf. BERMUDAS) and coral reefs. The aeolian deposits, which form the greater part of the islands, frequently rise in rounded hills and ridges to a height of 100 or 200 ft., and in Cat Island nearly 400 ft. They vary in texture from a fine-grained compact oolite to a coarse-grained rock composed of angular or rounded fragments, and they commonly exhibit strongly marked false bedding. The material is largely calcareous, and has probably been derived from the disintegration of the reefs, and from the shells of animals living in the shallows. When freshly exposed the rock is soft, but by the action of rain and sea it becomes covered with a hard crust. The surface is often remarkably honeycombed, and the rock weathers into pinnacles, pillars and arches of extraordinary shapes. On the island of Andros there is an extremely fine white marl almost resembling a chalky ooze. The coral reefs are of especial interest from their bearing on the general question of the formation of coral reefs.

Nassau.—The scenery of the islands is picturesque, gaining beauty from the fine colouring of the sea and the rich vegetation. Nassau is a winter health-resort for many visitors from the United States and Canada. The town lies on a safe harbour on the north shore of New Providence, sheltered by the small Hog Island. There is a depth of 14 ft. at low-water spring-tide on the bar. The town extends along the shore, and up a slightly elevated ridge behind it. It contains the principal public buildings, and some interesting old forts, dating from the middle and close of the 18th century, though the subterranean works below Fort Charlotte are attributed to an earlier period. From the same century dates the octagonal building which, formerly a gaol, now contains a good public library. The sea-bathing is excellent. The months of February and March are the principal season for visitors. There is direct connexion with New York by steamers, which make the journey in about four days; and there is also connexion with Miami in Florida.

Climate, Flora, Fauna.—The climate of the Bahamas adds to their attractions. The mean temperature of the hottest months (June to September) is 88° F., and that of the coldest (January to March) 66°. In a series of observations of winds about one

half have been found to indicate a direction from north-east or east. Hurricanes occur from July to October, and May to October are reckoned as the rainy months. The rainfall recorded in 1901 at Nassau amounted to 63.32 in. Where a mantle of soil covers the rock it is generally thin but very fertile. A well-defined area in New Providence is known as the "pine barrens," from the tree which principally grows in this rocky soil. Elsewhere three types of soil are distinguished—a black soil, of decayed vegetable matter, where the land is under forest, a reddish clay, and a white soil occurring along the shores. Andros Island and the Abaco Islands may be specially noted for their profusion of large timber, including mahogany, mastic, lignum vitae, iron and bullet woods, and many others. Unfortunately the want both of labour and of roads renders it impossible to turn much of this valuable timber to useful account, although attempts have been made to work it in Abaco. The fruits and spices of the Bahamas are very numerous, the fruit qualling any in the world. The produce of the islands includes tamarinds, olives, oranges, lemons, limes, citrons, pomgranates, pine-apples, figs, sapsodillas, bananas, sour-sops, melons, yams, potatoes, gourds, cucumbers, pepper, cassava, prickly pears, sugar-cane, ginger, coffee, indigo, Guinea corn and peas. Tobacco and cascarilla bark also flourish; and cotton is indigenous and was woven into cloth by the aborigines. But although oranges, pine-apples and some other fruits form important articles of commerce, it is only rarely that systematic and thorough methods of cultivation are prosecuted. Cotton has been found to suffer much from insect pests. Sisal is grown in increasing quantity. The Bahamas are far poorer in their fauna than in their flora. It is said that the aborigines had a breed of dogs which did not bark, and a small coney is also mentioned. The guana also is indigenous to the islands. Oxen, sheep, horses and other live-stock introduced from Europe thrive well, but little attention is paid to stock-rearing. There are many varieties of birds to be found in the woods of the Bahamas; they include flamingoes and the beautiful humming-bird, as well as wild geese, ducks, pigeons, hawks, green parrots and doves. The waters of the Bahamas swarm with fish; the turtle procured here is particularly fine, and the sponge fishery is of importance. In some islands there are rich salt ponds, but their working has decreased. The portion of Nassau harbour known as the Sea Gardens exhibits an extraordinarily beautiful development of marine organisms.

Government, Trade, &c.—The colony of the Bahamas is under a British governor, who is assisted by an executive council of nine members, partly official, partly unofficial; and by a legislative council of nine members nominated by the crown. There is also a legislative assembly of 29 members, representing 15 electoral districts; the franchise being extended to white and coloured men of 21 years of age at least, resident in the colony for not less than twelve months, and possessing land of a value of £5 or more, or being householders for six months at a rental not less than £2 : 18s. in New Providence, or £1 : 4s. in other islands. The members' qualification is the possession of real or personal estate to the value of £200. The average annual revenue and expenditure may be set down at about £75,000, expenditure somewhat exceeding revenue. There is a public debt of about £105,000. The average annual value of imports is somewhat over £300,000, and of exports £200,000. The average annual tonnage of shipping, entering and clearing, exceeds 1,000,000. The government supports elementary free schools, controlled by a nominated board of education, while committees partly elected exercise local supervision. There are higher schools and a Queen's College in Nassau. Nassau is the seat of a bishopric of the Church of England created in 1861. The Bahamas are without railways, but there are good roads in New Providence, and a few elsewhere. A cable connects Nassau with West Jupiter in Florida.

History.—The story of the Bahamas is a singular one, and bears principally upon the fortunes of New Providence, which, from the fact that it alone possesses a perfectly safe harbour for vessels drawing more than 9 ft., has always been the seat of

government when it was not the headquarters of lawlessness. San Salvador, however, claims historical precedence as the landfall of Columbus on his memorable voyage. Cat Island was long supposed to be the island first reached by Columbus (12th October 1492) and named by him San Salvador. Then the distinction was successively transferred to the neighbouring Watling, Great Turk, and Mariгуана; but in 1880 the American marine surveyor, G. V. Fox, identified San Salvador, on seemingly good grounds, with Samana (Atwood Cay), which lies about midway between Watling and Mariгуана. The chief difficulty is its size, for, if Samana is the true San Salvador, it must have been considerably larger than than now. Watling Island is generally accepted as the landfall.

Columbus passed through the islands, and in one of his letters to Ferdinand and Isabella he said, "This country excels all others as far as the day surpasses the night in splendour; the natives love their neighbours as themselves; their conversation is the sweetest imaginable; their faces always smiling; and so gentle and so affectionate are they, that I swear to your highness there is not a better people in the world." But the natives, innocent as they appeared, were doomed to utter destruction. Ovando, the governor of Hispaniola (Haiti), who had exhausted the labour of that island, turned his thoughts to the Bahamas, and in 1509 Ferdinand authorized him to procure labourers from these islands. It is said that reverence and love for their departed relatives was a marked feature in the character of the aborigines, and that the Spaniards made use of this as a bait to trap the unhappy natives. They promised to convey the ignorant savages in their ships to the "heavenly shores" where their departed friends now dwelt, and about 40,000 were transported to Hispaniola to perish miserably in the mines. From that date, until after the colonization of New Providence by the British, there is no record of a Spanish visit to the Bahamas, with the exception of the extraordinary cruise of Juan Ponce de Leon, the conqueror of Porto Rico, who passed months searching the islands for Bimini, which was reported to contain the miraculous "Fountain of Youth." This is in South Bimini, and has still a local reputation for healing powers.

It is commonly stated that in 1620 the British formed a settlement in New Providence, which they held till 1641, when the Spaniards expelled them. This, however, refers to the Providence Island off the Mosquito Coast; it was only in 1646 that Eleuthera was colonized, and in 1666 New Providence, by settlers from the Bermudas. In 1670 Charles II. made a grant of the islands to Christopher, duke of Albemarle, and others. Governors were appointed by the lords proprietors, and there are copious records in the state papers of the attempts made to develop the resources of the islands. But the buccaneers or pirates who had made their retreat here offered heavy opposition; in 1680 there was an attack by the Spaniards, and in July 1703 the French and Spaniards made a descent on New Providence, blew up the fort, spiked the guns, burnt the church and carried off the governor, with the principal inhabitants, to Havana. In October the Spaniards made a second descent and completed the work of destruction. It is said that when the last of the governors appointed by the lords proprietors, in ignorance of the Spanish raid, arrived in New Providence, he found the island without an inhabitant. It again, however, became the resort of pirates, and the names of many of the worst of these ruffians are associated with New Providence; the notorious Edward Teach, called Blackbeard, who was afterwards killed in action against two American ships in 1718, being chief among the number.

At last matters became so intolerable that the merchants of London and Bristol petitioned the crown to take possession and restore order, and Captain Woodes Rogers was sent out as the first crown governor and arrived at New Providence in 1718. Many families of good character now settled at the Bahamas, and some progress was made in developing the resources of the colony, although this was interrupted by the tyrannical conduct of some of the governors who succeeded Captain Woodes Rogers. At this time the pine-apple was introduced as an article of cultivation at Eleuthera; and a few years subsequently, during

the American war of independence, colonists arrived in great numbers, bringing with them wealth and also slave labour. Cotton cultivation was now attempted on a large scale. In 1783, at Long Island, 800 slaves were at work, and nearly 4000 acres of land under cultivation. But the usual bad luck of the Bahamas prevailed; the red bug destroyed the cotton crops in 1788 and again in 1794, and by the year 1800 cotton cultivation was almost abandoned. There were also other causes that tended to retard the progress of the colony. In 1776 Commodore Hopkins, of the American navy, took the island of New Providence; he soon, however, abandoned it as untenable, but in 1781 it was retaken by the Spanish governor of Cuba. The Spaniards retained nominal possession of the Bahamas until 1783, but before peace was notified New Providence was recaptured by a loyalist, Lieutenant-Colonel Deveaux, of the South Carolina militia, in June 1783.

In 1784 and 1786 sums were voted in parliament to indemnify the descendants of the old lords proprietors, and the islands were formally reconveyed to the crown. The Bahamas began again to make a little progress, until the separation of Turks and Caicos Islands in 1848, which had been hitherto the most productive of the salt-producing islands, unfavourably affected the finances. Probably the abolition of the slave-trade in 1834 was not without its effect upon the fortunes of the landed proprietors. The next event of importance in the history of the Bahamas was the rise of the blockade-running trade, consequent on the closing of the southern ports of America by the Federals in 1861. At the commencement of 1865 this trade was at its highest point. In January and February 1865 no less than 20 steamers arrived at Nassau, importing 14,182 bales of cotton, valued at £554,675. The extraordinary difference between the normal trade of the islands and that due to blockade-running will be seen by comparing the imports and exports before the closing of the southern ports in 1860 with those of 1864. In the first year the imports were £234,029, and the exports £157,350, while in the second year the imports were £5,346,112, and the exports £4,672,398. The excitement, extravagance and waste existing at Nassau during the days of blockade-running exceed belief. Individuals may have profited largely, but the Bahamas probably benefited little. The government managed to pay its debt amounting to £43,786, but crime increased and sickness became very prevalent. The cessation of the trade was marked, however, by hardly any disturbance; there were no local failures, and in a few months the steamers and their crews departed, and New Providence subsided into its usual state of quietude. This, however, was not fated to last long, for in October 1866 a most violent hurricane passed over the island, injuring the orchards, destroying the fruit-trees, and damaging the sponges, which had proved hitherto a source of profit. The hurricane, too, was followed by repeated droughts, and the inhabitants of the out-islands were reduced to indigence and want, a condition which is still, in some measure, in evidence.

See the valuable *General Descriptive Report on the Bahama Islands*, by Sir G. T. Carter (governor, 1898-1904), issued in place of the ordinary annual report by the Colonial Office, London, 1902; also Governor R. W. Rawson's *Report, 1866; Stark's History and Guide to the Bahama Islands* (Boston, Mass., 1891); *Bahama Islands* (Geog. Soc. of Baltimore), ed. G. B. Shattuck (New York, 1905). For geology see A. Agassiz, "A Reconnaissance of the Bahamas and of the Elevated Reefs of Cuba in the steam yacht 'Wild Duck,' January to April 1893," *Bull. Mus. Comp. Zool. Harvard*, vol. xxvi. no. 1, 1894.

BAHAWALPUR, or BHAWALPUR, a native state of India, within the Punjab, stretching for more than 300 m. along the left bank of the Sutlej, the Punjab and the Indus. It is bounded on the N. and E. by Sind and the Punjab, and on the S. by the Rajputana desert. It is the principal Mahomedan state in the Punjab, ranking second only to Patiala. Edward Thornton thus described the general aspect of the state:—

"Bahawalpur is a remarkably level country, there being no considerable eminence within its limits, as the occasional sand-hills, seldom exceeding 50 or 60 ft. in height, cannot be considered exceptions. The cultivable part extends along the river line for a distance of about 10 m. in breadth from the left or eastern bank. In the

sandy part of the desert beyond this strip of fertility both men and beasts, leaving the beaten path, sink as if in loose snow. Here, too, the sand is raised into ever-changing hills by the force of the wind sweeping over it. In those parts of the desert which have a hard level soil of clay, a few stunted mimosas, acacias and other shrubs are produced, together with rue, various bitter and aromatic plants, and occasionally tufts of grass. Much of the soil of the desert appears to be alluvial; there are numerous traces of streams having formerly passed over it, and still, where irrigation is at all practicable, fertility in the clayey tract follows; but the rains are scanty, the wells few and generally 100 ft. deep or more."

The area covers 15,918 sq. m.; pop. (1901) 720,877, showing an increase of 11% on the previous decade; estimated gross revenue, £146,700; there is no tribute. The chief, whose title is nabab, is a Mahomedan of the Daudputra family from Sind, and claims descent from Abbas, uncle of the Prophet. The dynasty established its independence of the Afghans towards the end of the 18th century, and made a treaty with the British in 1838 to which it has always been loyal. The benefits of canal irrigation were introduced in the 'seventies, and the revenue thus doubled. The territory is traversed throughout its length by the North-Western and Southern Punjab railways. There are an arts college and Anglo-vernacular schools.

The town of Bahawalpur is situated near the left bank of the Sutlej, and has a railway station 65 m. from Mooltan. It has a magnificent palace, which is visible from far across the Bikanir desert; it was built in 1882 by Nawab Sadik Mahomed Khan. Pop. (1901) 18,546.

BAHIA, an Atlantic state of Brazil, bounded N. by the states of Piauhys, Pernambuco and Sergipe, E. by Sergipe and the Atlantic, S. by Espírito Santo and Minas Geraes, and W. by Minas Geraes and Goyaz. Its area is 164,650 sq. m., a great part of which is an arid barren *chapada* (plateau), traversed from S. to N. and N.E. by the drainage basin of the São Francisco river, and having a general elevation of 1000 to 1700 ft. above that river, or 2300 to 3000 ft. above sea-level. On the W. the *chapada*, with an elevation of 2300 ft. and a breadth of 60 m., forms the western boundary of the state and the water-parting between the São Francisco and the Tocantins. East of the São Francisco it may be divided into three distinct regions: a rough limestone plateau rising gradually to the culminating ridges of the Serra da Chapada; a gneissose plateau showing extensive exposures of bare rock dipping slightly toward the coast; and a narrower plateau covered with a compact sandy soil descending to the coastal plain. The first two have a breadth of about 200 m. each, and are arid, barren and inhospitable, except at the dividing ridges where the clouds from the sea are deprived of some of their moisture. The third zone loses its arid character as it approaches the coast, and is better clothed with vegetation. The coastal plain varies in width and character: in some places low and sandy, or swampy, filled with lagoons and intersecting canals; in others more elevated, rolling and very fertile. The climate corresponds closely to these surface features, being hot and dry throughout the interior, hot and humid, in places unhealthy, along the coast. Cattle-raising was once the principal industry in the interior, but has been almost extinguished by the devastating droughts and increasing aridity caused by the custom of annually burning over the campos to improve the grass. In the agricultural regions sugar, cotton, tobacco, cacao, coffee, mandioca and tropical fruits are produced. The exports also include hides, mangabeira rubber, piassava fibre, diamonds, cabinet woods and rum. The population is largely of a mixed and unprogressive character, and numbered 1,919,802 in 1890. There is but little immigration and the vegetative increase is low. The capital, São Salvador or Bahia (*q.v.*), which is one of the principal cities and ports of Brazil, is the export town for the Reconcavo, as the fertile agricultural district surrounding the bay is called. The principal cities of the state are Alagoins and Bom Fim (formerly Villa Nova da Rainha) on the main railway line running N. to the São Francisco, Caçoieira and Santo Amaro near the capital in the Reconcavo, Caravellas and Ilheos on the southern coast, with tolerably good harbours, the former being the port for the Bahia & Minas railway, Feira de Santa Anna on the border of the *sertão* and long celebrated for

its cattle fairs, and Jacobina, an inland town N.W. of the capital, on the slopes of the Serra da Chapada, and noted for its mining industries, cotton and tobacco. The state of Bahia includes four of the original captaincies granted by the Portuguese crown—Bahia, Paraguassú, Ilheos and Porto Seguro, all of which reverted to the direct control of that government in 1549. During the war with Holland several efforts were made to conquer this captaincy, but without success. In 1823 Bahia became a province of the empire, and in 1889 a state in the republic. Its government consists of a governor elected for four years, and a general assembly of two chambers, the senators being elected for six years and the deputies for two years. (A. J. L.)

BAHIA, or SÃO SALVADOR, a maritime city of Brazil and capital of the state of Bahia, situated on the Bay of All Saints (*Bahia de Todos os Santos*), and on the western side of the peninsula separating that bay from the Atlantic, in 13° S. lat. and 38° 30' W. long. Pop. (1890) 174,412; (est. 1900) 200,000. The commercial section of the city occupies a long, narrow beach between the water-line and bluffs, and contains the arsenal, exchange, custom-house, post-office, railway station, market and principal business houses. It has narrow streets badly paved and drained, and made still more dirty and offensive by the surface drainage of the upper town. Communication with the upper town is effected by means of two elevators, a circular tramway, and steep zigzag roads. The upper town is built on the western slope of a low ridge, the backbone of the peninsula, and rises from the edge of the bluffs to altitudes of 200 to 260 ft. above the sea-level, affording magnificent views of the bay and its islands. There are wider streets, comfortable residences, and attractive gardens in this part of the city. Here also are to be found the churches, schools, theatres, asylums, and hospitals, academies of law and medicine, governor's palace, public library, and museum, and an interesting public garden on the edge of the bluff, overlooking the bay. The city is served by four street-car lines, connecting the suburbs with both the upper and lower towns. In 1906 contracts were made to reconstruct some of these lines for electric traction. The railways radiating from the city to inland points are the Bahia & Alagoins which is under construction to Joazeiro, on the São Francisco river, a short line to Santo Amaro, and two lines—the Bahia Central and the Nazareth tramway—extending inland from points on the opposite side of the bay. The port of Bahia, which has one of the best and most accessible harbours on the east coast of South America, has a large coastwise and foreign trade, and is also used as a port of call by most of the steamship lines trading between Europe and that continent. Bahia was founded in 1549 by Thomé de Souza, the first Portuguese governor-general of Brazil, and was the seat of colonial administration down to 1763. It was made the seat of a bishopric in 1551, and of an archbishopric in 1676, and until 1905 was the metropolis of the Roman Catholic Church in Brazil. The city was captured in 1624 by the Dutch, who held it only a few months. Always conservative in character, the city hesitated in adhering to the declaration of independence in 1822, and also to the declaration of the republic in 1889. Much of its commercial and political importance has been lost, also, through the decay of industrial activity in the state, and through the more vigorous competition of the agricultural states of the south. (A. J. L.)

BAHIA BLANCA, a city and port of Argentina, on the Naposta river, 3 m. from its outlet into a deep, well-sheltered bay of the same name. Pop. (est. 1903) 11,600. It is situated in the extreme southern part of the province of Buenos Aires and is 447 m. by rail S.W. of the national capital. The opening to settlement of the national territories of La Pampa and Neuquén has contributed largely to the growth and importance of Bahia Blanca. It is the natural shipping-port for these territories and for the southern districts of the province of Buenos Aires, from which great quantities of wheat and wool are exported. The bay has long been recognized as one of the best on the Argentine coast, and when the channel is properly dredged, will admit steamers of 30 ft. draught at low-water. The Argentine government has located its principal naval station here, at the

Puerto Militar, between the city and the entrance to the bay. The port, whose trade is increasing rapidly, is connected with the neighbouring and interior producing districts by five or six lines of railway and their branches. Bahía Blanca dates from 1828, when a fort and trading post were located here, but its development as a commercial centre began only in 1885, when its first railway line was opened. In 1908 direct railway communication was opened with Mendoza and San Juan. Though situated near the mountainous section of southern Buenos Aires, the immediate vicinity of the city is low and swampy, its water is brackish, and it has been decidedly unhealthy; but a water supply from the Sauce Grande, 50 m. distant, was projected in 1906, and this, with better drainage and street paving, was expected to improve matters. The mean annual temperature is 60°, and the average annual rainfall is 19 in. The city has street cars, electric-lights and telephone service, and the port has a shipping pier 1640 ft. long, with spacious warehouses and several miles of railway sidings.

BAHR, the Arabic for "sea," with the diminutive *bahira*. Bahr also signifies a river, especially one with a large body of water, e.g. the Nile, and is sometimes used to designate the dry bed of a river.

BAHRAICH or **BARAICH**, a town and district of British India, situated in the Fyzabad division of the United Provinces. The town is on the river Sarju. Since the opening of the railway the place has begun to flourish. It contains the most popular place of pilgrimage in Oudh, the tomb of Masaud, a champion of Islam, slain in battle by the confederate Rajputs in 1033, which is resorted to by Mahomedans and Hindus alike. There is also a Mussulman monastery, and the ruined palace of a nawab of Oudh. The American Methodists have a mission here. Pop. (1901) 27,394.

The district of Bahraich contains an area of 2647 sq. m. It consists of three tracts: (1) in the centre, an elevated triangular plateau, projecting from the base of the Himalayas for about 50 m. in a south-easterly direction—average breadth, 13 m., area, 670 sq. m.; (2) the great plain of the Gogra, on the west, about 40 ft. below the level of the plateau; and (3) on the east, another lesser area of depression, comprising the basin of the Rapti. The *taras*, or the forest and marshy tracts along the southern slopes of the Himalayas, gradually merge within the district into drier land, the beds of the streams become deeper and more marked, the marshes disappear, and the country assumes the ordinary appearance of the plain of the Ganges. The Gogra skirts the district for 114 m.; and the Rapti, with its branch the Bhalka, drains the high grounds. In 1901 the population was 1,051,347, showing an increase of 5% in the decade. A considerable trade is conducted with Nepal, chiefly in timber. A line of railway has been opened through the district to Nepalganj on the frontier. As there are no canals in the district, irrigation is obtained solely from wells, tanks and rivers. The district is purely agricultural in character, and is one of large estates, 78% being held by *taluqdars*, of whom the four chief are the raja of Kapurthala, the maharaja of Balrampur, the raja of Nanpara and the raja of Payagpur.

Little is known of the history of the district before the Mahomedan invasion in A.D. 1033. Masaud was defeated and slain by the nobles of Bahraich in 1033, and the Mahomedans did not establish their authority over the country till the middle of the 13th century. About 1450 the Raikwars, or Rajput adventurers, made themselves masters of the western portion of the district, which they retain to this day. In 1816 by the treaty of Segauli the Nepal *tarai* was ceded to the British, but was given back in 1860. During the Mutiny the district was the scene of considerable fighting, and after its close a large portion was distributed in *jagirs* to loyal chiefs, thus originating the *taluqdari* estates of the present day.

BAHRĀM (*Vārāhrān*, in Gr. *Ὀυαπαράνης* or *Ὀυραπάνης*, the younger form of the old *Verethragna*, the name of a Persian god, "the killer of the dragon Verethra"), the name of five Sassanid kings.

1. **BAHRĀM I.** (A.D. 274–277). From a Pahlavi inscription we

learn that he was the son (not, as the Greek authors and Tabari say, the grandson) of Shapur I., and succeeded his brother Hormizd (Ormizdas) I., who had only reigned a year. Bahrām I. is the king who, by the instigation of the magians, put to a cruel death the prophet Mani, the founder of Manichæism. Nothing else is known of his reign.

2. **BAHRĀM II.** (277–294), son of Bahrām I. During his reign the emperor Carus attacked the Persians and conquered Ctesiphon (283), but died by the plague. Of Bahrām II.'s reign some theological inscriptions exist (F. Stolze and J. C. Andreas, *Persepolis* (Berlin, 1882), and E. W. West, "Pahlavi Literature" in *Grundriss d. iranischen Philologie*, ii, pp. 75–129).

3. **BAHRĀM III.**, son of Bahrām II., under whose rule he had been governing Sejistān (therefore called Saganshah, Agathias iv. 24, Tabari). He reigned only four months (in 294), and was succeeded by the pretender Narseh.

4. **BAHRĀM IV.** (380–390), son and successor of Shapur III., under whom he had been governor of Kirman; therefore he was called Kirmanshah (Agathias iv. 26; Tabari). Under him or his predecessor Armenia was divided between the Roman and the Persian empire. Bahrām IV. was killed by some malcontents.

5. **BAHRĀM V.** (420–439), son of Yazdegerd I., after whose sudden death (or assassination) he gained the crown against the opposition of the grandees by the help of al-Mondhir, the Arabic dynast of Hira. He promised to rule otherwise than his father, who had been very energetic and at the same time tolerant in religion. So Bahrām V. began a systematic persecution of the Christians, which led to a war with the Roman empire. But he had little success, and soon concluded a treaty by which both empires promised toleration to the worshippers of the two rival religions, Christianity and Zoroastrianism. Bahrām deposed the vassal king of the Persian part of Armenia and made it a province. He is a great favourite in Persian tradition, which relates many stories of his valour and beauty, of his victories over the Romans, Turks, Indians and Negroes, and of his adventures in hunting and in love; he is called Bahrām Gūr, "the wild ass," on account of his strength and courage. In reality he seems to have been rather a weak monarch, after the heart of the grandees and the priests. He is said to have built many great fire-temples, with large gardens and villages (Tabari). (Ed. M.)

BAHRDT, KARL FRIEDRICH (1741–1792), German theologian and adventurer, was born on the 25th of August 1741 at Bischofswerda, where his father, afterwards professor, canon and general superintendent at Leipzig, was pastor. At the age of sixteen young Bahrdt, a precocious lad whose training had been grossly neglected, began to study theology under the orthodox mystic, Christian August Crusius (1715–1775), who in 1757 had become first professor in the theological faculty. The boy varied the monotony of his studies by pranks which revealed his unbalanced character, including an attempt to raise spirits with the aid of *Dr Faust's Hüllenswung*. His orthodoxy was, however, unimpeachable, his talent conspicuous, and in 1761 he was appointed lecturer on biblical exegesis, and preacher (*Katechet*) at the church of St Peter. His eloquence soon gave him a reputation, and in 1766 he was appointed professor extraordinary of biblical philology. Two years later, however, the scandals of his private life led to his dismissal. In spite of this he succeeded in obtaining the chair of biblical antiquities in the philosophical faculty at Erfurt. The post was unpaid, and Bahrdt, who had now married, lived by taking pupils and keeping an inn. He had meanwhile obtained the degree of doctor of theology from Erlangen, and was clever enough to persuade the Erfurt authorities to appoint him professor designate of theology. His financial troubles and coarse and truculent character, however, soon made the town too hot to hold him; and in 1771 he was glad to accept the offer of the post of professor of theology and preacher at Giessen.

Thus far Bahrdt's orthodoxy had counterbalanced his character; but at Giessen, where his behaviour was no less objectionable than elsewhere, he gave a handle to his enemies by a change

in his public attitude towards religion. The climax came with the publication of his *Neueste Offenbarungen Gottes in Briefen und Erzählungen* (1773-1775), purporting to be a "model version" of the New Testament, rendered, with due regard to enlightenment, into modern German. The book is remembered solely through Goethe's scornful attack on its want of taste; its immediate effect was to produce Bahrdt's expulsion from Giessen. He was lucky enough at once to find a post as principal of the educational institution established in his château at Marschlin by the Swiss statesman Ulysses von Salis (1728-1800). The school had languished since the death of its founder and first head, Martin Planta (1727-1772), and von Salis hoped to revive it by reconstituting it as a "Philanthropin" under Bahrdt's management. The experiment was a failure; Bahrdt, never at ease under the strict discipline maintained by von Salis, resigned in 1777, and the school was closed. At the invitation of the count of Leiningen-Dachsburg, Bahrdt now went as general superintendent to Dürkheim on the Hardt; his luckless translation of the Testament, however, pursued him, and in 1778 he was suspended by a decision of the high court of the Empire. In dire poverty he fled, in 1779, to Halle, where in spite of the opposition of the senate and the theologians, he obtained through the interest of the Prussian minister, von Zedlitz, permission to lecture on subjects other than theology. Forced to earn a living by writing, he developed an astounding literary activity. His orthodoxy had now quite gone by the board, and all his efforts were directed to the propaganda of a "moral system" which should replace supernatural Christianity.

By such means Bahrdt succeeded in maintaining himself until, on the death of Frederick the Great, the religious reaction set in at the Berlin court. The strain of writing had forced him to give up his lectures, and he had again opened an inn on the Weinberg near Halle. Here he lived with his mistress and his daughters—he had repudiated his wife—in disreputable peace until 1789, when he was condemned to a year's imprisonment for a lampoon on the Prussian religious edict of 1788. His year's enforced leisure he spent in writing indecent stories, coarse polemics, and an autobiography which is described as "a mixture of lies, hypocrisy and self-prostitution." He died on the 23rd of April 1792.

See life, with detailed bibliography, by Paul Tschakert in Herzog-Hauck, *Realencyklopädie*; a more favourable account is given in J. M. Robertson's *Short History of Free Thought*, ii. 278.

BAHREIN ISLANDS, a group of islands situated about 20 m. east of the coast of El Hasa, in the Persian Gulf, a little to the south of the port of El Katif, which, if rightly identified with the ancient Gerrha, has been celebrated throughout history as the mart of Indian trade, the starting-point of caravans across Arabia. The largest of the group is called Bahrein. It is about 27 m. long from north to south and about 10 wide—a low flat space of sandy waste with cultivated oases and palm groves of great luxuriance and beauty. The rocky hill of Jebel Dukhan (the "mountain of the mist") rises in the midst of it to a height of 400 ft. The rest of the group are of coral formation. The next island in size to Bahrein is Moharek, curved in shape, and about 5 m. long by ½ m. in breadth. It lies 1 m. to the north of Bahrein. Sitrah (4 m. long) Nebbi, Saleh, Sayeh, Khafirah and Arad (½ m. long) complete the group. Of these minor islands Arad alone retains its classical name.

The climate is mild, but humid, and rather unhealthy. The soil is for the most part fertile, and produces rice, pot herbs and fruits, of which the citrons are especially good. Water is abundant. Fish of all kinds abound off the coast, and are very cheap in the markets. The inhabitants are a mixed race of Arab, Omanite and Persian blood, slender and small in their physical appearance; they possess great activity and intelligence, and are known in all the ports of the Persian Gulf for their commercial and industrial ability.

The sea around the Bahrein islands is shallow, so shallow as to admit only of the approach of native craft, and the harbour is closely shut in by reefs. There is very little doubt that it was

from these islands that the Puni, or Phoenicians, emigrated northwards to the Mediterranean. Bahrein has always been the centre of the pearl fishing industry of the Persian Gulf. There are about 400 boats now employed in the pearl fisheries, each of them paying a tax to the Sheik. The pearl export from Linja is valued at about £30,000 to £35,000 per annum.

The capital town of Bahrein is *Manameh*, a long, straggling, narrow town of about 8000 inhabitants, chiefly of the Wahabi sect. Manameh is adjacent to the most northern point of the island, and looks across the narrow strait to Moharek.

Fish and sea-weed form the staple food of the islanders. The water-supply of Moharek is probably unique. It is derived from springs which burst through the beds below sea-level with such force as to retain their freshness in the midst of the surrounding salt water. Scattered through the islands are some fifty villages, each possessing its own date groves and cultivation, forming features in the landscape of great fertility and beauty. Most of these villages are walled in for protection.

The Portuguese obtained possession of the islands in 1507, but were driven from their settlements in that quarter by Shah Abbas in 1622. The islands afterwards became an object of contention between the Persians and Arabs, and at last the Arabian tribe of the Athubis made themselves masters of them in 1784.

The present Sheik of Bahrein (who lives chiefly at Moharek) is of the family of El Kalifa. This ruling race was driven from the mainland (where they held great possessions) by the Turks about 1850. In the year 1867 the Persians threatened Bahrein, and in 1875 the Turks laid their hands on it. British interference in both cases was successful in maintaining the integrity of Arab rule, and the Bahrein islands are now under British protection.

To the south-west of the picturesque belts of palm trees which stretch inland from the northern coast of Bahrein, is a wide space of open sandy plain filled with gigantic tumuli or earth mounds, of which the outer layers of gravel and clay have been hardened by the weather action of centuries to the consistency of conglomerate. Within these mounds are two-chambered sepulchres, built of huge slabs of limestone, several of which have been opened and examined by Durand, Bent and others, and found to contain relics of undoubted Phoenician design. Scattered here and there throughout the islands are isolated mounds, or smaller groups, all of which are of the same appearance, and probably of similar origin. (T. H. H.)*

BAHR-EL-GHAZAL, the chief western affluent of the river Nile, N.E. Africa, which it joins in 9° 30' N., 30° 25' E. The Bahr-el-Ghazal (Gazelle river) is a deep stream formed by the junction of many rivers, of which the Jur (see below) is the most important. The basin of the Ghazal is a large one, extending north-west to Darfur, and south-west to the Congo watershed. The main northern feeder of the Ghazal is a large river, whose headwaters are in the country west of 24° E. where the Nile, Congo and Shari watersheds meet. Reinforced by intermittent streams from the hills of Darfur and by considerable rivers flowing north from Dar Fertit, this river after reaching as far north as about 10° 30' pursues a general south-easterly direction until it joins the Ghazal 87 m. above the Deleb confluence (see below). This main northern feeder passes through the country of the Homr Arabs and Bahr-el-Homr may be adopted as its name. On many maps it is marked as the Bahr-el-Arab, a designation also used as an alternative name for the Lol¹ another tributary of the Ghazal, which eventually unites with the Bahr-el-Homr. The Bahr-el-Homr in its lower reaches was in 1906 completely blocked by sudd (q.v.), and then brought no water into the Bahr-el-Ghazal. The Sudan government, however, sent engineering parties to remove the sudd blocks and open out a continuous waterway. This Bahr-el-Homr is the only affluent of

¹ The Lol is also called the Kir, a name given likewise to the lower course of the Bahr-el-Homr. The confusion of names is partly attributable to the fact that each tribe has a different name for the same stream. It is also due in part to the belief that there was a large river flowing between the Bahr-el-Homr and the Lol. This third river, generally called the Kir, has proved to be only the lower course of the Lol or Bahr-el-Arab.

importance which has tributaries coming from north of the main stream; the rest of the very numerous affluents have their rise in the hilly country which stretches from Albert Nyanza in a general north-west direction as far as 23° E., and forms the watershed between the Nile basin and that of the Congo.

Chief affluents. The most westerly is the Lol or Bahr-el-Arab. It rises, as the Boro or Telgona, in Dar Fertit, and receives from the south and south-west the Raga, Sopo, Chel and Bongu. Dem Zobeir, formerly the chief station of Zobeir Rahama (*q.v.*), is near the Biri tributary of the Chel, in 7° 40' N., 26° 10' E. The Lol maintains a fairly straight course east to about 28° E., when it turns north-east, and in about 28½° E., 9½° N., joins the Bahr-el-Homr. The chief of the southern affluents, and that tributary of the Ghazal which contributes the largest volume of water, is the Jur, known in its upper course as the Sue, Swe or Souch. The Sue rises north of 4° N. in about 29° E., within three or four days' journey of the navigable waters of the Mbomou, a northern sub-tributary of the Congo. After flowing north for several hundred miles the Sue, now the Jur, is joined on the left bank, in about 7° 30' N., 28° E., by the Wau, a considerably larger river whose headwaters are west of those of the Jur. The united stream now turns east and joins the Ghazal through a lake-like expansion (see below). The town of Wau (7° 42' N., 28° 3' E.), on the Jur, is the capital of the Bahr-el-Ghazal province of the Anglo-Egyptian Sudan. Meshra-er-Rek, the chief station and trading centre of the first European visitors to the country, is on a backwater south of this lake. Between the Jur and the Nile, and following a course generally parallel with these rivers, several streams run north from the Congo-Nile watershed and join the Bahr-el-Ghazal. The Tonj, the most westerly of these rivers, joins the Jur a little above its confluence with the Ghazal. The Rohl (or Yalo), farther east, empties into a wide channel known as Khor Deleb, which joins the Ghazal some 9 m. above Lake No, and from the confluence the stream is known as the Deleb. Lake No is little more than a depression into which the waters of the Ghazal system pass near the point of junction with the Bahr-el-Jebel. The lake is about 7 m. long from west to east, and the Bahr-el-Jebel, after passing through its eastern corner, changes its name to Bahr-el-Abiad or White Nile.

In their upper courses all the southern affluents of the Ghazal flow across a plateau of ferruginous laterite, their valleys having steep banks. North of 7° 20' N. (where rapids interrupt the currents) the valleys open out and the rivers wind in tortuous channels often choked by sandbanks. This alluvial region, flooded in the rainy season, gives place about 6° N. to a sea of swamps, forming in fact part of the huge swamp region of the Nile (*q.v.*). Through these swamps it is almost impossible to trace the course of the various rivers. The Bahr-el-Ghazal itself is described as a drainage channel rather than a true river. From the confluence of the Lol with the Jur, above which point none of the rivers is called Bahr-el-Ghazal, to the junction with the Nile at Lake No, is a distance of about 200 m. Just above the Lol confluence the Jur broadens out and forms a lake (Ambadi) 10 m. long and over a mile broad at low water and very much larger in flood time. This lake is the home of many sudd plants of the "swimming" variety—papyrus and ambach are absent. The *Balaniceps rex*, elsewhere rare, is found here in large numbers. At first the Ghazal flows north with lagoon-like expansions having great breadth and little depth—nowhere more than 13 ft. Turning north-east the channel becomes narrower and deeper, and is characterized by occasional reaches of papyrus. Finally, the Ghazal turns east and again becomes broader until Lake No is reached. As a rule the banks in this section are marked by anthills and scrub. The anthills in one valley are so close together "that they somewhat resemble a gigantic graveyard" (Sir William Garstin). The rise of the Ghazal river in flood time is barely 3 ft., a depth sufficient, however, to place an enormous area of country under water.

Exploration of the River.—Rumours of the existence of the Bahr-el-Ghazal led some of the Greek geographers to imagine that the source of the Nile was westward in the direction of Lake Chad. The first map on which the course of the Ghazal

is indicated with anything like accuracy is that of the French cartographer d'Anville, published in 1772. The exploration of the river followed the ascent of the White Nile by the Egyptian expeditions of 1839–1842. For a considerable portion of the period between 1853 and 1865 John Petherick, a Welshman, originally a mining engineer, explored the Ghazal region, particularly the main stream and the Jur. In 1859 a Venetian, Giovanni Miani, penetrated the southern regions of the Ghazal basin and was the first to bring back reports of a great river (the Welle) flowing west beyond the Nile watershed. In 1862 a Frenchman named Lejean surveyed the main river, of which he published a map. In 1863 Miss Alexandrine Tinné (*q.v.*) with a large party of friends and scientists ascended the Ghazal with the intention of seeing how far west the basin of the Nile extended. The chief scientists of the party were the Germans, Theodor von Heuglin and Hermann Steudner. Considerable additions to the knowledge of the region were made by this expedition, five out of the nine white members of which died from blackwater fever.¹ Georg Schweinfurth (*q.v.*) between 1869 and 1871 traversed the whole of the southern district, and crossing the watershed discovered the Welle. The efforts to destroy the slave trade in the Ghazal province led (1870–1881) to the further exploration of the river and its tributaries by Gessi Pasha, the Italian governor under General C. G. Gordon. Wilhelm Junker (*q.v.*) about the same period also explored the southern tributaries of the Ghazal. These were carefully surveyed, and the Jur (Sue) followed throughout its course by Lieutenant A. H. Dyé and other members of the French mission under Colonel (then Captain) J. B. Marchand, which crossing from the Congo (Oct. 1897) reached Fashoda on the White Nile in July 1898.

Like the Bahr-el-Jebel the Bahr-el-Ghazal is liable to be choked by sudd. Gessi Pasha was imprisoned in it for some six weeks. The river became almost blocked by the accumulation of this obstruction during the rule of the Mahdists. In 1901 and following years the sudd was removed by British officers from the Bahr-el-Ghazal, the Jur and other rivers. Uninterrupted steamboat communication was thus established during the flood season between Khartoum and Wau, a distance of some 930 m. In 1905–1907 R. C. Bayldon, a British naval officer, Capt. C. Percival and Lieut. D. Comyn partly explored the northern and western affluents of the Ghazal, and threw some light on the puzzling hydrography and nomenclature of those tributaries.

See NILE and the authorities there quoted, especially Sir William Garstin's *Report upon the Basin of the Upper Nile, Egypt, No. 2* (1904), and Capt. H. G. Lyons's *The Physiography of the River Nile and its Basin* (Cairo, 1906); also *The Geographical Journal*, vol. xxx. (1907). (W. E. G.; F. R. C.)

BAHUT (a French word of unknown origin), a portable coffer or chest, with a rounded lid covered in leather, garnished with nails, used for the transport of clothes or other personal luggage,—it was, in short, the original portmanteau. This ancient receptacle, of which mention is made as early as the 14th century —its traditional form is still preserved in many varieties of the modern travelling trunk,—sometimes had its leather covering richly ornamented, and occasionally its interior was divided into compartments; but whatever the details of its construction it was always readily portable. Towards the end of the 17th century the name fell into desuetude, and was replaced by "coffer" (*q.v.*), which probably accounts for its misuse by the French romantic writers of the early 19th century. They applied it to almost any antique buffet, cupboard or wardrobe, and its use has now become hopelessly confused.

In architecture, this term is also used for a dwarf-wall of plain masonry, carrying the roof of a cathedral or church and masked or hidden behind the balustrade.

BAHYA, IBN PAQUDA, a Jewish ethical writer who flourished at Saragossa in the 11th century. In 1040 he wrote in Arabic a treatise, *Duties of the Heart*. This book was one of the most significant and influential Jewish works of the middle ages. Bahya portrays an intensely spiritual conception of religion, and rises at times to great heights of impassioned mysticism.

¹ Including Miss Tinné's mother and aunt and Dr Steudner.

The Law, in the rabbinical sense, was revered by Bahya, and he converted it into part and parcel of the Jew's inner life. The book is divided into ten parts:—the Unity of God; Contemplation; Worship; Trust; Consecration; Humility; Repentance; Self-Examination; the Ascetic Life; the Love of God. Some selections from Bahya's work have been rendered into English by E. Collins. (I. A.)

BAIAE, an ancient city of Campania, Italy, 10 m. W. of Neapolis, on the *Sinus Baianus*, a bay on the W. coast of the Gulf of Puteoli. It is said to derive its name from *Baiōs*, the helmsman of Ulysses, whose grave was shown there; it was originally, perhaps, the harbour of Cumae. It was principally famous, however, for its warm sulphur springs, remarkable for their variety and curative properties (Pliny, *Hist. Nat.* xxxi. 4), and its luxuriant vegetation (though in summer there was some malaria in the low ground). It was already frequented, especially by the rich, at the end of the republican period; and in Strabo's day it was as large as Puteoli. Julius Caesar possessed a villa here, the remains of which are probably to be recognized in some large substructures on the ridge above the 16th-century castle. Baiae was a favourite residence of the emperors. Nero built a huge villa probably on the site now occupied by the castle. Hadrian died in Caesar's villa in A.D. 138, and Alexander Severus erected large buildings for his mother. Baiae never became, however, an independent town, but formed part of the territory of Cumae. Three glass vases with views of the coast and its buildings were published by H. Jordan in *Archäologische Zeitung* (1868, 91). The luxury and immorality of the life of Baiac under both the republic and the empire are frequently spoken of by ancient writers.

Near Baiae was the villa resort of Bauli, so called from the *βοῦλῆα* (stalls) in which the oxen of Geryon were concealed by Hercules. By some it is identified with the modern village of Bacoli (owing to a presumed similarity to the ancient name), 2 m. S.S.E. of Baiae; by others with the Punta dell' Epitaffio, 1 m. N.E. of Baiae (see G. B. de Rossi in *Notizie degli scavi*, 1888, 709). At Bauli, Pompey and Hortensius possessed villas, the former on the hills, while that of the latter, on the shores of the Lacus Lucrinus, was remarkable for its tame lampreys and as the scene of the dialogue in the second book of Cicero's *Academica Priora*; it afterwards became imperial property and was the scene of Agrippina's murder by Nero. It was from Bauli to Puteoli that Caligula built his bridge of boats.

Of the once splendid villas and baths of Baiae and its district, the foundations of which were often thrown far out into the sea, considerable, though fragmentary, remains exist. It is not, as a rule, possible to identify the various buildings, and the names which have been applied to the ruins are not authenticated. At Baiae itself there exist three large and lofty domed buildings, two octagonal, one circular, and all circular in the interior, of *opus reticulatum* and brick, which, though popularly called temples, are remains of baths or *nymphaea*. The Punta dell' Epitaffio also is covered with remains, while at Bacoli are several ruins—to the north of the village a small theatre, called the tomb of Agrippina; under the village the remains of a large villa; to the E. the remains of a large water reservoir, the so-called Cento Camerelle; to the S. another with a vaulted ceiling, known as the *piscina mirabilis*, measuring 230 by 85 ft. The villa of Marius, which was bought by Lucullus, and afterwards came into the possession of the imperial house, was the scene of the death of Tiberius. It is sometimes spoken of as *Baiana*, sometimes as *Misenensis*, and is perhaps to be sought at Bacoli (Th. Mommsen in *Corp. Inscript. Latin.*, x., Berlin, 1833, 1748), though Beloch inclines to place it on the promontory S. of Misenum, and this perhaps agrees better with the description given by Phaedrus.

Baiae was devastated by the Saracens in the 8th century and entirely deserted on account of malaria in 1500.

See J. Beloch, *Campanien* (2nd ed., Breslau, 1890), 180 seq. (T. As.)

BAÏBUR, a town of Asiatic Turkey, on the direct carriage road from Trebizond to Erzerum, situated on both banks of the

Churuk river, which here traverses an open cultivated plateau (altitude, 5100 ft.), before turning east. It is the chief place of a kaza under Erzerum; the bazaar is poor, and there is no special industry in the town. The houses run up the hillsides on both banks of the river to a considerable height. On an isolated mass of rock, on the left bank, is the old castle, with extensive walls partly ruined, built originally by the Armenians and restored by the Seljuks. The principal gate with some Arabic inscriptions stands at the S.W. corner. There are remains of a vaulted chamber, a Christian church, a mosque and two covered staircases to the river. A fine view is seen from the summit over the plain and the Pontic ranges to the north. The population numbers 10,000, mostly Turkish with some Armenians. The place was occupied by the Russians under General Paskevich during their invasion of 1829, and was the farthest point westward then reached by them. (F. R. M.)

BAÏDĀWĪ ('Abdallāh ibn 'Umar al-Baidāwī, Mahomedan critic, was born in Fars, where his father was chief judge, in the time of the Atabek ruler Abu Bakr ibn Sa'd (1226-1260). He himself became judge in Shiraz, and died in Tabriz about 1286. His chief work is the commentary on the Koran entitled *The Secrets of Revelation and the Secrets of Interpretation* (*Asrār ut-tanzīl wa Asrār ul-ta'wīl*). This work is in the main a digest of the great Mu'tazilite commentary (*al-Kashshaf*) of Zamakhashari (q.v.) with omissions and additional notes. By the orthodox Moslems it is considered the standard commentary and almost holy, though it is not complete in its treatment of any branch of theological or linguistic knowledge of which it treats, and is not always accurate (cf. Th. Nöldeke's *Geschichte des Korans*, Göttingen, 1860, p. 29). It has been edited by H. O. Fleischer (2 vols., Leipzig, 1846-1848; indices ed. W. Fell, Leipzig, 1878). There are many editions published in the East. A selection with numerous notes was edited by D. S. Margoliouth as *Chrestomathia Beidawiana* (London, 1894). Many supercommentaries have been written on Baidāwī's work. He was also the author of several theological treatises.

See C. Brockelmann's *Geschichte der arabischen Litteratur* (Weimar, 1898), vol. I. pp. 416-418. (G. W. T.)

BAÏF, JEAN ANTOINE DE (1532-1589), French poet and member of the Pléiade, was born at Venice in 1532. He was the natural son of the scholar Lazare de Baïf, who was at that time French ambassador at Venice. Thanks, perhaps, to the surroundings of his childhood, he grew up an enthusiast for the fine arts, and surpassed in zeal all the leaders of the Renaissance in France. His father spared no pains to secure the best possible education for his son. The boy was taught Latin by Charles Estienne, and Greek by Ange Vergece, the Cretan scholar and calligraphist who designed Greek types for Francis I. When he was eleven years old he was put under the care of the famous Jean Daurat (q.v.). Ronsard, who was eight years his senior, now began to share his studies. Claude Binet tells how young Baïf, bred on Latin and Greek, smoothed out the tiresome beginnings of the Greek language for Ronsard, who in return initiated his companion into the mysteries of French versification. Baïf possessed an extraordinary facility, and the mass of his work has injured his reputation. Besides a number of volumes of short poems of an amorous or congratulatory kind, he translated or paraphrased various pieces from Bion, Moschus, Theocritus, Anacreon, Catullus and Martial. He resided in Paris, and enjoyed the continued favour of the court. He founded in 1567 an *académie de musique et de poésie*, with the idea of establishing a closer union between music and poetry; his house became famous for the charming concerts which he gave, entertainments at which Charles IX. and Henry III. frequently flattered him with their presence. Baïf elaborated a system for regulating French versification by quantity. In this he was not a pioneer. Jacques de la Taille had written in 1562 the *Manière de faire des vers en français comme en grec et en latin* (printed 1573), and other poets had made experiments in the same direction. The 16th-century poets did not realize the

¹ For an account of this academy see Edouard Frémy, *Les Origines de l'Académie Française* (1887).

¹ incompatibility of the system of quantity with French rhythm. Balf's innovations included a line of 15 syllables known as the *vers balfin*. He also meditated reforms in French spelling. His theories are exemplified in *Eirenes de poesie Francoese an vers meures* (1514). His works were published in 4 volumes, entitled *Œuvres en rime* (1573), consisting of *Amours, Jeux, Passetemps, et Poèmes*, containing, among much that is now hardly readable, some pieces of infinite grace and delicacy. His sonnet on the *Roman de la Rose* was said to contain the whole argument of that celebrated work, and Colletet says it was on everybody's lips. He also wrote a celebrated sonnet in praise of the massacre of Saint Bartholomew. Balf was the author of two comedies, *L'Eunuque*, 1565 (published 1573), a free translation of Terence, and *Le Brave* (1567), an imitation of the *Miles Gloriosus*, in which the characters of Plautus are turned into Frenchmen, the action taking place at Orleans. Balf published a collection of Latin verse in 1577, and in 1576 a popular volume of *Mimes, enseignemens et proverbes*. He died in 1589. His father, Lazare de Balf,¹ published a translation of the *Electra* of Sophocles in 1537, and afterwards a version of the *Hecuba*; he was an elegant writer of Latin verse, and is commended by Joachim du Bellay as having introduced certain valuable words into the French language.

The *Œuvres en rime* (5 vols., 1881-1890) of J. A. de Balf form part of the *Pléiade française* of M. Ch. Marty-Laveaux. See also Becq de Fouquières, *Poésies choisies de J. A. de Balf* (1874), with a valuable introduction; and F. Brunetière, *Hist. de la litt. française classique* (1904, bk. iii. pp. 398-422).

BAIKAL (known to the Mongols as *Dalai-nor*, and to the Turkish tribes as *Bai-kul*), a lake of East Siberia, the sixth in size of all the lakes of the world and the largest fresh-water basin of Eurasia. It stretches from S.W. to N.E. ($51^{\circ} 20'$ to $55^{\circ} 50'$ N. lat. and $103^{\circ} 40'$ to $110^{\circ} 0'$ E. long.), separating the government of Irkutsk from that of Transbaikalia, and has a length of 386 m. and a width of from 20 m. to 50 m. Its southern extremity penetrates into the high plateau of Asia, and the lake lies entirely in the Alpine zone which fringes that plateau on the north-west. Its area is 13,200 sq. m., i.e. nearly as great as Switzerland. The length of its coast-line is 525 m. along the western, and 640 m. along the eastern shore. Its altitude has been estimated at 1587 ft. (Chersky) and at 1679 ft. (Suess)—118 ft. above the level of the Angara at Irkutsk (*Zapiski Russ. Geog. Soc.* xv., 1885); but 1500 ft. would seem to be a more correct altitude (*Investia East Sib. Branch*, xxviii. 1, 1897). Its level is subject to slight oscillations, and after a heavy five weeks' rain in 1869 it rose 7 ft., an immense territory at the mouth of the Selenga being submerged.

A hydrographic survey of this lake was made by Drizhenko in 1897-1902. The elongated hilly island of Olkhon, and the peninsula of Svyatoi Nos, which forms its continuation on the opposite eastern shore, divide the lake into two basins. The deepest part is in the south-east, at the foot of the Khamar-daban border-ridge of the high plateau. An elongated trough, 66 m. long, reaches there a depth of over 600 fathoms, with a maximum depth of 880 fathoms, i.e. about 5280 ft. below the level of the ocean. As a rule the bottom of the lake has very steep slopes: the 100-fathom and even the 250-fathom lines run close to the shores, that is to say, the steepness of the surrounding mountains (4600 to 6000 ft.) continues beneath the surface. At the mouth of the Selenga, however, which enters from the south-east, pouring into it the waters and the alluvial deposits from a drainage area of 173,500 sq. m., a wide delta is thrust out into the lake, reducing its width to 20 m. and spreading under its waters, so as to leave only a narrow channel, 230 to 247 fathoms deep, along the opposite coast. The depth of the middle portion of the lake has not yet been measured, but must exceed 500 fathoms. It was expected that an underground ridge would be found connecting Olkhon with Svyatoi Nos; but depths exceeding 622 fathoms have been sounded even along that line. As to the northern basin, the configuration of its bottom is in accordance with the high mountains which

surround it, and most of its area has a depth exceeding 400 fathoms, the maximum depths along three lines of soundings taken across it being 491, 485, and 476 fathoms respectively. The water is beautifully clear.

Temperature.—The surface-layers of this immense basin are heated in the summer up to temperatures of $55\frac{1}{2}^{\circ}$ to 57° F., both close to the shores and at some distance from the mouth of the Selenga; but these warmer layers are not deep, and a uniform temperature of nearly 39° F. is generally found at a depth of 20 fathoms, as also on the surface in the middle of the lake. At a depth of 500 fathoms there is a nearly uniform temperature of 38° . At various places round the shores, e.g. the mouth of the Barguzin, hot springs exist. The lake freezes usually at the end of December, or in the beginning of January, so solidly that a temporary post-horse station is erected on the ice in the middle of the lake, and it remains frozen till the second half of May. The evaporation from this large basin exercises a certain influence on the climate of the surrounding country, while the absorption of heat for the thawing of the ice has a notable cooling effect in early summer.

Rivers.—Lake Baikal receives over 300 streams, mostly short mountain torrents, besides the Upper Angara, which enters its north-east extremity, the Barguzin, on the east, and the Selenga on the south-east. Its only outflow is the lower Angara, which issues through a rocky cleft on the west shore. The Irkut no longer reaches the Baikal, though it once did so. After approaching its south-west extremity it abandons the broad valley which leads to the lake, and makes its way northwards through a narrow gap in the mountains and joins the Angara at Irkutsk.

Mountains.—With the exception of the delta of the Selenga, Lake Baikal is surrounded by lofty mountains. The Khamar-daban border-ridge (the summit of a mountain of the same name is 5300 ft. above the lake), falling with steep cliffs towards the lake, fringes it on the south; a massive, deeply-ravined highland occupies the space between the Irkut and the Angara; the Onot and Baikal ridges (also Primorskiy) run along its north-west shore, striking it diagonally; an Alpine complex of yet unexplored mountains rises on its north-east shore; the Barguzin range impinges upon it obliquely in the east; and the Ülän-burgasu mountains intrude into the delta of the Selenga.

Geology.—It is certain that in previous geological ages Lake Baikal had a much greater extension. It stretched westwards into the valley of the Irkut, and up the lower valleys of the Upper Angara and the Barguzin. Volcanic activity took place around its shores at the end of the Tertiary or during the Quaternary Age, and great streams of lava cover the Sayan and Khamar-daban mountains, as well as the valley of Irkut. Earthquakes are still frequent along its shores.

Fauna.—The fauna, explored by Dybowski and Godlewski, and in 1900-2 by Korotnev, is much richer than it was supposed to be, and has quite an original character; but hypotheses as to a direct communication having existed between Lake Baikal and the Arctic Ocean during the Post-Tertiary or Tertiary ages are not proved. Still, Lake Baikal has a seal (*Phoca vitulina*, *Phoca baikalensis* of Dybowski) quite akin to the seals of Spitsbergen, marine sponges, polychaetes, a marine mollusc (*ancylodoris*), and some marine gammarids. The waters of the lake swarm with fish (including the *salmontidae*), and its herring (*Salmo omul*) is the chief product of the fisheries, though notably fewer have been taken within the last forty or fifty years. Plankton is very abundant. The little Lake Frolikha, situated close to the northern extremity of Lake Baikal and communicating with it by means of a river of the same name, contains a peculiar species of trout, *Salmo erythraeus*, which is not known elsewhere. Generally, while there is a relative poverty of zoological groups, there is a great wealth of species within the group. Of gammarids, there are as many as 300 species, and those living at great depths (330 to 380 fathoms) tend to assume abyssal characters similar to those displayed by the deep-sea fauna of the ocean.

Navigation.—Navigation of the lake is rendered difficult both by sudden storms and by the absence of good bays and ports.

¹ See L. Pinvert, *Lazare de Balf*, 1496 ?-1547 (1900).

The principal port on the western shore, Listvinichnoe, near the outflow of the Angara, is an open roadstead at the foot of steep mountains. Steamers ply from it weekly to Misovaya (Posolskoe) on the opposite shore, a few times a year to Verkhné-Angarsk, at the northern extremity of the lake, and frequently to the mouth of the Selenga. Steamers ascend this river as far as Bilyutai, near the Mongolian frontier, and bring back tea, imported via Kiakhtha, while grain, cedar nuts, salt, soda, wool and timber are shipped on rafts down the Khlokh, Chikoi and Uda (tributaries of the Selenga), and manufactured goods are taken up the river for export to China. Attempts are being made to render the Angara navigable below Irkutsk down to the Yenisei. In winter, when the lake is covered with ice 3 ft. to 4 ft. thick, it is crossed on sledges from Listvinichnoe to Misovaya. But a highway, available all the year round, was made in 1863-1864 around its southern shore, partly by blasting the cliffs, and it is now (since 1905) followed by the trans-Siberian railway. Further, a powerful ice-breaker is used to ferry trains across from Listvinichnoe to Misovaya.

AUTHORITIES.—Drizhenko, "Hydrographic Reconnoitring of Lake Baikal," in *Annuaire Russ. Geogr.* (1897, 2); Russian Addenda to Ritter's *Asie, East Siberia, Baikal, &c.* (1895); Chersky's Geological Map of Shores of Lake Baikal, 6½ m. to the inch, in *Zapiski of Russ. Geogr. Soc.* xv. (1886); "Report of Geological Exploration of Shores of Lake Baikal," in *Zapiski of East Siberian Branch of Russ. Geogr. Soc.* xii. (1886); Obruchev, "Geology of Baikal Mountains," *Ivestia of same Society* (1890, xxi. 4 and 5); Dybowski and Godlewski on "Fauna," in same periodical (1876); Witkowski, on "Seals"; Yakovlev's "Fishes of Angara," in same periodical (1890-1893); "Fishing in Lake Baikal and its Tributaries," in same periodical (1886-1890); and *La Géographie* (No. 3, 1904).

(P. A. K.; J. T. Be.)

BAIKIE, WILLIAM BALFOUR (1824-1864), Scottish explorer, naturalist and philologist, eldest son of Captain John Baikie, R.N., was born at Kirkwall, Orkney, on the 21st of August 1824. He studied medicine at Edinburgh, and, on obtaining his M.D. degree, joined the royal navy in 1848. He early attracted the notice of Sir Roderick Murchison, through whom he was appointed surgeon and naturalist to the Niger expedition sent out in 1854 by Macgregor Laird with government support. The death of the senior officer (Consul Brecroft) occurring at Fernando Po, Baikie succeeded to the command. Ascending the Benue about 250 m. beyond the point reached by former explorers, the little steamer "Pleid" returned and reached the mouth of the Niger, after a voyage of 118 days, without the loss of a single man. The expedition had been instructed to endeavour to afford assistance to Heinrich Barth (*q.v.*), who had in 1851 crossed the Benue in its upper course, but Baikie was unable to gain any trustworthy information concerning him. Returning to England, Baikie gave an account of his work in his *Narrative of an Exploring Voyage up the Rivers Kwora and Binue*. . . (London, 1856). In March 1857 Baikie—with the rank of British consul—started on another expedition in the "Pleid." After two years spent in exploring the Niger, the navigating vessel was wrecked in passing through some of the rapids of the river, and Baikie was unable longer to keep his party together. All returned home but himself; in no way daunted, he determined single-handed to carry out the purposes of the expedition. Landing from a small boat, with one or two native followers, at the confluence of the Niger and Benue, he chose Lokoja as the base of his future operations, it being the site of the model farm established by the expedition sent by the British government in 1841, and abandoned within a twelvemonth on the death of most of the white settlers (see Capt. W. Allen, R.N., and T. R. H. Thomson, M.D., *A Narrative of the Expedition . . . to the River Niger in 1841*, London, 1848). After purchasing the site, and concluding a treaty with the Fula emir of Nupe, he proceeded to clear the ground, build houses, form enclosures and pave the way for a future city. Numbers flocked to him from all neighbouring districts, and in his settlement were representatives of almost all the tribes of West-Central Africa. To the motley commonwealth thus formed he acted not merely as ruler, but also as physician, teacher and priest. In less than five years he had opened up the navigation of the Niger, made

roads, and established a market to which the native produce was brought for sale and barter. He had also collected vocabularies of nearly fifty African dialects, and translated portions of the Bible and prayer-book into Hausa. Once only during his residence had he to employ armed force against the surrounding tribes. While on his way home, on leave of absence, he died at Sierra Leone on the 30th of November 1864. He had done much to establish British influence on the Niger, but after his death the British government abolished the consulate (1866), and it was through private enterprise that some twenty years later the district where Baikie had worked so successfully was finally secured for Great Britain (see NIGERIA).

Baikie's *Observations on the Hausa and Fulfulde* (*i.e.* Fula) *Languages* was privately printed in 1861, and his translation of the Psalms into Hausa was published by the Bible Society in 1881. He was also the author of various works concerning Orkney and Shetland. A monument to his memory was placed in the nave of the ancient cathedral of St Magnus, Kirkwall.

BAIL,¹ in English common law, the freeing or setting at liberty of one arrested or imprisoned upon any action, either civil or criminal, on surety taken for his appearance on a certain day and at a place named. The surety is termed bail, because the person arrested or imprisoned is placed in the custody of those who bind themselves or become bail for his due appearance when required. So he may be released by them if they suspect that he is about to escape and surrendered to the court, when they are discharged from further liability. The sureties must be sufficient in the opinion of the court, and, as a rule, only householders are accepted; in criminal cases the solicitor or an accomplice of the person to be bailed, a married woman or an infant would not be accepted. Bail is obligatory in all summary cases. It is also obligatory in all misdemeanours, except such as have been placed on the level of felonies, *viz.* obtaining or attempting to obtain property on false pretences, receiving property so obtained or stolen, perjury or subornation of perjury, concealment of birth, wilful or indecent exposure of the person, riot, assault in pursuance of a conspiracy to raise wages, assault upon a peace-officer in the execution of his duty or upon any one assisting him, neglect or breach of duty as a peace-officer, any prosecution of which the costs are payable out of the county or borough rate or fund. In cases of treason, bail can only be granted by a secretary of state or the king's bench division. A person charged with felony is not entitled as of right to be released on bail. The power of admitting a prisoner to bail is discretionary and not ministerial, and the chief consideration in the exercise of that discretion must be the likelihood of the prisoner failing to appear at the trial. This must be gauged from the nature of the evidence in support of the accusation, the position of the accused and the severity of the punishment which his conviction will entail, as well as the independence of the sureties. The Bail Act 1898 gives a magistrate power, where a person is charged with felony or certain misdemeanours, or where he is committed for trial for any indictable offence, to dispense with sureties, if in his opinion the so dispensing will not tend to defeat the ends of justice. A surety may be examined on oath as to his means, while the court may also require notice to be given to the plaintiff, prosecutor or police. A person who has been taken into custody for an offence without a warrant, and cannot be brought before a court of summary jurisdiction within twenty-four hours, may be admitted to bail by a superintendent or inspector of police; and in a borough, if a person is arrested for a petty misdemeanour, he may be bailed by the constable in charge of the police-station. Bail in civil matters, since the abolition of arrest on mesne process, is virtually extinct. It took the form of an instrument termed a

¹ The ultimate origin of this and cognate words is the Lat. *bajulus*, properly a bearer of burdens or porter, later a tutor or guardian, and hence a governor or custodian, from which comes "baillif"; from *bajulare* is derived the French *bailler*, to take charge of, or to place in charge of, and "bail" thus means "custody," and is applied to the person who gives security for the appearance of the prisoner, the security given, or the release of the prisoner on such security.

hail-bond, which was prepared in the sheriff's office after arrest, and executed by two sufficient sureties and the person arrested.

In admiralty proceedings *in rem*, bail is often required for procuring the release of arrested ships or cargo. It is also given without the arrest of the ship, as a substitution of personal security for that of the *res*, generally in an amount to cover the claim and costs.

In the United States, bail (in a sum fixed by the committing magistrate) is a matter of right in all cases where a sentence of death cannot be inflicted (Rev. Stat. § 1015). In those where such a sentence can be inflicted, it may be allowed by one of the judges of the United States courts at his discretion (*ibid.* § 1016).

BAILÉN, or **BAYLÉN**, a town of southern Spain, in the province of Jaén; 21 m. by road N. of the city of Jaén. Pop. (1900) 7420. Bailén is probably the ancient Baecula, where the Romans, under P. Cornelius Scipio the elder, signally defeated the Carthaginians in 209 and 206 B.C. In its neighbourhood, also, in 1212, was fought the great battle of Las Navas de Tolosa, in which, according to the ancient chroniclers, the Castilians under Alphonso VIII, slew 200,000 Moors, and themselves only lost 25 men. Although this estimate is absurd, the victory of the Christians was complete. The capitulation of Bailén, signed at Andújar by the French general Dupont, on the 23rd of July 1808 after several days' hard fighting, involved the surrender of 17,000 men to the Spaniards, and was the first severe blow suffered by the French in the Peninsular War.

BAILEY, GAMALIEL (1807-1859), American journalist, was born at Mount Holly, New Jersey, on the 3rd of December 1807. He graduated at the Jefferson Medical College in Philadelphia in 1827. After editing for a short time a religious journal, the *Methodist Protestant*, at Baltimore, he removed in 1831 to Cincinnati, Ohio, where at first he devoted himself almost exclusively to the practice of medicine. He was also lecturer on physiology at the Lane Theological Seminary, and at the time of the Lane Seminary debates (February 1834) between the pro-slavery and the anti-slavery students, and the subsequent withdrawal of the latter, he became an ardent abolitionist. In 1836 he joined James G. Birney in the editorial control of the *Philanthropist*; in the following year he succeeded Birney as editor, and conducted the paper in spite of threats and acts of violence—the printing-office being thrice wrecked by a mob—until 1847. From 1843 also he edited a daily paper, the *Herald*. In 1847 he assumed control of the new abolitionist organ, the *National Era*, at Washington, D.C. Here also his paper was the object of attack by pro-slavery mobs, at one time in 1848 the editor and printers being besieged in their office for three days. This paper had a considerable circulation, and in it, in 1851-1852, Mrs. H. B. Stowe's *Uncle Tom's Cabin* was first published. Bailey died at sea in the course of a trip to Europe on the 5th of June 1859.

BAILEY, NATHAN or **NATHANIEL** (d. 1742), English philologist and lexicographer. He compiled a *Dictionary Britannicum: a more complete universal etymological English dictionary than any extant*, bearing the date 1730, but supposed to have been published in 1721. This was a great improvement on all previous attempts, and formed the basis of Dr Johnson's great work. Bailey, who was a Seventh-day Baptist (admitted 1691), had a school at Stepney, near London, and was the author of *Dictionary Domesticum* and several other educational works. He died on the 27th of June 1742.

BAILEY, PHILIP JAMES (1816-1902), English poet, author of *Festus*, was born at Nottingham on the 22nd of April 1816. His father, who himself published both prose and verse, owned and edited from 1845 to 1852 the *Nottingham Mercury*, one of the chief journals in his native town. Philip James Bailey received a local education until his sixteenth year, when he matriculated at Glasgow University. He did not, however, take his degree, but moved in 1835 to London and entered Lincoln's Inn. Without making serious practice of the law he settled at Basford, and for three years was occupied with the composition of *Festus*, which appeared anonymously in 1830.

Its success, both in England and America, was immediate. It passed through a dozen editions in the country of its birth, and nearly three times as many in the United States; and when in 1880 its author was able to publish a "Jubilee Edition," he could feel that it was one of the few poems of its time which was known to both the older and the younger generations. Its author is known almost exclusively by his one voluminous poem, for though Bailey published other verses he is essentially a man of one book. *Festus* has undergone many changes and incorporations, but it remains a singular example of a piece of work virtually completed in youth, and never supplanted or reinforced by later achievements of its author. It is a vast pageant of theology and philosophy, comprising in some twelve divisions an attempt to represent the relation of God to man and of man to God, to emphasize the benignity of Providence, to preach the immortality of the soul, and to postulate "a gospel of faith and reason combined." It contains fine lines and dignified thought, but its ambitious theme, and a certain incoherency in the manner in which it is worked out, prevent it from being easily readable by any but the most sympathetic student. Bailey died on the 6th of September 1902.

BAILEY, SAMUEL (1791-1870), British philosopher and author, was born at Sheffield in 1791. He was among the first of those Sheffield merchants who went to the United States to establish trade connexions. After a few years in his father's business, he retired with an ample fortune from all business concerns, with the exception of the Sheffield Banking Company, of which he was chairman for many years. Although an ardent liberal, he took little part in political affairs. On two occasions he stood for Sheffield as a "philosophic radical," but without success. His life is for the most part a history of his numerous and varied publications. His books, if not of first-rate importance, are marked by lucidity, elegance of style and originality of treatment. He died suddenly on the 18th of January 1870, leaving over £80,000 to the town of Sheffield. His first work, *Essays on the Formation and Publication of Opinions*, published anonymously in 1821 (2nd ed., 1826; 3rd ed., 1837), attracted more attention than any of his other writings. A sequel to it appeared in 1829, *Essays on the Pursuit of Truth* (2nd ed., 1844). Between these two were *Questions in Political Economy, Politics, Morals, &c.* (1823), and a *Critical Dissertation on the Nature, Measure, and Causes of Value* (1825), directed against the opinions of Ricardo and his school. His next publications also were on economic or political subjects, *Rationale of Political Representation* (1835), and *Money and its Vicissitudes* (1837), now practically forgotten; about the same time also appeared some of his pamphlets, *Discussion of Parliamentary Reform, Right of Primogeniture Examined, Defence of Joint-Stock Banks*. In 1842 appeared his *Review of Berkeley's Theory of Vision*, an able work, which called forth rejoinders from J. S. Mill in the *Westminster Review* (reprinted in *Dissertations*), and from Ferrier in *Blackwood* (reprinted in *Lectures and Remains*, ii). Bailey replied to his critics in a *Letter to a Philosopher* (1843), &c. In 1851 he published *Theory of Reasoning* (2nd ed., 1852), a discussion of the nature of inference, and an able criticism of the functions and value of the syllogism. In 1852 he published *Discourses on Various Subjects*; and finally summed up his philosophic views in the *Letters on the Philosophy of the Human Mind* (three series, 1855, 1858, 1863). In 1845 he published *Maro*, a poem in four cantoes (85 pp., Longmans), containing a description of a young poet who printed 1000 copies of his first poem, of which only 10 were sold. He was a diligent student of Shakespeare, and his last literary work was *On the Received Text of Shakespeare's Dramatic Writings and its Improvement* (1862). Many of the emendations suggested are more fantastic than felicitous.

The *Letters* contain a discussion of many of the principal problems in psychology and ethics. Bailey can hardly be classed as belonging either to the strictly empirical or to the idealist school, but his general tendency is towards the former. (1) In regard to method, he founds psychology entirely on introspection. He thus, to a certain extent, agrees with the Scottish school, but he differs from them in rejecting altogether the doctrine of mental faculties. What have been designated faculties are, upon his view, merely classified

facts or phenomena of consciousness. He criticizes very severely the habitual use of metaphorical language in describing mental operations. (2) His doctrine of perception, which is, in brief, that "the perception of external things through the organs of sense is a direct mental act or phenomenon of consciousness not susceptible of being resolved into anything else," and the reality of which can be neither proved nor disproved, is not worked out in detail, but is supported by elaborate and sometimes subtle criticisms of all other theories. (3) With regard to general and abstract ideas and general propositions, his opinions are those of the empirical school, but his analysis frequently puts the matter in a new light. (4) In the theory of morals, Bailey is an advocate of utilitarianism (though he objects to the term "utility" as being narrow and, to the unthinking, of sordid content), and works out with great skill the steps in the formation of the "complex" mental facts involved in the recognition of duty, obligation, right. He bases all moral phenomena on five facts:—(1) Man is susceptible to pleasure (and pain); (2) he likes (or dislikes) their causes; (3) he desires to reciprocate pleasure and pain received; (4) he expects such reciprocation from others; (5) he feels more or less sympathy with the same feelings in his fellows (*Letters*, 3rd series).

See A. Bain's *Moral Science*; Th. Ribot, *La Psychologie anglaise contemporaine*; J. F. Ferrier, *Philos. Remains* (Edinb. and Lond., 1875), pp. 351-381.

BAILEY (said to be a corruption of *Ballium* by some, and derived by others from the Fr. *baillie*, a corruption of *batallier*, because there the soldiers were drilled in battle array), the open space between the inner and outer lines of a fortification. Sometimes there were more than one, as the Inner and Outer Bailey; there are in England the Old Bailey at London and at York, and the Upper and Nether Baileys at Colchester.

BAILIFF and **BAILIE** (from Late Lat. *baulivus*, adjectival form of *baulus*, a governor or custodian; cf. BAIL), a legal officer to whom some degree of authority, care or jurisdiction is committed. Bailiffs are of various kinds and their offices and duties vary greatly.

The term was first applied in England to the king's officers generally, such as sheriffs, mayors, &c., and more particularly to the chief officer of a hundred. The county within which the sheriff exercises his jurisdiction is still called his bailiwick, while the term bailiff is retained as a title by the chief magistrates of various towns and the keepers of royal castles, as the high bailiff of Westminster, the bailiff of Dover Castle, &c. Under the manorial system, the bailiff, the steward and the reeve were important officers; the bailiff managed the property of the manor and superintended its cultivation (see Walter of Henley, *Husbandry*, R. Hist. Soc., 1800).

The bailiff of a franchise or liberty is the officer who executes writs and processes, and impanels juries within the franchise. He is appointed by the lord of such franchise (who, in the Sheriffs Act 1887, § 24, is referred to as the bailiff of the franchise).

The bailiff of a sheriff is an under-officer employed by a sheriff within a county for the purpose of executing writs, processes, distrains and arrests. As a sheriff is liable for the acts of his officers acting under his warrant, his bailiffs are annually bound to him in an obligation with sureties for the faithful discharge of their office, and thence are called *bound* bailiffs. They are also often called *bum-bailiffs*, or, shortly, *bums*. The origin of this word is uncertain; the *New English Dictionary* suggests that it is an allusion to the mode of catching the offender. Special bailiffs are officers appointed by the sheriff at the request of a plaintiff for the purpose of executing a particular process. The appointment of a special bailiff relieves the sheriff from all responsibility until the party is arrested and delivered into the sheriff's actual custody.

By the County Courts Act 1888, it is provided that there shall be one or more high-bailiffs, appointed by the judge and removable by the lord-chancellor; and every person discharging the duties of high-bailiff is empowered to appoint a sufficient number of able and fit persons as bailiffs to assist him, whom he can dismiss at his pleasure. The duty of the high-bailiff is to serve all summonses and orders, and execute all the warrants, precepts and writs issued out of the court. The high bailiff is responsible for all the acts and defaults of himself, and of the bailiffs appointed to assist him, in the same way as a sheriff of a county is responsible for the acts and defaults of himself and his officers. By the same

act (§40) bailiffs are answerable for any connivance, omission or neglect to levy any such execution. No action can be brought against a bailiff acting under order of the court without six days' notice (§54). Any warrant to a bailiff to give possession of a tenement justifies him in entering upon the premises named in the warrant, and giving possession, provided the entry be made between the hours of 9 A.M. and 4 P.M. (§ 142). The Law of Distress Amendment Act 1888 enacts that no person may act as a bailiff to levy any distress for rent, unless he is authorized by a county-court judge to act as a bailiff.

In the Channel Islands the bailiff is the first civil officer in each island. He is appointed by the crown, and generally holds office for life. He presides at the royal court, and takes the opinions of the jurors; he also presides over the states, and represents the crown in all civil matters. Though he need not necessarily have had legal training, he is usually selected from among those who have held some appointment at the island bar.

In the United States the word bailiff has no special significance. It is sometimes applied to the officer who takes charge of juries and waits upon the court. The officer who corresponds to the English sheriff's bailiff is termed a deputy or under-sheriff.

Bailie.—In Scotland the word bailiff has taken the form of "baillie," signifying a superior officer or magistrate of a municipal corporation. Bailies, by virtue of their office, are invested with certain judicial and administrative powers within the burgh for which they are appointed. They sit as police-court magistrates, being assisted usually by a paid legal adviser, called an "assessor," and, in the larger burghs, act as a licensing court. It is usually said that a baillie is analogous to the English alderman, but this is only in so far as he is a person of superior dignity in the council, for, unlike an alderman, he continues to sit for the ward for which he has been elected after selection as a baillie. He is always appointed from within the council, and his term of office is only that of an ordinary councillor, that is, for not more than three years. *Baillie to give sasine* was the person who appeared for the superior at the ceremony of giving sasine. This ceremony was abolished in 1845. The *Baillie of Holyrood*, or *Baillie of the Abbey*, was the official who had jurisdiction in all civil debts contracted within the precincts of the sanctuary (*q.v.*) (T. A. I.)

Bailli.—In France the bailiff (*bailli*), or seneschal in feudal days, was the principal officer of any noble importance. He it was who held the feudal court of assizes when the lord was not present himself. A great noble often also had a *prévôté*, where small matters were settled, and the preparatory steps taken relative to the more important cases reserved for the assizes. Among the great officers of the crown of France a grand-seneschal formerly figured until the reign of Philip Augustus, when the last holder of the office was not replaced by a successor. It is also under Philip Augustus that local bailiffs first make a definite appearance. In the ordinance of 1190, by which the king, about to set forth on the crusade, arranged for the administration of the kingdom during his absence, they figure as part of a general system. Probably the first royal bailiffs or seneschals were the seigniorial bailiffs of certain great fiefs that had been reunited to the crown, their functions still continuing after the annexation. Their essential function was at first the surveillance of the royal provosts (*prévôts*), who until then had had the sole administration of the various parts of the domain. They concentrated in their own hands the produce of the provostships, and they organized and led the men who by feudal rules owed military service to the king. They had also judicial functions, which, at first narrowly restricted in application, became much enlarged as time went on, and they held periodical assizes in the principal centres of their districts. When the right of appeal was instituted, it was they who heard the appeals from sentences pronounced by inferior royal judges and by the seigniorial justices. Royal cases, and cases in which a noble was defendant, were also reserved for them. The royal *bailli* or seneschal (no real difference existed between the two offices, the names merely changing according to the district), was for long the king's principal representative in the provinces,

and the *bailliage* or the *sénéchaussée* was then as important administratively as judicially. But the political power of the bailiffs was greatly lessened when the provincial governors were created. They had already lost their financial powers, and their judicial functions now passed from them to their *lieutenants*.

By his origin the bailiff had a military character; he was an officer of the "short robe" and not of the "long robe," which in those days was no obstacle to his being well versed in precedents. But when, under the influence of Roman and canon law, the legal procedure of the civil courts became *learned*, the bailiff often availed himself of a right granted him by ancient public law: that of delegating the exercise of his functions to whomsoever he thought fit. He delegated his judicial functions to lieutenants, whom he selected and discharged at will. But as this delegation became habitual, the position of the lieutenants was strengthened; in the 16th century they became royal officers by title, and even dispossessed the bailiffs of their judiciary prerogatives. The tribunal of the *bailliage* or *sénéchaussée* underwent yet another transformation, becoming a stationary court of justice, the seat of which was fixed at the chief town. During the 15th and 16th centuries ambulatory assizes diminished in both frequency and importance. In the 17th and 18th centuries they were no more than a survival, the *lieutenant* of such a *bailliage* having preserved the right to hold one assize each year at a certain locality in his district. The ancient bailiff or *bailli d'épée* still existed, however; the judgments in the tribunal of the *bailliage* were delivered in his name, and he was responsible for their execution. So long as the military service of the *ban* and *arrière ban*, due to the king from all fief-holders, was maintained (and it was still in force at the end of the 17th century), it was the bailiffs who organized it. Finally the *bailliage* became in principle the electoral district for the states-general, the unit represented therein by its three estates. The judiciary nobles retained their judges, often called bailiffs, until the Revolution. These judges, who were competent to decide questions as to the payment of seigniorial dues, could not, legally at all events, themselves farm those revenues.

See Dupont Ferrier, *Les Officiers royaux des bailliages et sénéchaussées et les institutions monarchiques locales en France à la fin du moyen âge* (1902); Armand Bréte, *Recueil de documents relatifs à la convocation des états-généraux de 1789* (3 vols. 1904) (vol. iii. gives the condition of the *bailliages* and *sénéchaussées* in 1789). (J. P. E.)

BAILLET, ADRIEN (1640-1706), French scholar and critic, was born on the 13th of June 1640, at the village of Neuville near Beauvais, in Picardy. His parents could only afford to send him to a small school in the village, but he picked up some Latin from the friars of a neighbouring convent, who brought him under the notice of the bishop of Beauvais. By his kindness Baillet received a thorough education at the theological seminary, and was afterwards appointed to a post as teacher in the college of Beauvais. In 1676 he was ordained priest and was presented to a small vicarage. He accepted in 1680 the appointment of librarian to M. de Lamoignon, advocate-general to the *parlement* of Paris, of whose library he made a *catalogue raisonné* (35 vols.), all written with his own hand. The remainder of his life was spent in incessant, unremitting labour; so keen was his devotion to study that he allowed himself only five hours a day for rest. He died on the 21st of January 1706. Of his numerous works the following are the most conspicuous: (1) *Histoire de Hollande depuis la trêve de 1609 jusqu'à 1690* (4 vols. 1693), a continuation of Grotius, and published under the name of La Neuville, (2) *Les Vies des saints* . . . (4 vols. 1701), (3) *Des Satires personnelles, traité historique et critique de celles qui portent le titre d'Anti* (2 vols. 1689), (4) *Vie de Descartes* (2 vols. 1661), (5) *Auteurs déguisés sous des noms étrangers, empruntés, &c.* (1690), (6) *Jugemens des savans sur les principaux ouvrages des auteurs* (9 vols. 1685-1686). The last is the most celebrated and useful of all his works. At the time of his death he was engaged on a *Dictionnaire universelle ecclésiastique*. The praise bestowed on the Jansenists in the *Jugemens des savans* brought down on Baillet the hatred of the Jesuits, and his *Vie des saints*, in which he brought his critical mind to bear on the question of miracles, caused some scandal. His *Vie de Descartes* is

a mine of information on the philosopher and his work, derived from numerous unimpeachable authorities.

(See the edition by M. de la Monnoye of the *Jugemens des Savans* (Amsterdam, 4 vols. 1725), which contains the *Anti-Baillet* of Gilles Ménage and an *Abregé de la vie de Mr Baillet*.)

BAILLIE, LADY GRIZEL (1665-1746), Scottish song-writer, eldest daughter of Sir Patrick Hume or Home of Polwarth, afterwards earl of Marchmont, was born at Redbraes Castle, Berwickshire, on the 25th of December 1665. When she was twelve years old she carried letters from her father to the Scottish patriot, Robert Baillie of Jerviswood, who was then in prison. Home's friendship for Baillie made him a suspected man, and the king's troops occupied Redbraes Castle. He remained in hiding for some time in a churchyard, where his daughter kept him supplied with food, but on hearing of the execution of Baillie (1684) he fled to Holland, where his family soon after joined him. They returned to Scotland at the Revolution. Lady Grizel married in 1692 George Baillie, son of the patriot. She died on the 6th of December 1746. She had two daughters, Grizel, who married Sir Alexander Murray of Stanhope, and Rachel, Lady Binning. Lady Murray had in her possession a MS. of her mother's in prose and verse. Some of the songs had been printed in Allan Ramsay's *Tea-Table Miscellany*. "And werena my heart light I wad dee," the most famous of Lady Grizel's songs, originally appeared in *Orpheus Caledonius* (1725).

Memoirs of the Lives and Characters of the Right Hon. George Baillie of Jerviswood and Lady Grizel Baillie, by their daughter, Lady Murray of Stanhope, were printed in 1822. George Baillie's *Correspondence* (1702-1708) was edited by Lord Minto for the Bannatyne Club in 1842. "The Legend of Lady Grizelda Baillie" forms one of Joanna Baillie's *Metrical Legends of Exalted Character*.

BAILLIE, JOANNA (1762-1851), British poet and dramatist, was born at the manse of Bothwell, on the banks of the Clyde, on the 11th of September 1762. She belonged to an old Scottish family, which claimed among its ancestors Sir William Wallace. At an early period she moved with her sister Agnes to London, where their brother, Dr Matthew Baillie, was settled. The two sisters inherited a small competence from their uncle, Dr William Hunter, and took up their residence at Hampstead, then on the outskirts of London, where they passed the remainder of their lives. Joanna Baillie had received an excellent education, and began very early to write poetry. She published anonymously in 1790 a volume called *Fugitive Verses*; but it was not till 1798 that she produced the first volume of her "plays on the passions" under the title of *A Series of Plays*. Her design was to illustrate each of the deepest and strongest passions of the human mind, such as hate, jealousy, fear, love, by a tragedy and a comedy, in each of which should be exhibited the actions of an individual under the influence of these passions. The first volume was published anonymously, but the authorship, though at first attributed to Sir Walter Scott, was soon discovered. The book had considerable success and was followed by a second volume in 1802, a third in 1812 and three volumes of *Dramas* in 1836. *Miscellaneous Plays* appeared in 1804, and the *Family Legend* in 1810. Miss Baillie herself intended her plays not for the closet but for the stage. The *Family Legend*, brought out in 1810 at Edinburgh, under the enthusiastic patronage of Sir Walter Scott, had a brief though brilliant success; *De Monfort* had a short run in London, mainly through the acting of John Kemble and Mrs Siddons; *Henriques* and *The Separation* were coldly received. With very few exceptions, Joanna Baillie's plays are unsuited for stage exhibition. Not only is there a flaw in the fundamental idea, viz. that of an individual who is the embodiment of a single passion, but the want of incident and the direction of the attention to a single point, present insuperable obstacles to their success as acting pieces. At the same time they show remarkable powers of analysis and acute observation and are written in a pure and vigorous style. Joanna Baillie's reputation does not rest entirely on her dramas; she was the author of some poems and songs of great beauty. The best of them are the *Lines to Agnes Baillie on her Birthday*, *The Kitten*, *To a Child* and some of her adaptations of Scottish songs, such as *Woo'd a and Married a' u'*. Scattered throughout the dramas are also some lively and

beautiful songs, *The Chough and the Crow in Orra*, and the lover's song in the *Phantom*. Miss Baillie died on the 23rd of February 1851, at the advanced age of 89, her faculties remaining unimpaired to the last. Her gentleness and sweetness of disposition made her a universal favourite, and her little cottage at Hampstead was the centre of a brilliant literary society.

See Joanna Baillie's *Dramatic and Poetical Works* (London, 1851).

BAILLIE, ROBERT (1602-1662), Scottish divine, was born at Glasgow. Having graduated there in 1620, he gave himself to the study of divinity. In 1631, after he had been ordained and had acted for some years as regent in the university, he was appointed to the living of Kilwinning in Ayrshire. In 1638 he was a member of the famous Glasgow Assembly, and soon after he accompanied Leslie and the Scottish army as chaplain or preacher. In 1642 he was made professor of divinity at Glasgow, and in the following year was selected as one of the five Scottish clergymen who were sent to the Westminster Assembly. In 1649 he was one of the commissioners sent to Holland for the purpose of inviting Charles II. to Scotland, and of settling the terms of his admission to the government. He continued to take an active part in all the minor disputes of the church, and in 1661 was made principal of Glasgow University. He died in August of the following year, his death being probably hastened by his mortification at the apparently firm establishment of episcopacy in Scotland. Baillie was a man of learning and ability; his views were not extreme, and he played but a secondary part in the stirring events of the time. His *Letters*, by which he is now chiefly remembered, are of first-rate historical importance, and give a very lively picture of the period.

A complete memoir and a full notice of all his writings will be found in D. Laing's edition of the *Letters and Journals of Robert Baillie* (1637-1662), Bannatyne Club, 3 vols. (Edinburgh, 1841-1842). Among his works are *Ladensium avaritiositas*, an answer to *Lysimachus Nicomor*, an attack on Laud and his system, in reply to a publication which charged the Covenanters with Jesuitry; *Anticipation, the true Fountain of Independency, Brownisme, Autonomy, Familisme, &c.*, a sermon; *An Historical Vindication of the Government of the Church of Scotland; The Life of William (Laud) now Lord Archbishop of Canterbury Examined* (London, 1643); *A Parallel of the Liturgy with the Mass Book, the Breviary, the Ceremonial and other Romish Rituals* (London, 1661).

BAILLIE, ROBERT (d. 1684), Scottish conspirator, known as BAILLIE OF JERVISWOOD, was the son of George Baillie of St. John's Kirk, Lanarkshire. He incurred the resentment of the Scottish government by rescuing, in June 1676, his brother-in-law Kirkton, a Presbyterian minister who had illegally been seized and confined in a house by Carstairs, an informer. He was fined £500, remaining in prison for four months and then being liberated on paying one-half the fine to Carstairs. In despair at the state of his country he determined in 1683 to emigrate to South Carolina, but the plan came to nothing. The same year Baillie, with some of his friends, went to London and entered into communication with Monmouth, Russell and their party in order to obtain redress; and on the discovery of the Rye House Plot he was arrested. Questioned by the king himself he repudiated any knowledge of the conspiracy, but with striking truthfulness would not deny that he had been consulted with the view of an insurrection in Scotland. He was subsequently loaded with irons and sent back a prisoner to Scotland. Though there was no evidence whatever to support his connexion with the plot, he was fined £6000 and kept in close confinement. He was already in a languishing state when on the 23rd of December 1684 he was brought up again before the high court on the charge of treason. He was pronounced guilty on the following day and hanged the same afternoon at the market cross at Edinburgh with all the usual barbarities. His shocking treatment was long remembered as one of the worst crimes committed by the Stuart administration in Scotland. Bishop Burnet, who was his cousin, describes him as "in the presbyterian principles but . . . a man of great piety and virtue, learned in the law, in mathematics and in languages." He married a sister of Sir Archibald Johnston, Lord Warriston, and left a son, George, who took refuge in Holland, afterwards returning with William III. and being restored to his estates.

BAILLY, JEAN SYLVAIN (1736-1793), French astronomer and orator, was born at Paris on the 15th of September 1736. Originally intended for the profession of a painter, he preferred writing tragedies until attracted to science by the influence of Nicolas de Lacaille. He calculated an orbit for the comet of 1759 (Halley's), reduced Lacaille's observations of 515 zodiacal stars, and was, in 1763, elected a member of the Academy of Sciences. His *Essai sur la théorie des satellites de Jupiter* (1766), an expansion of a memoir presented to the Academy in 1763, showed much original power; and it was followed up in 1771 by a noteworthy dissertation *Sur les inégalités de la lumière des satellites de Jupiter*. Meantime he had gained a high literary reputation by his *Eloges* of Charles V., Lacaille, Molière, Corneille and Leibnitz, which were issued in a collected form in 1770 and 1790; he was admitted to the French Academy (February 26, 1784), and to the Académie des Inscriptions in 1785, when Fontenelle's simultaneous membership of all three Academies was renewed in him. Thenceforth, he devoted himself to the history of science, publishing successively:—*Histoire de l'astronomie ancienne* (1775); *Histoire de l'astronomie moderne* (3 vols. 1779-1782); *Lettres sur l'origine des sciences* (1777); *Lettres sur l'Atlantide de Platon* (1779); and *Traité de l'astronomie indienne et orientale* (1787). Their erudition was, however, marred by speculative extravagances.

The cataclysm of the French Revolution interrupted his studies. Elected deputy from Paris to the states-general, he was chosen president of the Third Estate (May 5, 1789), led the famous proceedings in the Tennis Court (June 20), and acted as mayor of Paris (July 15, 1789, to November 16, 1791). The dispersal by the National Guard, under his orders, of the riotous assembly in the Champ de Mars (July 17, 1791) rendered him obnoxious to the infuriated populace, and he retired to Nantes, where he composed his *Mémoires d'un témoin* (published in 3 vols. by MM. Berville and Barrière, 1821-1822), an incomplete narrative of the extraordinary events of his public life. Late in 1793, Bailly quitted Nantes to join his friend Pierre Simon Laplace at Melun; but was there recognized, arrested and brought (November 10) before the Revolutionary Tribunal at Paris. On the 12th of November he was guillotined amid the insults of a howling mob. He met his death with patient dignity, having, indeed, disastrously shared the enthusiasms of his age, but taken no share in its crimes.

Notes of his life are contained in the *Éloges* by Mérard de Saint Just, Delisle de Sallés, Lalande and Lacretelle; in a memoir by Arago, read the 26th of February 1844 before the Académie des Sciences, and published in *Notices biographiques*, t. ii. (1852). See also Delambre, *Histoire de l'astronomie au 18ème siècle*, p. 735, and Lalande, *Bibliographie astronomique*, p. 730.

BAILMENT (from Fr. *bailler*, to place in charge, of. *BAIL*), in law, a delivery of goods from one person called the *bailor*, to another person called the *bailee*, for some purpose, upon a contract, express or implied, that after the purpose has been fulfilled they shall be redelivered to the bailor, or otherwise dealt with according to his direction, or kept till he reclaims them. The following is Chief Justice Holt's classification of bailments in *Coggs v. Bernard*, 1704, 1 Sm. L.C. 167, which is generally adopted. (1) *Depositum*, or bailment without reward, in order that the bailee may keep the goods for the bailor. In this case, the bailee has no right to use the thing entrusted to him, and is liable for gross negligence, but not for ordinary negligence. Thus, where a customer had deposited some securities with his banker (who received nothing for his services) and they were stolen by a cashier, it was held that as there was no proof of gross negligence the banker was not liable (*Giblin v. McMullen*, 1868, L.R. 2 P.C. 317). (2) *Commodatum*, or loan, where goods or chattels that are useful are lent to the bailee *gratis*, to be used by him. The bailee may be justly considered as representing himself to the bailor to be a person of competent skill to take care of the thing lent (*Wilson v. Brett*, 1843, 11 M. & W. 113), and the transaction being a gratuitous loan, and one for the advantage of the bailee solely, he is bound to use great diligence in the protection of the thing bailed and will be responsible even for slight negligence. Thus, where a

horse was lent to the defendant to ride, it was held that it did not warrant him in allowing his servant to do so (*Bringloe v. Morrice*, 1676, 1 Mod. 210). But where a horse was for sale and the vendor allowed the defendant to have the horse for the purpose of trying it, it was held that he had a right to allow a competent person upon the horse to try it (*Camoy v. Scurr*, 1849, 9 C. & P. 383). (3) *Locatio rei*, or lending for hire. In the case of hiring the bailee is bound to use such diligence as a prudent man would exercise towards his own property. Thus, where the defendant hired a horse, and it having fallen ill, prescribed for it himself instead of calling in a veterinary surgeon, he was held liable for the loss (*Doan v. Keate*, 1811, 3 Camp. 4). (4) *Vadium*, pawn or pledge; a bailment of personal property as a security for a debt. In this case the pledgee is bound to use ordinary diligence in guarding the thing pledged. (5) *Locatio operis faciendi*, where goods are delivered to be carried, or something is to be done about them for a reward to be paid to the bailee. In this case, the bailee is bound to use ordinary diligence in preserving the property entrusted to him. (6) *Mandatum*, a delivery of goods to somebody, who is to carry them, or do something about them gratis. The liabilities of a mandatory and of a depository are exactly the same; neither is liable for anything short of gross negligence.

See further under BANKS and BANKING; CARRIER; DILIGENCE; FACTOR; HIRING; INNS and INNKEEPERS; LIEN; NEGLIGENCE; PLEDGE; PAWNBROKING; PRINCIPAL and AGENT, &c.

BAILY, EDWARD HODGES (1788–1867), British sculptor, was born at Bristol on the 10th of March 1788. His father, who was a celebrated carver of figureheads for ships, destined him for a commercial life, but even at school the boy showed his natural taste and remarkable talents by producing numerous wax models and busts of his schoolfellows, and afterwards, when placed in a mercantile house, still carried on his favourite employment. Two Homeric studies, executed for a friend, were shown to J. Flaxman, who bestowed on them such high commendation that in 1807 Baily came to London and placed himself as a pupil under the great sculptor. In 1809 he entered the academy schools. In 1811 he gained the academy gold medal for a model of "Hercules restoring Alcestis to Admetus," and soon after exhibited "Apollo discharging his Arrows against the Greeks" and "Hercules casting Lichas into the Sea." In 1821 he was elected R.A., and exhibited one of his best pieces, "Eve at the Fountain." He was entrusted with the carving of the bas-reliefs on the south side of the Marble Arch in Hyde Park, and executed numerous busts and statues, such as those of Nelson in Trafalgar Square, of Earl Grey, of Lord Mansfield and others. Baily died at Holloway on the 22nd of May 1867.

BAILY, FRANCIS (1774–1844), English astronomer, was born at Newbury in Berkshire, on the 28th of April 1774. After a tour in the unsettled parts of North America in 1796–1797, his journal of which was edited by Augustus de Morgan in 1856, he entered the London Stock Exchange in 1799. The successive publication of *Tables for the Purchasing and Renewing of Leases* (1802), of *The Doctrine of Interest and Annuities* (1808), and *The Doctrine of Life-Annuities and Assurances* (1810), earned him a high reputation as a writer on life-contingencies; he amassed a fortune through diligence and integrity and retired from business in 1825, to devote himself wholly to astronomy. He had already, in 1820, taken a leading part in the foundation of the Royal Astronomical Society; and its gold medal was awarded him, in 1827, for his preparation of the Astronomical Society's Catalogue of 2881 stars (*Memoirs R. Astr. Soc.* ii.). The reform of the *Nautical Almanac* in 1829 was set on foot by his protests; he recommended to the British Association in 1837, and in great part executed, the reduction of Joseph de Lalande's and Nicolas de Lacaille's catalogues containing about 57,000 stars; he superintended the compilation of the British Association's Catalogue of 8377 stars (published 1845); and revised the catalogues of Tobias Mayer, Ptolemy, Ulugh Beg, Tycho Brahe, Edmund Halley and Hevelius (*Memoirs R. Astr. Soc.* iv., xiii.).

His note of "Baily's Beads," during an annular eclipse of the

sun on the 15th of May 1836, at Inch Bonney in Roxburghshire, started the modern series of eclipse-expeditions. The phenomenon, which depends upon the inequalities of the moon's limb, was so vividly described by him as to attract an unprecedented amount of attention to the totality of the 8th of July 1842, observed by Baily himself at Pavia. He completed and discussed H. Foster's pendulum-experiments, deducing from them an ellipticity for the earth of $\frac{1}{117}$ (*Memoirs R. Astr. Soc.* vii.); corrected for the length of the seconds-pendulum by introducing a neglected element of reduction; and was entrusted, in 1843, with the reconstruction of the standards of length. His laborious operations for determining the mean density of the earth, carried on by Henry Cavendish's method (1838–1842), yielded for it the authoritative value of 5.66. He died in London, on the 30th of August 1844. Baily's *Account of the Rev. John Flamsteed* (1835) is of included importance to the scientific history of that time. It included a republication of the British Catalogue.

See J. Herschel's *Memoir of F. Baily, Esq.* (1845), also prefixed to Baily's *Journal of a Tour*, with a list of his writings; *Month. Not. R. Astr. Soc.* xiv. 1844.

BAILY, WILLIAM HELLIER (1810–1888), English palaeontologist, nephew of E. H. Baily the sculptor, was born at Bristol on the 7th of July 1810. From 1837 to 1844 he was Assistant Curator in the Bristol Museum, a post he relinquished to join the staff of the Geological Survey in London. In 1854 he became assistant naturalist, under Edward Forbes and afterwards under Huxley. In 1857 he was transferred to the Irish branch of the Geological Survey, as acting palaeontologist, and retained this post until the end of his life. He was the author of many papers on palaeontological subjects, and of notes on fossils in the explanatory memoirs of the Geological Survey of Ireland. He published (1867–1875) a useful work entitled *Figures of Characteristic British Fossils, with Descriptive Remarks*, of which only the first volume, dealing with palaeozoic species, was issued. The figures were all drawn on stone by himself. He died at Rathmines near Dublin on the 6th of August 1888.

BAIN, ALEXANDER (1818–1903), Scottish philosopher and educationalist, was born on the 11th of June 1818 in Aberdeen, where he received his first schooling. In early life he was a weaver, hence the punning description of him as *Wee-ir, rex philosophorum*. In 1836 he entered Marischal College, and came under the influence of John Cruickshank, professor of mathematics, Thomas Clark, professor of chemistry, and William Knight, professor of natural philosophy. His college career was distinguished, especially in mental philosophy, mathematics and physics. Towards the end of his arts course he became a contributor to the *Westminster Review* (first article "Electrotype and Daguerreotype," September 1840). This was the beginning of his connexion with John Stuart Mill, which led to a life-long friendship. In 1841 he became substitute for Dr Glennie, the professor of moral philosophy, who, through ill-health, was unable to discharge the active duties of the chair. This post he occupied for three successive sessions, during which he continued writing for the *Westminster*, and also in 1842 helped Mill with the revision of the MS. of his *System of Logic*. In 1843 he contributed the first review of the book to the *London and Westminster*. In 1845 he was appointed professor of mathematics and natural philosophy in the Andersonian University of Glasgow. A year later, preferring a wider field, he resigned the position and devoted himself to literary work. In 1848 he removed to London to fill a post in the board of health, under Edwin Chadwick, and became a prominent member of the brilliant circle which included George Grote and John Stuart Mill. In 1855 he published his first large work, *The Senses and the Intellect*, followed in 1859 by *The Emotions and the Will*. These treatises won for him a position among independent thinkers. He was examiner in logical and moral philosophy (1857–1862 and 1864–1866) to the university of London, and in moral science in the Indian Civil Service examinations.

In 1866 he was appointed by the crown to the new chair of

logic and English in the university of Aberdeen (created on the amalgamation of the two colleges, King's and Marischal, by the Scottish Universities Commission in 1858). Up to this date neither logic nor English had received adequate attention in Aberdeen, and Bain devoted himself to supplying these deficiencies. He succeeded not only in raising the standard of education generally in the north of Scotland, but also in forming a school of philosophy and in widely influencing the teaching of English grammar and composition. His efforts were first directed to the preparation of English textbooks: *Higher English Grammar* (1863), followed in 1866 by the *Manual of Rhetoric*, in 1872 by *A First English Grammar*, and in 1874 by the *Companion to the Higher Grammar*. These works covered a large field and their original views and methods met with wide acceptance. But the other subject of his chair also called for attention. His own philosophical writings already published, especially *The Senses and the Intellect* (to which was added, in 1861, *The Study of Character*, including an *Estimate of Phrenology*), were too large for effective use in the class-room. Accordingly in 1868, he published his *Manual of Mental and Moral Science*, mainly a condensed form of his treatises, with the doctrines re-stated, and in many instances freshly illustrated, and with many important additions. The year 1870 saw the publication of the *Logic*. This, too, was a work designed for the use of students; it was based on J. S. Mill, but differed from him in many particulars, and had as distinctive features the treatment of the doctrine of the conservation of energy in connexion with causation and the detailed application of the principles of logic to the various sciences. His services to education in Scotland were now recognized by the conferment of the honorary degree of doctor of laws by the university of Edinburgh in 1871. Next came two publications in "The International Scientific Series," namely, *Mind and Body* (1872), and *Education as a Science* (1879).

All these works, from the *Higher English Grammar* downwards, were written by Bain during his twenty years' professoriate at Aberdeen. To the same period belongs his institution of the philosophical journal *Mind*; the first number appeared in January 1876, under the editorship of a former pupil, G. Croom Robertson, of University College, London. To this journal Bain contributed many important articles and discussions; and in fact he bore the whole expenses of it till Robertson, owing to ill-health, resigned the editorship in 1891, when it passed into other hands. Bain resigned his professorship in 1880 and was succeeded by William Minto, one of his most brilliant pupils. Nevertheless his interest in thought, and his desire to complete the scheme of work mapped out in earlier years, remained as keen as ever. Accordingly, in 1882 appeared the *Biography of James Mill*, and accompanying it *John Stuart Mill: a Criticism, with Personal Recollections*. Next came (1884) a collection of articles and papers, most of which had appeared in magazines, under the title of *Practical Essays*. This was succeeded (1887, 1888) by a new edition of the *Rhetoric*, and along with it, a book *On Teaching English*, being an exhaustive application of the principles of rhetoric to the criticism of style, for the use of teachers; and in 1894 he published a revised edition of *The Senses and the Intellect*, which contains his last word on psychology. In 1894 also appeared his last contribution to *Mind*. His last years were spent in privacy at Aberdeen, where he died on the 18th of September 1903. He married twice but left no children.

Bain's life was mainly that of a thinker and a man of letters. But he also took a keen interest and frequently an active part in the political and social movements of the day; and so highly did the students of Aberdeen rate his practical ability, that, after his retirement from the chair of logic, they twice in succession elected him lord rector of the university, each term of office extending over three years. He was a strenuous advocate of reform, especially in the teaching of sciences, and supported the claims of modern languages to a place in the curriculum. A marble bust of him stands in the public library and his portrait hangs in the Marischal College.

Wide as Bain's influence has been as a logician, a grammarian

and a writer on rhetoric, his reputation rests on his psychology. At one with Johannes Müller in the conviction *psychologus nemini physiologus*, he was the first in Great Britain during the 19th century to apply physiology in a thoroughgoing fashion to the elucidation of mental states. He was the originator of the theory of psycho-physical parallelism, which is used so widely as a working basis by modern psychologists. His idea of applying the natural history method of classification to psychical phenomena gave scientific character to his work, the value of which was enhanced by his methodical exposition and his command of illustration. In line with this, too, is his demand that psychology shall be cleared of metaphysics; and to his lead is no doubt due in great measure the position that psychology has now acquired as a distinct positive science. Prof. Wm. James calls his work the "last word" of the earlier stage of psychology, but he was in reality the pioneer of the new. Subsequent psycho-physical investigations have all been in the spirit of his work; and although he consistently advocated the introspective method in psychological investigation, he was among the first to appreciate the help that may be given to it by animal and social and infant psychology. He may justly claim the merit of having guided the awakened psychological interest of British thinkers of the second half of the 19th century into fruitful channels. He emphasized the importance of our active experiences of movement and effort, and though his theory of a central innervation sense is no longer held as he propounded it, its value as a suggestion to later psychologists is great. His autobiography, published in 1904, contains a full list of his works, and also the history of the last thirteen years of his life by W. L. Davidson of Aberdeen University, who further contributed to *Mind* (April 1904) a review of Bain's services to philosophy.

Works (beside the above):—Edition with notes of Paley's *Moral Philosophy* (1852); *Education as a Science* (1879); *Dissertations on leading philosophical topics* (1903, mainly reprints of papers in *Mind*); he collaborated with J. S. Mill and Grose in editing James Mill's *Analysis of the Phenomena of the Human Mind* (1869), and assisted in editing Grote's *Aristotle and Minor Works*; he also wrote a memoir prefixed to G. Croom Robertson's *Philosophical Remains* (1894). (See PSYCHOLOGY and ASSOCIATION OF IDEAS.) (W. L. D.)

BAIN, ANDREW GEDDES (1797-1864), British geologist, was a native of Scotland. In 1820 he emigrated to Cape Colony, and carried on for some years the business of a saddler at Graaf Reinet. During the Kaffir War in 1833-34 he took command of a provisional battalion raised for the defence of the frontier. Later he was engaged to construct a military road through the Ecca Pass, and displayed engineering talents which led to his being permanently employed as surveyor of military roads under the corps of Royal Engineers. This occupation created an interest in geology, which was fostered in 1837 by the loan of Lyell's *Elements*. He discovered the remains of many reptilia, including the *Dicynodon*, which was obtained from the Karroo Beds near Fort Beaufort and described by Owen. Devoting all his spare energies to geological studies, Bain prepared in 1852 the first comprehensive geological map of South Africa, a work of great merit, which was published by the Geological Society of London in 1856. He died at Cape Town in 1864.

Obituary by Dr R. N. Rubidge, in *Geol. Mag.* January 1865, p. 47; also *Trans. Geol. Soc. S. Africa*, vol. ii. part v., June 1896 (with portrait).

BAINBRIDGE, JOHN (1582-1643), English astronomer, was born at Ashby-de-la-Zouch, in Leicestershire. He started as a physician and practised for some years, kept a school and studied astronomy. Having removed to London, he was admitted (November 6, 1618) a licentiate of the college of physicians, and attracted notice by a publication concerning the comet of 1618. Sir Henry Savile (1549-1622) thereupon appointed him in 1619 to the Savilian chair of astronomy just founded by him at Oxford; Bainbridge was incorporated of Merton College and became, in 1631 and 1635 respectively, junior and senior reader of Linaere's lectures. He died at Oxford on the 3rd of November 1643. He wrote *An Astronomical Description of the late Comet* (1619); *Cansularia* (1648), and translated Proclus' *De Sphaera*, and Ptolemy's *De Planetarum Hypothesibus* (1620). Several

manuscript works by him exist in the library of Trinity College, Dublin.

See *Munk's College of Physicians*, i. 175; *Wood's Athenae* (Bliss), iii. 67; *Biographia Britannica*, i. 419.

BAINBRIDGE, WILLIAM (1774-1833), commodore in the United States navy, was born on the 7th of May 1774 in Princeton, New Jersey. At the age of fourteen he went to sea in the merchant service, and was in command of a trading schooner at an early age. The American trading vessels of that period were supposed to be excluded by the navigation laws from commerce with the British West Indian Islands, though with the concealed or very slightly disguised assistance of the planters, they engaged in a good deal of contraband commerce. The war between France and Great Britain tended further to make the carrying trade of neutrals difficult. Bainbridge had therefore to expect, and when he could to elude or beat off, much interference on the part of French and British cruisers alike. He is said to have forced a British schooner, probably a privateer, which attacked him when on his way from Bordeaux to St Thomas, to strike, but he did not take possession. On another occasion he is said to have taken a man out of a British ship in retaliation for the impressment of an American seaman by H.M.S. "Indefatigable," then commanded by Sir Edward Pellew. When the United States navy was organized in 1798 he was included in the corps of naval officers, and appointed to the schooner "Retaliation." She was on one occasion seized by the French but afterwards released. As captain of the brig "Norfolk" of 18 guns, he was employed in cruising against the French, who were as aggressive against American commerce as the English. He was also sent to carry the tribute which the United States still condescended to pay to the dey of Algiers, in order to secure exemption from capture for its merchant ships in the Mediterranean—a service which he performed punctually, though with great disgust. When the United States found that bribing the pirate Barbary states did not secure exemption from their outrages, and was constrained at last to use force, he served against Algiers and Tunis. His ship, the "Philadelphia," ran aground on the Tunisian coast, and he was for a time imprisoned. On his release he returned for a time to the merchant service in order to make good the pecuniary loss caused by his captivity. When the war of 1812 broke out between Great Britain and the United States, Bainbridge was appointed to command the United States frigate "Constitution" (44), in succession to Captain Isaac Hull (q.v.). The "Constitution" was a very fine ship of 1533 tons, which had already captured the "Guerrière." Under Bainbridge she was sent to cruise in the South Atlantic. On the 29th of December 1812 he fell in with H.M.S. "Java," a vessel of 1073 tons, formerly the French frigate "Renommée" (40). She was on her way to the East Indies, carrying the newly appointed lieutenant-governor of Bombay. She had a very raw crew, including very few real seamen, and her men had only had one day's gunnery drill. The United States navy paid great attention to its gunnery, which the British navy, misled by its easy victories over the French, had greatly neglected. In these conditions the fate of the "Java" was soon sealed. She was cut to pieces and forced to surrender, after suffering heavy loss, and inflicting very little on the "Constitution." After the conclusion of the war with Great Britain, Bainbridge served against the Barbary pirates once more. During his later years he served on the board of navy commissioners. He died on the 28th of July 1833. (D. H.)

BAINDIR (anc. *Caystrus*), a town in Asiatic Turkey in the Aidin vilayet, situated in the valley of the Kuchuk Menderes. Pop. under 10,000, nearly half Christian. It is connected with Smyrna by a branch of the Aidin railway, and has a trade in cotton, figs, raisins and tobacco.

BAINES, EDWARD (1774-1848), English newspaper-proprietor and politician, was born in 1774 at Walton-le-Dale, near Preston, Lancashire. He was educated at the grammar schools of Hawkshead and Preston, and at the age of sixteen was apprenticed to a printer in the latter town. After remaining there four years and a half he removed to Leeds, finished his apprenticeship, and at once started in business for himself. He was always

a most assiduous student, and quickly became known as a man of great practical shrewdness and ability, who took a keen interest in political and social movements. His political opinions led him to sympathize with nonconformity and he soon joined the Independents. In 1801 the assistance of party friends enabled him to buy the *Leeds Mercury*. Provincial newspapers did not at that time possess much influence; it was no part of the editor's duty to supply what are now called "leading articles," and the system of reporting was defective. In both respects Baines made a complete change in the *Mercury*. His able political articles gradually made the paper the organ of Liberal opinion in Leeds, and the connexion of the Baines family with the paper made their influence powerful for many years in this direction. Baines soon began to take a prominent part in politics; he was an ardent advocate of parliamentary reform, and it was mainly by his influence that Macaulay was returned for Leeds in 1832; and in 1834 he succeeded Macaulay as member. He was re-elected in 1835 and 1837, but resigned in 1841. In parliament he supported the Liberal party, but with independent views. Like his son Edward after him, he strongly advocated the separation of church and state, and opposed government interference in national education. His letters to Lord John Russell on the latter question (1846) had a powerful influence in determining the action of the government. He died in 1848. His best-known writings are:—*The History, Directory and Gazetteer of the County of York*; *History, Directory and Gazetteer of the County of Lancaster*; *History of the County Palatine and Duchy of Lancaster*. He was also the author of a *History of the Wars of Napoleon*, which was continued under the title of *A History of the Reign of George III*.

His *Life* (1861) has been written by his son, Sir Edward Baines (1800-1890), who was editor and afterwards proprietor of the *Leeds Mercury*, M.P. for Leeds (1850-1874), and was knighted in 1880; his *History of the Cotton Manufacture* (1835) was long a standard authority. An elder son, Matthew Talbot Baines (1799-1860), went to the bar, and became recorder of Hull (1837). He became M.P. for Hull in 1847, and in 1849 president of the Poor Law Board. In 1852 he was returned for Leeds, and again became president of the Poor Law Board (till 1855). In 1856 he entered the cabinet as chancellor of the duchy of Lancaster.

BAINI, GIUSEPPE (1775-1844), Italian priest, musical critic and composer of church music, was born at Rome on the 21st of October 1775. He was instructed in composition by his uncle, Lorenzo Baini, and afterwards by G. Jannaconi. In 1814 he was appointed musical director to the choir of the pontifical chapel, to which he had as early as 1802 gained admission in virtue of his fine bass voice. His compositions, of which very few have been published, were very favourable specimens of the severe ecclesiastical style; one in particular, a ten-part *Miserere*, composed for Holy Week in 1821 by order of Pope Pius VII., has taken a permanent place in the services of the Sistine chapel during Passion Week. Baini held a higher place, however, as a musical critic and historian than as a composer, and his *Life of Palestrina* (*Memorie storico-critiche della vita e delle opere di Giovanni Pierluigi da Palestrina, 1828*) ranks as one of the best works of its class. The phrase *Il Principe della Musica*, which has become finally associated with the name of Palestrina, originates with this biography. Giuseppe Baini died on the 21st of May 1844 in Rome.

BAIRAM, a Perso-Turkish word meaning "festival," applied in Turkish to the two principal festivals of Islam. The first of these, according to the calendar, is the "Lesser Festival," called by the Turks *Kütsühük Bairâm* ("Lesser Bairam"), or *Sheker Bairâm* ("Sugar Bairam"), and by Arabic-speaking Moslems 'Id al-Fitr ("Festival of Fast-breaking"), or *Al-'id as-şoghîr* ("Lesser Festival"). It follows immediately the ninth or the fasting-month, Ramaḍān, occupying the first three days of the tenth month, Shawwāl. It is, therefore, also called by Turks *Ramaḍān Bairâm*, and exhibits more outward signs of rejoicing than the technically "Greater Festival." Official receptions are held on it, and private visits paid; friends congratulate one another, and presents are given; new clothes

are put on, and the graves of relatives are visited. The second, or "Greater Festival," is called by the Turks *Qurbān Bairām*, Sacrifice Bairam, and by Arabic speakers *Al-'id al-kabir*, "Greater Festival," or *Id al-ahḡā*, "Festival of Sacrifice." It falls on the tenth, and two or three following days, of the last month, *Dhū-l-ḡijja*, when the pilgrims each slay a ram, a he-goat, a cow or a camel in the valley of Minā in commemoration of the ransom of Ishmael with a ram. Similarly throughout the Moslem world, all who can afford it sacrifice at this time a legal animal, and either consume the flesh themselves or give it to the poor. Otherwise it is celebrated like the "Lesser Festival," but with less ardour. Both festivals, of course, belong to a lunar calendar, and move through the solar year every thirty-two years.

See Lane's *Modern Egyptians*, chap. xxv.; Michell, *Egyptian Calendar*; Hughes, *Dictionary of Islam*, pp. 192 ff.; Sir R. Burton, *Pilgrimage*, chaps. vii., xxx. (D. B. Ma.)

BAIRD, SIR DAVID (1757-1829), British general, was born at Newbyth in Aberdeenshire in December 1757. He entered the British army in 1773, and was sent to India in 1779 with the 73rd (afterwards 71st) Highlanders, in which he was a captain. Immediately on his arrival, Baird was attached to the force commanded by Sir Hector Munro, which was sent forward to assist the detachment of Colonel Baillie, threatened by Hyder Ali. In the action which followed the whole force was destroyed, and Baird, severely wounded, fell into the hands of the Mysore chief. The prisoners, who were most barbarously treated, remained captive for over four years. Baird's mother, on hearing that her son and other prisoners were in fetters, is said to have remarked, "God help the chiel chained to oor Davie." The bullet was not extracted from Baird's wound until his release. He became major in 1787, visited England in 1789, and purchased a lieutenant-colonelcy in 1790, returning to India in the following year. He held a brigade command in the war against Tippon, and served under Cornwallis in the Seringapatam operations of 1792, being promoted colonel in 1795. Baird served also at the Cape of Good Hope as a brigadier-general, and he returned to India as a major-general in 1798. In the last war against Tippon in 1799 Baird was appointed to the senior brigade command in the army. At the successful assault of Seringapatam Baird led the storming party, and was soon a master of the stronghold in which he had long been a prisoner. He had been disappointed that the command of the large contingent of the nizam was given to Colonel Arthur Wellesley; and when after the capture of the fortress the same officer obtained the governorship, Baird judged himself to have been treated with injustice and disrespect. He afterwards received the thanks of parliament and of the East India Company for his gallant bearing on that important day, and a pension was offered to him by the Company, which he declined, apparently from the hope of receiving the order of the Bath from the government. General Baird commanded the Indian army which was sent in 1801 to co-operate with Abercromby in the expulsion of the French from Egypt. Wellesley was appointed second in command, but owing to ill-health did not accompany the expedition. Baird landed at Kosseir, conducted his army across the desert to Kena on the Nile, and thence to Cairo. He arrived before Alexandria in time for the final operations. On his return to India in 1802, he was employed against Sindhia, but being irritated at another appointment given to Wellesley he relinquished his command and returned to Europe. In 1804 he was knighted, and in 1805-1806, being by now a lieutenant-general, he commanded the expedition against the Cape of Good Hope with complete success, capturing Cape Town and forcing the Dutch general Janssens to surrender. But here again his usual ill luck attended him. Commodore Sir Home Popham persuaded Sir David to lend him troops for an expedition against Buenos Aires; the successive failures of operations against this place involved the recall of Baird, though on his return home he was quickly re-employed as a divisional general in the Copenhagen expedition of 1807. During the bombardment of Copenhagen Baird was wounded. Shortly after his return, he was sent out to the Peninsular War in command of a considerable force

which was sent to Spain to co-operate with Sir John Moore, to whom he was appointed second in command. It was Baird's misfortune that he was junior by a few days both to Moore and to Lord Cavan, under whom he had served at Alexandria, and thus never had an opportunity of a chief command in the field. At the battle of Corunna he succeeded to the supreme command after Moore's fall, but shortly afterwards his left arm was shattered, and the command passed to Sir John Hope. He again obtained the thanks of parliament for his gallant services, and was made a K.B. and a baronet. Sir David married Miss Campbell-Preston, a Perthshire heiress, in 1810. He was not employed again in the field, and personal and political enmities caused him to be neglected and repeatedly passed over. He was not given the full rank of general until 1814, and his governorship of Kinsale was given five years later. In 1820 he was appointed commander-in-chief in Ireland, but the command was soon reduced, and he resigned in 1822. He died on the 18th of August 1829.

See Theodore Hook's *Life of Sir David Baird*.

BAIRD, HENRY MARTYN (1832-1906), American historian and educationalist, a son of Robert Baird (1798-1863), a Presbyterian preacher and author who worked earnestly both in the United States and in Europe for the cause of temperance, was born in Philadelphia, Pennsylvania, on the 17th of January 1832. He spent eight years of his early youth with his father in Paris and Geneva, and in 1850 graduated at New York University. He then lived for two years in Italy and Greece, was a student in the Union Theological Seminary in New York city from 1853 to 1855, and in 1856 graduated at the Princeton Theological Seminary. He was a tutor for four years in the College of New Jersey (now Princeton University), and from 1859 until his death was professor of Greek language and literature in New York University. He is best known, however, as a historian of the Huguenots. His work, which appeared in three parts, entitled respectively *History of the Rise of the Huguenots of France* (2 vols., 1879), *The Huguenots and Henry of Navarre* (2 vols., 1886), and *The Huguenots and the Revocation of the Edict of Nantes* (2 vols., 1895), is characterized by painstaking thoroughness, by a judicial temper, and by scholarship of a high order. He also published *Modern Greece, A Narrative of a Residence and Travels in that Country* (1856); a biography of his father, *The Life of the Rev. Robert Baird, D.D.* (1866); and *Theodore Besa, the Counsellor of the French Reformation* (1899). He died in New York city on the 11th of November 1906.

His brother, CHARLES WASHINGTON BAIRD (1828-1887), a graduate of New York University (1848) and of the Union Theological Seminary (1852), and the minister in turn of a Dutch Reformed church at Brooklyn, New York, and of a Presbyterian church at Rye, New York, also was deeply interested in the history of the Huguenots, and published a scholarly work entitled *The History of the Huguenot Emigration to America* (2 vols., 1885), left unfinished at his death.

BAIRD, JAMES (1802-1876) Scottish iron-master, was born at Kirkwood, Lanarkshire, on the 5th of December 1802, the son of a coal-master. In 1826 his father, two brothers and himself leased coalfields at Gartsherrie and in the vicinity, and in 1828 iron mines near by, and in 1830 built blast furnaces. In this year the father retired, the firm of William Baird & Co. was organized, and James Baird assumed active control. His improvements in machinery largely increased the output of his furnaces, which by 1864 had grown in number to nearly fifty, producing 300,000 tons annually and employing 10,000 hands. The brothers became great landowners, and James was M.P. for the Falkirk burghs in 1851-1852 and 1852-1857. He died at his estate near Ayr on the 20th of June 1876, leaving property valued at three million pounds. He had been during his life a great public benefactor, founding schools and the Baird Lectures (1871) for the defence of orthodox theology, and in 1873 the Baird Trust of £500,000 to enable the Established Church of Scotland to cope with the spiritual needs of the masses. He was twice married but left no children.

BAIRD, SPENCER FULLERTON (1823-1887), American naturalist, was born in Reading, Pennsylvania, on the 3rd of

February 1823. He graduated at Dickinson College, Carlisle, Pennsylvania in 1840, and next year made an ornithological excursion through the mountains of Pennsylvania, walking, says one of his biographers, "400 m. in twenty-one days, and the last day 60 m." In 1838 he met J. J. Audubon, and thenceforward his studies were largely ornithological, Audubon giving him a part of his own collection of birds. After studying medicine for a time, Baird became professor of natural history in Dickinson College in 1845, assuming also the duties of the chair of chemistry, and giving instruction in physiology and mathematics. This variety of duties in a small college tended to give him that breadth of scientific interest which characterized him through life, and made him perhaps the most representative general man of science in America. For the long period between 1850 and 1878 he was assistant-secretary of the Smithsonian Institution, Washington, and on the death of Joseph Henry he became secretary. From 1871 till his death he was U.S. Commissioner of Fish and Fisheries. While an officer of the Smithsonian, Baird's duties included the superintendence of the labour of workers in widely different lines. Thus, apart from his assistance to others, his own studies and published writings cover a broad range: iconography, geology, mineralogy, botany, anthropology, general zoology, and, in particular, ornithology; while for a series of years he edited an annual volume summarizing progress in all scientific lines of investigation. He gave general superintendence, between 1850 and 1860, to several government expeditions for scientific exploration of the western territories of the United States, preparing for them a manual of *Instructions to Collectors*. Of his own publications, the bibliography by G. Brown Goode, from 1843 to the close of 1882, includes 1063 entries, of which 775 were short articles in his *Annual Record*. His most important volumes, on the whole, were *Birds*, in the series of reports of explorations and surveys for a railway route from the Mississippi river to the Pacific ocean (1858), of which Dr Elliott Coues says (as quoted in the *Popular Science Monthly*, xxxiii. 553) that it "exerted an influence perhaps stronger and more widely felt than that of any of its predecessors, Audubon's and Wilson's not excepted, and marked an epoch in the history of American ornithology"; *Mammals of North America: Descriptions based on Collections in the Smithsonian Institution* (Philadelphia, 1859); and the monumental work (with Thomas Mayo Brewer and Robert Ridgway) *History of North American Birds* (Boston, 1875-1884; "Land Birds," 3 vols., "Water Birds," 2 vols.). He died on the 10th of August 1887 at the great marine biological laboratory at Woods Hole, Massachusetts, an institution which was largely the result of his own efforts, and which has exercised a wide effect upon both scientific and economic ichthyology.

BAIRNSDALE, a town of Tanjil county, Victoria, Australia, on the Mitchell river, 171 m. by rail E. of Melbourne. Pop. (1901) 3074. It lies near the head of a lagoon called Lake King, which is open to the sea, and affords regular communication by water with Melbourne. In the district, which is chiefly pastoral, there are several goldfields, with both alluvial and reef mining. The town has tanneries, and cheese and butter factories. There is an active shipping trade with Melbourne in maize and other grain, hops, fruit and dairy produce.

BAITER, JOHANN GEORG (1801-1877). Swiss philologist and textual critic, was born at Zürich on the 31st of May 1801. Having received his early education in his native place, he went (1818) to the university of Tübingen, but from want of funds was obliged to return to Zürich, where for several years he was a private tutor. From 1824 to 1829 he studied at Munich under Friedrich Thiersch; at Göttingen, under Georg Dissen; at Königsberg, under Christian Lobeck. From 1833 to 1876 he was *Oberlehrer* at the gymnasium in Zürich, where he died on the 10th of October 1877. Baiter's strong point was textual criticism, applied chiefly to Cicero and the Attic orators; he was very successful in hunting up the best MS. authorities, and his collections were made with the greatest accuracy. Most of his works were produced in collaboration with other scholars, such as Orelli, who regarded him as his right-hand man. He edited Isocrates. *Panegyricus* (1831); with Sauppe, Lycurgus, *Leocratus*

(1834) and *Oratores Attici* (1838-1850); with Orelli and Winckelmann, a critical edition of Plato (1839-1842), which marked a distinct advance in the text, two new MSS. being laid under contribution; with Orelli, Babrius, *Fabellae Iambicæ nuper repertae* (1845); Isocrates, in the Didot collection of classics (1846). He had for some time been associated with Orelli in his great work on Cicero, and assisted in *Ciceronis Scholastica* (1833) and *Onomasticon Tullianum* (1836-1838). For the *Fasti Consulares* and *Triumphales* he was alone responsible. With Orelli and (after his death) Halm, he assisted in the second edition of the Cicero, and, with Kayser, edited the same author for the Teuchnitz series (1860-1866). New editions of Orelli's Tacitus and Horace were also due to him. It is worth noting that, with Sauppe, he translated Leake's *Topography of Athens*.

BAIUS, or DE BAY, **MICHAEL** (1513-1580), Belgian theologian, was born at Melun in Hainault in 1513. Educated at Louvain University, he studied philosophy and theology with distinguished success, and was rewarded by a series of academic appointments. In 1552 Charles V. appointed him professor of scriptural interpretation in the university. In 1563 he was nominated one of the Belgian representatives at the council of Trent, but arrived too late to take an important part in its deliberations. At Louvain, however, he obtained a great name as a leader in the anti-scholastic reaction of the 16th century. The champions of this reaction fought under the banner of St Augustine; and Baius' Augustinian predilections brought him into conflict with Rome on questions of grace, free-will and the like. In 1567 Pius V. condemned seventy-nine propositions from his writings in the Bull *Ex omnibus afflictionibus*. To this Baius submitted; though certain indiscreet utterances on the part of himself and his supporters led to a renewal of the condemnation in 1579 by Gregory XIII. Baius, however, was not disturbed in the tenure of his professorship, and even became chancellor of Louvain in 1575. He died, still in the enjoyment of these two dignities, in 1580. Baius is chiefly interesting as a forerunner of the more celebrated Cornelius Jansen (see JANSEN). His writings are described by Harnack as a curious mixture of Catholic orthodoxy and unconscious tendencies to Protestantism; their most noticeable point is the great importance they attach to the fact of sin, both original and actual.

His principal works were published in a collected form at Cologne, 1696, 1 vol. 4to, in two parts; some large treatises have not been published. There is an excellent study of both books and author by Linsenmann, *Michael Baius, und die Grundlegung des Jansenismus*, published at Tübingen in 1867.

BAIZE (16th century Fr. *baies*, cf. English "bay"), a material probably named from its original colour, though a derivation is also suggested from the Fr. *baise*, as the cloth is said to have been originally dyed with Avignon berries. It is generally a coarse, woollen cloth with a long nap and is commonly dyed green or red. It is now also made of cotton. The manufacture is said to have been introduced into England in the 16th century by refugees from France and the Netherlands. It is used chiefly for curtains, linings, &c., and sometimes, in the lighter makes, for clothing. *Table baize* is a kind of oilcloth used as a cheap and easily-cleaned covering for tables.

BAJOCIAN, in geology, the name proposed in 1849 by d'Orbigny for the rocks of Middle Jurassic age which are well developed in the neighbourhood of Bayeux, Calvados. The Bajocian stage is practically equivalent to the Inferior Oolite of British geologists. It corresponds fairly closely with the Lower and Middle Brown Jura of Quenstedt, and with the Dogger of Oepel. By means of the fossil ammonites the Bajocian strata have been subdivided into the following zones, in descending order:—

- Zone of *Parkinsonia Parkinsoni* and *Cosmoceras garantianum*
- " *Ceoloceras subcoronatum* (*Humphriestianum*)
- " *Sonninia Romani*
- " *Stephaoceras Sowerbyi*
- " *Harporoceras concavum*
- " " *Murchisonae* = Substage Aalénien
- " " *opalinum* = of Mayer-Eymar.

It should be remarked that some European geologists prefer

to include the *Parkinsonia* zone in the base of the overlying Bathonian (*q.v.*).

The Bajocian rocks of Europe are mostly limestones of various kinds, very frequently oolitic. At Bayeux, the type district, they are ferruginous oolites; in the Jura and Lorraine a coral limestone overlies a crinoidal variety; calcareous sandy and marly beds occur in Maine and Anjou; in Poitou the limestone is dolomitic and bears nodules of chert. Rocks of the same age, as recognized by their fossil contents, have a wide range; they are found in north Africa, Goa, Somaliland, German East Africa, and north-west Madagascar; through southern Europe they may be followed into Turkestan, and the Kota-Maleri beds of the Upper Gondwana series of India may possibly belong to this stage. In South America they appear in Bolivia, Chile and Argentina; in North America, in British Columbia, Dakota, Mexico, Oregon and California. The Bajocian sea also included parts of New South Wales, New Zealand (Flag Hills beds?), Borneo and Japan, and it extended into the polar region of eastern Greenland and Franz Josef Land.

In addition to the ammonites already mentioned, the large belemnites (*Megateuthis giganteus*) and terebratulites (*T. perovialis*) are worthy of notice; crinoids and corals were abundant, and so also were certain forms of *Trigonia* (*T. costata*), *Pleurotomaria* and *Cidaris*.

See JURASSIC; also A. de Lapparent, *Traité de géologie*, vol. ii. (5th ed., 1906); and H. B. Woodward, "The Jurassic Rocks of Britain," vol. iv., 1894 (*Mem. Geol. Survey*); both works contain references to original papers. (J. A. H.)

BAJOUR, or **BAJAUR**, a small district peopled by Pathan races of Afghan origin, in the North-West Frontier Province of India. It is about 45 m. long by 20. broad, and lies at a high level to the east of the Kunar valley, from which it is separated by a continuous line of rugged frontier hills, forming a barrier easily passable at one or two points. Across this barrier the old road from Kabul to India ran before the Khyber Pass was adopted as the main route. Bajour is inhabited almost exclusively by Tarkani (Tarkalanri) Pathans, sub-divided into Mamunds, Isazai, and Ismailzai, numbering together with a few Mohmands, Utmazais, &c., about 100,000. To the south of Bajour is the wild mountain district of the Mohmands, a Pathan race. To the east, beyond the Panjkora river, are the hills of Swat, dominated by another Pathan race. To the north is an intervening watershed between Bajour and the small state of Dir; and it is over this watershed and through the valley of Dir that the new road from Malakand and the Punjab runs to Chitral. The drainage of Bajour flows eastwards, starting from the eastern slopes of the dividing ridge which overlooks the Kunar and terminating in the Panjkora river, so that the district lies on a slope tilting gradually downwards from the Kunar ridge to the Panjkora. Nawagai is the chief town of Bajour, and the khan of Nawagai is under British protection for the safeguarding of the Chitral road. Jandol, one of the northern valleys of Bajour, has ceased to be of political importance since the failure of its chief, Umra Khan, to appropriate to himself Bajour, Dir, and a great part of the Kunar valley. It was the active hostility between the amir of Kabul (who claimed sovereignty of the same districts) and Umra Khan that led, firstly to the demarcation agreement of 1893 which fixed the boundary of Afghanistan in Kunar; and, secondly, to the invasion of Chitral by Umra Khan (who was no party to the boundary settlement) and the siege of the Chitral fort in 1895.

An interesting feature in Bajour topography is a mountain spur from the Kunar range, which curving eastwards culminates in the well-known peak of Koh-i-Mor, which is visible from the Peshawar valley. It was here, at the foot of the mountain, that Alexander found the ancient city of Nysa and the Nysaeen colony, traditionally said to have been founded by Dionysus. The Koh-i-Mor has been identified as the Meros of Ariian's history—the three-peaked mountain from which the god issued. It is also interesting to find that a section of the Kafir community of Kamdesh still claim the same Greek origin as did the Nysaeans; still chant hymns to the god who sprang from Gir Nysa (the

mountain of Nysa); whilst they maintain that they originally migrated from the Swat country to their present habitat in the lower Bashlog. Long after Buddhism had spread to Chitral, Gilgit, Dir and Swat; whilst Ningrahar was still full of monasteries and temples, and the Peshawar valley was recognized as the seat of Buddhist learning, the Kafirs or Nysaeans held their own in Bajour and in the lower Kunar valley, where Buddhism apparently never prevailed. It is probable that the invader Baber (who has much to say about Bajour) fought them there in the early years of the 16th century, when on his way to found the Mogul dynasty of India centuries after Buddhism has been crushed in northern India by the destroyer Mahmud.

The Gazetteers and Reports of the Indian government contain nearly all the modern information available about Bajour. The autobiography of Baber (by Leyden and Erskine) gives interesting details about the country in the 16th century. For the connexion between the Kafirs and the ancient Nysaeans of Swat, see *R. G. S. Journal*, vol. vii., 1896. (T. H. H.)

BAJZA, JOSEPH (1804–1858), Hungarian poet and critic, was born at Szicsi in 1804. His earliest contributions were made to Kisfaludy's *Aurora*, a literary paper of which he was editor from 1830 to 1837. He also wrote largely in the *Kritische Blätter*, the *Athenaeum*, and the *Figyelmező* or *Observer*. His criticisms on dramatic art were considered the best of these miscellaneous writings. In 1830 he published translations of some foreign dramas, *Ausländische Bühne*, and in 1835 a collection of his own poems. In 1837 he was made director of the newly established national theatre at Pest. He then, for some years, devoted himself to historical writing, and published in succession the *Historical Library* (*Történelmi Könyvtár*), 6 vols., 1843–1845; the *Modern Plutarch* (*Új Plutarch*), 1845–1847; and the *Universal History* (*Világörölet*), 1847. These works are to some extent translations from German authors. In 1847 Bajza edited the journal of the opposition, *Ellenőr*, at Leipzig, and in March 1848 Kossuth made him editor of his paper, *Kossuth Hirlojaja*. In 1850 he was attacked with brain disease and died in 1858.

BAKALAI (BAKALÉ, BANGOUENS), a Bantu negroid tribe inhabiting a wide tract of French Congo between the river Ogowé and 2° S. They appear to be immigrants from the south-east, and have been supposed to be connected racially with the Galoa, one of the Mpongwe tribes and the chief river-people of the Ogowé. The Bakalai have suffered much from the incursions of their neighbours the Fang, also arrivals from the south-east, and it may be that they migrated to their present abode under pressure from this people at an earlier date. They are keen hunters and were traders in slaves and rubber; the slave traffic has been prohibited by the French authorities. Their women display considerable ingenuity in dressing their hair, often taking a whole day to arrange a coiffure; the hair is built up on a substructure of clay and a good deal of false hair incorporated; a coat of red, green or yellow pigment often completes the effect. The same colours are used to decorate the hut doors. The villages, some of which are fortified with palisades, are usually very dirty; chiefs and rich men own plantations which are situated at some distance from the village and to which their womenfolk are sent in times of war. The Bakalai of Lake Isanga cremate their dead; those of the Upper Ogowé throw the bodies into the river, with the exception of those killed in war. The body of a chief is placed secretly in a hut erected in the depths of the forest, and the village is deserted for that night, in some cases altogether; the slaves of the deceased are (or were) sacrificed, and his wives scourged and secluded in huts for a week. "Natural" deaths are attributed to the machinations of a sorcerer, and the poison-ordeal is often practised. Of their social organization little is known, but it appears that nearly all individuals refrain from eating the flesh of some particular animal.

BAKE, JAN (1787–1864), Dutch philologist and critic, was born at Leiden on the 1st of September 1787, and from 1817 to 1854 he was professor of Greek and Roman literature at the university. He died on the 26th of March 1864. His principal works are:—*Posidonii Rhodii Reliquiae Doctrinae* (1810); *Cleemidis Circularis Doctrinae de Sublimitate* (1820); *Bibliotheca*

Critica Nova (1825-1831) and *Scholica Hypomnemata* (1837-1862), a collection of essays dealing mainly with Cicero and the Attic orators; Cicero, *De Legibus* (1842) and *De Oratore* (1863); and the *Rhetorica* of Apines and Longinus (1849).

His biography was written (in Dutch) by his pupil Bakhuizen van der Brink (1865); for an appreciation of his services to classical literature see L. Müller, *Geschichte der klassischen Philologie in den Niederlanden* (1869).

BAKER, SIR BENJAMIN (1840-1907), English engineer, was born near Bath in 1840, and, after receiving his early training in a South Wales ironworks, became associated with Sir John Fowler in London. He took part in the construction of the Metropolitan railway (London), and in designing the cylindrical vessel in which Cleopatra's Needle, now standing on the Thames Embankment, London, was brought over from Egypt to England in 1877-1878. By this time he had already made himself an authority on bridge-construction, and shortly afterwards he was engaged on the work which made his reputation with the general public—the design and erection of the Forth Bridge. On the completion of this undertaking in 1890 he was made K.C.M.G., and in the same year the Royal Society recognized his scientific attainments by electing him one of its fellows. Twelve years later at the formal opening of the Assuan dam, for which he was consulting-engineer, he was created K.C.B. Sir Benjamin Baker, who also had a large share in the introduction of the system widely adopted in London of constructing intra-urban railways in deep tubular tunnels built up of cast iron segments, obtained an extremely large professional practice, ranging over almost every branch of civil engineering, and was more or less directly concerned with most of the great engineering achievements of his day. He was also the author of many papers on engineering subjects. He died at Pangbourne, Berks, on the 10th of May 1907.

BAKER, HENRY (1698-1774), English naturalist, was born in London on the 8th of May 1698. After serving an apprenticeship with a bookseller, he devised a system of instructing the deaf and dumb, by the practice of which he made a considerable fortune. It brought him to the notice of Daniel Defoe, whose youngest daughter Sophia he married in 1729. A year before, under the name of Henry Stonecastle, he was associated with Defoe in starting the *Universal Spectator* and *Weekly Journal*. In 1740 he was elected fellow of the Society of Antiquaries and of the Royal Society. He contributed many memoirs to the *Transactions* of the latter society, and in 1744 received the Copley gold medal for microscopical observations on the crystallization of saline particles. He was one of the founders of the Society of Arts in 1754, and for some time acted as its secretary. He died in London on the 25th of November 1774. Among his publications were *The Microscope made Easy* (1743), *Employment for the Microscope* (1753), and several volumes of verse, original and translated, including *The Universe, a Poem intended to restrain the Pride of Man* (1727). His name is perpetuated by the Bakerian lecture of the Royal Society, for the foundation of which he left by will the sum of £100.

BAKER, SIR RICHARD (1568-1644/5), author of the *Chronicle of the Kings of England* and other works, was probably born at Sissinghurst in Kent, and entered Hart Hall, Oxford, as a commoner in 1584. He left the university without taking a degree, studied law in London and afterwards travelled in Europe. In 1593 he was chosen member of parliament for Arundel, in 1594 his university conferred upon him the degree of M.A., and in 1597 he was elected to parliament as the representative of East Grinstead. In 1603 he was knighted by King James I., in 1620 he acted as high sheriff at Oxfordshire where he owned some property, and soon afterwards he married Margaret, daughter of Sir George Mainwaring, of Ightfield, Shropshire. By making himself responsible for some debts of his wife's family, he was reduced to great poverty, which led to the seizure of his Oxfordshire property in 1625. Quite penniless, he took refuge in the Fleet prison in 1635, and was still in confinement when he died on the 18th of February 1644 (1645). He was buried in the church of St Bride, Fleet Street, London.

During his imprisonment Baker spent his time mainly in writing. His chief work is the *Chronicle of the Kings of England from the Time of the Romans' Government unto the Death of King James* (1643, and many subsequent editions). It was translated into Dutch in 1649, and was continued down to 1658 by Edward Phillips, a nephew of John Milton. For many years the *Chronicle* was extremely popular, but owing to numerous inaccuracies its historical value is very slight. Baker also wrote *Cato Variiegatus* or *Cato's Morall Disticks, Translated and Paraphrased by Sir Richard Baker, Knight* (London, 1636); *Meditations on the Lord's Prayer* (1637); *Translation of New Epistles by Moonsieur D'Balzac* (1638); *Apologie for Laymen's Writing in Divinity, with a Short Meditation upon the Fall of Lucifer* (1641); *Motives for Prayer upon the seven dayes of ye weeke* (1642); a translation of *Malsenzi's Discourses upon Cornelius Tacitus* (1642), and *Theatrum Redivivum, or The Theatre Vindicated*, a reply to the *Histrio-Mastix* of William Prynne (1642). He also wrote *Meditations* upon several of the psalms of David, which have been collected and edited by A. B. Grosart (London, 1882).

See J. Granger, *Biographical History of England to the Revolution* (London, 1804); *Biographia Britannica*, corrected by A. Kippis (London, 1778-1793).

BAKER, SIR SAMUEL WHITE (1821-1893), English explorer, was born in London on the 8th of June 1821. He was educated partly in England and partly in Germany. His father, a West India merchant, destined him for a commercial career, but a short experience of office work proved him to be entirely unsuited to such a life. On the 3rd of August 1843 he married Henrietta Biddulph Martin, daughter of the rector of Maisemore, Gloucestershire, and after two years in Mauritius the desire for travel took him in 1846 to Ceylon, where in the following year he founded an agricultural settlement at Nuwara Eliya, a mountain health-resort. Aided by his brother, he brought emigrants thither from England, together with choice breeds of cattle, and before long the new settlement was a success. During his residence in Ceylon he published, as a result of many adventurous hunting expeditions, *The Rifle and the Hound in Ceylon* (1853), and two years later *Eight Years' Wanderings in Ceylon* (1855). After a journey to Constantinople and the Crimea in 1856, he found an outlet for his restless energy by undertaking the supervision of the construction of a railway across the Dobruja, connecting the Danube with the Black Sea. After its completion he spent some months in a tour in south-eastern Europe and Asia Minor. It was during this time that he met in Hungary the lady who (in 1860) became his second wife, Florence, daughter of Finnian von Sass, his first wife having died in 1855. In March 1861 he started upon his first tour of exploration in central Africa. This, in his own words, was undertaken "to discover the sources of the Nile, with the hope of meeting the East African expedition under Captains Speke and Grant somewhere about the Victoria Lake." After a year spent on the Sudan-Abyssinian border, during which time he learnt Arabic, explored the Atbara and other Nile tributaries, and proved that the Nile sediment came from Abyssinia, he arrived at Khartoum, leaving that city in December 1862 to follow up the course of the White Nile. Two months later at Gondokoro he met Speke and Grant, who, after discovering the source of the Nile, were following the river to Egypt. Their success made him fear that there was nothing left for his own expedition to accomplish; but the two explorers generously gave him information which enabled him, after separating from them, to achieve the discovery of Albert Nyanza, of whose existence credible assurance had already been given to Speke and Grant. Baker first sighted the lake on the 14th of March 1864. After some time spent in the exploration of the neighbourhood, during which Baker demonstrated that the Nile flowed through the Albert Nyanza—of whose size he formed an exaggerated idea—he started upon his return journey, and reached Khartoum after many checks in May 1865. In the following October he returned to England with his wife, who had accompanied him throughout the whole of the perilous and arduous journey. In recognition of the achievements by which Baker had indissolubly linked his name

with the solution of the problem of the Nile sources, the Royal Geographical Society awarded him its gold medal, and a similar distinction was bestowed on him by the Paris Geographical Society. In August 1866 he was knighted. In the same year he published *The Albert N'yanza, Great Basin of the Nile, and Explorations of the Nile Sources*, and in 1867 *The Nile Tributaries of Abyssinia*, both books quickly going through several editions. In 1868 he published a popular story called *Cast up by the Sea*. In 1869 he attended the prince of Wales, afterwards King Edward VII., in a tour through Egypt. In the same year, at the request of the khedive Ismail, Baker undertook the command of a military expedition to the equatorial regions of the Nile, with the object of suppressing the slave-trade there and opening the way to commerce and civilization. Before starting from Cairo with a force of 1700 Egyptian troops—many of them discharged convicts—he was given the rank of pasha and major-general in the Ottoman army. Lady Baker, as before, accompanied him. The khedive appointed him governor-general of the new territory for four years at a salary of £10,000 a year; and it was not until the expiration of that time that Baker returned to Cairo, leaving his work to be carried on by the new governor, Colonel Charles George Gordon. He had to contend with innumerable difficulties—the blocking of the river by sudd, the bitter hostility of officials interested in the slave-trade, the armed opposition of the natives—but he succeeded in planting in the new territory the foundations upon which others could build up an administration. He returned to England with his wife in 1874, and in the following year purchased the estate of Sandford Orleigh in South Devon, where he made his home for the rest of his life. He published his narrative of the central African expedition under the title of *Ismailia* (1874). *Cyprus as I saw it in 1879* was the result of a visit to that island. He spent several winters in Egypt, and travelled in India, the Rocky Mountains and Japan in search of big game, publishing in 1890 *Wild Beasts and their Ways*. He kept up an exhaustive and vigorous correspondence with men of all shades of opinion upon Egyptian affairs, strongly opposing the abandonment of the Sudan and subsequently urging its reconquest. Next to these, questions of maritime defence and strategy chiefly attracted him in his later years. He died at Sandford Orleigh on the 30th of December 1893.

See, besides his own writings, *Sir Samuel Baker, a Memoir*, by T. Douglas Murray and A. Silva White (London, 1895).

BAKER, THOMAS (1656–1740), English antiquary, was born on the 14th of September 1656 at Lanchester, Durham. He was the grandson of Colonel Baker of Crook, Durham, who won fame in the civil war by his defence of Newcastle against the Scots. He was educated at the free school at Durham, and proceeded thence in 1672 to St John's College, Cambridge, where he afterwards obtained a fellowship. Lord Crew, bishop of Durham, collated him to the rectory of Long-Newton in his diocese in 1687, and intended to give him that of Sedgfield with a prebend had not Baker incurred his displeasure by refusing to read James II.'s Declaration of Indulgence. The bishop who disgraced him for this refusal, and who was afterwards specially excepted from William's Act of Indemnity, took the oaths to that king and kept his bishopric till his death. Baker, on the other hand, though he had opposed James, refused to take the oaths to William; he resigned Long-Newton on the 1st of August 1690, and retired to St John's, in which he was protected till the 20th of January 1716–1717, when he and one - and - twenty others were deprived of their fellowships. After the passing of the Registering Act in 1723, he could not be prevailed on to comply with its requirements by registering his annuity of £40, although that annuity, left him by his father, with £20 per annum from his elder brother's collieries, was now his whole subsistence. He retained a lively sense of the injuries he had suffered; and inscribed himself in all his own books, as well as in those which he gave to the college library, *socius ejectus*, and in some *rector ejectus*. He continued to reside in the college as commoner-master till his sudden death from apoplexy on the 2nd of July 1740. The whole of his valuable books and manuscripts he bequeathed to the university. The only works

he published were, *Reflections on Learning, showing the Insufficiency thereof in its several particulars, in order to evince the usefulness and necessity of Revelation* (London, 1709–1710) and the preface to Bishop Fisher's *Funeral Sermon for Margaret, Countess of Richmond and Derby* (1708)—both without his name. His valuable manuscript collections relative to the history and antiquities of the university of Cambridge, amounting to thirty-nine volumes in folio and three in quarto, are divided between the British Museum and the public library at Cambridge,—the former possessing twenty-three volumes, the latter sixteen in folio and three in quarto.

The life of Baker was written by Robert Masters (Camb., 1784), and by Horace Walpole in the quarto edition of his works.

BAKER, VALENTINE [BAKER PASHA] (1827–1887), British soldier, was a younger brother of Sir Samuel Baker (q.v.). He was educated at Gloucester and in Ceylon, and in 1848 entered the Ceylon Rifles as an ensign. Soon transferred to the 12th Lancers, he saw active service with that regiment in the Kaffir war of 1852–53. In the Crimean War Baker was present at the action of Traktir (or Tchernaya) and at the fall of Sevastopol, and in 1859 he became major in the 10th Hussars, succeeding only a year later to the command. This position he held for thirteen years, during which period the highest efficiency of his men was reached, and outside the regiment he did good service to his arm by his writings. He went through the wars of 1866 and 1870 as a spectator with the German armies, and in 1873 he started upon a famous journey through Khorassan. Though he was unable to reach Khiva the results of the journey afforded a great deal of political, geographical and military information, especially as to the advance of Russia in central Asia. In 1874 he was back in England and took up a staff appointment at Aldershot. Less than a year later Colonel Baker's career in the British army came to an untimely end. He was arrested on a charge of indecent assault upon a young woman in a railway carriage, and was sentenced to a year's imprisonment and a fine. His dismissal from the service was an inevitable consequence; it must be stated, however, that the view taken of the circumstances by good authorities was that Baker's conduct, when judged by conventional standards, admitted of considerable extenuation. He himself never opened his mouth in self-defence. Two years later, having meanwhile left England, he entered the service of Turkey in the war with Russia. At first in a high position in the gendarmerie, he was soon transferred to Mehemet's staff, and thence took over the command of a division of infantry. With this division Baker sustained the brilliant rearguard action of Tashkessan against the troops of Gourko. Promoted *Ferik* (lieutenant-general) for this feat, he continued to command Suleiman's rearguard with distinction. After the peace he was employed in an administrative post in Armenia, where he remained until 1882. In this year he was offered the command of the newly formed Egyptian army, which he accepted. On his arrival at Cairo, however, the offer was withdrawn, and he only obtained the command of the Egyptian police. In this post he devoted by far the greater amount of his energy to the training of the gendarmerie, which he realized would be the reserve of the purely military forces.

When the Sudan War broke out, Baker, hastening with 3500 men to relieve Tokar, encountered the enemy under Osman Digna at El Teb. His men became panic-stricken at the first rush and allowed themselves to be slaughtered like sheep. Baker himself with a few of his officers succeeded by hard fighting in cutting a way out, but his force was annihilated. British troops soon afterwards arrived at Suakin, and Sir Gerald Graham took the offensive. Baker Pasha accompanied the British force, and guided it in its march to the scene of his defeat, and at the desperately-fought second battle of El Teb he was wounded. He remained in command of the Egyptian police until his death in 1887. Amongst his works may be mentioned *Our National Defences* (1860), *War in Bulgaria, a Narrative of Personal Experience* (London, 1870), *Clouds in the East* (London, 1876).

BAKER CITY, a city and the county-seat of Baker county, Oregon, U.S.A., about 337 m. E. by S. of Portland. Pop. (1890,

2604; (1000) 6663 (1017 foreign-born); (1910) 6742. The city is served by the Oregon Railroad & Navigation Company, and by the Sumpter Valley railway, a short line (62 m.) extending from Baker City to Austin, Oregon. Baker City lies in the valley of Powder river, at the base of the Blue Mountains, and has an elevation of about 3440 ft. above the sea. It is the largest city in eastern Oregon, and is the centre of important mining, lumber, farming and live-stock interests. It was laid out as a town in 1865, became the county-seat in 1868, and was chartered as a city in 1874. The county and the city were named in honour of Edward Dickinson Baker (1811-1861), a political leader, orator and soldier, who was born in London, England, was taken to the United States in 1815, was a representative in Congress from Illinois in 1845-1846 and 1849-1851, served in the Mexican War as a colonel (1846-1847), became a prominent lawyer in California and later in Oregon, was a Republican member of the United States Senate in 1860-1861 and was killed at Ball's Bluff, Virginia, on the 21st of October in 1861, while serving as a colonel in the Federal army.

BAKEWELL, ROBERT (1725-1795) English agriculturist, was born at Dishley, Leicestershire, in 1725. His father, a farmer at the same place, died in 1760, and Robert Bakewell then took over the management of the estate. By visiting a large number of farms all over the country, he had already acquired a wide theoretical knowledge of agriculture and stock-breeding; and this knowledge he now put to practical use at Dishley. His main object was to improve the breed of sheep and oxen, and in this he was highly successful, his new Leicestershire breed of sheep attaining within little more than half a century an international reputation, while the Dishley cattle (also known as the new Leicestershire long-horn) became almost as famous. He extended his breeding experiments to horses, producing a new and particularly useful type of farm-horse. He was the first to establish the trade in ram-letting on a large scale, and founded the Dishley Society, the object of which was to ensure purity of breed. The value of his own stock was quickly recognized, and in one year he made 1200 guineas from the letting of a single ram. Bakewell's agricultural experiments were not confined to stock-breeding. His reputation stood high in every detail of farm-management, and as an improver of grass land by systematic irrigation he had no rival. He died on the 1st of October 1795.

BAKEWELL, ROBERT (1768-1843), English geologist, was born in 1768. He was an able observer, and deserving of mention as one of the earliest teachers of general and practical geology. His *Introduction to Geology* (1813) contained much sound information, and reached a fifth edition in 1838. The second edition was translated and published in Germany, and the third and fourth editions were reprinted in America by Professor Silliman of Yale College. Bakewell as author also of an *Introduction to Mineralogy* (1810), and of *Travels comprising Observations made during a Residence in the Tarentaise, &c.* (2 vols., 1823). He died at Hampstead on the 15th of August 1843.

BAKEWELL, a market-town in the western parliamentary division of Derbyshire, England, on the river Wye, 25 m. N.N.W. of Derby, on the Midland railway. Pop. of urban district (1901) 2850. The church of All Saints is mentioned in Domesday, and tradition ascribes the building of its nave to King John, while the western side of the tower must be older still. Within are some admirable specimens of encaustic tiles, and several monuments of the Vernon and Manners families; while an ancient runic roost-stone stands in the churchyard. Zinc and marble are worked in the neighbourhood. The cotton manufacture was established in the town by Sir Richard Arkwright. Bakewell is noted for a chalybeate spring, of use in cases of chronic rheumatism, and there are baths attached to it. A kind of jam-cake, called a "Bakewell pudding," gives another sort of fame to the place. The almshouses, known as St John's hospital, were founded in 1602; and in 1637 a free grammar school was endowed by Lady Grace Manners. Among modern buildings may be mentioned the Bakewell and High Peak Institute, and the town hall and museum. On Castle Hill, in the vicinity, are the remains of an earthwork, said to have been raised by Edward the Elder in 924. Within the parish are included the mansions of Burton Clouses

and Castle Hill. Two miles from the town, amidst beautiful gardens and meadows, is Haddon Hall. To the east lies the magnificent domain of Chatsworth. The scenery of the neighbourhood, in both the Wye and the Derwent valleys, is very beautiful; the village of Eyam (pronounced Eem) near the Derwent may be noticed as specially picturesque. The plague of 1665, carried hither from London, almost depopulated this village, and the name of the rector, William Mompesson, attracted wide notice on account of his brave attempts to combat the outbreak.

BAKHCHI-SARAI (Turk. for "garden-palace"), a town of Russia, in the government of Taurida, situated in a narrow gorge in the Crimea, 20 m. by rail S.S.W. of Simferopol. From the close of the 15th century down to 1783 it was the residence of the Tatar khans of the Crimea; and its streets wear a decidedly oriental look. The principal building, the palace, or *Khan-sarai*, was originally erected in 1519 by Abdul-Sahal-Ghirai, destroyed in 1736, and restored at Potemkin's command for the reception of Catherine II. Attached to it is a mausoleum, which contains the tombs of many of the khans. There are in the place no fewer than thirty-six mosques. The population consists for the most part of Tatars. Bakhchi-sarai manufactures morocco, sheep-skin cloaks, agricultural implements, sabres and cutlery. Pop. (1897) 12,955. Two and a half miles to the east is Chufut-Kaleh (or Jews' city), formerly the chief seat of the Karaite Jews of the Crimea, situated on lofty and almost inaccessible cliffs; it is now deserted except by the rabbi. Between Bakhchi-sarai and Chufut-kaleh is the Uspenskiy monastery, clinging like a swallow's nest to the face of the cliffs, and the scene of a great pilgrimage on the 15th (20th) of August every year.

BAKHMUT, a town of Russia, in the government of Ekaterinoslav, near the river from which it derives its name, 136 m. E. of the town of Ekaterinoslav. It owed its origin in the latter half of the 17th century to the discovery of salt-springs, and now produces coal, salt, alabaster and quicksilver, and manufactures steel rails. Pop. (1897) 19,416.

BAKHTIÁRI, one of the great nomad tribes of Persia, whose camping-grounds are in the hilly district, known as the Bakhtiári province. This province extends from Chaharmahal (west of Isfahan) in the E., to near Shushter in the W., and separated from Luristan in the N. by the Dizful river (Ab i Diz), and in the S. touches Behbahan and Ram Hormuz. The Bakhtiári are divided into the two great divisions Haft-lang and Chahar-lang, and a number of branches and clans, and were known until the 15th century as the "Great Lurs," the "Little Lurs" being the tribes settled in the district now known as Luristan, with Khorremábád as capital. According to popular tradition the Lurs originally came from Syria in the 10th century, but it is now held that they were in Persia long, perhaps fifteen centuries, before. They speak the Lur language, a Persian dialect. The Bakhtiári number about 38,000 or 40,000 families, under 200,000 souls, while the area of the district occupied by them is about 25,000 sq. m. In the middle of the 19th century they could put 20,000 well-equipped horsemen into the field, but in consequence of misrule and long-lasting feuds between the different branches, which the government often fostered, or even instigated, the district has become poor, and it would now be difficult to find 4000 horsemen. The province is under the governor-general of Arabistan, and pays a yearly tribute of about £5000. The chiefs of the Bakhtiári in 1897, having obtained the shah's permission for improving the road between Shushter or Ahváz and Isfahan, an iron suspension bridge with a span of 120 ft. was erected over the Karun river at Gudar i Bulútek; another, with a span of 70 ft., over the Bázuft river at Pul i Amárat; and a stone bridge over the Karun at Do-pu-lán.

For accounts of the Bakhtiári see Mrs Bishop (Isabella Bird), *Journeys in Persia and Kurdistan* (London, 1893); C. de Bode, *Travels in Luristan* (London, 1841); Lord Curzon, *Persia and the Persian Question*, vol. ii. 283-303 (London, 1892); Sir H. Layard, *Early Adventures in Persia* (London, 1894). (A. H.-S.)

BAKING, the action of the verb "to bake," a word, in various forms, common to Teutonic languages (cf. Ger. *backen*), meaning to cook by dry heat. "Baking" is thus primarily applied to

the process of preparing bread, and is also applied to the hardening by heat or "firing" of pottery, earthenware or bricks. (See **BREAD**; **CERAMICS** and **BRICK**.)

BAKIS (i.e. "speaker," from βᾶζω), a general name for the inspired prophets and dispensers of oracles who flourished in Greece from the 8th to the 6th century B.C. Suidas mentions three: a Boeotian, an Arcadian and an Athenian. The first, who was the most famous, was said to have been inspired by the nymphs of the Corycian cave. His oracles, of which specimens are extant in Herodotus and Pausanias, were written in hexameter verse, and were considered to have been strikingly fulfilled. The Arcadian was said to have cured the women of Sparta of a fit of madness. Many of the oracles which were current under his name have been attributed to Onomacritus.

Herodotus viii. 20, 77, ix. 43; Pausanias iv. 27, ix. 17, x. 12; Schol. Aristoph. *Pax*, 1070; see Götting, *Opuscula Academica* (1869).

BAKÓCZ, TAMÁS, CARDINAL (1442-1521), Hungarian ecclesiastic and statesman, was the son of a wagoner, adopted by his uncle, who trained him for the priesthood and whom he succeeded as rector of Tétel (1480). Shortly afterwards he became one of the secretaries of King Matthias I., who made him bishop of Győr and a member of the royal council (1490). Under Wladislaus II. (1490-1516) he became successively bishop of Eger, the richest of the Hungarian sees, archbishop of Esztergom (1497), cardinal (1500), and titular patriarch of Constantinople (1510). From 1490 to his death in 1521 he was the leading statesman of Hungary and mainly responsible for her foreign policy. It was solely through his efforts that Hungary did not accede to the league of Cambrai, was consistently friendly with Venice, and formed a family compact with the Habsburgs. He was also the only Magyar prelate who seriously aspired to the papal throne. In 1513, on the death of Julius II., he went to Rome for the express purpose of bringing about his own election as pope. He was received with more than princely pomp, and all but succeeded in his design, thanks to his extraordinary adroitness and the command of an almost unlimited bribing-fund. But Venice and the emperor played him false, and he failed. He returned to Hungary as papal legate, bringing with him the bull of Leo X. proclaiming a fresh crusade against the Turks. But the crusade degenerated into a *jaquerie* which ravaged the whole kingdom, and much discredited Bakócz. He lost some of his influence at first after the death of Wladislaus, but continued to be the guiding spirit at court, till age and infirmity confined him almost entirely to his house in the last three years of his life. Bakócz was a man of great ability but of no moral principle whatever. His whole life was a tissue of treachery. He was false to his benefactor Matthias, false to Matthias's son János Corvinus (q.v.), whom he chicaned out of the throne, and false to his accomplice in that transaction, Queen Beatrice. His rapacity disgusted even an age in which every one could be bought and sold. His attempt to incorporate the wealthy diocese of Transylvania with his own primate province was one of the principal causes of the spread of the Reformation in Hungary. He left a fortune of many millions. His one redeeming feature was a love of art; his own cathedral was a veritable Pantheon.

See Vilmos Fraknoi, *Tamás Bakócz* (Hung.) (Budapest, 1886).

(R. N. B.)

BAKRI [Abū 'Uбайд 'Abdallah ibn 'Abd ul-'Aziz ul-Bakri], (1040-1094), Arabian geographer, was born at Cordova. His best-known work is the dictionary of geographical names which occur in the poets, with an introduction on the seats of the Arabian tribes. This has been edited by F. Wüstenfeld (Göttingen, 1876-1877). Another of his works was a general geography of the world, which exists in manuscript. The part referring to North Africa was edited by M'G. de Slane (Algiers, 1857).

See C. Brockelmann's *Gesch. der Arab. Litteratur* (Weimar, 1898), vol. i. p. 476.

BAKU, a government of Russian Transcaucasia, stretching along the west coast of the Caspian Sea from 41° 50' to 38° 30' N. lat., and bounded on the W. by the government of Elisavetpol and the province of Daghestan, and on the S. by Persia. It

includes the Kuba plain on the north-east slope of the Caucasus; the eastern extremity of that range from the Shad-dagh (13,960 ft.) and the Bazardaryuz (14,727 ft.) to the Caspian, where it terminates in the Apsheron peninsula; the steppes of the lower Kura and Aras on the south of the Caucasus, and a narrow coast-belt between the Anti-Caucasus and the Caspian. The last-mentioned region lies partly round the Kizil-agach Bay, opening to the south. Area of government, 15,172 sq. m. Both slopes of the Caucasus are very fertile and well irrigated, with fine forests, fields of rice and other cereals, and flourishing gardens. The steppes of the Kura are also fertile, but require artificial irrigation, especially for cotton. In addition to agriculture and cattle-breeding, the vine and mulberry are extensively grown. The Apsheron peninsula is dry and bare of vegetation; but within it are situated the famous petroleum wells of Baku. These, which go down to depths of 700 to 1700 ft., yield crude naphtha, from which the petroleum or kerosene is distilled; while the heavier residue (*mazut*) is used as lubricating oil and for fuel, for instance in the locomotives of the Transcaspien railway. Whereas in 1863 the output was only 5500 tons of crude naphtha, in 1904 it amounted to 9,833,600 tons; but business was much injured by a serious fire in 1905. The oil-fields lie around the town of Baku; the largest, that of Balakhany-Sabunchi-Romany (6 sq. m.), is 8½ m. north of the town; that of Bibi-Eybat, is 3½ m. south; the "black town" (Nobel's) is 2 m. south-east; and beyond the last names is the "white town" (Rothschild's). The lighter oil is conveyed to Batum on the Black Sea in pipes, and is there shipped for export; the heavier oils reach the same port and the ports of Novorossysk and Poti, also on the Black Sea, in tank railway-cars. At Surakhani, 13 m. east of the town, is the now disused temple of the Parsee fire-worshippers, who were attracted thither by the natural fountains of inflammable gas.

The government is divided into six districts, the chief towns of which are Baku (the capital of the government), Geok-chai (pop. 2247 in 1897), Kuba (15,346), Lenkoran (8768), Salyany (10,168), in district of Jevat, and Shemakha (20,008). The population numbered 828,511 in 1897, of whom the major part were Tatars; other races were Russians, the Iranian tribes of the Tates (89,519) and Talysh (34,994), Armenians (52,233) and the Caucasian mountaineers known as Kurins.

BAKU, the chief town of the government of the same name, in Russian Transcaucasia, on the south side of the peninsula of Apsheron, in 40° 21' N. and 49° 50' E. It is connected by rail with the south Russian railway system at Beslan, the junction for Vladikavkaz (400 m.), via Derbent and Petrovsk, with Batum (560 m.) and Poti (536 m.) on the Black Sea via Tiflis. A long stone quay next the harbour is backed by the new town climbing up the slopes behind. To the west is the old town, consisting of steep, narrow, winding streets, and presenting a decidedly oriental appearance. Here are the ruins of a palace of the native khans, built in the 16th century; the mosques of the Persian shahs, built in 1078 and now converted into an arsenal; nearer the sea the "maidens' tower," transformed into a lighthouse; and not far from it remains of ancient walls projecting above the sea, and showing traces of Arabic architecture of the 9th and 10th centuries. Beside the harbour are engineering works, dry docks and barracks, stores and workshops belonging to the Russian Caspian fleet. Besides the petroleum refineries the town possesses oil-works (for fuel), flour-mills, sulphuric acid works and tobacco factories. Owing to its excellent harbour Baku is a chief depot for merchandise coming from Persia and Transcaspiā—raw cotton, silk, rice, wine, fish, dried fruit and timber—and for Russian manufactured goods. The climate is extreme, the mean temperature for the year being 58° F., for January 38°, for July 80°; annual rainfall 9.4 in. A wind of exceptional violence blows sometimes from the N.N.W. in winter. Pop. (1860) 13,381; (1897) 112,253; (1900) 179,133. The town is mentioned by the Arab geographer, Masudi, in the 10th century. From 1500 it was in the possession of the Persians. The Russians captured it from them in 1723, but restored it in 1735; it was incorporated in the Russian empire in 1806. In 1904-1905,

in consequence of the general political anarchy, serious conflicts took place here between the Tatars and the Armenians, and two-thirds of the Balakhani and Bibi-Eybat oil-works were burned.

See Marvin, *The Region of the Eternal Fire* (ed. 1891) and J. D. Henry, *Baku, an Essential History* (1906). (P. A. K.)

BAKUNIN, MIKHAIL (1814-1876), Russian anarchist, was born of an aristocratic family at Torjok, in the government of Tver, in 1814. As an officer of the Imperial Guard, he saw service in Poland, but resigned his commission from a disgust of despotism aroused by witnessing the repressive methods employed against the Poles. He proceeded to Germany, studied Hegel, and soon got into touch with the leaders of the young German movement in Berlin. Thence he went to Paris, where he met Proudhon and George Sand, and also made the acquaintance of the chief Polish exiles. From Paris he journeyed to Switzerland, where he resided for some time, taking an active share in all socialistic movements. While in Switzerland he was ordered by the Russian government to return to Russia, and on his refusal his property was confiscated. In 1848, on his return to Paris, he published a violent tirade against Russia, which caused his expulsion from France. The revolutionary movement of 1848 gave him the opportunity of entering upon a violent campaign of democratic agitation, and for his participation in the Dresden insurrection of 1849 he was arrested and condemned to death. The death sentence, however, was commuted to imprisonment for life, and he was eventually handed over to the Russian authorities, by whom he was imprisoned and finally sent to eastern Siberia in 1855. He received permission to remove to the Amur region, whence he succeeded in escaping, making his way through Japan and the United States to England in 1861. He spent the rest of his life in exile in western Europe, principally in Switzerland. In 1866 he founded the Social Democratic Alliance, which, however, dissolved in the same year, and joined the International (*q.v.*). In 1870 he attempted a rising at Lyons on the principles afterwards expounded by the Paris Commune. At the Hague congress of the International in 1872 he was outvoted and expelled by the Marx party. He retired to Lugano in 1873 and died at Bern on the 13th of June 1876.

Nothing can be clearer or more frank and comprehensive in its destructiveness than the revolutionary anarchism of Bakunin. He rejects all the ideal systems in every name and shape, from the idea of God downwards; and every form of external authority, whether emanating from the will of a sovereign or from universal suffrage. "The liberty of man," he says in his *Dieu et l'État* (published posthumously in 1882) "consists solely in this, that he obeys the laws of nature, because he has himself recognized them as such, and not because they have been imposed upon him externally by any foreign will whatsoever, human or divine, collective or individual." In this way will the whole problem of freedom be solved. That natural laws be ascertained by scientific discovery, and the knowledge of them be universally diffused among the masses. Natural laws being thus recognized by every man for himself, he cannot but obey them, for they are the laws also of his own nature; and the need for political organization, administration and legislation will at once disappear. Nor will he admit of any privileged position or class, for "it is the peculiarity of privilege and of every privileged position to kill the intellect and heart of man. The privileged man, whether he be privileged politically or economically, is a man deprived in intellect and heart." "In a word, we object to all legislation, all authority, and all influence, privileged, patented, official and legal, even when it has proceeded from universal suffrage, convinced that it must always turn to the profit of a dominating and exploiting minority, against the interests of the immense majority enslaved." Bakunin's methods of realizing his revolutionary programme are not less frank and destructive than his principles. The revolutionist, as he would recommend him to be, is a consecrated man, who will allow no private interests or feelings, and no scruples of religion, patriotism or morality, to turn him aside from his mission, the aim of which is by all available means to overturn the existing society. (See ANARCHISM.)

BA-KWIRI, a Bantu nation of German Cameroon, West Africa. According to tradition they are migrants from the eastward. The "Brushmen," for that is the meaning of their name, are grouped in about sixty separate clans. They are a lively intelligent people, brave fighters and daring hunters, and in their love of songs, music and elocution are superior to many negro races. Their domestic affections are strongly developed. Their chief physical peculiarity is the great disparity between the size and complexion of the sexes, most of the women being much shorter and far lighter in colour than the men. The Ba-Kwiri are generous and open-handed among themselves; but the law of blood for blood is mercilessly fulfilled, even in cases of accidental homicide. Their religion is ancestor-worship blended with witchcraft and magic. They believe in good and evil spirits, those of the forests and seas being especially feared. In common with their neighbours the Dualla (*q.v.*) the Ba-Kwiri possess a curious drum language. By drum-tapping news is conveyed from clan to clan. Slaves and women are not allowed to master this language, but all the initiated are bound to repeat it so as to pass the messages on. The Ba-Kwiri have also a horn language peculiar to themselves.

BALA, a market-town and urban district of Merionethshire, N. Wales, at the north end of Bala Lake, 17 m. N.E. of Dolgellay (Dolgelley). Pop. (1901) 1554. It is little more than one wide street. Its manufactures are flannel, stockings, gloves and hosiery (for which it was well known in the 18th century). The Tower of Bala (some 30 ft. high by 50 diameter) is a tumulus or "moat-hill," formerly thought to mark the site of a Roman camp. The theological college of the Calvinistic Methodists and the grammar school (endowed), which was founded in 1712, are the chief features, together with the statue of the Rev. Thomas Charles, the distinguished theological writer, to whom was largely due the foundation of the British and Foreign Bible Society. Bala Lake, the largest in Wales (4 m. long by some $\frac{1}{2}$ m. wide), is subject to sudden and dangerous floods, deep and clear, and full of pike, perch, trout, eel and *gwyniad*. The *gwyniad* (*Caregonus*) is peculiar to certain waters, as those of Bala Lake, and is fully described by Thomas Pennant in his *Zoology* (1776).

The lake (*Llyn Tegid*) is crossed by the Dee, local tradition having it that the waters of the two never mix, like those of Alpheus and the sea.

BALAAM (עֲלֵף Bil'am; Βαλαάμ; Vg. *Balaam*; the etymology of the name is uncertain), a prophet in the Bible. Balaam, the son of Beor, was a Gentile seer; he appears in the history of the Israelites during their sojourn in the plains of Moab, east of Jordan, at the close of the Forty Years' wandering, shortly before the death of Moses and the crossing of the Jordan. Israel had conquered two kings of eastern Palestine—Sihon, king of the Amorites, and Og, king of Bashan. Balak, king of Moab, became alarmed, and sent for Balaam to curse Israel; Balaam came after some hesitation, but when he sought to curse Israel Yahweh compelled him to bless them.

The main passage concerning Balaam in Num. xxii-xxv.; it consists of a narrative which serves as a framework for seven oracular poems, the first four being of some length and the last three very brief. The story is doubtless based on ancient traditions, current in various forms; the Old Testament references are not wholly consistent.

The narrative in Num. xxii. ff. is held to be compiled with editorial additions from the two ancient documents (900-700 B.C.) commonly denoted by the symbols J and E. The distribution of the material between the two documents is uncertain; but some such scheme as the following is not improbable. The references to portions the origin of which is especially uncertain are placed in brackets ().

The present narrative, therefore, is not really a single continuous story, but may be resolved into two older accounts. In combining these two and using them as a framework for the poems, the compilers have altered, added and omitted. Naturally, when both documents made statements which were nearly identical, one might be omitted; so that neither account need be given in full in the composite passage. The two older accounts,

as far as they are given here, may have run somewhat thus: restorations of supposed omissions are given in square brackets [].

(i) J. xlii. 3b-5a to "Beor" (5c to "to the land"—7, 11, 17, 18). Balak, king of Moab, alarmed at the Israelite conquests, sends *elders* of Moab and Midian to Balaam, son of Beor, to the land of Ammon, to induce him to come and curse Israel. He sends back word that he can only do what Yahweh commands.

The land of Ammon. The current Hebrew Text has the land of *ammo*, i.e. as EV, "his people," but Ammon is read by the Samaritan Pentateuch, the Syriac and Vulgate Versions and some Hebrew MSS., and is accepted by many modern scholars.

xxii. 22-35a to "Balaam," also "Go" and "So Balaam went." Nevertheless Balaam sets out with two servants to go to Balak, but the Angel of Yahweh meets him. At first the Angel is seen only by the ass, which arouses Balaam's anger by its efforts to avoid the Angel. The ass is miraculously enabled to speak to Balaam. Yahweh at last enables Balaam to see the Angel, who tells him that he would have slain him but for the ass. Balaam offers to go back, but is told to go on.

Speaking animals are a common feature of folk-lore; the only other case in the Old Testament is the serpent in Eden. Maimonides suggested that the episode of the Angel and the conversation with the ass is an account of a vision; similar views have been held by E. W. Hengstenberg and other Christian scholars. Others, e.g. Volk in Hauck's *Kaestlyklopädie* (s. "Bileam"), regard the statements about the ass speaking as figurative; the ass brayed, and Balaam translated the sound into words. The ordinary literal interpretation is more probable; but it does not follow that the authors of the Pentateuch intended the story to be taken as historical in its details. It need hardly be said that the exact accuracy of such narratives is not an essential part of the Christian faith; no such doctrine is laid down by the creeds and confessions.

xxii. 36, 39, xxiv. 1, 2, 10-14, 25. Balak meets Balaam and they go together, and offer sacrifices; Balaam, however, blesses Israel by divine inspiration; Balak remonstrates, but Balaam reminds him of his message and again blesses Israel. Then Balaam goes home. (For the relation of the poems to J's narrative, see below.)

(ii) E. xxii. 2, 3a, 5b "to Pethor, which is by the river," 8-10, 12-16, 19-21, 37a, to "unto me," 38. Balak, king of Moab, alarmed at the conquests of Israel, sends the princes of Moab to Balaam at Pethor on the Euphrates, that he might come and curse Israel.

A. Jeremias, *Das Alte Testament im Lichte des alten Orients*, p. 278, adopts Marquart's view that the "River" (*nahar*) is the so-called "River" (better "Ravine" *nahal*) of Egypt or Musis, on the southern frontier of Judea. So too Winckler, in the new edition of Schrader's *Die Keilinschriften und das Alte Testament*. It has been usual to keep *nahar* and take it in its ordinary sense when used absolutely, i.e. the Euphrates, and to identify Pethor with a Pithru on a tributary of the Euphrates, mentioned in an inscription of Salmeser II. Deut. xxiii. 4 places Pethor in Mesopotamia.

God appears to him in a dream and forbids him to go. The princes return and report to Balak, who sends them back to put further pressure on Balaam. God in another dream permits him to go, on condition that he speaks what God tells him. He goes with the *princes of Moab*. Balak meets them, and Balaam warns him that he can only speak what God tells him.

xxii. 40, 41, xxiii. 1-6, 11-17. Balak offers sacrifices, but Yahweh inspires Balaam with a blessing on Israel. Balak remonstrates and Balaam explains. They try to get a more favourable result by sacrificing on a different spot, and by placing Balaam on the top of Pisgah to view Israel, but he is again compelled to bless Israel. After further remonstrances and explanations [Balaam goes home]. (For the relation of the poems to E's narrative, see below.)

Deut. xxiii. 3-6¹ summarizes E's account of this incident, adding, however, the feature that the Ammonites were associated with the Moabites, possibly an imperfect reminiscence of the reference to Ammon in J. Joshua, in his farewell speech to the Israelites,² also refers to this episode. The Priestly Code³ has a different story of Balaam, in which he advises the *Midianites* how they may bring disaster on Israel by seducing the people

from their loyalty to Yahweh. Later on he is slain in battle, fighting in the ranks of Midian.

It is often supposed that the name of the king of Edom,⁴ Bela, son of Beor, is a corruption of Balaam, and that, therefore, one form of the tradition made him a king of Edom.

The *Poems* fall into two groups: the first four, in xxiii. 1-xxiv. 19, are commonly regarded as ancient lyrics of the early monarchy, perhaps in the time of David or Solomon, which J and E inserted in their narrative. Some recent critics,⁵ however, are inclined to place them in the post-exilic period, in which case a late editor has substituted them for earlier, probably less edifying, oracles. But the features which are held to indicate late date may be due to editorial revision.

The first two are found in an E setting, and therefore, if ancient, formed part of E.

The *First*, xxiii. 7-10, prophesies the unique exaltation of Israel, and its countless numbers.

The *Second*, xxiii. 18-24, celebrates the moral virtue of Israel, the monarchy and its conquests.

Again the second couple are connected with J.

The *Third*, xxiv. 3-9, also celebrates the glory and conquests of the monarchy.

Agag, in verse 7, can hardly be the Amalekite king of 1 Sam. xv.; Amalek was too small and obscure. The Septuagint and other Greek Versions and Sam. Pent. have *Gog*, which would imply a post-exilic date, cf. Ezek. xxxix. Probably both Agag and Gog are textual corruptions. *Og* has been suggested, but does not seem a great improvement.

The *Fourth*, xxiv. 14-19, announces the coming of a king, possibly David, who shall conquer Edom and Moab.

The remaining poems are usually regarded as later additions; thus the *Oxford Hexateuch* on Num. xxiv. 20-24. "The three concluding oracles seem irrelevant here, being concerned neither with Israel nor Moab. It has been thought that they were added to bring the cycle up to seven."

The *Fifth*, xxiv. 20, deals with the ruin of Amalek. It is of uncertain date; if the historical Amalek is meant, it may be early; but Amalek may be symbolical.

The *Sixth*, xxiv. 21 f., deals with the destruction of the Kenite state by Assyria; also of uncertain date, Assyria being, according to some, the ancient realm of Nineveh, according to others the Seleucid kingdom of Syria, which was also called Assyria.

The *Seventh*, xxiv. 23 f., speaks of the coming of ships from the West, to attack Assur and "Eber"; it may refer to the conquest of Persia by Alexander the Great. An interesting, but doubtful, emendation makes this poem describe the ruin of Shamal, a state in N. W. Syria.

In the New Testament Balaam is cited as a type of avarice;⁶ in Rev. ii. 14 we read of false teachers at Pergamum who held the "teaching of Balaam, who taught Balak to cast a stumbling-block before the children of Israel, to eat things sacrificed to idols, and to commit fornication."

Balaam has attracted much interest, alike from Jews, Christians and Mahomedans. Josephus⁷ paraphrases the story *more suo*, and speaks of Balaam as the best prophet of his time, but with a disposition ill adapted to resist temptation. Philo describes him in the *Life of Moses* as a great magician; elsewhere⁸ he speaks of "the sophist Balaam, being," i.e. symbolizing, "a vain crowd of contrary and warring opinions"; and again⁹ as "a vain people"; both phrases being based on a mistaken etymology of the name Balaam. The later Targums and the Talmud represent him as a typical sinner; and there are the usual worthless Rabbinical fables, e.g. that he was blind of one eye; that he was the Elihu of Job; that, as one of Pharaoh's counsellors, he was governor of a city of Ethiopia, and rebelled against Pharaoh; Moses was sent against him by Pharaoh at the head of an army, and stormed the city and put Balaam to flight, &c. &c.

⁴ Gen. xxxvi. 32.

⁵ For names and reasons, see Gray, *Numbers*, 314.

⁶ 2 Peter ii. 16, 17 (also refers to the ass speaking), Jude xi.

⁷ Ant. iv. 6. ⁸ *Quod. Det. Potiori*, § 20. ⁹ *De Cherub.*, § 10.

¹ Quoted Neh. xiii. 1 f. ² Josh. xxiv. 9, 10, E; cf. Micah vi. 5. ³ Num. xxxi. 8 (quoted Josh. xiii. 22). 16. These references are not necessarily inconsistent with JE; but they are probably based on an independent tradition. The date of the Priestly Code is ca. 400 B.C.

Curiously enough, the Rabbinical (Yalkut) identification of Balaam with Laban, Jacob's father-in-law, has been revived from a very different standpoint, by a modern critic.¹

The Mahomedans, also, have various fables concerning Balaam. He was one of the Anakim, or giants of Palestine; he read the books of Abraham, where he got the name Yahweh, by virtue of which he predicted the future, and got from God whatever he asked. It has been conjectured that the Arabic wise man, commonly called Luqmān (q.v.), is identical with Balaam. The names of their fathers are alike, and "Luqmān" means *devourer*, *swallower*, a meaning which might be got out of Balaam by a popular etymology.

If we might accept the various theories mentioned above, Balaam would appear in one source of J as an Edomite, in another as an Ammonite; in E as a native of the south of Judah or possibly as an Aramaean; in the tradition followed by the Priestly Code probably as a Midianite. All these peoples either belong to the Hebrew stock or are closely connected with it. We may conclude that Balaam was an ancient figure of traditions originally common to all the Hebrews and their allies, and afterwards appropriated by individual tribes; much as there are various St Georges.

The chief significance of the Balaam narratives for the history of the religion of Israel is the recognition by J and E of the genuine inspiration of a non-Hebrew prophet. Yahweh is as much the God of Balaam as he is of Moses. Probably the original tradition goes back to a time when Yahweh was recognized as a deity of a circle of connected tribes of which the Israelite tribes formed a part. But the retention of the story without modification may imply a continuous recognition through some centuries of the idea that Yahweh revealed his will to nations other than Israel.

Apparently the Priestly Code ignored this feature of the story.

Taking the narratives as we now have them, Balaam is a companion figure to Jonah, the prophet who wanted to go where he was not sent, over against the prophet who ran away from the mission to which he was called.

BIBLIOGRAPHY.—Ewald, *Geschichte des Volkes Israel*, Bd. II, p. 298; Hengstenberg's *Die Geschichte Bileams und seine Weissagungen* (1842); the commentaries on the scriptural passages, especially G. B. Gray on Numbers xxii.-xxiv.; and the articles on "Balaam" (Bileam) in Hamburger's *Realencyclopädie für Bibel und Talmud*, Hastings' *Bible Dict.*, Black and Cheyne's *Encyclopaedia Biblica*, Herzog-Hauck's *Realencyclopädie*. For the analysis into earlier documents, see also the *Oxford Hexateuch*, Estlin Carpenter and Harford-Battersby. (W. H. BE.)

BALĀDHURĪ (ABŪ-L-'ABBĀS AHMAD IBN YAḤYĀ IBN JĀBR AL-BALĀDHURĪ), Arabian historian, was a Persian by birth, though his sympathies seem to have been strongly with the Arabs, for Mas'ūdī refers to one of his works in which he refuted the Shu'ūbites (see ABŪ 'UBĀIDA). He lived at the court of the caliphs al-Mutawakkil and al-Musta'in and was tutor to the son of al-Mu'tazz. He died in 802 as the result of a drug called *balādhūr* (hence his name). The work by which he is best known is the *Futūḥ ul-Bulādān* (Conquests of Lands), edited by M. J. de Goeje as *Liber expugnations regionum* (Leiden, 1870; Cairo, 1901). This work is a digest of a larger one, which is now lost. It contains an account of the early conquests of Mahomet and the early caliphs. Balādhūrī is said to have spared no trouble in collecting traditions, and to have visited various parts of north Syria and Mesopotamia for this purpose. Another great historical work of his was the *Ansb̄ ul-Ashraf* (Genealogies of the Nobles), of which he is said to have written forty parts when he died. Of this work the eleventh book has been published by W. Ahlwardt (Greifswald, 1883), and another part is known in manuscript (see *Journal of the German Oriental Society*, vol. xxxviii, pp. 382-406). He also made some translations from Persian into Arabic. (G. W. T.)

BALAGHAT (i.e. "above the ghats or passes," the highlands), a district of British India in the Nagpur division of the Central Provinces. The administrative headquarters are at the town of Burha. The district contains an area of 2132 sq. m. It forms the eastern portion of the central plateau which divides the

province from east to west. These highlands, formerly known as the Raigarh Bichhā tract, remained desolate and neglected until 1866, when the district of Balaghat was formed, and the country opened to the industrious and enterprising peasantry of the Wainganga valley. Geographically the district is divided into three distinct parts:—(1) The southern lowlands, a slightly undulating plain, comparatively well cultivated and drained by the Wainganga, Bagh, Deo, Ghisri and Son rivers. (2) The long narrow valley known as the Mau Taluka, lying between the hills and the Wainganga river, and comprising a long, narrow, irregular-shaped lowland tract, intersected by hill ranges and peaks covered with dense jungle, and running generally from north to south. (3) The lofty plateau, in which is situated the Raigarh Bichhā tract, comprising irregular ranges of hills, broken into numerous valleys, and generally running from east to west. The highest points in the hills of the district are as follows:—Peaks above Lanji, 2300 or 2500 feet; Tepakgarh hill, about 2600 ft.; and Bhainsaghat range, about 3000 ft. above the sea. The principal rivers in the district are the Wainganga, and its tributaries, the Bagh, Nahra and Uskal; a few smaller streams, such as the Masmar, the Mahkara, &c.; and the Banjar, Halon and Jamunia, tributaries of the Nerbudā, which drain a portion of the upper plateau. In the middle of the 19th century the upper part of the district was an impenetrable waste. About that time one Lachman Naik established the first villages on the Paraswara plateau. But a handsome Buddhist temple of cut stone, belonging to some remote period, is suggestive of a civilization which had disappeared before historic times. The population in 1901 was 326,521, showing a decrease of 15% in the decade, due to the effects of famine. A large part of the area is still covered with forest, the most valuable timber-tree being *sal*. There are few good roads. The Gondia-Jubbulpore line of the Bengal-Nagpur railway traverses the Wainganga valley in the west of the district. The district suffered very severely from the famine of 1896-1897. It suffered again in 1900, when in April the number of persons relieved rose above 100,000.

BALAGUER, VICTOR (1824-1901), Spanish politician and author, was born at Barcelona on the 11th of December 1824, and was educated at the university of his native town. His precocity was remarkable; his first dramatic essay, *Pepin el jorobado*, was placed on the Barcelona stage when he was fourteen years of age, and at nineteen he was publicly "crowned" after the production of his second play, *Don Enrique el Dudivoso*. From 1843 to 1868 he was the chief of the Liberal party in Barcelona, and as proprietor and editor of *El Conseller* did much to promote the growth of local patriotism in Catalonia. But it was not till 1857 that he wrote his first poem in Catalan—a copy of verses to the Virgin of Montserrat. Henceforward he frequently adopted the pseudonym of "lo Trovador de Montserrat"; in 1859 he helped to restore the "Juegos Florales," and in 1861 was proclaimed *mestre de gay saber*. He was removed to Madrid, took a prominent part in political life, and in 1867 emigrated to Provence. On the expulsion of Queen Isabella, he returned to Spain, represented Manresa in the Cortes, and in 1871-1872 was successively minister of the colonies and of finance. He resigned office at the restoration, but finally followed his party in rallying to the dynasty; he was appointed vice-president of congress, and was subsequently a senator. He died at Madrid on the 14th of January 1901. Long before his death he had become alienated from the advanced school of Catalan nationalists, and endeavoured to explain away the severe criticism of Castile in which his *Historia de Cataluña y de la Corona de Aragón* (1860-1863) abounds. This work, like his *Historia política y literaria de los trovadores* (1878-1879), is inaccurate, partial and unscientific; but both books are attractively written and have done great service to the cause which Balaguer once upheld. As a poet he is imitative: reminiscences of Quintana are noticeable in his patriotic songs, of Zorrilla in his historical ballads, of Byron in his lyrical poems. He wrote too hastily to satisfy artistic canons; but if he has the faults he has also the merits of a pioneer, and in Catalonia his name will endure.

¹T. Steuernagel, *Einwanderung der israelitischen Stämme* (1901).

BALAKIREV, MILI ALEXEIVICH (1836—), Russian musical composer, was born at Nijni-Novgorod on the 31st of December 1836. He had the advantage as a boy of living with Oulibichev, author of a *Life of Mozart*, who had a private band, and from whom Balakirev obtained a valuable education in music. At eighteen, after a university course in mathematics, he went to St Petersburg, full of national ardour, and there made the acquaintance of Glinka. Round him gathered César Cui (b. 1835), and others, and in 1862 the Free School of Music was established, by which, and by Balakirev's personal zeal, the modern school of Russian music was largely stimulated. In 1869 Balakirev was appointed director of the imperial chapel and conductor of the Imperial Musical Society. His influence as a conductor, and as an organizer of Russian music, give him the place of a founder of a new movement, apart even from his own compositions, which though few in number are remarkable in themselves. His works consist largely of songs and collections of folk-songs, but include a symphony (first played in England in 1901), two symphonic poems ("Russia" and "Tamara"), and four overtures, besides pianoforte pieces. His orchestral works are of the "programme-music" order, but all are brilliant examples of the highly coloured, elaborate style characteristic of modern Russian composers, and developed by Balakirev's disciples, such as Borodin and Rimsky-Korsakov.

BALAKLAVA, a village in the Crimea, east of Sevastopol, famous for a battle in the Crimean War. The action of Balaklava (October 25th, 1854) was brought about by the advance of a Russian field army under General Liprandi to attack the allied English, French and Turkish forces besieging Sevastopol. The ground on which the engagement took place was the Vorontsov ridge (see CRIMEAN WAR), and the valleys on either side of it. Liprandi's corps formed near Traktir Bridge, and early on the 25th of October its advanced guard moved southward to attack the ridge, which was weakly occupied by Turkish battalions behind slight entrenchments. The two nearest British divisions were put into motion as soon as the firing became serious, but were prevented by their orders from descending at once into the plain, and the Turks had to meet the assault of greatly superior numbers. They made a gallant resistance, but the Russians quickly cleared the ridge, capturing several guns, and their first line was followed by a heavy mass of cavalry which crossed the ridge and descended into the Balaklava plain. At this moment the British cavalry division under the earl of Lucan was in the plain, but their commander was prevented from engaging the Russians by the tenor of his orders. One of his brigades, the Heavy (4th and 5th Dragoon Guards, 1st, 2nd and 6th Dragoons) under Brigadier-General J. Y. Scarlett, was in the Balaklava plain; the other, the Light Brigade under Lord Cardigan (4th and 13th Light Dragoons now Hussars, 8th and 11th Hussars and 17th Lancers) in the valley to the north of the Vorontsov ridge. All these regiments were very weak in numbers. The Russian cavalry mass, after crossing the ridge, moved towards Balaklava; a few shots were fired into it by a Turkish battery and a moment later the Heavy Brigade charged. The attack was impeded at first by obstacles of ground, but in the *mêlée* the weight of the British troopers gradually broke up the enemy, and the charge of the 4th Dragoon Guards, delivered against the flank of the Russian mass, was decisive. The whole of the Russian cavalry broke and fled to the ridge. This famous charge occupied less than five minutes from first to last, and at the same time some of the Russian squadrons, attempting to charge the 93rd Highlanders (who were near Balaklava) were met by the steady volleys of the "thun red line," and fled with the rest. The defeated troops retreated past the still inactive Light Brigade, on whose left a French cavalry brigade was now posted. The Russians were at this juncture reinforced by a mixed force on the Fedukhine heights; Liprandi's infantry occupied the captured ridge, and manned the guns taken from the Turks. The cavalry defeated by the Heavy Brigade was re-formed in the northern valley behind the field guns, and infantry, cavalry and artillery were on both the Fedukhine and the Vorontsov heights. Thus, in front of the

was the enemy's cavalry and twelve guns, and on the ridges on either side there were in all twenty-two guns, with cavalry and infantry. It was under these circumstances that an order was given by the British headquarters, which led to the charge for which above all Balaklava is remembered. It was carried to Lord Lucan by Captain L. E. Nolan, 15th Hussars, and ran as follows:—"Lord Raglan wishes the cavalry to advance rapidly to the front and try to prevent the enemy carrying away the guns. . . . French cavalry is on your left." Lucan, seeing no attempt on the part of the enemy to move guns, questioned Nolan, who is said to have pointed down the valley to the artillery on the plain; whereupon Lucan rode to Lord Cardigan, the commander of the Light Brigade, and repeated Lord Raglan's order and Nolan's explanation. The Light Brigade then advanced straight to its front, and soon came under fire from the guns on both flanks. Nolan was killed as he rode across the front of the brigade, perhaps with the intention of changing its direction to the Vorontsov ridge. Five minutes later the guns in front began to fire with telling effect. The pace was increased, though the "charge" was not sounded, and Cardigan and those of his men who remained mounted, rode up to and through the Russian line of guns. Small parties even charged the Russian cavalry in rear and on either flank. The French 4th *Chasseurs d'Afrique* made a dashing charge which drove the Russians off the Fedukhine heights, though at considerable loss. Lucan had meanwhile called up the Heavy Brigade to support the Light, but it lost many men and horses and was quickly withdrawn. Only two formed bodies of the Light Brigade found their way back. The 13th Light Dragoons mustered but ten mounted men at the evening parade; the brigade as a whole had lost 247 men and 407 horses out of a total strength of 673 engaged in the charge, which lasted twenty minutes from first to last. The two infantry divisions which now approached the field were again halted, and Liprandi was left undisturbed on the Vorontsov ridge and in possession of the captured guns. The result of the day was thus unfavourable to the allies, but the three chief incidents of the engagement—the two cavalry charges and the fight of the 93rd Highlanders—gave to it all the prestige of a victory. The impression created by the conduct of the Light Brigade was forcibly expressed in Tennyson's well-known ballad, and in spite of the equally celebrated remark of the French general Bosquet, *C'est magnifique mais ce n'est pas la guerre*, it may be questioned whether the moral effect of the charge did not outweigh the very serious loss in trained men and horses involved.

BALALAIKA, a stringed instrument said to have retained its primitive form unchanged, very popular in Russia among the peasants, more especially in Ukraine. The instrument has a triangular soundboard to which is glued a vaulted back, forming a body having a triangular base, enabling it to stand upright. To the body is added a fretted neck strung with two, three or four strings, generally so tuned as to produce a minor chord when sounded together. The strings are generally plucked with the fingers, but the peasants obtain charming "glissando" effects by sweeping the strings lightly one after the other with the fingers or side of the hand. The Balalajka is common to the Slav races, who use it to accompany their folk-songs and dances. It is also to be seen in the hands of gipsies at rural festivities and fairs.

BALANCE (derived through the Fr. from the Late Lat. *bilantia*, an apparatus for weighing, from *bi*, two, and *lanx*, a dish or scale), a term originally used for the ordinary beam balance or weighing machine with two scale pans, but extended to include (with or without adjectival qualification) other apparatus for measuring and comparing weights and forces. In addition to beam and spring balances (see WEIGHING MACHINES), apparatus termed "torsion balances," in which forces are measured or compared by their twisting moment on a wire, are used, especially in gravitational, electrostatic and magnetic experiments (see GRAVITATION and ELECTROMETER). The term also connotes the idea of equality or equalization; e.g. in the following expressions: "balance," in bookkeeping, the amount which equalizes the debit and credit accounts; "balance wheel,"

in horology, a device for equalizing the relaxing of a watch or clock spring (see CLOCK); the "balancing of engines," the art of minimizing the total vibrations of engines when running, and consisting generally in the introduction of masses which induce vibrations opposed to the vibrations of the essential parts of the engine.

BALANCE OF POWER, a phrase in international law for such a "just equilibrium" between the members of the family of nations as should prevent any one of them from becoming sufficiently strong to enforce its will upon the rest. The principle involved in this, as Hume pointed out in his *Essay on the Balance of Power*, is as old as history, and was perfectly familiar to the ancients both as political theorists and as practical statesmen. In its essence it is no more than a precept of commonsense born of experience and the instinct of self-preservation; for, as Polybius very clearly puts it (lib. i. cap. 83): "Nor is such a principle to be despised, nor should a great power be allowed to any one as to make it impossible for you afterwards to dispute with him on equal terms concerning your manifest rights." It was not, however, till the beginning of the 17th century, when the science of international law took shape at the hands of Grotius and his successors, that the theory of the balance of power was formulated as a fundamental principle of diplomacy. According to this the European states formed a sort of federal community, the fundamental condition of which was the preservation of the balance of power, i.e. such a disposition of things that no one state or potentate should be able absolutely to predominate and prescribe laws to the rest; and, since all were equally interested in this settlement, it was held to be the interest, the right and the duty of every power to interfere, even by force of arms, when any of the conditions of this settlement were infringed or assailed by any other member of the community.¹ This principle, once formulated, became an axiom of political science. It was impressed as such by Fénelon, in his *Instructions*, on the young duke of Burgundy; it was proclaimed to the world by Frederick the Great in his *Anti-Machiavel*; it was re-stated with admirable clearness in 1806 by Friedrich von Gentz in his *Fragments on the Balance of Power*. It formed the basis of the coalitions against Louis XIV. and Napoleon, and the occasion, or the excuse, for most of the wars which desolated Europe between the congress of Münster in 1648 and that of Vienna in 1814. During the greater part of the 19th century it was obscured by the series of national upheavals which have remodelled the map of Europe; yet it underlay all the efforts of diplomacy to stay or to direct the elemental forces let loose by the Revolution, and with the restoration of comparative calm it has once more emerged as the motive for the various political alliances of which the ostensible object is the preservation of peace (see EUROPE: History).

An equilibrium between the various powers which form the family of nations is, in fact,—as Professor L. Oppenheim (*Internat. Law*, i. 73) justly points out—essential to the very existence of any international law. In the absence of any central authority, the only sanction behind the code of rules established by custom or defined in treaties, known as "international law," is the capacity of the powers to hold each other in check. Were this to fail, nothing could prevent any state sufficiently powerful from ignoring the law and acting solely according to its convenience and its interests.

See, besides the works quoted in the article, the standard books on International Law (q.v.). (W. A. P.)

BALANCE OF TRADE, a term in economics belonging originally to the period when the "mercantile theory" prevailed, but still in use, though not quite perhaps in the same way as at its origin. The "balance of trade" was then identified with the sum of the precious metals which a country received in the course of its trading with other countries or with particular countries. There was no doubt an idea that somehow or other the amount of the precious metals received represented profit on the trading, and each country desired as much profit as possible. Princes and sovereigns, however, with political aims in view, were not

close students of mercantile profits, and would probably have urged the acquisition of the precious metals as an object of trade even if they had realized that the country as a whole was exporting "money's worth" in order to buy the precious metals which were desired for political objects. The "mercantile theory" was exploded by Adam Smith's demonstration that gold and silver were only commodities like others with no special virtue in them, and that they would come into a country when there was a demand for them, according to the amount, in proportion to other demands, which the country could afford to pay; but the ideas in which the theory itself has originated have not died out, and the idea especially of a "balance of trade" to which the rulers of a country should give attention is to be found in popular discussions of business topics and in politics, the general notion being that a nation is prosperous when its statistics show a "trade balance" in its favour and unprosperous when the reverse is shown. In modern times the excess of imports over exports or of exports over imports, shown in the statistics of foreign trade, has also come to be identified in popular speech with the "balance of trade," and many minds are no doubt imbued with the ideas (1) that an excess of imports over exports is bad, and (2) an excess of exports over imports is the reverse, because the former indicates an "unfavourable" and the latter a "favourable" trade balance. In the former case it is urged that a nation so circumstanced is living on its capital. Exact remedies are not suggested, although the idea of preventing or hampering foreign imports as a means of developing home trade and of thus altering the supposed disastrous trade balance is obviously the logical inference from the arguments. A consideration of these ideas and of recent discussions about imports and exports, appears accordingly to be needed, although the "mercantile theory" is itself exploded.

The phrase "balance of trade," then, appears to be an application of a trader's language in his own business to the larger affairs of nations or rather of the aggregate of individuals in a nation engaged in foreign trade. A trader in his own books sets his sales against his purchases, and the amount by which the former exceed the latter is his trade balance or profit. What is true of the individual, it is assumed, must be true of a nation or of the aggregate of individual traders in a nation engaged in the foreign trade. If their collective sales amount to more than their collective purchases the trade balance will be in their favour, and they will have money to receive. Contrariwise, if their purchases amount to more than their sales, they will have to pay money, and they will presumably be living on their capital. The argument fails, however, in many ways. Even as regards the experience of the individual trader, it is to be observed that he may or may not receive his profit, if any, in money. As a rule he does not do so. As the profit accrues he may invest it either by employing labour to add to his machinery or warehouses, or by increasing his stock-in-trade, or by adding to his book debts, or by a purchase of stocks or shares outside his regular business. At the end of a given period he may or may not have an increased cash balance to show as the result of his profitable trading. Even if he has an increased cash balance, according to the modern system of business, this might be a balance at his bankers', and they in turn may have invested the amount so that there is no stock of the precious metals, of "hard money," anywhere to represent it. And the argument fails still further when applied to the transactions between nations, or rather, to use the phrase already employed, between the aggregate of individuals in nations engaged in the foreign trade. It is quite clear that if a nation, or the individuals of a nation, do make profit in their foreign trading, the amount may be invested as it accrues—in machinery, or warehouses, or stock-in-trade, or book debts, or stocks and shares purchased abroad, so that there may be no corresponding "balance of trade" to bring home. There is no doubt also that what may be in reality what largely happens. A prosperous foreign trade carried on by any country implies a continuous investment by that country either abroad or at home, and there may or may not be a balance receivable in actual gold and silver.

¹ Emerich de Vattel, *Le Droit des gens* (Leiden, 1758).

In another particular the argument also fails. In the aggregate of individual trading with various countries, there may sometimes be purchases and sales as far as the individuals are concerned, but not purchases and sales as between the nations. For example, goods are exported from the United Kingdom, ammunition and stores and ships, which appear in the British returns as exports, and which have really been sold by individual British traders to individuals abroad; but these sales are not set off by any purchases on the other side which come into the international account, as the set-off is a loan by the people of one country to the people or government of another. The same with the export of railway and other material when goods are exported for the purpose of constructing railways or other works abroad. The sales are made by individuals in the United Kingdom to individuals abroad; but there is no set-off of purchases on the other side. *Mutatis mutandis* the same explanation applies to the remittance of goods by one country to another, or by individuals in one country to individuals in another to pay the interest or repay the capital of loans which have been received in former times. These are all cases of the movement of goods irrespective of international sales and purchases, though the movements themselves appear in the international records of imports and exports, and therefore it seems to be assumed, though without any warrant, in the international records of the balance of trade. There is yet another failure in the comparison. The individual trader would include in his sales and purchases services such as repairs performed by him for others, and similar services which others do for himself; but no similar accounts are kept of the corresponding portions of international trade such as the earning of freights and commissions, although in strictness, it is obvious, they belong as much to international trade as the imports and exports themselves, which cannot therefore show a complete "balance of trade."

The illusions which may result then from the confusion of ideas between a balance of trade or profit, and a balance of cash paid or received, and from the identification of an excess of imports over exports or of exports over imports with the balance of trade itself, though they are not the same things, hardly need description. The believers in such illusions are not entitled to any hearing as economists, however, much they may be accepted in the market-place or among politicians.

The "balance of trade" and "the excess of imports over exports" are thus simply pitfalls for the amateur and the unwary. On the statistical side, moreover, there is a good deal more to be urged in order to impress the student with care and attention. The records of imports and exports themselves may vary from the actual facts of international purchases and sales. The actual values of the goods imported and paid for by the nation may vary from the published returns of imports, which are, by the necessity of the case, only estimated values. And so with the exports. The actual purchases and sales may be something very different. A so-called sale may prove abortive through its not being paid for at all, the debtor failing altogether. In any case the purchases of a year may not be paid for by the sales of the year, and the "squaring" of the account may take a long time. Still more the estimates of value may be so taken as not to give even an approximately correct account as far as the records go. Thus in the plan followed in the United Kingdom imports are valued as at the port where they arrive and exports at the port where they are despatched from—a plan which so far places them on an equal footing for the purpose of striking a balance of trade. But in the import and export records of the United States a different plan is followed. The imports are no longer valued as at the port of arrival with the freight and other charges included, but as at the port of shipment. The results on the balance of trade drawn out must accordingly be quite different in the two cases. With other countries similar differences arise. To deduce then from records of imports and exports any conclusions as to the excess of imports or exports at different times is a work of enormous statistical difficulty. Excellent illustrations will be found in J. Holt Schooling's *British Trade Book* (1908).

The country which presents the most interesting questions in connexion with the study is the United Kingdom, with its largely preponderating foreign trade. Its annual imports and exports, excluding bullion, exceed 800 millions sterling, and the bullion one year with another is 100 millions more. Its excess of imports, moreover, between the middle and end of the 19th century gradually rose from a small figure to 180 millions sterling annually, and occasioned the popular discussion referred to respecting an "adverse" balance of trade, and particularly the belief existing in many quarters that the nation is living on its capital. The result has been a new investigation of the subject, so as to bring out and present the credits to which the country is entitled in its trade as a shipowner and commission merchant, and to exhibit at the same time the magnitude of British foreign investments, which cannot be less than 2000 millions sterling and must bring in an enormous annual income. Other countries such as France, Germany, Belgium, Holland, Denmark, Norway and Sweden, are in the same condition, though their foreign trade is not on the same scale, and similar rules apply to the reading of their import and export accounts. The United States is a conspicuous instance of a country which in the first decade of the 20th century was still in the position of a borrower and had a large excess of exports, though there were signs of a change in the opposite direction. New countries generally, such as Canada, Australia and the South American countries, resemble the United States. Comparisons are made difficult by the want of uniformity in the methods of stating the figures, but that different countries have to be grouped according as they are indebted or creditor countries is undeniable, and no study of the trade statistics is possible without recognition of the underlying economic circumstances.

In conclusion it may be useful to repeat the main propositions laid down as to the balance of trade. (1) A "balance of trade" to the individual trader, from whose experience the phrase comes, is not necessarily, as is supposed, a balance received or receivable in the precious metals. It may be invested as it accrues—in machinery, or warehouses, or stock-in-trade, or in book debts, or in stocks and shares or other property outside the trader's business, as well as in cash. (2) What is true of the individual trader is also true of the aggregate of individuals engaged in the foreign trade of a country. Cash is only one of the forms in which they may elect to be paid. (3) The imports and exports recorded in the statistical returns of a country do not correspond with the purchases and sales of individual traders, as the sales especially may be set off by loans, while the so-called imports may include remittances of interest and of capital repaid. (4) When capital is repaid the country receiving it need not be living on it, but may be investing it at home. (5) The foreign trading of countries may also comprise many transactions, such as the earning of freights and commissions, which ought to appear in a proper account showing a balance of trade, as similar transactions appear in an individual trader's account, but which are not treated as imports or exports in the statistical returns of a nation's foreign trade. (6) Import and export returns themselves are not the same as accounts of purchases and sales; the values are only estimates, and must not be relied on literally without study of the actual facts. (7) Import and export returns in different countries are not in all cases taken at the same point, there being important variations, for instance, in this respect between the returns of two great countries, the United Kingdom and the United States, which are often compared, but are really most difficult to compare. (8) The United Kingdom is a conspicuous instance of a country which has a great excess of imports over exports in consequence of its large lending abroad in former times; while its accounts are specially affected by the magnitude of its services as a trading nation carrying passengers and goods all over the world, which do not result, however, in so-called "exports." The United States, on the other hand, is a conspicuous instance of an indebted nation, which has or had until lately few or no sums to its credit in foreign trade except the visible exports. (9) The various countries of the world naturally fall into groups. The nations of western Europe, such as France, Germany, Belgium, Holland, Sweden and Norway, fall into a

group with Great Britain as creditor nations, while Canada, Australasia and the South American countries fall into a group with the United States as undeveloped and indebted countries. So also of other countries, each belongs naturally to one group or another. (10) The excess of imports or exports may vary indefinitely at different times according as a creditor country is receiving or lending at the time, or according as a debtor country is borrowing or paying off its debts at the time, but the permanent characteristics are always to be considered. (R.G.N.)

BALANOGLOSSUS, the general name given to certain peculiar, opaque, worm-like animals which live in an obscure life under stones, and burrow in the sand from between tide-marks down to the abyssal regions of the sea. Their colour is usually some tone of yellow with dashes of red, brown and green, and they frequently emit a pungent odour. The name has reference to the tongue-shaped muscular proboscis by which the animal works its way through the sand. The proboscis is not the only organ of locomotion, being assisted by the succeeding segment of the body, the buccal segment or collar. By the waves of contraction executed by the proboscis accompanied by inflation of the collar, progression is effected, sometimes with marvellous rapidity. The third body region or trunk may attain a great length, one or two feet, or even more, and is also muscular, but the truncal muscles are of subordinate importance in locomotion, serving principally to promote the peristaltic contractions of the body by which the food is carried through the gut. The function of alimentation is closely associated with that of locomotion, somewhat as in the burrowing earthworm; in the excavation of its burrows the sand is passed through the body, and any nutrient matter that may adhere to it is extracted during its passage through the intestine, the exhausted sand being finally ejected through the vent at the orifice of the burrow and appearing at low tide as a worm casting. In accordance with this manner of feeding, the mouth is kept permanently open and prevented from collapsing by a pair of skeletal cornua belonging to a sustentacular apparatus (the nuchal skeleton), the body of which lies within the narrow neck of the proboscis; the latter is inserted into the collar and surrounded by the anterior free flap of this segment of the body.

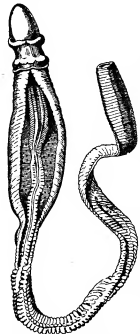

FIG. 1.—*Ptychodera flava* (New Caledonia), from above; about life size.

When first discovered by J. F. Eschscholtz at the Marshall Islands in 1825, *Balanoglossus* was described as a worm-like animal belonging to the Echinoderm order of Holothurians or sea-cucumbers. In 1865 Kowalevsky discovered that the organs of respiration consist of numerous pairs of gill-slits leading from the digestive canal through the thickness of the body-wall to the exterior. On this account the animal was subsequently placed by Gegenbaur in a special class of Vermes, the Enteropneusta. In 1883-1886 Bateson showed by his embryological researches that the Enteropneusta exhibit chordate (vertebrate) affinities in respect of the coelomic, skeletal and nervous systems as well as in regard to the respiratory system, and, further, that the gill-slits are formed upon a plan similar to that of the gill-slits of *Amphioxus*, being subdivided by tongue-bars which depend from the dorsal borders of the slits.

Coelom and Pore-canals.—In correspondence with the tri-regular differentiation of the body in its external configuration, the coelom (body-cavity, perivisceral cavity) is divided into three portions completely separated from one another by septa:—(1) proboscis-coelom, or first body-cavity; (2) the collar-coelom, or second body-cavity;

(3) truncal coelom, or third body-cavity. Of these divisions of the coelom the first two communicate with the exterior by means of a pair of ciliated pore-canals placed at the posterior end of their respective segments. The proboscis-pores are highly variable, and frequently only one is present, that on the left side; sometimes the pore-canals of the proboscis unite to open by a common median orifice, and sometimes their communication with the proboscis-coelom appears to be occluded, and finally the pore-canals may be quite vestigial. The collar-pores are remarkable for their constancy; this is probably owing to the fact that they have become adapted to a special function, the imbibition of water to render the collar turgid during progression. There are reasons for supposing that the truncal coelom was at one time provided with pore-canals, but supposed vestiges of these structures have only been described for one genus, *Spengelina*, in which they lie near the anterior end of the truncal coelom.

Enteron.—Not only is the coelom thus subdivided, but the enteron (gut, alimentary canal, digestive tube) itself shows indications of three main subsections in continuity with one another:—(1) proboscis-gut (*Eicheldarm*, stomach, *vide infra*); (2) collar-gut (buccal cavity, throat); (3) truncal gut extending from the collar to the vent.

Stomochord.—The proboscis-gut occurs as an outgrowth from the anterior dorsal wall of the collar-gut, and extends forward into the basal (posterior) region of the proboscis, through the neck into the proboscis-coelom, ending blindly in front. Although an integral portion of the gut, it has ceased to assist in alimentation, its epithelium undergoes vacuolar differentiation and hypertrophy, and its lumen becomes more or less vestigial. It has, in fact, become metamorphosed into a resistant supporting structure resembling in some respects the notochord of the true Chordata, but probably not directly comparable with the latter structure, being related to it solely by way of substitution. On account of the presence and mode of origin (from the gut-wall) of this organ Bateson introduced the term *hemichorda* as a phyletic name for the class Enteropneusta. As the proboscis-gut appears to have undoubtedly skeletal properties, and as it also has topographical relations with the mouth, it has been designated in English by the non-committal term *stomochord*. It is not a simple diverticulum of the collar-gut, but a complex structure possessing paired lateral pouches and a ventral convexity (ventral caecum) which rests in a concavity at the front end of the body of the nuchal skeleton (fig. 3). In some species (*Spengelidae*) there is a long capillary vermiform extension of the stomochord in front. The nuchal skeleton is a non-cellular laminated thickening of basement-membrane underlying that portion of the stomochord which lies between the above-mentioned pouches and the orifice into the throat. At the point where the stomochord opens into the buccal cavity the nuchal skeleton bifurcates, and the two cornua thus produced pass obliquely backwards and downwards to embed in the wall of the throat, often giving rise to projecting ridges that bound a dorsal groove of the collar-gut which is in continuity with the wall of the stomochord (fig. 3).

Nervous System.—At the base of the epidermis (which is in general ciliated) there is over the entire surface of the body a layer of nerve-fibres, occurring immediately outside the basement-membrane which separates the epidermis from the subjacent musculature. The nervous system is thus essentially epidermal in position and diffuse in distribution; but an interesting concentration of nerve-cells and fibres has taken place in the collar-region, where a medullary tube, closed in from the outside, opens in front and behind by anterior and posterior neuropores. This is the collar nerve-tube. Sometimes the central canal is wide and uninterrupted between the two neuropores; in other cases it becomes broken up into a large number of small closed medullary cavities, and in others again it is obsolete. In one family, the *Ptychodera*, the medullary tube of the collar is connected at intermediate points with the epidermis by means of a variable number of unpaired outgrowths from its dorsal wall, generally containing an axial lumen derived from and in continuity with the central canal. These hollow roots terminate blindly in the dorsal epidermis of the collar, and place the nervous layer of the latter in direct connexion with the fibres of the nerve-tube. The exact significance of these roots is a matter for speculation, but it seems possible that they are epiphyseal structures remotely comparable with the epiphyseal (pneusal) complex of the cranial vertebrates. In accordance with this view there would be also some probability in favour of regarding the collar nerve-tube of the Enteropneusta as the equivalent of the cerebral vesicle only of *Amphioxus* and the Ascidian tadpole, and also of the primary fore-brain of vertebrates.

Special thickenings of the diffuse nervous layer of the epidermis occur in certain regions and along certain lines. In the neck of the proboscis the fibrous layer is greatly thickened, and other intensifications of this layer occur in the dorsal and ventral middle lines of the trunk extending to the posterior end of the body. The dorsal epidermal nerve-tract is continued in front into the trunk, and in the collar nerve-tube and at the point of junction there is a circular commissural thickening following the posterior rim of the collar and affording a special connexion between the dorsal and ventral nerve-tracts. From the ventral surface of the collar nerve-tube numerous motor fibres may be seen passing to the subjacent musculature. These fibres are not aggregated into roots.

Gill-slits.—The possession of gill-slits is as interesting a feature in the organization of *Balanoglossus* as is the presence of tracheae in *Peripatus*. These gill-slits occupy a variable extent of the anterior portion of the trunk, commencing immediately behind the collar-trunk septum. The branchial bars which constitute the borders of the clefts are of two kinds:—(1) Septal bars between two contiguous clefts, corresponding to the primary bars in *Amphioxus*; (2) Tongue-bars. The chief resemblances

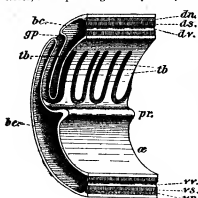

FIG. 2.—Structure of branchial region.

bc, coelom. gp, gill-pore.
tb, tongue-bars. dn, dorsal nerve.
ds, dorsal mesentery. dv, dorsal vessel.
pr, ridge. ae, oesophagus.
vr, vessel. vs, mesentery.
vn, ventral nerve.

Balanoglossus are double; (d) the tongue-bar in *Balanoglossus* does not fuse with the ventral border of the cleft, but ends freely below, thus producing a continuous U-shaped cleft. The meaning of this singular contrast between the two animals may be that we have here an instance of an interesting gradation in evolution. From serving primitively as the essential organ of the cleft the tongue-bar may have undergone reduction and modification, becoming a secondary bar in *Amphioxus*, subordinate to the primary bars in size, vascularity and development; finally, in the craniate vertebrates; it would then have completed its involution, the suggestion having been made that the tongue-bars are represented by the thymus-primordia.

Gill-pouches and Gill-pores.—Only rarely do the gill-slits open freely and directly to the exterior (fig. 1). In most species of *Balanoglossus* each gill-slit may be said to open into its own atrial chamber or gill-pouch; this in its turn opens to the exterior by a minute gill-pore. There are, therefore, as many gill-pouches as there are gill-slits and as many gill-pores as pouches. The gill-pores occur on each side of the dorsal aspect of the worm in a longitudinal series at the base of a shallow groove, the branchial groove. The respiratory current of water is therefore conducted to the exterior by different means from that adopted by *Amphioxus*, and this difference is so great that the theory which seeks to explain it has to postulate radical changes of structure, function and topography.

Excretory and Vascular Systems.—It seems likely that the coelomic pore-canal was originally excretory organs, but in the existing Enteropneusta the pore-canal (especially the collar canal) have, as we have seen, acquired new functions or become vestigial, and the function of excretion is now mainly accomplished by a structure peculiar to the Enteropneusta called the glomerulus, a vascular complex placed on either side of the anterior portion of the stomach, projecting into the proboscis-coelom. The vascular system itself is quite peculiar, consisting of lacunae and channels destitute of endothelium, situated within the thickness of the basement-membrane of the body-wall, of the gut-wall and of the mesenteries. The blood, which is a non-corporeal fluid, is propelled forwards by the contractile dorsal vessel and collected into the central blood sinus; this lies over the stomach, and is surrounded on three sides by a closed vesicle, with contractile walls, called the pericardium (*Hierablase*). By the pulsation of the pericardial vesicle (best observed in the larva) the blood is driven into the glomerulus, from which it issues by efferent vessels which effect a junction with the ventral (sub-intestinal) vessel in the trunk. The vascular system does not readily lend itself to morphological comparison between such widely different animals as *Balanoglossus* and *Amphioxus*, and the reader is therefore referred to the memoirs cited at the end of this article for further details.

Reproductive System.—The sexes are separate, and when mature are sometimes distinguished by small differences of colour in the genital region. Both male and female gonads consist of more or less lobulated hollow sacs connected with the epidermis by short ducts. In their disposition they are either uniserial, biserial or multiserial. They occur in the branchial region, and also extend to a variable distance behind it. In exceptional cases they are either confined to the branchial region or excluded from it. When

they are arranged in uniserial or biserial rows the genital ducts open into or near the branchial grooves in the region of the pharynx and in a corresponding position in the post-branchial region. An important feature is the occurrence in some species (*Ptychoderidae*) of paired longitudinal pleural or lateral folds of the body which are mobile, and can be approximated at their free edges so as to close in the dorsal surface, embracing both the median dorsal nerve-trachea and the branchial grooves with the gill-pores, so as to form a temporary peri-branchial and medullary tube, open behind where the folds cease. On the other hand, they can be spread out horizontally so as to expose their own upper side as well as the dorsal surface

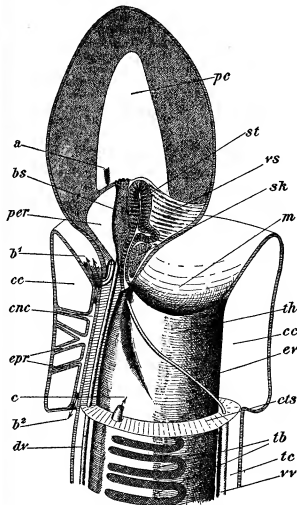

FIG. 3.—Structure of anterior end.

- a, Arrow from proboscis-cavity (pc) passing to left of pericardium (per) and out through proboscis-pore-canal.
b¹, arrow from central canal of neurochord (cnc) passed out through anterior neuropore.
b², ditto; through posterior neuropore.
c, arrow intended to pass from 1st gill-pouch through collar pore-canal into collar-coelom (cc).
cls, posterior limit of collar.
dv, dorsal vessel passing into central sinus (bs).
ev, efferent vessel passing into ventral vessel (vv).
ep, epipharyngeal tubes.
st, stomochord.
vs, ventral septum of proboscis.
sk, body of nuchal skeleton.
m, mouth.
th, throat.
tb, tongue-bars.
tc, trunk coelom.

of the body (fig. 1). These folds are called the genital pleurae because they contain the bulk of the gonads. Correlated with the presence of the genital pleurae there is a pair of vascular folds of the basement membrane proceeding from the dorsal wall of the gut in the post-branchial portion of the branchio-genital region, and from the dorsal angles made by the pleural folds with the body-wall in the pharyngeal border of the genital pleurae. These vascular membranes are called the lateral septa. Since there are many species which do not possess these genital pleurae, the question arises as to whether their presence or their absence is the more primitive condition. Without attempting to answer this question categorically, it may be pointed out that within the limits of the family (*Ptychoderidae*) which is especially characterized by their presence there are some species in

which the genital pleurae are quite obsolete, and yet lateral septa occur (e.g. *Psychodera ruficollis*), seeming to indicate that the pleural folds have in such cases been secondarily suppressed.

Development.—The development of *Balanoglossus* takes place according to two different schemes, known as direct and indirect, correlated with the occurrence in the group of two kinds of ova, large and small.

Direct development, in which the adult form is achieved without striking metamorphosis by a gradual succession of stages, seems to be confined to the family *Balanoglossidae*. The remaining two families of Enteropneusta, *Psychodoridae* and *Spengelidae*, contain species of which probably all pursue an indirect course of development, culminating in a metamorphosis by which the adult form is attained. In these cases the larva, called *Tornaria*, is pelagic and transparent, and possesses a complicated ciliated seam, the longitudinal ciliated band, often drawn out into convoluted bays and lapets. In addition to this ciliated band the form of the *Tornaria* is quite characteristic and unlike the adult. The *Tornaria* larva offers a certain similarity to larvae of Echinoderms (sea-urchins, star-fishes, and sea-cucumbers), and when first discovered was so described.

It is within the bounds of possibility that *Tornaria* actually does indicate a remote affinity on the part of the Enteropneusta to the Echinoderms, not only on account of its external form, but also by reason of the possession of a dorsal water-pore communicating with the anterior body-cavity. In the direct development Bateson showed that the three divisions of the coelom arise as pouches constricted off from the archenteron or primitive gut, thus resembling the development of the mesoblastic somites of *Amphioxus*. It would appear that while the direct development throws light upon the special form of organization of the Enteropneusta, the indirect development affords a clue to their possible derivation. However this may be, it is sufficiently remarkable that a small and circumscribed group like the Enteropneusta, which presents such a comparatively uniform plan of composition and of external form, should follow two such diverse methods of development.

Distribution.—Some thirty species of *Balanoglossus* are known, distributed among all the principal marine provinces from Greenland to New Zealand. The species which occurs in the English Channel is *Psychodera sarniensis*. The *Psychodoridae* and *Spengelidae* are predominantly tropical and subtropical, while the *Balanoglossidae* are predominant in the arctic and temperate in their distribution. One of the most singular facts concerning the geographical distribution of Enteropneusta has recently been brought to light by Benham, who found a species of *Balanoglossus*, *sensu stricto*, on the coast of New Zealand hardly distinguishable from one occurring off Japan. Finally, *Glandiceps abyssicola* (*Spengelidae*) was dredged during the "Challenger" expedition in the Atlantic Ocean off the coast of Africa at a depth of 2500 fathoms.

AUTHORITIES.—W. Bateson, "Memoirs on the Direct Development of *Balanoglossus*," *Quart. Journ. Micr. Sci.* (vols. xxiv-xxvi, 1886); W. Benham, "*Balanoglossus otogagensis*, n. sp.," *Q. J. M. S.* (vol. xlii, p. 497, 1895); Yves Delage and Ed. Hérouard, *Traité de zoologie comparée* (t. viii.), "Les Procordés" (1898); S. F. Harmer, "Note on the Name *Balanoglossus*," *Proc. Camb. Phil. Soc.* (x. p. 190, 1900); T. H. Morgan, "Memoirs on the Indirect Development of *Balanoglossus*," *Journ. Morph.* (vol. v, 1891, and vol. ix, 1894); W. E. Ritter, "*Harrimania maculosa*, a new Genus and Species of Enteropneusta from Alaska," Papers from the Harriman Alaska Expedition (ii.), *Proc. Washington Ac.* (ii. p. 111, 1900); J. W. Spengel, "Die Enteropneusten," *Eighteenth Monograph of the Fauna and Flora des Golfes von Neapel* (1893); A. Willey, "Enteropneusta from the South Pacific, with Notes on the West Indian Species," *Zool. Results* (Willey), part iii., 1899; see also *Q. J. M. S.* (vol. xlii, p. 223, 1899); J. P. Hill, "The Enteropneusta of Funafuti," *Mem. Austral. Mus.* (iii., 1897-1898); M. Caullery and F. Mesnil, "*Balanoglossus Kochleri*, n. sp. English Channel," *C. R. Soc. Biol.* (ii. p. 256 (1900)).

BALARD, ANTOINE JÉRÔME (1802-1876), French chemist, was born at Montpellier on the 30th of September 1802. He started as an apothecary, but taking up teaching he acted as chemical assistant at the faculty of sciences of his native town, and then became professor of chemistry at the royal college and school of pharmacy and at the faculty of sciences. In 1826 he discovered in sea-water a substance which he recognized as a previously unknown element and named *bromine*. The reputation brought him by this achievement secured his election as successor to L. J. Thénard in the chair of chemistry at the faculty of sciences in Paris, and in 1851 he was appointed professor of chemistry at the Collège de France, where he had M. P. E. Berthelot first as pupil, then as assistant and finally as colleague. He died in Paris on the 30th of April 1876. While the discovery of bromine and the preparation of many of its compounds was his most conspicuous piece of work, Balard was an industrious chemist on both the pure and applied sides. In his researches on the bleaching compounds of chlorine he was the first to advance the view that bleaching-powder is a double compound of calcium

chloride and hypochlorite; and he devoted much time to the problem of economically obtaining soda and potash from seawater, though here his efforts were nullified by the discovery of the much richer sources of supply afforded by the Stassfurt deposits. In organic chemistry he published papers on the decomposition of ammonium oxalate, with formation of oxamic acid, on amyl alcohol, on the cyanides, and on the difference in constitution between nitric and sulphuric ether.

BALA SERIES, in geology, a series of dark slates and sandstones with beds of limestone which occurs in the neighbourhood of Bala, Merionethshire, North Wales. It was first described by A. Sedgwick, who considered it to be the upper part of his Cambrian System. The series is now placed at the top of the Ordovician System, above the Llandovery beds. The Bala limestone is from 20 to 40 ft. thick, and is recognizable over most of North Wales; it is regarded as the equivalent of the Coniston limestone of the Lake District. The series in the type area consists of the Hirnant limestone, a thin inconstant bed, which is separated by 1400 ft. of slates from the Bala limestone, below this are more slates and volcanic rocks. The latter are represented by large contemporaneous deposits of tuff and felsitic lava which in the Snowdon District are several thousand feet thick. In South Wales the Bala Series contains the following beds in descending order:—the *Trinucleus seticornis* beds (Slade beds, Redhill shales and Sholeshook limestone), the Robeston Wathen beds, and the *Dicranograptus* shales. The typical graptolites are, in the upper part, *Dicellograptus anceps* and *D. complanatus*; in the lower part, *Pleurograptus linearis* and *Dicranograptus Clingani*. In Shropshire this series is represented by the Caradoc and Chirbury Series; in southern Scotland by the Hartfell and Ardmillar Series; and by similar rocks in Ireland. See CARADOC SERIES and ORDOVICIAN SYSTEM.

BALASH (in the Greek authors, Balas; the later form of the name Volgaes), Sassanian king in A.D. 484-488, was the brother and successor of Péroz, who had died in a battle against the Hephthalites (White Huns) who invaded Persia from the east. He put down the rebellion of his brother Zereh, and is praised as a mild and generous monarch, who made concessions to the Christians. But as he did nothing against his enemies, he was, after a reign of four years, deposed and blinded, and his nephew, Kavadh I., raised to the throne. (Ed. M.)

BALASORE, a town and district of British India, in the Orissa division of Bengal. The town is the principal one and the administrative headquarters of the district, and is situated on the right bank of the river Burabahal, about 7 m. from the sea-coast as the crow flies and 16 m. by the river. There is a station on the East Coast railway. The English settlement of Balasore, formed in 1642, and that of Pippli in its neighbourhood seven years earlier, became the basis of the future greatness of the British in India. The servants of the East India Company here fortified themselves in a strong position, and carried on a brisk investment in country goods, chiefly cottons and muslins. They flourished in spite of the oppressions of the Mahomedan governors, and when needful asserted their claims to respect by arms. In 1688, affairs having come to a crisis, Captain William Heath, commander of the company's ships, bombarded the town. In the 18th century Balasore rapidly declined in importance, on account of a dangerous bar which formed across the mouth of the river. At present the bar has 12 to 15 ft. of water at spring-tides, but not more than 2 or 3 ft. at low water in the dry season. Large ships have to anchor outside in the open roadstead. The town still possesses a large maritime trade, despite the silting-up of the river mouth. Pop. (1901) 20,880.

The district forms a strip of alluvial land between the hills and the sea, varying from about 9 to 34 m. in breadth; area, 2085 sq. m. The hill country rises from the western boundary line. The district naturally divides itself into three well-defined tracts—(1) The salt tract, along the coast; (2) The arable tract, or rice country; and (3) The submontane tract, or jungle lands. The salt tract runs the whole way down the coast, and forms a desolate strip a few miles broad. Towards the beach it rises into sandy ridges, from 50 to 80 ft. high, sloping inland and covered with a

vegetation of low scrub jungle. Sluggish brackish streams creep along between banks of fetid black mud. The sandhills on the verge of the ocean are carpeted with creepers and the wild convolvulus. Inland, it spreads out into prairies of coarse long grass and scrub jungle, which harbour wild animals in plenty; but throughout this vast region there is scarcely a hamlet, and only patches of rice cultivation at long intervals. From any part of the salt tract one may see the boundary of the inner arable part of the district fringed with long lines of trees, from which every morning the villagers drive their cattle out to the saliferous plains to graze. The salt tract is purely alluvial, and appears to be of recent date. Towards the coast the soil has a distinctly saline taste.

Salt used to be largely manufactured in the district by evaporation, but the industry is now extinct. The arable tract lies beyond the salt lands, and embraces the chief part of the district. It is a long dead-level of rich fields, with a soil lighter in colour than that of Bengal or Behar; much more friable, and apt to split up into small cubes with a rectangular cleavage. A peculiar feature of the arable tract is the *Páts* (literally cups) or depressed lands near the river-banks. They were probably marshes that have partially silted up by the yearly overflow of the streams. These *páts* bear the finest crops. As a whole, the arable tract is a treeless region, except around the villages, which are encircled by fine mango, *pápal*, banyan and tamarind trees, and intersected with green shady lanes of bamboo. A few palmiras, date-palms and screw-pines (a sort of aloe, whose leaves are armed with formidable triple rows of hook-shaped thorns) dot the expanse or run in straight lines between the fields. The sub-montane tract is an undulating country with a red soil, much broken up into ravines along the foot of the hills. Masses of laterite, buried in hard ferruginous clay, crop up as rocks or slabs. At Kopari, in Kila Ambohata, about 2 sq. m. are almost paved with such slabs, dark-red in colour, perfectly flat and polished like plates of iron. A thousand mountain torrents have scooped out for themselves picturesque ravines, clothed with an ever-fresh verdure of prickly thorns, stunted gnarled shrubs, and here and there a noble forest tree. Large tracts are covered with sal jungle, which nowhere, however, attains to any great height.

Balasure district is watered by six distinct river systems: those of the Subanrekha, the Burabalang, the Jamka, the Kansbans and the Dhamra.

The climate greatly varies according to the seasons of the year. The hot season lasts from March to June, but is tempered by cool sea-breezes; from June to September the weather is close and oppressive; and from October to February the cold season brings the north-easterly winds, with cool mornings and evenings.

Almost the only crop grown is rice, which is largely exported by sea. The country is exposed to destructive floods from the hill-rivers and also from cyclonic storm-waves. The district is traversed throughout its entire length by the navigable Orissa coast canal, and also by the East Coast railway from Calcutta to Madras. The seaports of Balasure, Chandbali and Dhamra conduct a very large coasting trade. The exports are almost confined to rice, which is sent to Ceylon, the Maldives and Mauritius. The imports consist of cotton twist and piece goods, mineral oils, metals, betel-nuts and salt. In 1901 the population was 1,071,107, an increase of 9% in the decade.

BALASSA, BALINT, BARON OF KÉKKÖ and GYARMAT (1851-1904), Magyar lyric poet, was born at Kékkö, and educated by the reformer, Péter Bornemissza, and by his mother, the highly gifted Protestant zealot, Anna Sulyok. His first work was a translation of Michael Bock's *Würgertlein für die kranken Seelen*, to comfort his father while in prison (1870-1872) for some political offence. On his father's release, Balint accompanied him to court, and was also present at the coronation diet of Pressburg in 1872. He then joined the army and led a merry life at the fortress of Eger. Here he fell violently in love with Anna Losonczy, the daughter of the hero of Temesvár, and evidently, from his verses, his love was not unrequited. But a new mistress speedily dragged the ever mercurial youth away from her,

and deeply wounded, she gave her hand to Krisztóf Ungnad. Naturally Balassa only began to realize how much he loved Anna when he had lost her. He pursued her with gifts and verses, but she remained true to her pique and to her marriage vows, and he could only enshrine her memory in immortal verse. In 1874 Balint was sent to the camp of Gáspár Békésy to assist him against Stephen Báthory; but his troops were encountered and scattered on the way thither, and he himself was severely wounded and taken prisoner. His not very rigorous captivity lasted for two years, and he then disappears from sight. We next hear of him in 1884 as the wooer and winner of Christina Dobo, the daughter of the valiant commandant of Eger. What led him to this step we know not, but it was the cause of all his subsequent misfortunes. His wife's greedy relatives nearly ruined him by legal processes, and when in 1886 he turned Catholic to escape their persecutions they declared that he and his son had become Turks. His simultaneous desertion of his wife led to his expulsion from Hungary, and from 1889 to 1894 he lived a vagabond life in Poland, sweetened by innumerable amours with damsels of every degree from cithara players to princesses. The Turkish war of 1894 recalled him to Hungary, and he died of his wounds at the siege of Esztergom the same year. Balassa's poems fall into four divisions: religious hymns, patriotic and martial songs, original love poems, and adaptations from the Latin and German. They are all most original, exceedingly objective and so excellent in point of style that it is difficult even to imagine him a contemporary of Sebastian Tinodi and Peter Ilosvay. But his erotics are his best productions. They circulated in MS. for generations and were never printed till 1874, when Farkas Deák discovered a perfect copy of them in the Radványi library. For beauty, feeling and transporting passion there is nothing like them in Magyar literature till we come to the age of Michael Csokonai and Alexander Petöfi. Balassa was also the inventor of the strophe which goes by his name. It consists of nine lines—a b c b c d d b, or three rhyming pairs alternating with the rhyming third, sixth and ninth lines.

See Aron Szilády, *Balint Balassa's Poems* (Hung.) Budapest, 1879. (R. N. E.)

BALATON (PLATTENSEE), the largest lake of middle Europe, in the south-west of Hungary, situated between the counties of Veszprém, Zala and Somogy. Its length is 48 m., average breadth $3\frac{1}{2}$ to $4\frac{1}{2}$ m., greatest breadth $7\frac{1}{2}$ m., least breadth a little less than 1 m. It covers 266 sq. m. and has an extreme depth of 149 ft. Its northern shores are bordered by the beautiful basaltic cones of the Bakony mountains, the volcanic soil of which produces grapes yielding excellent wine; the southern consist partly of a marshy plain, partly of downs. The most beautiful point of the lake is that where the peninsula of Tihany projects in the waters. An ancient church of the Benedictines is here situated on the top of a hill. In a tomb therein is buried Andrew I. (d. 1061), a king of the Hungarian Arpadian dynasty. The temperature of the lake varies greatly, in a manner resembling that of the sea, and many connect its origin with a sea of the Miocene period, the waters of which are said to have covered the Hungarian plain. About fifty streams flow into the lake, which drains into the Danube and is well stocked with fish. It often freezes in winter. Lake Balaton is of growing importance as a bathing resort.

BALAYAN, a town and port of entry of the province of Batangas, Luzon, Philippine Islands, at the head of the Gulf of Balayan, about 55 m. S. by W. of Manila. Pop. (1903) 8493. Subsequently in October 1903, Calatagan (pop. 2654) and Tuy (pop. 2430) were annexed. Balayan has a healthful climate, and is in the midst of a fertile district (with a volcanic soil), which produces rice, cane-sugar, cacao, coffee, pepper, cotton, Indian corn, fruit (oranges, bananas, mangoes, &c.) and native dyes. Horses and cattle are raised for market in considerable numbers. The fisheries are important. The native language is Tagalog.

BALBI, ADRIAN (1782-1848), Italian geographer, was born at Venice on the 25th of April 1782. The publication of his *Prospetto politico-geografico dello stato attuale del globo* (Venice,

1808) obtained his election to the chair of professor of geography at the college of San Michele at Murano; in 1811-1813 he was professor of physics at the Lyceum of Fermo, and afterwards became attached to the customs office at his native city. In 1820 he visited Portugal, and there collected materials for his *Essai statistique sur le royaume de Portugal et d'Algarve*, published in 1822 at Paris, where the author resided from 1821 until 1832. This was followed by *Variétés politiques et statistiques de la monarchie portugaise*, which contains some curious observations respecting that country under the Roman sway. In 1826 he published the first volume of his *Atlas ethnographique du globe, ou classification des peuples anciens et modernes d'après leurs langues*, a work of great erudition. In 1832 appeared the *Abrégé de Géographie*, which, in an enlarged form, was translated into the principal languages of Europe. Balbi retired to Padua and there died on the 14th of March 1848. His son, Eugenio Balbi (1812-1884), followed a similar career, being professor of geography at Pavia, and publishing his father's *Scritti Geografici* (Turin, 1841), and original works in *Gea, ossia la terra* (Trieste, 1854-1867) and *Saggio di geografia* (Milan, 1868).

BALBO, CESARE, COUNT (1789-1853), Italian writer and statesman, was born at Turin on the 21st of November 1789. His father, Prospero Balbo, who belonged to a noble Piedmontese family, held a high position in the Sardinian court, and at the time of Cesare's birth was mayor of the capital. His mother, a member of the Azeglio family, died when he was three years old; and he was brought up in the house of his great-grandmother, the countess of Bugino. In 1798 he joined his father at Paris. From 1808 to 1814 Balbo served in various capacities under the Napoleonic empire at Florence, Rome, Paris and in Illyria. On the fall of Napoleon he entered the service of his native country. While his father was appointed minister of the interior, he entered the army, and undertook political missions to Paris and London. On the outbreak of the revolution of 1821, of which he disapproved, although he was suspected of sympathizing with it, he was forced into exile; and though not long after he was allowed to return to Piedmont, all public service was denied him. Reluctantly, and with frequent endeavours to obtain some appointment, he gave himself up to literature as the only means left him to influence the destinies of his country. This accounts for the fitfulness and incompleteness of so much of his literary work, and for the practical, and in many cases temporary, element which runs through even his most elaborate productions. The great object of his labours was to help in securing the independence of Italy from foreign control. Of true Italian unity he had no expectation and no desire, but he was devoted to the house of Savoy, which he foresaw was destined to change the fate of Italy. A confederation of separate states under the supremacy of the pope was the genuine ideal of Balbo, as it was the ostensible one of Gioberti. But Gioberti, in his *Primato*, seemed to him to neglect the first essential of independence, which he accordingly inculcated in his *Speranze or Hopes of Italy*, in which he suggests that Austria should seek compensation in the Balkans for the inevitable loss of her Italian provinces. Preparation, both military and moral, alertness and patience were his constant theme. He did not desire revolution, but reform; and thus he became the leader of a moderate party, and the steady opponent not only of despotism but of democracy. At last in 1848 his hopes were to some extent satisfied by the constitution granted by the king. He was appointed a member of the commission on the electoral law, and became first constitutional prime-minister of Piedmont, but only held office a few months. With the ministry of d'Azeglio, which soon after got into power, he was on friendly terms, and his pen continued the active defence of his political principles till his death on the 3rd of June 1853. The most important of his writings are historico-political, and derive at once their majesty and their weakness from his theocratic theory of Christianity. His style is clear and vigorous, and not unfrequently terse and epigrammatic. He published *Quattro Novelle* in 1829; *Storia d'Italia sotto i Barbari* in 1830; *Vita di Dante*, 1839; *Meditazioni Storiche*, 1842-1845; *Le Speranze d'Italia*, 1844; *Pensieri*

sulla Storia d'Italia, 1858; *Della Monarchia rappresentativa in Italia* (Florence, 1857).

See E. Ricotti, *Della Vita e degli Scritti di Cesare Balbo* (1856); A. Vismara, *Bibliografia di Cesare Balbo* (Milan, 1882).

BALBOA, VASCO NUÑEZ DE (c. 1475-1517), the discoverer of the Pacific, a leading figure among the Spanish explorers and conquerors of America, was born at Jerez de los Caballeros, in Estremadura, about 1475. Though poor, he was by birth a gentleman (*hidalgó*). Little is known of his life till 1501, when he followed Rodrigo de Bastidas in his voyage of discovery to the western seas. He appears to have settled in Hispaniola, and took to cultivating land in the neighbourhood of Salvatierra, but with no great success, as his debts soon became oppressive. In 1509 the famous Ojeda (Hojeda) sailed from San Domingo with an expedition and founded the settlement of San Sebastian. He had left orders with Enciso, an adventurous lawyer of the town, to fit out two ships and convey provisions to the new settlement. Enciso set sail in 1510, and Balboa, whose debts made the town unpleasant to him, managed to accompany him by concealing himself, it is said, in a cask of "victuals for the voyage," which was conveyed from his farm to the ship. The expedition reached San Sebastian to find Ojeda gone and the settlement in ruins. While Enciso was undecided how to act, Balboa proposed that they should sail for Darien, on the Gulf of Uraba, where he had touched when with Bastidas. His proposal was accepted and a new town was founded, named Sta Maria de la Antigua del Darien; but quarrels soon broke out among the adventurers, and Enciso was deposed, thrown into prison and finally sent off to Spain with Balboa's ally, the alcalde Zamudio. Being thus left in authority, Balboa began to conquer the surrounding country, and by his bravery, courtesy, kindness of heart and just dealing gained the friendship of several native chiefs. On one of these excursions he heard for the first time, from the cacique Comogre, of the ocean on the other side of the mountains and of the gold of Peru. Soon after his return to Darien he received letters from Zamudio, informing him that Enciso had complained to the king, and had obtained a sentence condemning Balboa and summoning him to Spain. In his despair at this message Vasco Nuñez resolved to attempt some great enterprise, the success of which he trusted would conciliate his sovereign. On the 1st of September 1513 he set out with one hundred and ninety Spaniards (Francisco Pizarro among them) and one thousand natives; on the 25th or 26th of September he reached the summit of the range, and sighted the Pacific. Pizarro and two others were sent on to reconnoitre; one of these scouts, Alonso Martin, was the first European actually to embark upon the new-found ocean, in St Michael's Gulf. On the 20th of September Balboa himself arrived upon the shore, and formally took possession of the "Great South Sea" in the name of the Spanish monarch. He remained on the coast for some time, heard again of Peru, visited the Pearl Islands, and thence returned to Darien, which he entered in triumph with a great booty on the 18th of January 1514. He at once sent messengers to Spain bearing presents, to give an account of his discoveries; and the king, Ferdinand the Catholic, partly reconciled to his daring subject, named him *Adelantado of the South Sea*, or admiral of the Pacific, and governor of Panama and Coysa. None the less an expedition sailed from Spain under Don Pedro Arias de Ávila (generally called Pedrarias Dávila) to replace Balboa in the government of the Darien colony itself. Meanwhile the latter had crossed the isthmus and revisited the Pacific several (some say more than twenty) times; plans of the conquest of Peru and of the exploration of the western ocean began to shape themselves in his mind; and with a view to these projects, materials for shipbuilding were gathered together upon the Pacific coast, and two light brigantines were built, launched and armed. With these Vasco Nuñez now took possession of the Pearl Islands, and had it not been for the weather, would have reached the coast of Peru. But his career was stopped by the jealousy of Pedrarias, who pretended that Balboa proposed to throw off his allegiance, and enticed him to Acla, near Darien, by a crafty message. As soon as he had him in his power, he threw

him into prison, had him tried for treason, and forced the judge to condemn him to death. The sentence was carried into execution on the public square of Acla in 1517. From a reckless adventurer, Balboa had developed into an able general, an excellent colonial administrator, and a statesman of mature judgment and brilliant foresight.

See G. F. de Oviedo, *Historia general . . . de las Indias* (1526, bk. XXX, chs. 2, 3); D. M. T. Quintana, *Vidas de Españoles celebres*; M. F. de Navarrete, *Colección de los Viajes y Descubrimientos* (1825-1837); J. Acosta, *Compendio historico de la Nueva Granada* (1848); O. Peschel, *Geschichte der Erdkunde* (1865, p. 237), and *Zeitalter der Entdeckungen*, pp. 442-3 &c.; Washington Irving's *Voyages and Discoveries of the Companions of Columbus* (1831), and Varella's notes on the same in *Biblioteca del Comercio del Plata* (Monte Video); Ferdinand Denis, art. "Vasco Nuñez de Balboa," in *Nouv. Biog. Gén.*

BALBRIGGAN, a market-town and seaport of Co. Dublin, Ireland, in the north parliamentary division, 2½ m. N.N.E. of Dublin by the Great Northern railway. Pop. (1901) 2236. The harbour, though dry at low tides, has a depth of 14 ft. at high-water springs, and affords a good refuge from the east or south-east gales. There are two piers, and a railway viaduct of eleven arches crosses the harbour. The town has considerable manufactures of cottons and hosiery, "Balbriggan hose" being well known. The industry was founded by Baron Hamilton in 1761. There is some coast trade in grain, &c., and sea-fishery is prosecuted. Balbriggan is much frequented as a watering-place in summer.

BALBUS, literally "stammerer," the name of several Roman families. Of the Aclii Balbi, one Manius Aclius Balbus was consul in 150 B.C., another in 114. To another family belonged T. Ampius Balbus, a supporter of Pompey, but afterwards pardoned by Julius Caesar (cf. Cic. *ad Fam.* vi. 12 and xii. 70). We know also of Q. Antonius Balbus, praetor in Sicily in 82 B.C., and Marcus Atius Balbus, who married Julia, a sister of Caesar, and had a daughter Atia, mother of Augustus. The most important of the name were the two Corneli Balbi, natives of Gades (Cadiz).

1. **LUCIUS CORNELIUS BALBUS** (called *Major* to distinguish him from his nephew) was born early in the last century B.C. He is generally considered to have been of Phoenician origin. For his services against Sertorius in Spain, the Roman citizenship was conferred upon him and his family by Pompey. Becoming friendly with all parties, he had much to do with the formation of the First Triumvirate, and was one of the chief financiers in Rome. He was careful to ingratiate himself with Caesar, whom he accompanied when propraetor to Spain (61), and to Gaul (58) as chief engineer (*praefectus fabrum*). His position as a naturalized foreigner, his influence and his wealth naturally made Balbus many enemies, who in 56 put up a native of Gades to prosecute him for illegally assuming the rights of a Roman citizen, a charge directed against the triumvirs equally with himself. Cicero, Pompey and Crassus all spoke on his behalf, and he was acquitted. During the civil war he endeavoured to get Cicero to mediate between Caesar and Pompey, with the object of preventing him from definitely siding with the latter; and Cicero admits that he was dissuaded from doing so, against his better judgment. Subsequently, Balbus became Caesar's private secretary, and Cicero was obliged to ask for his good offices with Caesar. After Caesar's murder, Balbus seems to have attached himself to Octavian; in 43 or 42 he was praetor, and in 40 consul—an honour then for the first time conferred on an alien. The year of his death is not known. Balbus kept a diary of the chief events in his own and Caesar's life (Suetonius, *Caesar*, 81). The 8th book of the *Bell. Gall.*, which was probably written by his friend Hirtius at his instigation, was dedicated to him.

Cicero, *Letters* (ed. Tyrrell and Purser, iv. introd. p. 62) and *Pro Balbo*; see also E. Julien, *De L. Cornelio Balbo Maiore* (1886).

2. **LUCIUS CORNELIUS BALBUS** (called *Minor*), nephew of the above, received the Roman citizenship at the same time as his uncle. During the civil war, he served under Caesar, by whom he was entrusted with several important missions. He also took part in the Alexandrian and Spanish wars. He was rewarded for his services by being admitted into the college of pontiffs.

In 43 he was quaestor in Further Spain, where he amassed a large fortune by plundering the inhabitants. In the same year he crossed over to Bogud, king of Mauretania, and is not heard of again until 21, when he appears as proconsul of Africa. Mommsen thinks that he had incurred the displeasure of Augustus by his conduct as praetor, and that his African appointment after so many years was due to his exceptional fitness for the post. In 10 Balbus defeated the Garamantes, and on the 27th of March in that year received the honour of a triumph, which was then for the first time granted to one who was not a Roman citizen by birth, and for the last time to a private individual. He built a theatre in the capital, which was dedicated on the visit of Augustus from Gaul in 13 (Dio Cassius liv. 25; Pliny, *Nat. Hist.* xxxvi. 12. 60). Balbus appears to have given some attention to literature. He wrote a play of which the subject was his visit to Lentulus in the camp of Pompey at Dyrrhachium, and, according to Macrobius (*Saturnalia*, iii. 6), was the author of a work called Ἐπιγραμμά, dealing with the gods and their worship. See Velleius Paterculus ii. 51; Cicero, *ad Att.* viii. 9; and on both the above the exhaustive articles in Pauly-Wissowa, *Realencyclopädie*, iv. pt. 1. (1900).

BALCONY (Ital. *balcone* from *balco*, scaffold; cf. O. H. Ger. *balcho*, beam, Mod. Ger. *Balken*, Eng. *balk*), a kind of platform projecting from the wall of a building, supported by columns or console brackets, and enclosed with a balustrade. Sometimes balconies are adapted for ceremonial purposes, e.g. that of St Peter's at Rome, whence the newly elected pope gives his blessing *urbi et orbi*. Inside churches balconies are sometimes provided for the singers, and in banqueting halls and the like for the musicians. In theatres the "balcony" was formerly a stage-box, but the name is now usually confined to the part of the auditorium above the dress circle and below the gallery.

BALDE, JAKOB (1604-1668), German Latinist, was born at Ensisheim in Alsace on the 4th of January 1604. Driven from Alsace by the marauding bands of Count Mansfeld, he fled to Ingolstadt where he began to study law. A love disappointment, however, turned his thoughts to the church, and in 1624 he entered the Society of Jesus. Continuing his study of the humanities, he became in 1628 professor of rhetoric at Innsbruck, and in 1635 at Ingolstadt, whither he had been transferred by his superiors in order to study theology. In 1633 he was ordained priest. His lectures and poems had now made him famous, and he was summoned to Munich where, in 1638, he became court chaplain to the elector Maximilian I. He remained in Munich till 1650, when he went to live at Landshut and afterwards at Amberg. In 1654 he was transferred to Neuburg on the Danube, as court preacher and confessor to the count palatine. In the opinion of his contemporaries, Balde revived the glories of the Augustan age, and Pope Alexander VII. and the scholars of the Netherlands combined to do him honour; even Herder regarded him as a greater poet than Horace. While such judgments are naturally exaggerated, there is no doubt that he takes a very high place among modern Latin poets. He died at Neuburg on the 6th of August 1668.

A collected edition of Balde's works in 4 vols. was published at Cologne in 1680; a more complete edition in 8 vols. at Munich, 1729; also a good selection by L. Spach (Paris and Strassburg, 1871). An edition of his Latin lyrics appeared at Regensburg in 1884. There are translations into German of his finer odes, by J. Schrott and M. Schleich (Munich, 1870). See G. Westermayer, *Jacobus Balde, sein Leben und seine Werke* (1868); J. Bach, *Jakob Balde* (Freiburg, 1904).

BALDER, a Scandinavian god, the son of Odin or Othin. The story of his death is given in two widely different forms, by Saxo in his *Gesta Danorum* (ed. Holder, pp. 69 ff.) and in the prose Edda (*Gylfaginning*, cap. 49).

See F. Kauffmann, *Balder: Mythos und Sage* (Strassburg, 1902). For other works, see **TRUONIC PEOPLES**, § 7.

BALDERIC, the name given to the author of a chronicle of the bishops of Cambrai, written in the 11th century. This *Gesta episcoporum Cambraecensium* was for some time attributed to Balderic, archbishop of Noyon, but it now seems tolerably certain that the author was an anonymous canon of Cambrai. The work is of considerable importance for the history of the north of France during the 11th century, and was first published in 1615.

The best edition is in the *Monumenta Germaniae historica. Scriptores*, Bd. vii. (Hanover and Berlin, 1826-1892), which contains an introduction by L. C. Bethmann.

See *Histoire littéraire de la France*, tome viii. (Paris, 1865-1869).

BALDI, BERNARDINO (1533-1617), Italian mathematician and miscellaneous writer, was descended of a noble family at Urbino, in which city he was born on the 6th of June 1533. He pursued his studies at Padua with extraordinary zeal and success, and is said to have acquired, during the course of his life, no fewer than sixteen languages, though according to Tiraboschi the inscription on his tomb limits the number to twelve. The appearance of the plague at Padua obliged him to retire to his native city, whence he was, shortly afterwards, called to act as tutor to Ferrante (Ferdinand) Gonzaga, from whom he received the rich abbey of Guastalla. He held office as abbot for twenty-five years, and then retired to his native town. In 1612 he was employed by the duke as his envoy to Venice, where he distinguished himself by the congratulatory oration he delivered before the Venetian senate on the election of the new doge, Andrea Memmo. Baldi died at Urbino on the 12th of October 1617. He was, perhaps, the most universal genius of his age, and is said to have written upwards of a hundred different works, the chief part of which have remained unpublished. His various works give satisfactory evidence of his abilities as a theologian, mathematician, geographer, antiquary, historian and poet. The *Cronica dei Matematici* (published at Urbino in 1707) is an abridgment of a larger work, on which he had bestowed twelve years of labour, and which was intended to contain the lives of more than two hundred mathematicians. His life has been written by Affò, Mazzuchelli and others.

BALDINGER, ERNST GOTTFRIED (1738-1804), German physician, was born near Erfurt on the 13th of May 1738. He studied medicine at Erfurt, Halle and Jena, and in 1761 was entrusted with the superintendence of the military hospitals connected with the Prussian encampment near Torgau. He published in 1765 a treatise *De Militum Morbis*, which met with a favourable reception. In 1768 he became professor of medicine at Jena, whence he removed in 1773 to Göttingen, and in 1785 to Marburg, where he died of apoplexy on the 21st of January 1804. Among his pupils were S. T. Sömmerring and J. F. Blumenbach. Some eighty-four separate treatises are mentioned as having proceeded from his pen, in addition to numerous papers scattered through various collections and journals.

BALDINUCCI, FILIPPO (1624-1696), Italian writer on the history of the arts, was born at Florence. His chief work is entitled *Notizie de' Professori del Disegno da Cimabue . . . (dal 1260 sino al 1670)*, and was first published in six vols. 4to, 1681-1728. The capital defect of this work is the attempt to derive all Italian art from the schools of Florence. A good edition is that by Ranalli (5 vols. 8vo, Florence, 1845-1847). Baldinucci's whole works were published in fourteen vols. at Milan, 1808-1812.

BALDNESS¹ (technically *alopecia*, from ἀλωπηξ, a fox, foxes often having bald patches on their coats), the result of loss of hair, particularly on the human scalp. So far as remediable alopecia is concerned, two forms may be distinguished: one the premature baldness so commonly seen in young men, due to alopecia seborrhoica, the other alopecia areata, now regarded as an alopecia disease.

Alopecia seborrhoica is that premature baldness so constantly seen, in which the condition steadily advances from the forehead backwards, until only a fringe of hair is left on the head. It is always due to the underlying disease seborrhoica, and though it progresses steadily if neglected, is yet very amenable to treatment. The two drugs of greatest value in this trouble are sulphur and salicylic acid, some eighteen grains of each added to an ounce of vaseline making a good application. This should be rubbed well into the scalp daily for a prolonged period. Where the greasiness is objected to, the following salicylic lotion may be substituted,

¹ The adjective "bald" M. E. "balled" is usually explained as literally "round and smooth like a ball," but it may be connected with a stem *bal*, white or shining. The Greek φάλακρος certainly suggests some such derivation.

though the vaseline application has probably the greater value:—R Ac. salicyl. ʒi-iv; Ol. ricini ʒii-vi; Ol. ros. geran. ℥j; Spt. vini ad ʒvi. The head must be frequently cleansed, and in very mild cases a daily washing with soap spirit will at times effect a cure unaided.

Alopecia areata is characterized by the development of round patches more or less completely denuded of hair. It is most commonly observed on the scalp, though it may occur on any part of the body where hair is naturally present. The patches are rounded, smooth and somewhat depressed owing to the loss of a large proportion of the follicles. At the margin of the patches short broken hairs are usually to be seen. Clinical evidence is steadily accumulating to show that this disease may be transmitted. Organisms are invariably present, in some cases few in number, but in others very abundant and forming a continuous sheath round the hair. They were first described by Dr George Thin, who gave them the name of *Bacterium decalvans*. The disease must be distinguished from ringworm—especially the bald variety; but though this is at times somewhat difficult clinically, the use of the microscope leaves no room for doubt. It must be remembered that for patients under forty years of age, time alone will generally bring about the desired end, though treatment undoubtedly hastens recovery. After forty every year added to the patient's age makes the prognosis less good. The general hygiene and mode of life of the sufferer must be very carefully attended to, and any weakness suitably treated. The following lotion should be applied daily to the affected parts, at first cautiously, later more vigorously, and in stronger solution:—R Acidi lactici ʒi-ʒii; Ol. ricini ʒii; Spt. vini ad ʒiv.

The loss of hair following acute fevers must be treated by keeping the hair short, applying stimulating lotions to the scalp, and attending to the general hygiene of the patient.

BALDOVINETTI, ALESSIO (1427-1499), Florentine painter, was born on the 14th of October 1427, and died on the 29th of August 1499. He was a follower of the group of scientific realists and naturalists in art which included Andrea del Castagno, Paolo Uccello and Domenico Veneziano, the influence of the last-named master being particularly manifest in his work. Tradition, probable in itself though not attested by contemporary records, says that he assisted in the decorations of the chapel of S. Egidio in Santa Maria Nuova, carried out during the years 1441-1451 by Domenico Veneziano and in conjunction with Andrea del Castagno. That he was commissioned to complete the series at a later date (1460) is certain. In 1462 Alessio was employed to paint the great fresco of the Annunciation in the cloister of the Annunziata, which still exists in ruined condition. The remains as we see them give evidence of the artist's power both of imitating natural detail with minute fidelity and of spacing his figures in a landscape with a large sense of air and distance; and they amply verify two separate statements of Vasari concerning him: that "he delighted in drawing landscapes from nature exactly as they are, whence we see in his paintings rivers, bridges, rocks, plants, fruits, roads, fields, cities, exercise-grounds, and an infinity of other such things," and that he was an inveterate experimentalist in technical matters. His favourite method in wall-painting was to lay in his compositions in fresco and finish them *a secco* with a mixture of yolk of egg and liquid varnish. This, says Vasari, was with the view of protecting the painting from damp; but in course of time the parts executed with this vehicle scaled away, so that the great secret he hoped to have discovered turned out a failure. In 1465 he furnished a cartoon of the Nativity, which was executed in tarsia by Giuliano de Maiano in the sacristy of the cathedral and still exists. From 1466 date the groups of four Evangelists and four Fathers of the Church in fresco, together with the Annunciation on an oblong panel, which still decorate the Portuguese chapel in the church of S. Miniato, and are given in error by Vasari to Pietro Pollaiuolo. A fresco of the risen Christ between angels inside a Holy Sepulchre in the chapel of the Rucellai family, also still existing, belongs to 1467. In 1471 Alessio undertook important works for the church of Sta Trinità at the commission of Bongianni Gianfigliuzzi. First, to paint an altar-piece of the

Virgin and Child with six saints; this was finished in 1472 and is now in the Academy at Florence: next, a series of frescoes from the Old Testament which was to be completed according to contract within five years, but actually remained on hand for fully sixteen. In 1497 the finished series, which contained many portraits of leading Florentine citizens, was valued at a thousand gold florins by a committee consisting of Cosimo Rosselli, Benozzo Gozzoli, Perugino and Filippino Lippi; only some defaced fragments of it now remain. Meanwhile Alessio had been much occupied with other technical pursuits and researches apart from painting. He was regarded by his contemporaries as the one craftsman who had rediscovered and fully understood the long disused art of mosaic, and was employed accordingly between 1481 and 1483 to repair the mosaics over the door of the church of S. Miniato, as well as several of those both within and without the baptistery of the cathedral.

These are the recorded and datable works of the master; others attributed to him on good and sufficient internal evidences are as follows:—A small panel in the Florence Academy, with the three subjects of the Baptism, the Marriage of Cana and the Transfiguration; this was long attributed to Fra Angelico, but is to all appearance early work of BaldoVinetti: an Annunciation in the Uffizi, formerly in the church of S. Giorgio; unmistakably by the master's hand though given by Vasari to Pesellino: several Madonnas of peculiarly fine and characteristic quality; one in the collection of Madame André at Paris acquired direct from the descendants of the painter, a second, formerly in the Duchâtel collection and now in the Louvre, a third in the possession of Mr Berenson at Florence. All these are executed with the determined patience and precision characteristic of BaldoVinetti; two, those at the Louvre and in the André collection, are distinguished by beautiful landscape backgrounds; and all, but especially the example in the Louvre, add a peculiar and delicate charm to the quality of grave majesty which Alessio's works share with those of Piero della Francesca and others of Domenico Veneziano's following. They probably belong to the years 1460-1465. In the later of his preserved works, while there is no abatement of precise and laborious finish, his beginning to prevail a certain harshness and commonness of type, and a lack of care for beauty in composition, the technical and scientific searcher seeming more and more to predominate over the artist.

See also Vasari, ed. Milanesi, vol. ii.; Crowe-Cavalcaselle, *Hist. of Painting in Italy*, vol. ii.; Bernhard Berenson, *Study and Criticism of Italian Art*, 2nd series.

BALDRIC (from O. Fr. *basdre*, O. Ger. *baldריך*, of doubtful origin; cognate with English "belt"), a belt worn over one shoulder, passing diagonally across the body and under the other arm, either as an ornament or a support for a sword, bugle, &c.

BALDUINUS, JACOBUS, Italian jurist of the 13th century, was by birth a Bolognese, and is reputed to have been of a noble family. He was a pupil of Azo, and the master of Odofredus, of Hostiensis, and of Jacobus de Ravanis, the last of whom has the reputation of having first applied dialectical forms to legal science. His great fame as a professor of civil law at the university of Bologna caused Balduinus to be elected *podestà* of the city of Genoa, where he was entrusted with the reforms of the law of the republic. He died at Bologna in 1225, and has left behind him some treatises on procedure, the earliest of their kind.

BALDUS DE UBALDIS, PETRUS (1327-1406), Italian jurist, a member of the noble family of the Ubaldi (Baldeschi), was born at Perugia in 1327, and studied civil law there under Bartolus, being admitted to the degree of doctor of civil law at the early age of seventeen. Federicus Petrucius of Siena is said to have been the master under whom he studied canon law. Upon his promotion to the doctorate he at once proceeded to Bologna, where he taught law for three years; after which he was advanced to a professorship at Perugia, where he remained for thirty-three years. He taught law subsequently at Pisa, at Florence, at Padua and at Pavia, at a time when the schools of law in those universities disputed the palm with the school of Bologna. He died at Pavia on the 28th of April 1406. The extant works of Baldus hardly bear out the great reputation which he acquired

amongst his contemporaries, due partly to the active part he took in public affairs, and partly to the fame he acquired by his consultations, of which five volumes have been published (Frankfort, 1589). Baldus was the master of Pierre Roger de Beaufort, who became pope under the title of Gregory XI., and whose immediate successor, Urban VI., summoned Baldus to Rome to assist him by his consultations in 1380 against the anti-pope Clement VII. Cardinal de Zabarella and Paulus Castrensis were also amongst his pupils. His *Commentary on the Liber Feudorum* is considered to be one of the best of his works, which were unfortunately left by him for the most part in an incomplete state. His brothers Angelus (1328-1407) and Petrus (1335-1400) were of almost equal eminence with himself as jurists.

BALDWIN I. (d. 1205), emperor of Romania, count of Flanders and Hainaut, was one of the most prominent leaders of the fourth crusade, which resulted in the capture of Constantinople, the conquest of the greater part of the East Roman empire, and the foundation of the Latin empire of Romania. The imperial crown was offered to, and refused by, Henry Dandolo, doge of Venice. The choice then lay between Baldwin and Boniface of Montferat. Baldwin was elected (9th of May 1204), and crowned a week later. He was young, gallant, pious and virtuous, one of the few who interpreted and observed his crusading vows strictly; the most popular leader in the host. The empire of Romania was organized on feudal principles; the emperor was feudal superior of the princes who received portions of the conquered territory. His own special portion consisted of Constantinople, the adjacent regions both on the European and the Asiatic side, along with some outlying districts, and several islands including Lemnos, Lesbos, Chios and Tenos. The territories had still to be conquered; and first of all it was necessary to break the resistance of the Greeks in Thrace and secure Thessalonica. In this enterprise (summer of 1204) Baldwin came into collision with Boniface of Montferat, the rival candidate for the empire, who was to receive a large territory in Macedonia with the title of king of Saloniki. He hoped to make himself quite independent of the empire, to do no homage for his kingdom, and he opposed Baldwin's proposal to march to Thessalonica. The antagonism between Flemings and Lombards aggravated the quarrel. Baldwin insisted on going to Thessalonica; Boniface laid siege to Hadrianople, where Baldwin had established a governor; civil war seemed inevitable. An agreement was effected by the efforts of Dandolo and the count of Blois. Boniface received Thessalonica as a fief from the emperor, and was appointed commander of the forces which were to march to the conquest of Greece.

During the following winter (1204-1205) the Franks prosecuted conquests in Bithynia, in which Henry, Baldwin's brother, took part. But in February the Greeks revolted in Thrace, relying on the assistance of John (Kaloyan), king of Bulgaria, whose overtures of alliance had been unwisely rejected by the emperor. The garrison of Hadrianople was expelled. Baldwin along with Dandolo, the count of Blois, and Marshal Villehardouin, the historian, marched to besiege that city. The Bulgarian king led to its relief an army which far outnumbered that of the crusaders. The Frank knights fought desperately, but were utterly defeated (14th of April 1205); the count of Blois was slain, and the emperor captured. For some time his fate was uncertain, and in the meanwhile Henry, his brother, assumed the regency. Not till the middle of July was it definitely ascertained that he was dead. It seems that he was at first treated well as a valuable hostage, but was sacrificed by the Bulgarian monarch in a sudden outburst of rage, perhaps in consequence of the revolt of Philippopolis, which passed into the hands of the Franks. One contemporary writer says that his hands and feet were cut off, and he was thrown into a valley where he died on the third day; but the manner of his death is obscure. King John himself wrote to Pope Innocent III. that he died in prison. His brother Henry was crowned emperor in August.

AUTHORITIES.—Villehardouin, *La Conquête de Constantinople* (ed. De Wailly, Paris, 1872; ed. Bouchet, 2 vols., Paris, 1891); Robert

de Clari, *La Prise de Constantinople* (in Hopf's *Chroniques géographiques*); Ernoul, *Chronique* (ed. Mas Latrie, Paris, 1871); Nicetas (ed. Bonn, 1835); George Acropolites, vol. i. (ed. Heisenberg, Leipzig, 1903); Documents in Tafel and Thomas, *Urkunden zur älteren Handels- und Staatsgeschichte der Republik Venedig* (Vienna, 1856).

MODERN WORKS.—Ducange, *Histoire de l'empire de Constantinople sous les empereurs français* (Paris, 1657); Gibbon, *Decline and Fall*, vol. vi. (ed. Bury, 1808); G. Finlay, *History of Greece*, vol. iv. (Oxford, 1877); Poens, *The Fall of Constantinople* (London, 1883); Hopf, "Griechische Geschichte," in Ersch and Gruber's *Encyclopädie*, vol. lxxv. (Leipzig, 1870); Gerland, *Geschichte des lateinischen Kaiserreiches von Konstantinopel*, part i. (Homburg v. d. Höhe, 1905).

BALDWIN II. (1217–1273), emperor of Romania, was a younger son of Yolande, sister of Baldwin I. Her husband, Peter of Courtenay, was third emperor of Romania, and had been followed by his son Robert, on whose death in 1228 the succession passed to Baldwin, a boy of eleven years old. The barons chose John of Brienne (titular king of Jerusalem) as emperor-regent for life; Baldwin was to rule the Asiatic possessions of the empire when he reached the age of twenty, was to marry John's daughter Mary, and on John's death to enjoy the full imperial sovereignty. The marriage contract was carried out in 1234. Since the death of the emperor Henry in 1216, the Latin empire had declined and the Greek power advanced; and the hopes that John of Brienne might restore it were disappointed. He died in 1237. The realm which Baldwin governed was little more than Constantinople. His financial situation was desperate, and his life was chiefly occupied in begging at European courts. He went to the West in 1236, visited Rome, France and Flanders, trying to raise money and men to recover the lost territory of his realm. His efforts met with success, and in 1240 he returned to Constantinople (through Germany and Hungary) at the head of a considerable army. Circumstances hindered him from accomplishing anything with this help, and in 1245 he travelled again to the West, first to Italy and then to France, where he spent two years. The empress Maria and Philip of Toucy governed during his absence. He was happy to be able to get money from King Louis IX. in exchange for relics. In 1249 he was with King Louis at Damietta. The extremity of his financial straits reduced him soon afterwards to handing over his only son Philip to merchants as a pledge for loans of money. Louis IX. redeemed the hostage. The rest of his inglorious reign was spent by Baldwin in mendicant tours in western Europe. In 1261 Constantinople was captured by Michael Palaeologus, and Baldwin's rule came to an end. He escaped in a Venetian galley to Negropont, and then proceeded to Athens, thence to Apulia, finally to France. As titular emperor, his rôle was still the same, to beg help from the western powers. In 1267 he went to Italy; his hopes were centred in Charles of Anjou. Charles seriously entertained the idea of conquering Constantinople, though various complications hindered him from realizing it. He made a definite treaty with Baldwin to this intent (May 1267). During the next year Baldwin and his son Philip lived on pensions from Charles. In October 1273 Philip married Beatrice, daughter of Charles, at Foggia. A few days later Baldwin died.

See authorities for BALDWIN I. above; also Norden, *Das Papsttum und Byzanz* (Berlin 1903).

BALDWIN I., prince of Edessa (1098–1100), first king of Jerusalem (1100–1118), was the brother of Godfrey of Bouillon (q.v.). He was originally a clerk in orders, and held several prebends; but in 1096 he joined the first crusade, and accompanied his brother Godfrey as far as Heraclea in Asia Minor. When Tancred left the main body of the crusaders at Heraclea, and marched into Cilicia, Baldwin followed, partly in jealousy, partly from the same political motives which animated Tancred. He wrested Tarsus from Tancred's grip (September 1097), and left there a garrison of his own. After rejoining the main army at Marash, he received an invitation from an Armenian named Pakrad, and moved eastwards towards the Euphrates, where he occupied Tell-bashir. Another invitation followed from Thoros of Edessa; and to Edessa Baldwin came, first as protector, and then, when Thoros was assassinated, as his successor (March 1098). For two years he ruled in Edessa (1098–1100), marrying

an Armenian wife, and acting generally as the intermediary between the crusaders and the Armenians. During these two years he was successful in maintaining his ground, both against the Mahomedan powers by which he was surrounded, and from which he won Samosata and Seruj (Sarorgia), and against a conspiracy of his own subjects in 1098. At the end of 1099 he visited Jerusalem along with Bohemund I.; but he returned to Edessa in January 1100. On the death of Godfrey he was summoned by a party in Jerusalem to succeed to his brother. A lay reaction against the theocratic pretensions of Dagobert, who was counting on Norman support, was responsible for the summons; and in the strength of that reaction Baldwin was able to become the first king of Jerusalem. He was crowned on Christmas Day, 1100, by the patriarch himself; but the struggle of church and state was not yet over, and in the spring of 1101 Baldwin had Dagobert suspended by a papal legate, while later in the year the two disagreed on the question of the contribution to be made by the patriarch towards the defence of the Holy Land. The struggle ended in the deposition of Dagobert and the triumph of Baldwin (1102).

As Baldwin had secured the supremacy of the lay power in Jerusalem, so he extended into a compact kingdom the poor and straggling territories to which he had succeeded. This he did by an alliance with the Italian trading towns, especially Genoa, which supplied in return for the concession of a quarter in the conquered towns, the instruments and the skill for a war of sieges, in which the coast towns of Palestine were successively reduced. Arsuf and Caesarea were captured in 1102; Acre in 1104; Beirut and Sidon in 1110 (the latter with the aid of the Venetians and Norwegians). Meanwhile Baldwin repelled in successive years the attacks of the Egyptians (1102, 1103, 1105), and in the latter years of his reign (1115–1118) he even pushed southward at the expense of Egypt, penetrating as far as the Red Sea, and planting an outpost at Monreal. In the north he had to compose the dissensions of the Christian princes in Tripoli, Antioch and Edessa (1109–1110), and to help them to maintain their ground against the Mahomedan princes of N.E. Syria, especially Maudud and Aksunk-ur, amirs of Mosul. In this way Baldwin was able to make himself into practical suzerain of the three Christian principalities of the north, though the suzerainty was, and always continued to be, somewhat nominal. In 1118 he died, after an expedition to Egypt, during which he captured Farama, and, as old Fuller says, "caught many fish, and his death in eating them."

Baldwin was one of the "adventurer princes" of the first crusade, and as such he stands alongside of Bohemund, Tancred and Raymond. On the whole he was the most successful of his class. By his defence of the lay power against a nascent theocracy, and by his alliance with the Italian towns, he was the real founder of the Latin kingdom of Jerusalem. Events worked for him: he might never have come to the throne, unless Bohemund had fallen into the hands of Danishmend; and the dissensions among the Mahomedans alone made possible the subsequent consolidation of his kingdom. But he had *virtù* as well as *fortuna*; and on his tombstone it was written that he was "a second Judas Maccabaeus, whom Kedar and Egypt, Dan and Damascus dreaded." As king, he still retained something of the clerk in his habits; but he was at the same time a warrior so impetuous, as to be sometimes foolhardy, and his policy was on the whole anti-clerical. He may be accused of greed: his life was not chaste; and the two defects met in his rejection of his Armenian wife and his marriage to the rich Sicilian widow Adelaide (1113). But "on the holiest soil of history, he gave his people a fatherland"; and Fulcher of Chartres, his chaplain, who paints at the beginning of Baldwin's reign the terrors of the lonely band of Christians in the midst of their foes, can celebrate at the end the formation of a new nation in the East ("qui fuimus occidentales, nunc facti sumus orientales")—an achievement which, so far as it was the work of any one man, was the work of Baldwin I.

LITERATURE.—The *Historia Hierosolymitana* of Fulcher, who had accompanied Baldwin as chaplain to Edessa, and had lived in

Jerusalem during his reign, is the primary authority for Baldwin's career. There is a monograph on Baldwin by Wolff (*König Baldwin I. von Jerusalem*), and his reign is sketched in R. Röhricht's *Geschichte des Königtums Jerusalem* (Innsbruck, 1898) C. i.-iv. (E. Br.)

BALDWIN II., count of Edessa (1100—1118), king of Jerusalem (1118—1131), originally known as Baldwin de Burg, was a son of Count Hugh of Rethel, and a nephew of Godfrey of Bouillon and Baldwin I. He appears on the first crusade at Constantinople as one of Godfrey's men; and he helped Tancred to occupy Bethlehem in June 1099. After the capture of Jerusalem he served for a time with Bohemund at Antioch; but when Baldwin of Edessa became king of Jerusalem, he summoned Baldwin de Burg, and left him as count in Edessa. From Edessa Baldwin conducted continual forays against the Mahomedan princes; and in the great foray of 1104, in which he was joined by Bohemund, he was defeated and captured at Balich. Tancred became guardian of Edessa during Baldwin's captivity, and did not trouble himself greatly to procure his release. Baldwin, however, recovered his liberty at the beginning of 1108, and at once entered upon a struggle with Tancred for the recovery of Edessa. In September 1108 he regained his principality; but the struggle with Tancred continued, until it was composed by Baldwin in 1109. For the next ten years Baldwin ruled his principality with success, if not without severity. Planted in the farthest Christian outpost in northern Syria, he had to meet many attacks, especially from Mardin and Mosul, in revenge for the provocation offered by his own forays and those of the restless Tancred. In 1110 he was besieged in Edessa, and relieved by Baldwin I.; in 1114 he repelled an attack by Aksunkur of Mosul; in 1115 he helped to defeat Aksunkur at Danith. At the same time, if Matthew of Edessa may be trusted, he also carried his arms against the Armenians, and plundered in his avarice every Armenian of wealth and position. In 1118 he was on his way to spend Easter at Jerusalem, when he received the news of the death of Baldwin I.; and when he arrived at Jerusalem, he was made king, chiefly by the influence of the patriarch Arnulf. In a reign of thirteen years, Baldwin II. extended the kingdom of Jerusalem to its widest limits. His reign is marked by almost incessant fighting in northern Syria. In 1119, after the defeat and death of Roger of Antioch, he defeated the amirs of Mardin and Damascus at Danith; in subsequent years he extended his sway to the very gates of Aleppo. In 1123 he was captured by Balak of Mardin, and confined in Kharput with Joscelin, his successor in the county of Edessa, who had been captured in the previous year. During his captivity Eustace Graverius became regent of Jerusalem, and succeeded, with the aid of the Venetians, in repelling an Egyptian attack, and even in capturing Tyre, 1124. In 1124 Baldwin II. succeeded in securing his liberty, under conditions which he instantly broke; and he at once embarked on strenuous and not unsuccessful hostilities against Aleppo and Damascus (1124—1127), exacting tribute from both. During his reign he twice acted as regent in Antioch (1119, 1130), and in 1126 he married his daughter Alice to Bohemund II. In 1128 he offered the hand of his eldest daughter, Melisinda, to Fulk of Anjou, who had been recommended to him by Honorius II. In 1129 Fulk came and married Melisinda, and in 1131, on the death of Baldwin, he succeeded to the crown.

Baldwin II. had much of the churchmanship of Godfrey and Baldwin I.; but he appears most decidedly as an incessant warrior, under whom the Latin domination in the East stretched, as Ibn al-Athir writes, in a long line from Mardin in the North to el-Arish on the Red Sea—a line only broken by the Mahomedan powers of Aleppo, Hamah, Homs and Damascus. The Franks controlled the great routes of trade, and took tolls of the traders; and in 1130 their power may be regarded as having reached its height.

LITERATURE.—Fulcher of Chartres narrates the reign of Baldwin II. down to 1127; for the rest of the reign the authority is William of Tyre. R. Röhricht, *Geschichte des Königtums Jerusalem* (Innsbruck, 1898), C. vii.-x., is the chief modern authority. (E. Br.)

BALDWIN III., king of Jerusalem (1143—1162), was the eldest son of Fulk of Jerusalem by his wife Melisinda. He was born in

1130, and became king in 1143, under the regency of his mother, which lasted till 1152. He came to the throne at a time when the attacks of the Greeks in Cilicia, and of Zengi on Edessa, were fatally weakening the position of the Franks in northern Syria; and from the beginning of his reign the power of the Latin kingdom of Jerusalem may be said to be slowly declining, though as yet there is little outward trace of its decay to be seen. Edessa was lost, however, in the year after Baldwin's accession, and the conquest by Zengi of this farthest and most important outpost in northern Syria was already a serious blow to the kingdom. Upon it in 1147 there followed the second crusade; and in that crusade Baldwin III., now some eighteen years of age, played his part by the side of Conrad III. and Louis VII. He received them in Jerusalem in 1148; with them he planned the attack on Damascus and with them he signally failed in the attack. In 1149, after the failure of the crusade, Baldwin III. appeared in Antioch, where the fall of Raymond, the husband of the princess Constance, made his presence necessary. He regulated affairs in Antioch, and tried to strengthen the north of Palestine generally against the arm of Zengi's successor, Nureddin, by renewing the old and politic alliance with Damascus interrupted since 1147, and by ceding Tellbasher, the one remnant of the county of Edessa, to Manuel of Constantinople. In 1152 came the inevitable struggle between the young king and his mother, who had ruled with wisdom and vigour during the regency and was unwilling to lay down the reins of power. Baldwin originally planned a solemn coronation, as the signal of his emancipation. Dissuaded from that course, he nevertheless wore his crown publicly in the church of the Sepulchre. A struggle followed: in the issue, Baldwin agreed to leave his mother in possession of Jerusalem and Nablus, while he retained Acre and Tyre for himself. But he repented of the bargain; and a new struggle began, in which Baldwin recovered, after some fighting, the possession of his capital. From these internal dissensions Baldwin was now summoned to the north, to regulate anew the affairs of Antioch and also those of Tripoli, where the death of Count Raymond had thrown on his shoulders the cares of a second regency. On his return to Jerusalem he was successful in repelling an attack by an army of Turcomans; and his success encouraged him to attempt the siege of Ascalon in the spring of 1153. He was successful: the "bride of Syria," which had all but become the property of the crusaders in 1099, but had since defied the arms of the Franks for half a century, became part of the kingdom of Jerusalem. From 1156 to 1158 Baldwin was occupied in hostilities with Nureddin. In 1156 he had to submit to a treaty which cut short his territories; in the winter of 1157—1158 he besieged and captured Harim, in the territory once belonging to Antioch: in 1158 he defeated Nureddin himself. In the same year Baldwin married Theodora, a near relative of the East Roman emperor Manuel; while in 1159 he received a visit from Manuel himself at Antioch. The Latin king rode behind the Greek emperor, without any of the insignia of his dignity, at the entry into Antioch; but their relations were of the friendliest, and Manuel—as great a physician as he was a hunter—personally attended to Baldwin when the king was thrown from his horse in attempting to equal the emperor's feats of horsemanship. In the same year Baldwin had to undertake the regency in Antioch once more, Raymond of Chatillon, the second husband of Constance, being captured in battle. Three years later he died (1162), without male issue, and was succeeded by his brother Amalric I.

Baldwin III. was the first of the kings of Jerusalem who was a native of the soil of Palestine. His three predecessors had all been emigrants from the West. His reign also marks a new departure from another point of view. His predecessors had been men of a type half military, half clerical—at once hard fighters and sound churchmen. Baldwin was a man of a subtler type—a man capable of dealing with the intrigues of a court and with problems of law, and, as such, suited for guiding the middle age of the kingdom, which the different qualities of his predecessors had been equally suited to found. Like his brother, Amalric I., he was a clerly and studious king versed

in law, and ready to discuss points of dogma. In an excellent sketch of Baldwin's character (xvi. cil.), William of Tyre tells us that he spent his spare time in reading and had a particular affection for history; that he was well skilled in the *ius consuetudinarium* of the kingdom (afterwards recorded by lawyers like John of Ibelin and Philip of Novara as "the assizes of Jerusalem"); and that he had the royal faculty for remembering faces, and could generally be trusted to address by name anybody whom he had once met, so that he was more popular with high and low than any of his predecessors. He had, William also reports, a gift of impromptu eloquence, and a faculty both for saying witty things pleasantly at other people's expense and for listening placidly to witticisms directed against himself; while he was generous to excess without needing to make exactions in order to support his generosity, and always respected the Church. If in his youth he had been prone to gambling, and before his marriage with Theodora had been somewhat lax in his morals, when he became a man he put away childish things; his married life was a shining example to his people and he was abstemious both in food and drink, holding that "excess in either was an incentive to the worst of crimes." Even his enemy, Nureddin, said of him, when he died—"The Franks have lost such a prince that the world has not now his like."

LITERATURE.—William of Tyre is the great primary authority for his reign; Cinnamus and Ibn-al-athir (see *Bibliography*) to the article *CRUSADES*) give the Byzantine and Mahomedan point of view. His reign is described by R. Röhricht, *Geschichte des Königreichs Jerusalem* (Innsbruck, 1898), C. xiii.-xvi. (E. BR.)

BALDWIN IV., the son of Amalric I. by his first wife Agnes, ruled in Jerusalem from 1174 to 1183, when he had his nephew Baldwin crowned in his stead. Educated by William of Tyre, Baldwin IV. came to the throne at the early age of thirteen; and thus the kingdom came under the regency of Raymond II. of Tripoli. Happily for the kingdom whose king was a child and a leper, the attention of Saladin was distracted for several years by an attempt to wrest from the sons of Nureddin the inheritance of their father—an attempt partially successful in 1174, but only finally realized in 1183. The problems of the reign of Baldwin IV. may be said to have been two—his sister Sibylla and the fiery Raynald of Chatillon, once prince of Antioch through marriage to Constance (1153-1159), then a captive for many years in the hand of the Mahomedans, and since 1176 lord of Krak (Kerak), to the east of the Dead Sea. Sibylla was the heiress of the kingdom; the problem of her marriage was important. Married first to William of Montferrat, to whom she bore a son, Baldwin, she was again married in 1180 to Guy of Lusignan; and dissensions between Sibylla and her husband on the one side, and Baldwin IV. on the other, troubled the latter years of his reign. Meanwhile Raynald of Krak took advantage of the position of his fortress, which lay on the great route of trade from Damascus and Egypt, to plunder the caravans (1182), and thus helped to precipitate the inevitable attack by Saladin. When the attack came, Guy of Lusignan was made regent by Baldwin IV., but he declined battle and he was consequently deposed both from his regency and from his right of succession, while Sibylla's son by her first husband was crowned king as Baldwin V. in 1183. For a time Baldwin IV. still continued to be active; but in 1184 he handed over the regency to Raymond of Tripoli, and in 1185 he died.

LITERATURE.—The narrative of William of Tyre concludes with Baldwin IV.'s transfer of the regency to Raymond of Tripoli. R. Röhricht describes the reign of Baldwin IV., *Geschichte des Königreichs Jerusalem* (Innsbruck, 1898), C. xix.-xxi. (E. BR.)

BALDWIN V., the son of Sibylla (daughter of Amalric I.) by her first husband, William of Montferrat, was the nominal king of Jerusalem from 1183 to 1186, under the regency of Raymond of Tripoli. His reign is marked by the advance of Saladin and by dissensions between the government and Guy of Lusignan.

BALDWIN, JAMES MARK (1861-), American philosopher, was born at Columbia, S.C., and educated at Princeton and several German universities. He was professor of philosophy in the university of Toronto (1886), of psychology at Princeton (1893), and subsequently (1903) of philosophy and psychology in

Johns Hopkins University. Prominent among experimental psychologists, he was one of the founders of the *Psychological Review*. In 1892 he was vice-president of the International Congress of Psychology held in London, and in 1897-1898 president of the American Psychological Association; he received a gold medal from the Royal Academy of Arts and Sciences of Denmark (1897), was honorary president of the International Congress of Criminal Anthropology held in Geneva in 1896, and was made an honorary D.Sc. of Oxford University. Apart from articles in the *Psychological Review*, he has written:—*Handbook of Psychology* (1890); translation of Ribot's *German Psychology of To-day* (1886); *Elements of Psychology* (1893); *Social and Ethical Interpretations in Mental Development* (1898); *Story of the Mind* (1898); *Mental Development in the Child and the Race* (1896); *Thought and Things* (London and New York, vol. i., 1906). He also contributed largely to the *Dictionary of Philosophy and Psychology* (1901-1905), of which he was editor-in-chief.

BALDWIN, ROBERT (1804-1858), Canadian statesman, was born at York (now Toronto) on the 12th of May 1804. His father, William Warren Baldwin (d. 1844), went to Canada from Ireland in 1798; though a man of wealth and good family and a devoted member of the Church of England, he opposed the religious and political oligarchy which was then at the head of Canadian affairs, and brought up his son in the same principles. Robert Baldwin was called to the Bar in 1825, and entered into partnership with his father. In 1829 he was elected a member of the parliament of Upper Canada for the town of York, but was defeated in the following year and retired for a time into private life. During the next six years, he so constantly advocated a responsible executive as the one cure for the political and economic evils of the time that he was known as "the man of one idea." In 1836 he was called by Sir Francis Bond Head (1793-1875), the lieutenant-governor, to the executive council, but finding himself without influence, and compelled to countenance measures to which he was opposed, he resigned within a month. Though a reformer, he strongly disapproved of the rebellion of 1837-1838. On the union of the two Canadas he became (1841) a member of the executive council under Lord Sydenham, but soon resigned on the question of responsible government. In 1842 he formed the first Liberal administration, in connexion with Mr (afterwards Sir) L. H. Lafontaine, but resigned the next year, after a quarrel with the governor-general, Sir Charles Metcalfe, on a question of patronage, in which he felt that of responsible government to be involved. At the general election which followed, the governor-general was sustained by a narrow majority, but in 1848 the Liberals were again returned to power, and he and Mr Lafontaine formed their second administration under Lord Elgin and carried numerous important reforms, including the freeing from sectarian control of the Provincial University and the introduction into Upper Canada of an important municipal system.

Internal dissensions soon began to appear in the Liberal party, and in 1851 Mr Baldwin resigned. The special struggle leading to his resignation was an attempt to abolish the court of chancery of Upper Canada, whose constitution was due to a measure introduced by Baldwin in 1849. The attempt, though defeated, had been supported by a majority of the representatives from Upper Canada, and Baldwin's fastidious conscience took it as a vote of want of confidence. A deeper reason was his inability to approve of the advanced views of the Radicals, or "Clear Grits," as they came to be called. On seeking re-election in York, he declined to give any pledge on the burning question of the Clergy Reserves and was defeated. In 1858 the Liberal-Conservative party, formed in 1854 by a coalition, attempted to bring him out as a candidate for the upper house, which was at this date elective, but though he had broken with the advanced reformers, he could not approve of the tactics of their opponents, and refused to stand. He died on the 9th of December 1858. Even those who most bitterly attacked his measures admitted the purity and unselfishness of his motives. After the concession of responsible government, he devoted himself to bringing about

a good understanding between the English and French-speaking inhabitants of Canada, and his memory is held as dear among the French Canadians as in his native province of Ontario.

See J. C. Dent, *Canadian Portrait Gallery* (1886). His life, by the Hon. Geo. W. Ross, is included in *The Makers of Canada series* (Toronto).

BALE, JOHN (1495-1563), bishop of Ossory, English author, was born at Cove, near Dunwich in Suffolk, on the 21st of November 1495. At the age of twelve he entered the Carmelite monastery at Norwich, removing later to the house of "Holme," probably the abbey of the Whitefriars at Hulne near Alnwick. Later he entered Jesus College, Cambridge, and took his degree of B. D. in 1529. At Cambridge he came under the influence of Cranmer and of Thomas Wentworth, 1st Baron Wentworth, and became an ardent partisan of the Reformers. He laid aside his monastic habit, and, as he himself puts it with characteristically brutal violence, "that I might never more serve so execrable a beast, I took to wife the faithful Dorothy." He obtained the living of Thornden, Suffolk, but in 1534 was summoned before the archbishop of York for a sermon against the invocation of saints preached at Doncaster, and afterwards before Stokesley, bishop of London, but he escaped through the powerful protection of Thomas Cromwell, whose notice he is said to have attracted by his miracle plays. He was an unscrupulous controversialist, and in these plays he allows no considerations of decency to stand in the way of his denunciations of the monastic system and its supporters. The prayer of Infidelitas which opens the second act of his *Thre Lusus* (quoted by T. Warton, *Hist. Eng. Poetry*, sect. 41) is an example of the lengths to which he went in profane parody. These coarse and violent productions were well calculated to impress popular feeling, and no doubt Cromwell found in him an invaluable instrument. But on his patron's fall in 1540 Bale fled with his wife and children to Germany. He returned on the accession of Edward VI. He received the living of Bishopstoke, Hampshire, being promoted in 1552 to the Irish see of Ossory. He refused to be consecrated by the Roman rite, which still obtained in the Irish church, and won his point, though the dean of Dublin entered a protest against the revised office during the ceremony (see his *Vocacyge of John Bale to the Bishopperryche of Ossorie*, *Harl. Misc.* vol. vi.). He pushed his Protestant propaganda in Ireland with no regard to expediency, and when the accession of Mary inaugurated a reaction in matters of religion, it was with difficulty that he was got safely out of the country. He tried to escape to Scotland, but on the voyage was captured by a Dutch man-of-war, which was driven by stress of weather to St. Ives in Cornwall. Bale was arrested on suspicion of treason, but soon released. At Dover he had another narrow escape, but he eventually made his way to Holland and thence to Frankfort and Basel. During his exile he devoted himself to writing. After his return, on the accession of Elizabeth, he received (1560) a prebendal stall at Canterbury. He died in November 1563 and was buried in the cathedral.

The scurrility and vehemence with which "foul-mouthed Bale," as Wood calls him, attacked his enemies does not destroy the value of his contributions to literature, though his strong bias against Roman Catholic writers does detract from the critical value of his works. Of his mysteries and miracle plays only five have been preserved, but the titles of the others, quoted by himself in his *Catalogus*, show that they were animated by the same political and religious aims. *The Thre Lusus of Nature, Moses and Christ, corrupted by the Sodomities, Pharisees and Papystes most wicked* (pr. 1538 and again in 1562) was a morality play. The direction for the dressing of the parts is instructive: "Let Idolatry be decked like an old witch, Sodomy like a monk of all sects, Ambition like a bishop, Covetousness like a Pharisee or spiritual lawyer, False Doctrine like a popish doctor, and Hypocrisy like a gray friar." *A Tragedy; or enterule many-festing the chief promysyes of God unto Man* . . . (1538, printed in Dodsley's *Old Plays*, vol. 1), *The Temptacyon of our Lorde* (ed. A. B. Grosart in *Miscellanies of the Fuller Worthies Library*, vol. i., 1870), and *A breffe Comedy or Enterule of Johan Baptystes*

preachynge in the Wyldernes, &c. (*Harl. Misc.* vol. i.) were all written in 1538. His plays are doggerel, but he is a figure of some dramatic importance as the author of *Kynge Johan* (c. 1548), which marks the transition between the old morality play and the English historical drama. It does not appear to have directly influenced the creators of the chronicle histories. To the authors of the *Troublesome Raigne of King John* (1591) it was apparently unknown, but it is noteworthy that an attempt, however feeble, at historical drama was made fourteen years before the production of *Gorboduc*. *Kynge Johan* (ed. J. P. Collier, Camden Soc. 1838) is itself a polemic against the Roman Catholic Church. King John is represented as the champion of English rites against the Roman see:—

"This noble Kynge Johan, as a faythfull Moses
Withstode proude Pharao for his poore Israel."

But the English people remained in the bondage of Rome,—

"Tyll that duke Josue, which was our late Kynge Henrye,
Clerely brought us out in to the lande of mylke and honye."

Elsewhere John is called a Lollard and accused of "heretycall langage," and he is finally poisoned by a monk of Swinestede. Allegorical characters are mixed with the real persons. Ynglonde *vidua*, represents the nation, and the jocular element is provided by Sedwyson (sedition), who would have been the Vice in a pure morality play. One actor was obviously intended to play many parts, for stage directions such as "Go out Ynglonde, and dress for Clargy" are by no means uncommon. The MS. of *Kynge Johan* was discovered between 1831 and 1838 among the corporation papers at Ipswich, where it was probably performed, for there are references to charitable foundations by King John in the town and neighbourhood. It is described at the end of the MS. as two plays, but there is no obvious division, the end of the first act alone being noted. The first part is corrected by Bale and the latter half is in his handwriting, but his name nowhere occurs. In the list of his works, however, he gives a play *De Joanne Anglorum Rege, written in idioma materno*.

But Bale's most important work is *Illustrium majoris Britanniae scriptorum, hoc est, Angliae, Cambriae, ac Scotiae Summarium* . . . (Ipswich and Wesel, for John Overton, 1548, 1540). This contained five centuries, but another edition, almost entirely rewritten and containing fourteen centuries, was printed at Basel with the title *Scriptorium Illustrium majoris Britanniae* . . . *Catalogus* (1557-1559). The chronological catalogue of British authors and their works was partly founded on the *Collectanea et Commentarii* of John Leland, but Bale was an indefatigable collector and worker, and himself examined many of the valuable libraries of the Augustinian and Carmelite houses before their dissolution. In his notebook he records as an instance of the wholesale destruction in progress: "I have been also at Norwyche, our second citey of name, and there all the library monuments are turned to the use of their grossers, candelmakers, soppellers, and other worldly occupiers . . . As much have I saved there and in certain other places in Northfolke and Southfolke concerning the authors names and titles of their workes, as I could, and as much wold I have done through out the whole realm, yf I had been able to have borne the charges, as I am not." His work is therefore invaluable, in spite of the inaccuracies and the abuse lavished on Catholic writers, for it contains much information that would otherwise have been hopelessly lost.

A list of Bale's works is to be found in *Aethnae Cantabrigiensis* (vol. i. pp. 227 et seq.). Beside the reprints already mentioned, *The Examinations of Lord Cobham, William Thorpe and Anne Askewe, &c.* were edited by the Rev. H. Christmas for the Parker Society in 1849. Bale's autograph note-book is preserved in the Selden Collection of the Bodleian Library, Oxford. It contains the materials he collected for his two published catalogues arranged alphabetically, with no attempt at ornament of any kind, and without the personalities which deface his completed work. He also gives in most cases the sources from which his information was derived. This book was prepared for publication with notes by Dr R. Lane Poole, with the help of Miss Mary Bateson, as *Index Britanniae Scriptorum quos . . . collegit Ioannes Baleus* (Clarendon Press, 1902), forming part of *Index of Aeneadae Ioannis*.

John Pits or Pitseus (1560-1616), an English Catholic exile, founded on Bale's work his *Relationum historicarum de rebus anglis tomus primus* (Paris, 1619), better known by its running title of

De illustribus Angliæ scriptoribus. This is really the fourth book of a more extensive work. He omits the Wycliffite and Protestant divines mentioned by Bale, and the most valuable section is the lives of the Catholic exiles resident in Douai and other French towns. He does not scruple to assert (*Nota de Joanne Bale*) that Bale's *Catalogus* was a misrepresentation of Leland's matter, though there is every reason to believe that he was only acquainted with Leland's work at second-hand, through Bale.

BALE. (1) (A word common to Teutonic languages, in O. Eng. *balu*, cf. Icelandic *ból*), evil, suffering, a word obsolete except in poetry, and more common in the adjectival form "baleful." In early alliterative poetry it is especially used antithetically with "bliss." (2) (O. Eng. *bael*, a blazing fire, a funeral pyre), a bonfire, a northern English use more common in the tautological "bale-fire," with sometimes a confused reference from (1) to evil. (3) (A word of doubtful origin, possibly connected with "ball"), a bundle of merchandise, especially of cotton, wool or hay, packed with a cover, or fastened with bands of metal, &c. for transportation; the weight and capacity varies with the goods. (4) (Properly "ball," from Fr. *baïlle*, possibly connected with Lat. *bacula*, a tub), to empty water out of a boat by means of a bail or bucket.

BALEARIC ISLANDS (*Baleares*), an archipelago of four large and eleven small islands in the Mediterranean Sea, off the east coast of Spain, of which country it forms a province. Pop. (1900) 311,649; area, 1935 sq. m. The archipelago, which lies between 38° 40' and 40° 5' N., and between 1° and 5° E., comprises two distinct groups. The eastern and larger group, corresponding with the ancient *Insulæ Baleares*, comprises the two principal members of the archipelago, Majorca (Spanish, *Mallorca*) and Minorca (Spanish, *Menorca*), with seven islets:—Aire, Aucanada, Botafoch, Cabrera, Dragoneria, Pinto and El Rey. The western group, corresponding with the ancient *Pityusæ* or Pine Islands, also comprises two relatively large islands, *Iviza* (Spanish, *Ibiza* or, formerly, *Ivica*) and *Formentera*, with the islets of *Ahorcados*, *Conejera*, *Pou* and *Espalmador*. Majorca, Minorca and *Iviza* are described in separate articles. *Formentera* is described with *Iviza*. The total population of the eleven islets only amounted to 171 in 1900, but all were inhabited. None of them is of any importance except *Cabrera*, which is full of caverns, and was formerly used as a place of banishment. In 1808 a large body of Frenchmen were landed here by their Spanish captors, and allowed almost to perish of starvation.

The origin of the name *Baleares* is a mere matter of conjecture; it is obvious, however, that the modern Majorca and Minorca are obtained from the Latin *Majar* and *Minor*, through the Byzantine forms *Μαγιορική* and *Μινωρική*; while *Iviza* is plainly the older *Ebusus*, a name probably of Carthaginian origin. The *Ophiusa* of the Greeks (*Colubraria* of the Romans) is now known as *Formentera*.

Geology.—The strata which form the Balearic Isles fall naturally into two divisions. There is an older series, ranging from the Devonian to the Cretaceous, which is folded and faulted and forms all the higher hills, and there is a newer series of Tertiary age, which lies nearly horizontal and rests unconformably upon the older beds. The direction of the folds in the older series is in *Iviza* nearly west to east, in Majorca south-west to north-east, and in Minorca south to north, thus forming an arc convex towards the south-east. The Devonian is visible only in Minorca, the Trias being the oldest system represented in the other islands. The higher part of the Cretaceous is absent, and it appears to have been during this period that the principal folding of the older beds took place. The Eocene beds are nummulitic. There is a lacustrine group which has usually been placed in the Lower Eocene, but the discovery of *Anthrocotherium magnum* in the interbedded lignites proves it to be Oligocene, in part at least. The Miocene included a limestone with *Clypeaster*. Pliocene beds also occur.

Climate, Fauna, Flora.—The climate of the archipelago, though generally mild, healthy and favourable to plant life, is by no means uniform, owing to the differences of altitude and shelter from wind in different islands. The fauna and flora resemble those of the Mediterranean coasts of Spain or France.

Inhabitants.—The islanders are a Spanish race, very closely akin to the Catalans; but the long period of Moorish rule has left its mark on their physical type and customs. In character they are industrious and hospitable, and pique themselves on their loyalty and orthodoxy. Crime is rare. There are higher schools in the principal towns, and the standard of primary education is well up to the average of Spain. Vaccination is common except in the cities,—the women often performing the operation themselves when medical assistance cannot be got. Castilian is spoken by the upper and commercial classes; the lower and agricultural employ a dialect resembling that of the Catalans.

Commerce.—Fruit, grain, wine and oil are produced in the islands, and there is an active trade with Barcelona in fresh fish, including large quantities of lobsters. Shoemaking is one of the most prosperous industries. There is not a very active trade direct with foreign countries, as the principal imports—cotton, leather, petroleum, sugar, coal and timber—are introduced through Barcelona. The export trade is chiefly with the Peninsula, France, Italy, Algeria and with Cuba and Porto Rico. Most of the agricultural products are sent to the Peninsula; wine, figs, marble, almonds, lemons and rice to Europe and Africa.

Administration.—The administration of the Balearic Islands differs in no respect from that of the other Spanish provinces on the mainland. There are five judicial districts (*partidos judiciales*), named after their chief towns—Inca, *Iviza*, Manacor, Palma and Port Mahon.

History.—Of the origin of the early inhabitants of the Balearic Islands nothing is certainly known, though Greek and Roman writers refer to the Boeotian and Rhodian settlements. There are numerous sepulchral and other monuments, which are generally believed to be of prehistoric origin. According to general tradition the natives, from whatever quarter derived, were a strange and savage people till they received some tincture of civilization from the Carthaginians, who early took possession of the islands and built themselves cities on their coasts. Of these cities, Port Mahon, the most important, still retains the name which is derived from the family of Mago. About twenty-three years after the destruction of Carthage the Romans accused the islanders of piracy, and sent against them Q. Cæcilius Metellus, who soon reduced them to obedience, settled amongst them 3000 Roman and Spanish colonists, founded the cities of Palma and Pollentia (*Pollensa*), and introduced the cultivation of the olive. Besides valuable contingents of the celebrated Balearic slingers, the Romans derived from their new conquest mules (from Minorca), edible snails, sinope and pitch. Of their occupation numerous traces still exist,—the most remarkable being the aqueduct at Pollensa. In A.D. 423 the islands were seized by the Vandals and in 798 by the Moors. They became a separate Moorish kingdom in 1009, which, becoming extremely obnoxious for piracy, was the object of a crusade directed against it by Pope Paschal II., in which the Catalans took the lead. This expedition was frustrated at the time, but was resumed by James I. of Aragon, and the Moors were expelled in 1323. During their occupation the island was populous and productive, and an active commerce was carried on with Spain and Africa. King James conferred the sovereignty of the isles on his third son, under whom and his successor they formed an independent kingdom up to 1349, from which time their history merges in that of Spain. In 1521 an insurrection of the peasantry against the nobility, whom they massacred, took place in Majorca, and was not suppressed without much bloodshed. In the War of the Spanish Succession all the islands declared for Charles; the duke of Anjou had no footing anywhere save in the citadel of Mahon. Minorca was reduced by Count Villars in 1707; but it was not till June 1715 that Majorca was subjugated, and meanwhile Port Mahon was captured by the English under General Stanhope in 1708. In 1713 the island was secured to them by the peace of Utrecht; but in 1756 it was invaded by a force of 12,000 French, who, after defeating the British under Admiral Byng, captured Port Mahon. Restored to England in

1763, the island remained in possession of the British till 1782, when it was retaken by the Spaniards. Again seized by the British in 1798, it was finally ceded to Spain by the peace of Amiens in 1803. When the French invaded Spain in 1808, the Mallorquins did not remain indifferent; the governor, D. Juan Miguel de Vives, announced, amid universal acclamation, his resolution to support Ferdinand VII. At first the Junta would take no active part in the war, retaining the corps of volunteers that was formed for the defence of the island; but finding it quite secure, they transferred a succession of them to the Peninsula to reinforce the allies. Such was the animosity excited against the French when their excesses were known to the Mallorquins, that some of the French prisoners, conducted thither in 1810, had to be transferred with all speed to the island of Cabrera, a transference which was not effected before some of them had been killed.

BIBLIOGRAPHY.—For a general account of the islands, the most valuable books are *Die Balearen geschicht in Wort und Bild*, by the archduke Ludwig Salvator of Austria (Leipzig, 1896); *Les Îles oubliées*, by G. Vuillier (Paris, 1904), the first edition of which has been translated under the title of *The Forgotten Isles* (London, 1896)—and *Islas Baleares*, an illustrated volume of 1423 pages, by P. Pifferrer, in the series "España" (Barcelona, 1888). An article by George Sand in the *Revue des deux mondes* (1841) also deserves notice. The following are monographs on special subjects:—*The Story of Majorca and Minorca*, by Sir C. R. Markham (London, 1908); *Illustrations florae insularum Balearicarum*, by M. Wilkomm (Stuttgart, 1881–1892); *Monuments primitifs des Îles baléares*, by E. Cartailhac (*Mission scientifique du ministère de l'instruction publique*, Toulouse, 1892). The *British Foreign Office Reports for the Consular District of Barcelona* give some account of the movement of commerce (London, annual). Much of the material available for a scientific history will be found in *La Historia general del reino balearico*, by J. Darneto and V. Mut (Majorca, 1632–1650). For the period of Moorish rule, see *Bosquejo histórico de la dominación islámica en las islas Baleares*, by A. Campaner y Fuentes (Palma, 1888). See also the elaborate treatise *Les Relations de la France avec le royaume de Majorque*, by A. Lecocq de la Marche (Paris, 1892).

BALES [BALESIUS], **PETER** (1547–1610?), English calligrapher, one of the inventors of shorthand writing, was born in London in 1547, and is described by Anthony Wood as a "most dexterous person in his profession, to the great wonder of scholars and others." We are also informed that "he spent several years in sciences among Oxonians, particularly, as it seems, in Gloucester Hall; but that study, which he used for a diversion only, proved at length an employment of profit." He is mentioned for his skill in micrography in Holinshed's *Chronicle*. "Hadrian Junius," says Evelyn, "speaking as a miracle of somebody who wrote the Apostles' Creed and the beginning of St John's Gospel within the compass of a farthing: what would he have said of our famous Peter Bales, who, in the year 1575, wrote the Lord's Prayer, the Creed, Decalogue, with two short prayers in Latin, his own name, motto, day of the month, year of the Lord, and reign of the queen, to whom he presented it at Hampton Court, all of it written within the circle of a single penny, inclosed in a ring and borders of gold, and covered with a crystal, so accurately wrought as to be very plainly legible; to the great admiration of her majesty, the whole privy council, and several ambassadors then at court?" Bales was likewise very dexterous in imitating handwritings, and between 1576 and 1590 was employed by Secretary Walsingham in certain political manoeuvres. We find him at the head of a school near the Old Bailey, London, in 1590, in which year he published his *Writing Schoolemaster, in three Parts*. This book included an *Arte of Brachygraphie*, which is one of the earliest attempts to construct a system of shorthand. In 1595 he had a great trial of skill with one Daniel Johnson, for a golden pen of £20 value, and won it; and a contemporary author further relates that he had also the arms of calligraphy given him, which are azure, a pen or. Bales died about the year 1610.

BALFE, MICHAEL WILLIAM (1808–1870), Irish musical composer, was born on the 15th of May 1808, at Dublin. His musical gifts became apparent at an early age. The only instruction he received was from his father, who was a dancing master, and from a musician, C. E. Horn (1786–1849). Between 1814 and

1815 he played the violin for his father's dancing-classes, and at the age of seven composed a polacca. In 1817 he appeared as a violinist in public, and in this year composed a ballad, first called "Young Fanny" and afterwards, when sung in *Paul Pry* by Madame Vestris, "The Lovers' Mistake." On the death of his father in 1823 he was engaged in the orchestra of Drury Lane, and being in possession of a small but pleasant baritone voice, he chose the career of an operatic singer. An unsuccessful début was made at Norwich in *Der Freischütz*. In 1825 he was taken to Rome by Count Mazzara, being introduced to Cherubini on the way. In Italy he wrote his first dramatic work, a ballet, *La Pérouse*. At the close of 1827 he appeared as Figaro in Rossini's *Barbire*, at the Italian opera in Paris. Balfe soon returned to Italy, where, during the next nine years, he remained, singing at various theatres and composing a number of operas. During this time he married Mdle Luisa Roser, a Hungarian singer whom he had met at Bergamo. Féting says that the public indignation roused by an attempt at "improving" Meyerbeer's opera *Il Crociato* by interpolated music of his own compelled Balfe to throw up his engagement at the theatre La Fenice in Venice. By this time he had produced his first complete opera, *I Rivali di se stessi*, at Palermo in the carnival season of 1829–1830; the opera *Un Avvertimento ai gelosi* at Pavia; and *Enrico Crispo* at Milan, where he had been engaged to sing with Malibran at the Scala. He returned to England in the spring of 1833, and on the 29th of October 1835 his *Siege of Rochelle* was produced and rapturously received at Drury Lane. Encouraged by his success, he produced *The Maid of Artois* on the 27th of May 1836—the success of the opera being confirmed by the exquisite singing of Malibran. Balfe was a prolific composer, as may be seen from the following imperfect list of his English operas alone:—*Siege of Rochelle* (1835); *The Maid of Artois* (1836); *Catherine Grey* (1837); *Joan of Arc* (1837); *Falstaff* (1838, Lablache in title-rôle); *Amelia*, or *The Love Test* (1838); *Koolanthe* (1841); *The Bohemian Girl*, his best known work (1844); *The Daughter of St. Mark* (1844); *The Enchantress* (1845); *The Bondman* (1846); *The Devil's in it* (1847); *The Maid of Honour* (1847); *The Sicilian Bride* (1852); *The Rose of Castile* (1857); *Satanella* (1858); *Bianca* (1860); *The Puritan's Daughter* (1861); *The Armourer of Nantes* (1863); *Blanche de Nevers* (1863). Balfe also wrote several operas for the Opéra Comique and Grand Opéra in Paris, where MM. Scribe and St George provided him with the libretti for his *Le Puis d'amour* (1843) and his *Les Quatre Fils Aymon* (1844). His *L'Étoile de Seville* was written in 1845 for the Académie Royale. The fact that Balfe was an Irishman, who produced operas in English, French and Italian with conspicuous success, is in itself interesting. When to this we add the record of his operatic impersonations on the stage, the European success of his *Bohemian Girl*, his picturesque retirement into Hertfordshire in 1864 as a gentleman farmer, and above all the undeniable gift for creating such pure melodies as his songs "When other Hearts" and "I dream that I dwell in marble halls," it is idle to refuse him a prominent place in the history of music. He wrote much that was trivial, but also much that was enduring. He died on the 20th of October 1870, and was buried at Kensal Green. In 1882 a medallion portrait of him was unveiled in Westminster Abbey.

BALFOUR, ARTHUR JAMES (1848—), British statesman, eldest son of James Maitland Balfour of Whittingehame, Haddingtonshire, and of Lady Blanche Gascoyne Cecil, a sister of the third marquis of Salisbury, was born on the 25th of July 1848. He was educated at Eton and Trinity College, Cambridge. In 1874 he became M.P. in the Conservative interest for Hertford, and represented that constituency until 1885. When, in the spring of 1878, Lord Salisbury became foreign minister on re-termination of the fifteenth Lord Derby, Mr Balfour became his private secretary. In that capacity he accompanied his uncle to the Berlin congress, and gained his first experience of international politics in connexion with the settlement of the Russo-Turkish conflict. It was at this time also that he became known in the world of letters, the intellectual subtlety and literary capacity of his *Defence of Philosophic Doubt* (1879) suggesting that he might make a reputation as a speculative thinker. Belonging, however, to a

class in which the responsibilities of government are a traditional duty, Mr Balfour divided his time between the political arena and the study. Being released from his duties as private secretary by the general election of 1880, he began to take a rather more active part in parliamentary affairs. He was for a time politically associated with Lord Randolph Churchill, Sir Henry Drummond Wolff and Sir John (then Mr) Gorst, the quartette becoming known as the "Fourth Party," and gaining notoriety by the freedom of the criticisms directed by its leader, Lord Randolph Churchill, against Sir Stafford Northcote, Lord Cross and other prominent members of the "old gang." In these sallies, however, Mr Balfour had no direct share. He was thought to be merely amusing himself with politics. It was regarded as doubtful whether his health could withstand the severity of English winters, and the delicacy of his physique and the languor of his manner helped to create the impression that, however great his intellectual powers might be, he had neither the bodily strength nor the energy of character requisite for a political career. He was the "odd man" of the Fourth Party, apparently content to fetch and carry for his colleagues, and was believed to have no definite ambitions of his own. His reputation in the parliament of 1880-1886 was that of a dilettante, who allied himself with the three politicians already named from a feeling of irresponsibility rather than of earnest purpose; he was regarded as one who, on the rare occasions when he spoke, was more desirous to impart an academic quality to his speeches than to make any solid contribution to public questions. The House, indeed, did not take him quite seriously. Members did not suspect the reserve of strength and ability beneath what seemed to them to be the pose of a parliamentary *flâneur*; they looked upon him merely as a young member of the governing classes who remained in the House because it was the proper thing for a man of family to do. As a member of the coterie known as the "Souls" he was, so to speak, caviare to the general. Indolence was supposed to be the keynote of his character—a refined indolence, not, however, without cleverness of a somewhat cynical and superior order.

That these views were not shared by Lord Salisbury was sufficiently shown by the fact that in his first administration (June 1885-January 1886) he made Mr Balfour president of the Local Government Board, and in forming his second administration (July 1886) secretary for Scotland with a seat in the cabinet. These offices gave few opportunities for distinction, and may be regarded merely as Mr Balfour's apprenticeship to departmental responsibilities. The accidents of political life suddenly opened out to him a career which made him, next to Lord Salisbury, the most prominent, the most admired and the most attacked Conservative politician of the day. Sir Michael Hicks-Beach, who was chief secretary for Ireland, suffered from an affection of the eyes and found it desirable to resign, and Lord Salisbury appointed his nephew in his stead. The selection took the political world by surprise, and was much criticized. By the Irish Nationalists it was received with contemptuous ridicule, for none suspected Mr Balfour's immense strength of will, his debating power, his ability in attack and his still greater capacity to disregard criticism. The debates on the Crimes Bill and the Irish Land Bill quickly undeceived them, and the steady and even remorseless vigour with which the government of Ireland was conducted speedily convinced the House of Commons and the country that Mr Balfour was in his right place as chief secretary. His policy was that of "coercion"—the fearless administration of the Crimes Act,—coupled with remedial legislation; and he enforced the one while he proceeded with the other, regardless of the risk of outrage outside the House and of insult within. Mr Balfour's work in this office covered one of the most turbulent and most exciting periods in modern parliamentary history and Irish administration. With a courage that never faltered he broke down the Plan of Campaign in Ireland, and in parliament he not only withstood the assaults of the Irish Nationalists, but waged successful warfare with the entire Home Rule party. He combined an obstinacy of will with a mastery of facts unsurpassed by any of his predecessors in the secretaryship. Events, it is true, were in his favour. The disclosures before the Parnell Commission, the O'Shea divorce

proceedings, the downfall of Mr Parnell and the disruption of the Irish party, assisted him in his task; but the fact remains that by persistent courage and undeviating thoroughness he reduced crime in Ireland to a vanishing point. His work was also constructive, for he broadened the basis of material prosperity and social progress by creating the Congested Districts Board in 1890. During this period, from 1886-1892, moreover, he developed gifts of oratory which made him one of the most effective of public speakers. Impressive in matter rather than in manner of delivery, and seldom rising to the level of eloquence in the sense in which that quality was understood in a House which had listened to Bright and Gladstone, his speeches were logical and convincing, and their attractive literary form delighted a wider audience than that which listens to the mere politician.

In 1888 Mr Balfour served on the Gold and Silver Commission, currency problems from the standpoint of bimetalism being among the more academic subjects which had engaged his attention. On the death of Mr W. H. Smith in 1891 he became first lord of the treasury and leader of the House of Commons, and in that capacity introduced in 1892 a Local Government Bill for Ireland. The Conservative government was then at the end of its tether, and the project fell through. For the next three years Mr Balfour led the opposition with great skill and address. On the return of the Unionists to power in 1895 he resumed the leadership of the House, but not at first with the success expected of him, his management of the abortive education proposals of '96 being thought, even by his own supporters, to show a disinclination for the continuous drudgery of parliamentary management under modern conditions. But after the opening session matters proceeded more smoothly, and Mr Balfour regained his old position in the estimation of the House and the country. He had the satisfaction of seeing a bill pass for providing Ireland with an improved system of local government, and took an active share in the debates on the various foreign and domestic questions that came before parliament during 1895-1900. His championship of the voluntary schools, his adroit parliamentary handling of the problems opened up by the so-called "crisis in the Church" caused by the Protestant movement against ritualistic practices, and his pronouncement in favour of a Roman Catholic university for Ireland—for which he outlined a scheme that met with much adverse criticism both from his colleagues and his party,—were the most important aspects of Mr Balfour's activity during these years. His speeches and work throughout this period took a wider range than before his accession to the leadership of the Commons. During the illness of Lord Salisbury in 1898, and again in Lord Salisbury's absence abroad, he was in charge of the foreign office, and it fell to his lot to conduct the very critical negotiations with Russia on the question of railways in North China. To his firmness, and at the same time to the conciliatory readiness with which he accepted and elaborated the principles of a *modus vivendi*, the two powers owed the avoidance of what threatened to be a dangerous quarrel. As a member of the cabinet responsible for the Transvaal negotiations in 1899 he bore his full share of controversy, and when the war opened so disastrously he was the first to realize the necessity for putting the full military strength of the country into the field. At the general election of 1900 he was returned for East Manchester (which he had represented since 1885) by a majority of 2453, and continued in office as first lord of the treasury. His leadership of the House of Commons in the first session of the new parliament was marked by considerable firmness in the suppression of obstruction, but there was a slight revival of the criticisms which had been current in 1896. Mr Balfour's inability to get the maximum amount of work out of the House was largely due to the situation in South Africa, which absorbed the intellectual energies of the House and of the country and impeded the progress of legislation.

The principal achievements of the long session of 1902 (which extended to the autumn) were the passing of the Education Act,—entirely reorganizing the system of primary education, abolishing the school boards and making the county councils the local authority; new rules of procedure; and the creation

of the Metropolitan Water Board; and on all these questions, and particularly the two first, Mr Balfour's powers as a debater were brilliantly exhibited.

On Lord Salisbury's resignation on the 11th of July 1902, Mr Balfour succeeded him as prime minister, with the cordial approval of all sections of the Unionist party. For the next three and a half years his premiership involves the political history of England, at a peculiarly interesting period both for foreign and domestic affairs. Within a few weeks Mr Balfour had reconstituted the cabinet. He himself became first lord of the treasury and lord privy seal, with the duke of Devonshire (remaining lord president of the council) as leader of the House of Lords; Lord Lansdowne remained foreign secretary, Mr (afterwards Lord) Ritchie took the place of Sir Michael Hicks-Beach (afterwards Lord St Aldwyn) as chancellor of the exchequer, Mr J. Chamberlain remained colonial secretary, his son Austen being postmaster-general with a seat in the cabinet. Mr G. Wyndham as chief secretary for Ireland was included in the cabinet; Lord Selborne remained at the admiralty, Mr St John Brodrick (afterwards Lord Midleton) war minister, Lord George Hamilton secretary for India, and Mr Akers-Douglas, who had been first commissioner of works, became home secretary; Lord Balfour of Burleigh remained secretary for Scotland, Lord Dudley succeeded Lord Cadogan as lord lieutenant of Ireland, and Lord Londonderry became president of the Board of Education (with Sir William Anson as parliamentary secretary in the House of Commons). Mr Balfour's brother Gerald (b. 1853), who had entered public life as his private secretary when at the Local Government Board, and had been chief secretary for Ireland from 1895-1900, retained his position (since 1900) as president of the Board of Trade.

The new prime minister came into power practically at the same moment as the king's coronation (see EDWARD VII.) and the end of the South African War (see TRANSVAAL). The task of clearing up after the war, both in South Africa and at home, lay before him; but his cordial relations with Mr Chamberlain (q.v.), and the enthusiastic support of a large parliamentary majority, made the prospects fair. For a while no cloud appeared on the horizon: and the Liberal party were still disorganized (see CAMPBELL-BANNERMAN and ROSEBERY) over their attitude towards the Boers. Mr Chamberlain went to South Africa in the late autumn, with the hope that his personality would influence the settlement there; and the session of 1903 opened in February with no hint of troubles to come. A difficulty with Venezuela, resulting in British and German co-operation to coerce that refractory republic, caused an explosion of anti-German feeling in England and some restlessness in the United States, but the government brought the crisis to an end by tactful handling and by an ultimate recourse to arbitration. The two chief items of the ministerial parliamentary programme were the extension of the new Education Act to London and Mr Wyndham's Irish Land Purchase Act, by which the British exchequer should advance the capital for enabling the tenants in Ireland to buy out the landlords. Moreover, the budget was certain to show a surplus and taxation could be remitted. As events proved, it was the budget which was to provide a cause of dissension, bringing a new political movement into being, and an issue overriding all the legislative interest of the session. Mr Ritchie's remission of the shilling import-duty on corn led to Mr Chamberlain's crusade in favour of tariff reform and colonial preference, and as the session proceeded the rift grew in the Unionist ranks.

In the separate article on Mr Chamberlain the progress of this movement is sufficiently narrated. From this moment it is only necessary here to realize Mr Balfour's position. He had always admitted the oneness of the English free-trade system, and had supported the desirability of retaliating against unfair competition and "dumping" by foreign countries. But Mr Chamberlain's new programme for a general tariff, with new taxes on food arranged so as to give a preference to colonial products, involved a radical alteration of the established fiscal system, and such out-and-out Unionist free-traders in the cabinet

as Mr Ritchie and Lord George Hamilton, and outside it, like Lord Hugh Cecil and Mr Arthur Elliot (secretary to the treasury), were entirely opposed to this. Mr Balfour was anxious to avoid a rupture, doubtful of the feeling of the country, uncertain of the details by which Mr Chamberlain's scheme could be worked out. As leader of the party and responsible for the maintenance of so great a political engine, he was anxious not to be precipitate. He was neither for nor against the new movement, and professed to hold "no settled convictions" on the subject. Mr Chamberlain rested his case largely on the alleged diminution in British trade, and the statistics therefore required investigation before the government could adopt any such programme. From the middle of May, when Mr Chamberlain began to press the matter, Mr Balfour had a difficult hand to play, so long as it was uncertain how the party would follow the new lead. The Board of Trade was asked to supply full figures, and while its report was awaited the uncertainty of attitude on the part of the government afforded grateful opportunity for opposition mischief-making, since the Liberal party had now the chance of acting as the conservative champions of orthodox economics. Another opportunity for making political capital was provided by the publication of the report of the royal commission on the Boer War under Lord Elgin's chairmanship, which horrified the country by its disclosures (August 26th) as to the political and military muddling which had gone on, and the want of any efficient system of organization.

The session ended in August without any definite action on the fiscal question, but in the cabinet the discussions continued. On the 16th of September Mr Balfour published a pamphlet on "Insular Free Trade," and on the 18th it was announced that Lord George Hamilton and Mr Ritchie had resigned, Lord Balfour of Burleigh and Mr Arthur Elliot following a day or two later. These were the strait free-traders, but at the same time Mr Chamberlain resigned also. The correspondence between Mr Chamberlain and Mr Balfour (September 9th and 16th) was published, and presented the latter in the light of a sympathizer with some form of fiscal union with the colonies, if practicable, and in favour of retaliatory duties, but unable to believe that the country was yet ready to agree to the taxation of food required for a preferential tariff, and therefore unwilling to support that scheme; at the same time he encouraged Mr Chamberlain to test the feeling of the public and to convert them by his missionary efforts outside the government. Mr Chamberlain on his side emphasized his own parliamentary loyalty to Mr Balfour. In his pamphlet on "Insular Free Trade" the prime minister reviewed the economic history since Cobden's time, pointed to the falsification of the promises of the early free-traders, and to the fact that England was still the only free-importing country, and insisted that he was "in harmony with the true spirit of free-trade" when he pleaded for "freedom to negotiate that freedom of exchange may be increased." This manifesto was at first taken, not only as the platform of the government, but also as that from which its resigning free-trade members had dissented; and the country was puzzled by a statement from Lord George Hamilton that Mr Balfour had circulated among his colleagues a second and different document, in fuller agreement with Mr Chamberlain. The situation was confused by personal suspicion and distrust as well as by economic difficulties. But the public noted that the duke of Devonshire, whose orthodoxy was considered typical, remained in the cabinet.

The crisis, however, soon developed further, owing to explanations between the free-trade Unionists. On October 1st Mr Balfour spoke at Sheffield, reiterating his views as to free-trade and retaliation, insisting that he "intended to lead," and declaring that he was prepared at all events to reverse the traditional fiscal policy by doing away with the axiom that import duties should only be levied for revenue purposes. The speech was enthusiastically received by the National Union of Conservative Associations, who had year by year flirted with protectionist resolutions, and who were known to be predominantly in sympathy with Mr Chamberlain. But the free-traders did not like Mr Balfour's formula as to reversing the traditional

fiscal policy of import taxes for revenue only. Next day the duke of Devonshire resigned, a step somewhat bitterly resented by Mr Balfour, who clearly thought that his sacrifices in order to conciliate the duke had now been made in vain. During this critical fortnight the duke had apparently acquiesced in Mr Balfour's compromise, and had co-operated in reconstituting the ministry; his nephew and heir had been made financial secretary to the treasury, while Mr Alfred Lyttelton was appointed colonial secretary, Mr Austen Chamberlain chancellor of the exchequer, Mr Brodrick secretary for India, Mr H. O. Arnold-Forster war minister, Lord Stanley postmaster-general and Mr Graham Murray secretary for Scotland. Lord Lansdowne now became president of the council, Lord Lansdowne leader of the House of Lords, and Lord Salisbury, son of the late premier, who as Lord Cranborne had for three years been under-secretary for foreign affairs, was included in the cabinet as lord privy seal.

During the remainder of 1903 the struggle within the Unionist party continued. Mr Chamberlain spoke all over the country, advocating a definite scheme for reorganizing the budget, so as to have more taxes on imports, including food, but proposing to adjust the taxation so as to improve the position of the working-classes and to stimulate employment. The free-trade Unionists, with the duke of Devonshire, Lord Goschen, Lord James and Lord Hugh Cecil, as their chief representatives, started a Free Food league in opposition to Mr Chamberlain's Tariff Reform league; and at a great meeting at Queen's Hall, London, on the 24th of November their attitude was made plain. They rejected Mr Chamberlain's food-taxes, discredited his statistics, and, while admitting the theoretical orthodoxy of retaliation, criticized Mr Balfour's attitude and repudiated his assumption that retaliation would be desirable. Finally in December came the appointment of Mr Chamberlain's Tariff Commission. There was no doubt about the obstinacy and persistency of both sections, and both were fighting, not only to persuade the public, but for the capture of the party and of its prime minister. Both sides were inclined to claim him; neither could do so without qualification. His dialectical dexterity in evading the necessity of expressing his fiscal opinions further than he had already done became a daily subject for contemptuous criticism in the Liberal press; but he insisted that in any case no definite action could be taken till the next parliament; and while he declined to go the "whole hog"—as the phrase went—with Mr Chamberlain, he did nothing to discourage Mr Chamberlain's campaign. Whether he would eventually follow in the same direction, or would come back to the straiter free-trade side, continued to be the political conundrum for month after month. Minor changes were made in the ministry in 1903, Mr Brodrick going to the India office and Mr Arnold-Forster becoming minister for war, but Mr Balfour's personal influence remained potent, the government held together, and in 1904 the Licensing Bill was successfully carried. Though a few Unionists transferred their allegiance, notably Mr Winston Churchill, and by-elections went badly, Mr Balfour still commanded a considerable though a dwindling majority, and the various contrivances of the opposition for combining all free-traders against the government were obstructed by the fact that anything tantamount to a vote of censure would not be supported by the "wobblers" in the ministerial party, while the government could always manage to draft some "safe" amendment acceptable to most of them. This was notably shown in the debate on Mr Black's motion on the 18th of May. On the 3rd of October Mr Balfour spoke at Edinburgh on the fiscal question. The more aggressive protectionists among Mr Chamberlain's supporters had lately become very confident, and Mr Balfour plainly repudiated "protection" in so far as it meant a policy aiming at supporting or creating home industries by raising home prices; but he introduced a new point by declaring that an Imperial Conference would be called to discuss with the colonies the question of preferential tariffs if the Unionist government obtained a majority at the next general election. The Edinburgh speech was again received with conflicting interpretations, and much discussion prevailed as to the

conditions of the proposed conference, and as to whether it was or was not an advance, as the Chamberlainites claimed, towards Mr Chamberlain. Meanwhile the party was getting more and more disorganized, and the public were getting tired of the apparent mystification. The opposition used the situation to make capital in the country, and loudly called for a dissolution.

It was plain indeed that the fiscal question itself was ripe for the polls; Board of Trade statistics had been issued in profusion, and the whole case was before the country. But, though Mr Chamberlain declared his desire for an early appeal to the electors, he maintained his parliamentary loyalty to Mr Balfour. There were, moreover, public reasons why a change of government was undesirable. From 1903 onwards the question of army reform had been under discussion, and the government was anxious to get this settled, though in fact Mr Brodrick's and Mr Arnold-Forster's schemes for reorganization failed to obtain any general support. And while foreign affairs were being admirably conducted by Lord Lansdowne, they were critical enough to make it dangerous to contemplate a "swopping of horses." The Russo-Japanese War might at any moment lead to complications. The exercise by Russian warships of the right of search over British ships was causing great irritation in English commercial circles during 1904; after several incidents had occurred, the stopping of the P. & O. steamer "Malacca" on July 13th in the Red Sea by the Russian volunteer cruiser "Peterburg" led to a storm of indignation, and the sinking of the "Knight Commander" (July 24th) by the Vladivostok squadron intensified the feeling. On the 23rd of October the outrageous firing by the Russian Baltic fleet on the English fishing-fleet off the Dogger Bank in the North Sea was within an ace of causing war. It was not till the 28th that Mr Balfour, speaking at Southampton, was able to announce that the Russian government had expressed regret, and that an international commission would inquire into the facts with a view to the responsible persons being punished. Apart from the importance of seeing the Russo-Japanese War through, there were important negotiations on foot for a renewal or revision of the treaty with Japan; and it was felt that on these grounds it would be a mistake for the government to allow itself to be driven into a premature dissolution, unless it found itself unable to maintain a majority in parliament. At the same time the government's tenure of office was obviously drawing to its close; the usual interpretation of the Septennial Act involved a dissolution either in 1905 or 1906, and the government whips found increased difficulty in keeping a majority at Westminster, since neither the pronounced Chamberlainites nor the convinced free-trade Unionists showed any zeal, and a large number of the uncertain Unionists did not intend to stand again for parliament.

The events of the session of 1905 soon foreshadowed the end. The opposition were determined to raise debates in the House of Commons on the fiscal question, and Mr Balfour was no less determined not to be caught in their trap. These tactics of avoidance reached their culminating point when on one occasion Mr Balfour and his supporters left the House and allowed a motion hostile to tariff reform to be passed *nem. con.* Though the Scottish Churches Bill, the Unemployed Bill and the Aliens Bill were passed, a complete fiasco occurred over the redistribution proposals, which pleased nobody and had to be withdrawn owing to a blunder as to procedure; and though on the 17th of July a meeting of the party at the foreign office resulted in verbal assurances of loyalty, only two days later the government was caught in a minority of four on the estimates for the Irish Land Commission. For a few days it was uncertain whether they would resign or dissolve, but it was decided to hold on.

The real causes, however, which kept the government in office, were gradually losing their validity. The Russo-Japanese War came to an end; the new offensive and defensive alliance with Japan was signed on the 12th of August; the successful Anglo-French agreement, concluded in April 1904, had brought out a vigorous expression of cordiality between England and France, shown in an enthusiastic exchange of naval visits; and the danger, which threatened in the early summer, of complications

with France and Germany over Morocco, was in a fair way of being dispelled by the support given to France by Great Britain. The Liberal leaders had given public pledges of their adhesion to Lord Lansdowne's foreign policy, and the fear of their being unable to carry it on was no longer a factor in the public mind. The end came in November 1905, precipitated by a speech made by Mr Balfour at Newcastle on the 14th, appealing for unity in the party and the sinking of differences, an appeal plainly addressed to Mr Chamberlain, whose supporters—the vast majority of the Unionists—were clamouring for a fighting policy. But Mr Chamberlain was no longer prepared to wait. On the 21st of November at Bristol he insisted on his programme being adopted, and Mr Balfour was compelled to abandon the position he had held with so much tactical dexterity for two years past. Amid Liberal protests in favour of immediate dissolution, he resigned on the 4th of December; and Sir Henry Campbell-Bannerman, being entrusted by the king with the formation of a government, filled his cabinet with a view to a general election in January. The Unionists went to the polls with divided counsels, and sustained a crushing defeat, remarkable nevertheless for the comparative success of the tariff reformers. While Mr Chamberlain had a signal personal triumph in all the divisions of Birmingham, Mr Balfour himself was defeated by a large majority in Manchester.

Being in a miserable minority in parliament (157 Unionists against 379 Liberals, 51 Labour members, and 83 Nationalists), some form of consolidation among the Unionists was immediately necessary, and negotiations took place between Mr Balfour and Mr Chamberlain which resulted in the patching up of an agreement (expressed in a correspondence dated February 14th), and its confirmation at a meeting of the party at Lansdowne House a few days later. The new compact was indicated in Mr Balfour's letter, in which he declared that "fiscal reform is, and must remain, the first constructive work of the Unionist party; its objects are to secure more equal terms of competition for British trade and closer commercial union with the colonies; and while it is at present unnecessary to prescribe the exact methods by which these objects are to be attained, and inexpedient to permit differences of opinion as to these methods to divide the party, though other means are possible, the establishment of a moderate general tariff on manufactured goods, not imposed for the purpose of raising prices, or giving artificial protection against legitimate competition, and the imposition of a small duty on foreign corn, are not in principle objectionable, and should be adopted if shown to be necessary for the attainment of the ends in view or for purposes of revenue." Mr Balfour's leadership of the whole party was now confirmed; and a seat was found for him in the City of London by the retirement of Mr Gibbs.

The downfall of Mr Balfour's administration, and the necessity of reorganizing the Unionist forces on the basis of the common platform now adopted, naturally represented a fresh departure under his leadership, the conditions of which to some extent depended on the opportunities given to the new opposition by the proceedings of the Radical government (see CAMPBELL-BANNERMAN, SIR H.; and ASQUITH, H. H.). His own administration had been wrecked, through no initiative of his, by the dissensions over the fiscal question. But his wide range of knowledge and interests, his intellectual *finesse*, his personal hold over his supporters, his statesmanlike grasp upon imperial problems and his oratorical ability, had been proved to a remarkable degree; and in foreign affairs his tenure of power had been conspicuously successful. He left his country indeed in a position of strength abroad, which it had not held since the Crimean War. His institution of the permanent Committee of Imperial Defence, and of the new Army Council (1904), were reforms of the highest importance, resulting from the report of a "triumvirate" consisting of Lord Esher, Sir John Fisher and Sir George Clarke, appointed in November 1903. The Unionist régime as a whole, however, had collapsed. Its ministers had become "stale." The heavy taxation of the war years was still retained, to the disgust especially of the income-tax payers; and new issues arose over the Education Act, labour questions,

and the introduction of Chinese labour into South Africa (in 1904), which were successfully used against the government in the constituencies. The result was an electoral defeat which indicated, no doubt, a pronounced weakening of Mr Balfour's position in public confidence. This verdict, however, was one based mainly on temporary reasons, which were soon to be overshadowed by the new issues involved in the change of ministry. As a matter of fact, a year of opposition had not passed before his power in the House of Commons, even with so small a party behind him, was once more realized. The immense Radical majority started with a feeling of contempt for the leader who had been rejected at Manchester, but by 1907 he had completely reasserted his individual pre-eminence among parliamentarians. Mr Balfour had never spoken more brilliantly, nor shone more as a debater, than in these years when he had to confront a House of Commons three-fourths of which was hostile. His speech at Birmingham (November 14, 1907), fully accepted the principles of Mr Chamberlain's fiscal policy, proved epoch-making in consolidating the Unionist party—except for a small number of free-traders, like Lord Robert Cecil, who continued to hold out—in favour of tariff reform; and during 1908 the process of recuperation went on, the by-elections showing to a marked degree the increased popular support given to the Unionist candidates. This recovery was due also to the forcible feeble character of the Radical campaign against the House of Lords, the unpopularity of the Licensing Bill, the failure of the government to arrive at an education settlement, the incapacity of its Irish administration, its apparent domination by the "little navy" section, and its dallying with Socialism in the budget of 1909. The rejection of this budget in December by the House of Lords led to a desperate struggle at the polls in January 1910, but the confident hopes of the Unionists were doomed to disappointment. They won back over a hundred seats, returning 273 strong, but were still in a minority, the Liberals numbering 275, Labour members 40, and Irish Nationalists 82. Mr Balfour himself was elected for the City of London by an enormous majority.

Mr Balfour's other publications, not yet mentioned, include *Essays and Addresses* (1893) and *The Foundations of Belief, being Notes introductory to the Study of Theology* (1895). He was made LL.D. of Edinburgh University in 1881; of St Andrews University in 1885; of Cambridge University in 1888; of Dublin and Glasgow Universities in 1891; lord rector of St Andrews University in 1886; of Glasgow University in 1890; chancellor of Edinburgh University in 1891; member of the senate London University in 1888; and D.C.L. of Oxford University in 1891. He was president of the British Association in 1904, and became a fellow of the Royal Society in 1888. He was known from early life as a cultured musician, and became an enthusiastic golf player, having been captain of the Royal and Antient Golf Club of St Andrews in 1894-1895. (H. CH.)

BALFOUR, FRANCIS MAITLAND (1851-1882), British biologist, younger brother of Arthur James Balfour, was born at Edinburgh on the 10th of November 1851. At Harrow school he showed but little interest in the ordinary routine, but in one of the masters, Mr George Griffith, he fortunately found a man who encouraged and aided him in the pursuit of natural science, a taste for which, and especially for geology, had been cultivated in him by his mother from an early age. Going into residence at Trinity College, Cambridge, in 1870, he was elected a natural science scholar of his college in the following year, and although his reading was not ordered on the lines usual for the Schools, he obtained the second place in the Natural Science Tripos of December 1873. A course of lectures on embryology, delivered by Sir Michael Foster in 1871, definitely turned his attention to animal morphology, and, after his tripos, he was selected to occupy one of the two seats allocated to the university of Cambridge at the Naples zoological station. The research work which he began there contributed in an important degree to his election as a fellow of Trinity in 1874, and also afforded him material for a series of papers (published as a monograph in 1878) on the Elasmobranch fishes, which threw new light on

the development of several organs in the Vertebrates, in particular of the uro-genital and nervous systems. His next work was to write a large treatise, *Comparative Embryology*, in two volumes; the first, published in 1880, dealing with the Invertebrates, and the second (1881) with the Vertebrates. This book displayed a vigorous scientific imagination, always controlled by a logical sense that rigidly distinguished between proved fact and mere hypothesis, and it at once won wide recognition, not only as an admirable digest of the numberless observations made with regard to the development of animals during the quarter of a century preceding its publication, but also on account of the large amount of original research incorporated in its pages. Balfour's reputation was now such that other universities became anxious to secure his services, and he was invited to succeed Professor George Rolleston at Oxford and Sir Wyville Thomson at Edinburgh. But although he was only a college lecturer, holding no official post in his university, he declined to leave Cambridge, and in the spring of 1882 the university recognized his merits by instituting a special professorship of animal morphology for his benefit. Unhappily he did not deliver a single professorial lecture. During the first term after his appointment he was incapacitated from work by an attack of typhoid fever. Going to the Alps to recruit his health, he perished, probably on the 10th of July 1882, in attempting the ascent of the Aiguille Blanche, Mont Blanc, at that time unscathed. Besides being a brilliant morphologist, Balfour was an accomplished naturalist, and had he lived would probably have taken a high place among British taxonomists.

BALFOUR, SIR JAMES, BART. (of Denmyne and Kinnaird) (c. 1600–1657), Scottish annalist and antiquary. He was well acquainted with Sir William Segar and with Dugdale, to whose *Monasticon* he contributed. He was knighted by Charles I. in 1630, was made Lyon king-at-arms in the same year, and in 1633 baronet of Kinnaird. He was removed from his office of king-at-arms by Cromwell and died in 1657. Some of his numerous works are preserved in the Advocates' library at Edinburgh, together with his correspondence—from which rich collection Haig published *Balfour's Annales of Scotland* in 4 vols. 8vo (1824–1825).

See Sibbald, *Memoria Balfouriana* (1699).

BALFOUR, SIR JAMES (of Pittendreich) (d. 1583 or 1584), Scottish judge and politician, son of Sir Michael Balfour of Montquhanny, was educated for the legal branch of the church of Scotland. In June 1547, together with Knox and others taken at St Andrews, he was condemned to the French galleys, but was released in 1549, abjured the reformers, entered the service of Mary of Guise, and was rewarded with some considerable legal appointments. Subsequently he went over to the lords of the congregation and then betrayed their plans. After Mary's arrival in Scotland he became one of her secretaries, in 1565 being reported as her greatest favourite after Rizzio.¹ He obtained the parsonage of Flisk in Fife in 1561, was nominated a lord of session, and in 1563 one of the commissaries of the court which now took the place of the former ecclesiastical tribunal; in 1565 he was made a privy-councillor, and in 1566 lord-clerk-register, and was knighted. According to Mary his murder was intended together with Rizzio's in 1566. An adherent of Bothwell, he was deeply implicated in Darnley's murder, though not present at the commission of the crime. By his means Darnley was lodged at Kirk o' Field, his brothers' house. He was supposed to have drawn up the bond at Craigmillar for the murder; he signed it, was made under Bothwell deputy-governor of Edinburgh Castle, and is said to have drawn up the marriage-contract between Bothwell and Mary. When, however, the fall of Bothwell was seen to be impending he rapidly changed sides and surrendered the castle to Murray, stipulating for his pardon for Darnley's murder, the retention of the priory of Pittenweem, and pecuniary rewards. He was appointed president of the court of session on resigning the office of lord-clerk-register. He was present at the battle of Langside with the regent in 1568, and was accused of having advised Mary to

leave Dunbar to her ruin, and of having betrayed to her enemies the casket letters. The same year, however, in consequence of renewed intrigues with Mary's faction, he was dismissed, and next year was imprisoned on the charge of complicity in Darnley's murder. He succeeded in effecting his escape by means of bribery, the expenses of which he is said to have paid by intercepting the money sent from France to Mary's aid. In August 1571, during the regency of Lennox, an act of forfeiture was passed against him, but next year he was again playing traitor and discovering the secrets of his party to Morton, and he obtained a pardon from the latter in 1573 and negotiated the pacification of Perth the same year. Distrusted by all parties, he fled to France, where he seems to have remained till 1580. In 1570 his forfeiture was renewed by act of parliament. In January 1580 he wrote to Mary offering her his services, and in June protested his desire to be useful to Elizabeth, lamented the influence of the Jesuits, and intended a journey to Dieppe to bear some good Protestant preaching.² On the 27th of December of the same year he returned to Scotland and effected the downfall and execution of Morton by producing a bond, probably that in defence of Bothwell and to promote his marriage with Mary, and giving evidence of the latter's knowledge of Bothwell's intention to murder Darnley. In July 1581 his cause was reheard; he was acquitted of murder by assize, and shortly afterwards in 1581 or 1582 he was restored to his estates and received at court. His career, one of the blackest in the annals of political perfidy and crime, closed shortly before the 24th of January 1584. He was the greatest lawyer of his day, and part-author at least of Balfour's *Practicks*, the earliest text-book of Scottish law, not published, however, till 1754. He married Margaret, daughter and heir of Michael Balfour of Burleigh, by whom, besides three daughters, he had six sons, the eldest of whom was created Baron Balfour of Burleigh in 1607.³

BIBLIOGRAPHY.—See article in the *Dict. of Nat. Biog.* and authorities there quoted; Balfour's *Practicks* (1754) and introductory preface; A. Lang's *Hist. of Scotland*, vol. ii. and authorities (1902); J. Melville's *Memoirs* (Bannatyne Club, 1827); *Cal. of State Papers—Register of Privy Council of Scotland*, i.-iii.; *Scottish Series* (Thorpe), i. and ii. (Bain), ii.-iv.; *The Border Papers*, i. & ii. (P. C. Y.).

BALFOUR, ROBERT (known also as BALFOREUS) (1550?–1625?), Scottish philosopher, was educated at St Andrews and the university of Paris. He was for many years principal of the Guienne College at Bordeaux. His great work is his *Commentarii in Organum Logicum Aristotelis* (Bordeaux, 1618); the copy in the British Museum contains a number of highly-eulogistic poems in honour of Balfour, who is described as *Graivm aemulus acer*. Balfour was one of the scholars who contributed to spread over Europe the fame of the *præferendum ingenium Solorum*. His contemporary, Dempster, called him the "phoenix of his age, a philosopher profoundly skilled in the Greek and Latin languages, and a mathematician worthy of being compared with the ancients." His *Cleomedis meteora*, with notes and Latin translation, was reprinted at Leiden as late as 1820.

See Dempster, *Historia Ecclesiastica Gent. Solorum*; Irving's *Lives of the Scottish Writers*; Anderson's *Scottish Nation*, i. 217.

BALGUY, JOHN (1686–1748), English divine and philosopher, was born at Sheffield on the 12th of August 1686. He was educated at the Sheffield grammar school and at St John's College, Cambridge, graduated B.A. in 1706, was ordained in 1710, and in 1711 obtained the small living of Lamesley and Tanfield in Durham. He married in 1715. It was the year in which Bishop Hoadley preached the famous sermon on "The Kingdom of Christ," which gave rise to the "Bangorian controversy"; and Balguy, under the *nom de plume* of Silvius, began his career of authorship by taking the side of Hoadley in this controversy against some of his High Church opponents.

¹ *Cal. of State Pap.* (Foreign), 1579–1580, p. 294.

² The title was attained in 1716, through the 5th baron's complicity in the Jacobite rising of 1715. In 1869 it was restored to Alexander Hugh Bruce (b. 1849), as 6th baron; he became one of the most influential of contemporary Scottish noblemen, on the Conservative side in politics, and was secretary for Scotland from 1895 to 1903.

³ *Cal. of State Pap.* (Scottish), ii. 218, 250.

In 1726 he published *A letter to a Deist concerning the Beauty and Excellency of Moral Virtue, and the Support and Improvement which it receives from the Christian Religion*, chiefly designed to show that, while a love of virtue for its own sake is the highest principle of morality, religious rewards and punishments are most valuable, and in some cases absolutely indispensable, as sanctions of conduct. In 1727 he was made a prebendary of Salisbury by his friend Hoadley. He published in the same year the first part of a tractate entitled *The Foundation of Moral Goodness*, and in the following year a second part, *Illustrating and enforcing the Principles contained in the former*. The aim of the work is two-fold—to refute the theory of Hutcheson regarding the basis of rectitude, and to establish the theory of Cudworth and Clarke, that virtue is conformity to reason—the acting according to fitness which arise out of the eternal and immutable relations of agents to objects. In 1729 he became vicar of Northallerton, in the county of York. His next work was an essay on *Divine Rectitude: or, a Brief Inquiry concerning the Moral Perfections of the Deity, particularly in respect of Creation and Providence*. It is an attempt to show that the same moral principle which ought to direct human life may be perceived to underlie the works and ways of God: goodness in the Deity not being a mere disposition to benevolence, but a regard to an order, beauty and harmony, which are not merely relative to our faculties and capacities, but real and absolute; claiming for their own sakes the reverence of all intelligent beings, and alone answering to the perfection of the divine ideas. Balguy wrote several other terse and readable tracts of the same nature, which he collected and published in a single volume in 1734. In 1741 he published an *Essay on Redemption*, containing somewhat advanced views. Redemption as taught in Scripture means, according to him, "the deliverance or release of mankind from the power and punishment of sin, by the meritorious sufferings of Jesus Christ," but involves no *translation of guilt, substitution of persons or vicarious punishment*. Freed from these ideas, which have arisen from interpreting literally expressions which are properly figurative, the doctrine, he argues, satisfies deep and urgent human wants, and is in perfect consistence and agreement with reason and rectitude. His last publication was a volume of sermons, pervaded by good sense and good feeling, and clear, natural and direct in style. He died at Harrogate on the 21st of September 1748. A second volume of sermons appeared in 1750 (3rd ed. in 2 vols., 1760).

BALI, an island of the East Indies, E. of Java, from which it is separated by Bali Strait, which is shallow, and scarcely over a mile in width at its narrowest point. Bali is 93 m. in length, and its greatest breadth is 50 m. The area is 2095 sq. m. In 1882, for administrative purposes, Bali was separated from Java and combined with the island of Lombok to form the Dutch residency of Lombok and Bali. Politically its divisions are two:—(1) the two districts, Buleleng and Jembrana, on Dutch territory; and (2) the autonomous states of Klung Lung, Bangli, Mengwi, Badung and Tabanan. Buleleng, on the north-west, is the chief town. The population on Dutch territory in the whole residency in the year 1905 was 523,535. Bali belongs physically to Java; the climate and soil are the same and it has mountains of proportionate height. There are several lakes of great depth and streams well fitted for the purposes of irrigation, of which full advantage is taken by the natives. The geological formation includes (like that of Java) three regions—the central volcanic, the southern peninsula of Tertiary limestone, and alluvial plains between the older formations. The highest volcanoes, Tabanan, Batur and Gunung Agung (Bali Beak), have respectively heights of 7545 ft., 7383 ft., and 10,497 ft., the central chain having an average altitude of 3282 ft. As regards flora and fauna Bali is associated with Java. The deep strait which separates it on the east from Lombok was taken by A. R. Wallace (*q.v.*) as representing the so-called Wallace's Line, whereby he demarcated the Asiatic from the Australian fauna.

The natives of Bali, though of the same stock as the Javanese, and resembling them in general appearance, exceed them in stature and muscular power, as well as in activity and enterprise.

They are skillful agriculturists and artisans, especially in textile fabrics and the manufacture of arms. Though native rule is tyrannical and arbitrary, especially in the principalities of Badung and Tabanan, trade and industry could not flourish if insecurity of persons and property existed to any great extent. The natives have also a remedy against the aggression of their rulers in their own hands; it is called *Méilas*, consists in a general rising and renunciation of allegiance, and proves mostly successful. Justice is administered from a written civil and criminal code. Slavery is abolished. Hinduism, which was once the religion of Java, but has been extinct there for four centuries, is still in vogue in the islands of Bali and Lombok, where the cruel custom of widow-burning (*sutte*) is still practised, and the Hindu system of the four castes, with a fifth or Pariah caste (called *Chandala*), adhered to. It appears partly blended with Buddhism, partly overgrown with a belief in *Kalas*, or evil spirits. To appease these, offerings are made to them either direct or through the mediation of the *Devas* (domestic or agrarian deities); and if these avail not, the *Menyepi* or Great Sacrifice is resorted to. In the course of this ceremony, after the sacrifice, men rush in all directions carrying torches; the women also carry fire-brands, or knock on the houses with rice-crushers and other heavy implements, and thus the evil spirits are considered to be driven away. The Mahomedan religion occurs among the coastal population. The Balinese language belongs to the same group of the Malayan class as the Javanese, Sundanese, Madurese, &c., but is as distinct from each of these as French is from Italian. It is most nearly akin to the Sasak language spoken in Lombok and on the east coast of Bali. The literary language has embodied many of its ingredients from the Old Javanese, as spoken in Java at the time of the fall of Majapahit (15th century), while the vulgar dialect has kept free from such admixture. Javanese influence is also traceable in the use of three varieties of speech, as in the Javanese language, according to the rank of the people addressed. The alphabet is with some modifications the same as the Javanese, but more complicated. The material universally used for writing on is the prepared leaf of the lontar palm. The sacred literature of the Balinese is written in the ancient Javanese or *Kawi* language, which appears to be better understood here than it is in Java. A general decline in culture is manifest in the Balinese. Of the early history of their island the Balinese know nothing. The oldest tradition they possess refers to a time shortly after the overthrow of the Majapahit dynasty in Java, about the middle of the 15th century; but it has been supposed that there must have been Indian settlers here before the middle of the 1st century, by whom the present name, probably cognate with the Sanskrit *balin*, strong, was in all likelihood imposed. It was not till 1633 that the Dutch attempted to enter into alliance with the native princes, and their earliest permanent settlement at Port Badung only dates from 1845. Their influence was extended by the results of the war which they waged with the natives about 1847-49.

The only roadstead safe all the year round is Temukus on the north coast. The rivers are not navigable. Agriculture is the chief means of subsistence; rice being a crop of particular importance. Other crops grown for export are coffee, tobacco, cocoa and indigo. Gold-working, the making of arms and musical instruments, wood-carving, cotton, silk and gold thread weaving are of importance. There are numerous Arab and Chinese traders.

See R. Van Eck, *Schetsen van het eiland Bali*, Tijdsch. van Nederl. Indie (1878-1879); J. Jacobs, *Eenigen tijd onder de Baiers* (Batavia, 1883); H. Tonkes, *Vakskunde von Bali* (Halle, 1888); Liefrinck, *De rijstcultuur op Bali*, Indische Gids. (1886).

BALIKISRI (*Balukiser*), a town of Asia Minor, capital of the Karasi sanjak in the vilayet of Brusa, altitude 575 ft., situated on rising ground above a fertile plain which drains to the Sea of Marmora. Pop. 20,000 (Moslems, 15,000; Christians, 5000). It is a centre of trade in opium, silk and cereals, communicating by carriage roads with Panderma. The sanjak is rich in mineral wealth; silver mines are worked at Balia and boracic mines at Susurlu. At or near Balikisri was the Roman town of *Hædriantheræ*, founded, as its name commemorates, by the emperor Hadrian.

BALIOL, the name of a family which played an important part in the history of Scotland. The founder of the family in England was a Norman baron, Guy or Guido de Baliol, who held the fiefs of Bailleul, Dampierre, Harcourt and Vinoy in Normandy. Coming to England with William the Conqueror, he received lands in the north of England from William I., and his son, or grandson, Bernard or Barnard de Baliol, built a fortress in Durham called Castle Barnard, around which the town of Barnard Castle grew. The first burgesses probably obtained their privileges from him. Bernard fought for King Stephen during the civil war, was present at the battle of the Standard in August 1138, and was taken prisoner at the battle of Lincoln in February 1141. The date of his death is uncertain. Dugdale only believes in the existence of one Bernard de Baliol, but it seems more probable that the Bernard de Baliol referred to after 1167 was a son of the elder Bernard, and not the same individual. If so the younger Bernard was one of the northern barons who raised the siege of Alnwick, and took William the Lion, king of Scotland, prisoner in July 1174. He also confirmed the privileges granted by his father to the burgesses of Barnard Castle, and was succeeded by his son Eustace. Practically nothing is known of Eustace, or of his son Hugh who succeeded about 1215. Hugh's son and successor, John de Baliol, who increased his wealth and position by a marriage with Dervorguila (d. 1290), daughter of Alan, earl of Galloway, is said to have possessed thirty knights' fees in England and one half of the lands in Galloway. He was one of the regents of Scotland during the minority of Alexander III., but in 1255 was deprived of this office and his lands forfeited for treason. He then appeared in England fighting for Henry III. against Simon de Montfort, and was taken prisoner at the battle of Lewes in 1264. About 1263 he established several scholarships at Oxford, and after his death in 1269 his widow founded the college which bears the name of the family. He left four sons, three of whom died without issue, and in 1278 his lands came to his son, John de Baliol (q.v.), who was king of Scotland from 1292 to 1296, and who died in Normandy in 1315. John's eldest son by his marriage with Isabel, daughter of John de Warenne, earl of Surrey, was Edward de Baliol who shared his father's captivity in England in 1296. Subsequently crossing over to France, he appears to have lived mainly on his lands in Normandy until 1324, when he was invited to England by King Edward II., who hoped to bring him forward as a candidate for the Scottish crown. A favourable opportunity, however, did not arise until after the death of King Robert the Bruce in 1329, when Edward III. had succeeded his father on the English throne. Although Edward did not give Baliol any active assistance, the claimant placed himself at the head of some disinherited Scottish nobles, raised a small army and sailed from Ravenspur. Landing at Kinghorn in Fifeshire in August 1332, he gained a complete victory over the Scots under Donald, earl of Mar, at Dupplin Moor, took Perth, and on the 24th of September was crowned king of Scotland at Scone. He then acknowledged Edward III. as his superior, but soon afterwards was defeated at Annan (where his brother, Henry de Baliol, was slain) and compelled to fly to England. Regaining his kingdom after the defeat of the Scots at Halidon Hill in July 1333, Baliol surrendered the whole of the district formerly known as Lothian to Edward, and did homage for Scotland to the English king. His party, however, was weakened by disunion, and he won no serious support in Scotland. Entirely dependent on Edward, he again sought refuge in England, and took a very slight part in the war waged on his behalf. He returned to Scotland after the defeat of King David II. at Neville's Cross in 1346. After making an absolute surrender of Scotland to Edward III. in 1356 at Roxburgh in return for a pension, Edward de Baliol died at Wheatley near Doncaster in 1367.

A cadet branch of the Baliol family was descended from Ingelram, or Engelram, a son of the younger Bernard de Baliol. Ingelram's wife was the daughter and heiress of William de Berkeley, lord of Reidcastle in Forfarshire, and chamberlain of Scotland, and by her he had a son Henry, who became chamberlain about 1223. Henry married Lora or Lauretta, a daughter

of Philip de Valoines (Valsques), lord of Panmure, and in 1234 inherited part of the rich English fiefs of the Valoines family. He sided with the English barons against John in 1215, and accompanied Henry III. to France in 1242. He died in 1246. It is probable but not certain that Henry's son was Alexander de Baliol, lord of Cavers in Teviotdale, and chamberlain of Scotland. Alexander took a leading part in Scottish affairs during the latter part of the 13th century, and is first mentioned as chamberlain in 1287. He shared in the negotiations between the Scottish nobles and Edward I. of England which culminated in the treaty of Salisbury in 1289, and the treaty of Brigham in 1290. Probably deprived of his office as chamberlain about 1296 he may have shared the imprisonment of his kinsman, John de Baliol the king. He then fought in Scotland for Edward, and was summoned to several English parliaments. His wife was Isabella de Chilham, through whom he obtained lands in Kent. He died about 1309, leaving a son, Alexander, whose son, Thomas, sold the estate of Cavers to William, earl of Douglas, in 1368. Thomas is the last of the Baliols mentioned in the Scottish records.

A late and dubious tradition asserts that the family name became so discredited owing to the pusillanimous conduct of John and Edward Baliol that it was abandoned by its owners in favour of the form Baillie.

See John of Fordun, *Chronica gentis Scotorum*, edited by W. F. Skene (Edinburgh, 1871-1872); Andrew of Wyntoun, *The Ormyngale Cronykyl of Scotland*, edited by David Laing (Edinburgh, 1872-1879); *Gesta Edwardi de Carnarvan*, by a canon of Bridlington, edited by W. Stubbs (London, 1883); W. Dugdale, *The Baronage of England* (London, 1675-1676); R. Surtees, *The History of Durham* (London, 1816-1840); *Documents and Records illustrating the History of Scotland*, edited by F. T. Palgrave (London, 1837); *Documents illustrative of the History of Scotland* (1286-1306), edited by J. Stevenson (Edinburgh, 1870); *Calendar of Documents relating to Scotland*, edited by J. Bain (Edinburgh, 1881-1888).

BALIOL, JOHN DE (1249-1315), king of Scotland, was a son of John de Baliol (d. 1269) of Barnard Castle, Durham, by his wife Dervorguila, daughter of Alan, earl of Galloway, and became head of the Baliol family (see above) and lord of extensive lands in England, France and Scotland on his elder brother's death in 1278. Little else, however, is known of his early life. He came into prominence when the Scottish throne became vacant in 1290 owing to the death of Margaret, the "maid of Norway," a granddaughter of King Alexander III., and was one of the three candidates for the crown whose pretensions were seriously considered. Claiming through his maternal grandmother, Margaret, the eldest daughter of David, earl of Huntingdon (d. 1219), who was a grandson of King David I., Baliol's principal rival was Robert Bruce, earl of Annandale, and the dispute was the somewhat familiar one of the eldest by descent against the nearest of kin. Meanwhile the English king, Edward I., was closely watching the trend of affairs in Scotland and was invited to settle this dispute. It is doubtful what rights, if any, the English kings had over Scotland, but when Edward met the Scottish nobles at Norham in May 1291, he demanded a formal recognition of his position as overlord of Scotland. After some delay this was tacitly admitted by the nobles, and acknowledged by Baliol and the other competitors, who all agreed to abide by his decision. A court of eighty Scotsmen and twenty-four Englishmen was then appointed to try the question. Traversing the statements made in favour of Bruce, Baliol claimed by the principles of feudal law for an indivisible inheritance, and on the advice of the court Edward decided in his favour. Having sworn fealty to the English king, Baliol was crowned king of Scotland at Scone on the 30th of November 1292; in his new capacity he did homage to Edward at Newcastle, and in January 1293 released the English king from all promises and obligations made while the kingdom of Scotland was in his hands. These amicable relations were soon disturbed. A Scottish vassal carried his case to Edward as Baliol's overlord, and Baliol himself was soon summoned to the English court to answer a suit brought against him. After a short struggle he admitted Edward's right, and in May 1294 attended a parliament in London. He soon quarrelled with his overlord, the exact point at issue being doubtful, and returned

to Scotland. Consequent on the dispute which had broken out between England and France, a council of twelve was appointed to assist him, and it was decided to defy Edward. Englishmen were dismissed from the Scottish court, their fiefs were confiscated, and an alliance was concluded with Philip IV., king of France. War broke out, but Baliol did not take the field in person. Invading Scotland, Edward met with a feeble resistance, and at Brechin in July 1296 Baliol surrendered his kingdom to Antony Bek, bishop of Durham, as the representative of the English king. About the same time he appeared before Edward at Montrose, and delivered to him a white rod, the feudal token of resignation. With his son, Edward, he was taken a prisoner to England, remaining in captivity until July 1299, when he was released at the request of Pope Boniface VIII. He lived for some time under the pope's supervision, and seems to have passed his remaining days quietly on his French estates. He died in Normandy early in 1315, leaving several children by his wife, Isabel, a daughter of John de Warenne, earl of Surrey (d. 1304).

See *Documents and Records illustrating the History of Scotland*, edited by F. T. Palgrave (London, 1837); *Documents illustrating the History of Scotland, 1286-1306*, edited by J. Stevenson (Edinburgh, 1870); J. H. Burton, *History of Scotland*, vol. ii. (Edinburgh, 1905); A. Lang, *History of Scotland*, vol. i. (Edinburgh, 1904); Sir H. Maxwell, *Robert the Bruce* (London, 1897); *Calendar of Documents relating to Scotland*, edited by J. Bain (Edinburgh, 1881-1888). Also SCOTLAND: *History*.

BALIUG, a town of the province of Bulacán, Luzon, Philippine Islands, on the Quiñaga river, 29 m. (by rail) N.N.W. of Manila. Pop. (1903) 21,008, including the population (7072) of Bustos, which was annexed to Baliug in that year after the census was taken. Baliug is served by an extension of the railway between Manila and Dagupan. It is the trade centre of a fertile agricultural district, and manufactures bamboo hats, silk and native fibre goods.

BALKAN PENINSULA, the most easterly of the three large peninsulas which form the southern extremities of the European continent. Its area, 184,779 sq. m., is about 35,000 sq. m. less than that of the Iberian Peninsula, but more than twice that of the Italian. Its northern boundary stretches from the Kilia mouth of the Danube to the Adriatic Sea near Fiume, and is generally regarded as marked by the courses of the rivers Danube, Save and Kupa. On the E. it is bounded by the Black Sea, the Sea of Marmora, and the Aegean; on the S. by the Mediterranean; on the W. by the Ionian Sea and the Adriatic.

With the exception of the Black Sea coast and the Albanian littoral, its shores are considerably indented and flanked by groups of islands. The Peninsula in its general contour resembles an inverted pyramid or triangle, terminating at its apex in a subsidiary peninsula, the Peloponnesus or Morea. Its surface is almost entirely mountainous, the only extensive plains being those formed by the valleys of the Danube and Maritza, and the basin of Thessaly drained by the Salambria (ancient *Peneus*). The Danubian plain, lying, for the most part, outside the Peninsula, is enclosed, on the north, by the Carpathians; and on the south by the Balkans, from which the Peninsula derives its name. These ranges form together the great semicircular mountain-chain, known as the anti-Dacian system, through which the Danube finds a passage at the Iron Gates. The other mountain-systems display great complexity of formation; beginning with the Dinaric Alps and the parallel ranges of Bosnia, they run, as a rule, from north-west to south-east; the great chain of Rhodope traverses the centre of the Peninsula, throwing out spurs towards the Black Sea and the Aegean; farther west are the lofty Shar Dagh and the mountains of Montenegro and Albania, continued by the Pindus range and the heights of Acarnania and Aetolia. The principal summits are Olympus (9794 ft.), overlooking the Gulf of Salonica; Musallá (9631) and Popova Shapka (8855), both in the Rhodope system; Liubotrn in the Shar Dagh (8089); Elin, in the Perin Planina (8704); Belmeken in southern Bulgaria (chain of Dospat, 8562); Smolika in the Pindus range (8445); Dormitor in northern Montenegro (8294); Kaimakchalan in central Macedonia (8255);

and Kiona in Aetolia (8235). Owing to the distribution of the mountain-chains, the principal rivers flow in an easterly or south-easterly direction; the Danube falls into the Black Sea; the Maritza, Mesta, Struma (*Strymon*), Vardar and Salambria into the Aegean. The only considerable rivers flowing into the Adriatic are the Narenta, Drin and Viossa. The principal lakes are those of Ochrida, Prespa, Scutari and Iannina. The climate is more severe than that of the sister peninsulas, and the temperature is liable to sudden changes. The winter, though short, is often intensely cold, especially in the Danubian plain and in Thrace, the rigorous climate of which is frequently alluded to by the Latin poets. Bitter north-easterly winds prevail in the spring, and snow is not uncommon even in the low-lying districts of Greece. The autumn weather is generally fine and clear.

Geology.—Broadly speaking, the Balkan Peninsula may be divided into four areas which geologically are distinct. There is a central region, roughly triangular in shape, with its base resting upon the

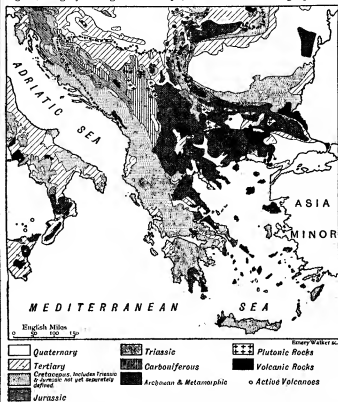

Aegean Sea and its apex in Servia. On two sides this area is bordered by belts of folded beds which form on the west the mountain ranges of the Adriatic and Ionian coasts, and on the north the chain of the Balkans. Finally, beyond the Balkans lies the great Rumanian depression, occupied chiefly by undisturbed Cretaceous and Tertiary strata. The central region, although wedged in between two belts of folding, is not affected by the folds of either, excepting near its margins. It consists largely of crystalline and schistose rocks. The core is formed by the mountain masses of Rhodope, Belasitza, Perin and Karia; and here Palaeozoic and Mesozoic beds are absent, and the earliest sedimentary deposits belong to the Tertiary period and lie flat upon the crystalline rocks. Upon the margins, however, Cretaceous beds are found. The eastern parts of Greece are composed almost entirely of Cretaceous beds, but nevertheless they must be considered to belong to the central area, for the folds which affect them are nearly at right angles to those of the western chains. In general, however, the central area is one of faulting rather than of folding, and the sedimentary beds sometimes lie in troughs formed by faults. Extensive volcanic outbursts occurred in this region during the Tertiary period. In the western folded belt the strike of the folds is N.W.-S.E., or N.W.-S.S.E. There are many local irregularities, but the general direction is maintained as far as the southern extremity of Greece, where the folds show a tendency to curve towards Crete. In the north, Carboniferous beds are present, and the Trias and the Jura take a considerable part in the formation of the chain. The Sarmatian beds are also involved in the folds, indicating that the folding was not completed till Pliocene times. In the south, the older beds disappear and the whole chain is formed chiefly of Cretaceous beds, though Eocene and probably Jurassic rocks are

present. The Eocene beds are folded, but the marginal Pliocene beds are not, and the final folding seems to have taken place during the Miocene period. (For the Balkans, see BULGARIA.)

Area and Population.—The following figures show the area and population of the various political divisions of the Balkan Peninsula in 1909; see also the articles on the separate countries.

Political Divisions.	Area in sq. m.	Pop. in 1909.	Pop. per sq. m.
Croatia-Slavonia (south of the Save and Kulpa)	(about) 8,200	(about) 1,200,000	146.3
Servia	18,782	2,493,770	132.2
Bulgaria (with Eastern Rumelia)	37,240	4,028,239	88
The Dobrudja (Rumania)	5,896	258,242	43.9
Dalmatia (Austria)	4,923	591,597	120.1
Montenegro	3,255	311,564	94
Bosnia and Herzegovina (Austria-Hungary)	19,696	1,568,092	79.9
Sanjak of Novibazar (Turkish)	2,840	153,000	53.5
Albania, Macedonia and other Turkish possessions	62,744	5,812,300	92.6
Greece	24,400	2,631,952	107.8
	187,976	19,048,756	101.3

For full details as to the physical features, natural products, population, customs, trade, finance, government, religion, education, language, literature, antiquities, history, politics, &c., of the Balkan lands, see ALBANIA, BOSNIA AND HERZEGOVINA, BULGARIA, CROATIA-SLAVONIA, DALMATIA, DOBRUDJA, GREECE, ILLYRIA, MACEDONIA, MONTENEGRO, NOVIBAZAR, SERVIA and TURKEY.

Races.—The Peninsula is inhabited by a great variety of races, whose ethnological limits are far from corresponding with the existing political boundaries. The Turkish population, descended in part from the Ottoman invaders of the 14th and 15th centuries,

appeared in the rest of Greece, almost entirely in Servia; and it continues to decrease in Bulgaria notwithstanding the efforts of the authorities to check emigration. It is nowhere found in compact masses except in north-eastern Bulgaria and the region between Adrianople, the Black Sea and the Sea of Marmora.

Elsewhere it appears in separate villages and isolated districts, or in the larger towns and their immediate neighbourhood. The total Turkish population of the Peninsula scarcely exceeds 1,800,000. The Slavonic population, including the Serbo-Croats and Bulgars, is by far the most numerous; its total aggregate exceeds 10,000,000. The majority of the Serbo-Croats left their homes among the Carpathians and settled in the Balkan Peninsula in the 7th century. The distinction between the Serbs of the more central region and the Croats of the north-west, was first drawn by the early Byzantine chroniclers, and was well established by the 12th century. It does not correspond with any valid linguistic or racial difference; but in the course of

time a strong religious difference arose. Along the Croatian and Dalmatian coast there existed a well-developed Latin civilization, which was sustained by constant intercourse with Italy; and, under its influence, the Serbo-Croatian immigrants were converted to the Roman Catholic Church. In the wild and mountainous interior, however, the Byzantine Church had few or no rivals and the Orthodox creed prevailed. The Orthodox Serbs inhabit the kingdom of Servia, Old Servia (or Novibazar and north-western Macedonia), Montenegro, Herzegovina and parts of Bosnia. The Roman Catholic Croats predominate in Dalmatia, north-western Bosnia and Croatia-Slavonia. Montenegro, like the other mountainous regions, adhered to the Greek Church; it received a number of Orthodox Servian refugees at the beginning of the 15th century, when the Turks occupied Servia. The numbers of the Serbo-Croats may be estimated at about 5,600,000. The Bulgars, who descend from a fusion of the Slavonic element with a later Ugro-Finnish immigration, inhabit the kingdom of Bulgaria (including Eastern Rumelia), parts of the Dobrudja and the greater part of Macedonia, except Old Servia and the Aegean littoral. Apart from their colonies in Bessarabia and elsewhere, they may be reckoned at 4,400,000. Only a portion of the widely-spread Ruman or Vlach race, which extends over a great part of Transylvania, south Hungary and Bessarabia, as well as the Rumanian kingdom, falls within the limits of the Peninsula. It is found in numerous detached settlements in Macedonia, Albania and northern Greece, and in colonies of recent date in Servia and Bulgaria. The nomad Vlachs or Tzintzars of these countries call themselves Arumani or "Romans"; they are a remnant of the native Latinized population which received an increase from the immigration of Daco-Roman refugees, who fled southwards during the 3rd century, after the abandonment of Dacia by Aurelian. (See VLACHS.) The entire Ruman population of the Balkan countries may be set down approximately at 600,000. The Albanians, who call themselves *Shtitipetar* or *Arber*, are the representatives of the primitive Illyrian population; they inhabit the Adriatic littoral from the southern frontier of Montenegro to the northern boundary of Greece, in which country they are found in considerable numbers. They have shown a tendency to advance in a north-easterly direction towards the Servian frontier, and the movement has been encouraged for political reasons by the Turkish government. The whole Albanian nation possibly numbers from 1,500,000 to 1,600,000. The Greeks, whose immigration from Asia Minor took place in pre-historic times, are, next to the Albanians, the oldest race in the Peninsula. Their maritime and commercial instincts have led them from the earliest times to found settlements on the sea-coast and the islands. They inhabit the Black Sea littoral from Varna to the Bosphorus, the shores of the Sea of Marmora and the Aegean, the Aegean archipelago, the mainland of Greece, Epirus and the western islands as far north as Corfu. In Constantinople they

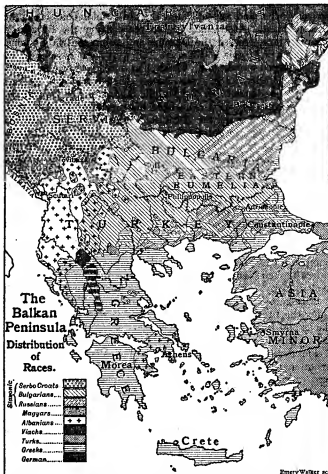

in part from colonists introduced at various epochs from Asia by the Turkish government, declined considerably during the 19th century, especially in the countries withdrawn from the sultan's authority. It is diminishing in Thessaly; it has entirely dis-

probably exceed 300,000. They are seldom found in large numbers at any great distance from the sea, and usually congregate in the principal towns and commercial centres, such as Adrianople, Constantza, Varna and Philippopolis; there are also detached colonies at Melnik, Stanimaka, Kavakly, Niegush and elsewhere. The Greek inhabitants of the Peninsula and adjacent islands probably number 4,500,000. The remainder of the population is for the most part composed of Armenians, Jews and gipsies. The Armenians, like the Greeks, congregate in the principal centres of trade, especially at Constantinople; their numbers were greatly reduced by the massacres of 1896. The Jews are most numerous at Salonica where they form half the population. The gipsies are scattered widely throughout the Peninsula; they are found not only in wandering troops, as elsewhere in Europe, but in settlements or cantonments in the neighbourhood of towns and villages.

Religions.—Owing to the numerous conversions to Islam which followed the Turkish conquest, the Mohammedan population of the Peninsula is largely in excess of the purely Turkish element. More than half the Albanian nation and 35% of the inhabitants of Bosnia and Herzegovina adopted the creed of the conquering race. Among the Bulgars and Greeks the conversions were less numerous. The Bulgarian Mahomedans, or Pontaks, who inhabit the valleys of Rhodope and certain districts in northern Bulgaria, are numerically insignificant; the Greek followers of Islam are almost confined to Crete.

The whole Moslem population of the Peninsula is about 3,500,000. The great bulk of the Christian population belongs to the Orthodox Church, of which the oecumenical patriarch at Constantinople is the nominal head, having precedence over all other ecclesiastical dignitaries. The Bulgarian, Servian, Montenegrin and Greek churches are, however, in reality autocephalous. The Bulgarian church enjoys an exceptional position, inasmuch as its spiritual chief, the exarch, who resides at Constantinople, controls the Bulgarian prelates in European Turkey as well as those in the kingdom of Bulgaria. On the other hand the Greek prelates in Bulgaria are subject to the patriarch. Religious and political questions are intimately connected in eastern Europe. The heads of the various religious communities are the only representatives of the Christian population recognized by the Turkish government; they possess a seat in the local administrative councils and supervise the Christian schools. The efforts of the several branches of the Orthodox Church to obtain a separate organization in the Turkish dominions are to be attributed exclusively to political motives, as no difference of dogma divides them. The Serbo-Croats of Dalmatia, and Croatia-Slavonia, some of the Gheg tribes in Albania, about 21% of the Bosnians, a still smaller number of Bulgarians in the kingdom and in Macedonia and a few Greeks in the islands belong to the Roman Catholic Church. A certain number of Bulgars at Kuchuk in Macedonia and elsewhere form a "uniate" church, which accepts the authority and dogma of Rome, but preserves the Orthodox rite and discipline. The Armenians are divided between the Gregorian and Uniate-Armenian churches, each under a patriarch. The other Christian confessions are numerically inconsiderable. The Gagazidi in Eastern Bulgaria, a Turanian and Turkish-speaking race, profess Christianity.

Languages.—Until comparatively recent times Turkish and Greek were the only languages systematically taught or officially recognized in the Balkan lands subject to Turkish rule. The first, the speech of the conquering race, was the official language; the second, owing to the intellectual and literary superiority of the Greeks, their educational zeal and the privileges acquired by their church, became the language of the upper classes among the Christians. The Slavonic masses, however, both Servian and Bulgarian, preserved their language, which saved the nationalities from extinction. The Servian dialect extending into regions which escaped the Turkish yoke, enjoyed certain advantages denied to the Bulgarians; in free Montenegro the first Slavonic printing-press was founded in 1493; at Ragusa, a century later, Servian literature attained a high degree of excellence. Bulgarian, for nearly four centuries, ceased to be a written language except in a few monasteries; a literary revival, which began about the middle of the 18th century, was the first symptom of returning national consciousness. The Servian, Bulgarian and Rumanian languages have borrowed largely from the Turkish in their vocabularies, but not in their structural forms, and have adopted many words from the Greek. Modern Greek has also a large number of Turkish words which are rejected in the artificial literary language. The revival of the various Balkan nationalities was in every case accompanied or preceded by a literary movement; in Servian literature, under the influence of Obradovich and Vuk Karajich, the popular idiom, notwithstanding the opposition of the priesthood, superseded the ecclesiastical Russian-Slavonic; in Bulgaria the eastern dialect, that of the Sredna Gora, prevailed. Among the Greeks, whose literature never suffered a complete eclipse, a similar effort to restore the classical tongue resulted in a kind of compromise; the conventional literary language, which is neither ancient nor modern, differs widely from the ver-

acular. Albanian, the only surviving remnant of the ancient Thracio-Illyrian speech, affords an interesting study to philologists. It undoubtedly belongs to the Indo-European family, but its earlier forms cannot, unfortunately, be ascertained owing to the absence of literary monuments. Certain remarkable analogies between Albanian and the other languages of the Peninsula, especially Bulgarian and Rumanian, have been supposed to point to the influence exercised by the primitive speech upon the idioms of the immigrant races.

History.—The great Slavonic immigration, which changed the ethnographic face of the Peninsula, began in the 3rd century A.D. and continued at intervals throughout the following four centuries. At the beginning of this movement the Byzantine empire was in actual or nominal possession of all the regions south of the Danube; the greater part of the native Thracio-Illyrian population of the interior had been romanized and spoke Latin. The Thracians, the progenitors of the Vlachs, took refuge in the mountainous districts and for some centuries disappeared from history; originally an agricultural people, they became nomad shepherds. In Albania the aboriginal Illyrian element, which preserved its ancient language, maintained itself in the mountains and eventually forced back the immigrant race. The Greeks, who occupied the maritime and southern regions, were driven to the sea-coast, the islands and the fortified towns. Slavonic place-names, still existing in every portion of the Peninsula, bear witness to the multitude of the invaders and the permanency of their settlements. In the 6th century the Slavs penetrated to the Morea, where a Slavonic dialect was spoken down to the middle of the 15th century. In the 7th the Serbo-Croats invaded the north-western regions (Croatia, Servia, Bosnia, Herzegovina, Montenegro and northern Albania); they expelled or assimilated the Illyrian population, now represented in Dalmatia by the slavonized Morlachs or Mavro-Vlachs, and appropriated the old Roman colonies on the Adriatic coast. At the end of the 7th century the Bulgars, a Turanian race, crossed the Danube and subjected the Slavonic inhabitants of Moesia and Thrace, but were soon assimilated by the conquered population, which had already become partly civilized. Under their tsar Krum (802-815) the Bulgars invaded the districts of Adrianople and central Macedonia; under Simeon (893-927), who fixed his capital at Preslav, their empire extended from the Adriatic to the Black Sea. In 971 "the first Bulgarian empire" was overthrown by the emperor John Zimisce, but Bulgarian power was soon revived under the Shishman dynasty at Ochrida. In 1014 Tsar Samuel of Ochrida, who had conquered the greater part of the Peninsula, was defeated at Belasitza by the Greek emperor Basil II, and the "western Bulgarian empire" came to an end. In the 10th century the Vlachs reappear as an independent power in Southern Macedonia and the Pindus district, which were known as Great Walachia (Μεγάλη Βλαχία). The Serbs, who owing to the dissensions of their zhupans or chiefs, had hitherto failed to take a prominent part in the history of the Peninsula, attained unity under Stephen Nemanja (1169-1195), the founder of the Nemanjic dynasty. A new Bulgarian power, known as the "second" or "Bulgaro-Vlach empire," was founded at Trnovo in 1186 under the brothers Ivan and Peter Asen, who led a revolt of Vlachs and Bulgars against the Greeks. In 1204 Constantinople was captured by the Latins of the Fourth Crusade, and Baldwin of Flanders was crowned emperor; the Venetians acquired several maritime towns and islands, and Frankish feudal dynasties were established in Salonica, Athens, Achaia and elsewhere. Greek rule, however, survived in the despotate of Epirus under princes of the imperial house of the Angeli. The Latin tenure of Constantinople lasted only 57 years; the imperial city was recaptured in 1261 by Michael VIII. Palaeologus, but most of the feudal Latin states continued to exist till the Turkish conquest; the Venetians retained their possessions for several centuries later and waged continual wars with the Turks. In 1230 Theodore of Epirus, who had conquered Albania, Great Walachia and Macedonia, was overthrown at Klokotniza by Ivan Asen II, the greatest of Bulgarian monarchs (1218-1241), who defeated Baldwin at Adrianople and extended his sway over most of the Peninsula. The Bulgarian power declined after

his death and was extinguished at the battle of Velbúdz (1330) by the Servians under Stephen Urosh III. A short period of Servian predominance followed under Stephen Dushan (1331-1355) whose realm included Albania, Macedonia, Epirus, Thessaly and northern Greece. The Servian incursion was followed by a great Albanian emigration to the southern regions of the Peninsula. After Dushan's death his empire disappeared, and Servia fell a prey to anarchy. For a short time the Bosnians, under their king Stephen Tvrtko (1353-1391), became the principal power in the west of the Peninsula. The disorganization and internecine feuds of the various states prepared the way for the Ottoman invasion. In 1356 the Turks seized Gallipoli; in 1361 the sultan Murad I established his capital at Adrianople; in 1389 the fate of the Slavonic states was decided by the rout of the Servians and their allies at Kosovo. The last remnant of Bulgarian national existence disappeared with the fall of Trnovo in 1393, and Great Walachia was conquered in the same year. Under Mahommed II, (1453-1481) the Turks completed the conquest of the Peninsula. The despotate of Epirus succumbed in 1449, the duchy of Athens in 1456; in 1453 Constantinople was taken and the decrepit Byzantine empire perished; the greater part of Bosnia submitted in 1463; the heroic resistance of the Albanians under Scanderberg collapsed with the fall of Croia (1466), and Venetian supremacy in Upper Albania ended with the capture of Scutari (1478). Only the mountain stronghold of Montenegro and the Italian city-states on the Adriatic coast escaped subjection. In the 16th century under Solymán the Magnificent (1520-1566) the Ottoman power attained its greatest height; after the unsuccessful siege of Vienna (1683) it began to decline. After the period of decadence was marked in the latter half of the 18th century by the formation of practically independent pashaliks or fiefs, such as those of Scutari under Mahommed of Bushat, Iannina under Ali of Tepelen, and Viden under Pasvan-oglu. The detachment of the outlying portions of the empire followed. Owing to the uncompromising character of the Mahomedan religion and the contemptuous attitude of the dominant race, the subject nationalities underwent no process of assimilation during the four centuries of Turkish rule; they retained not only their language but their religion, manners and peculiar characteristics, and when the power of the central authority waned they still possessed the germs of a national existence. The independence of Greece was acknowledged in 1829, that of Servia (as a tributary principality) in 1830. No territorial changes within the Peninsula followed the Crimean War; but the continuance of the weakened authority of the Porte tended indirectly to the independent development of the various nationalities. The Ionian Islands were ceded by Great Britain to Greece in 1864. The great break-up came in 1878. The abortive treaty of San Stefano, concluded in that year, reduced the Turkish possessions in the Peninsula to Albania, Epirus, Thessaly and a portion of southern Thrace. A large Bulgarian principality was created extending from the Danube to the Aegean and from the Black Sea to the river Drin in Albania; it received a considerable coast-line on the Aegean and abutted on the Gulf of Salonica under the walls of that town. At the same time the frontiers of Servia and Montenegro were enlarged so as to become almost contiguous, and Montenegro received the ports of Antivari and Dulcigno on the Adriatic. From a strategic point of view the Bulgaria of the San Stefano treaty threatened Salonica, Adrianople and Constantinople itself; and the great powers, anticipating that the new state would become a Russian dependency, refused their sanction to its provisions. The treaty of Berlin followed, which limited the principality to the country between the Danube and the Balkans, created the autonomous province of Eastern Rumelia south of the Balkans, and left the remainder of the proposed Bulgarian state under Turkish rule. The Montenegrin frontier laid down at San Stefano was considerably curtailed, Dulcigno, the district north-east of the Tara, and other territories being restored to Turkey; in addition to Nish, Servia received the districts of Piot and Vranja on the east instead of the Ibar valley on the

west; the Dobruja, somewhat enlarged, was ceded to Rumania which surrendered southern Bessarabia to Russia. Bosnia and Herzegovina were handed over to Austrian administration; under a subsequent convention with Turkey, Austria sent troops into the sanjak of Novibazar. The complete independence of the principalities of Servia, Rumania and Montenegro was recognized. The claims of Greece, ignored at San Stefano, were admitted at Berlin; an extension of frontier, including Epirus as well as Thessaly, was finally sanctioned by the powers in 1880, but owing to the tenacious resistance of Turkey only Thessaly and the district of Arta were acquired by Greece in 1881. Rumania was proclaimed a kingdom in that year, Servia in 1882. In 1880, after a naval demonstration by the powers, Dulcigno was surrendered to Montenegro in compensation for the districts of Plava and Gusinye restored to Turkey. In 1886 the informal union of Eastern Rumelia with Bulgaria was sanctioned by Europe, the districts of Tumulsh (Rhodope) and Krjali being given back to the sultan. In 1897 Crete was withdrawn from Turkish administration, and the Greco-Turkish War of that year was followed by the cession to Turkey of a few strategic points on the Thessalian frontier. In 1908 Bosnia and Herzegovina were annexed to the Dual Monarchy, and Bulgaria (including Eastern Rumelia) was proclaimed an independent kingdom.

The growth and development of the Balkan nations have, to a great extent, been retarded by the international jealousies arising from the Eastern Question. The possibility of the young states entering into a combination which would enable them to offer a united resistance to foreign interference while simultaneously effecting a compromise in regard to their national aims, has at various times occupied the attention of Balkan politicians. Among the earliest advocates of this idea was Rustich, the Servian statesman. During the reaction against Russia which followed the war of 1877 informal discussions were conducted with this object, and it was even suggested that a reformed or constitutional Turkey might find a place in the confederation. The movement was favourably regarded by King Charles of Rumania and Prince Alexander of Bulgaria. But the revolt of Eastern Rumelia, followed by the Servo-Bulgarian War and the coercion of Greece by the powers, embittered the rivalry of the various races, and the project was laid aside. It was revived in a somewhat modified form in 1891 by Tricoupsis, who suggested an offensive alliance of the Balkan states, directed against Turkey and aiming at a partition of the Sultan's possessions in Europe. The scheme, which found favour in Servia, was frustrated by the opposition of Stamboloff, who denounced it to the Porte. In 1897 a Bulgarian proposal for joint pacific action with a view to obtaining reforms in Macedonia was rejected by Greece.

AUTHORITIES.—Special bibliographies are appended to the separate articles which deal with the various political divisions of the Peninsula. For a general description of the whole region, its inhabitants, political problems, &c., see "Mysidseus," *Turkey in Europe* (London, 1900), a work of exceptional interest and value. See also *The Balkan Question*, ed. L. Villari (London, 1905); W. Miller, *Travels and Politics in the Near East* (London, 1898); L. Lamouche, *La Péninsule balkanique* (Paris, 1899); H. C. Thomson, *The Outgoing Turk* (London, 1897); T. Joanne, *Etats du Danube et des Balkans* (Paris, 1895); R. Millet, *Souvenirs des Balkans* (Paris, 1891); V. Cambon, *Autour des Balkans* (Paris, 1890); P. J. Hamard, *Par delà l'Adriatique et les Balkans* (Paris, 1890); E. de Laveleye, *La Péninsule des Balkans* (Brussels, 1886). For geology see F. Toula, "Materialien zu einer Geologie der Balkan-halbinsel," *Jahr. k.-k. geol. Reichsanst.* (Vienna, vol. xxxii, 1883), pp. 61-114; A. Bittner, M. Neumayr, &c., *Denks. k. Acad. Wiss. Wien, math.-nat. Cl.*, vol. xl. (1880); A. Philippson, *Der Peloponnes* (Berlin, 1892); J. Cvijic, "Die Tektonik der Balkanhalbinsel," *Conr. R. IX. Cong. geol. inter. Vienne*, pp. 347-370 (1904). For the condition of the Peninsula before the Treaty of Berlin, see E. Rüffer, *Die Balkanhalbinsel und ihre Völker* (Bautzen, 1869); Mackenzie and Irby, *Travels in the Slavonic Provinces of Turkey* (London, 1866); and A. Boué, *La Turquie d'Europe* (Paris, 1840). W. Miller, *The Balkans* (London, 1896), sketches the history of Bulgaria, Montenegro, Rumania and Servia. See also Sir E. Herislet, *The Map of Europe by Treaty*, esp. vol. iv. (London, 1875-1891); J. D. Bouchier, "A Balkan Confederation," in the *Fortnightly Review* (London, September 1891); the Austrian and Russian staff maps, and the ethnographical map of Kiepert and Peucker.

A Balkan confederation.

BALKASH, or **BALKHASH** (called by the Kirghiz *Ak-denghis* or *Ala-denghis* and by the Chinese *Si-hai*), a lake of Asiatic Russia, in the Kirghiz steppes, between the governments of Semipalatinsk and Semirechensk, in 45° to 47° N. and 73° 30' to 79° E., about 600 m. to the east of Lake Aral. It is fourth in size of the lakes in Eurasia, having an area of 7115 sq. m., and lies at an altitude of 900 ft. It has the shape of a broad crescent, about 430 m. long from W.S.W. to E.N.E., having its concave side turned southwards; its width varies from 36 to 53 m. Its north-western shore is bordered by a dreary plateau, known as the Famine Steppe (*Bek-pak-dala*). The south-east shore, on the contrary, is low, and bears traces of having extended formerly as far as the Sasyk-kul and the Ala-kul. The Kirghiz in 1903 declared that its surface had been rising steadily during the preceding ten years, though prior to that it was dropping. The chief feeder of the lake is the Ili, which rises in the Khan-tengri group of the Tian-shan Mountains. The Karatal, the Aksu and the Lepsa also enter from the south-east, and the Ayaguz from the north-east. The first three rivers make their way with difficulty through the sands and reeds, which at a quite recent time were covered by the lake. Although it has no outlet, its waters are relatively fresh. It freezes generally from November to April. Its greatest depth, 35 ft., is along the north-west shore. The fauna of the lake and of its tributaries—explored by Nikolsky—is more akin to the fauna of the rivers of the Tarim basin than to that of the Aral; it also does not contain the common frog. It seems, therefore, probable that Lake Balkash stood formerly in communication through lakes Ebi-nor and Ayar (Telli-nor) with the lake that formerly filled the Lukchun depression (in 80½° E. long. and 42½° N. lat.), but researches show that a connexion with Lake Aral—at least in recent times—was improbable. The lake has been investigated by L. S. Berg (see *Petermanns Mitteilungen*, 1903).

BALKH, a city of Afghanistan, about 100 m. E. of Andkhui and some 46 m. S. of the Oxus. The city which is identical with the ancient Bactra or Zainaspa, is now for the most part a mass of ruins, situated on the right bank of the Balkh river, 1200 ft. above the sea. It comprises about 500 houses of Afghan settlers, a colony of Jews and a small bazaar, set in the midst of a waste of ruins and many acres of débris. Entering by the west (or Akcha) gate, one passes under three arches, which are probably the remnants of a former Jama Masjid. The outer walls (mostly in utter disrepair) are about 6½ to 7 m. in perimeter, and on the south-eastern borders are set high on a mound or rampart, indicating a Mongol origin. The fort and citadel to the north-east are built well above the town on a barren mound and are walled and moated. There is, however, little left but the remains of a few pillars. The Masjid Sabz, with its green-tiled dome, is said to be the tomb of a Khwaja, Abul Narsi Parsar. Nothing but the arched entrance remains of the Madrasa, which is traditionally not very old. The earlier Buddhist constructions have proved more durable than the Mahomedan buildings. The Top-i-Rustam is 50 yds. in diameter at the base and 30 yds. at the top, circular and about 50 ft. high. Four circular vaults are sunk in the interior and four passages have been pierced below from the outside, which probably lead to them. The base of the building is constructed of sun-dried bricks about 2 ft. square and 4 or 5 in. thick. The Takht-i-Rustam is wedge-shaped in plan, with uneven sides. It is apparently built of pisé mud (i.e. mud mixed with straw and puddled). It is possible that in these ruins we may recognize the Nan Vihara of the Chinese traveller Hsüan Tsang. There are the remains of many other topes (or stupas) in the neighbourhood. The mounds of ruins on the road to Mazar-i-Sharif probably represent the site of a city yet older than those on which stands the modern Balkh. The town is garrisoned by a few hundred kasidas, the regular troops of Afghan Turkestan being cantoned at Takhtapul, near Mazar-i-Sharif. The gardens to the north-east contain a caravanserai, which is fairly well kept and comfortable. It forms one side of a courtyard, which is shaded by a group of magnificent chenar trees.

The antiquity and greatness of the place are recognized by the native populations, who speak of it as the *Mother of Cities*. Its foundation is mythically ascribed to Kaiomurs, the Persian Romulus; and it is at least certain that, at a very early date, it was the rival of Ecbatana, Nineveh and Babylon. For a long time the city and country was the central seat of the Zoroastrian religion, the founder of which is said to have died within the walls. From the *Memoirs of Hsüan Tsang*, we learn that, at the time of his visit in the 7th century, there were in the city, or its vicinity, about a hundred Buddhist convents, with 3000 devotees and that there was a large number of stupas, and other religious monuments. The most remarkable was the *Nau Behar*, *Nava Bihara* or New Convent, which possessed a very costly statue of Buddha. A curious notice of this building is found in the Arabian geographer Yāqūt. Ibn-Haukal, an Arabian traveller of the 10th century, describes Balkh as built of clay, with ramparts and six gates, and extending half a parasang. He also mentions a castle and a mosque. Idrisi, in the 12th century, speaks of its possessing a variety of educational establishments, and carrying on an active trade. There were several important commercial routes from the city, stretching as far east as India and China. In 1220 Jenghiz Khan sacked Balkh, butchered its inhabitants and levelled all the buildings capable of defence.—treatment to which it was again subjected in the 14th century by Timur. Notwithstanding this, however, Marco Polo can still, in the following century, describe it as "a noble city and a great." Balkh formed the government of Aurangzeb in his youth. In 1736 it was conquered by Nadir Shah. Under the Durani monarchy it fell into the hands of the Afghans; it was conquered by Shah Murad of Kunduz in 1820, and for some time was subject to the khan of Bokhara. In 1850 Mahommed Akram Khan, Barakzai, captured Balkh, and from that time it remained under Afghan rule.

See *Hsüan Tsang*, tr. by Julien, vol. i. pp. 29-32; Burnes's *Travels in Bokhara* (1831-1833); Ferrier's *Travels*; Vambéry's *Bokhara* (1873); *Report of the Russo-Afghan Boundary Commission of 1884-1885*. (T. H. H.)

BALL, SIR ALEXANDER JOHN, BART. (1759-1809), British rear-admiral and governor of Malta, came of a Gloucestershire family. He entered the navy, and in 1778 was promoted lieutenant. Three years later began a close association with Rodney, and, two days after his chief's crowning victory of April 12, 1782, Ball was promoted commander, and in 1783 he became captain. At this time he spent a year in France with the double purpose of learning the language and living economically. Nelson, then a captain, was at this time by no means favourably impressed by his future friend and comrade, and spoke of him as a "great coxcomb." It was not until 1790 that Ball received a command. From that year, however, he was continuously employed. In 1793, assistance rendered by him to Nelson's ship in heavy weather caused the latter to forget his former animosity, and from that time the two were close friends. Under Nelson's command Ball took part in the battle of the Nile, and his ship, the "Alexander," was the particular opponent of Bruyès' flagship, "L'Orient," which blew up. Two months later he was ordered to the blockade of Malta, which was kept up without a break for the next two years. Ball committed the blockade to his first lieutenant, and himself led the marines and local militia, which made the siege on the land side. His care for his men laid the foundations of his popularity with the Maltese which continued till his death. After the fall of Malta, Ball practically retired from the service, in spite of Nelson's urgent entreaty that he should continue afloat, and from 1801 (when he was made a baronet) to 1809 he was governor of Malta, where he endeared himself to the people by his regard for their interests, and his opposition to the policy of treating the island as a conquered dependency. His friendship with Lord Nelson, whose letters prove his high regard for him, was only broken by death. Ball died on the 20th of October 1809 and was buried in Malta. Sir Alexander Ball was kind to Coleridge and is highly praised by him in *The Friend*, "The Third Landing Place." There are numerous mentions of Ball in Nelson's *Despatches*, in Sir H. Nicolas' edition.

BALL, JOHN (d. 1381), an English priest who took a prominent part in the peasant revolt in 1381. Little is known of his early years, but he lived probably at York and afterwards at Colchester. He gained considerable fame as a preacher by expounding the doctrines of John Wycliffe, but especially by his insistence on the principle of social equality. These utterances brought him into collision with the archbishop of Canterbury, and on three occasions he was committed to prison. He appears also to have been excommunicated, and in 1366 all persons were forbidden to hear him preach. His opinions, however, were not moderated, nor his popularity diminished by these measures, and his words had a considerable effect in stirring up the rising which broke out in June 1381. Ball was then in prison at Maidstone; but he was quickly released by the Kentish rebels, to whom he preached at Blackheath from the text, "When Adam delved and Eve span, Who was then a gentleman?" He urged his hearers to kill the principal lords of the kingdom and the lawyers; and he was afterwards among those who rushed into the Tower of London to seize Simon of Sudbury, archbishop of Canterbury. When the rebels dispersed Ball fled to the midland counties, but was taken prisoner at Coventry and executed in the presence of Richard II. on the 15th of July 1381. Ball, who was called by Froissart "the mad priest of Kent," seems to have possessed the gift of rhyme. He undoubtedly voiced the feelings of the lower orders of society at that time.

See Thomas Walsingham, *Historia Anglicana*, edited by H. T. Riley (London, 1863-1864); Henry Knighton, *Chronicon*, edited by J. R. Lumby (London, 1889-1895); Jean Froissart, *Chroniques*, edited by S. Luce and G. Raynaud (Paris, 1869-1897); C. E. Maurice, *Lines of English Popular Leaders in the Middle Ages* (London, 1875); C. Oman, *The Great Revolt of 1381* (Oxford, 1906).

BALL, JOHN (1585-1640), English puritan divine, was born at Cassington, Oxfordshire, in October 1585. After taking his B.A. degree from St Mary's Hall, Oxford, in 1608, he went into Cheshire to act as tutor to the children of Lady Cholmondeley. He adopted Puritan views, and after being ordained without subscription, was appointed to the small curacy of Whitmore in Staffordshire. He was soon deprived by John Bridgeman, the high church bishop of Chester, who put him to much suffering. He became a schoolmaster and earned a wide and high reputation for his scholarship and piety. He died on the 20th of October 1640. The most popular of his numerous works was *A Short Catechism, containing all the Principal Grounds of Religion* (14 editions before 1632). His *Treatise of Faith* (1632), and *Friendly Trial of the Grounds tending to Separation* (1640), the latter of which defines his position with regard to the church, are also valuable.

BALL, JOHN (1818-1889), Irish politician, naturalist and Alpine traveller, eldest son of an Irish judge, Nicholas Ball, was born at Dublin on the 20th of August 1818. He was educated at the Roman Catholic College at Oscott near Birmingham, and at Christ's College, Cambridge. He showed in early years a taste for natural science, particularly botany; and after leaving Cambridge he travelled in Switzerland and elsewhere in Europe, studying his favourite pursuits, and contributing papers on botany and the Swiss glaciers to scientific periodicals. In 1846 he was made an assistant poor-law commissioner, but resigned in 1847, and in 1848 stood unsuccessfully as a parliamentary candidate for Sligo. In 1849 he was appointed second poor-law commissioner, but resigned in 1852 and successfully contested the county of Carlow in the Liberal interest. In the House of Commons he attracted Lord Palmerston's attention by his abilities, and in 1885 was made under-secretary for the colonies, a post which he held for two years. At the colonial office he had great influence in furthering the cause of natural science, particularly in connexion with equipment of the Palliser expedition in Canada, and with Sir W. Hooker's efforts to obtain a systematic knowledge of the colonial floras. In 1858 he stood for Limerick, but was beaten, and he then gave up politics and devoted himself to natural history. He was first president of the Alpine Club (founded 1857), and it is for his work as an Alpinist that he is chiefly remembered, his well-known *Alpine*

Guide (London, 1863-1868) being the result of innumerable climbs and journeys and of careful observation recorded in a clear and often entertaining style. He also travelled in Morocco (1871) and South America (1882), and recorded his observations in books which were recognized as having a scientific value. He died in London on the 21st of October 1889.

BALL, THOMAS (1819-), American sculptor, was born at Charlestown, Massachusetts, on the 3rd of June 1819. He was the son of a house-and-sign-painter, and after starting, self-taught, as a portrait painter he turned his attention in 1851 to sculpture, his earliest work being a bust of Jenny Lind. At thirty-five he went to Florence for study; there, with an interval of work in Boston, Massachusetts, in 1857-1865, he remained for more than thirty years, being one of the artistic colony which included the Brownings and Hiram Powers. He returned to America in 1867, and lived in Montclair, New Jersey, with a studio in New York City. His work includes many early cabinet busts of musicians (he was an accomplished musician himself, and was the first in America to sing "Elijah"), and later the equestrian statue of Washington in the Boston public gardens, probably his best work; Josiah Quincy in City Hall Square, Boston; Charles Sumner in the public gardens of Boston; Daniel Webster in Central Park, New York City; the Lincoln Emancipation group at Washington; Edwin Forrest as "Coriolanus," in the Actors' Home, Philadelphia, and the Washington monument in Methuen, Massachusetts. His work has had a marked influence on monumental art in the United States and especially in New England. In 1891 he published an autobiographical volume, *My Three Score Years and Ten*.

BALL (in Mid. Eng. *bal*; the word is probably cognate with "bale," Teutonic in origin, cf. also Lat. *foliis*, and Gr. *πάλλα*), any rounded body, particularly one with a smooth surface, whether used for games, as a missile, or applied to such rounded bodies as the protuberance at the root of the thumb or the big toe, to an enarthrosis, or "ball socket" joint, such as that of the hip or shoulder, and the like. A ball, as the essential feature in nearly every form of game requiring physical exertion, must date from the very earliest times. A rolling object appeals not only to a human baby but to a kitten and a puppy. Some form of game with a ball is found portrayed on Egyptian monuments, and is played among the least advanced of savage tribes at the present day. In Homer, Nausicaa was playing at ball with her maidens when Odysseus first saw her in the land of the Phaeacians (*Od.* vi. 100). And Halios and Laodamas performed before Alcinous and Odysseus with ball play, accompanied with dancing (*Od.* vii. 370). The Hebrews, the least athletic of races, have no mention of the ball in their scriptures. Among the Greeks games with balls (*σφαίρα*) were regarded as a useful subsidiary to the more violent athletic exercises, as a means of keeping the body supple, and rendering it graceful, but were generally left to boys and girls. Similarly at Rome they were looked upon as an adjunct to the bath, and were graduated to the age and health of the bathers, and usually a place (*sphaeristerium*) was set apart for them in the baths (*thermae*). Of regular rules for the playing of ball games, little trace remains, if there were any such. The names in Greek for various forms, which have come down to us in such works as the *Ἵστοριογράφων* of Pollux of Naucratis, imply little or nothing of such; thus, *ἀπὸρραγίς* only means the putting of the ball on the ground with the open hand, *σφαιρία* the flinging of the ball in the air to be caught by two or more players; *φαινόδα* would seem to be a game of catch played by two or more, where feinting is used as a test of quickness and skill. Pollux (i. x. 104) mentions a game called *ἐπικυπος*, which has often been looked on as the origin of football. It seems to have been played by two sides, arranged in lines; how far there was any form of "goal" seems uncertain. Among the Romans there appear to have been three types or sizes of ball, the *pila*, or small ball, used in catching games, the *paganica*, a heavy ball stuffed with feathers, and the *foliis*, a leather ball filled with air, the largest of the three. This was struck from player to player, who wore a kind of gauntlet on the arm. There was a game known as *trigon*, played by three players standing in

the form of a triangle, and played with the *foliis*, and also one known as *harpastum*, which seems to imply a "scrimmage" among several players for the ball.¹ These games are known to us through the Romans, though the names are Greek. The various modern games played with a ball or balls and subject to rules are treated under their various names, such as polo, cricket, football, &c.

From Fr. *bal*, *baller*, to dance (late Lat. *ballare*, and hence connected with "ballad," "ballet") comes "ball," meaning a dance, and especially a social gathering of people for the purpose of dancing.

BALLADE, the technical name of a complicated and fixed form of verse, arranged on a precise system, and having nothing in common with the word *ballad*, except its derivation from the same Low Latin verb, *ballare*, to dance. In the 14th and 15th centuries it was spelt *balade*. In its regular conditions a ballade consists of three stanzas and an envoi; there is a refrain which is repeated at the close of each stanza and of the envoi. The entire poem should contain but three or four rhymes, as the case may be, and these must be reproduced with exactitude in each section. These rules were laid down by Henri de Croi, whose *L'Art et science de rhétorique* was first printed in 1493, and he added that if the refrain consists of eight syllables, the ballade must be written in huitains (eight-line stanzas), if of ten syllables in dizains (ten-line), and so on. The form can best be studied in an example, and we quote, as absolutely faultless in execution, the famous "Ballade aux Enfants Perdus," composed by Théodore de Banville in 1861:—

" Je le sais bien que Cythère est en deuil!
Que son jardin, souffleté par l'orage,
O mes amis, n'est plus qu'un sombre écueil
Agonisant sous le soleil sauvage.
La solitude habite son rivage.
Qu'importe! allons vers les pays fictifs!
Cherchons la plage où nos désirs oisifs
S'abreuvèrent dans le sacré mystère
Fait pour un cœur d'esprits contemplatifs:
Embarquons-nous pour la belle Cythère.

" La grande mer sera notre cerceuil;
Nous servirons de proie au noir naufrage,
Le feu du ciel punira notre orgueil
Et l'aiguillon nous garde son outrage.
Qu'importe! allons vers le clair paysage!
Malgré la mer jalouse et les récifs,
Venez, portons comme des fugitifs,
Loin de ce monde au souffle délétère.
Nous dont les cœurs sont des ramiers plaintifs,
Embarquons-nous pour la belle Cythère.

" Des serpents gris se traînent sur le seuil
Où souriait Cypris, la chère image
Aux tresses d'or, la vierge au doux accueil!
Mais les Amours sur le plus haut cordeau
Nous chantent l'hymne adoré du voyage.
Héros cachés dans ces corps maladifs,
Fuyons, partons sur nos légers esquifs,
Vers le divin bocage où la panthère
Pleure d'amour sous les rosiers lascifs:
Embarquons-nous pour la belle Cythère.

Envoi.

" Rasseisons d'azur nos yeux pensifs!
Oiseaux chanteurs, dans la brise expansifs,
Ne souillons pas nos ailes sur la terre.
Volons, charmés, vers les dieux primitifs!
Embarquons-nous pour la belle Cythère."

This is the type of the ballade in its most elaborate and highly-finished form, which it cannot be said to have reached until the 14th century. It arose from the *canzone* or *ballo* of the Italians, but it is in Provençal literature that the ballade first takes a modern form. It was in France, however, and not until the reign of Charles V., that the ballade as we understand it began to flourish; instantly it became popular, and in a few years the art-out-pur of these poems was inculcated. Machault, Froissart, Eustache Deschamps and Christine de Pisan were among the poets who cultivated the ballade most abundantly. Later, those

¹ Martial (iv. 19. 6) calls the *harpastum*, *pulverulentum*, implying that it involves a considerable amount of exertion.

of Alain Chartier and Henri Baude were famous, while the form was chosen by François Villon for some of the most admirable and extraordinary poems which the middle ages have handed down to us. Somewhat later, Clément Marot composed ballades of great precision of form, and the fashion culminated in the 17th century with those of Madame Deshoulières, Sarrazin, Voiture and La Fontaine. Attacked by Molière, and by Boileau, who wrote

" La ballade asservie à ses vieilles maximes,
Souvent doit tout son lustre au caprice des rimes,"

the ballade went entirely out of fashion for two hundred years, when it was resuscitated in the middle of the 19th century by Théodore de Banville, who published in 1873 a volume of *Trentesix ballades joyeuses*, which has found many imitators. The ballade, a typically French form, has been extensively employed in no other language, except in English. In the 15th and 16th centuries many ballades were written, with more or less close attention to the French rules, by the leading English poets, and in particular by Chaucer, by Gower (whose surviving ballades, however, are all in French) and by Lydgate. An example from Chaucer will show that the type of strophe and rhyme arrangement was in medieval English:—

" Madamé, ye been of all beauty shrine
As far as circled is the mapperdoun;
For, as the crystal, glorious ye shine,
And liké ruby been your cheeks round;
Therewith ye been so merry and so jocund
That at a revel when that I see you dance,
It is an oinément unto my wound,
Though ye to me ne do no dalance.

" For though I weep of tearful full a tine [cask],
Yet may that wee my heartis not confound;
Your seemly voice, that ye so small out-twine,
Maketh my thought in joy and bliss abound.
So courteously I go, with lovè bound,
That to myself I say, in my penance,
Sufficeth me to love you, Rosamound,
Though ye to me ne do no dalance.

" Was never pike wallowed in galantine,
As I in love am wallowed and w-round;
For which full oft I of myself divine
That I am trueè Tristram the second.
My love may not refrayed [cooled down] be nor afound
I burn ay in an amorous plesance. [foundered];
Do what you list, I will your thrall be found,
Though ye to me ne do no dalance."

The absence of an envoi will be noticed in Chaucer's, as in most of the medieval English ballades. This points to a relation with the earliest French form, in its imperfect condition, rather than with that which afterwards became accepted. But a ballade without an envoi lacks that section whose function is to tie together the rest, and complete the whole as a work of art. After the 16th century original ballades were no more written in English until the latter part of the 19th, when they were re-introduced, almost simultaneously, by Algernon Charles Swinburne, Austin Dobson, Andrew Lang, Edmund Gosse and W. E. Henley; but D. G. Rossetti's popular translation of Villon's "Ballade of Fair Ladies" may almost be considered an original poem, especially as it entirely disregards the metrical rules of the ballades. Mr. Dobson's "The Prodigals" (1876) was one of the earliest examples of a correct English specimen. In 1880 Mr. Lang published a volume of *Ballades in Blue China*, which found innumerable imitators. The modern English ballades have been, as a rule, closely modelled on the lines laid down in the 15th century by Henri de Croi. With the exception of the sonnet, the ballade is the noblest of the artificial forms of verse cultivated in English literature. It lends itself equally well to pathos and to mockery, and in the hands of a competent poet produces an effect which is rich in melody without seeming fantastic or artificial. (E. G.)

BALLADS. The word "ballad" is derived from the O. Fr. *baller*, to dance, and originally meant a song sung to the rhythmic movement of a dancing chorus. Later, the word, in the form of *ballade* (q.v.), became the technical term for a particular form of old-fashioned French poetry, remarkable for its involved and

recurring rhymes. "Laisse moi aux Jeux Floraux de Toulouse toutes ces vieux poésies Françaises comme *ballades*," says Joachim du Bellay in 1550; and Philaminte, the lady pedant of Molière's *Femmes Savantes*, observes—

"La ballade, à mon goût, est une chose fade,
Ce n'en est plus la mode, elle sent son vieux temps."

In England the term has usually been applied to any simple tale told in simple verse, though attempts have been made to confine it to the subject of this article, namely, the literary form of popular songs, the folk-tunes associated with them being treated in the article *SONG*. By popular songs we understand what the Germans call *Volkslieder*, that is, songs with words composed by members of the people, for the people, handed down by oral tradition, and in style, taste and even incident, common to the people in all European countries. The beauty of these purely popular ballads, their directness and freshness, has made them admired even by the artificial critics of the most artificial periods in literature. Thus Sir Philip Sydney confesses that the ballad of *Chevy Chase*, when chanted by "a blind crowder," stirred his blood like the sound of trumpet. Addison devoted two articles in the *Spectator* to a critique of the same poem. Montaigne praised the *naïveté* of the village carols; and Malherbe preferred a rustic *chansonnette* to all the poems of Ronsard. These, however, are rare instances of the taste for popular poetry, and though the Danish ballads were collected and printed in the middle of the 16th century, and some Scottish collections date from the beginning of the 18th, it was not till the publication of Allan Ramsay's *Evergreen and Tea Table Miscellany*, and of Bishop Percy's *Reliques* (1765), that a serious effort was made to recover Scottish and English folk-songs from the recitation of the old people who still knew them by heart. At the time when Percy was editing the *Reliques*, Madame de Chénier, the mother of the celebrated French poet of that name, composed an essay on the ballads of her native land, modern Greece; and later, Herder and Grimm and Goethe, in Germany, did for the songs of their country what Scott did for those of Liddesdale and the Forest. It was fortunate, perhaps, for poetry, though unlucky for the scientific study of the ballads, that they were mainly regarded from the literary point of view. The influence of their artless melody and straightforward diction may be felt in the lyrics of Goethe and of Coleridge, of Wordsworth, of Heine and of André Chénier. Chénier, in the most affected age even of French poetry, translated some of the Romaic ballads; one, as it chanced, being almost identical with that which Shakespeare borrowed from some English reciter, and put into the mouth of the mad Ophelia. The beauty of the ballads and the interest they excited led to numerous forgeries and modern interpolations, which it is seldom difficult to detect with certainty. Editors could not resist the temptation to interpolate, to restore, and to improve the fragments that came in their way. The marquis de la Villemarqué, who first drew attention to the ballads of Brittany, is not wholly free from this fault. Thus a very general scepticism was awakened, and when questions came to be asked as to the date and authorship of the Scottish traditional ballads, it is scarcely to be wondered at that Dr Chambers attributed most of them to the accomplished Lady Wardlaw, who lived in the middle of the 18th century.

The vexed and dull controversy as to the origin of Scottish folk-songs was due to ignorance of the comparative method, and of the ballad literature of Europe in general. The result of the discussion was to leave a vague impression that the Scottish ballads were perhaps as old as the time of Dunbar, and were the production of a class of professional minstrels. These minstrels are a stumbling-block in the way of the student of the growth of ballads. The domestic annals of Scotland show that her kings used to keep court-bards, and also that strollers, *jongleurs*, as they were called, went about singing at the doors of farm-houses and in the streets of towns. Here were two sets of minstrels who had apparently left no poetry; and, on the other side, there was a number of ballads that claimed no author. It was the easiest and most satisfactory inference that the courtly minstrels made the verses, which the wandering crowds

imitated or corrupted. But this theory fails to account, among other things, for the universal sameness of tone, of incident, of legend, of primitive poetical formulae, which the Scottish ballad possesses, in common with the ballads of Greece, of France, of Provence, of Portugal, of Denmark and of Italy. The object, therefore, of this article is to prove that what has long been acknowledged of nursery tales, of what the Germans call *Märchen*, namely, that they are the immemorial inheritance at least of all European peoples, is true also of some ballads. Their present form, of course, is relatively recent: in centuries of oral recitation the language altered automatically, but the stock situations and ideas of many *romantic* ballads are of dateless age and world-wide diffusion. The main incidents and plots of the fairy tales of Celts and Germans and Slavonic and Indian peoples, their unknown antiquity and mysterious origin, are universally recognized. No one any longer attributes them to this or that author, or to this or that date. The attempt to find date or author for a genuine popular song is as futile as a similar search in the case of a *Märchen*. It is to be asked, then, whether what is confessedly true of folk-tales,—of such stories as the *Sleeping Beauty* and *Cinderella*,—is true also of folk-songs. Are they, or have they been, as universally sung as the fairy tales have been narrated? Do they, too, bear traces of the survival of primitive creeds and primitive forms of consciousness and of imagination? Are they, like *Märchen*, for the most part, little influenced by the higher religions, Christian or polytheistic? Do they turn, as *Märchen* do, on the same incidents, repeat the same stories, employ the same machinery of talking birds and beasts? Lastly, are any specimens of ballad literature capable of being traced back to extreme antiquity? It appears that all these questions may be answered in the affirmative; that the great age and universal diffusion of the ballad may be proved; and that its birth, from the lips and heart of the people, may be contrasted with the origin of an artistic poetry in the demand of an aristocracy for a separate epic literature destined to be its own possession, and to be the first development of a poetry of personality,—a record of *individual* passions and emotions. After bringing forward examples of the identity of features in European ballad poetry, we shall proceed to show that the earlier *genre* of ballads with refrain sprang from the same primitive custom of dance, accompanied by improvised song, which still exists in Greece and Russia, and even in valleys of the Pyrenees.

There can scarcely be a better guide in the examination of the *notes* or marks of popular poetry than the instructions which M. Ampère gave to the committee appointed in 1852-1853 to search for the remains of ballads in France. M. Ampère bade the collectors look for the following characteristics:—"The use of assonance in place of rhyme, the brusque character of the recital, the textual repetition, as in Homer, of the speeches of the persons, the constant use of certain numbers,—as three and seven,—and the representation of the commonest objects of every-day life as being made of gold and silver." M. Ampère might have added that French ballads would probably employ a "bird chorus," the use of talking-birds as messengers; that they would repeat the plots current in other countries, and display the same non-Christian idea of death and of the future world (see "The Lyke-wake Dirge"), the same ghostly superstitions and stories of metamorphosis, and the same belief in elves and fairies, as are found in the ballads of Greece, of Provence, of Brittany, Denmark and Scotland. We shall now examine these supposed common notes of all genuine popular song, supplying a few out of the many instances of curious identity. As to brusqueness of recital, and the use of assonance instead of rhyme, as well as the aid to memory given by reproducing speeches verbally, these are almost unavoidable in all simple poetry preserved by oral tradition. In the matter of recurring numbers, we have the eternal—

"Trois belles filles

L'y en a z'une plus belle que le jour,"

who appear in old French ballads, as well as the "Three Sailors," whose adventures are related in the Lithuanian and Provençal originals of Thackeray's *Little Billee*. Then there is "the league,

the league, the league, but barely three," of Scottish ballads; and the *τρία πουλακιά*, three golden birds, which sing the prelude to Greek folk-songs, and so on. A more curious note of primitive poetry is the lavish and reckless use of gold and silver. H. F. Tozer, in his account of ballads in the *Highlands of Turkey*, remarks on this fact, and attributes it to Eastern influences. But the horses' shoes of silver, the knives of fine gold, the talking "birds with gold on their wings," as in Aristophanes, are common to all folk-song. Everything almost is gold in the *Kalevala* (*q.v.*), a so-called epic formed by putting into juxtaposition all the popular songs of Finland. Gold is used as freely in the ballads, real or spurious, which M. Verkovich has had collected in the wilds of Mount Rhodope. The Captain in the French song is as lavish in his treatment of his runaway bride,—

"Son amant l'habille,
Tout en or et argent";

and the rustic in a song from Poitou talks of his *faucille d'or*, just as a variant of Hugh of Lincoln introduces gold chairs and tables. Again, when the lover, in a ballad common to France and to Scotland, cuts the winding-sheet from about his living bride—"il tira ses ciseaux d'or fin." If the horses of the Klephts in Romaic ballads are gold shod, the steed in *Willie's Lady* is no less splendidly accoutred,—

"Silver shod before,
And gowden shod behind."

Readers of Homer, and of the *Chanson de Roland*, must have observed the same primitive luxury of gold in these early epics, in Homer reflecting perhaps the radiance of the actual "golden Mycenae."

Next as to talking-birds. These are not so common as in *Märchen*, but still are very general, and cause no surprise to their human listeners. The omniscient popinjay, who "up and spoke" in the Border minstrelsy, is of the same family of birds as those that, according to Talvj, pervade Servian song; as the *τρία πουλακιά* which introduce the story in the Romaic ballads; as the wise birds whose speech is still understood by exceptionally gifted Zulus; as the wicked dove that whispers temptation in the sweet French folk-song; as the "bird that came out of a bush, on water for to dine," in the *Water o' Wearies Well*.

In the matter of identity of plot and incident in the ballads of various lands, it is to be regretted that no such comparative tables exist as Von Hahn tried, not very exhaustively, to make of the "story-roots" of *Märchen*. Such tables might be compiled from the learned notes and introductions of Prof. Child to his *English and Scottish Popular Ballads* (1898). A common plot is the story of the faithful leman, whose lord brings home "a brow new bride," and who recovers his affection at the eleventh hour. In Scotland this is the ballad of Lord Thomas and Fair Annie; in Danish it is Skiaan Anna. It occurs twice in M. Fauriel's collection of Romaic songs. Again, there is the familiar ballad about a girl who pretends to be dead, that she may be borne on a bier to meet her lover. This occurs not only in Scotland, but in the popular songs of Provence (collected by Damase Arbaud) and in those of Metz (Puymaigre), and in both countries an incongruous sequel tells how the lover tried to murder his bride, and how she was too cunning, and drowned him. Another familiar feature is the bush and briar, or the two rose trees, which meet and plait over the graves of unhappy lovers, so that all passers-by see them, and say in the Provençal,—

"Djou ague l'amo
Des paures amourosus."

Another example of a very widespread theme brings us to the ideas of the state of the dead revealed in folk-songs. *The Night Journey*, in M. Fauriel's Romaic collection, tells how a dead brother, wakened from his sleep of death by the longing of love, bore his living sister on his saddle-bow, in one night, from Bagdad to Constantinople. In Scotland this is the story of Proud Lady Margaret; in Germany it is the song which Bürger converted into Lenore; in Denmark it is *Aagé and Elsé*; in Brittany the dead foster-brother carries his sister to the apple close of the Celtic paradise (*Barzaz Breiz*). Only in Brittany

do the sad-hearted people think of the land of death as an island of Avalon, with the eternal sunset lingering behind the flowering apple trees, and gleaming on the fountain of forgetfulness. In Scotland the channering worm doth chide even the souls that come from where, "beside the gate of Paradise, the birch grows fair enough." The Romaic idea of the place of the dead, the garden of Charon, whence "neither in spring or summer, nor when grapes are gleaned in autumn, can warrior or maiden escape," is likewise pre-Christian. In Provençal and Danish folk-song, the cries of children ill-treated by a cruel step-mother awaken the departed mother,—

"Twas cold at night and the bairnies graat,
The mother below the moults heard that."

She reappears in her old home, and henceforth, "when dogs howl in the night, the step-mother trembles, and is kind to the children." To this identity of superstition we may add the less tangible fact of identity of tone. The balls of Klephtic exploits in Greece match the Border songs of Dick of the Cow and Kinmont Willie. The same simple delight of living animates the short Greek *Scolia* and their counterparts in France. Everywhere in these happier climes, as in southern Italy, there are snatches of popular verse that make but one song of rose trees, and apple blossom, and the nightgale that sings for maidens loverless,—

"Il ne chante pas pour moi,
J'en ai un, Dieu merci,"

says the gay French refrain.

It would not be difficult to multiply instances of resemblance between the different folk-songs of Europe; but enough has, perhaps, been said to support the position that some of them are popular and primitive in the same sense as *Märchen*. They are composed by peoples of an early stage who find, in a natural improvisation, a natural utterance of modulated and rhythmic speech, the appropriate relief of their emotions, in moments of high-wrought feeling or on solemn occasions. "Poesie" (as Puttenham well says in his *Art of English Poesie*, 1589) "is more ancient than the artificial of the Greeks and Latines, and used of the savage and uncivil, who were before all science and civilitie. This is proved by certificate of merchants and travellers, who by late navigations have surveyed the whole world, and discovered large countries, and wild people strange and savage, affirming that the American, the Perusine, and the very Cannibal do sing and also say their highest and holiest matters in certain riming versicles." In the same way Aristotle, discoursing of the origin of poetry, says (*Poet.* c. iv.), *ἐγένετο τὴν ποιησὶν ἐκ τῶν αὐτοσχεδιασμάτων*. M. de la Villemarqué in Brittany, M. Pitré in Italy, Herr Ulrich in France, have described the process of improvisation, how it grows out of the custom of dancing in large bands and accompanying the figure of the dance with song. "If the people," says M. Pitré, "find out who is the composer of a *canzone*, they will not sing it." Now in those lands where a blithe peasant life still exists with its dances, like the *kolos* of Russia, we find ballads identical in many respects with those which have died out of oral tradition in these islands. It is natural to conclude that originally some of the British ballads too were first improvised, and circulated in rustic dances. We learn from M. Bugeaud and M. de Puymaigre in France, that all ballads there have their air or tune, and that every dance has its own words, for if a new dance comes in, perhaps a fashionable one from Paris, words are fitted to it. Is there any trace of such an operatic, lyrical, dancing peasantry in austere Scotland? We find it in Gavin Douglas's account of—

"Sie as clepe wenches and damosels,
In gerys greens, wandering by spring wells,
Of bloomed branches, and flowers white and red,
Plattand their lusty chaplets for their head,
Some sang ring-sangs, dances, ledes, and rounds."

Now, ring-sangs are ballads, dancing songs; and *Young Tamlane*, for instance, was doubtless once danced to, as we know it possessed an appropriate air. Again, Fabyan, the chronicler (quoted by Ritson) says that the song of triumph over Edward II., "was after many days sung in dances, to the carols of the

maidens and minstrels of Scotland." We might quote the *Complaint of Scotland* to the same effect. "The shepherds, and their wyvis sang mony other melodi sangs, . . . than efter this suet celestial harmony, tha began to dance in ane ring." It is natural to conjecture that, if we find identical ballads in Scotland, and in Greece and Italy, and traces of identical customs—customs crushed by the Reformation, by Puritanism, by modern so-called civilization,—the ballads sprang out of the institution of dances, as they still do in warmer and pleasanter climates. It may be supposed that legends on which the ballads are composed, being found as they are from the White Sea to Cape Matapan, are part of the stock of primitive folk-lore. Thus we have an immemorial antiquity for the legends, and for the lyrical choruses in which their musical rendering was improvised. We are still at a loss to discover the possibly mythological germs of the legends; but, at all events, some ballads may be claimed as distinctly popular, and, so to speak, impersonal in matter and in origin. It would be easy to show that survivals out of this stage of inartistic lyric poetry linger in the early epic poetry of Homer and in the French *épopées*, and that the Greek drama sprang from the sacred choruses of village vintagers. In the great early epics, as in popular ballads, there is the same directness and simplicity, the same use of recurring epithets, the "green grass," the "salt sea," the "shadowy hills," the same repetition of speeches and something of the same barbaric profusion in the use of gold and silver. But these resemblances must not lead us into the mistake of supposing Homer to be a collection of ballads, or that he can be properly translated into ballad metre. The *Iliad* and the *Odyssey* are the highest form of an artistic epic, not composed by piecing together ballads, but developed by a long series of noble *œuvres*, for the benefit of the great houses which entertain them, out of the method and materials of popular song.

We have here spoken mainly of romantic ballads, which retain in the refrain a vestige of the custom of singing and dancing; of a period when "dance, song and poetry itself began with a communal consent" (Gummere, *The Beginnings of Poetry*, p. 93, 1901). The custom by which a singer in a dancing-circle chants a few words, the dancers chiming in with the refrain, is found by M. Junod among the tribes of Delagoa Bay (Junod, *Chantes et contes des Ba Ronga*, 1897). Other instances are the Australian song-dances (Siebert, in Howitt's *Native Tribes of South-East Australia*, Appendix 1904; and Dennett, *Folk-Lore of the Fiort*). We must not infer that even among the aborigines of Australia song is entirely "communal." Known men, inspired, they say, in dreams, or by the All Father, devise new forms of song with dance, which are carried all over the country; and Mr Howitt gives a few examples of individual lyric. The history of the much exaggerated opinion that a whole people, as a people, composed its own ballads is traced by Prof. Gummere in *The Beginnings of Poetry*, pp. 116-163. Some British ballads retain traces of the early dance-song, and most are so far "communal" in that, as they stand, they have been modified and interpolated by many reciters in various ages, and finally (in *The Border Minstrelsy*) by Sir Walter Scott, and by hands much weaker than his (see *The Young Tamlane*). There are cases in which the matter of a ballad has been derived by a popular singer from medieval literary romance (as in the Arthurian ballads), while the author of the romance again usually borrowed, like Homer in the *Odyssey*, from popular *Märchen* of dateless antiquity. It would be an error to suppose that most romantic folk-songs are vulgarizations of literary romance—a view to which Mr Courthope, in his *History of English Poetry*, and Mr Henderson in *The Border Minstrelsy* (1902), incline—and the opposite error would be to hold that this process of borrowing from and vulgarization of literary medieval romance never occurred. A good illustration of the true state of the case will be found in Child's introduction to the ballad of *Young Beichan*.

Gaston Paris, a great authority, holds that early popular poetry is "improvised and contemporary with its facts" (*Histoire poétique de Charlemagne*). If this dictum be applied to such ballads as "The Bonny Earl o' Murray," "Kinmont

Willie," "Jamie Telfer" and "Jock o' the Side," it must appear that the contemporary poets often knew little of the events and knew that little wrong. We gather the true facts from contemporary letters and despatches. In the ballads the facts are confused and distorted to such a degree that we must suppose them to have been composed in a later generation on the basis of erroneous oral tradition; or, as in the case of *The Queen's Marie*, to have been later defaced by the fantastic interpolations of reciters. To prove this it is only necessary to compare the historical Border ballads (especially those of 1595-1600) with Bain's *Border Papers* (1804-1806). Even down to 1750, the ballads on Rob Roy's sons are more or less mythopoeic. It seems probable that the existing form of most of our border ballads is not earlier than the generation of 1603-1633, after the union of the crowns. Even when the ballads have been taken from recitation, the reciter has sometimes been inspired by a "stall copy," or printed broadsheet.

AUTHORITIES.—The indispensable book for the student of ballads is Child's *English and Scottish Popular Ballads*, published in 1897-1898 (Boston, U.S.A.). Professor Child unfortunately died without summing up his ideas in a separate essay, and they must be sought in his introductions, which have never been analysed. He did not give much attention to such materials for the study of ancient poetry as exist copiously in anthropological treatises. In knowledge of the ballads of all European peoples he was unrivalled, and his bibliography of collections of ballads contains some four hundred titles, (Child, vol. v., pp. 455-468). The most copious ballad makers have been the Scots and English, the German, Slavic, Danish, French and Italian peoples; for the Gaelic there is but one entry, Campbell of Islay's *Lea har na Feinne* (London, 1872). The general bibliography occupies over sixty pages, and to this the reader must be referred, while Prof. Gummere's book, *The Beginnings of Poetry*, is an adequate introduction to the literature, mainly continental, of the ballad question, which has received but scanty attention in England. For the relation of ballad to epic there is no better guide than Comparetti's *La Kœuvala*, of which there is an English translation. For purely literary purposes the best collection of ballads is Scott's *Border Minstrelsy* in any complete edition. The best critical modern edition is that of Mr T. F. Henderson; his theory of ballad origins is not that which may be gathered from Professor Child's introductions. (A. L.)

BALLANCE, JOHN (1839-1893), New Zealand statesman, eldest son of Samuel Ballance, farmer, of Glenavy, Antrim, Ulster, was born on the 27th of March 1839. He was educated at a national school, and, on leaving, was apprenticed to an ironmonger at Belfast. He became a clerk in a wholesale ironmonger's house in Birmingham, and migrated to New Zealand, intending to start in business there as a small jeweller. After settling at Wanganui, however, he took an opportunity, soon offered, of founding a newspaper, the *Wanganui Herald*, of which he became editor and remained chief owner for the rest of his life. During the fighting with the Maori chief Titokowaru, in 1867, Ballance was concerned in the raising of a troop of volunteer horse, in which he received a commission. Of this he was deprived owing to the appearance in his newspaper of articles criticizing the management of the campaign. He had, however, behaved well in the field, and, in spite of his dismissal, was awarded the New Zealand war medal. He entered the colony's parliament in 1875 and, with one interval (1881-1884), sat there till his death. Ballance was a member of three ministries, that of Sir George Grey (1877-1879); that of Sir Robert Stout (1884-1887); and that of which he himself was premier (1891-1893). His alliance with Grey ended with a notorious and very painful quarrel. In the Stout government his portfolios were those of lands and native affairs; but it was at the treasury that his prudent and successful finance made the chief mark. As native minister his policy was pacific and humane, and in his last years he contrived to adjust equitably certain long-standing difficulties relating to reserved lands on the west coast of the North Island. He was resolutely opposed to the sale of crown lands for cash, and advocated with effect their disposal by perpetual lease. His system of state-aided "village settlements," by which small farms were allotted to peasants holding by lease from the crown, and money lent them to make a beginning of building and cultivation, has been on the whole successful. To Ballance, also, was due the law reducing the life-tenure of legislative councillors

to one of seven years. He was actively concerned in the advocacy of woman suffrage. But his best known achievement was the imposition, in 1801, of the progressive land-tax and progressive income-tax still levied in the colony. As premier he brought together the strong experimental and progressive party which long held office in New Zealand. In office he showed debating power, constructive skill and tact in managing men; but in 1803, at the height of his success and popularity, he died at Wellington of an intestinal disease after a severe surgical operation. Quiet and unassuming in manner, Ballanche, who was a well-read man, always seemed fonder of his books and his chess-board than of public bustle; yet his loss to New Zealand political life was great. A statue was erected to his memory in front of Parliament House, Wellington. (W. P. R.)

BALLANCHE, PIERRE SIMON (1776-1847), French philosopher of the theocratic school, was born at Lyons. Naturally delicate and highly-strung, he was profoundly stirred by the horrors of the siege of Lyons. His sensitiveness received a second blow in an unsuccessful love affair, which, however, he bore with fortitude. He devoted himself to an examination of the nature of society and his work brought him into connexion with the literary circle of Châteaubriand and Madame Récamier. His great work is the *Palingénésie*, which is divided into three parts, *L'orphée*, *La formule*, *La ville des expiations*. The first deals with the prehistoric period of the world, before the rise of religion; the second was to be an endeavour to deduce a universal law from known historical facts; the third to sketch the ultimate state of perfection to which humanity is moving. Of these the first alone was completed, but fragments of the other parts exist. Perhaps the most valuable part of the work is the general introduction. His last work, *Vision d'Hébal*, intended as part of the *Ville des expiations*, describes the city of a Scottish clan, who, gifted with second sight, gives semi-prophetic utterances as to the course of world-history. In 1841 Ballanche was elected a member of the French Academy. He died in 1847. A collected edition of his works in nine volumes was begun in 1850. Four only appeared. In 1833 a second edition in six volumes was published. As a man, Ballanche was warm-hearted and enthusiastic, but he was endowed with a too-vivid imagination and his strange thoughts are expressed in equally bizarre language. To give a connected account of his views is difficult; their full development should be studied in relation with his life-history, the stages of which are curiously parallel to his theory of the progress of man, the fall, the trial, the perfection.

As has been said, he belonged to the theocratic school, who, in opposition to the rationalism of the preceding age, emphasized the principle of authority, placing revelation above individual reason, order above freedom and progress. But Ballanche made a sincere endeavour to unite in one system what was valuable in the opposed modes of thinking. He held with the theocratists that individualism was an impracticable view; man, according to him, exists only in and through society. He agreed further with them that the origin of society was to be explained, not by human desire and efforts, but by a direct revelation from God. Lastly, with De Bonald, he reduced the problem of the origin of society to that of the origin of language, and held that language was a divine gift. But at this point he parts company with the theocratists, and in this very revelation of language finds a germ of progress. Originally, in the primitive state of man, speech and thought are identical; but gradually the two separate; language is no longer only spoken, it is also written and finally is printed. Thus the primitive unity is broken up; the original social order which co-existed with, and was dependent on it, breaks up also. New institutions spring up, upon which thought acts, and in and through which it even draws nearer to a final unity, a *palingénésie*. The volition of primitive man was one with that of God but it becomes broken up into separate volitions which oppose themselves to the divine will, and through the oppositions and trials of this world work onward to a second and complete harmony. Humanity, therefore, passes through three stages, the fall from perfection, the period of trial and the final re-birth or return to perfection. In the dim records of mythical times may be traced the obscure outlines of primitive society and of its fall. Actual history exhibits the conflict of two great principles, which may be said to be realized in the patricians and plebeians of Rome. Such a distinction of caste is regarded by Ballanche as the original state of historical society; and history, as a whole, he considers to have followed the same course as that taken by the Roman plebs in its attempts to attain equality with the patriciate. On the events through which the human race is to achieve its destiny Ballanche

gives few intelligible hints. The sudden flash which disclosed to the eyes of Hébal the whole epic of humanity cannot be reproduced in language trammelled by time and space. Scattered throughout the works of Ballanche are many valuable ideas on the connexion of events which makes possible a philosophy of history; but his own theory does not seem likely to find more favour than it has already received. Besides the *Palingénésie*, Ballanche wrote a poem on the siege at Lyons (unpublished); *Du sentiment considéré dans la littérature et dans les arts* (1801); *Antigone*, a prose poem (1814); *Essai sur les institutions sociales* (1818), intended as a prelude to his great work; *Le Vieillard et le jeune homme*, a philosophical dialogue (1819); *L'Homme sans nom*, a novel (1820).

See Ampère, *Ballanche* (Paris, 1848); Ste Beuve, *Portraits contemporains*, vol. II.; Damiron, *Philosophie de XIX^e siècle*; Eugène Blum, "Essai sur Ballanche" (in *Critique Philos.*, 30th June 1887); Gaston Frainnet, *Essai sur la philos. de P. S. Ballanche* (Paris, 1903, containing unpublished letters, portraits and full bibliography); C. Huit, *La Vie et les œuvres de Ballanche* (1904). An admirable analysis of the works composing the *Palingénésie* is given by Barchou, *Revue des deux mondes* (1831), t. 2, pp. 410-456.

BALLANTINE, WILLIAM (1812-1887), English serjeant-at-law, was born in London on the 3rd of January 1812, being the son of a London police-magistrate. He was educated at St Paul's school, and called to the bar in 1834. He began in early life a varied acquaintance with dramatic and literary society, and his experience, combined with his own pushing character and acute intellect, helped to obtain for him very soon a large practice, particularly in criminal cases. He became known as a formidable cross-examiner, his great rival being Serjeant Parry (1816-1880). The three great cases of his career were his successful prosecution of the murderer Franz Müller in 1864, his skilful defence of the Tichborne claimant in 1871 and his defence of the gaekwar of Baroda in 1875, his fee in this last case being one of the largest ever known. Ballantine became a serjeant-at-law in 1856. He died at Margate on the 9th of January 1887, having previously published more than one volume of reminiscences. Serjeant Ballantine's private life was decidedly Bohemian; and though he earned large sums, he died very poor.

BALLANTYNE, ROBERT MICHAEL (1825-1894), Scottish writer of fiction, was born at Edinburgh on the 24th of April 1825, and came of the same family as the famous printers and publishers. When sixteen years of age he went to Canada and was for six years in the service of the Hudson's Bay Company. He returned to Scotland in 1847, and next year published his first book, *Hudson's Bay: or, Life in the Wilds of North America*. For some time he was employed by Messrs Constable, the publishers, but in 1856 he gave up business for the profession of literature, and began the series of excellent stories of adventure for the young with which his name is popularly associated. *The Young Fur-Traders* (1856), *The Coral Island* (1857), *The World of Ice* (1859), *Ungava: a Tale of Eskimo Land* (1857), *The Dog Crusoe* (1860), *The Lighthouse* (1865), *Deep Down* (1868), *The Pirate City* (1874), *Erling the Bold* (1869), *The Settler and the Savage* (1877), and other books, to the number of upwards of a hundred, followed in regular succession, his rule being in every case to write as far as possible from personal knowledge of the scenes he described. His stories had the merit of being thoroughly healthy in tone and possessed considerable graphic force. Ballantyne was also no mean artist, and exhibited some of his water-colours at the Royal Scottish Academy. He lived in his later years at Harrow, and died on the 8th of February 1894, at Rome, where he had gone to attempt to shake off the results of overwork. He wrote a volume of *Personal Reminiscences of Book-making* (1893).

BALLARAT [BALLAARAT] and **BALLARAT EAST**, a city and a town of Grenville county, Victoria, Australia, 74 m. by rail W.N.W. of Melbourne. The city and Ballarat East, separated only by the Yarrowee Creek, are distinct municipalities. Pop. of Ballarat (1901) 25,448, of Ballarat East, 18,262. Ballarat is the second city and the chief gold-mining centre of the state. The alluvial gold-fields were the richest ever opened up, but as these deposits have become exhausted the quartz reefs at deep levels have been exploited, and several mines are worked at depths exceeding 2000 ft. The city is the seat of Anglican and Roman Catholic bishops. It has a number of admirable public buildings, while, among several parks and recreation grounds, mention must be made of the fine botanical garden, 750 acres in extent,

where, in Lake Wendouree, pisciculture is carried on with great success. The school of mines is the most important in Australia and is affiliated to the university of Melbourne. Ballarat is an important railway centre and its industries include woollen-milling, brewing, iron-founding, flour-milling and distilling. Owing to its elevation of 1438 ft. it has an exceptionally cool and healthy climate. Although the district is principally devoted to mining it is well adapted for sheep-farming, and some of the finest wool in the world is produced near Ballarat. The existence of the towns is due to the heavy immigration which followed upon the discovery of the gold-fields in 1851. In 1854, in their resistance of an arbitrary tax, the miners came into armed conflict with the authorities; but a commission was appointed to investigate their grievances; and a charter was granted to the town in 1855. In 1870 Ballarat was raised to the rank of a city.

BALLAST (O. Swed. *barlast*, perhaps from *bar*, bare or mere, and *last*, load), heavy material, such as gravel, stone or metal, placed in the hold of a ship in order to immerse her sufficiently to give adequate stability. In botany "ballast-plants" are so-called because they have been introduced into countries in which they are not indigenous through their seeds being carried in such ballast. A ship "in ballast" is one which carries no paying cargo. In modern vessels the place of ballast is taken by water-tanks which are filled more or less as required to trim the ship. The term is also applied to materials like gravel, broken slag, burnt clay, &c., used to form the bed in which the sleepers or ties of a railway track are laid, and also to the sand which a balloonist takes up with him, in order that, by throwing portions of it out of the car from time to time, he may lighten his balloon when he desires to rise to a higher level.

BALLATER (Gaelic for "the town on a sloping hill"), a village in the parish of Glenmuik, Aberdeenshire, Scotland, 670 ft. above the sea, on the left bank of the Dee, here crossed by a fine bridge, 432 m. by rail W. by S. of Aberdeen. It is the terminus of the Deeside railway and the station for Balmoral, 9 m. to the W. Founded in 1770 to provide accommodation for the visitors to the mineral wells of Pannanich, 1½ m. to the E., it has since become a popular summer resort. It contains the Albert Memorial Hall and the barracks for the sovereign's body-guard, used when the king is in residence at Balmoral. Red granite is the chief building material of the houses. Ballatrach farm, where Byron spent part of his boyhood, lies some 4 m. to the E. Ballater has a mean temperature of 44.6° F., and an average annual rainfall of 33.4 in.

BALLENSTEDT, a town of Germany, in the duchy of Anhalt, on the river Gletti, 20 m. E. of Quedlinburg by rail. Pop. (1900) 5423. It is pleasantly situated under the north-eastern declivity of the Harz mountains. The inhabitants are mostly engaged in agriculture and there is practically no other industry. The palace of the dukes of Anhalt, standing on an eminence, contains a library and collections of various kinds, including a good picture gallery. It is approached by a fine avenue of trees and is surrounded by a well-wooded park. In the Schlosskirche the grave of Albert the Bear, margrave of Brandenburg (1100-1170) has been discovered.

BALLET, a performance in which dancing, music and pantomime are involved. Originally derived from the (Sicilian) Gr. βαλλί(σκ)ειν, to dance, the word has passed through the Med. Lat. *ballare* (with *ballator* as synonymous with *sallator*) to the Ital. *ballare* and *ballata*, to the Fr. *baller*, to the O. Eng. word *ballette*, and to *ballad*. In O. Fr., according to Rousseau, *ballet* signifies "to dance, to sing, to rejoice"; and thus it incorporates three distinct modern words, "baller, ball and ballad." Through the gradual changes in the amusements of different ages, the meaning of the first two words has at length become limited to dancing, and the third is now confined to singing. But, although ballads are no longer the vocal accompaniments to dances round the maypole, old ballads are still sung to dance tunes. The present acceptance of the word *ballet* is—a theatrical representation in which a story is told only by gesture, accompanied by music, which should be characterized by stronger emphasis than would be employed with the voice. The dancing

should be connected with the story but is more commonly incidental. The French word was found to be so comprehensive as to require further definition, and thus the above-described would be distinguished as the *ballet d'action* or pantomime ballet, while a single scene, such as that of a village festival with its dances, would now be termed a *divertissement*.

The *ballet d'action*, to which the changed meaning of the word is to be ascribed, and therewith the introduction of modern ballet, has been generally attributed to the 15th century. Novelty of entertainment was then sought for in the splendid courts of Italy, in order to celebrate events which were thought great in their time, such as the marriages of princes, or the triumphs of their arms. Invention was on the rack for novelty, and the skill of the machinist was taxed to the utmost. It has been supposed that the art of the old Roman *pantomimi* was then revived, to add to the attractions of court-dances. Under the Roman empire the *pantomimi* had represented either a mythological story, or perhaps a scene from a Greek tragedy, by mute gestures, while a chorus, placed in the background, sang *cantica* to narrate the fable, or to describe the action of the scene. The question is whether mute pantomimic action, which is the essence of modern ballet, was carried through those court entertainments, in which kings, queens, princes and princesses, took parts with the courtiers; or whether it is of later growth, and derived from professional dances upon the stage. The former is the general opinion, but the court entertainments of Italy and France were masques or masks which included declamation and song, like those of Ben Jonson with Inigo Jones for the court of James I.

The earliest modern ballet on record was that given by Bergonzio di Botta at Tortona to celebrate the marriage of the duke of Milan in 1489. The ballet, like other forms of dancing, was developed and perfected in France; it is closely associated with the history of the opera; but in England it came much later than the opera, for it was not introduced until the 18th century, and in the first Italian operas given in London there was no ballet. During the regency of Lord Middlesex a ballet-master was appointed and a *corps* of dancers formed. The ballet has had three distinct stages in its development. For a long time it was to be found only at the court, when princely entertainments were given to celebrate great occasions. At that time ladies of the highest rank performed in the ballet and spent much time in practising and perfecting themselves for it. Catherine de' Medici introduced these entertainments into France and spent large sums of money on devising performances to distract her son's attention from the affairs of the state. Baltasarini, otherwise known as Beaujoyeux, was the composer of a famous entertainment given by Catherine in 1581 called the "Ballet Comique de la Reyne." This marks an era in the history of the opera and ballet, for we find here for the first time dance and music arranged for the display of coherent dramatic ideas. Henry IV., Louis XIII. and XIV. were all lovers of the ballet and performed various characters in them, and Richelieu used the ballet as an instrument for the expression of political purposes. Lully was the first to make an art of the composition of ballet music and he was the first to insist on the admission of women as ballet dancers, feminine characters having hitherto been assumed by men dressed as women. When Louis XIV. became too fat to dance, the ballet at court became unpopular and thus was ended the first stage of its development. It was then adopted in the colleges at prize distributions and other occasions, when the ballets of Lully and Quinault were commonly performed. The third period in the history of the ballet was marked by its appearance on the stage, where it has remained ever since. It should be added that up till the third period dramatic poems had accompanied the ballet and the dramatic meaning was helped out with speech and song; but with the advent of the third period speech disappeared and the purely pantomime performance, or *ballet d'action*, was instituted.

The father of ballet dancing as we know it at the present day was Jean Georges Noverre (q.v.). The *ballet d'action* was really invented by him; in fact, the ballet has never advanced beyond the stage to which he brought it; it has rather gone back. The

essence of Noverre's theory was that mere display was not enough to ensure interest and life for the ballet; and some years ago Sir Augustus Harris expressed a similar opinion when he was asked wherein lay the reason of the decadence of the modern ballet. Noverre brought to a high degree of perfection the art of presenting a story by means of pantomime, and he never allowed dancing which was not the direct expression of a particular attitude of mind. Apart from Noverre, the greatest ballet-master was undoubtedly Gaetano Apolline Balthazare Vestris (*q.v.*), who modestly called himself *le dieu de la danse*, and was, indeed, the finest male dancer that Europe ever produced. Gluck composed *Iphigénie en Aulide* in conjunction with Vestris. In 1750 the two greatest dancers of the day performed together in Paris in a ballet-opera called *Léandre et Héro*; the dancers were Vestris and Madame Camargo (*q.v.*), who introduced short skirts in the ballet.

The word "ballette" was first used in the English language by Dryden in 1667, and the first descriptive ballet seen in London was *The Tavern Bickers*, which was played at Drury Lane in 1702. Since then the ballet in England has been purely exotic and has merely followed on the lines of French developments. The palmy days of the ballet in England were in the first half of the 19th century, when a royal revenue was spent on the maintenance of this fashionable attraction. Some famous dancers of this period were Carlotta Grisi, Mdle Taglioni (who is said to have turned the heads of an entire generation), Fanny Elssler, Mdle Cerito, Miss P. Horton, Miss Lucile Grahn and Mdle Carolina Rosati. In later years Kate Vaughan was a remarkably graceful dancer of a new type in England, and, in Sir Augustus Harris's opinion, she did much to elevate the modern art. She was the first to make skirt-dancing popular, although that achievement will not be regarded as an unmixed benefit by every student of the art. Skirt-dancing, in itself a beautiful exhibition, is a departure from true dancing in the sense that the steps are of little importance in it; and we have seen its development extend to a mere exhibition of whirling draperies under many-coloured lime-lights. The best known of Miss Vaughan's disciples and imitators (each of whom has contributed something to the art on her own account) were Miss Sylvia Grey and Miss Letty Lind. Of the older and classical school of ballet-dancing Adeline Genée became in London the finest exponent. But ballet-dancing, affected by a tendency in modern entertainment to make less and less demands on the intelligence and intellectual appreciation of the public, and more and more demands on the eye—the sense most easily affected—has gradually developed into a spectacle, the chief interest of which is quite independent of dancing. Thousands of pounds are spent on dressing a small army of women who do little but march about the stage and group themselves in accordance with some design of colour and mass; and no more is asked of the intelligence than to believe that a ballet dressed, for example, in military uniform is a compliment to or glorification of the army. Only a few out of hundreds of members of the *corps de ballet* are really dancers and they perform against a background of colour afforded by the majority. It seems unlikely that we shall see any revival of the best period and styles of dancing until a higher standard of grace and manners becomes fashionable in society. With the constantly increasing abolition of ceremony, courtliness of manner is bound to diminish; and only in an atmosphere of ceremony, courtesy and chivalry can the dance maintain itself in perfection.

LITERATURE—One of the most complete books on the ballet is by the Jesuit, Claude François Menestrier, *Des ballets anciens et modernes*, 12mo (1682). He was the inventor of a ballet for Louis XIV. in 1658; and in his book he analyses about fifty of the early Italian and French ballets. See also Noverre, *Lettres sur la danse* (1760; new ed. 1804); Castel-Blaze, *La Danse et les ballets* (1832), and *Les Origines de l'Opéra* (1869).

BALL-FLOWER, an architectural ornament in the form of a ball inserted in the cup of a flower, which came into use in the latter part of the 13th, and was in great vogue in the early part of the 14th century. It is generally placed in rows at equal distances in the hollow of a moulding, frequently by the sides of mullions. The earliest known is said to be in the west part of

Salisbury cathedral, where it is mixed with the tooth ornament. It seems to have been used more and more frequently, till at Gloucester cathedral, in the south side, it is in profusion.

BALLIA, a town and district of British India, in the Benares division of the United Provinces. The town is situated on the left bank of the Ganges, below the confluence of the lesser Sarju. It is really an aggregation of rural villages. Pop. (1901) 15,278.

The district of Ballia, constituted in 1879, occupies an angle at the junction of the Gogra with the Ganges, being bordered by two districts of Behar. It contains an area of 1245 sq. m. Owing to the great pressure on the soil from the density of the population, to the reluctance to part with land characteristic of small proprietors, to the generally great productiveness of land and to the very light assessment of government revenue, land in Ballia, for agricultural purposes merely, has a market value higher than in almost any other district. It commonly brings in Rs. 200 per bigha, or £20 per acre, and sometimes double that figure. In 1901 the population was 987,768, showing a decrease of 5% in the decade. The principal crops are rice, barley, other food-grains, pulse, sugar-cane and opium. There are practically no manufactures, except that of sugar. Trade is carried on largely by way of the two bordering rivers.

BALLINA, a seaport and market-town of county Mayo, Ireland, in the north parliamentary division, on the left bank of the river Moy, with a station on the Killala branch of the Midland Great Western railway. Pop. of urban district (1901) 4505. Across the river, and therefore in county Sligo, is the suburb of Ardnaree, connected with Ballina by two bridges. In Ardnaree is the Roman Catholic cathedral (diocese of Killala), with an east window of Munich glass, and the ruins of an Augustinian abbey (1427) adjoining. There is a Roman Catholic diocesan college and the Protestant parish church is also in Ardnaree. A convent was erected in 1867. In trade and population Ballina is the first town in the county. The salmon-fishery and fish-curing are important branches of its trade; and it has also breweries and flour-mills and manufactures snuff and coarse linen. On the 25th of August 1798, Ballina was entered by the French under General Humbert, marching from their landing-place at Killala. In the neighbourhood there is the interesting cromlech of the four Maels, which, if actually erected over the criminals whose name it bears, is proved by the early annals of Ireland to belong to the 7th century A.D. Their story relates that these men, foster-brothers of Cellach, bishop of Kilmore-Moy, murdered him at the instigation of Guaire Aidhne, king of Connaught, but were themselves executed at Ardnaree (*Ard-na-riaghadh*, the hill of the executions) by the bishop's brother. The Moy is a notable salmon river for rod-fishing and its tributaries and the neighbouring lakes contain trout.

BALLINASLOE, a market town of county Galway, Ireland, in the east parliamentary division, 91 m. W. of Dublin, on the Midland Great Western main line. Pop. of urban district (1901) 4904. The river Suck, an affluent of the Shannon, divides it into two parts, of which the eastern was in county Roscommon until 1898. The town contains remains of a castle of Elizabethan date. Industries include brewing, flour-milling, tanning, hat-making and carriage-building. Trade is assisted by water-communication through the Grand canal to the Shannon. The town is widely celebrated for its great annual cattle-fair held in October, at which vast numbers of cattle and sheep are offered for sale. Adjoining the town is Garbally Castle, the seat of the earl of Clancarty, into the demesne of which the great fair extends from the town.

BALLISTICS (from the Gr. *βάλλω*, to throw), the science of throwing warlike missiles or projectiles. It is now divided into two parts:—*Exterior Ballistics*, in which the motion of the projectile is considered after it has received its initial impulse, when the projectile is moving freely under the influence of gravity and the resistance of the air, and it is required to determine the circumstances so as to hit a certain object, with a view to its destruction or perforation; and *Interior Ballistics*, in which the pressure of the powder-gas is analysed in the bore

of the gun, and the investigation is carried out of the requisite charge of powder to secure the initial velocity of the projectile, without straining the gun unduly. The calculation of the stress in the various parts of the gun due to the powder pressure is dealt with in the article ORDNANCE.

I. EXTERIOR BALLISTICS.

In the ancient theory due to Galileo, the resistance of the air is ignored, and, as shown in the article on MECHANICS (§ 13), the trajectory is now a *parabola*. But this theory is very far from being of practical value for most purposes of gunnery; so that a first requirement is an accurate experimental knowledge of the resistance of the air to the projectiles employed, at all velocities useful in artillery. The theoretical assumptions of Newton and Euler (*hypotheses magis mathematicae quam naturales*) of a resistance varying as some simple power of the velocity, for instance, as the square or cube of the velocity (the quadratic or cubic law), lead to results of great analytical complexity, and are useful only for provisional extrapolation at high or low velocity, pending further experiment.

The foundation of our knowledge of the resistance of the air, as employed in the construction of ballistic tables, is the series of experiments carried out between 1864 and 1880 by the Rev. F. Bashforth, B.D. (*Report on the Experiments made with the Bashforth Chronograph*, &c., 1865-1870; *Final Report*, &c., 1878-1880; *The Bashforth Chronograph*, Cambridge, 1890). According to these experiments, the resistance of the air can be represented by no simple algebraical law over a large range of velocity. Abandoning therefore all *a priori* theoretical assumption, Bashforth set to work to measure experimentally the velocity of shot and the resistance of the air by means of equidistant electric screens furnished with vertical threads or wire, and by a chronograph which measured the instants of time at which the screens were cut by a shot flying nearly horizontally. Formulae of the calculus of finite differences enable us from the chronograph records to infer the velocity and retardation of the shot, and thence the resistance of the air.

As a first result of experiment it was found that the resistance of similar shot was proportional, at the same velocity, to the surface or cross section, or square of the diameter. The resistance R can thus be divided into two factors, one of which is d^2 , where d denotes the diameter of the shot in inches, and the other factor is denoted by ρ , where ρ is the resistance in pounds at the same velocity to a similar 1-in. projectile; thus $R = d^2\rho$, and the value of ρ , for velocity ranging from 1600 to 2150 ft. per second (*f/s*) is given in the second column of the extract from the abridged ballistic table below. These values of ρ refer to a standard density of the air, of 534.22 grains per cubic foot, which is the density of dry air at sea-level in the latitude of Greenwich, at a temperature of 62° F. and a barometric height of 30 in.

But in consequence of the humidity of the climate of England it is better to suppose the air to be (on the average) two-thirds saturated with aqueous vapour, and then the standard temperature will be reduced to 60° F., so as to secure the same standard density; the density of the air being reduced perceptibly by the presence of the aqueous vapour.

It is further assumed, as the result of experiment, that the resistance is proportional to the density of the air; so that if the standard density changes from unity to any other relative density denoted by τ , then $R = \tau d^2\rho$, and τ is called the *coefficient of density*.

The factor τ becomes of importance in long range high angle fire, where the shot reaches the higher attenuated strata of the atmosphere; on the other hand, we must take τ about 800 in a calculation of shooting under water.

The resistance of the air is reduced considerably in modern projectiles by giving them a greater length and a sharper point, and by the omission of projecting studs, a factor κ , called the *coefficient of shape*, being introduced to allow for this change.

For a projectile in which the ogival head is struck with a radius of 2 diameters, Bashforth puts $\kappa = 0.975$; on the other hand, for a flat-headed projectile, as required at proof-butts, $\kappa = 1.8$, say 2 on the average.

For spherical shot κ is not constant, and a separate ballistic table must be constructed; but κ may be taken as 1.7 on the average.

Lastly, to allow for the superior centering of the shot obtainable with the breech-loading system, Bashforth introduces a factor σ , called the *coefficient of steadiness*.

This steadiness may vary during the flight of the projectile, as the shot may be unsteady for some distance after leaving the muzzle, afterwards steadying down, like a spinning-top. Again, σ may increase as the gun wears out, after firing a number of rounds.

Collecting all the coefficients, τ , κ , σ , into one, we put

$$(1) \quad R = nd^2\rho = nd^2\rho f(v), \text{ where}$$

$$(2) \quad n = \kappa\sigma\tau,$$

and n is called the *coefficient of reduction*.

By means of a well-chosen value of n , determined by a few experiments, it is possible, pending further experiment, with the most recent design, to utilize Bashforth's experimental results carried out with old-fashioned projectiles fired from muzzle-loading guns. For instance, $n = 0.8$ or even less is considered a good average for the modern rifle bullet.

Starting with the experimental values of ρ , for a standard projectile, fired under standard conditions in air of standard density, we proceed to the construction of the ballistic table. We first determine the time t in seconds required for the velocity of a shot, d inches in diameter and weighing w lb., to fall from any initial velocity $V(f/s)$ to any final velocity $v(f/s)$. The shot is supposed to move horizontally, and the curving effect of gravity is ignored.

If Δt seconds is the time during which the resistance of the air, R lb., causes the velocity of the shot to fall $\Delta v(f/s)$, so that the velocity drops from $v + \frac{1}{2}\Delta v$ to $v - \frac{1}{2}\Delta v$ in passing through the mean velocity v , then

$$(3) \quad R\Delta t = \text{loss of momentum in second-pounds,}$$

$$= w(v + \frac{1}{2}\Delta v)/g - w(v - \frac{1}{2}\Delta v)/g = w\Delta v/g$$

so that with the value of R in (1),

$$(4) \quad \Delta t = w\Delta v/nd^2\rho g.$$

We put

$$(5) \quad w/nd^2 = C,$$

and call C the ballistic coefficient (driving power) of the shot, so that

$$(6) \quad \Delta t = C\Delta t, \text{ where}$$

$$(7) \quad \Delta T = \Delta v/g\rho,$$

and ΔT is the time in seconds for the velocity to drop Δv of the standard shot for which $C = 1$, and for which the ballistic table is calculated.

Since ρ is determined experimentally and tabulated as a function of v , the velocity is taken as the argument of the ballistic table; and taking $\Delta v = 10$, the average value of ρ in the interval is used to determine ΔT .

Denoting the value of T at any velocity v by $T(v)$, then

(8) $T(v)$ = sum of all the preceding values of ΔT plus an arbitrary constant, expressed by the notation

(9) $T(v) = \Sigma(\Delta T/g\rho) + \text{constant}$, or $\int dv/g\rho + \text{constant}$, in which ρ is supposed known as a function of v .

The constant may be any arbitrary number, as in using the table the difference only is required of two tabular values for an initial velocity V and final velocity v ; and thus

$$(10) \quad T(V) - T(v) = \Sigma_v \Delta v/g\rho \text{ or } \int_v^V dv/g\rho;$$

and for a shot whose ballistic coefficient is C

$$(11) \quad t = C[T(V) - T(v)].$$

To save the trouble of proportional parts the value of $T(v)$ for unit increment of v is interpolated in a full-length extended ballistic table for T .

Next, if the shot advances a distance Δs ft. in the time Δt , during which the velocity falls from $v + \frac{1}{2}\Delta v$ to $v - \frac{1}{2}\Delta v$, we have

$$(12) \quad R\Delta s = \text{loss of kinetic energy in foot-pounds}$$

$$= w(v + \frac{1}{2}\Delta v)^2/g - w(v - \frac{1}{2}\Delta v)^2/g = wv\Delta v/g, \text{ so that}$$

$$(13) \quad \Delta s = wv\Delta v/nd^2\rho g = C\Delta s, \text{ where}$$

$$(14) \quad \Delta S = v\Delta v/g\rho = v\Delta T,$$

and ΔS is the advance in feet of a shot for which $C = 1$, while the velocity falls Δv in passing through the average velocity v .

Denoting by $S(v)$ the sum of all the values of ΔS up to any assigned velocity v ,

(15) $S(v) = \Sigma(\Delta S) + \text{constant}$, by which $S(v)$ is calculated from ΔS , and then between two assigned velocities V and v ,

$$(16) \quad S(V) - S(v) = \sum_v v\Delta T = \sum_v \frac{v\Delta v}{g\rho} \text{ or } \int_v^V \frac{v dv}{g\rho},$$

and if s feet is the advance of a shot whose ballistic coefficient is C ,

$$(17) \quad s = C[S(V) - S(v)].$$

In an extended table of S , the value is interpolated for unit increment of velocity.

A third table, due to Sir W.D. Niven, F.R.S., called the *degree* table, determines the change of direction of motion of the shot while the velocity changes from V to v , the shot flying nearly horizontally.

To explain the theory of this table, suppose the tangent at the point of the trajectory, where the velocity is v , to make an angle i radians with the horizon.

Resolving normally in the trajectory, and supposing the resistance of the air to act tangentially,

$$(18) \quad v(di/dt) = g \cos i,$$

where di denotes the infinitesimal decrement of i in the infinitesimal increment of time dt .

v.	m.	log k.	$Cr = gp = f(v) = v^n/k.$
3600			$v^{1.44} \times \log^{-1} 3.6090480$
2600	1.55	2.3909520	$v^{1.7} \times \log^{-1} 3.0961978$
1800	1.7	2.9038022	$v^2 \times \log^{-1} 4.1192596$
1370	2	3.8807404	$v^3 \times \log^{-1} 5.9809023$
1230	3	7.0190977	$v^4 \times \log^{-1} 8.8018712$
970	5	13.1981288	$v^5 \times \log^{-1} 8.7734430$
790	3	7.2265570	$v^6 \times \log^{-1} 5.6698914$

The numbers have been changed from kilogramme-metre to pound-foot units by Colonel Ingalls, and employed by him in the calculation of an extended ballistic table, which can be compared with the result of the abridged table. The calculation can be carried out in each region of velocity from the formulae:—

$$(25) \quad T(V) - T(v) = k \int_v^V v^{-n} dv, \quad S(V) - S(v) = k \int_v^V v^{n-1} dv$$

$$I(V) - I(v) = gk \int_v^V v^{-n-1} dv,$$

and the corresponding integration.

The following exercises will show the application of the ballistic table. A slide rule should be used for the arithmetical operations, as it works to the accuracy obtainable in practice.

Example 1.—Determine the time *t* sec. and distance *s* ft. in which the velocity falls from 2150 to 1600 f/s.

- (a) of a 6-in. shot weighing 100lb, taking $n = 0.96$.
- (b) of a rifle bullet, 0.303-in. calibre, weighing half an ounce, taking $n = 0.8$.

V.	v.	T(V).	T(v).	t/C.	S(V).	S(v).	s/C.
2150	1600	28.6891	27.5457	1.1434	20700.53	18587.00	2113.53

	d.	w.	C.	t/C.	t.	s/C.	s.
(a)	6	100	2.894	1.1434	3.307	2113.53	6114 (2038 yds.)
(b)	0.303	1/32	0.426	1.1434	0.486	2113.53	900 (300 yds.)

Example 2.—Determine the remaining velocity *v* and time of flight *t* over a range of 1000 yds. of the same two shot, fired with the same muzzle velocity *V* = 2150 f/s.

	S.	s/C.	S(V).	S(v).	$v \bullet$	T(V).	T(v).	t/C.	t.
(a)	3000	1037	20700.53	19663.53	1861	28.6891	28.1690	0.5201	1.505
(b)	3000	7050	20700.53	13650.53	920*	28.6891	23.0803	0.5688	2.387

In the calculation of range tables for *direct fire*, defined officially as "fire from guns with full charge at elevation not exceeding 15°," the vertical component of the resistance of the

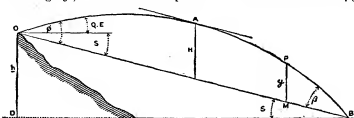

FIG. 1.

air may be ignored as insensible, and the actual velocity and its horizontal component, or component parallel to the line of sight, are undisturbable.

The equations of motion are now, the co-ordinates *x* and *y* being measured in feet,

$$(26) \quad \frac{d^2x}{dt^2} = -rv = -\frac{g\beta}{C}$$

$$(27) \quad \frac{d^2y}{dt^2} = -g.$$

* These numbers are taken from a part omitted here of the abridged ballistic table.

The first equation leads, as before, to

$$(28) \quad t = C \{T(V) - T(v)\},$$

$$(29) \quad x = C \{S(V) - S(v)\}.$$

The integration of (24) gives

$$(30) \quad \frac{dy}{dt} = \text{constant} - gt = g\{\frac{1}{2}T - t\}.$$

If *T* denotes the whole time of flight from *O* to the point *B* (fig. 1), where the trajectory cuts the line of sight; so that $\frac{1}{2}T$ is the time to the vertex *A*, where the shot is flying parallel to *OB*.

Integrating (27) again,

$$(31) \quad y = g\{\frac{1}{2}Tt - \frac{1}{2}t^2\} = \frac{1}{2}gt(T - t);$$

and denoting *T* - *t* by *t'*, and taking $g = 32\text{ft/s}^2$,

$$(32) \quad y = 16t't,$$

which is Colonel Sladen's formula, employed in plotting ordinates of a trajectory.

At the vertex *A*, where *y* = *H*, we have $t = t' = \frac{1}{2}T$, so that

$$(33) \quad H = \frac{1}{4}gT^2,$$

which for practical purposes, taking $g = 32$, is replaced by

$$(34) \quad H = 4T^2, \text{ or } (2T)^2.$$

Thus, if the time of flight of a shell is 5 sec., the height of the vertex of the trajectory is about 100 ft.; and if the fuse is set to burst the shell one-tenth of a second short of its impact at *B*, the height of the burst is 7.84, say 8 ft.

The line of sight *Ox*, considered horizontal in range table results, may be inclined slightly to the horizon, as in shooting up or down a moderate slope, without appreciable modification of (28) and (29), and *y* or *PM* is still drawn vertically to meet *OB* in *M*.

Given the ballistic coefficient *C*, the initial velocity *V*, and a range of *R* yds. or *X* = 3*R* ft., the final velocity *v* is first calculated from

$$(35) \quad S(v) = S(V) - X/C,$$

and then the time of flight *T* by

$$(36) \quad T = C \{T(V) - T(v)\}.$$

Denoting the angle of departure and descent, measured in degrees and from the line of sight *OB* by ϕ and β , the total deviation in the range *OB* is (fig. 1)

$$(37) \quad \delta = \phi + \beta = C/D \{D(V) - D(v)\}.$$

To share the δ between ϕ and β , the vertex *A* is taken as the point of *half-time* (and therefore beyond *half-range*, because of the continual diminution of the velocity), and the velocity *v* at *A* is calculated from the formula

$$(38) \quad T(v) = T(V) - \frac{1}{2} \frac{T}{C} = \frac{1}{2} \{T(V) + T(v)\};$$

and now the degree table for *D(v)* gives

$$(39) \quad \phi = C \{D(V) - D(v)\},$$

$$(40) \quad \beta = C \{D(v) - D(v)\}.$$

This value of ϕ is the tangent elevation (T.E.); the quadrant elevation (Q.E.) is $\phi - S$, where *S* is the angular depression of the line of sight *OB*; and if *O* is *h* ft. vertical above *B*, the angle *S* at a range of *R* yds. is given by

$$(41) \quad \sin S = h/3R,$$

or, for a small angle, expressed in minutes, taking the radian as 3438',

$$(42) \quad S = 114.6h/R.$$

So also the angle β must be increased by *S* to obtain the angle at which the shot strikes a horizontal plane—the water, for instance.

A systematic exercise is given here of the compilation of a range table by calculation with the ballistic table; and it is to be compared with the published official range table which follows.

A discrepancy between a calculated and tabulated result will serve to show the influence of a slight change in the coefficient of reduction *n*, and the muzzle velocity *V*.

Example 3.—Determine by calculation with the abridged ballistic table the remaining velocity *v*, the time of flight *t*, angle of elevation ϕ , and descent β of this 6-in. gun at ranges 500, 1000, 1500, 2000 yds., taking the muzzle velocity *V* = 2150 f/s, and a coefficient of reduction *n* = 0.96. [For Table see p. 274.]

An important problem is to determine the alteration of elevation for firing up and down a slope. It is found that the alteration of the tangent elevation is almost insensible, but the quadrant elevation requires the addition or subtraction of the angle of sight.

Example.—Find the alteration of elevation required at a range of 3000 yds. in the exchange of fire between a ship and a fort 1200 ft. high, a 12-in. gun being employed on each side, firing a shot weighing 850 lb. with velocity 2150 f/s. The complete ballistic table, and the method of high angle fire (see below) must be employed.

Range.	s.	s/C.	S(v).	v.	T(v).	i/C.	i.	T(v ₀).	v ₀ .	D(v ₀).	φ/C.	φ.	β/C.	β.
0	0	0	20700-53	2150	28-6891	0-0000	0-000	28-6891	2150	50-9219	0-0000	0-000	0-0000	0-000
500	1500	518	20182-53	1999	28-4399	0-2492	0-720	28-5645	2071	50-8132	0-1087	0-315	0-1135	0-328
1000	3000	1036	19664-53	1862	28-1711	0-5180	1-497	28-4301	1994	50-6913	0-2306	0-666	0-2486	0-718
1500	4500	1554	19146-53	1732	27-8815	0-8076	2-330	28-2853	1918	50-5542	0-3677	1-062	0-4085	1-181
2000	6000	2072	18628-53	1610	27-5728	1-1163	3-225	28-1310	1843	50-4029	0-5190	1-500	0-5989	1-734

RANGE TABLE FOR 6-INCH GUN.

Charge	weight, 13 lb. 4 oz. gravi-metric density, nature, cordite, size 30.	55-01 0-504	Projectile	Palliser shot, Shrapnel shell. Weight, 100 lb.	Muzzle velocity, 2154 f/s.
					Nature of mounting, pedestal. Jump, nil.

Remaining Velocity.	To strike an object to ft. high range must be known to	Slope of Descent.	5' elevation or depression alters point of impact.		Elevation.	Range.	Fuse scale for T. and P. middle No. 54 Marks I., II., or III.	50% of rounds should fall in.			Time of Flight.	Penetration into Wrought Iron.
			Range.	Laterally or Vertically.				Length.	Breadth.	Height.		
f/s.	yds.	1 in.	yds.	yds.	°	yds.		yds.	yds.	yds.	secs.	in.
2154	0-00	0 0	0	0-00	13-6
2122	1145	687	125	0-14	0 4	100	0-4	..	0-16	13-4
2091	635	381	125	0-29	0 9	200	0-4	..	0-31	13-2
2061	408	245	125	0-43	0 13	300	1	..	0-4	..	0-47	13-0
2032	316	190	125	0-58	0 17	400	1 1/2	..	0-4	..	0-62	12-8
2003	260	156	125	0-72	0 21	500	2	..	0-5	..	0-78	12-6
1974	211	127	125	0-87	0 26	600	2 1/2	..	0-5	0-2	0-95	12-4
1946	183	110	125	1-01	0 30	700	3	..	0-5	0-2	1-11	12-2
1909	163	98	125	1-16	0 34	800	3 1/2	..	0-5	0-2	1-28	12-0
1883	143	85	125	1-31	0 39	900	4	..	0-6	0-3	1-44	11-8
1857	130	78	125	1-45	0 43	1000	4 1/2	..	0-6	0-3	1-61	11-6
1830	118	71	125	1-60	0 47	1100	5	..	0-6	0-3	1-78	11-4
1803	110	66	125	1-74	0 51	1200	5 1/2	..	0-6	0-3	1-95	11-2
1776	101	61	125	1-89	0 55	1300	6	..	0-7	0-4	2-12	11-0
1749	93	56	125	2-03	0 59	1400	6 1/2	..	0-7	0-4	2-30	10-8
1722	86	52	125	2-18	1 3	1500	7	..	0-7	0-4	2-47	10-6
1695	80	48	125	2-32	1 7	1600	7 1/2	25	0-8	0-5	2-65	10-5
1669	71	43	125	2-47	1 11	1700	8	25	0-9	0-5	2-84	10-3
1642	67	40	100	2-61	1 16	1800	8 1/2	25	1-0	0-5	3-03	10-1
1616	61	37	100	2-76	1 22	1900	9	25	1-1	0-6	3-23	9-9
1591	57	34	100	2-91	1 27	2000	9 1/2	25	1-2	0-6	3-41	9-7

The last column in the Range Table giving the inches of penetration into wrought iron is calculated from the remaining velocity by an empirical formula, as explained in the article ARMOUR PLATES.

High Angle and Curved Fire.—"High angle fire," as defined officially, "is fire at elevations greater than 15°," and "curved fire is fire from howitzers at all angles of elevation not exceeding 15°." In these cases the curvature of the trajectory becomes considerable, and the formulæ employed in direct fire must be modified; the method generally employed is due to Colonel Sacci of the Italian artillery.

Starting with the exact equations of motion in a resisting medium,

$$(43) \quad \frac{d^2x}{dt^2} = -r \cos i = -r \frac{dx}{ds},$$

$$(44) \quad \frac{d^2y}{dt^2} = -r \sin i - g = -r \frac{dy}{ds} - g,$$

and eliminating r ,

$$(45) \quad \frac{dx}{dt} \frac{d^2y}{dt^2} - \frac{dy}{dt} \frac{d^2x}{dt^2} = -g \frac{dx}{dt},$$

and this, in conjunction with

$$(46) \quad \tan i = \frac{dy}{dx} = \frac{dy}{dt} \frac{dt}{dx},$$

$$(47) \quad \sec^2 i \frac{di}{dt} = \left(\frac{dx}{dt} \frac{d^2y}{dt^2} - \frac{dy}{dt} \frac{d^2x}{dt^2} \right) \left(\frac{dx}{dt} \right)^{-2},$$

reduces to

$$(48) \quad \frac{di}{dt} = \frac{g}{v} \cos i, \text{ or } \frac{di}{dt} \tan i = -\frac{g}{v \cos i},$$

the equation obtained, as in (18), by resolving normally in the trajectory, but di now denoting the increment of i in the increment of time dt .

Denoting dx/dt , the horizontal component of the velocity, by g , so that

$$(49) \quad v \cos i = g,$$

equation (43) becomes

$$(50) \quad dq/dt = -r \cos i,$$

and therefore by (48)

$$(51) \quad \frac{dq}{dt} = \frac{dq}{dt} \frac{dt}{dv} = \frac{rv}{g}.$$

It is convenient to express r as a function of v in the previous

$$(52) \quad Cr = f(v).$$

and now

$$(53) \quad \frac{dq}{dv} = \frac{v f(v)}{Cg},$$

an equation connecting q and v .

Now, since $v = g \sec i$

$$(54) \quad \frac{dq}{dq} = -C \frac{\sec i}{f(q \sec i)},$$

and multiplying by dx/dt or g ,

$$(55) \quad \frac{dx}{dq} = -\frac{C g \sec i}{f(q \sec i)},$$

and multiplying by dy/dx or $\tan i$,

$$(56) \quad \frac{dy}{dq} = -\frac{C g \sec i \tan i}{f(q \sec i)};$$

also

$$(57) \quad \frac{di}{dq} = \frac{Cg}{q \sec i \cdot f(q \sec i)},$$

$$(58) \quad \frac{d \tan i}{dq} = \frac{Cg \sec i}{q \cdot f(q \sec i)},$$

from which the values of i , x , y , t , and $\tan i$ are given by integration with respect to q , when $\sec i$ is given as a function of q by means of (51).

Now these integrations are quite intractable, even for a very simple mathematical assumption of the function $f(v)$, say the quadratic or cubic law, $f(v) = v^2/k$ or v^3/k .

But, as originally pointed out by Euler, the difficulty can be turned if we notice that in the ordinary trajectory of practice the quantities i , $\cos i$, and $\sec i$ vary so slowly that they may be replaced by their mean values, η , $\cos \eta$, and $\sec \eta$, especially if the trajectory, when considerable, is divided up in the calculation into arcs of small curvature, the curvature of an arc being defined as the angle between the tangents or normals at the ends of the arc.

Replacing then the angle i on the right-hand side of equations (54)–(56) by some mean value η , we introduce Sacci's pseudo-velocity u defined by

$$(59) \quad u = g \sec \eta,$$

so that u is a quasi-component parallel to the mean direction of the tangent, say the direction of the chord of the arc.

Integrating from any initial pseudo-velocity U ,

$$(60) \quad t = C \int_U^v \frac{du}{f(u)}$$

$$(61) \quad x = C \cos \eta \int_U^v \frac{u du}{f(u)}$$

$$(62) \quad y = C \sin \eta \int_U^v \frac{u du}{f(u)}$$

and supposing the inclination i to change from ϕ to θ radians over the arc.

$$(63) \quad \phi - \theta = C g \cos \eta \int_U^v \frac{du}{u f(u)}$$

$$(64) \quad \tan \phi - \tan \theta = C g \sec \eta \int_U^v \frac{du}{u f(u)}$$

But according to the definition of the functions T , S , I and D of the ballistic table, employed for direct fire, with u written for v ,

$$(65) \quad \int_U^v \frac{v du}{u f(u)} = \int_U^v \frac{du}{kP} = T(U) - T(u),$$

$$(66) \quad \int_U^v \frac{u du}{f(u)} = S(U) - S(u),$$

$$(67) \quad \int_U^v \frac{g du}{u f(u)} = I(U) - I(u);$$

and therefore

$$(68) \quad t = C [T(U) - T(u)],$$

$$(69) \quad x = C \cos \eta [S(U) - S(u)],$$

$$(70) \quad y = C \sin \eta [S(U) - S(u)],$$

$$(71) \quad \phi - \theta = C \cos \eta [I(U) - I(u)],$$

$$(72) \quad \tan \phi - \tan \theta = C \sec \eta [I(U) - I(u)],$$

while, expressed in degrees,

$$(73) \quad \phi^\circ - \theta^\circ = C \cos \eta [D(U) - D(u)].$$

The equations (66)-(71) are Sacci's, slightly modified by General Mayevski and now in the numerical applications to high angle fire we can still employ the ballistic table for direct fire.

It will be noticed that η cannot be exactly the same mean angle in all these equations; but if η is the same in (69) and (70),

$$(74) \quad y/x = \tan \eta,$$

so that η is the inclination of the chord of the arc of the trajectory, as in Niven's method of calculating trajectories (*Proc. R. S.*, 1877); but this method requires η to be known with accuracy, as 1% variation in η causes more than 1% variation in $\tan \eta$.

The difficulty is avoided by the use of Sacci's altitude-function A or $A(u)$, by which y/x can be calculated without introducing $\sin \eta$ or $\tan \eta$, but in which y/x occurs only in the form $\cos \eta$ or $\sec \eta$, which varies very slowly for moderate values of η , so that η need not be calculated with any great regard for accuracy, the arithmetic mean $\frac{1}{2}(\phi + \theta)$ of ϕ and θ being near enough for η over any arc $\phi - \theta$ of moderate extent.

Now taking equation (72), and replacing $\tan \theta$, as a variable final tangent of an angle, by $\tan i$ or dy/dx ,

$$(75) \quad \tan \phi - \frac{dy}{dx} = C \sec \eta [I(U) - I(u)],$$

and integrating with respect to x over the arc considered,

$$(76) \quad x \tan \phi - y = C \sec \eta [x I(U) - \int_0^x I(u) dx].$$

But

$$(77) \quad \int_0^x I(u) dx = \int_U^v I(u) \frac{dx}{du} du \\ = C \cos \eta \int_U^v I(u) \frac{u du}{f(u)} \\ = C \cos \eta [A(U) - A(u)]$$

in Sacci's notation; so that the altitude-function A must be calculated by summation from the finite difference ΔA , where

$$(78) \quad \Delta A = I(u) \frac{\Delta u}{u \beta} = I(u) \Delta S,$$

or else by an integration when it is legitimate to assume that $f(u) = v^2/k$ in an interval of velocity in which m may be supposed constant.

Dividing again by x , as given in (76),

$$(79) \quad \tan \phi - \frac{y}{x} = C \sec \eta \left[I(U) - \frac{A(U) - A(u)}{S(U) - S(u)} \right]$$

from which y/x can be calculated, and thence η .

In the application of Sacci's method to the calculation of a trajectory in high angle fire by successive arcs of small curvature, starting at the beginning of an arc at an angle ϕ with velocity v , the curvature of the arc $\phi - \theta$ is first settled upon, and now

$$(80) \quad \eta = \frac{1}{2}(\phi + \theta)$$

is a good first approximation for η .

Now calculate the pseudo-velocity u_ϕ from

$$(81) \quad u_\phi = v_\phi \cos \phi \sec \eta,$$

and then, from the given values of ϕ and θ , calculate u_θ from either of the formulæ of (72) or (73):—

$$(82) \quad I(u_\theta) - I(u_\phi) = \frac{\tan \phi - \tan \theta}{C \sec \eta},$$

$$(83) \quad D(u_\theta) - D(u_\phi) = \frac{\phi^\circ - \theta^\circ}{C \cos \eta}.$$

Then with the suffix notation to denote the beginning and end of the arc $\phi - \theta$,

$$(84) \quad \phi_\theta = C [T(u_\theta) - T(u_\phi)],$$

$$(85) \quad \phi_\theta \eta = C \cos \eta [S(u_\theta) - S(u_\phi)],$$

$$(86) \quad \phi \left(\frac{y}{x} \right)_\theta = \tan \phi - C \sec \eta \left[I(u_\theta) - \frac{\Delta A}{\Delta S} \right].$$

Now denoting any finite tabular difference of the function between the initial and final (pseudo-) velocity.

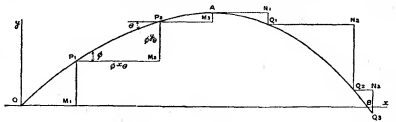

FIG. 2.

Also the velocity v_θ at the end of the arc is given by

$$(87) \quad v_\theta = u_\theta \cos \theta \sec \eta.$$

Treating this final velocity v_θ and angle θ as the initial velocity v_ϕ and angle ϕ of the next arc, the calculation proceeds as before (fig. 2).

In the long range high angle fire the shot ascends to such a height that the correction for the tenuity of the air becomes important, and the curvature $\phi - \theta$ of an arc should be so chosen that ϕ_{y_0} , the height ascended, should be limited to about 1000 ft., equivalent to a fall of 1 inch in the barometer or 3% diminution in the tenuity factor τ .

A convenient rule has been given by Captain James M. Ingalls, U.S.A., for approximating to a high angle trajectory in a single arc, which assumes that the mean density of the air may be taken as the density at two-thirds of the estimated height of the vertex; the rule is founded on the fact that in an unresisted parabolic trajectory the average height of the shot is two-thirds the height of the vertex, as illustrated in a jet of water, or in a stream of bullets from a Maxim gun.

The longest recorded range is that given in 1888 by the 9.2-in. gun to a shot weighing 380 lb fired with velocity 2375 f/s at elevation 40°; the range was about 12 m., with a time for flight of about 64 sec., shown in fig. 2.

A calculation of this trajectory is given by Lieutenant A. H. Wolley-Dod, R.A., in the *Proceedings R.A. Institution*, 1888, employing Sacci's method and about twenty arcs; and Captain Ingalls, by assuming a mean tenuity-factor $\tau = 0.68$, corresponding to a height of about 2 m., on the estimate that the shot would reach a height of 3 m., was able to obtain a very accurate result, working in two arcs over the whole trajectory, up to the vertex and down again (Ingalls, *Handbook of Ballistic Problems*).

Sacci's altitude-function is useful in direct fire, for giving immediately the angle of elevation ϕ required for a given range of R yds. or X ft., between limits V and v of the velocity, and also the angle of descent β .

In direct fire the pseudo-velocities U and u , and the real velocities V and v , are undistinguishable, and $\sec \eta$ may be replaced by unity so that, putting $y = 0$ in (79),

$$(88) \quad \tan \phi = C \left[I(V) - \frac{\Delta A}{\Delta S} \right].$$

Also

$$(89) \quad \tan \phi - \tan \beta = C [I(V) - L(v)]$$

so that

$$(90) \quad \tan \beta = C \left[\frac{\Delta A}{\Delta S} - I(v) \right],$$

or, as (88) and (90) may be written for small angles,

$$(91) \quad \sin 2\phi = 2C \left[I(V) - \frac{\Delta A}{\Delta S} \right],$$

$$(92) \quad \sin 2\beta = 2C \left[\frac{\Delta A}{\Delta S} - I(v) \right].$$

To simplify the work, so as to look out the value of $\sin 2\phi$ without the intermediate calculation of the remaining velocity v , a double-entry table has been devised by Captain Braccialini Scipione

(*Problemi del Tiro*, Roma, 1883), and adapted to yd., ft., in. and lb units by A. G. Hadcock, late R.A., and published in the *Proc. R.A. Institution*, 1898, and in *Gunnery Tables*, 1898.

In this table
(93) $\sin 2\phi = Ca$,
where a is a function tabulated for the two arguments, V the initial velocity, and R/C the reduced range in yards.

The table is too long for insertion here. The results for ϕ and β , as calculated for the range tables above, are also given there for comparison.

Drift.—An elongated shot fired from a rifled gun does not move in a vertical plane, but as if the mean plane of the trajectory were inclined to the true vertical at a small angle, 2° or 3° ; so that the shot will hit the mark aimed at if the back sight is tilted to the vertical at this angle δ , called the permanent angle of deflection (see SIGHTS).

This effect is called *drift* and the reason of it is not yet understood very clearly.

It is evidently a gyroscopic effect, being reversed in direction by a change from a right to a left-handed twist of rifling, and being increased by an increase of rotation of the shot.

The axis of an elongated shot would move parallel to itself only if fired in a vacuum; but in air the couple due to a sidelong motion tends to place the axis at right angles to the tangent of the trajectory, and acting on a rotating body causes the axis to precess about the tangent. At the same time the frictional drag damps the nutation and causes the axis of the shot to follow the tangent of the trajectory very closely, the point of the shot being seen to be slightly above and to the right of the tangent, with a right-handed twist. The effect is as if there was a mean sidelong thrust $w \tan \delta$ on the shot from left to right in order to deflect the plane of the trajectory at angle δ to the vertical. But no formula has yet been invented, derived on theoretical principles from the physical data, which will assign by calculation a definite magnitude to δ .

An effect similar to drift is observable at tennis, golf, base-ball and cricket; but this effect is explainable by the inequality of pressure due to a vortex of air carried along by the rotating

ball, and the deviation is in the opposite direction of the drift observed in artillery practice, so artillerymen are still awaiting theory and crucial experiment.

After all care has been taken in laying and pointing, in accordance with the rules of theory and practice, absolute certainty of hitting the same spot every time is unattainable, as causes of error exist which cannot be eliminated, such as variations in the air and in the muzzle-velocity, and also in the steadiness of the shot to flight.

To obtain an estimate of the accuracy of a gun, as much actual practice as is available must be utilized for the calculation in accordance with the laws of probability of the 50% zones shown in the range table (see PROBABILITY.)

II. INTERIOR BALLISTICS

The investigation of the relations connecting the pressure, volume and temperature of the powder-gas inside the bore of the gun, of the work realized by the expansion of the powder, of the

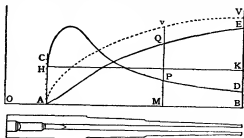

FIG. 3.

dynamics of the movement of the shot up the bore, and of the stress set up in the material of the gun, constitutes the branch of interior ballistics.

A gun may be considered a simple thermo-dynamic machine or heat-engine which does its work in a single stroke, and does not act in a series of periodic cycles as an ordinary steam or gas-engine.

An indicator diagram can be drawn for a gun (fig. 3) as for a

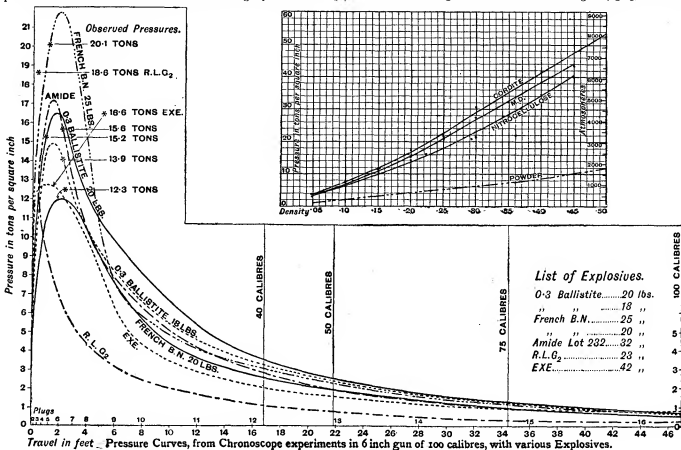

FIG. 4.

steam-engine, representing graphically by a curve CPD the relation between the volume and pressure of the powder-gas; and in addition the curves AQE of energy e , Δv of velocity v , and ΔT of time t can be plotted or derived, the velocity and energy at the muzzle B being denoted by V and E .

After a certain discount for friction and the recoil of the gun, the net work realized by the powder-gas as the shot advances AM is represented by the area ACPM, and this is equated to the kinetic energy e of the shot, in foot-tons,

$$(1) \quad e = \frac{w}{2240} \left(1 + \frac{4k^2}{d^2} \tan^2 \theta \right) \frac{v^2}{2g}$$

in which the factor $4(k^2/d^2)\tan^2\theta$ represents the fraction due to the rotation of the shot, of diameter d and axial radius of gyration k , and θ represents the angle of the rifling; this factor may be ignored in the subsequent calculations as small, less than 1%.

The mean effective pressure (M.E.P.) in tons per sq. in. is represented in fig. 3 by the height AH, such that the rectangle AHKB is equal to the area APDB; and the M.E.P. multiplied by $\frac{1}{4}\pi d^2$, the cross-section of the bore in square inches, gives in tons the mean effective thrust of the powder on the base of the shot; and multiplied again by l , the length in inches of the travel AB of the shot up the bore, gives the work realized in inch-tons; which work is thus equal to the M.E.P. multiplied by $\frac{1}{4}\pi d^2 l = B-C$, the volume in cubic inches of the rifled part AB of the bore, the difference between B the total volume of the bore and C the volume of the powder-chamber.

Equating the muzzle-energy and the work in foot-tons

$$(2) \quad E = \frac{w}{2240} \frac{V^2}{2g} = \frac{B-C}{12} \times \text{M.E.P.}$$

$$(3) \quad \text{M.E.P.} = \frac{w}{2240} \frac{V^2}{2g} \frac{12}{B-C}$$

Working this out for the 6-in. gun of the range table, taking $L=216$ in., we find $B-C=6100$ cub. in., and the M.E.P. is about 6.4 tons per sq. in.

But the maximum pressure may exceed the mean in the ratio of 2 or 3 to 1, as shown in fig. 4, representing graphically the result of Sir Andrew Noble's experiments with a 6-in. gun, capable of being lengthened to 100 calibres or 50 ft. (*Proc. R.S.*, June 1894).

On the assumption of uniform pressure up the bore, practically realizable in a Zalinski pneumatic dynamite gun, the pressure-curve would be the straight line HK of fig. 3 parallel to AM; the energy-curve AQE would be another straight line through A; the velocity-curve Δv , of which the ordinate v is as the square root of the energy, would be a parabola; and the acceleration of the shot being constant, the time-curve ΔT will also be a similar parabola.

If the pressure falls off uniformly, so that the pressure-curve is a straight line PDF sloping downwards and cutting AM in F, then the energy-curve will be a parabola curving downwards, and the velocity-curve can be represented by an ellipse, or circle with centre F and radius FA; while the time-curve will be a sinusoid.

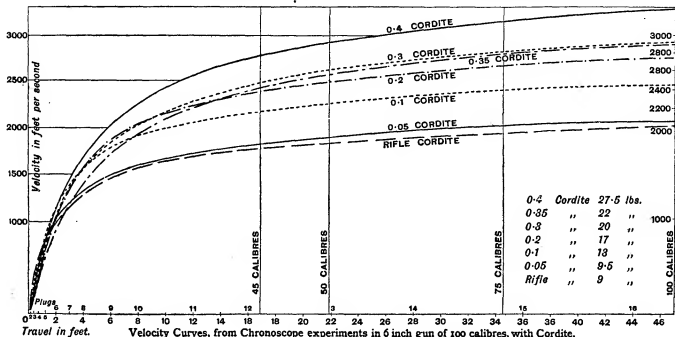

FIG. 5.

But if the pressure-curve is a straight line F'CP sloping upwards, cutting AM behind A in F', the energy-curve will be a parabola curving upwards, and the velocity-curve a hyperbola with center at F'.

These theorems may prove useful in preliminary calculations where the pressure-curve is nearly straight; but, in the absence of any observable law, the area of the pressure-curve must be read off by a planimeter, or calculated by Simpson's rule, as an indicator diagram.

To measure the pressure experimentally in the bore of a gun, the crusher-gauge is used as shown in fig. 6, nearly full size; it records the maximum pressure by the compression of a copper cylinder in its interior; it may be placed in the powder-chamber, or fastened in the base of the shot.

In Sir Andrew Noble's researches a number of plugs were inserted in the side of the experimental gun, reaching to the bore and carrying crusher-gauges, and also chronographic appliances which registered the passage of the shot in the same manner as the electric screens in Bashforth's experiments; thence the velocity and energy of the shot was inferred, to serve as an independent control of the crusher-gauge records (figs. 4 and 5).

As a preliminary step to the determination of the pressure in the bore of a gun, it is desirable to measure the pressure obtained by exploding a charge of powder in a closed vessel, varying the weight of the charge and thereby the density of the powder-gas.

The earliest experiments of this nature are due to Benjamin Robins in 1743 and Count Rumford in 1792; and their method has been revived by Dr Kellner, War Department chemist, who

employed the steel spheres of bicycle ball-bearings as safety-valves, loaded to register the pressure at which the powder-gas will blow off, and thereby check the indications of the crusher-gauge (*Proc. R.S.*, March 1895).

Chevalier d'Arcy, 1760, also experimented on the pressure of powder and the velocity of the bullet in a musket barrel; this he accomplished by shortening the barrel successively, and measuring the velocity obtained by the ballistic pendulum; thus reversing Noble's procedure of gradually lengthening the gun.

But the most modern results employed with gunpowder are based on the experiments of Noble and Abel (*Phil. Trans.*, 1875-1880-1892-1894 and following years).

A charge of powder, or other explosive, of varying weight P lb, is fired in an explosion chamber (fig. 7, scale about $\frac{1}{2}$) of which the volume C , cub. in., is known accurately, and the pressure p , tons per sq. in., was recorded by a crusher-gauge (fig. 6).

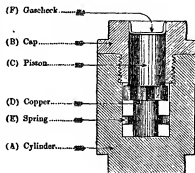

FIG. 6.

The result is plotted in figs. 8 and 9, in a curve showing the relation between ρ and D the *gravimetric density*, which is the specific gravity of the P lb of powder when filling the volume C , cub. in., in

EXPLOSION VESSEL

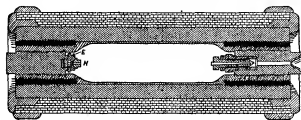

FIG. 7.

a state of gas; or between ρ and v , the reciprocal of D , which may be called the *gravimetric volume* ($G. V.$), being the ratio of the volume of the gas to the volume of an equal weight of water.

The results are also embodied in the following Table:—

TABLE I.

G.D.	G.V.	Pressure in Tons per sq. in.	
		Pebble Powder.	Cordite.
0.05	20.00	0.855	3.00
0	16.66	1.00	3.80
8	12.50	1.36	5.40
0.10	10.00	1.76	7.10
12	8.33	2.06	8.70
14	7.14	2.53	10.50
15	6.66	2.73	11.36
16	6.25	2.96	12.30
18	5.55	3.33	14.20
20	5.00	3.77	16.00
22	4.54	4.26	17.90
24	4.17	4.66	19.80
25	4.00	4.88	20.63
26	3.84	5.10	21.75
30	3.33	6.07	26.00
35	2.85	7.35	31.00
40	2.50	8.73	36.53
45	2.22	10.23	42.20
50	2.00	11.25	48.66
55	1.81	13.62	55.86
60	1.66	15.55	63.33

The term *gravimetric density* ($G.D.$) is peculiar to artillerymen; it is required to distinguish between the specific gravity ($S.G.$) of the powder filling a given volume in a state of gas, and the specific gravity of the separate solid grain or cord of powder.

Thus, for instance, a lump of solid lead of given $S.G.$, when formed into a charge of lead shot composed of equal spherules closely packed, will have a $G.D.$ such that

$$(4) \quad \frac{G.D. \text{ of charge of lead shot}}{S.G. \text{ of lump of solid lead}} = \frac{1}{8^2} \sqrt{2} = 0.7403;$$

while in the case of a bundle of cylindrical sticks of cordite,

$$(5) \quad \frac{G.D. \text{ of charge of cordite}}{S.G. \text{ of stick of cordite}} = \frac{1}{6^2} \sqrt{3} = 0.9067.$$

At the standard temperature of $62^\circ F.$ the volume of the gallon of 10 lb of water is 277.3 cub. in.; or otherwise, 1 cub. ft. or 1728 cub.

PRESSURES OBSERVED IN A CLOSED VESSEL WITH VARIOUS EXPLOSIVES

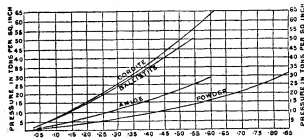

FIG. 8.

in. of water at this temperature weighs 62.35 lb, and therefore 1 lb of water bulks 1728 ÷ 62.35 = 27.73 cub. in.

Thus if a charge of P lb of powder is placed in a chamber of volume C cub. in., the

$$(6) \quad G.D. = 27.73P/C, \quad G.V. = C/27.73P.$$

Sometimes the factor 27.73 is employed, corresponding to a density of water of about 62.4 lb per cub. ft., and a temperature $12^\circ C.$, or $54^\circ F.$

With metric units, measuring P in kg., and C in litres, the $G.D. = P/C$, $G.V. = C/P$, no factor being required.

From the Table I., or by quadrature of the curve in fig. 9, the work E in foot-tons realized by the expansion of 1 lb of the powder from one gravimetric volume to another is inferred; for if the average pressure is ρ tons per sq. in., while the gravimetric volume changes from $v - \frac{1}{2}\Delta v$ to $v + \frac{1}{2}\Delta v$, a change of volume of $27.73 \Delta v$ cub. in., the work done is $27.73 \rho \Delta v$ inch-tons, or

$$(7) \quad \Delta E = 2.31 \rho \Delta v \text{ foot-tons};$$

and the differences ΔE being calculated from the observed values of ρ , a summation, as in the ballistic tables, would give E in a tabular form, and conversely from a table of E in terms of v , we can infer the value of ρ .

On drawing off a little of the gas from the explosion vessel it was found that a gramme of cordite-gas at $0^\circ C.$ and standard atmospheric pressure occupied 700 ccs., while the same gas compressed into 5 ccs. at the temperature of explosion had a pressure of 16 tons per sq. in., or $16 \times 2240 \div 14.7 = 2440$ atmospheres, of 14.7 lb per sq. in.; one ton per sq. in. being in round numbers 150 atmospheres.

The absolute centigrade temperature T is thence inferred from the gas equation

$$(8) \quad R = p v / T = p_0 v_0 / 273,$$

which, with $p = 2440$, $v = 5$, $p_0 = 1$, $v_0 = 700$, makes $T = 4758$, a temperature of $4485^\circ C.$ or $8105^\circ F.$

PRESSURE IN A CLOSED VESSEL OBSERVED AND CALCULATED

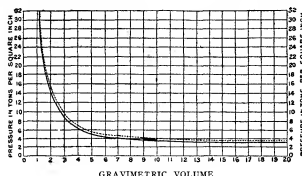

FIG. 9.

In the heading of the 6-in. range table we find the description of the charge.

Charge: weight 13 lb 4 oz.; gravimetric density 55.01/0.504; nature, cordite, size 30.

So that $P = 13.25$, the $G.D. = 0.504$, the upper figure 55.01 denoting the specific volume of the charge measured in cubic inches per lb, filling the chamber in a state of gas, the product of the two numbers 55.01 and 0.504 being 27.73; and the chamber capacity $C = 13.25 \times 55.01 = 730$ cub. in., equivalent to 25.8 in. or 2.15 ft. length of bore, now called the equivalent length of the chamber ($E.L.C.$).

If the shot was not free to move, the closed chamber pressure due to the explosion of the charge at this $G.D.$ ($= 0.5$) would be nearly 49 tons per sq. in., much too great to be safe.

But the shot advances during the combustion of the cordite, and the chief problem in interior ballistics is to adjust the $G.D.$ of the charge to the weight of the shot so that the advance of the shot during the combustion of the charge should prevent the maximum pressure from exceeding a safe limit, as shown by the maximum pressure of the pressure curve CPD in fig. 3.

Suppose this limit is fixed at 16 tons per sq. in., corresponding in Table I. to a $G.D.$ of 0.2; the powder-gas will now occupy a volume $\rho = 8C = 1825$ cub. in., corresponding to an advance of the shot $\rho \times 2 = 15 = 3.225$ ft.

Assuming an average pressure of 8 tons per sq. in., the shot will have acquired energy $8 \times \frac{1}{2} \rho^2 \times 3.225 = 730$ foot-tons, and a velocity about $v = 1020$ ft/s, so that the time over the 3.225 ft. at an average velocity $\frac{1}{2} 1015$ ft/s is about 0.0063 sec.

Comparing this time with the experimental value of the time occupied by the cordite in burning, a start is made for a fresh estimate and a closer approximation.

Assuming, however, that the agreement is close enough for practical requirement, the combustion of the cordite may be considered complete at this stage P , and in the subsequent expansion it is assumed that the gas obeys an adiabatic law in which the pressure varies inversely as some m^{th} power of the volume.

The work done in expanding to infinity from ρ tons per sq. in.

at volume b cub. in. is then $\frac{pb}{m-1}$ inch-tons, or to any volume B cub. in. is

$$(9) \quad \frac{pb}{m-1} \left[1 - \left(\frac{b}{B} \right)^{m-1} \right].$$

It is found experimentally that $m=1.2$ is a good average value to take for cordite; so now supposing the combustion of the charge of the 6-in. is complete in 0.063 sec., when $p=16$ tons per sq. in., $b=1825$ cub. in., and that the gas expands adiabatically up to the muzzle, where

$$(10) \quad \frac{B}{b} = \frac{216+25.8}{2.5 \times 25.8} = 3.75,$$

we find the work realized by expansion is 2826 foot-tons, sufficient to increase the velocity from 1020 to 2250 f/s at the muzzle.

This muzzle velocity is about 5 to 25% greater than the 1500 f/s of the range table, so on these considerations we may suppose about 10% of work is lost by friction in the bore; this is expressed by saying that the factor of effect is $f=0.9$.

The experimental determination of the time of burning under the influence of the varying pressure and density, and the size of the grain, is thus of great practical importance, as thereby it is possible to estimate close limits to the maximum pressure that will be reached in the bore of a gun, and to design the chamber so that the G.D. of the charge may be suitable for the weight and acceleration of the shot. Empirical formulas based on practical experience are employed for an approximation to the result.

A great change has come over interior ballistics in recent years, as the old black gunpowder has been abandoned in artillery after holding the field for six hundred years. It is replaced by modern explosives such as those indicated on fig. 4, capable of giving off a very much larger volume of gas at a greater temperature and pressure, more than threefold as seen on fig. 8, so that the charge may be reduced in proportion, and possessing the military advantage of being nearly smokeless. (See EXPLOSIVES.)

The explosive cordite is adopted in the British service; it derives the name from its appearance as cord in short lengths, the composition being squeezed in a viscous state through the hole in a die, and the cordite is designated in size by the number of hundredths of an inch in the diameter of the hole. Thus the cordite, size 30, of the range table has been squeezed through a hole 0.30 in. diameter.

The thermochemical properties of the constituents of an explosive will assign an upper limit to the volume, temperature and pressure of the gas produced by the combustion; but much experiment is required in addition. Sir Andrew Noble has published some of his results in the *Phil. Trans.*, 1905-1906 and following years.

AUTHORITIES.—Tartaglia, *Nova Scientia* (1537); Galileo (1638); Robins, *New Principles of Gunnery* (1743); Euler (trans. by Hugh Brown), *The True Principles of Gunnery* (1777); Didion, Hélie, Hugoniot, Vallier, Baillis, &c., *Balistique* (French); Siacci, *Balistica* (Italian); Mavevski, Zabudski, *Balistique* (Russian); La Llave, Oller, Mata, &c., *Balistica* (Spanish); Bashforth, *The Motion of Projectiles* (1872); *The Bashforth Chronograph* (1890); Ingalls, *Exterior and Interior Ballistics, Handbook of Problems in Direct and Indirect Fire*; Bruif, *Ordnance and Gunnery*; Cranz, *Compendium der Ballistik* (1898); *The Official Text-Book of Gunnery* (1902); Charbonnier, *Balistique* (1905); Lissak, *Ordnance and Gunnery* (1907). (A. G. G.)

BALLOON, a globular bag of varnished silk or other material impermeable to air, which, when inflated with gas lighter than common air, can be used in aeronautics, or, according to its size, &c., for any purpose for which its ability to rise and float in the atmosphere adapts such a mechanism. "Balloon" in this sense was first used in 1783 in connexion with the invention of the brothers Montgolfier, but the word was in earlier use (derived from Ital. *ballone*, a large ball) as meaning an actual ball or ball-game, a primitive explosive bomb or firework, a form of chemical retort or receiver, and an ornamental globe in architecture; and from the appearance and shape of an air balloon the word is also given by analogy to other things, such as a "balloon skirt" in dress, "balloon training" in horticulture. (See AERONAUTICS, and FLIGHT and FLYING.)

BALLOT (from Ital. *ballotta*, dim. of *balla*, a ball), the modern method of secret-voting employed in political, legislative and judicial assemblies, and also in the proceedings of private clubs and corporations. The name comes from the use of a little ball

dropped according to choice into the right receptacle; but nowadays it is used for any system of secret-voting, even though no such ball is employed. In ancient Athens, the dicasts, in giving their verdict, generally used balls of stone (*psephoi*) or of metal (*spondulii*). Those pierced in the centre, or black in colour, signified condemnation; those unpierced, or white, signified acquittal. The boxes were variously arranged; but generally a brass box received both classes of votes, and a wooden box received the unused balls. In the assembly, cases of *privilegio*, such as ostracism, the naturalization of foreigners or the release of state-debtors, were decided by secret-voting. The petalism, or voting by words on olive-leaves, practised at Syracuse, may also be mentioned. At Rome the ballot was introduced to the comitia by the *Leges Tabellariae*, of which the *Lex Cassia* (139 B.C.) relates to the election of magistrates, the *Lex Cassia* (137 B.C.) to *judicia populi*, and the *Lex Papiria* (131 B.C.) to the enactment and repeal of laws. The wooden *tabellae*, placed in the *cista* or wicker box, were marked U. R. (*uti rogas*) and A. (*antiquo*) in the case of a proposed law; L. (*libero*) and D. (*damno*) in the case of a public trial; in the case of an election, *puncta* were made opposite the names or initials of the candidates. *Tabellae* were also used by the Roman judges, who expressed their verdict or judgment by the letters A. (*absolvo*), C. (*condemno*), and N. L. (*non liquet*). In modern times voting by ballot is usually by some form of writing, but the use of the ball still persists (especially in clubs), and a "black ball" is the regular term for a hostile vote.

Great Britain.—In Great Britain the ballot was suggested for use in parliament by a political tract of the time of Charles II. It was actually used by the Scots parliament of 1662 in proceeding on the Billenting Act, a measure proposed by Middleton to secure the ostracism of Lauderdale and other political opponents who were by secret-vote declared incapable of public office. The plan followed was this: each member of parliament wrote, in a disguised hand, on a piece of paper, the names of twelve suspected persons; the billets were put in a bag held by the registrar; the bag was then sealed, and was afterwards opened and its contents ascertained in the exchequer chamber, where the billets were immediately burned and the names of the ostracised concealed on oath. The Billenting Act was repudiated by the king, and the ballot was not again heard of till 1705, when Fletcher of Saltoun, in his measure for a provisional government of Scotland by annual parliaments in the event of Queen Anne's death, proposed secret-voting to protect members from court influence. The gradual emancipation of the British parliament from the power of the crown, and the adoption of a strictly representative system of election, not only destroyed whatever reason may once have existed for the ballot in deliberative voting, but rendered it essential that such voting should be open. It was in the agitations for parliamentary reform at the beginning of the 19th century that the demand for the ballot in parliamentary elections was first seriously made. The Benthamites advocated the system in 1817. At the so-called Peterloo Massacre (1819) several banners were inscribed with the ballot. O'Connell introduced a bill on the subject in 1830; and the original draft of Lord John Russell's Reform Bill, probably on the suggestion of Lords Durham and Duncannon, provided for its introduction. Later on the historian Grote became its chief supporter in the House of Commons; and from 1833 to 1839, in spite of the ridicule cast by Sydney Smith on the "mouse-trap," and on Grote's "dagger-box, in which you stab the card of your favourite candidate with a dagger," the minority for the ballot increased from 106 to 217. In 1838 the ballot was the fourth point of the People's Charter. In the same year the abolition of the land qualification introduced rich commercial candidates to the constituencies. Lord Melbourne's cabinet declared the question open. The cause, upheld by Macaulay, Ward, Hume (in his resolutions, 1848) and Berkeley, was strengthened by the report of Lord Hartington's Select Committee

¹ For a description of Grote's card-frame, in which the card was punctured through a hole, and was thus never in the voter's hands, see *Spectator*, 25th February 1837.

(15th March 1870), to the effect that corruption, treating and intimidation by priests and landlords took place to a large extent at both parliamentary and municipal elections in England and Ireland; and that the ballot, if adopted, would probably not only promote tranquillity at elections, but protect voters from undue influence, and introduce greater freedom and purity in voting, provided secrecy was made inviolable except in cases where a voter was found guilty of bribery, or where an invalid vote had been given.

Meanwhile in Australia the ballot had been introduced by the Constitution Act of South Australia (1856), and in other colonies at the same date. In South Australia (Electoral Act of 1858) the returning-officer put his initials on the voting-card, which the voter was directed, under pain of nullity, to fold so that the officer might not see the vote which was indicated by a cross. In Victoria, under the Electoral Act of 1865, the officer added to his initials a number corresponding to the voter's number on the register. In Tasmania the chief peculiarity was that (as in South Australia) the card was not put directly by the voter into the box, but handed to the officer, who put it there (this being thought a security against double-voting or voting with a non-official card, and also against the voter carrying away his card). In 1860, at Manchester and Stafford in England, test-ballots were taken on the Australian system as practised in Victoria—the voting-card containing the names of all the candidates, printed in different colours (for the benefit of illiterate voters), and the voter being directed to score out the names of those he did not support, and then to place the card (covered by an official envelope) in the box. It was found at Manchester that the voting was considerably more rapid, and therefore less expensive, than under the old system; that only 80 cards out of 11,475 were rejected as informal; and that, the representatives of candidates being present to check false statements of identity, and the public outside being debarred from receiving information what voters had voted, the ballot rather decreased the risk of personation. At Manchester the cards were not numbered consecutively, as in Victoria, so that (assuming the officials to be free from corruption) no scrutiny could have detected by whom particular votes were given. At Stafford the returning-officer stamped each card before giving it to the voter, the die of the stamp having been finished only on the morning of the election. By this means the possibility was excluded of what was known as "the Tasmanian Dodge," by which a corrupt voter gave to the returning-officer, or placed in the box, a blank non-official ticket, and carried out from the booth his official card, which a corrupt agent then marked for his candidate, and gave so-marked to corrupt voter No. 2 (before he entered the booth) on condition that he also would bring out his official card, and so on *ad libitum*; the agent thus obtaining a security for his bribe, unless the corrupt voter chose to disfranchise himself by making further marks on the card. At the close of 1870 the ballot was employed in the election of members for the London School Board under the Education Act of that year.

In 1872 W. E. Forster's Ballot Act introduced the ballot in all parliamentary and municipal elections, except parliamentary elections for universities; and the code of procedure prescribed by the act was adopted by the Scottish Education Board in the first School Board election (1873) under the Education (Scotland) Act 1872. The Ballot Act not only abolished public nominations of candidates, but dealt with the offence of personation and the expenses of elections.

As practised in the United Kingdom, a white paper is used on which the names of the candidates are printed in alphabetical order, the voter filling up with a X the blank on the right-hand opposite the name he votes for. The paper, before being given out, is marked by the presiding-officer on both sides with an official stamp, which is kept secret, and cannot be used for a second election within seven years. The paper is marked on the back with the same number as the counterfoil of the paper which remains with the officer. This counterfoil is also marked with the voter's number on the register, so that the vote may be identified on a scrutiny; and a mark on the register shows that

the voter has received a ballot-paper. The voter folds up the paper so as to conceal his mark, but to show the stamp to the officer, and deposits it in the box, which is locked and sealed, and so constructed that papers cannot be withdrawn without unlocking it. Papers inadvertently spoiled by the voters may be exchanged, the officer preserving separately the spoiled papers. If a voter is incapacitated from blindness, or other physical cause, or makes before the officer a declaration of inability to read, or when the poll is on a Saturday declares himself a Jew, the officer causes the paper to be marked as the voter directs, and keeps a record of the transaction. A voter who claims to vote after another has voted in respect of the same qualification, obtains a (green) paper which is not placed in the box, but preserved apart as a "tendered" paper. He must, however, declare his identity and that he has not already voted. The presiding-officer at the close of the poll has to account to the returning-officer for the papers entrusted to him, the number being made up by—(1) papers in the box, (2) spoiled papers, (3) unused papers and (4) tendered papers. During the voting (for which schoolrooms and other public rooms are available, and for which a separate compartment must be provided for every 150 electors entitled to vote at a station) agents of candidates are allowed to be present in the polling-station, but they, as well as the officials, are sworn to secrecy as regards who have voted, and for whom; and they are prohibited from interfering with the voter, inducing him to show his vote, or attempting to ascertain the number on the back of the paper. These agents are also present with the returning-officer when he counts the papers and the votes, rejecting those papers—(1) which want the official mark on the back; (2) on which votes are given for more candidates than the voter is entitled to vote for; (3) on which anything except the number on the back is marked or written by which the voter can be identified; (4) which are unmarked, or so marked that it is uncertain for whom the vote is given. The counted and rejected papers, and also the "tendered" papers, counterfoils and marked register (which have not been opened), are, in parliamentary elections, transmitted by the returning officer to the clerk of the crown in chancery in England, or the sheriff-clerk in Scotland, who destroys them at the end of one year, unless otherwise directed by an order of the House of Commons, or of some court having jurisdiction in election petitions. Such petitions either simply dispute the accuracy of the return on the ground of miscounting, or wrongful rejection or wrongful admission of papers, in which case the court examines the counted and rejected papers; or make allegations of corruption, &c. on which it may be necessary to refer to the marked counterfoils and ascertain how bribed voters have voted. Since the elections of 1874 much discontent has been expressed, because judges have rejected papers with trifling (perhaps accidental) marks other than the X upon them, and because elections have been lost through the failure of the officer to stamp the papers. For this purpose the use has been suggested of a perforating instead of an embossing stamp, while a dark-ground paper with white voting-spaces would make *misplaced* votes impossible.

The Ballot Act introduced several new offences, such as forging of papers or fraudulently defacing or destroying a paper or the official mark; supplying a paper without due authority; fraudulently putting into the box a non-official paper; fraudulently taking a paper out of the station without due authority; destroying, taking, opening or otherwise interfering with a box or packet of papers then in use for election purposes. These offences and attempts to commit them are punishable in the case of officers and clerks with imprisonment for two years, with or without hard labour. In other cases the term of imprisonment is six months.

The ballot was long criticized as leading to universal hypocrisy and deception; and Sydney Smith spoke of "voters, in dominos, going to the poll in sedan-chairs with closely-drawn curtains." The observed effect of a secret ballot has been, however, gradually to exterminate undue influence. The alarm of "the confessional" seems to be unfounded, as a Catholic penitent is not bound to

confess his vote, and if he did so, it would be a crime in the confessor to divulge it.

Continental Europe.—The ballot is largely employed in European countries. In France, where from 1840 to 1845 the ballot, or *scrutin*, had been used for deliberative voting in the chamber of deputies, its use in elections to the Corps Législatif was carefully regulated at the beginning of the Second Empire by the Organic Decree of the 2nd of February 1852. Under this law the voting was superintended by a bureau consisting of the deputy returning-officer (called president of the section), four unpaid assessors selected from the constituency and a secretary. Each voter presents a polling-card, with his designation, date of birth and signature (to secure identity), which he had previously got at the Mairie. This the president mutilates, and the vote is then recorded by a "bulletin," which is not official, but is generally printed with a candidate's name, and given to the voter by an agent outside, the only conditions being that the bulletin shall be "sur papier blanc, sans signes extérieurs, et préparé en dehors de l'assemblée." The total number of votes given (there being only one member in each electoral district) is checked by reference to "la feuille d'appel et inscription des votants," the law still supposing that each voter is publicly called on to vote. If the voter, when challenged, cannot sign his polling-card, he may call a witness to sign for him. The following classes of bulletins are rejected:—"illisibles, blancs, ne contenant pas une désignation suffisante; sur lesquels les votants se sont fait connaître; contenant le nom d'une personne n'ayant pas prêté le serment prescrit" (i.e. of a person not nominated). Only the votes pronounced bad by the bureau in presence of representative scrutineers are preserved, in case these should be called for during the "Session pour vérification des Pouvoirs." Practically the French ballot did not afford secrecy, for you might observe what bulletin the voter took from the agent, and follow him up the *queue* into the polling-place; but the determined voter might conceal his vote even from the undue influence of government by scratching out the printed matter and writing his vote. This was always a good vote and scrutiny of good votes was impossible. The ballot is still used in the elections to the National Assembly, but in the Assembly itself only in special cases, as e.g. in the election of a "rapporteur." Under the law of 10th August 1871 the conseils généraux (departmental councils) are elected by ballot.

In Piedmont the ballot formed part of the free constitutional government introduced by Charles Albert in March 1848; it was extended to Italy in 1861. Voting for the Italian chamber of deputies takes place under the law of 20th November 1850, and in public halls (not booths), to which admission is gained by showing a certificate of inscription, issued by the mayor to each qualified voter. A stamped blue official paper, with a memorandum of the law printed on the back (*bolletino spiegato*), is then issued to the elector; on this he writes the name of a candidate (there being equal electoral colleges) or, in certain exceptional cases, gets a confidential friend to do so, and hands the paper folded-up to the president of the bureau, who puts it in the box (*urna*), and who afterwards presides at the public "scrittino dei suffragi." Greece is the only European country in which the ball-ballot is used. The voting takes place in the churches, each candidate has a box on which his name is inscribed, one half (white) being also marked "yes," the other half (black) "no." The voter, his citizenship or right to vote in the parish being verified, receives one ball or leaden bullet for each candidate from a wooden bowl, which a clerk carries from box to box. The voter stretches his arm down a funnel, and drops the ball into the "yes" or "no" division. The vote is secret, but there is apparently no check on "yes" votes being given for all the candidates, and the ball or bullet is imitable.

The earlier history of the ballot in Hungary is remarkable. Before 1848 secret voting was unknown there. The electoral law of that year left the regulation of parliamentary elections to the county and town councils, very few of which adopted the ballot. The mode of voting was perhaps the most primitive on record. Each candidate had a large box with his name

superscribed and painted in a distinguishing colour. On entering the room alone the voter received a rod from 4 to 6 feet in length (to prevent concealment of non-official rods on the voter's person), which he placed in the box through a slit in the lid. By the electoral law of 1874 the ballot in parliamentary elections in Hungary was abolished, but was made obligatory in the elections of town and county councils, the voting being for several persons at once.

In Prussia, Stein, by his *Städteordnung*, or municipal corporation act of 1808, introduced the ballot in the election of the municipal assembly (*Städteordnetenversammlung*). Under the German constitution of 1867, and the new constitution of the 1st of January 1871, the elections of the Reichstag were to be conducted by universal suffrage under the ballot in conformity with the electoral law of the 31st of May 1869.

America.—At the first elections in America voting was viva voce; but several of the colonies early provided for the use of written or printed ballots. By 1775 ballots were used in the New England states, in Pennsylvania, Delaware, North Carolina and South Carolina; they were introduced in New Jersey in 1776, and in New York in 1778, so that, at the time the constitution of the United States was adopted, viva voce voting prevailed at public elections only in Maryland, Virginia and Georgia. Of the new states which later entered the Union, only Illinois, Kentucky, Missouri and Arkansas did not have a ballot system when they became states. During the first half of the 19th century, Maryland, Georgia, Arkansas (1846) and Illinois (1848) adopted the ballot. In Missouri ballot-voting was introduced to some localities in 1845, but not until 1863 was it generally adopted in that state. Virginia did not provide for voting by ballot until 1869, and in Kentucky viva voce voting continued until 1819, but while the use of ballots was thus required in voting, and most of the states had laws prescribing the form of ballots and providing for the count of the vote, there was no provision making it the duty of any one to print and distribute the ballots at the polling-places on election day. In the primitive town meetings ballots had been written by the voters, or, if printed, were furnished by the candidates. With the development of elections, the task of preparing and distributing ballots fell to political committees for the various parties. The ballot-tickets were thus prepared for party-lists of candidates, and it was not easy for any one to vote a mixed ticket, while, as the voter received the ballot within a few feet of the polls, secrecy was almost impossible, and intimidation and bribery became both easy and frequent.

Soon after the adoption of the Australian ballot in Great Britain, it was introduced in Canada, but no serious agitation was begun for a similar system in the United States until 1885. In 1887 bills for the Australian ballot were actively urged in the legislatures of New York and Michigan, although neither became law. A Wisconsin law of that year, regulating elections in cities of over 50,000 population, incorporated some features of the Australian system, but the first complete law was enacted by Massachusetts in 1888. This Massachusetts statute provided for the printing and distribution of ballots by the state to contain the names of all candidates arranged alphabetically for each office, the electors to vote by marking the name of each candidate for whom they wished to vote. At the presidential election of 1888 it was freely alleged that large sums of money had been raised on an unprecedented scale for the purchase of votes, and this situation created a feeling of deep alarm which gave a powerful impetus to the movement for ballot reform. In 1889 new ballot laws were enacted in nine states: two states bordering on Massachusetts, Connecticut and Rhode Island; four states in the middle-west, Indiana, Michigan, Wisconsin and Minnesota; two southern states, Tennessee and Missouri; and Montana, in the far west. The Connecticut law, however, marked but little improvement over former conditions, since it provided only for official envelopes in which the unofficial party ballots should be voted. The Indiana law provided for a single or "blanket" ballot, but with the names of candidates arranged in party-groups, and a method of voting for all of the candidates in a party-group by a single

mark. Michigan and Missouri also adopted the party-group system. The other states followed the Massachusetts law providing for a blanket ballot with the candidates arranged by offices.

The new ballot system had its first practical demonstration at the Massachusetts election of 1880, and its success led to its rapid adoption in many other states. In 1890 ballot laws were passed in seven states: Vermont, Mississippi, Wyoming and Washington provided for the Massachusetts plan, although Vermont afterwards adopted the system of party-groups, which Maryland used from the first. The New York and New Jersey laws of 1890, however, only provided for official ballots for each party, and allowed ballots obtained outside of the polling-booths to be used. In 1891 seventeen additional states and two territories adopted the Australian ballot system. All of these provided for a blanket ballot; but while the Massachusetts arrangement was adopted in Arkansas, Nebraska, New Hampshire, North and South Dakota, Kentucky, Texas and Oregon, the system of party groups was followed in Colorado, Delaware, Illinois, Maine, Ohio, Pennsylvania and West Virginia. California had the Massachusetts arrangement of names, but added on the ballot a list of party names, by marking one of which a voter would cast his vote for all of the candidates of that party. Pennsylvania placed all the candidates not in a party-group in alphabetical order.

Iowa adopted the Australian ballot system in 1892; Alabama and Kansas in 1893; Virginia in 1894; Florida in 1895; and Louisiana and Utah in 1896. In 1895, too, New York adopted the blanket ballot in place of separate party ballots, but arranged the names of candidates in party columns. The only state to abandon the blanket ballot after once adopting it was Missouri which in 1897 returned to the system of separate ballots, with no provision for booths where the ballot might be marked in secret. (See the article, "Present Status of the Ballot Laws," by Arthur Ludington in *Amer. Pol. Science Rev.* for May 1906.)

Owing to the large number of officials chosen at one time in American elections, the form and appearance of the ballot used is very different from that in Great Britain. At the quadrennial presidential election in New York state, for example, the officers to be voted for by each elector are thirty-six presidential electors, one congressman, state-governor, lieutenant-governor and five other state officers, a member for each house of the state legislature, several judges, a sheriff, county-clerk and other county officers. The column with the list of the candidates of each party for all of these offices is 2 to 3 ft. in length; and as there are often eight to ten party-tickets in the field, the ballot-paper is usually from 18 to 20 in. in width. Each voter receives one of these "blanket" ballots on entering the polling-place, and retires to a booth to mark either a party column or the individual candidates in different columns for whom he wishes to vote. Where, as in Massachusetts, the names of candidates are arranged by offices instead of in party-lists, every voter must mark the name of each individual candidate for whom he wishes to vote. Connecticut, New Jersey, Missouri, North and South Carolina, Georgia and New Mexico use the system of separate party ballots. (See also VOTING, VOTING MACHINES, ELECTION, REPRESENTATION.)

BALLOU, HOSEA (1771-1852), American Universalist clergyman, was born in Richmond, New Hampshire, on the 30th of April 1771. He was the son of Maturin Ballou, a Baptist minister, was self-educated, early devoted himself to the ministry, became a convert to Universalism in 1789, and in 1794 became a pastor of a congregation at Dana, Massachusetts. He preached at Barnard, Vermont, and the surrounding towns in 1801-1807; at Portsmouth, New Hampshire, in 1807-1815; at Salem, Massachusetts, in 1815-1817; and as pastor of the Second Universalist Church in Boston from December 1817 until his death there on the 7th of June 1852. He founded and edited *The Universalist Magazine* (1819; later called *The Trumpet*) and *The Universalist Expositor* (1831; later *The Universalist Quarterly Review*); wrote about 10,000 sermons, many hymns, essays and polemic theological works; and is best known for *Notes on the Parables* (1804), *A Treatise on Atonement* (1805) and *Examination of the Doctrine of a Future Retribution* (1834); in these, especially

the second, he showed himself the principal American expositor of Universalism. His great contribution to his Church was the body of denominational literature he left. From the theology of John Murray, who like Ballou has been called "the father of American Universalism," he differed in that he divested Universalism of every trace of Calvinism and opposed legalism and trinitarian views.

Consult the biography by Thomas Whittemore (4 vols., Boston, 1854-1855) and that by Oscar F. Safford (Boston, 1889); and J. C. Adams, *Hosea Ballou and the Gospel Renaissance* (Boston, 1904).

His grand-nephew, HOSEA BALLOU (1796-1861), born in Halifax, Vermont, on the 18th of October 1796, preached to Universalists in Stafford, Connecticut (1815-1821); and in Massachusetts, in Roxbury (1821-1838) and in Medford (1838-1853); and in 1853 was elected first president of Tufts College at Medford, serving in that office until shortly before his death, which took place at Somerville, Massachusetts, on the 27th of May 1861. He was the first (1847) to urge the necessity of a Universalist denominational college, and this did much towards the establishment of Tufts. He was associated with the elder Hosea Ballou in editing *The Universalist Quarterly Review*; edited an edition of Sismondi's *History of the Crusades* (1833); and wrote the *Ancient History of Universalism*, down to A.D. 553 (1829; 2nd ed., 1842).

MATURIN MURRAY BALLOU (1820-1895), son of the first Hosea, was a pioneer in American illustrated journalism, edited *Gleason's Pictorial and Ballou's Monthly* and many collections of quotations, and in 1872 became editor-in-chief of the *Boston Daily Globe*, of which he was one of the founders. He wrote a life of his father (1860), and a *History of Cuba* (1854).

BALLOON SPA, a village and the county-seat of Saratoga county, New York, U.S.A., about 7 m. S. of Saratoga Springs. Pop. (1890) 3527; (1900) 3923; (1910 U. S. Census) 4138. It is served by the Delaware & Hudson railway, and is connected with Saratoga Springs, Albany, and Schenectady by electric lines. There are several manufacturing establishments, among which are one of the largest manufactories of paper-bags in the United States and a large tannery. It is, however, as a popular summer resort that Ballon Spa is best known. Many fine chalybeate and other springs rising through solid rock from a depth of about 650 ft. furnish a highly effervescent water of considerable medicinal and commercial value. The village has the Ballon Spa public library, the Saratoga county law library and the Saratoga county court house. Ballon Spa, which was named in honour of the Rev. Eliphalet Ball, an early settler, was settled about 1787 by the grandfather of Stephen A. Douglas, and was incorporated in 1855.

See E. F. Prose, *Centennial Hist. of Ballon Spa*, 1908.

BALLYCASTLE, a seaport and watering-place on the north coast of Co. Antrim, Ireland, in the north parliamentary division, situated on a bay of the same name opposite Rathlin Island. Pop. (1901) 1481. It is connected with the Northern Counties (Midland) railway at Ballymoney by the Ballycastle light railway. The town consists of two divisions, about a quarter of a mile apart and connected by a fine avenue. Towards the close of the 18th century Mr Hugh Boyd, obtaining the estate, devoted himself to the extension and improvement of the town, establishing manufactures, endowing charities and building churches; and succeeded in producing a temporary vitality. Upwards of £150,000, including a large government grant, is said to have been expended upon the pier and harbour; but the violence of the sea overthrew the one and the other became filled with sand. To the east of the town are the remains of Bonamargy Abbey, the burial-place of many of the Mac-Donnell family. The Carey brook, by the side of which the abbey stands, was formerly called the Margy, and on its waters according to tradition dwelt the four children of Lir, changed to swans by their step-mother until St Columba released them from enchantment. (See P. W. Joyce, *Old Celtic Romances*.) With this well-known romance is connected the wide-spread belief in Ireland of ill-fortune following the killing of a swan. Coal-seams, formerly extensively worked, and from an unknown

period of antiquity, appear in the cliffs towards Fair Head, and the fisheries are important. The coast-scenery and the view from the hill of Knocklayd are notable.

BALLYMENA, a town of Co. Antrim, Ireland, in the mid parliamentary division, on the Braid, an affluent of the Maine, 2 m. above their junction. Pop. of urban district (1901) 10,886. It is 33 m. N.N.W. of Belfast on the Northern Counties (Midland) railway. Branch lines run to Larne and to Parkmore on the east coast. The town owes its prosperity chiefly to its linen trade, introduced in 1733, which gives employment to the greater part of the inhabitants. Brown linen is a speciality. Iron ore is raised in the neighbourhood. Antiquities in the neighbourhood are few and the present buildings of Ballymena Castle and Galmorm Castle are modern. Gracehill, however, a Moravian settlement, was founded in 1746.

BALLYMONEY, a market town of Co. Antrim, Ireland, in the north parliamentary division, 53 m. N.N.W. from Belfast by the Northern Counties (Midland) railway. Pop. of urban district (1901) 2952. The Ballycastle railway joins the main line here. The trade of the town is prosperous, brewing, distilling and tanning being carried on, besides the linen manufacture common to the whole county. Soap, candles and tobacco are also manufactured, and the town is a centre for local agricultural trade. Near the neighbouring village of Dervock (4½ m. N.) is a cottage shown by an inscription to have been the home of the ancestors of William McKinley, president of the United States.

BALLYMOTE, a market town of Co. Sligo, Ireland, in the south parliamentary division, 14 m. S. of Sligo by the Midland Great Western railway. Pop. (1901) 997. It is a centre for some agricultural trade and has carriage-building works. There are remains of a strong castle, built by the powerful earl of Ulster, Richard de Burgh, in 1300, and the scene of hostilities in 1642 and 1652. Ruins are also seen of a Franciscan foundation attributed to the 13th century; it was a celebrated seat of learning and an extant memorial of the work of its monks is the *Book of Ballymote* (c. 1391) in the possession of the Royal Irish Academy, a miscellaneous collection in prose and verse of historical, genealogical and romantic writings. There are also, near the town, ruins of a house of the Knights of St John (1303).

BALLYSHANNON, a seaport and market-town of Co. Donegal, Ireland, in the south parliamentary division, at the mouth of the Erne; on the Bundoran branch of the Great Northern railway. Pop. (1901) 2359. The river is here crossed by a bridge of twelve arches, which connects the town with the suburb of The Port. Below the bridge the river forms a beautiful cascade, 150 yds. wide, with a fall at low water of 16 ft. Here is the salmon leap, where the fish are trapped in large numbers, but also assisted to mount the fall by salmon-ladders. The fisheries are of great value, and there is an export trade to England in salmon, which are despatched in ice. The harbour is a small exposed creek of Donegal Bay, and is only accessible to small vessels owing to a bar. Previous to the Union Ballyshannon returned two members to the Irish parliament and it was incorporated by James I. There are slight remains of a castle of the O'Donnells, earls of Tyrconnell, where the English, on attempting to besiege it, were defeated and lost heavily in their retreat across the river, in 1597. There are numerous raths or encampments in the vicinity and other remains. Coolmore, 3 m. N.W., is a bathing-resort.

BALM, a fragrant herb, *Melissa officinalis*, of the Deadnettle order (*Labiatae*) with opposite, ovate, crenulated leaves, which are wrinkled above, and small white or rose-spotted flowers. It is a native of central and southern Europe; it is often grown in gardens and has become naturalized in the south of England and grows apparently wild as a garden escape in North America. The name is from the Greek μέλισσα, the plant being visited by bees. Bastard Balm is an allied plant, *Melittis Melissophyllum*, a southern European species, found in the south and south-west of England.

BALMACEDA, JOSÉ MANUEL (1838-1891), president of the republic of Chile, was born in Santiago in 1838. His parents were wealthy, and in his early days he was chiefly concerned in

industrial and agricultural enterprise. In 1865 he was one of the representatives of the Chilean government at the general South American congress at Lima, and after his return obtained great distinction as an orator in the national assembly. After discharging some diplomatic missions abroad, he became successively minister of foreign affairs and of the interior under the presidency of Señor Santa María, and in the latter capacity carried compulsory civil marriage and several other laws highly obnoxious to the clergy. In 1886 he was elected president; but, in spite of his great capacity, his imperious temper little fitted him for the post. He was soon irconcilably at variance with the majority of the national representatives, and on the 1st of January 1891 he sought to terminate an intolerable situation by refusing to convoke the assembly and ordering the continued collection of the taxes on his own authority. This led to the Chilean Civil War of 1891, which ended in the overthrow of Balmaceda, who committed suicide on the 18th of September, the anniversary of his elevation to the presidency.

BALMAIN, a town of Cumberland county, N.S.W., Australia, on the western shore of Darling Harbour, Port Jackson, 2 m. by water from Sydney and suburban to it. Pop. (1901) 30,881. It is the home of great numbers of the working classes of Sydney and some of the largest factories and most important docks are situated here. Saw-mills, iron foundries, chemicals, glass and soap works, shipbuilding yards and a cocoanut-oil factory in connexion with the soap-manufacture at Port Sunlight, England, are among the chief industrial establishments. Balmain became a municipality in 1860.

BALMERINO, JAMES ELPHINSTONE, 1st BARON (c. 1553-1612), Scottish politician, was the third son of Robert, 3rd Lord Elphinstone (d. 1602). Rising to power under James VI. he became a judge and a royal secretary; he accompanied the king to London in 1603 and was made Lord Balmerino, or Balmerinoch, in 1604. In 1605 he became president of the court of session, but his ardour for the Roman Catholic religion brought about his overthrow. In 1599 on the king's behalf, but without the king's knowledge, he had sent a letter to Clement VIII. in which he addressed the pope in very cordial terms. A copy of this letter having been seen by Elizabeth, the English queen asked James for an explanation, whereupon both the king and the secretary declared it was a forgery. There the matter rested until 1608, when the existence of the letter was again referred to during some controversy between James and Cardinal Bellarmine. Interrogated afresh Balmerino admitted that he had written the compromising letter, that he had surreptitiously obtained the king's signature, and that afterwards he had added the full titles of the pope. In March 1609 he was tried, attainted and sentenced to death, but after a brief imprisonment he was released and he died at Balmerino in July 1612.

Balmerino's elder son JOHN (d. 1649) was permitted to take his father's title in 1613. In 1634 he was imprisoned for his opposition to Charles I. in Scotland, and by a bare majority of the jury he was found guilty of "leasing-making" and was sentenced to death. But popular sympathy was strongly in his favour; the poet Drummond of Hawthornden and others interceded for him, and after much hesitation Charles pardoned him. Balmerino, however, did not desist from his opposition to the king. A chief among the Covenanters and a trusted counsellor of the marquis of Argyll, he presided over the celebrated parliament which met in Edinburgh in August 1641, and was one of the Scottish commissioners who visited England in 1644. He died in February 1649 and was succeeded as 3rd lord by his son JOHN (1623-1704), who in 1666 inherited from his uncle James the title of Lord Coupar. John's son JOHN, 4th Lord Balmerino (1652-1736), was a lawyer of some repute and, although a sturdy opponent of the Union, was a Scottish representative peer in 1710 and 1713. John's son ARTHUR (1688-1746) who became 6th Lord Balmerino on the death of his half-brother John in January 1746, is famous as a Jacobite. He joined the partisans of James Edward, the Old Pretender, after the battle of Sheriffmuir in November 1715, and then lived for some time in exile, returning to Scotland in 1733 when his father had

secured for him a pardon. He was one of the first to join Charles Edward in 1745; he marched with the Jacobites to Derby, fought at Falkirk and was captured at Culloden. Tried for treason in Westminster Hall he was found guilty, and was beheaded on the 11th of August 1746, behaving both at his trial and at his execution with great constancy and courage. On his death without issue his titles became extinct.

BALMÈS, JAIME LUCIANO (1810-1848), Spanish ecclesiastic, eminent as a political writer and a philosopher, was born at Vich in Catalonia, on the 28th of August 1810, and died there on the 9th of July 1848. Having attacked the regent Espartero and been exiled he founded and edited on his return the *El Pensamiento de la Nación*, a Catholic and Conservative weekly; but his fame rests principally on *El Protestantismo comparado con el Catholicismo-en sus relaciones con la Civilización Europea* (3 vols., 1842-1844, 6th edition, 1879; Eng. trans. London, 1849), an able defence of Catholicism on the ground that it represents the spirit of obedience or order, as opposed to Protestantism, the spirit of revolt or anarchy. From the historical standpoint it is of little value. The best of his philosophical works, which are clear expositions of the scholastic system of thought, are the *Filosofía Fundamental* (4 vols., 1846, Eng. trans. by H. F. Brownson, 2 vols. New York, 1856), and the *Curso de Filosofía Elemental* (4 vols., 1847), which he translated into Latin for use in seminaries.

See A. de Blanche-Raffin, *Jacques Balmès, sa vie et ses ouvrages* (Paris, 1849); and E. Bullón Fernández, *Jaime Balmès y sus obras* (Madrid, 1903).

BALMORAL CASTLE (Gaelic, "the majestic dwelling"), a private residence of the British sovereign, in the parish of Craithie and Braemar, Aberdeenshire, Scotland, on the right bank of the Dee (here spanned by a fine suspension bridge), 9 m. W. of Ballater and at a height of 900 ft. above the sea. The property formerly belonged to the Farquhasons of Inverey, from whom it was acquired by Sir Robert Gordon, whose trustees disposed of the lease in 1848 to the prince consort, by whom the whole estate was purchased in 1852 and bequeathed to Queen Victoria. The castle is built of granite in the Scots baronial style, with an eastern tower 100 ft. high commanding a superb view—Ballochbuie and Braemar to the W., Glen Gairn to the N., Lochnagar and the beautiful valley of the Dee to the S. On Craig Gowan (1319 ft.), a hill 1 m. to the south, have been erected memorial cairns to Queen Victoria, the prince consort, Princess Alice and other members of the royal family of Great Britain. The parish church of Craithie (1903), replacing the kirk of 1806, is 1½ m. to the W., and about 2 m. farther west stands Abergeldie Castle, another Highland royal residence, an ancient building to which modern additions have been made, inhabited by King Edward VII. when prince of Wales, and after his accession to the throne used as a shooting-lodge.

BALNAVES, HENRY (1512?-1579), Scottish politician and reformer, born at Kirkcaldy about 1512, was educated at St Andrews and on the continent, where he adopted Protestant views. Returning to Scotland, he continued his legal studies and in 1538 was appointed a lord of session. He married about the same time Christian Scheves, and in 1539 was granted the estate of Halhill in Fife, after which he is generally named. Before 1540 he was sworn of James V's. privy council, and was known as one of the party in favour of the English alliance and of an ecclesiastical reformation. He is also described as treasurer to James (*Letters and Papers*, 1543, i. 64), but the regent Arran appointed him secretary in the new government of the infant Queen Mary (January 1543). He promoted the act permitting the reading of the Scriptures in the vulgar tongue, and was one of the commissioners appointed to arrange a marriage treaty between the little queen and the future Edward VI. In London he was not considered so complainant as some of the other commissioners, and was not made privy to all the engagements taken by his colleagues (*ib.* i. 834). But Beton "loved him worst of all," and when Arran went over to the priestly party, Balnaves was, in November 1543, deprived of his offices and imprisoned in Blackness Castle.

Thence he was released by the arrival of Hertford's fleet in the following May, and from this time he became a paid agent of the English cause in Scotland. He took no part in the murder of Beton, but was one of the most active defenders of the castle of St Andrews. He received £100 from Henry VIII. in December 1546, was granted an annuity of £125 by Protector Somerset in 1547 and was made English paymaster of the forces in St Andrews. When that castle surrendered to the French in July Balnaves was taken prisoner to Rouen. Somerset made vain efforts to procure his release and continued his pension. He made himself useful by giving information to the English government, and even Mary Tudor sent him £50 as reward in June 1554. Balnaves also busied himself in writing what Knox calls "a comfortable treatise of justification," which was found in MS. with a preface by Knox, among the reformer's papers, and was published at Edinburgh in 1584 under the title *The Confession of Faith*.

In 1557 Balnaves was permitted to return to Scotland and regain his property; probably it was thought that Mary Tudor's burnings would have cooled the ardour of his English affections, and that in the war threatening between two Catholic countries, Balnaves would serve his own. The accession of Queen Elizabeth changed the situation, and Mary of Guise had reasons for accusing him of "practices out of England" (*Salisbury MSS.* i. 155). He took, in fact, an active part in the rising of 1559 and was commissioned by the Congregation to solicit the help of the English government through Sir Ralph Sadleir at Berwick. He was also selected one of the Scots representatives to negotiate with the duke of Norfolk in February 1560. In 1563 he was restored to his office as lord of session, and was one of those appointed by the General Assembly to revise the *Book of Discipline*. He was one of Bothwell's judges for the murder of Darnley in 1567, and in 1568 he accompanied Moray to the York inquiry into Queen Mary's guilt. He resigned his judicial office in 1574, and died in 1579 at Edinburgh. He has been claimed as a Scots bard on the strength of one ballad, "O gallandis all, I cry and call," which is printed in Allan Ramsay's *Evergreen* (2 vols. 1724-1727).

See *Letters and Papers of Henry VIII.* (1540-1545); Bain's and Thorp's *Cal. of Scottish State-Papers*; *English Domestic and Foreign Cal.*; *Acts of Engl. Privy Council*; *Reg. P.C.*, Scotland; *Reg. Great Seal of Scotland*; *Hamilton Papers*; *Border Papers*; Knox, *Works*; Burnet, *Reformation*; Froude, *Hist.* (A. F. P.)

BALNEOTHERAPEUTICS (Lat. *balneum*, a bath, and Gr. *θεραπεύω*, to treat medically). The medical treatment of disease by internal and external use of mineral waters is quite distinct from "hydrotherapy," or the therapeutic uses of pure water. But the term "balneotherapeutics" has gradually come to be applied to everything relating to spa treatment, including the drinking of waters and the use of hot baths and natural vapour baths, as well as of the various kinds of mud and sand used for hot applications. The principal constituents found in mineral waters are sodium, magnesium, calcium and iron, in combination with the acids to form chlorides, sulphates, sulphides and carbonates. Other substances occasionally present in sufficient quantity to exert a therapeutic influence are arsenic, lithium, potassium, manganese, bromine, iodine, &c. The chief gases in solution are oxygen, nitrogen, carbonic acid and sulphuretted hydrogen. Argon and helium occur in some of the "simple thermal" and "thermal sulphur waters." There are few doctors who would deny the great value of special bathing and drinking cures in certain morbid conditions. In the employment of the various mineral waters, many of the spas adopt special means by which they increase or modify their influence, e.g. the so-called "aromatic" or "medicated" baths, in which substances are mixed to exert a special influence on the skin and peripheral nerves. Of these the "pine-needle" bath has the greatest repute; it is made by adding a decoction of the needles or young shoots of firs and pines. Fir wood oil (a mixture of ethereal oils) or the tincture of an alcoholic extract acts equally well. The volatile ethereal constituents are supposed to penetrate the skin and to stimulate the cutaneous

circulation and peripheral nerves, being eliminated later by the ordinary channels. Similar effects follow the addition to the bath of aromatic herbs, such as camomile, thyme, &c. For a full-sized bath $1\frac{1}{2}$ to 2 lb of herbs are tied in a muslin bag and infused in a gallon of boiling water; the juices are then expressed and the infusion added to the bath. Astringent baths are prepared in a similar way from decoctions of oak bark, walnut leaves, &c. In many spas on the European continent baths are prepared from peat or mud mixed with hot mineral water. Mineral peat consists of decomposing vegetable soil that has been so long in the neighbourhood of the medicinal spring that it has undergone peculiar and variable chemical changes. This is mixed with the hot mineral water until the bath has the desired consistency, the effect on the patient being in almost direct proportion to the density. These baths vary greatly in composition. Mud baths are chiefly prepared from muddy deposits found in the neighbourhood of the springs, as at St Amand. They act like a large poultice applied to the surface of the body, and in addition to the influence of the temperature, they exert a considerable mechanical effect. The pulse is accelerated some 6 to 12 beats a minute, the respiration number rises, and the patient is thrown into a profuse perspiration. They have very great value in gouty and rheumatic conditions and in some of the special troubles of women.

There are certain conditions in which mineral water treatment is distinctly contra-indicated. Advanced cardiac disease and cardiac cases with failure of compensation must pre-eminently be treated at home, not at a spa. Advanced arterio-sclerosis, any form of serious organic visceral disease, advanced cirrhosis, pulmonary tuberculosis with a tendency to haemoptysis, much elevation of temperature or emaciation, are all entirely unsuited for this form of treatment. Serious organic nervous diseases, great nervous depression and old cases of paralysis are all contra-indicated. Any trouble, however suited in itself for spa treatment, must be considered inapplicable if complicated with pregnancy.

In advising balneo-therapeutic treatment in any case, all the conditions and habits of the patient—pecuniary, physical and psychical—must be considered, as the spa must be fitted to the patient, not the patient to the spa. Besides the particular disease, the idiosyncrasy of the patient must be considered, the same morbid condition in different people requiring very different treatment. Retarded convalescence is a condition often treated at the spas, although hygienic surroundings, both mental and physical, are usually all that is necessary to ensure complete recovery. After rheumatic fever, however, if the joints remain painful and the heart is dilated, the thermal gaseous saline water of Nauheim, augmented by Schott's resistance movements, will often appear to work wonders. Chronic rheumatism, where there is much exudation round a joint or incipient stiffness of a joint, may be relieved by hot thermal treatment, especially when combined with various forms of massage and exercises. Simple thermal waters, hot sulphur springs and hot muriated waters are all successful in different cases. Chronic muscular rheumatism can also be benefited in a similar manner. Diseases of the nervous system are on the whole treated by these means with small success. Mental diseases other than very mild cases of depression should be considered inapplicable. Neurasthenics are sometimes treated at chalybeate or thermal muriated saline spas; but such treatment is entirely secondary to the general management of the case. Neuralgic affections and the later stages of neuritis, especially when dependent on gout or rheumatism, are often relieved or cured. Abdominal venosity (abdominal plethora), a feature of obesity, glycosuria, &c., are extremely well fitted for this form of treatment. The alkaline sulphated waters, the bitter waters and the common salt waters can all be prescribed, and after a short course can be supplemented with various forms of active and passive exercises. Diseases of the respiratory organs are far more suited for climatic treatment than for treatment by baths. Anaemia can usually be better or equally well treated at home, or by seaside residence or a sea voyage, though many physicians prescribe chloride of

sodium waters, followed by a course of iron waters at some suitably situated spa. In the anaemia dependent on malarial infection, the muriated or alkaline sulphated waters at spas of considerable elevation and combined with iron and arsenic are often very beneficial. Gravel and stone, if of the uric acid variety, can be treated with the alkaline waters, but the case must be under constant observation lest the urine become too alkaline and a deposition of phosphates take place on the already formed uric acid stone. Gout is so variable both in cause and effect that much discrimination is required in its treatment. Where the patient is of "full habit," with portal stagnation, the sulphated alkaline or mild bitter waters are indicated, especially those of Carlsbad and Marienbad; but the use of these strong waters must be followed by a long rest under strict hygienic conditions. Where this is impossible, a milder course must be advised, as at Homburg, Kissingen, Harrogate, Wiesbaden, Baden-Baden, &c. For very delicate patients, and where time is limited, the simple thermal waters are preferable.

For radiant heat and light baths and electric baths of all kinds, see ELECTROTHERAPEUTICS; and for compressed air baths, AEROTHERAPEUTICS. (See also BATHS, THERAPEUTICS, and the articles on diseases.)

BALQUHIDDER (Gaelic, "the farm in the back-lying country"), a village and parish of Perthshire, Scotland. Pop. of parish (1901) 605. The village lies 2 m. W. of the station of the same name on the Caledonian railway from Calander to Oban, and 27½ m. N.W. of Stirling. It is situated at the east end of Loch Voil, a lake at the foot of the Braes of Balquhider. The MacLaurins acquired the district as early as the 9th century and occupied it for several hundred years until ousted by the Macgregors, a neighbouring clan, who had repeatedly raided their lands, and in 1558 slew the chief and many of his followers. Balquhider was the scene of some of the exploits of Rob Roy, who died there in 1734. His grave in the old kirkyard is marked by a stone ornamented with rude carving, executed probably centuries before his time. Another ancient stone is said traditionally to cover the grave of Angus, the Columban missionary, who was the first to carry on Christian work in this part of the Highlands.

BALRAMPUR, a town of British India near the river Rapti, 28 m. from Gonda, in the Gonda district of the United Provinces. Pop. (1901) 16,723. It gives its name to one of the largest *talukdars* estates in the province. The raja, Sir Drigbijai Singh K.C.S.I., was conspicuously loyal during the Mutiny, and was rewarded with accessions of territory and hereditary privileges. His death in 1882 gave rise to prolonged litigation and the estate was thrown into chancery. The income is estimated at £120,000, paying a revenue of £46,000. Numerous schools and hospitals are supported. Balrampur contains a large palace, a handsome modern temple and an Anglo-vernacular school.

BALSAM (from Gr. *βάλσαμον*, through Lat. *balsamum*, contracted by popular use to O. Fr. *basme*, mod. Fr. *bâme*; Eng. *baln*), a term properly limited to such resins or oleo-resins as contain benzoic acid or cinnamic acid or both. Those balsams which conform to this definition make up a distinct class, allied to each other by their composition, properties and uses. Those found in commerce are the balsam of Peru, balsam of Tolu, liquid storax and liquidambar. *Balsam of Peru* is the produce of a lofty leguminous tree, *Myroxylon Pेरειρα*, growing within a limited area in San Salvador, Central America and introduced into Ceylon. It is a thick, viscid oleo-resin of a deep brown or black colour and a fragrant balsamic odour. It is used in perfumery. Though contained in the pharmacopias it has no special medicinal virtues. *Balsam of Tolu* is produced from *Myroxylon toluiferum*. It is of a brown colour, thicker than Peru balsam, and attains a considerable degree of solidity on keeping. It also is a product of equatorial America, but is found over a much wider area than is the balsam of Peru. It is used in perfumery and as a constituent in cough syrups and lozenges. *Liquid storax* or *styrax preparatus*, is a balsam yielded by *Liquidambar orientalis*, a native of Asia Minor. It is a soft resinous substance, with a pleasing balsamic odour, especially after it

has been kept for some time. It is used in medicine as an external application in some parasitic skin diseases, and internally as an expectorant. An analogous substance is derived from *Liquidambar Altingia* in Java. *Liquidambar balsam* is derived from *Liquidambar styraciflua*, a tree found in the United States and Mexico. It contains cinnamic acid, but not benzoic acid.

Of so-called balsams, entirely destitute of cinnamic and benzoic constituents, the following are found in commerce:—*Mecca balsam* or *Balm of Gilead*, from *Commiphora opobalsamum*, a tree growing in Arabia and Abyssinia, is supposed to be the balm of Scripture and the *βάλσαμον* of Theophrastus. When fresh it is a viscid fluid, with a penetrating odour, but it solidifies with age. It was regarded with the utmost esteem among the nations of antiquity and to the present day it is peculiarly prized among the people of the East. For *balsam of copaiba* see COPAIBA. Under the name of *wood oil*, or *Gurjun balsam*, an oleo-resin is procured in India and the Eastern Archipelago from several species of *Dipterocarpus*, chiefly *D. turbinatus*, which has the odour and properties of copaiba and has been used for the same purposes. Wood oil is also used as a varnish in India and forms an effective protection against the attacks of white ants. *Canada balsam* or *Canada turpentine* is the oleo-resin yielded by *Abies balsamea*, a tree that grows in Canada and the northern parts of the United States. It is a very transparent substance, somewhat fluid when first run, but thickening considerably with age, possessed of a delicate yellow colour and a mild terebinthous odour. It contains 24% of essential oil, 60% of resin soluble in alcohol, and 16% of resin soluble only in ether. Its chief uses are for mounting preparations for the microscope and as a cement for glass in optical work.

The garden balsam is an annual plant, *Impatiens balsamina*, and the balsam apple is the fruit of *Momordica balsamina*, nat. order Cucurbitaceae.

BALSHAM, HUGH DE (d. 1286), English churchman, appears first as sub-prior of the monastery of Ely. On the death of William of Kilkenny in 1256 the monks elected him bishop of Ely, to the annoyance of Henry III. who had handed over the temporalities of the see to John de Waleran. The election was confirmed by the pope in 1257 and Hugh set to work to repair the harm done to the diocese by the intruder. In 1280 the bishop obtained a charter allowing him to replace the secular brethren residing in his hospital of St John at Cambridge by "studious scholars"; a second charter four years later entirely differentiated these scholars from the brethren of the hospital, and for them Hugh de Balsham founded and endowed the college of Peterhouse.

BALTA, a town in the Russian government of Podolia, between the Dniester and the Bug, 131 m. by rail N.N.W. of Odessa. It carries on a large trade in cattle, horses and grain, and has two annual fairs, held at Whitsuntide and in June. A variety of industries, such as tallow-melting, soap-boiling, tile-making and brewing, are carried on. The Jews form a very considerable part of the population, which in 1867 numbered 14,528, and in 1897, 23,393. Balta was in great part destroyed by the Russians in 1780.

BALTARD, LOUIS PIERRE (1764–1846), French architect and engraver, was born in Paris on the 9th of July 1764. He was originally a landscape painter, but in his travels through Italy was so much struck with the beauty of the Italian buildings, that he changed his profession and devoted himself to architecture. In his new occupation he achieved great success, and was selected to prepare the plans for some of the largest public edifices in Paris. His reputation, however, is chiefly based on his great skill in engraving. Among the best known of his plates are the drawings of Paris (*Paris et ses monuments*, 2 vols. fol., 1803), the engravings for Denon's *Égypte*, the illustrations of Napoleon's wars (*La Colonne de la grande armée*), and those contained in the series entitled the *Grand prix de l'architecture*, which for some time he carried on alone. He also gained distinction as an engraver of portraits. Baltard died in Paris on the 22nd of January 1846.

Two of his children were also architects. Of these the more important was VICTOR BALTARD (1805–1874), who was born in Paris on the 19th of June 1805. In 1803 he gained the *prix de Rome* at the Ecole des beaux-arts for designing a military school. He was largely instrumental in introducing a regular scheme of fresco decoration by modern artists in the churches of Paris, to take the place of the heterogeneous collections of pictures of all kinds with which their walls had been promiscuously decorated. He built many additions to existing churches, and also the church of St Augustin, in which he united the structural values of stone and steel. His most popular achievement was, however, the building of the central market in Paris. Victor Baltard also built the slaughter houses and the cattle market of La Villette. He died in Paris on the 13th of January 1874, after a life of great activity in his profession.

BALTIC SEA (Scand. and Ger. *Ostsee*; Russ. *Baltiyskoye More*), a sea extending between 54° and 66° N. lat., and 9° and 30° E. long., surrounded by the territories of Sweden, Russia, Germany and Denmark. Its greatest length is about 660 m.; greatest breadth about 400 m.; and length of coast-line, 5000 m.; central axis runs approximately from south-west to north-east. The Baltic is connected with North Sea by the winding channel between the south of Scandinavia and the Cimbrian peninsula. This channel is usually included in the Baltic. The part of it west of a line joining the Skaw with Christiania fjord receives the name of Skagerrak; the part east of this line is called the Kattegat. At its southern end the Kattegat is blocked by the Danish islands, and it communicates with the Baltic proper by narrow channels called the Sound, the Great Belt and the Little Belt. The real physical boundary between the North Sea and the Baltic is formed by the plateau on which the islands Zealand, Fünen and Laaland are situated; and its prolongation from the islands Falster and Møen to the coasts of Mecklenburg and Rügen.

East of this plateau the Baltic proper forms a series of hollows or troughs. The first, or Bornholm deep, lies east of the island of Bornholm, and is separated from the next, or Gotland deep, by the Middelbank. Beyond the Middelbank the Danziger Tiefe, an isolated depression, lies to the south-east, while to the north-east the Gotland basin, the largest and deepest of all, extends north-eastwards to the Gulf of Finland. Along the Swedish coast a deep channel runs northward from outside the island of Öland; this is entirely cut off to the south and east by a bank which sweeps eastward and northward from near Karlskrona, and on which the island of Gotland stands, but it communicates at its northern end with the Gotland deep, and near the junction opposite Landsort is the deepest hole in the Baltic (420 metres = 230 fathoms).

An unbroken ridge, extending from Stockholm to Hangö in Finland, separates the Baltic basin proper from the depression between Sweden and the Åland Isles, to which the name Åland Haf has been given. North of the Åland Haf a ridge defines the southern edge of another depression, the Bothnian Sea, which in turn is separated from the most northerly division, the Gulf of Bothnia, by a ridge across the narrow Quarken or Kvarken Strait. The Gotland deep may be said to extend directly into the Gulf of Finland, an arm of the Baltic, running eastwards for about 250 m., and separating Finland from Esthonia. Between Esthonia and Courland is the Gulf of Riga, a shallow inlet of roughly circular form, about 100 m. in diameter, and nowhere more than 27 fathoms deep.

According to recent computations the total area of the Baltic, including the Skagerrak and Kattegat, is 166,397 sq. m., and its volume 6007 cub. m., giving a mean depth of 36 fathoms, which is markedly less than that of any other arm of the sea of similar area.

In the deeper hollows in the south part of the Baltic the bottom consists almost invariably of either soft brown or grey mud or hard clay, while on the shallow banks and near the low coasts fine sand, of white, yellow or brown colour with small pebbles, is usually found.

At the time of the last great subsidence, in glacial times, an arm of the sea extended across Sweden, submerging a great part of the littoral up to the Gulf of Bothnia, and including the present lakes Vener, Hjelmar and Mälär. During this period the waters of the northern Baltic were sufficiently salt for oysters to flourish. The subsequent upheaval restricted direct communication with the open sea to the Danish channels, and the Baltic waters became fresher: the oyster disappeared, but a number of cold salt-water fishes and crustaceans, and even seals, became acclimatized. It has been suggested that the presence of the remains of these animals indicates a communication to the north with the Arctic Ocean; but in view of the severe climatic conditions still prevailing at the time, this seems an unnecessary assumption. In the next stage of its history the Baltic is transformed by further elevation into a vast freshwater lake, the *Ancyclus* lake of G. de Geer (named from the remains of the mollusc *Ancyclus fuvialis*), which is supposed to have covered an area of about 220,000 sq. m., including the whole of the present Baltic area and a large part of Finland, with Lake Ladoga. Then followed a subsidence, which not only re-established communication through the Danish channels, but allowed the Baltic to become sufficiently salt for such forms as *Cardium edule* and *Littorina littorea*. At this time the Gulf of Bothnia must have suffered greater depression than the Baltic proper, for the deposits of that epoch show a thickness of 100 metres (328 ft.) near Hernösand, but of only 25 metres (82 ft.) in the neighbourhood of Gotland. After this period of subsidence the process of elevation set in which gave the Baltic its present form and physical condition, and appears to be still in progress. Dr R. Sieger has traced a series of isobasic lines, or lines of equal rate of elevation, for portions of Sweden and Finland; these indicate that the movement is now almost *nil* along the axial lines of the Baltic and the Gulf of Finland, but increases in amplitude northwards to the Gulf of Bothnia and in the direction of the main ridge of the *massif* of southern Sweden. At Stockholm the rate of elevation is approximately 0.47 metre (=1.54 ft.) in a century.

The coast of the Baltic is rocky only in the island-studded region at the head of the Baltic basin proper—a submerged lake-district—and the littoral generally is a typical moranic land, the work of the last great Baltic glacier. The southern margin of the Baltic is of peculiar interest. From Schleswig eastwards to Lübeck Bay the coast is pierced by a number of narrow openings or *Fährden*, the result of encroachment of the sea caused by subsidence. East of Lübeck, as far as the mouth of the Oder, these give place to *Bodden*, ramified openings studded with islands; the structure here resembles that of Scania in southern Sweden, a region once joined to both Denmark and Pomerania by an isthmus which was severed by tectonic movements. Beyond the Oder the coast-line is unbroken as far as the Gulf of Danzig. It is then cut into by the estuaries of the Vistula, the Pregel and the Memel. Here the westerly winds have full play, and the coast is rimmed by a continuous line of dunes, which cut off the two great lagoons of the *Frisches Haff* and *Kurisches Haff* by sandspits or *Nehrungen*.

The drainage area of the Baltic is relatively large. According to the measurements of Sir J. Murray it extends to 461,450 sq. sea m. (=611,700 sq. English m.). The largest river-basin included in it is that of the Neva in the east, and next in size come the Vistula and the Oder in the south. The narrow parallel troughs, at right angles to the coast, which form the drainage-system of Sweden and western Finland, are a remarkable feature.

Levelings from Swinemünde show that the mean level of the surface of the Baltic at that point is 0.093 metres (=.305 ft.) below the surface of the North Sea at Amsterdam, and 0.066 metres (=.216 ft.) below its level at Ostend. A line of levels from Swinemünde through Eger to the Adriatic showed the mean level of the surface of the Baltic to be 0.499 metres (1.6 ft.) above that of the Adriatic Sea. The mean level of the surface of the Baltic rises about 0.5 metres (1.6 ft.) from the coast of Holstein to Memel, probably as a result of the prevailing westerly winds; this mean difference is exceeded with strong westerly winds, and disappears or is reversed with easterly winds. The waves of the Baltic are usually short and irregular, often dangerous to navigation. Destructive waves, probably caused by distant earthquakes, called *Seebären* (cf. English "bores") have been recorded.

The range of the tides is about one foot at Copenhagen; within the Baltic proper ordinary tides are scarcely perceptible. There is, however, a distinctly marked annual rise and fall due to meteorological influences having a mean range of about 11.4 cm. (0.37 ft.), at Travemünde, and 13.9 cm. (0.46 ft.) at Swinemünde, the maximum occurring at the end of the summer rainy period in August.

The circulation of water in the Baltic proper must be considered apart from that in the channels connecting it with the

North Sea; and in this relation the plateau connecting the islands Falster and Møen with the coast of Mecklenburg and Rügen must be taken as the dividing line. In the great basins and hollows from Rügen to the Gulfs of Bothnia and Finland the upper layers of water, from 30 to 70 metres (16 to 38 fathoms) in thickness, have almost the same salinity throughout. In these waters a vertical circulation is kept up by convection

currents. Beneath these layers are masses of saltier water, through which a thermal wave of small amplitude is slowly propagated to the bottom by conduction. These strata are practically stagnant, deficient in oxygen and surcharged with carbonic acid. Their saltier waters must have been originally derived from outside, and must therefore have passed over the plateau between Falster and Mecklenburg, but their horizontal extension is checked by the ridges separating the deep hollows in the Baltic from each other. The inflow to the deep basins is intermittent, probably with a long period of flux and reflux.

The circulation in the channels connecting the Baltic proper with the North Sea is of a complex character. It is necessary in the first place to distinguish clearly between outflowing and inflowing waters; in practice this is easily done, as the outflowing water always contains less than 30 parts *pro mille* of salt, and the inflowing water more than 32 *pro mille*. The Baltic receives much more water by rainfall, discharge of rivers, &c., than it loses by evaporation; hence a surplus must be got rid of by an outflowing current which may be named the "Baltic Stream." The following general laws may be laid down with regard to this:—

1. That the Baltic Stream must be a surface current, because it originates from a redundancy of fresh water.

2. That, on account of the earth's rotation, the main part of the Baltic Stream must keep close to the coast of the Scandinavian peninsula.

3. That it must be a periodic stream, because the discharge of the rivers into the Baltic varies with the season of the year. In spring and summer the water from the Baltic is sufficiently abundant to inundate the whole surface of the Kattegat and Skagerrak, but in winter the sources of the Baltic current are for the most part dried up by the freezing of the land water.

All the waters which enter the Skagerrak or Kattegat as undercurrents can be found at the surface of the North Sea (*q.v.*). They may be divided according to their origin and salinity as follows:—

(a) *Ocean water*, of 35 *pro mille* salinity or more.

(b) *North Sea water*, the predominant water in the North Sea area, of 34 to 35 *pro mille* salinity.

(c) *Bank water*, 32 to 34 *pro mille*, which forms a broad edging covering the coast banks of Holland, Germany, Denmark and Norway.

The deepest water stratum in the Skagerrak is certainly of oceanic origin; it has been found to suffer changes of long period, and it is probably not always composed of water derived from the same part or the same depth of the North Atlantic; this water is, as a rule, deficient in oxygen. The "North Sea" water, of 34 to 35 *pro mille* salinity, does not appear at the surface in the Skagerrak, except as a strip along part of the coast of Jutland, but it is always found as an undercurrent overlying the oceanic water. It enters into all the deep coast channels, and into the Christiania fjord, but it is not always found in the deep channels of the Kattegat. The principal time of inflow of North Sea water is during spring and summer. The bank-water of 32 to 34 *pro mille* salinity is found all along the continental coast of the North Sea and North Atlantic, and it may therefore enter the Skagerrak either from the North Sea or from the north along the coast of Norway. It is probable indeed that an inflow of this water occurs from both directions—in August and September from the south, and in the late winter and early spring from the north. The seasonal changes in the distribution of the bank-waters in different parts of the coast are too complex to be briefly explained; their relations to the times of occurrence of various fisheries of the region present many remarkable features, which have been investigated in recent years by the Swedish Commission.

On the west and south coasts of Sweden, and in the Skagerrak south-east of Norway, navigation is interfered with by ice only in severe winters, and then the ice is usually drifting, compact sea-ice being very rare. Between Stockholm and Visby navigation usually ceases at the end of December and begins again about the 10th of April. During very severe winters the Åland Sea is covered with thick ice available for traffic. The south part of the Gulf of Bothnia is covered with ice every winter along the coasts, but rarely, if ever, in its central part. Navigation is interrupted by drifting ice from about the middle of November to the beginning of May, though the port of Hernösand has been known to remain open during a whole winter. The northern Quarken is covered with traversable ice every third or fourth year. The northern part of the Gulf of Bothnia is frozen every winter. In the Gulf of Finland the sea is closed to navigation by ice for about 150 days in the year; but navigation is rendered possible throughout the winter by the use of ice-breakers.

See references to different parts of the subject in the standard book of E. Petz, A. de Lapparent, E. Sauer and others. Also Crunin, *Die Entstehung der Ostsee* (Leipzig, 1895); G. de Geer, *Om Skandinavien's nordförändringar under kvartärperioden* (Stockholm, 1888); R. Sieger, *Seenschwankungen und Stranderschiebungen in Skandinavien* (Berlin, 1893); O. Pettersson, "Review of Swedish Hydrographic Research," *Scottish Geographical Magazine* (1894); N. Ekholm, *Om klimatets ändringar i geologisk och historisk tid*. *Ymer* (Stockholm, 1899); *Publications of the International Council for the Study of the Sea* (Copenhagen, since 1902). (H. N. D.)

BALTIMORE, GEORGE CALVERT, 1ST BARON (c. 1580-1632), English statesman, son of Leonard Calvert, and Alice, daughter of John Crosland of Crosland, was born at Kipling in Yorkshire and educated at Trinity College, Oxford. After travelling on the continent, he entered the public service as secretary to Robert Cecil, afterwards earl of Salisbury. In 1606 he was appointed clerk of the crown in Connaught and Clare, in 1608 a clerk of the council, and was returned to parliament for Bossiney in 1609. He assisted James I. in his discourse against Vorstius, the Arminian theological professor of Leiden, and in 1613 took charge of the Spanish and Italian correspondence. The same year he was sent on a mission to Ireland to investigate grievances. For these services he was rewarded by knighthood in 1617, followed by a secretaryship of state in 1619 and a pension of £2000 a year in 1620. He represented successively Yorkshire (1621) and Oxford University (1624) in the House of Commons, where it fell to him in his official capacity to communicate the king's policy and to obtain supplies. He was distrusted by the parliament, and was in favour of the unpopular alliance with Spain and the Spanish marriage. Shortly after the failure of the scheme he declared himself a Roman Catholic, and on the 12th of February 1625 threw up his office, when he was created Baron Baltimore of Baltimore and received a grant of large estates in Ireland. Henceforth he was seen little in public life and his attention was directed to colonial enterprise, with which his name will be always associated. He had established a small settlement in Newfoundland in 1621, for which under the name of Avalon he procured a charter in 1623, and which he himself visited in 1627. In consequence of disputes and the unsuitable nature of the climate he sailed thence for Virginia, but was forbidden to settle there unless he took the oaths of allegiance and supremacy. He returned home, and died on the 15th of April 1632 before a new concession was secured, the charter of Maryland passing the great seal on the 20th of June 1632 in favour of his son Cecilus, second Lord Baltimore, who founded the colony. Baltimore married Anne, daughter of George Mysons of Hurlingfordbury, Hertfordshire, by whom he had six sons and five daughters. He wrote *Carmen Junebre in D. Hen. Untonsm* (1596); *The Answer to Tom Tell-Troth* . . . (1642) is also attributed to him, and Wood mentions Baltimore as having composed "something concerning Maryland." His letters are to be found in various publications, including *Strafford's Letters, Clarendon State Papers and the Calendars of State Papers*.

BIBLIOGRAPHY.—*George and Cecilus Calvert* by William Hand Browne (1890); article by C. H. Firth in the *Dict. of Nat. Biog.* with references there given; Wood's *Athenae Oxonienses* (Bliss) ii. 522; Doyle's, *The English in America; Discourse on the Life and Character of Sir G. Calvert* by J. P. Kennedy (1845), with the *Review* and the *Reply* to the same; *London Magazine*, June 1768; "Sir G. Calvert," by L. W. Wilhelm (*Maryland Hist. Soc.*, 14th April 1884); *The Nation*, vol. 70, p. 95; *American Historical Review*, vol. 5, p. 577.

BALTIMORE, a city and seaport, and the metropolis of Maryland, U.S.A., the 7th city in population in the United States. It is at the head of tide-water on the Patapsco river and its middle and north-west branches where they form an estuary 12 m. from the entrance of their waters into Chesapeake Bay, in lat. 39° 17' N. and long. 76° 37' W., about 172 m. by water from the Atlantic Ocean, 40 m. by rail N.W. from Washington, 20 m. N. by W. from Annapolis, 97 m. S.W. from Philadelphia, and 184 m. from New York. Pop. (1890) 434,430; (1900) 508,957 of whom 79,258 were negroes, and 68,600 foreign-born (of these 33,208 were natives of Germany, 10,493 of Russia, 9690 of Ireland, 2841 of England, 2811 of Poland, 2321 of Bohemia and 2042 of Italy); (1910, census) 558,485. It is served by the Baltimore & Ohio, the Philadelphia, Baltimore & Washington (the Pennsylvania system), the Baltimore & Annapolis Short Line, the Baltimore, Chesapeake & Atlantic; the Northern Central; the Western Maryland and the Maryland & Pennsylvania railways; and by steamship lines running directly to all the more important ports on the Atlantic coast of the United States, to ports in the West Indies and Brazil, to London, Liverpool, Southampton, Bristol, Leith, Glasgow, Dublin, Belfast, Havre, Antwerp, Rotterdam, Bremen, Hamburg and other European ports.

The city extends nearly 6½ m. from E. to W., and except on the W. side a little more than 5 m. from N. to S., covering an area of about 32 sq. m. The ground on which it is built is for the most part gently rolling; originally some portions were swampy and others were marked by precipitous heights, but the swamps have been drained and filled and the heights rounded off, Jones's Falls, a small stream shut in between granite walls several feet in height, crosses the N. boundary line a short distance W. of its middle, flows S. E. to the S.E. corner of the main business quarter, and there meets the north-west branch of the Patapsco, in which lies the harbour, defended at its entrance by the historic Fort McHenry, built at the S.E. extremity of Locust Point, an irregular peninsula extending S.E., on which are grain-elevators and a number of wharves, including those of the Baltimore & Ohio railway.

That part of the city which lies E. of Jones's Falls is known as East Baltimore, and is in turn nominally divided into Fells Point to the S. and E., now a shipbuilding and manufacturing quarter, and Old Town to the N. and W. In the Old Town still remain a few specimens of eighteenth century architecture, including several old-fashioned post-houses, which used to furnish entertainment for travellers starting for the Middle West by way of the old Cumberland Road beginning at Fort Cumberland, and from Baltimore to Fort Cumberland by a much older turnpike. The more inviting portion of the modern city lies on the western side of Jones's Falls, and the principal residential districts are in the northern half of the city. A little S. from the centre of the city, Baltimore Street, running E. and W., and Charles Street, running N. and S., intersect; from this point buildings on these two streets are numbered N., S., E. and W., while buildings on other streets are numbered N. and S. from Baltimore Street and E. and W. from Charles Street. Baltimore Street is the chief business thoroughfare; S. of it as well as a little to the N. is the wholesale, financial and shipping district; while West Lexington Street, a short distance to the N., and North Howard and North Eutaw Streets, between Fayette and Franklin Streets, have numerous department and other retail stores. In North Gay Street also, which runs N.E. through East Baltimore, there are many small but busy retail shops. North Charles Street, running through the district in which the more wealthy citizens live, is itself lined with many of the most substantial and imposing residences in the city. Mount Vernon Place and Washington Place, intersecting near the centre of the city, Eutaw Place farther N.W., and Broadway running N. and S. through the middle of East Baltimore, are good examples of wide streets, having squares in the middle, adorned with lawns, flower-beds and fountains.

The buildings of the principal business quarter have been erected since 1904, when a fire which broke out on Sunday the 7th of February destroyed all the old ones within an area of 150 acres. Within a year after the fire, however, 225 places of business were again occupied and 170 more were building. A city ordinance prohibited the erection of any building more than 185 ft. in height, and prescribed a uniform height for those in the same neighbourhood; a large portion of the new buildings are of either three or four storeys, but a few tall ones range from ten to sixteen. The principal materials of which they are built are limestone, granite, marble and bricks, and terra-cotta of various colours.

The city hall, the post-office and the court-house, standing in a row, and each occupying a separate block along E. Fayette Street in almost the exact centre of the city, are three of Baltimore's most imposing buildings, and all of them narrowly escaped destruction by the great fire. The city hall, completed in 1875, in the Renaissance style, consists of a centre structure of four storeys surmounted by an iron dome 260 ft. high, and two connecting wings of three storeys surmounted by a mansard roof; the entire outer facing is of white Maryland marble. The post-office, completed in 1890, is built of Maine granite. The court-house, completed in 1890, is of white marble, with mural paintings by La Farge, E. H. Blashfield and C. Y. Turner. Two of the principal library buildings—the Peabody and the Enoch Pratt—

are faced with white marble. Among the churches may be mentioned the Roman Catholic cathedral, surmounted by a dome 125 ft. high—Baltimore being the seat of a Roman Catholic archbishopric, the highest in rank in the United States; the First Presbyterian church (decorated Gothic), with a spire 250 ft. high; the Grace Episcopal church—Baltimore being the seat of a Protestant Episcopal bishopric; the First Methodist Episcopal church; and the synagogues of the Baltimore Hebrew Congregation and the Oheb Shalom Congregation. Other notable buildings are the custom-house, the Masonic Temple, the Maryland Club-house, the Mount Royal station of the Baltimore & Ohio railway, and the buildings of the Johns Hopkins hospital. There are several good bridges across Jones's Falls.

On an elevated site at the intersection of Washington Place—a continuation of N. Charles Street—with Mount Vernon Place stands a white marble monument in honour of George Washington, the eldest of the monuments in his honour in the United States. The corner-stone was laid in 1815 and the monument was completed in 1820. The base is 50 ft. sq. and 24 ft. high; on this stands a Doric column, 25 ft. in diameter at the base and 130 ft. high, which is surmounted by a statue of Washington 16 ft. high. A winding stairway in the interior leads to a parapet at the top. In the square by which the monument is surrounded are also statues of George Peabody by W. W. Story (a replica of the one in London), Roger Brooke Taney by W. H. Rinehart, and John Eager Howard by Emmanuel Frémiet; and bronze pieces representing Peace, War, Force and Order, and a figure of a lion by Antoine L. Barye. The Henry Walters collection of paintings, mostly by modern French artists, and of Chinese and Japanese bronzes, ivory carvings, enamels, porcelain and paintings is housed in the Walters Art Gallery at the S. end of Washington Place; at the south-east corner of the square is the Peabody Institute with its conservatory of music and collection of rare books, of American paintings, and of casts, including the Rinehart collection of the works of William H. Rinehart who was a native of Maryland. In Monument Square near the post-office and the court-house is the white marble Battle Monument, erected in 1815 to the memory of those who had fallen in defence of the city in the previous year; it is 52 ft. high, the column being in the form of a bundle of Roman fasces, upon the bands of which are inscribed the names of those whom it commemorates; and the whole is surmounted by a female figure, the emblematic genius of the city. To this monument and the one in honour of Washington, Baltimore owes the name "The Monumental City," frequently applied to it. A small monument erected to the memory of Edgar Allan Poe stands in the Westminster Presbyterian churchyard, where he is buried; there is another monument to his memory in Druid Hill Park. In Greenmount Cemetery in the north central part of the city are the graves of Junius Brutus Booth, Mme Elizabeth Patterson Bonaparte (1785-1870), the wife of Jerome Bonaparte, Johns Hopkins, John McDonogh and Sidney Lanier.

In 1908 there were in the city under the jurisdiction of the department of public parks and squares 13 parks of 10 acres or more each and 33 squares, and the total acreage of parks was 2188 acres and of squares 86.53 acres. Chief among the parks is Druid Hill Park in the N.W. containing 672.78 acres and famous for its natural beauty. Clifton Park, of 311.26 acres, 2 m. E. of Druid Hill and formerly a part of the Johns Hopkins estate, passed into the possession of the city in 1895. Patterson Park in the extreme S.E., of 125.79 acres, is a favourite resort for the inhabitants of East Baltimore.

Education.—Baltimore ranks high as an educational centre. Johns Hopkins University (*q.v.*) is a leading institution of the United States for graduate study. The Peabody Institute, founded in 1850 by George Peabody, who was for some years a resident of Baltimore, is an important factor in the promotion of science, literature and the fine arts. Goucher College (Methodist, 1888) for women, is one of the best institutions of the kind in southern United States. The older of the two state normal schools, opened in 1867, is located here. Morgan College (Methodist), opened in 1876, offers the advantages of a

college education to the coloured young people. Loyola College, founded in 1852, and various other institutions are for the training of the Catholics.

The McDonogh farm school, about 12 m. N.W., with a farm of 835 acres, a printing-office, and carpenter and machine shops prepares poor boys to enter any college in the country. The institution owes its origin to a bequest left by John McDonogh. Among the professional schools are the university of Maryland and Baltimore University—each of which offers courses in law, medicine and dentistry—the Baltimore Medical College, the College of Physicians and Surgeons, the Woman's Medical College, the Baltimore College of Dental Surgery, the Maryland College of Pharmacy (since 1924 part of the university of Maryland), the Baltimore Law School, St Joseph's Seminary and St Mary's Seminary, which, established by the Society of St Sulpice in 1791, is said to be the oldest Catholic theological seminary in the United States. The city also has a Polytechnic Institute, as well as high schools for white and for coloured pupils. The principal libraries are those of Johns Hopkins University, Peabody Institute, Maryland Historical Society, and the Bar Association; and the Enoch Pratt, the New Mercantile, and Maryland Diocesan (Protestant Episcopal).

The charitable institutions of Baltimore are numerous. Several such institutions supported wholly or in part by the state of Maryland (*q.v.*) are located here, and besides these there are scores of others. A representative list includes:—the Charity Organization Society, the primary object of which is to organize the work of the others; the Baltimore Association for the Improvement of the Condition of the Poor, which seeks to discourage indiscriminate alms-giving; the Bay View asylum or city poorhouse; the Children's Aid Society; the Thomas Wilson Fuel-Saving Society, for furnishing coal at low rates; the Woman's Industrial Exchange, for assisting women in need to support themselves; Johns Hopkins hospital, noted for the excellence of its equipment especially for heating and ventilating; Saint Joseph's general hospital; hospital for the women of Maryland of Baltimore city; nursery and child's hospital; Baltimore eye, ear and throat charity hospital; Maryland hospital for the insane; the Sheppard asylum, intended especially for the cure of the insane; the Sheppard and Enoch Pratt hospital; the Baltimore orphan asylum; Saint Vincent's infant asylum; the Thomas Wilson sanatorium for children, intended for children under three years of age, who are suffering from disease, during the warm summer months; the Free Summer Excursion Society, for affording a change of air to the indigent sick; home for the incurables; homes for the aged; homes for friendless children; institutions for the blind; and institutions for the deaf and dumb.

Water for the city taken from Jones's Falls and Gunpowder river a few miles N. of the city limits, is brought through tunnels, and is stored in eight reservoirs having an aggregate capacity of 2275 million gallons. The whole system is owned by the municipality and can furnish about 300 million gallons daily. After the fire \$10,000,000 was appropriated for a new sewage system (began 1906). In 1900 the Maryland legislature empowered the city to borrow \$1,350,000 to establish a municipal lighting plant, but in 1900 private concerns still limited the streets with light.

Commerce.—The harbour, which consists of three parts, is excellent. Its entrance at Fort McHenry is a channel 600 ft. wide, with a minimum draft (1907) of 31 ft. of water. The depth is continued with an increased width for a mile and a quarter to near Fells' Point, where the width is contracted to one-fourth of a mile with a depth of 16 ft. Above this entrance it widens into an ellipse a mile long, half a mile broad and 15 ft. deep. The third or inner harbour has a depth of 14 ft. and penetrates far into the city. Vessels of the largest class can lie at the Locust Point wharves and Canton, and vessels of 4000 tons can use the inner harbour W. of the mouth of Jones's Falls. By 1905 \$5,000,000 had been appropriated since the great fire for new docks. In 1908 the city ranked fourth among the Atlantic ports of the United States in the amount of its exports (\$82,113,496), and fourth in the amount of its imports (\$23,722,045).

That Baltimore has grown rapidly as a manufacturing city since 1880 is seen from the fact that in that year there were but 3683 manufacturing establishments, with a total annual product valued at \$78,417,304, as compared with 6350 establishments (of which 2274 were under the factory system) in 1900 producing commodities valued at \$161,249,240 (\$135,107,626 under the factory system); in 1905 there were 2163 establishments under the factory system with a total annual product valued at \$151,546,580, an increase of 12.2% in the five years. The city ranked eighth among the manufacturing centres of the United States, as regards the value of products, in the three successive censuses of 1880, 1890 and 1900. In 1905 it was ninth. Baltimore is noted particularly as the most important centre in the United States of the canning and preserving industry. The output in 1905 (\$5,981,541) of the city's establishments for the canning and preserving of fruits and vegetables was 7.7% of that of the whole United States; in 1900 it had been 15% of the country's total. What seems to have been the first oyster-canning establishment in America was built in Baltimore (by a Thomas Kensett) in 1820, and oyster-canning as a distinct industry on a permanent footing was begun here in 1850. The term "cove oysters," now applied to canned oysters everywhere, was originally applied to the oysters found in the coves on the W. side of the Chesapeake Bay, above the mouth of the Potomac. Up to 1900, after which year oyster canneries began to be built in the southern states, especially in Mississippi, Baltimore was the centre of the oyster-canning industry. Baltimore is also a well-known centre for the manufacture of clothing, in which in 1905 (\$22,684,656) it ranked fourth among the cities of the United States; for cigar and cigarette-making (1905, \$4,360,366); for the manufacture of foundry and machine shop products (1905, \$6,572,925); of tinware (1905, \$5,705,980); of shirts (1905, \$5,710,783); of cotton-duck (the output of sail-duck being about three-fourths of the total for the United States); bricks (about 150,000,000 annually), and fertilizers; it also manufactures furniture, malt liquors, and confectionery, and many other commodities in smaller amounts. The markets, especially the Lexington market, are noted for the abundance and great variety of their produce. The proximity of coal-mines, the abundance and variety of food supplies furnished by the state, the great quantity and variety of the city's manufactured goods, the excellent shipping facilities, and the consequent low cost of living, are prominent features of the physical life of the city.

Government.—Although the charter under which Baltimore is governed came into effect as late as 1808, it is only the second one for the city, the first one having been in force for 101 years. The mayor is now elected for a term of four years; he must be at least twenty-five years of age and must have property in the city valued at \$2000 or more, on which he shall have paid taxes for two years preceding his election. Great responsibility is centred upon him by giving him power to appoint the heads of departments and sub-departments, subject to the approval of the second branch of the council, and permitting him to remove at pleasure for six months after an appointment; in appointing a board or commission, however, he is required to choose the members from more than one political party. He has five days in which to veto an ordinance, and an affirmative vote of three-fourths of the members of each branch of the council is required to pass an ordinance over his veto. The council, constituting the legislative department, consists of two branches. The first branch is composed of one member from each ward, elected for a term of four years; the second branch of two members from each of four districts, and a president elected by the city at large, all for a term of four years; a property qualification is prescribed for members of each branch. All municipal officers are elected in May in order to separate municipal from state and national elections. No street franchise can be granted for a longer term than twenty-five years, and the right to regulate the exercise of each and every franchise is reserved to the mayor and council. A board of estimate, composed of the mayor, the city solicitor, the comptroller, the president of the second branch of the city council, and the president of the board of

public improvements, has control over appropriations, the council having power to decrease the amount of any item but not to enlarge it. To create a debt for any purpose other than to meet a temporary deficiency, the mayor and council must first obtain the consent of both the state legislature and the city electorate. The department of education is intrusted to an unsalaried board of nine commissioners, appointed by the mayor with the approval of the second branch of the council for a term of six years, three retiring every two years. This board appoints a superintendent, six or more assistant superintendents, and the teachers of the high schools and the Polytechnic Institute, also the other teachers, but only according to the superintendent's recommendation on the basis of merit.

History.—Baltimore was named in honour of the Lords Baltimore, the founders of the province of Maryland, but no settlement was made here until nearly 100 years after the planting of the colony; meanwhile at least two other town-sites, on which it was hoped permanent towns might be established, had received the same name, but nothing came of either. Finally, however, while the provincial legislature was still engaged in the practice of directing places to be laid out for towns, where, as events proved there was nothing to give these towns more than a mere paper existence, that body in 1720 directed seven commissioners to purchase 60 acres of land on the N. side of the Patapsco and lay it out in sixty equal lots as the town of Baltimore. Three years later, at the instance of the same body, Jones-Town (Old Town) was laid out on the opposite side of Jones's Falls, and in 1745 these two towns were consolidated. About the same time the resources of the interior, for which Baltimore was to become a trade centre, were being rapidly developed by the Germans. Prior to 1752, in which year there were only twenty-five houses with two hundred inhabitants, the growth of the city had indeed been slow; but only a year or two later wheat loaded in its harbour was for the first time shipped to Scotland; during the war between the French and the English at this time some of the unfortunate Acadians found new homes here; in 1767 Baltimore was made the county seat; by the beginning of the War of Independence its population had grown to 6755; and in 1780 it was made a port of entry. The city early became an important shipping centre; during both the War of Independence and the War of 1812 many privateers were sent out from it, and in the interval between these wars, the ship-owners of Baltimore had their share in the world's carrying trade, the "Baltimore clippers" becoming famous. In 1797 Baltimore received its first charter, having been governed until then from Annapolis and through commissions with very limited powers; at the same time the Fells' Point settlement, founded about 1730 by William Fells, a ship carpenter, was annexed. During the War of Independence, the Continental Congress, frightened from Philadelphia in 1776, sat for several weeks in a hall in W. Baltimore Street near Liberty Street; during the same war also fortifications were first erected on the site of the present Fort M'Henry. This fort effectively protected the city in 1814 when attacked by the British, and it was during the attack that Francis Scott Key, detained on one of the British attacking vessels, composed the "Star Spangled Banner." In 1860 all three of the candidates opposed to Lincoln—Douglas, Breckinridge and Bell—were nominated here, and here in 1864 President Lincoln was nominated for a second term. The city has been the meeting-place of other important conventions, and is sometimes called "The Convention City." At the outbreak of the Civil War on the 19th of April 1861, the Sixth Massachusetts regiment, while passing through Baltimore, was attacked by a mob and several men were killed on both sides; in the following month the city was subjected to military rule and so continued until the close of the war. From 1856 to 1860 Baltimore was under the control of the American or Know-Nothing party, and suffered greatly from election riots and other disorders, until as a remedy the control of the police system was taken from the mayor and council and exercised by the state government. Soon after the Civil War a Democratic "machine" got firm control of the city,

and although a struggle to overthrow the machine was begun in earnest in 1875 by a coalition of the reform element of the Democratic party with the Republican party, it was not till 1895 that the coalition won its first decisive victory at the polls. Even then the efforts of the Republican mayor were at first thwarted by the council, which passed an ordinance over his veto, taking from him the power of appointment and vesting it in themselves; the Maryland court of appeals, however, soon decided that the council had exceeded its powers, and an important outcome of the reform movement was the new charter of 1898. Annexations of suburban territory in 1888 and 1890 greatly increased the area of the city.

AUTHORITIES.—J. H. Hollander, *Guide to the City of Baltimore* (Baltimore, 1893); T. P. Thomas, "The City Government of Baltimore" (in *Johns Hopkins University Studies in Historical and Political Science*, Baltimore, 1896); St G. L. Siousat, "Baltimore, the Monumental City" (in L. P. Powell, *Historic Towns of the Southern States*, New York, 1900); J. T. Scharf, *Chronicles of Baltimore* (Baltimore, 1874).

BALTZAR, THOMAS (c. 1630—1663), German violinist, was born at Lübeck. He visited England in 1656 and made a great impression on Evelyn and Anthony Wood. In 1661 he was appointed leader of the king's famous band of twenty-four violins, but his intemperate habits cut short his career within two years. Nothing like his violin-playing had ever been heard in England before, and in all probability the instrumental music of Henry Purcell owes much to its influence.

BA-LUBA, a Bantu negroid race with several subdivisions; one of the most important and cultivated peoples of Central Africa. They are distributed over eight degrees of longitude between Lakes Tanganyika, Mweru and Bangweulu in the east, and the Kasai in the west. In the east, where they are found in the greatest racial purity, they founded the states of Katanga, Urua and Uguha; in the west they have intermixed to some extent with the Ba-Kete aborigines, whom they have partially dispossessed, dividing them into two portions, one to the north, the other to the south. To the western Ba-Luba the name Ba-Shilange has been given. With the Ba-Luba are connected the founders of the great Lunda empire—now divided between Belgian Congo and Angola—ruled by a monarch entitled Muata Yanvo (Jamvo). The westward movement of the Ba-Luba took place in comparatively recent times, the end of the 18th century or the beginning of the 19th. Shortly afterwards a chief named Kalamba Mukenge founded a large state. There followed in 1870 a remarkable politico-religious revolution, the result of which was the establishment of a cult of hemp-smoking, connected with a secret society termed *Bena Riamba*; the members of this abandoned their old fetish worship and adopted a form of communism of which the central idea was the blood-brotherhood of all the members. Towards the east hemp-smoking becomes less common.

The Ba-Luba practise circumcision and scar-tattooing is common; tooth-filing is very frequent in the east, though in the west it is comparatively rare; the fashion of dressing the hair is very varied and often extremely fantastic. Their houses, which are built by the women, are rectangular; on the Lulua, however, pile-houses, square in shape, are found. They are an agricultural people, but work in the fields is relegated to the women and slaves; the men are admirable craftsmen and are renowned for their wood-carving, cloth-weaving and iron-work. In the west, bows and arrows are the chief weapons, in the east spears principally are used. The old form of religion still obtains in the east, which was untouched by the communistic movement mentioned, and charms of all sorts, as well as carved anthropomorphic figures, are extremely common. The Ba-Luba are a fine race physically and seem very prosperous, though in the extreme west considerable deterioration, physical, moral and cultural, has taken place.

BALUCHISTAN, a country within the borders of British India which, like Afghanistan, derives its name from its dominant race of inhabitants. It extends from the Gomal river to the Arabian Sea, and from the borders of Persia and Afghanistan to those of the Punjab and Sind. It is divided into two main

divisions, British Baluchistan, which is a portion of British India under the chief commissioner, and the foreign territories under the administration or superintendence of the same officer as agent to the governor-general. The former portion, with an area of 9403 sq. m., consists principally of tracts ceded to the British government by Afghanistan under the treaty of Gandamak (1879), and formally declared to be part of British India in 1887. The second class comprises three subdivisions, namely areas directly administered, native states and tribal areas. The directly-administered districts include areas acquired in various ways. Some portions are held on lease from the Khan of Kalat; while others are tribal areas in which it has been decided for various reasons that revenue shall be taken. They include the whole of the Zhoob and Chagai political agencies, the eastern portion of the Quetta tahsil and other tracts, among which may be mentioned the Bolan Pass, comprising 36,401 sq. m. in all. The whole of the northern boundary, with the north-eastern corner and the railway which traverses Baluchistan through Quetta up to New Chaman on the Afghan-Baluch frontier, is therefore in one form or other under direct British control. The remainder of the territory (79,382 sq. m.) belongs to the native states of Kalat (including Makran and Kharan) and Las Bela. Tribal areas, in the possession of the Marri and Bugti tribes, cover 7129 sq. m.

Baluchistan as a whole is a sparsely populated tract covering a larger area than any Indian province save Burma, Madras and Bengal. Three hundred miles of its mountain walls facing the Indus are south of the railway from the Indus to Quetta, and about 250 north of it. The railway with the passes and plains about it, and the dominant hills which surround Quetta, divide Baluchistan into two distinct parts. North of the railway line, hedged in between Afghanistan and the plains of the Indus, stretch the long ridges of rough but picturesque highlands, which embrace the central ranges of the Suliman system (the prehistoric home of the Pathan highlander), where vegetation is often alpine, and the climate clear and bracing and subject to no great extremes of temperature. The average breadth of this northern Pathan district is 150 m., but it narrows to less than 100 m. on the line of the Gomal, and expands to more than 200 m. on the line of the railway. Here all the main drainage either runs northwards to the Gomal, passing through the uplands that lie west of the Suliman Range; or it gathers locally in narrow lateral valleys at the back of these mountains and then bursts directly eastwards through the limestone axis of the hills, making for the Indus by the shortest transverse route. South of the railway lies a square block of territory, measuring roughly 300 m. by 300, primarily the home of the Brahui and the Baluch; but within that block are included almost, every conceivable phase of climate and representatives of half the great races of Asia. Here, throughout the elevated highlands of the Kalat plateau which are called Jalawan, the drainage gathers into channels which cut deep gorges in the hills, and passes eastwards into the plains of Sind. Beyond and south of the hydrographical area of the Jalawan highlands the rivers and streams of the hills either run in long straight lines to the Arabian Sea, north of Karachi, or, curving gradually westwards, they disappear in the inland swamps which form so prominent a feature in this part of south-west Asia. A narrow width of the coast districts collects its waters for discharge into the Arabian Sea direct. This section includes Makran. Baluchistan thus becomes naturally divided into two districts, north and south, by an intervening space which contains the Sind-Pishin railway. This intervening space comprises the wedge-shaped desert of Kach Gandava (Gandava), which is thrust westwards from the Indus as a deep indentation into the mountains, and, above it, the central uplands which figure on the map as "British Baluchistan"—where lies Quetta. All Baluchistan has now been surveyed. From the great Indus series of triangles bases have been selected at intervals which have supported minor chains of triangulation reaching into the heart of the country. These again have been connected by links of more or less regularity, so that, if the Baluchistan triangulation lacks the rigid accuracy of a "first

class" system, it at least supports good topography on geographical scales.

From Domandi, at the junction of the Gomal and Kunder rivers, the boundary between Baluchistan and Afghanistan follows the *Northern*. Kunder stream for about 40 m. to the south-west. It then leaves the river and diverges northwards, so as to include a section of the plain country stretching away towards Lake Ab-i-Istada, before returning to the skirts of the hills. After about 100 m. of this divergence it strikes the Kadamir river, turning the northern spurs of the Toba plateau (the base of the Kwaja Amran (Kojak) Range, and winds through the open plains west of the Kojak. Here, however, the boundary does not follow the river. It deserts it for the western edge of the Toba plateau (8000 ft. high at this point), till it nears the little railway station of New Chaman. It then descends to the plains, returns again to the hills 40 m. south of Chaman, and thenceforward is defined by hill ranges southwards to Nushki. The eastern boundary of this northern section of Baluchistan is the "red line" at the foot of the frontier hills, which defines the border of British India. This part of Baluchistan thus presents a buffer system of independent tribes between the British frontier and Afghanistan. But the independence of the Pathan people south of the Gomal is not as the independence of the Pathans (Waziris, Afridis, &c.) who live north of it. It is true that the Indian government interferes as little with the internal jurisdiction of the tribal chiefs amongst the Pathans of the Suliman Range as it does with that of the northern chiefs; but the occupation of a line of posts on the Zhub river, which flanks that range almost from end to end on the west, places the doors of communication with Afghanistan in British hands, and gives command of their hills. It thus tends to the maintenance of peace and order on the southern frontier to a degree that does not exist in the north.

The central range of the Suliman hills is the dominant feature in the geography of northern Baluchistan. The central line or axis of the range lies a little east of the meridian of 70° E., and it is geologically composed of one or more great folds of the Cretaceous series. Towards the northern extremity of the range occur a group of peaks, which together form an oblong block or "massif" amongst the neighbouring ridges known as "Kaisargarh" amongst the Sherani clansmen who occupy it; and as the "Takht-i-Suliman" (Solomon's throne), generally, on the frontier, from the fact of a cherted shrine of that name existing near its southern abutment. The massif of the Takht is a high tableland (about 8000 ft. above sea-level), bounded on its eastern and western edges by high, rugged and steep parallel ridges. The western ridge culminates on the north in the peak of Kaisargarh (11,300 ft.), and the eastern in a block, or detached headland, on the south, where rests the immortal "zirat" or shrine (11,070 ft.). This tableland is formed by a huge cap of coral limestone, estimated by Griesbach at from 4000 to 5000 ft. in thickness. At each end the tableland is rent by gorges which deepen, amidst stupendous precipices, to the channel of the Draband or "Gat" on the north, and of the Dhana on the south. These two channels carry the rush of mountain streams from the western slopes of the massif right across the axis of the mountains and through the intervening barrier of minor ridges to the plains of the Indus. The plateau is covered with a fairly thick growth of the chilghosa or "edible" pine, and a sprinkling of juniper, on the higher slopes. It was ascended and surveyed for the first time in 1883.

From the summit of the Kaisargarh peak a magnificent view is obtained which practically embraces the whole width of northern Baluchistan. Westwards, looking towards Afghanistan, lie upon line of broken jagged ridges and ranges, folds in the Cretaceous series overlaid by coarse sandstones and shales, follow each other in order, preserving their approximate parallelism until they touch the borders of Baluchistan. Immediately on the west of the Kaisargarh there towers the Shingarh Mountain, a geological repetition of the Kaisargarh, and crowned with pine-trees and a crown of crags of coral limestone. Beyond it are the grey outlines of the close-packed ridges which enclose the lower reaches of the Zhub and the Kunder. As they pass away southwards this grid-iron formation strikes with a gentle curve westwards, the narrow enclosed valleys widening out towards the sources of the rivers, where ages of denudation have worn down the folds and filled up the hollows with fruitful soil, until at last they touch the central water-divide, the key of the whole system, on the Quetta plateau. Thus the upper parts of the Zhub valley are comparatively open and fertile, with flourishing villages, and a cultivation which has been greatly developed under British rule, and are bounded by long, sweeping, gentle spurs that lead to the plains of the Indus by means of immense steps. The lower reaches of the Zhub and Kunder are hemmed in by rugged limestone walls, serrated and banded with deep clefts and gorges, a wilderness of stony desolation. Looking eastwards from the Kaisargarh, one can again count the backs of innumerable minor ridges, smaller wrinkles or folds formed during a process of upheaval of the Suliman Mountains, at the close of a great volcanic epoch which has hardly yet ceased to give evidence of its existence. On the outside edge, facing the Indus plains, is a more strictly regular, but higher and more rugged, ridge of hills which marks the Siwaliks. The Baluch Siwaliks afford us strange

glimpses into a recent geological past, when the same gigantic mammals roamed along the foot of these wild hills as once inhabited the tangled forests below the Himalaya. Between the Takht-i-Suliman and the Siwaliks, the intervening belt of ridge and furrow has been greatly denuded by transverse drainage—a system of drainage which we now know to have existed before the formation of the hills, and to have continued to cut through them as they gradually rose above the plain level. Where this intervening band is not covered by recent gravel deposits, it exhibits beds of limestone, clays and sandstone with fossils, which, in age, range from the Lower Eocene to the Miocene. Beyond the Siwaliks, still looking eastwards, are the sand waves of the Indus plain; a yellow sea broken here and there with the shadow of village orchards and the sheen of cultivation, extending to the long black sinuous line which denotes the fringe of forest bordering the Indus. Such is the scene which Solomon is said to have invited his Indian bride to gaze upon for the last time, as they rested on the crags of the southern buttress of the Takht—where his shrine exists to this day. To that shrine thousands of pilgrims, Mahomedans and Hindus alike, resort on their yearly pilgrimages, in spite of its dangerous approach. All this country, so far, is independent Baluchistan within the jurisdiction of the Baluchistan Agency, with the exception of certain clans of the Sheranis on the eastern slopes of the Takht-i-Suliman, north of the Vihova, who are under the North-West Frontier Province administration. Wedged in between the railway and the Indus, but still north of the railway, is a curious mass of rough mountain country, which forms the southern abutment of the Suliman system. The strike of the main ridges forming that system is almost due north and south till it reaches its 30° N. lat. Here it assumes a westerly curve, till it points north-west, and finally merges in the broad band of mountains which hedge in the Quetta and Pishin uplands on the north and east.

At this point, as might be expected, are some of the grandest peaks and precipices in Baluchistan. Khalifat on the east of Quetta, flanking the Harnai loop of the Sind-Pishin railway; Takatu to the north; Chahiltan (Chiltan) on the south-west; and the great square-headed Murdar to the south—all overlook the pretty cantonment from heights which range from 10,500 to 11,500 ft. Lying in the midst of them, on an open plain formed by the high-level tributaries of the Lora (which have also raised the Pishin valley to the north), 5500 ft. above the sea, is Quetta. The mass of twisted flexures, the curious east-west line of the Suliman system, is occupied by true Baluchis, the Marri and Bugri sections of the great Ring, a combination of tribes owning an Arabic origin. There are no Pathans here. To the north of them are the Bozdar, another Rind clan; and these Rind tribes form the exception to the general rule of Pathan occupation of northern Baluchistan. Amongst the Pathans, the Kakars and Dumars of Pishin, with the Mando Kluel of Zhub, are the most prominent tribal divisions.

The curved recession of the Suliman Ranges to the north-west leaves a space of flat alluvial desert to the south, which forms a sort of inlet or bay striking into the Baluchistan mountain **Central** system. The point of this desert inlet receives the drainage of two local basins, the Bolan and the Nari. Both drain south-eastward from the central Quetta-Pishin plateau and both have served for railway alignment. Being fed by tributaries which for the most part drain narrow valleys where gradual denudation has washed bare the flat-backed slopes of limestone ridges, and which consequently send down torrents of rapidly accumulating rainfall, both these central lines of water-course are liable to terrific floods. The drainage of the Bolan and Nari finally disappears in the irrigated flats of the alluvial bay (Kach Gandava), which extends 130 m. from the Indus to Sibi at the foot of the hills, and which offers (in spite of periodic Indus floods) an opportunity for railway approach to Baluchistan, such as occurs nowhere else on the frontier. Kach Gandava, whilst its agricultural development has in no way receded, is now rivalled by many of the valleys of the highlands. Its climate is so hot in summer, and so cold in winter, that it is a land of dust-storms and poisonous winds; a land where the thermometer never sinks below 100° F. in summer, and drops below freezing-point in winter; where there is a deadly monotony of dust-coloured scenery for the greater part of the year, with the minimum of rain and the maximum of heat. The Quetta and Pishin plateau to which it leads is the central dominant water-divide of Baluchistan and the base of the Kandahar highway.

An irregularly-shaped block of upland territory, which includes all the upper Lora tributaries, and the Toba plateau beyond them; resting on the Kwaja Amran (Kojak) Range (with an **British** advanced loop to include the Chaman railway terminus) on the west; reaching south through Sherardul to Nushki; including the basins of the Bolan and Nari as far as Sibi to the south-east; stretching out an arm to embrace the Thal Chotial valley on the east, and following the main water-divide between the Zhub and Lora on the north, is called British Baluchistan. It is leased from Kalat, and forms a distinctive province, being brought under the ordinary forms of civil administration in British India. Beyond it, north and south, lies independent Baluchistan, which is under British political control. Its administrative staff is usually composed of military officers. The degree of independence enjoyed by the various districts of Baluchistan may be said to vary in direct proportion to their

distance from Quetta. No part of Baluchistan is beyond the reach of the political officer, but there are many parts where he is not often seen. The climate of British Baluchistan is dry and bracing—even exhilarating—but the extremes of temperature lead to the development of fever in very severe forms. On the whole it is favourable to European existence.

South-west of the dividing railway lies the great block of Southern Baluchistan. Within this area the drainage generally takes to the south.

Southern.—The west of the Arabian Sea, or to the central swamps of Lora and Mashkel. The Hab river, which forms the boundary west of Karachi; the Purali (the ancient *Arabus*), which drains the low-lying flats of Las Bela; the Hingol (the ancient *Tomurus*) and the Dasht, which drain Makran, are all considerable streams, draining into the Arabian Sea and forming important arteries in the network of internal communication. An exception to the general rule is found in the Mulla, which carries the floods of the Kalat highlands into the Gandava basin and forms one of the most important of the ancient highways from the Indus plains to Kandahar. The fortress of Kalat is situated about midway between the sources of the Bolan and the Mulla, near a small tributary of the Lora (the river of Pishin and Quetta), about 6800 ft. above sea-level, on the western edge of a cultivated plain in the very midst of hills. (See KALAT.) To the north are the long sweeping lines of the Sarawan ridges, enclosing narrow fertile valleys, and passing away to the south-west to the edge of the Kharan desert. East and south are the rugged bands of Jalawan, amongst which the Mulla rises, and through which it breaks in a series of magnificent defiles in order to reach the Gandava plain. Routes which converge on Kalat from the south pass for the most part through narrow mountain valleys, enclosed between steep ridges of denuded hills, and, following the general strike of these ridges, they run from valley to valley with easy grades. Kalat is the "hub" or centre, from which radiate the Bolan, the Mulla and the southern Lora affluents; but the Lora drains also the Pishin valley on the north; and the two systems uniting in Shorawak, to lose themselves in the desert and swamps to the west of Nushki, on the road to Seistan. Sixty miles south of Kalat, and beyond the Mulla sources, commences another remarkable hydrographic system which includes all southern and south-western Baluchistan. To the west the Kharan and the intermittent river channels enclosed and often lost in sand-waves ere they reach the Mashkel swamps on the far borders of Persia. To the south-west are the long sweeping valleys of Rakshan and Panjur, which, curving northwards, likewise discharge their drainage into the Mashkel. Directly south are the beginnings of the meridional arteries, the Hab, the Purali and the Hingol, which end in the Arabian Sea, leaving a space of mountainous seaboard (Makran) south of the Panjur and west of the Hingol, which is watered (so far as it is watered at all) by the long lateral Kej river and several smaller tributaries. Thus the southern Baluchistan comprises four hydrographical systems. First is the long extension from Kalat, southwards, of that inconceivably wild highland country which faces the desert of Sind, the foot of which forms the Indian frontier. This is the land of the Brahui, and the flat wall of its frontier limestone barrier is one of the most remarkable features in the configuration of the whole line of Indian borderland. For the first 60 m. from the sea near Karachi the Hab river is the boundary of Sind, and here, across the enclosing desolation of outcropping ridges and intervening sand, a road may be found into Makran. But from the point where the boundary leaves the Hab to follow the Kharan coast to a break in the line (one) in 150 m. of solid rock wall, there may be thousands of feet straight from the sandy plain. The one break, or gorge, which allows the Kej waters to pass, only forms a local gateway into a mass of impracticable hills. Secondly, to the west of this mountain wilderness, stretching upwards from the sea in a wedge form between the Brahui highlands and the group of towering peaks which enclose the Hingol river and abut on the sea at Malan, are the alluvial flats and delta of the Purali, forming the little province of Las Bela, the home of the Las Rajput. In this hot and thirsty corner of Baluchistan, ruled by the Jam or Cham, there is a fairly wide stretch of cultivation, nourished by the alluvial detritus of the Purali and well irrigated. In a little garden to the south of the modern town of Bela (the ancient *Armedel*) is the tomb of Sir Robert Sandeman, who spent the best part of an energetic and active life in the making of Baluchistan.

The boundary between Baluchistan and Afghanistan, starting from Nushki, cuts across the Lora hamun, leaving the frontier post of Chagai to Baluchistan, and from this point to the

Western boundary. Malik Shah Koh it is based partly on the central mountainous water-divide already referred to, and partly runs in straight lines through the hills south of the low swamps of the Gaud-i-Zirreh. It thus passes 50 m. to the south of the Helmund, entirely shutting off that valley and the approach to Seistan between the Helmund and the Gaud-i-Zirreh (the only approach from the east in seasons of flood) from Baluchistan. But it leaves a connected line of desert route between Nushki and Seistan, which is open in all ordinary seasons, to the south, and this route has been largely developed, posts or serais having been established at intervals and wells having been dug. There is already a promising khafia traffic along it and the railway has been extended from Quetta to Nushki.

Geology.—The mountain ranges of Baluchistan consist chiefly of Cretaceous and Tertiary beds, which are thrown into a series of folds running approximately parallel to the mountain ridges. The folds are part of an extensive system arranged as if in a festoon hanging southwards between Peshawar and Mount Ararat, but with the outer folds looped up at Sibi so as to form the subsidiary festoon of the Suliman and Bugti Hills. Outside the folds lie the horizontal deposits of the Makran coast, and within them lies the stony desert of north-western Baluchistan. In the broader depressions between the mountain ridges the beds are said to be but little disturbed. Besides the Cretaceous and Tertiary beds, Jurassic rocks are known to take a considerable part in the formation of the hills of British Baluchistan. Triassic beds lie along the south side of the upper Zhoib, and *Fusulina* limestone has also been found there. With the exception of the later Tertiary beds the deposits are mostly marine. But in the upper Cretaceous and lower Tertiary, especially in north-western Baluchistan, there is an extensive development of volcanic tufts and conglomerates, which are probably contemporaneous with the Deccan Traps of India. Great masses of syenite and diorite were intruded during the Tertiary period, and with the curve of the folded belt a line of recent volcanic cones stretches from western Baluchistan into eastern Persia. In Baluchistan these volcanoes appear to be extinct; though the Koh-i-Tafdan, beyond the Persian frontier, still emits vapours at frequent intervals. The lavas and ashes which form these cones are mostly andesitic. Mud "volcanoes" occur upon the Makran coast, but it is doubtful whether these are in any way connected with true volcanic agencies.

So far as is known, the mineral wealth of Baluchistan is inconsiderable. Coal has been worked in the Tertiary beds along the Hamrai route to Quetta, but the seams are thin and of quality poor. A somewhat thick and viscid form of mineral oil is met with at Khattan in the Marri country; and petroleum of excellent quality has been found in the Sherani hills and probably occurs in other portions of the Suliman Range. Sulphur has long been worked on a small scale in the Koh-i-Sultan, the largest of the volcanoes of western Baluchistan.

Races.—Within the Baluchistan half of the desert are to be found scattered tribes of nomads, called Rekis (or desert people), the Mohamadani being the most numerous. They are probably of Arab origin. This central desert is the Kir, Kej, Katz or Kash Kaian of Arabic medieval geography and a part of the ancient Kaiani kingdom; the prefix Kej or Kach always denoting low-level flats or valleys, in contradistinction to mountains or hills. The Mohamadani nomads occupy the central mountain region, to the south of which lie the Mashkel and Kharan deserts, inhabited by a people of quite different origin, who possess something approaching to historical records. These are the Naushirwanis, a purely Persian race, who passed into Baluchistan within historic times, although the exact date is uncertain. The Naushirwanis appear to be identical with the Tahuki or Tahukani who are found in Perso-Baluchistan. (A place Taoc is mentioned by Nearchus, by Strabo and by Ptolemy.) They are a fine manly race of people, in many respects superior to their modern compatriots of Iran. Between the Naushirwanis of the Kharan desert and Mashkel, and the fish-eating population of the coast, enclosed in the narrow valleys of the Rakshan and Kej tributaries, or about the sources of the Hingol, are tribes innumerable, remnants of races which may be recognized in the works of Herodotus, or may be traced in the records of recent immigration. Equally scattered through the whole country, and almost everywhere recognizable, is the underlying Persian population (Tajik), which is sometimes represented by a locally dominant tribe, but more frequently by the agricultural slave and bondsmen of the general community. Such are the Dehwaris or Dehkanis, and the Durzadas (*Derusiaci* of Herod. i. 125), who extend all through Makran, and, as slaves, are called Nakibs. The Arabs have naturally left their mark most strongly impressed on the ethnography of Baluchistan. All Rind tribes claim to be of Arab origin and of Korahish extraction. As the Arabs occupied all southern Baluchistan and Seistan from a very early date, and finally spread through the Sind valley, where they remained till the 12th century, their genealogical records have become much obscured and it is probable that there is not

¹ See W. T. Blanford, "Geological Notes on the Hills in the neighbourhood of the Sind and Punjab Frontier between Quetta and Dera Ghazi Khan," *Mem. Geol. Surv. India*, vol. xx, pt. 2 (1883); E. Vredenburg, "A Geological Sketch of the Baluchistan Desert, and part of Eastern Persia," *Mem. Geol. Surv. India*, vol. xxxi, pt. 2 (1901); E. Vredenburg, "On the Occurrence of a Species of Halorites in the Trias of Baluchistan," *Rec. Geol. Surv. India*, vol. xxxi, (1904), pp. 162-166, pls. 17, 18.

now a pure Arab in the country. It is as builders or engineers that they have established their most permanent records, Makran being full of the relics of their irrigation works constructed in times when the climatic conditions of Baluchistan must have been very different from what they are now. Lower Sind also contains a great wealth of architectural remains, which may be found to the west of the Indus as well as in the delta. One particular tribe (the Kalmats), who left their name on the Makran coast and subsequently dominated Bela and Sind, west of the Indus, for a considerable period, exhibit great power of artistic design in their sepulchral monuments. The Dravidian races (Brahuis), who are chiefly represented by the Kambaranis and Mingals or Mongals (the latter are doubtless of Tatar origin), spread through southern Baluchistan as well as the eastern hills, and are scattered irregularly through the mountain tracts south of Kharan. The ancient Oreitae mentioned by Arrian are probably represented by the tribe of Hot, who, as original masters of the soil, are exempt from taxation. The name Brahui is (according to Bellow) but a corruption of Ba-rohi (or "hillmen") in a language derived from Sanskrit which would represent the same term by Parva-ka. So that the Παρβακίαιος (Herod. iii. 92) may be recognized as surviving in the Brahui, and in the name (Parkan) of a mountain-bred stream which is a tributary of the Hingol. Amongst other aboriginal tribes to whom reference is made by very early writers are the Bolédi, who give their name to the Bolida valley, a tributary of the Kej. The Bolédi were once the ruling race of southern Baluchistan, which was originally called Boledistan, and it seems possible that this may be the real origin of the much-disputed name of the country generally. Bola was an Assyrian term for Bael or Bel, the god of the Phoenicians and Druids. The Bolédi ruling family were in 1906 represented by but one living member, a lady, who was a government pensioner. The fast-diminishing Sajidis (Sajittae) and Saka (Sacaë) are others of the more ancient races of Baluchistan easily recognizable in classical geography. Most recent of all are the Gitckhis. The Gitckhis derive from a Rajput adventurer who flourished in the early part of the 17th century. They are now the dominant race in Panjgur and Kej, from whence they ousted the Bolédis. For three generations they remained Hindus; since then there has arisen amongst them a strange new sect called Zikari, with exceedingly loose notions of morality. The sect, however, appears to be fast merging into orthodox Mahomedanism. A Baluch (or rather Makran) race which deserves attention is that of the Gadaras, who once gave the name Gadoria to Southern Baluchistan. According to Tate the Gadaras are now represented by Sidi half-castes—those Makrani "boys" who are so well known in the mercantile marine as stokers and firemen. It seems unlikely that this modern admixture of Asiatic and African blood represents the "Asiatic Ethiopian" of Herodotus, which was more probably a direct connexion of the Himyaritic Arab builders of "bunds" and revetments who spread eastwards from Arabia. Bellow finds in the Gadora the Garuda (eagles) of Sanskrit, who were ever in opposition to the Naga (snakes) of Scythian origin. Southern Baluchistan affords a most interesting field for the ethnographer. It has never yet been thoroughly explored in the interests of ethnographical science.

The Baluch character is influenced by its environment as much as by its origin, so that it is impossible to select any one section of the general community as affording a satisfactory sample of popular Baluch idiosyncrasies. They are not a homogeneous race. Peoples of Arab extraction intermixed with people of Dravidian and Persian stock are all lumped together under the name of Baluch. The Marri and Bugti tribes, who occupy the most southern buttresses of the Suliman Mountains, are Rind Baluchis, almost certainly of Arab extraction. They came to Sind either with the Arab conquerors or after them, and remained there mixed up with the original Hindu inhabitants. The Arab type of Baluch extends through the whole country at intervals, and includes all the finest and best of Baluch humanity. Taking the Rind Baluch as the type opposed to the Afridi Pathan, the Baluch is easier to deal with and to control than the Pathan, owing to his tribal organization and his freedom from bigoted

fanaticism or blind allegiance to his priest. The Baluch is less turbulent, less treacherous, less bloodthirsty and less fanatical than the Pathan. His frame is shorter and more spare and wiry than that of his neighbour to the north, though generations have given to him too a bold and manly bearing. It would be difficult to match the stately dignity and imposing presence of a Baluch chief of the Marri or Bugti clans. His Semitic features are those of the Bedouin and he carries himself as straight and as loftily as any Arab gentleman. Frank and open in his manners, fairly truthful, faithful to his word, temperate and enduring, and looking upon courage as the highest virtue, the true Baluch of the Derajat is a pleasant man to have dealings with. As a revenue payer he is not so satisfactory, his want of industry and the pride which looks upon manual labour as degrading making him but a poor husbandman. He is an expert rider; horse-racing is his national amusement, and the Baluch breed of horses is celebrated throughout northern India. Like the Pathan he is a bandit by tradition and descent and makes a first-rate fighting man, but he rarely enlists in the Indian army. He is nominally a Mahomedan, but is neglectful of the practices of his religion. The relations of the modern Baluch with the government of India were entirely transformed by the life work of Sir Robert Sandeman (q.v.).

The strategic position of Great Britain in Baluchistan is a very important factor in the problem of maintaining order and good administration in the country. The ever-restless Pathan tribes of the Suliman hills are held in check by the occupation of the Zhub valley; whilst the central dominant position at Quetta safeguards the peace and security of Kalat, and of the wildest of the Baluch hills occupied by the Marris and Bugtis, no less than it bars the way to an advance upon India by way of Kandahar. Nominally all the provinces and districts of Baluchistan, with the exception of the ceded territory which we call British Baluchistan, are under the khan of Kalat, and all chiefs acknowledge him as their suzerain. But it may be doubted if this suzerainty was ever complete, or could be maintained at all but for the assistance of the British government. The Baluch is still essentially a robber and a raider (a trait which is common to all tribes), and the history of Baluchistan is nothing but a story of successful robberies, of lawless rapine and bloodshed, for which plunder and devastation were accounted a worthy and honourable return.

Extensive changes have taken place in the climatic condition of the country—changes which are some of them so recent as to be noted by surveyors who have found the remains of forests in districts now entirely desiccated. Possibly the ordinary process of denudation and erosion acting on those recent deposits which overlie the harder beds of the older series, may have much to say to these climatic changes, and the wanton destruction of forests may have assisted the efforts of nature; but it is difficult to understand the widespread desiccation of large areas of the Baluch highlands, where evidences of Arab irrigation works and of cultivation still attest to a once flourishing agricultural condition, without appealing to more rapidly destructive principles for the change. There is ample proof throughout the country of alterations of level within recent geologic periods; and there have even been compressions, resulting in a relative rise of the ground, over the crests of anticlinal folds, within historic record. "Proof that this compression is still going on was given on 20th December 1892, when a severe earthquake resulted from the sudden yielding of the earth's crust along what appears to be an old line of fault, west of the Kawaja Amran range, whereby an adjustment took place indicated by a shortening of some 2½ ft. on the railway line which crosses the fault." Nor should the evidences of active volcanic agency afforded by the mud volcanoes of the coast be overlooked. It is probably to climatic changes (whatever their origin may have been), rather than to the effects of tribal disturbances, that the Arab's disappearance from the field of trade and agriculture must be attributed. The total area of Baluchistan is 132,315 sq. m., and its population in 1901 was 914,551. The population is largely nomadic. The fact that so many as 15,000 camels have been counted in the Bolan Pass during one month of the annual Brahui migration indicates the dimensions which the movement assumes. The religion of the country is so overwhelmingly Mahomedan that out of every 100,000 inhabitants 94,403 are Mussulman, and only 4706 Hindus, while the balance is made up by Christians, Sikhs and other denominations. Out of the total number 280 in the houses are literates. The chief languages spoken are vernaculars of Baluchistan, Pushtu, Panjabi, Urdu and Sindhi. The

Strategic interest.

Climate.

Population.

Baluchi language belongs to the Iranian branch of the Aryan sub-family of the Indo-European family. It is divided into two main dialects which are so different that speakers of the one are almost unintelligible to speakers of the other. These two dialects are separated by the belt of Brahui and Sindhi speakers who occupy the Sarawan and Jalawan hills, and Las Bela. Owing probably to the fact that Makran was for many generations under the rule of the Persian kings, the Baluchi spoken on the west of the province, which is also called Makrani, is more largely impregnated with Persian words and expressions than the Eastern dialect. In the latter the words in use for common objects and acts are nearly all pure Baluchi, the remainder of the language being borrowed from Persian, Sindhi and Panjabi. There is no indigenous literature, but many specimens of poetry exist in which heroes and brave deeds are commemorated, and a good many of these have been collected from time to time. The philological classification of the Brahui dialect has been much disputed, but the latest enquiries, conducted by Dr G. A. Grierson, have resulted in his placing it among the Dravidian languages. It is remarkable to find in Baluchistan a Dravidian tongue, surrounded on all sides by Aryan languages, and with the next nearest branch of the same family located so far away as the Gond hills of central India. Brahui has no literature of its own, and such knowledge as we possess of it is due to European scholars, such as Bellew, Trumpp and Caldwell. Numerically the Brahuis are the strongest race in Baluchistan. They number nearly 300,000 souls. Next to them and numbering nearly 200,000 are the Pathans. After this there is a drop to 80,000 mixed Baluchis and less than 40,000 Lasbis (Lurris) of Las Bela. There are thirteen indigenous tribes of Pathan origin, of which the Kakars (q.v.) are by far the most important, numbering more than 100,000 souls. They are to be found in the largest numbers in Zhoib, Quetta, Pishin and Thal-Chotiali, but there are a few of them in Kalat and Chagai also. The most important Baluch tribes are the Marris, the Bughris, the Boledis, the Domkis, the Magassis and the Rinds. Owing partly to the tribal system, and partly to the levelling effect of Islam, nothing similar to the Brahmanical system of social precedent is to be found in Baluchistan.

History—Of the early history of this portion of the Asiatic continent little or nothing is known. The poverty and natural strength of the country, combined with the ferocious habits of the natives, seem to have equally repelled the friendly visits of inquisitive strangers and the hostile incursions of invading armies. The first distinct account which we have is from Arrian, who, with his usual brevity and severe veracity, narrates the march of Alexander through this region, which he calls the country of the Oreitae and Gadrosii.¹ He gives a very accurate account of this forlorn tract, its general aridity and the necessity of obtaining water by digging in the beds of torrents; describes the food of the inhabitants as dates and fish; and adverts to the occasional occurrence of fertile spots, the abundance of aromatic and thorny shrubs and fragrant plants, and the violence of the monsoon in the western part of Makran. He notices also the impossibility of supporting a large army, and the consequent destruction of the greater part of the men and beasts which accompanied the expedition of Alexander. In the 8th century this country was traversed by an army of the Caliphate.

The precise period at which the Brahuis gained the mastery cannot be accurately ascertained; but it was probably about two and a half centuries ago. The last raja of the Hindu dynasty found himself compelled to call for the assistance of the mountain shepherds, with their leader, Kambhar, in order to check the encroachments of a horde of depredators, headed by an Afghan chief, who infested the country and even threatened to attack the seat of government. Kambhar successfully performed the service for which he had been engaged; but having in a few years quelled the robbers against whom he had been called in, and finding himself at the head of the only military tribe in the country, he formally deposed the raja and assumed the government.

The history of the country after the accession of Kambhar is as obscure as during the Hindu dynasty. It would appear, however, that the sceptre was quietly transmitted to Abdulla Khan, the fourth in descent from Kambhar, who, being an intrepid and ambitious soldier, turned his thoughts towards the conquest of Kach Gandava, then held by different petty chiefs under the authority of the nawabs of Sind¹.

After various success, the Kambharanis at length possessed themselves of the sovereignty of a considerable portion of that

fruitful plain, including the chief town, Gandava. It was during this contest that the famous Nadir Shah advanced from Persia to the invasion of Hindustan; and while at Kandahar he despatched several detachments into Baluchistan and established his authority in that province. Abdulla Khan, however, was continued in the government of the country by Nadir's orders; but he was soon after killed in a battle with the forces of the nawabs of Sind. He was succeeded by his eldest son, Haji Mahommed Khan, who abandoned himself to the most tyrannical and licentious way of life and alienated his subjects by oppressive taxation. In these circumstances Nasir Khan, the second son of Abdulla Khan, who had accompanied the victorious Nadir to Delhi, and acquired the favour and confidence of that monarch, returned to Kalat and was hailed by the whole population as their deliverer. Finding that expostulation had no effect upon his brother, he one day entered his apartment and stabbed him to the heart. As soon as the tyrant was dead, Nasir Khan mounted the *musnud* amidst the universal joy of his subjects; and immediately transmitted a report of the events which had taken place to Nadir Shah, who was then encamped near Kandahar. The shah received the intelligence with satisfaction, and despatched a firman, by return of the messenger, appointing Nasir Khan beglar begi (prince of princes) of all Baluchistan. This event took place in the year 1739.

Nasir Khan proved an active, politic and warlike prince. He took great pains to re-establish the internal government of all the provinces in his dominions, and improved and fortified the city of Kalat. On the death of Nadir Shah in 1747, he acknowledged the title of the king of Kabul, Ahmad Shah (Duran). In 1758 he declared himself entirely independent; upon which Ahmad Shah despatched a force against him under one of his ministers. The khan, however, raised an army and totally routed the Afghan army. On receiving intelligence of this discomfiture, the king himself marched with strong reinforcements, and a pitched battle was fought in which Nasir Khan was worsted. He retired in good order to Kalat, whither he was followed by the victor, who invested the place with his whole army. The khan made a vigorous defence; and, after the royal troops had been foiled in their attempts to take the city by storm or surprise, a negotiation was proposed by the king which terminated in a treaty of peace. By this treaty it was stipulated that the king was to receive the cousin of Nasir Khan in marriage; and that the khan was to pay no tribute, but only, when called upon, to furnish troops to assist the army, for which he was to receive an allowance in cash equal to half their pay. The khan frequently distinguished himself in the subsequent wars of Kabul; and, as a reward for his services, the king bestowed upon him several districts in perpetual and entire sovereignty. Having succeeded in quelling a dangerous rebellion headed by his cousin Behram Khan, this able prince at length died in extreme old age in the month of June 1795, leaving three sons and five daughters. He was succeeded by his eldest son, Mahmud Khan, then a boy of about fourteen years. During the reign of this prince, who has been described as a very humane and indolent man, the country was distracted by sanguinary broils; the governors of several provinces and districts withdrew their allegiance; and the dominions of the khans of Kalat gradually so diminished that they now comprehend only a small portion of the provinces formerly subject to Nasir Khan.

In 1839, when the British army advanced through the Bolan Pass towards Afghanistan, the conduct of Mehrab Khan, the ruler of Baluchistan, was considered so treacherous and dangerous as to require "the exaction of retribution from that chieftain," and "the execution of such arrangements as would establish future security in that quarter." General Willshire was accordingly detached from the army of the Indus with 1050 men to assault Kalat. A gate was knocked in by the field-pieces, and the town and citadel were stormed in a few minutes. Above 400 Baluchies were slain, among them Mehrab Khan himself; and 2000 prisoners were taken. Subsequent inquiries have, however, proved that the treachery towards the British was not

¹ See V. A. Smith, *Early Hist. of India* (ed. 1908), p. 103 seq.

on the part of Mehrab Khan, but on that of his vizier, Mahommed Hussein, and certain chiefs with whom he was in league, and at whose instigation the British convoys were plundered in their passage through Kach Gandava and in the Bolan Pass. The treacherous vizier, however, made our too credulous political officers believe that Mehrab Khan was to blame; his object being to bring his master to ruin and to obtain for himself all power in the state, knowing that Mehrab's successor was only a child. How far he succeeded in his object history has shown. In the following year Kalat changed hands, the governor established by the British, together with a feeble garrison, being overpowered. At the close of the same year it was reoccupied by the British under General Nott. In 1841 Nasir Khan II., the youthful son of the slain Mehrab Khan, was recognized by the British, who soon after evacuated the country.

From the conquest of Sind by the British troops under the command of General Sir Charles Napier in 1843 up to 1854 no diplomatic intercourse occurred worthy of note between the British and Baluch states. In the latter year, however, under the governor-generalship of the marquis of Dalhousie, General John Jacob, C.B., at the time political superintendent and commandant on the Sind frontier, was deputed to arrange and conclude a treaty between the Kalat state, then under the chieftainship of Nasir Khan and the British government. This treaty was executed on the 14th of May 1854 and was to the following effect:—

"That the former offensive and defensive treaty, concluded in 1841 by Major Outram between the British government and Nasir Khan II., chief of Kalat, was to be annulled.

"That Nasir Khan II., his heirs and successors, bound themselves to oppose to the utmost all the enemies of the British government, and in all cases to act in subordinate co-operation with that government, and to enter into no negotiations with other states without its consent.

"That should it be deemed necessary to station British troops in any part of the territory of Kalat, they shall occupy such positions as may be thought advisable by the British authorities.

"That the Baluch chief was to prevent all plundering on the part of his subjects within or in the neighbourhood of British territory.

"That he was further to protect all merchants passing through his territory, and only to exact from them a transit duty, fixed by schedule attached to the treaty; and that, on condition of a faithful performance of these duties, he was to receive from the British government an annual subsidy of Rs.50,000 (£5,000)."

The provisions of the above treaty were most loyally performed by Nasir Khan up to the time of his death in 1856. He was succeeded by his brother, Mir Khodadad Khan, when a youth of twelve years of age, who, however, did not obtain his position before he had put down by force a rebellion on the part of his turbulent chiefs, who had first elected him, but, not receiving what they considered an adequate reward from his treasury, sought to depose him in favour of his cousin Sher dil Khan. In the latter part of 1857, the Indian rebellion being at its height and the city of Delhi still in the hands of the rebels, a British officer (Major Henry Green) was deputed, on the part of the British government, to reside as political agent with the Khan at Kalat and to assist him by his advice in maintaining control over his turbulent tribes. This duty was successfully performed until 1863, when, during the temporary absence of Major Malcolm Green, the then political agent, Khodadad Khan was, at the instigation of some of his principal chiefs, attacked while out riding by his cousin, Sher dil Khan, and severely wounded. Khodadad fled in safety to a residence close to the British border, and Sher dil Khan was elected and proclaimed Khan. His rule was, however, a short one, for early in 1864, when proceeding to Kalat, he was murdered in the Gandava Pass; and Khodadad was again elected chief by the very men who had only the previous year caused his overthrow, and who had lately been accomplices to the murder of his cousin. After the above events Khodadad maintained his precarious position with great difficulty; but owing to his inability to govern his unruly subjects without material assistance from the British government, which they were not disposed to give, his country gradually fell into the greatest anarchy; and, consequently, some of the provisions of the treaty of 1854 having been

broken, diplomatic relations were discontinued with the Kalat state after the end of 1874.

After this the chiefs of Las and Wad, the Marris and Bugtis, Kej and Makran all threw off their allegiance, and anarchy became so widespread that the British government again interfered. The treaty of 1854 was renewed in 1876 by Lord Lytton (under Sandeman's advice), and the khan received substantial aid from the government in the form of an annual subsidy of a lakh of rupees, instead of the Rs. 50,000 previously assigned to him. The treaty of 1854 was a treaty of alliance offensive and defensive. The treaty of 1876 renewed these terms, but utterly changed the policy of non-intervention which was maintained by the former, by the recognition of the sirdars as well as the khan, and by the appointment of the British government as referee in cases of dispute between them. British troops were to be located in the khan's country; Quetta was founded; telegraphs and railways were projected; roads were made; and the reign of law and order established. The nebulous claims of Afghanistan to Sibi and Pishin were disposed of by the treaty of Gandamak in the spring of 1879, and the final consolidation of the existing form of Kalat administration was effected by Sandeman's expedition to Kharan in 1883, and the reconciliation of Azad Khan, the great Naushirvani chief, with the khan of Kalat. British Baluchistan was incorporated with British India by the resolution of 1st November 1887, and divided into two districts—Quetta-Pishin and Thal Chotiali—to be administered by a deputy-commissioner and a regular staff.

In 1890 and 1891 were carried out that series of politico-military expeditions which resulted in the occupation of the Zhoab valley, the foundation of the central cantonment of Fort Sandeman, and the extension of a line of outposts which, commencing at Quetta, may be said to rest on Wana north of the Gomal. The effect of these expeditions, and of this extension of military occupation, has been to reduce the independent Pathan tribes of the Suliman mountains to effective order, and to put a stop to border raiding on the Indus plains south of the Gomal. In 1893 serious differences arose between the khan of Kalat and Sir James Browne, who succeeded Sir Robert Sandeman as agent to the governor-general in Baluchistan, arising out of Mir Khodadad Khan's outrageous conduct in the management of his own court, and the treatment of his officials. Finally, the khan was deposed, and his son Mir Mahmud Khan succeeded in November 1893. Since then the most important change in Baluch administration has been the perpetual lease and transfer of management to British agency of the Nushki district and Niabat, with all rights, jurisdiction and administrative power, in lieu of a perpetual rent of Rs.9,000 per annum. This was effected in July 1899. This secures the direct control of the great highway to Seistan which has been opened to khafla and railway traffic.

The revenues of the khan of Kalat consist partly of subsidies and partly of agricultural revenue, the total value being about Rs.500,000 per annum. Since 1882 he has received Rs.25,000 as government rent for the Quetta district, besides Rs.30,000 in lieu of transit duties in the Boian; this has been increased lately by Rs.9,000 as already stated. In 1899 the total imports of Kalat were valued at Rs.700,000, and the exports at Rs.505,000.

AUTHORITIES.—The Seistan Boundary Report of 1873 by Sir F. Goldsmid; Floyer, *Unexplored Baluchistan* (London, 1882); T. Thorndon, *Life of Sandeman* (London, 1896); G. P. Tate, *Kalat, a Memoir* (Calcutta, 1896); Sir T. Holdich, (*Ethnographic and Historical Notes on Makran*, Calcutta, 1892 (*Survey Report*); "Antiquities, Ethnography, &c. of Las Bela and Makran," Calcutta, 1894 (*Survey Report*); "Ancient and Medieval Makran," vol. vii. *R.G.S. Journal* (1896); "Perso-Baluch Boundary," vol. ix. *R.G.S. Journal* (1897); M'Mahon, "The Southern Borderland of Afghanistan," vol. x. *Journal R.G.S.* (1897). Notes on Sir R. Sandeman's tours in Baluchistan will be found in vols. v., xiii., xii., and xiv. of the *R.G.S. Proceedings*; *Popular Poetry of the Baloches*, by M. Longworth-Dames (2 vols., *Roy. Asi. Soc.* 1907). (T. H. H.)*

BALUCHISTAN, a province of Persia consisting of the western part of Baluchistan (q.v.) in a wider sense. Persian Baluchistan has an area of about 60,000 sq. m., and lying along the northern shore of the Arabian Sea, is bounded E. by British and

independent Baluchistan, N. by Seistan and the central Persian desert, and W. by Kerman. The country has little water and only a small part of it is under cultivation, the remainder being composed of arid, waterless plains, deserts—some stony, others with moving sands—barren hills and mountains. The principal rivers are the Mashkid and that of Bamapur which flow away from the sea and are lost in depressions called *hamuns*. The rivers which flow into the sea are unimportant and dry during the greater part of the year. Persian Baluchistan forms an administrative division of the province of Kerman and is subdivided into the following twenty districts:—(1) Bamapur; (2) Serhad; (3) Dizek; (4) Jalk; (5) Sib; (6) Irafshan; (7) Magas; (8) Serbaz; (9) Lashar; (10) Champ; (11) Fannuj; (12) Bazman; (13) Aptar; (14) Daman; (15) Aprandagan; (16) Asfehgh; (17) Surmij; (18) Meskutan; (19) Pushteh; (20) Makran, the country of the Ichthyophagi, with the sub-districts Kasrkand, Geh, Bint, Dasht, Kucheh and Bahu. The total population of Baluchistan is under 200,000. The province was practically independent until the occupation of Bamapur by Persian troops in 1849, and over some of the extreme eastern districts Persian supremacy was not recognized until 1872.

BALUE, JÉAN (c. 1421–1491), French cardinal and minister of Louis XI., was born of very humble parentage at Angle in Poitou, and was first patronized by the bishop of Poitiers. In 1461 he became vicar-general of the bishop of Angers. His activity, cunning and mastery of intrigue gained him the appreciation of Louis XI., who made him his almoner. In a short time Balue became a considerable personage. In 1465 he received the bishopric of Évreux; the king made him *le premier du grant conseil*, and, in spite of his dissolute life, obtained for him a cardinalate (1468). But in that year Balue was compromised in the king's humiliation by Charles the Bold at Péronne and excluded from the council. He then intrigued with Charles against his master: their secret correspondence was intercepted, and on the 23rd of April 1469 Balue was thrown into prison, where he remained eleven years, but not, as has been alleged, in an iron cage. In 1480, through the intervention of Pope Sixtus IV., he was set at liberty, and from that time lived in high favour at the court of Rome. He received the bishopric of Albano and afterwards that of Palestrina. In 1484 he was even sent to France as legate *à latere*. He died at Ancona in 1491.

See Henri Forgeot, "Jean Balue, cardinal d'Angers" (1895), in the *Bibliothèque de l'école des hautes études*.

BALUSTER (through the Fr. from the Ital. *balauastro*, so-called from a supposed likeness to the flower of the *βαλαστριον*, or wild pomegranate; the word has been corrupted in English into "banister"), a small moulded shaft, square or circular, in stone or wood and sometimes in metal, supporting the coping of a parapet or the rail of a staircase, an assemblage of them being known as a balustrade. The earliest examples are those shown in the bas-reliefs representing the Assyrian palaces, where they were employed as window balustrades and apparently had Ionic capitals. They do not seem to have been known to either the Greeks or the Romans, but early examples are found in the balconies in the palaces at Venice and Verona. In the hands of the Italian revivalists they became features of the greatest importance, and were largely employed for window balconies and roof parapets.

The term "baluster shaft" is given to the shaft dividing a window in Saxon architecture. In the south transept of the abbey at St Albans, England, are some of these shafts, supposed to have been taken from the old Saxon church. Norman bases and capitals have been added, together with plain cylindrical Norman shafts.

BALUSTRADE, a parapet or low screen consisting of a coping or rail supported on balusters (q.v.). Sometimes it is employed purely as a decorative feature beneath the sill of a window which was not carried down to the ground. Sometimes flowing foliage takes the place of the parapet, and sometimes so-called balustrades are formed of vertical slabs of stone, pierced as in the Ca' d'oro at Venice and the balconies of the minarets at Cairo.

BALUZE, ÉTIENNE (1530–1718), French scholar, was born at Tulle on the 24th of November 1630. He was educated at his native town and took minor orders. As secretary to Pierre de Marca, archbishop of Toulouse, he won the appreciation of that learned prelate to such a degree that at his death Marca left him all his papers. Thus it came about that Baluze produced the first complete edition of Marca's treatise *De libertatibus Ecclesiae Gallicanae* (1663), and brought out his *Marca hispanica* (1688 f.). About 1667 Baluze entered Colbert's service, and until 1700 was in charge of the invaluable library belonging to that minister and to his son the marquis de Seignelai. He enriched it prodigiously (see the history of the Colbertine library in the *Cabinet des Manuscrits* by M. Léopold Delisle, vol. i.), and Colbert rewarded him by obtaining various benefices for him, and the post of king's almoner (1679). Subsequently Baluze was appointed professor of Canon law at the Collège de France on the 31st of December 1689, and directed that great institution from 1707 to 1710.

The works which place him in the first rank of the scholars of his time are the *Capitularia Regum Francorum* (1674; new edition enlarged and corrected in 1780); the *Nova Collectio Conciliorum* (4 vols., 1677); the *Miscellanea* (7 vols., 1678–1715; new edition revised by Mansi, 4 vols. i., 1761–1764); the *Letters of Pope Innocent III.* (1682); and, finally, the *Vitae Paparum Avenionensium, 1305–1394* (1693). But he was unfortunate enough to take up the history of Auvergne just at the time when the cardinal de Bouillon, inheritor of the rights, and above all of the ambitious pretensions of the La Tour family, was endeavouring to prove the descent of that house in the direct line from the ancient hereditary counts of Auvergne of the 9th century.

As authentic documents in support of these pretensions could not be found, false ones were fabricated. The production of spurious genealogies had already been begun in the *Histoire de la maison d'Auvergne* published by Christophe Justel in 1645; and Chorier, the historian of Dauphiny, had included in the second volume of his history (1672) a forged deed which connected the La Tours of Dauphiny with the La Tours of Auvergne. Next a regular manufactory of forged documents was organized by a certain Jean de Bar, an intimate companion of the cardinal. These rogues were skilful enough, for they succeeded in duping the most illustrious scholars; Dom Jean Mabillon, the founder of Diplomatics, Dom Thierry Ruinat and Baluze himself, called as experts, made a unanimously favourable report on the 23rd of July 1695. But cardinal de Bouillon had many enemies, and a war of pamphlets began. In March 1698 Baluze in reply wrote a *Letter* which proved nothing. Two years later, in 1700, Jean de Bar and his accomplices were arrested, and after a long and searching inquiry were declared guilty in 1704. Baluze, nevertheless, was obstinate in his opinion. He was convinced that the incriminated documents were genuine and proposed to do Justel's work anew. Encouraged and financially supported by the cardinal de Bouillon, he first produced a *Table généalogique* in 1705, and then in 1709 a *Histoire généalogique de la maison d'Auvergne*, with "Proofs," among which, unfortunately, we find all the deeds which had been pronounced spurious. In the following year he was suddenly engulfed in the disgrace which overtook his intriguing patron: deprived of his appointments, pensions and benefices, he was exiled far from Paris. None the less he continued to work, and in 1717 published a history of his native town, *Historiae Tuleensis libri tres*. Before his death he succeeded in returning to Paris, where he died unconvinced of his errors on the 28th of July 1718. Was he dupe or accomplice? The study of his correspondence with the cardinal gives the impression that he was the victim of clever cheats.

The history of the forgeries committed in the interests of the house of Bouillon forms a curious and instructive episode in the history of French scholarship in the time of Louis XIV. It is to be found in the *Manuel de diplomatique* by A. Giry; and above all in a note to the *Œuvres de Saint-Simon* by M. de Boissière (vol. xiv. pp. 533–558). The bibliography of Baluze's researches has been made by M. René Fage (1882, 1884) and his *Life* told by M. Émile Fage (1899). To these we must add an amusing book by G. Clément-Simon, *La Gaieté de Baluze; documents biographiques et littéraires*

(1888). Baluze's will has been published by M. Léopold Delisle (*Bibliothèque de l'École de Chartres*, 1872); his papers are now in the Bibliothèque Nationale in Paris, and in the Bibliothèque de l' Arsenal (*Revue historique*, t. xviii, p. 309). See also the article by Arthur de Boislesle in the *Revue des questions historiques* for October 1908. (C. B. *)

BALZAC, HONORÉ DE (1790-1850), French novelist, was born at Tours on the 20th of May 1790. His father, Bernard François, never called himself de Balzac and Honoré only assumed the participle after 1830. But the father had equally little right to the name of Balzac at all, for his birth-certificate has been recently discovered. The true name was "Balsas," and this in various forms ("Balsa," "Balsas") has been traced for more than a century before the novelist's birth as that of a family of day-labourers or very small peasant proprietors in the parish of Canezac, department of the Tarn. It is probable that the novelist himself was not aware of this, and his father appears to have practised some mystification as to his own professional career. In and after the Revolution, however, he actually attained positions of some importance in the commissariat and hospital departments of the army, and he married in 1797 Anne Charlotte Laure Sallambier, who was a beauty, an heiress, and a woman of considerable faculty. She survived her son; the father died in 1820. There were two sisters (the elder, Laure, afterwards Madame Surville, was her brother's favourite and later his biographer), and a younger brother, Henri, of whom we hear little and that little not very favourable.

Honoré was put out to nurse till he was four years old, and in 1806, when he was seven, was sent to the *collège* (grammar school) of Vendôme, where he remained till April 1813 as a strict boarder without any holidays. From this he passed as a day-boy to the *collège* of Tours. His father's official work was transferred to Paris the year after, and Balzac came under the teaching of a royalist private schoolmaster, M. Lepitre, and others. He left school altogether in 1816, being then between seventeen and eighteen. His experiences at Vendôme served as base for much of *Louis Lambert*, and he seems to have been frequently in disgrace. Later, his teachers appear to have found him remarkable neither for good nor for evil. He was indeed never a scholar; but he must have read a good deal, and as he certainly had no time for it later, much of this reading must have been done early.

The profession which Balzac's father chose for him was the law; and he not only passed through the schools thereof, and duly obtained his *licence*, but had three years' practical experience in the offices of a notary and a solicitor (*avoué*), for the latter of whom, M. Guillonnet-Merville, he seems to have had a sincere respect. But though no man of letters has ever had, in some ways, such a fancy for business, no man of business could ever come out of such a born man of letters. And when in 1820 (the *licence* having been obtained and M. Balzac, senior, having had some losses) the father wished the son to become a practising lawyer in one or another branch, Honoré revolted. His family had left Paris, and they tried to starve him into submission by establishing him in a garret with a very small allowance. Here he began to write tragedies, corresponded (in letters which have fortunately been preserved) with his sister Laure, and, most important of all, attempted something in prose fiction. The tragedy *Cromwell* was actually completed and read to friends if not to others; nay more, the manuscript exists in the hands of M. Spoelberch de Lovenjoul, the great authority on Balzac's life and bibliography; but it has never been published. The novels, *Cocquignac* and *Stella*, proved abortions, but were only the first of many attempts at his true way until he found it. Drama he never abandoned; but for him it was always an error.

The garret-period from 1820 to 1822 was succeeded by another of equal length at home, but before it had finished (1821) he found his way into print with the first of the singular productions which (and that not entirely or finally) have taken a sort of outside place in his works under the title of *Œuvres de jeunesse*. The *incumbance* of Balzac were *Les Deux Héritiers*, *ou Les Deux Familles bretonnes*, and *Charles Pointel*, *ou Mon Cousin de la main gauche*. They were followed next year by six others:—*L'Héritière de Birague*; *Jean Louis*, *ou La Fille troupée*; *Clotilde de Lusignan*,

ou Le Beau Juif; *Le Centenaire*, *ou Les Deux Beringheld*; *Le Vicaire des Ardennes*; *Le Tartare*, *ou Le Retour de l'exilé*. And these were again followed up in 1823 by three more: *La Dernière Fée*, *ou La Nouvelle Lampe merveilleuse*; *Michel et Christine et la suite*; *L'Anonyme*, *ou Ni père ni mère*. In 1824 came *Annette et le criminel*, a continuation of the *Vicaire*; in 1825, *Wann-Chlore*, which afterwards took the less extravagant title of *Jane la pâle*. These novels, which filled some two score volumes originally, were published under divers pseudonyms ("Lord R'hoone," an anagram of "Honoré," "Horace de Saint Aubin," &c.), and in actual collaboration with two or three other writers. But though there is not yet in them anything more than the faintest dawn of the true Balzac, though no one of them is good as a whole, and very few parts deserve that word except with much qualification, they deserve far more study than they have usually received, and it is difficult to apprehend the true Balzac until they have been studied. They ceased for a time, not because of the author's conviction of their badness (though he entertained no serious delusions on this subject), nor because they failed of a certain success in actual money return, but because he had taken to the earliest, the most prolonged, and the most disastrous of his dabbings in business—this time as a publisher to some extent and still more as a printer and type-founder. Not very much was known about his experiences in this way (except their general failure, and the result in hampering him with a load of debt directly for some ten years and indirectly for the whole of his life) till in 1903 MM. Hanotaux and Vicaire published the results of their inquiries into the actual accounts of the concern. There seems to have been no reason why it should not have succeeded, and there has been claimed for it first, that it provided Balzac with a great amount of actual detail which he utilized directly in the novels, and secondly, that it gave him at whatever cost a still more valuable experience of practical life—the experience which has so often been wanting to men of letters. Anyhow, from 1825 to 1828, the future author of the *Comédie humaine* was a publisher, printer and type-founder; and in the last year he had to abscond, or something like it, under pressure of debts which were never fully settled till 1838, and then by a further obligation of ninety thousand francs, chiefly furnished by his mother and never repaid to her.

It was Balzac's habit throughout his life to relieve the double pressure of debt and of work by frequent excursions into the country and abroad. On this occasion he fled to Brittany where he introduced to a M. and Mme. de Pommereul, who received him hospitably in their château near Fougères. Here he obtained some of the direct material, and most of the scenery and atmosphere, for what he himself recognized as his first serious attempt in novel-writing, *Les Chouans*, or, as it was at first called, *Le Dernier Chouan*. This book (obviously written in direct following of Scott, of whom Balzac was a lifelong admirer) has been very variously judged—those who lay most stress on his realism thinking little of it, while those who maintain that he was always a romantic "with a difference" place it higher. It has at any rate brilliant colouring, some very vivid scenes, and almost more passion as well as "curtain" at its ending than any other of his books. Though not without a touch of melodrama it differs utterly from the confused and tedious imitations of Mrs Radcliffe, M. G. Lewis and C. R. Maturin which fill most of the *Œuvres de jeunesse*. At the same time Balzac was engaged on a very different work, the analytic-satirical sketches which compose the *Physiologie du mariage*, and which illustrate his other and non-romantic side, again with some crudity, but again also with a vast advance on his earlier productions. Both were published in the year 1820, from which his real literary career unquestionably starts. It had exactly twenty-one years to run.

The history of these twenty-one years, though (in consequence mainly of the diligence and luck as a collector of the above-named M. de Lovenjoul) the materials for it are large and constantly accumulating, has never been arranged in a really standard biography, and there seems to be an increasing habit of concentrating the attention on parts of it. It divides itself under three heads mainly, the history of Balzac's business affairs, that

of his loves and friendships and that of his actual work. The first has some small resemblance to Scott's similar experiences, though in Balzac's case there was no great crash but a lifelong pressure; on the other hand, his debts were brought upon him by a long course not so much of extravagance in actual expenditure (though there was something of this) as of financial irregularities of almost every description,—anticipations of earnings, costly methods of production (he practically wrote his novels on a succession of printed revises), speculations, travel, and lastly the collection of curiosities. As regards the second, although his fashion of life made him by turns a hermit and a vagrant, he was on good terms with most of the famous men of letters of his day from Hugo downwards, and seems never to have quarrelled with any man, except with some of his editors and publishers, by his own fault. Balzac was indeed, in no belittling sense of the word, one of the most good-natured of men of genius. But his friendships with the other sex are of much more importance, and not in the least matters of mere gossip. His sister Laure, as has been said, and a school-friend of hers, Mme Zulma Carraud, played important and not questionable parts as his correspondents. But at least three ladies, all of a rank higher than his own, figure as his "Egerias" to such an extent that it is hardly extravagant to say that Balzac would not have been Balzac without them. These are Madame de Berny, a lady connected with the court of the *ancien régime*, much older than himself and the mother of nine children, to whom he was introduced in 1821, who became to him *La dilecta*, who was the original of Mme de Mortsaut in *Le Lys dans la vallée*, and who seems to have exercised an excellent influence on him in matters of taste till her death in 1836; the marquise de Castries, who took him up for a time and dropped him, and who has been supposed to have been his model for his less impeccable ladies of fashion; and lastly, the Polish-Russian countess Evelina Hanska, who after addressing, as *l'Étrangère*, a letter to him as early as 1832, became his idol, rarely seen but constantly corresponded with, for the last eighteen years, and his wife for the last few months of his life. Some of his letters to her have long been known, but the bulk of them constituted the greatest recent addition to our knowledge of him as given in the two volumes of *Lettres à l'étrangère*. Of hers we have practically none and it is exceedingly hard to form any clear idea of her, but his devotion is absolutely beyond question.

Business, friendship and love, however, much more other things, were in Balzac's case always connected with and on the whole quite secondary to work. He would even sometimes resist the commands by which at long intervals Mme Hanska would summon him to see her, and abstract the greater part of his actual visits to her in order to serve this still more absorbing mistress. He had, as we have seen, worked pretty hard, even before 1820, and his work had partly taken forms not yet mentioned—political pamphlets and miscellaneous articles which are now accessible in the *Édition définitive* of his works, and hardly one of which is irrelevant to a just conception of him. Nor did he by any means abandon these by-works after 1829; indeed, he at one time started and almost entirely wrote, a periodical called the *Revue parisienne*. He wrote some dramas and planned many more, though the few which reached the stage left it again promptly. Balzac's dramas, as they appear in his works, consist of *Vautrin*, *Les Ressources de Quinola*, *Pamela Giraud* (arranged for the stage by others), *La Martine* and *Mercadet le faiseur*, the last of which has, since his death, been not unsuccessful. But on the whole he did devote himself to his true vocation, with a furious energy beside which even Scott's, except in his sadder and later days, becomes leisurely. Balzac generally wrote (dining early and lightly, and sleeping for some hours immediately after dinner) from midnight till any hour in the following day—stretches of sixteen hours being not unknown, and the process being often continued for days and weeks. Besides his habit of correcting a small printed original into a long novel on the proofs, he was always altering and re-shaping his work, even before, in 1842, he carried out the idea of building it all into one huge structure—the *Comédie humaine* with its subdivisions of *Scènes de la vie parisienne*,

Études philosophiques, &c. Much pains have been spent upon this title and Balzac's intentions in selecting it. But the "Human Comedy," as a description for mere studies of life as his, will explain itself at once or else can never be explained.

Of its constituents, however, some account must be given, and this can be best done through an exact and complete list of the whole work by years, with such abbreviated notes on the chief constituents as may lead up to a general critical summary. Of the two capital works of 1820, we have spoken. 1830, the epoch year, saw part (it was not fully published till the next) of *La Peau de chagrin*, one of the crudest, but according to some estimates, one of the greatest of the works, full of romantic extravagance and surplussage, but with an engrossing central idea—the Nemesis of accomplished desire—powerfully worked out; *La Maison du chat qui pelote*, a triumph of observation and nature, together with a crowd of things less in bulk but sometimes of the first excellence—*El Verdugo*, *Étude de femme*, *La Poix du ménage*, *Le Bâle de sceaux*, *La Vendetta*, *Gobseck*, *Une Double Famille*, *Les Deux Rôles*, *Adieu*, *L'Élixir de longue vie*, *Sarrazine*, *Une Passion dans le désert* and *Un Épisode sous la Terreur*. In 1831, *La Peau de chagrin* appeared complete, accompanied by the *Réquisitionnaire*, *Les Proscrits*, *Le Chef-d'œuvre inconnu* (a masterpiece fortunately not unrecognized), *Jésus Christ en Flandre* and *Maitre Cornélius*. 1832 gave *Madame Firmiani*, *Le Message*, *Le Colonel Chabert* and *Le Curé de Tours* (two stories of contrasted but extraordinary excellence), *La Bourse*, *La Femme abandonnée*, *Louis Lambert* (autobiographical and philosophic), *La Grenadière* and *Les Marana* (a great favourite with the author). In 1833 appeared *Ferragus*, *chef des dévorants*, the first part of *L'Histoire des treize* (a collection in the more extravagant romantic manner, very popular at the time, and since a favourite with some, but few, good judges), *Le Médecin de campagne* (another pet of the author's, and a kind of intended document of his ability to support the cause of virtue, but, despite certain great things, especially a wonderful popular "legend of Napoleon," a little heavy as a whole), the universally admitted masterpiece of *Eugénie Grandet*, and *L'Illustre Gaudissari* (very amusing). 1833 also saw the beginning of a remarkable and never finished work—out of his usual scope but exceedingly powerful in parts—the *Contes drolatiques*, a series of tales of Old France in Old (or at least Rabelaisian) French, which were to have been a hundred in number but never got beyond the third batch of ten. They often borrow the licence of their 15th and 16th century models; but in *La Succube* and others there is undoubted genius and not a little art. 1834 continued the *Treize* with *La Duchesse de Langeais* and added *La Recherche de l'absolu* (one of Balzac's great studies of monomania, and thought by some to be the greatest, though others prefer *Le Chef-d'œuvre inconnu*), *La Femme de trente ans* (the chief example of the author's caprice for re-handling, and very differently judged as a whole), with yet another of the acknowledged triumphs, *Le Père Goriot*. On the whole, this year's work, though not the author's largest, is perhaps his most unique. Next year (1835) followed *Mémoires réconciliés* (a tribute to the great influence which Maturin exercised, not over Balzac only, at this time in France), *Un Drame au bord de la mer*, the brilliant, if questionable, conclusion of *Les Treize*, *La Fille aux yeux d'or*, *Le Contrat de mariage* and *Séraphita*. This last, a Swedenborgian rhapsody of great beauty in parts, has divided critics almost more than anything else of its writer's, some seeing in it (with excuse) nothing but the short description given above in three words, the others (with justice) reckoning it his greatest triumph of style and his nearest attempt to reach poetry through prose. 1836 furnished *La Messe de Fatmé*, *Intériction*, *Facino Cane*, *Le Lys dans la vallée* (already referred to and of a somewhat sickly sweetness), *L'Enfant maudit*, *La Vieille Fille* and *Le Secret des Ruggieri* (connected with the earlier *Les deux Rôles* under the general title, *Sur Catherine de Médicis*, and said to have been turned out by Balzac in a single night, which is hardly possible). In 1837 were published *Les Deux Poètes*, destined to form part of *Illusions perdues*, *Les Employés*, *Gombard* and another capital work, *Histoire de la grandeur et de la décadence*

de César Bivotteau, where Balzac's own unlucky experiences in trade are made thoroughly matter of art. 1838 was less fruitful, contributing only *Le Cabinet des antiques*, which had made an earlier partial appearance, *La Maison Nucingen* and *Une Fille d'Ève*. But 1839 made amends with the second part of *Illusions perdues*, *Un Grand Homme de province à Paris* (one of Balzac's minor diploma-pieces), *Le Curé de village* (a very considerable thing), and two smaller stories, *Les Secrets de la princesse de Cadignan* and *Massimilla Doni*. *Pierrette*, Z. Marcas, *Un Prince de la Bohème* and *Pierre Grassou* followed in 1840, and in 1841 *Une Ténébreuse Affaire* (one of his most remarkable workings-up of the minor facts of actual history), *Le Martyr Calviniste* (the conclusion of *Sur Cathérine de Médicis*), *Ursule Miroulet* (an admirable story), *La Fausse Maîtresse* and *Mémoires de deux jeunes mariées*, on which again there have been very different opinions. 1842 supplied *Albert Savarus* (autobiographical largely), *Un Début dans la vie*, the very variously named and often rehandled *Rabouilleuse* (which, since Taine's exaltation of it, has often been taken as a Balzacian quintessence), and *Autre étude de femme*, yet another rehandling of earlier work. In 1843 came the introduction of the completed *Sur Cathérine de Médicis Honorine* and *La Muse du département* (almost as often reconstructed as *La Femme de trente ans*), with *Comment aiment les jeunes filles* (a similar rehandling intended to start the collected *Splendeurs et misères des courtisanes*), and a further instalment of *Illusions perdues*, *Les Souffrances d'un inventeur*. Three out of the next four years were astonishingly fruitful. 1844 gave *Modeste Mignon* (a book with a place to itself, and said to be founded on a story actually written by Madame Hanska), *Gaudissart II*, *A combien l'amour revient aux vieillards* (a second part of the *Splendeurs*), *Beatrice* (one of the most powerful if not of the most agreeable), and the first and very promising part of *Les Paysans*. Only *Un Homme d'affaires* came out in 1845, but this was made up in 1846 by *Les Comédiens sans le savoir* (sketched earlier), another part of the *Splendeurs*, *Où mènent les mauvais chemins*, the first part of *Les Parents pauvres*, *La Cousine Bette* (sometimes considered the topmost achievement of Balzac's genius), and the final form of a work first issued fifteen years earlier and often retouched, *Petites misères de la vie conjugale*. 1847 was even richer, with *Le Cousin Pons* (the second part of *Les Parents pauvres*, and again a masterpiece), the conclusion of the *Splendeurs*, *La Dernière Incarnation de Vautrin*, *L'Envers de l'histoire contemporaine* (which had been on and off the stocks for five years), and the unfinished *Député d'Arcis*. This was the last scene of the comedy that appeared in the life of its author. The conclusion of the *Député d'Arcis*, published in 1853, and those of *Les Paysans* and *Les Petits Bourgeois* which appeared, the first in this year, the second wholly in 1855, are believed or known to be by Balzac's friend, Charles Rabou (1803-1871).

This immense and varied total stands to its author in a somewhat different relation from that of any other work to any other writer. It has been well said that the whole of Balzac's production was always in his head together; and this is the main justification for his syllabus of it as the "Comedy." Some part never came out of his head into print; he has numerous titles of work (sometimes spoken of in his letters as more or less finished) of which no trace remains, or only fragmentary MS. sketches. One apparently considerable book, *La Bataille*, which was to be devoted to the battle of Essling, and for which he actually visited the ground, is frequently referred to as in progress from the time of his early letters to Madame Hanska onwards; but it has never been found. Another result of this relation was the constant altering, re-shaping, re-connecting of the different parts. That if Balzac had lived as long as Hugo, and had preserved his faculties as well, he could never have finished the *Comédie*, is of course obvious: the life of Methuselah, with the powers of Shakespeare, would not suffice for that. But that he never would—even if by some impossibility he could—is almost equally certain. Whether there is any mark of decline in his latest work has been disputed, but there could hardly have been farther advance, and the character of the

whole, not easy to define, is much less hard to comprehend, if prejudice be kept out of the way. That character was put early, but finally, by Victor Hugo in his funeral discourse on Balzac, whose work he declared, with unusual terseness, among other phrases of more or less gorgeous rhetoric, to be "observation and imagination." It may be doubted whether all the volumes written on Balzac (a reasoned catalogue of the best of which will be found below) have ever said more than these three words, or have ever said it more truly if the due stress be laid upon the "and." On the other side, most of the mistakes about him have arisen from laying undue stress on one of the two qualities, or from considering them separately rather than as inextricably mixed and blended. It is this blending which gives him his unique position. He is an observer of the most exact, the most minute, the most elaborate; but he suffuses this observation with so strange and constant an imaginative quality that he is, to some careful and experienced critics, never quite "real"—or almost always something more than real. He seems accustomed to create in a fashion which is not so much of the actual world as of some other, possible but not actual—no matter whether he deals with money or with love, with Paris or with the provinces, with old times or with new. A further puzzle has arisen from the fact that though Balzac has virtuous characters, he sees humanity on the whole "in black": and that, whether he actually prefers the delineation of vice, misfortune, failure, or not, he produces as a rule in his readers the sensation familiarly described as "uncomfortable." His morality has been fiercely attacked and valiantly defended, but it is absolutely certain that he wrote with no immoral intention, and with no indifference to morality. In the same way there has been much discussion of his style, which seldom achieves beauty, and sometimes falls short of correctness, but which still more seldom lacks force and adequacy to his own purpose. On the whole, to write with the shorthand necessary here, it is idle to claim for Balzac an absolute supremacy in the novel, while it may be questioned whether any single book of his, or any scene of a book, or even any single character or situation, is among the very greatest books, scenes, characters, or situations in literature. But no novelist has created on the same scale, with the same range; none has such a cosmos of his own, pervaded with such a sense of the originality and power of its creator.

Balzac's life during these twenty years of strenuous production has, as regards the production itself, been already outlined, but its outward events, its distractions or avocations—apart from that almost weekly process of "raising the wind," of settling old debts by contracting new ones, which seems to have taken up no small part of it—must now be shortly dealt with. Besides constant visits to the Margonne family at Saché in Touraine, and to the Carraults at Frapesne in Berry, he travelled frequently in France. He went in 1833 to Neuchâtel for his first meeting with Madame Hanska, to Geneva later for his second, and to Vienna in 1835 for his third. He took at least two flights to Italy, in more or less serious circumstances. In 1838, he went on a journey to Sardinia to make his fortune by melting the silver out of the slag-heaps of Roman mines,—a project, it seems, actually feasible and actually accomplished, but in which he was anticipated. The year before, tired of Paris apartments, he had bought ground at Ville d'Avray, and there constructed, certainly at great, though perhaps exaggerated expense, his villa of Les Jardies, which figures largely in the Balzacian legend. His rash and complicated literary engagements, and (it must be added) his disregard of them when the whim took him, brought him into frequent legal difficulties, the most serious of which was a law-suit with the *Revue de Paris* in 1836. In 1831, and again in 1834, he had thought of standing for election as Deputy, and in the latter year he actually did so both at Cambrai and Angoulême; but it is not certain that he received any votes. He also more than once took steps to become a candidate for the Academy, but retired on several occasions before the voting, and when at last, in 1849, he actually stood, he only obtained two votes.

As early as the Geneva meeting of 1833, Madame Hanska had formally promised to marry Balzac in the case of her husband's

death, and this occurred at the end of 1841. She would not, however, allow him even to visit her till the next year had expired, and then, though he travelled to St Petersburg and the engagement was renewed after a fashion, its fulfilment was indefinitely postponed. For some years Balzac met his beloved at Baden, Wiesbaden, Brussels, Paris, Rome and elsewhere. Only in September 1847 was he invited on the definite footing of her future husband to her estate of Wierzschowia in the Ukraine; and even then the visit, interrupted by one excursion to Paris and back, was prolonged for more than two years before (on the 14th of March 1850) the wedding actually took place. But Balzac's own *Peau de chagrin* was now reduced to its last morsel. His health, weakened by his enormous labours, had been ruined by the Russian cold and his journeyings across Europe. The pair reached the house at Paris in the rue Fortunée, which Balzac had bought for his wife and filled with his collections, at the end of May. On Sunday, the 17th of August, Victor Hugo found Balzac dying, attended by his mother, but not by his wife. He actually died at half-past eleven that night and was buried on the 20th, the pall-bearers being Hugo himself, Dumas, Sainte-Beuve (an enemy, but in this case a generous one) and the statesman Baroche, in Père La Chaise, where Hugo delivered the speech cited above.

BIBLIOGRAPHY.—The extraordinarily complicated bibliography of Balzac will be found all but complete in the *Histoire des œuvres* (1875 and later), attached by M. Spœlberch de Lovenoit to the *Édition définitive*, and supplemented by him in numerous smaller works, *Adour de Balzac, Une Page perdue de Balzac*, &c. Summaries of it will be found appended to the introductory critical notices of each volume of the English translation edited by Saintsbury (London, 1895-1898), which also contains a short Memoir and general criticism. Before the *Édition définitive* (1869 onwards), the works had been issued during the author's life in various forms and instalments, the earliest *Comédie humaine* being of 1842 to 1846 in sixteen volumes. For many years, however, the edition best known was that referred to in Browning as "all Balzac's novels fifty volumes long," really fifty-five small and closely-printed 24mos kept stereotyped with varying dates by Michel (Calmann) Lévy, which did not include the miscellaneous works and was not arranged according to the author's last disposition, but did include the *Œuvres de jeunesse*. These were not reprinted in the *Édition définitive*, but this gives the miscellaneous works in four volumes, an invaluable volume of correspondence, and the *Histoire des œuvres* as cited. To this was added, in 1893, another volume, *Répertoire des œuvres de Balzac*, in which the history of the various personages of the *Comédie* is tracked throughout and ranged under separate articles by MM. Cerfberr and Christophe with extraordinary pains, and with a result of usefulness which should have protected it from some critical sneers. In 1899 appeared, as the first volume of *Œuvres posthumes*, an instalment of the *Lettres à Vierge*, and in 1906 a second (up to 1844) with a portrait of Madame Hanska, and other illustrations.

Works on Balzac are very numerous, and some of them are of much importance. Sainte-Beuve and Balzac fell out, and a furious diatribe by the novelist on the critic is preserved; but the latter's post-mortem examination in *Causeries du lundi*, vol. ii., is not unfair, though it could hardly be cordial. Gautier, who was a very intimate and trusty friend of Balzac, has left an excellent study, mainly personal, reprinted in his *Portraits contemporains*. Lamartine produced a volume, not of much value, on Balzac in 1866; and minor contemporaries—Gozlan, Lemer, Champfleury—supplied something. But the series of important studies of Balzac, based on the whole of his work and not biased by friendship or enmity, begins with Taine's *Essai* of 1858, printed in volume form, 1867. Even then the *Œuvres diverses* were accessible only by immense labour in the scattered originals, and the invaluable *Correspondance* not at all. It was not till the reunion of all in the *Édition définitive* was completed, that full study of man and work was possible. To this edition itself was attached a sort of official critical introduction, *L'Œuvre de Balzac*, by M. Marcel Barrière (1890). But this is largely occupied by elaborate analyses of the different books, and the purely critical part is small, and not of the first value. Better are M. Paul Flat's *Essais sur Balzac* (2 vols., 1893-1894), which busy themselves especially with tracing types of character. Important and new biographical details (including the proper spelling of the name) were given by M. Edmond Biré's *Honoré de Balzac* (1897). The *Balzac ignoré* of A. Cabanès (1899) is chiefly remarkable for its investigations of Balzac's fancy for occult studies, and the first part (*Balzac imprimeur*) of MM. Hanotaux and Vicaire's *La Jeunesse de Balzac* (1903) mentioned above, for its dealing with the printing business and the intimacy with Madame de Berny. Two most important studies of Balzac in French, are those of M. A. Le Breton, *Balzac, l'homme et l'œuvre* (1905), a somewhat severe, but critical and very well-informed examination, and M. Ferdinand Brunetière's *Honoré de Balzac* (1906), a brilliant but rather one-sided panegyric on the subject as the evolver of the modern novel proper, and a realist and

observer *par excellence*. In English, translations of separate books are innumerable; of the whole, besides that mentioned above, but containing a few things there omitted, an American version by Miss Wormeley and others may be mentioned. The most elaborate monograph in English, till recently, was F. Wedmore's *Balzac* (1887), with a useful bibliography up to the time. The recent additions to our knowledge are utilized in Miss Mary F. Sanders' *Balzac* (1904), a rather popular, but full and readable summary, chiefly of the life, from all but the latest documents, and W. H. Helm's *Aspects of Balzac* (1905), which is critical as well as anecdotic. The present writer, besides the critical and biographical essays referred to above, prefixed a shorter one to a translation of *Les Chouans* executed by himself in 1890. (G. S.A.)

BALZAC, JEAN LOUIS GUEZ DE (1594-1654), French author, was born at Angoulême in 1594. At the age of eighteen he travelled in Holland with Théophile de Viaud, with whom he later exchanged bitter recriminations. He was early befriended by the duc d'Épernon and his son Louis, Cardinal de la Valette, who took him to Rome. His letters written to his acquaintances and to many who held a high position at the French court gained for him a great reputation. Compliments were showered upon him, he became an habitué of the Hôtel de Rambouillet, and his head appears to have been turned a little by his success. Richelieu was lavish of praise and promises, but never offered Balzac the preferment he expected. In 1624 a collection of his *Lettres* was published, and was received with great favour. From the château of Balzac, whither he had retired, he continued to correspond with Jean Chapelain, Valentin Conrart and others. In 1634 he was elected to the Academy. He died at Angoulême on the 18th of February 1654. His fame rests chiefly upon the *Lettres*, a second collection of which appeared in 1636. *Recueil de nouvelles lettres* was printed in the next year. His letters, though empty and affected in matter, show a real mastery of style, introducing a new clearness and precision into French prose and encouraging the development of the language on national lines by emphasizing its most idiomatic elements. Balzac has thus the credit of executing in French prose a reform parallel to Malherbe's in verse. In 1631 he published an eulogy of Louis XIII. entitled *Le Prince*; in 1652 the *Socrate chrétien*, the best of his longer works; *Aristippe ou de la Cour* in 1638; and several dissertations on style.

His *Œuvres* were collected (2 vols.) in 1665 by Valentine Conrart. There are numerous English translations from Balzac, dating from the 17th century.

BAM, a town of Persia in the province of Kerman, situated 115 m. S.E. of the city of Kerman at an elevation of 3600 ft. on both banks of the river Bam. Pop. about 13,000. It is the capital of the Bam-Narmashir district and has extensive groves of date-palms and gardens. Outside the town stands the famous citadel with walls 40 ft. in height. This citadel was, even as late as the beginning of the 19th century, the strongest fortified place in Persia, and owed its strength to the Afghans who took Bam in 1719 and were not finally expelled until 1801. Post and telegraph offices have been established there since 1903.

BAMBERG, a town and archiepiscopal see of Germany, in the kingdom of Bavaria. Pop. (1885) 31,521; (1905) 45,308. It lies on an open plain on the river Regnitz, 2 m. above its junction with the Main, and 39 m. north of Nuremberg by railway. The upper town is built on seven hills, each crowned by a church, while the lower, still partially surrounded by walls and ditches, is divided by the river and Ludwigskanal into three districts. The cathedral is a noble late Romanesque building with four imposing towers. It was founded in 1004 by the emperor Henry II., finished in 1012, afterwards partially burnt, and rebuilt in the 13th century. Of its many works of art may be mentioned the magnificent marble tomb of the founder and his wife, the empress Cunigunde, carved by Tilman Riemschneider between 1499 and 1513, and an equestrian statue of the emperor Conrad III. Other noteworthy churches are the Jakobskirche, an 11th-century Romanesque basilica; the St Martinskirche; the Marienkirche or Obere Pfarrkirche (1320-1387), which has now been restored to its original pure Gothic style. The Michaelskirche, 12th-century Romanesque (restored) and the Michaelsberg, was formerly the church of a Benedictine monastery secularized in 1803, which now contains

the Bürgerspital, or alms-house, and the museum and municipal art collections. Of the bridges connecting the sections of the lower town the most interesting is the *Obere Brücke*, completed in 1455. Halfway across this, on an artificial island, is the Rathaus (rebuilt 1744-1756). The royal lyceum, formerly a Jesuit college, contains notable collections and the royal library of over 300,000 volumes. The picturesque Old Palace (*Alte Residenz*) was built in 1591 on the site of an old residence of the counts of Babenberg. The New Palace (1698-1704) was formerly occupied by the prince-bishops, and from 1864 to 1867 by the deposed King Otto of Greece. Noteworthy among the monuments of the town is the Maximilian fountain (1880), with statues of Maximilian I. of Bavaria, the emperor Henry II. and his wife, Conrad III. and St Otto, bishop of Bamberg. At a short distance from the town is the Altenburg (1266 ft.), a castle occupied from 1251 onwards by the bishops of Bamberg. It was destroyed in 1553 by Albert, margrave of Brandenburg, but has been partly restored. The schools include the lyceum for philosophy and Catholic theology (a survival of the university suppressed in 1803), a seminary, two gymnasias, a Realschule, and several technical schools, including one for porcelain-painting. The industries of the town include cotton spinning and weaving, silk spinning, the manufacture of tobacco, ropes, metal-ware, furniture, &c. The market gardens of the neighbourhood are famous, and there is a considerable shipping trade by the river and the Ludwigskanal.

Bamberg, first mentioned in 902, grew up by the castle (Babenberch) which gave its name to the Babenberg family (q.v.). On their extinction it passed to the Saxon house, and in 1007 the emperor Henry II. founded the see. From the middle of the 13th century onward the bishops were princes of the Empire. The see was secularized in 1802 and in 1803 assigned to Bavaria.

A brief history of the bishopric is given in the *Catholic Encyclopedia* (London and New York, 1909), with bibliography. For general and special works on the town see Ulysse Chevalier, *Topobibliographie* (Montbéliard, 1894-1899), s. v.

BAMBERGER, LUDWIG (1823-1899), German economist and politician, was born of Jewish parents on the 22nd of July 1823 at Mainz. After studying at Gießen, Heidelberg and Göttingen, he entered on the practice of the law. When the revolution of 1848 broke out he took an active part as one of the leaders of the republican party in his native city, both as popular orator and as editor of one of the local papers. In 1849 he took part in the republican rising in the Palatinate and Baden; on the restoration of order he was condemned to death, but he had escaped to Switzerland. The next years he spent in exile, at first in London, then in Holland; in 1852 he went to Paris, where, by means of private connexions, he received an appointment in the bank of Bischoffheim & Goldschmidt, of which he became managing director, a post which he held till 1866. During these years he saved a competence and gained a thorough acquaintance with the theory and practice of finance. This he put to account when the amnesty of 1866 enabled him to return to Germany. He was elected a member of the Reichstag, where he joined the National Liberal party, for like many other exiles he was willing to accept the results of Bismarck's work. In 1868 he published a short life of Bismarck in French, with the object of producing a better understanding of German affairs, and in 1870, owing to his intimate acquaintance with France and with finance, he was summoned by Bismarck to Versailles to help in the discussion of terms of peace. In the German Reichstag he was the leading authority on matters of finance and economics, as well as a clear and persuasive speaker, and it was chiefly owing to him that a gold currency was adopted and that the German Imperial Bank took its present form; in his later years he wrote and spoke strongly against bimetalism. He was the leader of the free traders, and after 1878 refused to follow Bismarck in his new policy of protection, state socialism and colonial development; in a celebrated speech he declared that the day on which it was introduced was a *dies nefastus* for Germany. True to his free trade principles he and a number of followers left the National Liberal party and formed the so-called "Secession" in 1880. He

was one of the few prominent politicians who consistently maintained the struggle against state socialism on the one hand and democratic socialism on the other. In 1892 he retired from political life and died in 1899. Bamberger was a clear and attractive writer and was a frequent contributor on political and economic questions to the *Nation* and other periodicals. His most important works are those on the currency, on the French war-indemnity, his criticism of socialism and his apology for the Secession.

An edition of his collected works (including the French life of Bismarck) was published in 1894 in five volumes. After his death in 1899 appeared a volume of reminiscences, which, though it does not extend beyond 1866, gives an interesting picture of his share in the revolution of 1848, and of his life in Paris. (J. W. H.E.)

BAMBERG, IL (Ital. for "the Babe"), the name given in art to the image of the infant Jesus in swaddling clothes common in Roman Catholic churches. The most famous is the miracle-working *Santissimo Bambino* in the church of Ara Coeli at Rome, the festival of which is celebrated on the feast of the Epiphany (January 6).

BAMBOO, the popular name for a tribe of grasses, *Bambuseae*, which are large, often tree-like, with woody stems. The stems spring from an underground root-stock and are often crowded to form dense clumps; the largest species reach 120 ft. in

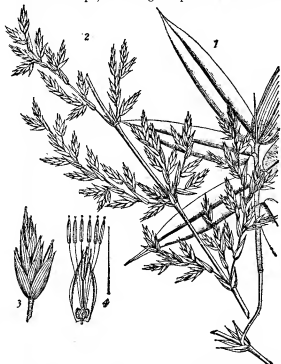

FIG. 1.—*Bambusa arundinacea*, an Indian bamboo. 1, Leafy shoot. 2, Branch of inflorescence. 3, Spikelet. 4, Flower.

height. The slender stem is hollow, and, as generally in grasses, has well-marked joints or nodes, at which the cavity is closed by a strong diaphragm. The branches are numerous and in some species spiny; the narrow, often short, leaf-blade is usually jointed at the base and has a short stalk, by which it is attached to the long sheath. The spikelets are usually many-flowered and variously arranged in racemes or panicles. The flower differs from that of the majority of grasses in having usually three lodicules and six stamens. Many species bloom annually, but others only at intervals sometimes of many years, when the individuals of one and the same species are found in bloom over large areas. Thus on the west coast of India the simultaneous blooming of *Bambusa arundinacea* (fig. 1), one of the largest species, has been observed at intervals of thirty-two years. After ripening of the seed, the leafless flowering culms always die down.

The *Bambuseae* contain twenty-three genera and occur throughout the tropical zone, but very unevenly distributed; they also extend into the sub-tropical and even into the temperate zone. Tropical Asia is richest in species; in Africa there are very few. In Asia they extend into Japan and to 10,000 ft. or more on the

Himalayas; and in the Andes of South America they reach the snow-line.

The fruit in *Bambusa*, *Arundinaria* and other genera resembles the grain generally characteristic of grasses, but in *Dendrocalamus* and others it is a nut, while rarely, as in *Melocanna*, it is fleshy and suggests an apple in size and appearance. The uses to which all the parts and products of the bamboo are applied in Oriental countries are almost endless. The soft and succulent shoots, when just beginning to spring, are cut off and served up at table like asparagus. Like that vegetable, also, they are earthed over to keep them longer fit for consumption; and they afford a continuous supply during the whole year, though it is more abundant in autumn. They are also salted and eaten with rice, prepared in the form of pickles or candied and preserved in sugar. As the plant grows older, a species of fluid is secreted in the hollow joints, in which a concrete substance once highly valued in the East for its medicinal qualities, called *tabaxir* or *tabascheer*, is gradually developed. This substance, which has been found to be a purely siliceous concretion, is possessed of peculiar optical properties. As a medicinal agent the bamboo is entirely inert, and it has never been received into the European materia medica.

The grains of the bamboo are available for food, and the Chinese have a proverb that it produces seed more abundantly in years when the rice crop fails, which means, probably, that in times of dearth the natives look more after such a source of food. The Hindus eat it mixed with honey as a delicacy, equal quantities being put into a hollow joint, coated externally with clay, and thus roasted over a fire. The fleshy fruit of *Melocanna* is baked and eaten. The plant is a native of India, but is sometimes cultivated as in Mauritius. It is, however, the stem of the bamboo which is applied to the greatest



FIG. 2.—Bamboo (*Bambusa vulgaris*), very much reduced. Grows 20 to 50 ft. high.

variety of uses. Joints of sufficient size form water buckets; smaller ones are used as bottles, and among the Dyaks of Borneo they are employed as cooking vessels. Bamboo is extensively used as a timber wood, and houses are frequently made entirely out of the products of the plant; complete sections of the stem form posts or columns; split up, it serves for floors or rafters; and, interwoven in lattice-work, it is employed for the sides of rooms, admitting light and air. The roof is sometimes of bamboo solely, and when split, which is accomplished with the greatest ease, it can be formed into laths or planks. It is employed in shipping of all kinds; some of the strongest plants are selected for masts of boats of moderate size, and the masts of larger vessels are sometimes formed by the union of several bamboos built up and joined together.

The bamboo is employed in the construction of all kinds of agricultural and domestic implements and in the materials and implements required in fishery. Bows are made of it by the union of two pieces with many bands; and, the septa being bored out and the lengths joined together, it is employed, as we use leaden pipes, in transmitting water to reservoirs or gardens. From the light and slender stalks shafts for arrows are obtained; and in the south-west of Asia there is a certain species of equally slender growth, from which writing-

pens or reeds are made. A joint forms a holder for papers or pens, and it was in a joint of bamboo that silk-worm eggs were carried from China to Constantinople during the reign of Justinian. The outer cuticle of Oriental species is so hard that it forms a sharp and durable cutting edge, and it is so siliceous that it can be used as a whetstone. This outer cuticle, cut into thin strips, is one of the most durable and beautiful materials for basket-making, and both in China and Japan it is largely so employed. Strips are also woven into cages, chairs, beds and other articles of furniture, Oriental wicker-work in bamboo being unequalled for beauty and neatness of workmanship. In China the interior portions of the stem are beaten into a pulp and used for the manufacture of the finer varieties of paper. Bamboos are imported to a considerable extent into Europe for the use of basket-makers, and for umbrella and walking-sticks. In short, the purposes to which the bamboo is applicable are almost endless, and well justify the opinion that "it is one of the most wonderful and most beautiful productions of the tropics, and one of Nature's most valuable gifts to uncivilized man" (A. R. Wallace, *The Malay Archipelago*).

A number of species of bamboo are hardy under cultivation in the British Isles. A useful and interesting account of these and their cultivation will be found in the *Bamboo Garden*, by A. B. Freeman-Mitford. They are mostly natives of China and Japan and belong to the genera *Arundinaria*, *Bambusa* and *Phyllostachys*; but include a few Himalayan species of *Arundinaria*. They may be propagated by seed (though owing to the rare occurrence of fruit, this method is seldom applicable), by division and by cuttings. They are described as hungry plants which will repay generous treatment, and will flourish in a rich, not too stiff loam, and for the first year or two should be well mulched. They should be sheltered from winds and well watered during the growing period. When being transplanted the roots must be disturbed as little as possible. The following may be mentioned; *Arundinaria simoni*, a fine plant which in the bamboo garden at Kew has reached 18 ft. in height, and not infrequently flowers and fruits in Britain; *A. japonica*, a tall and handsome plant generally grown in gardens under the name *Bambusa métaké*; *A. nitida*, "by far the daintiest and most attractive of all its genus, and remarkably hardy"; *Bambusa palmata*, with leaves a foot or more long and three inches broad; *B. tessellata*; *B. quadrangularis*, remarkable for its square stems; *Phyllostachys mitis*, growing to 60 ft. high in its native home, China and Japan; and *P. nigra*, so called from the black stem, a handsome species.

BAMBURGH, or **BAMBOROUGH**, a village in the Berwick-upon-Tweed parliamentary division of Northumberland, England, on the sea-coast, 2½ m. E. of Belford station on the North Eastern railway, and 54 m. N. of Newcastle. It was a royal borough previous to the Norman Conquest and returned two members to parliament in the reign of Edward I. Its ancient castle occupies a magnificent position close to the sea on an almost perpendicular rock, 150 ft. in height, accessible only on the south-east side.

The first erection is ascribed by the Saxon chronicles to King Ida of Northumberland. The castle buildings are of various dates from the Norman period and are of great strength and dignity. They include a massive keep and the remains of an apsidal chapel dedicated to St Peter. In the village, the church is dedicated to St Aidan, who was bishop of Lindisfarne or Holy Island, which lies off the coast to the north, about 634. It is a fine cruciform building, mainly of Early English date, with a crypt beneath the chancel. In the churchyard is a monument to Grace Darling (1815-1842), the brave rescuer of some of the crew of the ship "Forfarshire" in 1838. The Longstone Lighthouse, where her father was keeper, stands on an outer rock of the Farne Islands, which stretch north-eastward for 6 m. from the coast at Bamburgh.

The town of Bamburgh (*Bebbanburgh*) sprang up round the ancient castle. During the struggle for the crown between William Rufus and Robert of Normandy, Bamburgh was besieged by William, who, finding the defence too strong, erected and garrisoned a new castle before Bamburgh called

"Malveisin" or "Evil neighbour." Earl Robert of Northumberland, who was in command of Bamburgh, having been defeated in a sally, the castle surrendered to William in November 1095. The first mention of Bamburgh as a borough does not occur until 1160, when the men paid 2½ marks to an aid. Henry III. by charter of 1254-1255 granted the burgesses their town at an annual fee farm rent of 26 marks, of which they were acquitted in 1318 and 1327 "on account of the robberies and fires inflicted on them by the Scots." Edward III. in 1332 confirmed the charter of Henry III., and granted further that the town should be a free borough governed by four bailiffs, that it should be enclosed by a wall and that the burgesses should have a gild merchant. He also altered the market-day from Sunday to Wednesday, and gave licence for the fairs, which had been held "from time immemorial" on the feasts of SS. Oswald and Aidan, to continue for three extra days. During the Scottish wars of the reign of Henry V., Bamburgh again suffered severely, so much so that in 1430 the burgesses had decreased in number from 120 to 13. These again petitioned for a remission of their farm, which in 1446 was reduced to £10 yearly. Bamburgh was twice taken by the Yorkists in the Wars of the Roses and twice recovered by Queen Margaret. In 1463, after it had been recovered a second time by the queen, Henry VI. stayed there for a year, but after the battle of Hexham it was again taken by the Yorkists, and the castle and town were then so much injured that from that time there is no mention of the burgesses or their privileges. Bamburgh returned two members to parliament in 1295 and again in Edward III.'s reign, but since then has never been represented. In 1384 Lord Neville received licence to dig for sea-coal in Bamburgh, and mines of coal and lead existed there as late as 1681.

BAMBUTE (sometimes incorrectly called *BATWA*), a race of pygmies of the Semliki Forest, on the western borders of the Uganda Protectorate between Albert Nyanza and Albert Edward Nyanza. They probably form merely a branch of the pygmy race of Equatorial Africa, represented farther west by H. von Wissmann's *Batwa* (*q.v.*). Their complexion varies from reddish-yellow to brownish-black, with head-hair often of a russet-brown, and body-hair, black and bristly on upper lip, chin, chest, axillae and pubes, yellowish and fleecy on cheeks, back and limbs. Their average height is 4 ft. 9 in. Even when forced to keep clean, their skins give out a rancid odour, something (Sir H. H. Johnston says) between the smell of a monkey and a negro. Their faces are remarkable for the long upper lip, and the bridgeless nose with enormous alae (the cartilage of the nose above the nostrils). Like the *Batwa* they are nomad hunters, building only huts of sticks and leaves, and living in the forest, where they hunt the largest game with no weapon but a tiny bow from which they shoot poisoned arrows. Sir H. H. Johnston states that the *Bambute* have a good idea of drawing, and with a sharpened stick can sketch in sand or mud the beasts and birds known to them. The *Bambute* do not tattoo or scar, nor have they any love of ornament, wearing no ear-rings, necklets, anklets, &c. The upper incisors and canines are sharpened to a point. In the forests they go quite naked. They speak a corrupted form of the dialects of their negro neighbours. They have a peculiar way of singing their words. Their voices are low and musical and the pronunciation is singularly staccato, every syllable being separately uttered. They show no trace of spirit or ancestor worship, but have some idea that thunder, lightning and rain are manifestations of an Evil Power, and that the dead are reincarnated in the red bush-pig. They have no tribal government, accepting as temporary lawgiver some adept hunter. Marriage is by purchase; polygamy seems to exist, but the domestic affections are strong. The dead are buried in dug graves, and food, tobacco and weapons are often placed with the corpse. The *Bambute* are very musical, though they are uninventive as regards instruments. They have many songs which they sing well and they dance with spirit.

See A. de Quatrefages, *The Pygmies* (Eng. edit. 1895); Sir H. H. Johnston, *Uganda Protectorate* (1902).

BAMFORD, SAMUEL (1788-1872), English labour politician, was born at Miston, near Middleton, Lancashire, on the 28th of February 1788. Himself a stalwart weaver, he was opposed to physical force movements and did all he could to restrain the violent resistance to trade oppression which was so common; yet through attending and speaking at the meeting (1819) at Peterloo, Manchester (*q.v.*), which was intended to be a peaceful gathering to petition for Parliamentary reform and a repeal of the Corn Law but ended in a massacre, he was arrested for a breach of the law, convicted and sentenced to twelve months' imprisonment. He was the author of several widely popular poems (principally in the Lancashire dialect) showing sympathy with the conditions of his class, and his *Passages in the Life of a Radical* (1840-1844) is an authoritative history of the condition of the working classes in the years succeeding the battle of Waterloo. He died at Harpurhey on the 13th of April 1872, and was accorded a public funeral, attended by thousands.

BAMIAN, a once renowned city of Afghanistan, situated about 80 m. N.W. of Kabul. Its remains lie in a valley of the Hazara country, on the chief road from Kabul towards Turkestan, and immediately at the northern foot of that prolongation of the Indian Caucasus now called Koh-i-Baba. The passes on the Kabul side are not less than 11,000 and 12,000 ft. in absolute height, and those immediately to the north but little inferior. The height of the valley was fixed at about 8500 ft., and the surrounding country carefully surveyed by Major Pelham J. Maitland and the Hon. M. G. Talbot, during the progress of the Russo-Afghan Boundary Commission in November 1885. The river draining the valley is one of the chief sources of the *Sarkhab* (*Surkhab*) or *Aksarai*, an important tributary of the Upper Oxus. The prominences of the cliffs which line the valley are crowned by the remains of numerous massive towers, whilst their precipitous faces are for 6 or 7 m. pierced by an infinity of ancient cave-dwellings, some of which are still occupied. The actual site of the old city is marked by mounds and remains of walls, and on an isolated rock in the middle of the valley are considerable ruins of what appears to have been the acropolis, now known to the people as *Ghulgulah*. But the most famous remains at Bamian are two colossal standing idols, carved in the cliffs on the north side of the valley. They are 173 ft. and 120 ft. high respectively. These images, which have been much injured, apparently by cannon-shot, are cut in niches in the rock, and both images and niches have been coated with stucco. There is an inscription, not yet interpreted, over the greater idol, and on each side of its niche are staircases leading to a chamber near the head, which shows traces of elaborate ornamentation in azure and gilding. These chambers are used by the amir as store-houses for grain. The surface of the niches also has been painted with figures. In one of the branch valleys is a similar colossus, somewhat inferior in size to the second of these two; and there are indications of other niches and idols. *Chahilburj*, 28 m. from Zari, on the road to Balkh by the *Balkhab*, at the east end of the *Sokhtagi* valley; *Shahr-i-Babar*, about 45 m. above *Chahilburj*; and *Gawargin*, 6 m. above *Shahr-i-Babar*, are all fortified sites of about the same age as the relics at Bamian. At *Haibak* there is a very perfect excavation called the *Takht-i-Rustam* (a general name for all incomprehensible constructions amongst the modern inhabitants of Afghan Turkestan), which consists of an annular ditch enclosing a platform, with a small house about 21 ft. square above it, all cut out of the solid rock. There are hundreds of caves in this neighbourhood, all pointing to a line of Buddhist occupation connecting *Balkh* with *Kabul*. As seen from the rock of *Ghulgulah*, *Bamian*, with its ruined towers, its colossi, its innumerable grottos, and with the singular red colour of its barren soil, presents an impressive aspect of desolation and mystery.

That the idols of Bamian, about which so many conjectures have been uttered, were Buddhist figures, is ascertained from the narrative of the Chinese pilgrim, *Hsüan-Tsang*, who saw them in their splendour in A.D. 630, and was verified by the officers above named, who discovered other Buddhist caves and excavations in the valleys of the *Balkhab* and *Sarikol*.

Still vaster than these was a recumbent figure, 2 m. east of Bamian, representing Sakya Buddha entering *Nirvāna*, i.e. in act of death. This was "about 1000 ft. in length." No traces of this are alluded to by modern travellers, but in all likelihood it was only formed of rubble plastered (as is the case still with such *Nirvāna* figures in Indo-China) and of no durability. For a city so notable Bamian has a very obscure history. It does not seem possible to identify it with any city in classical geography: *Alexandria ad Cascasum* it certainly was not. The first known mention of it seems to be that by Hsuan-Tsang, at a time when apparently it had already passed its meridian, and was the head of one of the small states into which the empire of the White Huns had broken up. At a later period Bamian was for half a century, ending A.D. 1214, the seat of a branch of the Ghorid dynasty, ruling over Tokharistan, or the basin of the Upper Oxus. The place was long besieged, and finally annihilated (1222) by Jenghiz Khan, whose wrath was exasperated at the death of a favourite grandson by an arrow from its walls. There appears to be no further record of Bamian as a city; but the character of ruins at Ghulghul agrees with traditions on the spot in indicating that the city must have been rebuilt after the time of the Mongols and again perished. In 1840, during the British occupation of Kabul, Bamian was the scene of an action in which Colonel William H. Dennie with a small force routed Dost Mahomed Khan, accompanied by a number of Uzbek chiefs.

See Hon. M. G. Talbot, "The Rock-cut Caves and Statues of Bamian," *Journal R. Austral. Soc. vol. xviii.* Part 3; and J. A. Gray, *At the Court of the Amir* (1895). (T. H. H.)

BAMPTON, JOHN (c. 1690–1751), English divine, was a member of Trinity College, Oxford, where he graduated M.A. in 1712, and for some time canon of Salisbury. He died on the 2nd of June 1751, aged 61. His will directs that eight lectures shall be delivered annually at Oxford in the University Church on as many Sunday mornings in full term, "between the commencement of the last month in Lent term and the end of the third week in Act term, upon either of the following subjects:—to confirm and establish the Christian faith, and to confute all heretics and schismatics; upon the divine authority of the Holy Scriptures; upon the authority of the writings of the primitive fathers, as to the faith and practice of the primitive Church; upon the divinity of our Lord and Saviour Jesus Christ; upon the divinity of the Holy Ghost; upon the articles of the Christian faith as comprehended in the Apostles' and Nicene Creeds." The lecturer, who must be at least a Master of Arts of Oxford or Cambridge, was formerly chosen yearly by the heads of colleges, on the fourth Tuesday in Easter term, and no one can be chosen a second time. The series of lectures began in 1780, and is still continued, though since 1895 elections are only made in alternate years through a depreciation of the revenue of the fund. The endowment provides £120 for each lecturer, and the lectures have to be published within two months of their delivery. Among the lecturers have been Heber in 1815 (*The Personality and Office of the Christian Comforter*); R. Whately in 1822 (*Party Feeling in Religion*); R. D. Hampden in 1832 (*The Scholastic Philosophy in relation to Christian Theology*); E. M. Goulburn in 1850 (*The Resurrection of the Body*); H. L. Mansel in 1858 (*The Limits of Religious Thought*); H. P. Liddon in 1866 (*The Divinity of our Lord*); E. Hatch in 1880 (*The Organization of the Early Christian Churches*); C. Bigg in 1886 (*Christian Platonists of Alexandria*); C. Gore in 1891 (*The Incarnation*); W. Sanday in 1893 (*Inspiration*); J. R. Illingworth in 1894 (*Personality, Human and Divine*); W. R. Inge in 1899 (*Christian Mysticism*), &c. A complete list is given in the *Oxford Historical Register*. The institution has done much to preserve a high standard in English theology; and the lectures as a whole form a historically interesting collection of apologetic literature.

BAMPŪR, a town of Persia, in the province of Baluchistan, 330 m. S.E. of Kerman, in 27° 12' N., 60° 24' E., at an elevation of 1720 ft. Pop. about 2000. It is the capital of the province and situated on the banks of the Bampūr river which flows from east to west and empties itself about 70 m. W. into a *hamun*, or depression, 50 m. in length, and called Jaz-morian. The old

citadel of Bampūr which crowned an elevation about 100 ft. in height, 3 m. north of the river, having completely fallen in ruins, a new fort called Kalah Nāsseri, was built at Fahraj, 15 m. further east, in the eighties; and Fahraj, which now has a population of about 2500, has become more important than Bampūr. Fahraj, which is also known as Pahura, Paharu, Puhra, is by some identified as the Paura where Alexander the Great halted on his march from India, but others are more in favour of another Fahraj near Bam, or even of Bampūr itself.

BAMRA, a feudatory state of India, in the province of Bengal. Area 1988 sq. m.; pop. (1901) 123,378; estimated revenue £5000; tribute £100. Most of the country is forest, producing only timber and lac but said to be rich in iron ore. The northern border is touched by the Bengal-Nagpur railway, with a station at Bamra town. The state is one of the five Uriya feudatories, which were transferred from the Central Provinces to Bengal, on the reconstitution of that province in October 1905. The capital is Deogarh.

BAN, a word taken from the root of a verb common to many Teutonic languages and meaning originally "to proclaim" or "to announce." The Late Lat. form of the word is *bannum*.

In the laws of the Franks and kindred tribes the word had three main uses: first in the general sense of a proclamation, secondly, for the fine incurred for disobeying such proclamation, and thirdly for the district over which proclamations were issued.

It was the frequent use of proclamations or bans, commanding or forbidding certain actions under a threat of punishment, which caused the second of these uses to arise out of the first, as the idea of wrong-doing became associated with the proclamation or ban. This *bannum dominicum*, as it was called, was employed by all feudal lords, from the king downwards, against offenders, and played an important part in the administration of justice in feudal times. It usually took the form of an order to make some amend for wrong-doing, which, if not complied with, was followed by the withdrawal of all protection from the offender, i.e. by outlawry.

After the break-up of the Carolingian empire another use of the word arose in France. "Ban" had occasionally been used in a restricted sense referring only to the summons calling out the host; and as France became separated from the Empire, French law and custom seized upon this use, and soon the men liable to military service were known as "the ban." A variant form of this word was *heriban* or *ariban*, and it is possible that some confusion between the early syllables of this word and the word *arrière* led to a distinction between the *ban* and the *arrière-ban* or *retro-bannum*. At all events this distinction arose; the *ban* referring to the vassals called out by the king, and the *arrière-ban* to the sub-vassals called upon by the vassals in their turn. As in England, the liability to military service was often commuted for a monetary payment, and there were various exemptions. In the 17th and 18th centuries the *ban* and *arrière-ban* were lacking in discipline when called out, and were last summoned in 1758. Local levies, however, called out between this date and the Revolution were sometimes referred to by these names.

In the medieval Empire and in Germany the word "ban" retained the special sense of punishment. The German equivalent of *ban* is *Acht*, and the sentence soon became practically one of outlawry. Connected possibly with the power enjoyed in earlier times by the assemblies of freemen of outlawing an offender, it was frequently used by the emperor, or German king, and the phrase "under the ban" is very common in medieval history. The execution of this sentence of placing an offender under the imperial ban, or *Reichsacht*, was usually entrusted to some prince or noble, who was often rewarded with a portion of the outlaw's lands. It was, however, only a serious punishment when the king or his supporters were strong enough to enforce its execution. Employed not only against individuals but also against towns and districts, it was sometimes divided into the *Acht* and the *Oberacht*, i.e. partial or complete outlawry. Documents of the time show that the person placed under the imperial ban drew down absolute destitution upon his relatives and frequently death upon himself. At first this sentence was the act of the

emperor or king himself, but as the Empire became more German, and its administration less personal, it was entrusted to the imperial aulic council (*Reichshofrat*), and to the imperial court of justice or imperial chamber (*Reichskammergericht*). These courts were deprived of this power in 1711, retaining only the right of suggesting its use. The imperial ban had, however, been used for the last time in 1706, when Maximilian Emanuel, elector of Bavaria, was placed under it.

There are many other uses of the word in the sense of a prohibition. In earlier French law the ban of wine or *banum vini*, was the exclusive right of a lord to sell wine during a stated number of days, and the ban of March and April forbade the pasturing of cattle in certain fields during these months. There were also other similar uses dating from feudal times. In modern French law the phrase *rupture de ban* described, previous to 1885, the departure without notice of any released criminal living under the special surveillance of the police. The French government still retains the rights of appointing an obligatory place of residence for a criminal, and any escape from this place is a *rupture de ban*. A Scandinavian use of the word gives it the sense of a curse. This usage mingling with the use which spiritual lords shared with temporal lords of issuing the ban over their dependents, has become in a special sense ecclesiastical, and the sentence of excommunication is frequently referred to as "under the papal ban." The word is also used in this way by Shakespeare and Milton. The modern English use of the phrase "under the ban" refers to any line of conduct condemned by custom or public opinion. In its earlier and general sense as a proclamation, the ban may be said to have been suspended by the writ. The word, however, survives in the sense of a proclamation in the "banns of marriage" (*q.v.*).

The Persian word *ban*, meaning lord or master, was brought into Europe by the Avars. It was long used in many parts of south-eastern Europe, especially in southern Hungary, to denote the governors of military districts called *banats*, and is almost equivalent to the German *margrave*. After enjoying very extensive powers the bans were gradually reduced, both in numbers and importance. Since 1868, however, the governor of Croatia and Slavonia has been known as the ban of Croatia, Slavonia and Dalmatia, but his duties are civil and not military. He is appointed by the emperor of Austria, as king of Hungary, and has a seat in the upper house of the Hungarian parliament.

See Du Cange, *Glossarium*, tome i. (Nior, 1883); H. Brunner, *Grundzüge der deutschen Rechtsgeschichte* (Leipzig, 1901); E. P. Boutaric, *Institutions militaires de la France* (Paris, 1863); Pêre G. Daniel, *Histoire de la milice française* (Paris, 1721).

BANANA, a gigantic herbaceous plant belonging to the genus *Musa* (nat. ord. Musaceae). It is perennial, sending up from an underground root-stock an apparent stem 15 or 20 ft. high, consisting of the closely-enveloped leaf-sheaths, the corresponding blades, each sometimes 10 ft. in length, forming a spreading crown. A true stem develops at the flowering period; it grows up through the hollow tube formed by the sheaths, emerges above and bears a large number of inconspicuous tubular flowers closely crowded in the axils of large, often brightly-coloured, protecting bracts. The fruits form dense clusters.

The genus *Musa* contains about 40 species, widely distributed throughout the tropics of the Old World, and in some cases introduced into the New World. In many parts of the tropics they are as important to the inhabitants as are the grain plants to those living in cooler regions. They are most successfully cultivated in a hot, damp, tropical climate. The northern limit of their cultivation (usually *Musa Cavendishii*) is reached in Florida, south of 29° lat., the Canary Islands, Egypt and south Japan, the southern limit in Natal and south Brazil. There has been considerable discussion as to whether the banana was growing in America before the discovery of the New World. It has been suggested that it may have been carried by ocean currents or in some earlier intercourse between the Old and New Worlds. The evidence, however, of its existence in America at the time of the discovery of the new continent is not very definite. The unripe fruit is rich in starch, which in ripening changes into sugar. The

most generally used fruits are derived from *Musa paradisiaca*, of which an enormous number of varieties and forms exist in cultivation. The sub-species *sapientum* (formerly regarded as a distinct species *M. sapientum*) is the source of the fruits generally known in England as bananas, and eaten raw, while the name plantain is given to forms of the species itself *M. paradisiaca*, which require cooking.

The species is probably a native of India and southern Asia. Other species which are used as fruits are *M. acuminata* in the Malay Archipelago, *M. Fehi* in Tahiti, and *M. Cavendishii*, the so-called Chinese banana, in cooler countries; the fruit of the last-named has a thinner rind and a delicate, fragrant flesh. The species, the fruits of which require cooking, are of much greater importance as an article of food. These often reach a considerable size; forms are known in East Africa which attain nearly 2 ft. in length with the thickness of a man's arm. A form of *M. corniculato*, from Cochin China and the Malay Archipelago, produces only a single fruit, which, however, affords an adequate meal for three men. The hardly-ripe fruit is stewed whole or cut in slices and roasted or baked.

Banana-meal is an important food-stuff; the fruit is peeled and cut in strips, which are then dried and pounded in a mortar. In East Africa and elsewhere, an intoxicating drink is prepared from the fruit. The root-stock which bears the leaves is, just before the flowering period, soft and full of starch, and is sometimes used as food, as in the case of the Abyssinian species, *M. Ensel*.

The leaves cut in strips are plaited to form mats and bags; they are also largely used for packing and the finer ones for cigarette papers. Several species yield a valuable fibre, the best of which is "Manila hemp" (*q.v.*) from *M. textilis*.

The following is the composition of the flour, according to Hutchison: water, 13%; proteid, 4%; fat, 0.5%; carbohydrates, 80%; salts, 2.5%. It would require about eighty bananas of average size to yield the amount of energy required daily, and about double that number to yield the necessary amount of proteid. Hence the undue abdominal development of those who live mainly on this article of diet (Hutchison). In recent years the cultivation of the banana in Jamaica for the American and also for the English market has been greatly developed.

BANAS, or **BUNAS**, the name of three rivers of India. (1) A river of Rajputana, which rises in the Aravalli range in Udaipur, drains the Udaipur valley, and the after a course of 300 m. flows into the Chambal. (2) A river of the Shahabad district of Bengal, which forms the drainage channel between the Arrah canal and the Sone canals system, and finally falls into the Gangi nadi. (3) A river of Chota Nagpur in Bengal, which rises in the state of Chang Bhakar and falls into the Sone near Rampur.

BANAT (Hungarian *Bánság*), a district in the south-east of Hungary, consisting of the counties of Torontál, Temes and Krasso-Szörény. The term, in Hungarian, means generally a frontier province governed by a *ban* and is equivalent to the German term *Mark*. There were in Hungary several banats, which disappeared during the Turkish wars, as the banat of Dalmatia, of Slavonia, of Bosnia and of Croatia. But when the word is used without any other qualification, it indicates the Temesvár banat, which strangely acquired this title after the peace of Passarowitz (1718), though it was never governed by a *ban*. The Banat is bounded E. by the Transylvanian Alps, S. by the Danube, W. by the Theiss and N. by the Maros, and has an



Banana (*Musa sapientum*).

area of 11,260 sq. m. It is mountainous in the south and south-east, while in the north, west and south-west it is flat and in some places marshy. The climate, except in the marshy parts, is generally healthy. It is well-watered, and forms one of the most fertile districts of Hungary. Wheat, barley, oats, rye, maize, flax, hemp and tobacco are grown in large quantities, and the products of the vineyards are of a good quality. Game is plentiful and the rivers swarm with fish. The mineral wealth is great, including copper, tin, lead, zinc, iron and especially coal. Amongst its numerous mineral springs, the most important are those of Mehadia, with sulphurous waters, which were already known in the Roman period as the *Thermae Herculis*. The Banat had in 1900 a population of 1,431,329 inhabitants. According to nationality there were 578,789 Rumanians, 362,487 Germans, 251,938 Servians and 170,124 Magyars. The chief town is Temesvár (pop. 53,033), and other places of importance are Versecz (25,109), Lugos (16,126), Nagybecskerek (26,407), Nagykikinda (24,843) and Pancsova (10,044).

The Banat was conquered by the Turks in 1552, and remained a Turkish sanjak (province) till 1716, when Prince Eugene of Savoy liberated it from the Turkish yoke. It received the title of Banat after the peace of Passarowitz (1718), and remained under a military administration until 1751, when Maria Theresa introduced a civil administration. During the Turkish occupation the district was nearly depopulated, and allowed to lie almost desolate in marsh and heath and forest. Count Claudius Mercy (1666-1734), who was appointed governor of Temesvár in 1720, took numerous measures for the regeneration of the Banat. The marshes near the Danube and Theiss were cleared, roads and canals were built at great expense of labour, German artisans and other settlers were attracted to colonize the district, and agriculture and trade encouraged. Maria Theresa also took a great interest in the Banat, colonized the land belonging to the crown with German peasants, founded many villages, encouraged the exploitation of the mineral wealth of the country, and generally developed the measures introduced by Mercy. In 1779 the Banat was again incorporated with Hungary. After the revolution of 1848-1849, the Banat together with another county (Bács) was separated from Hungary, and created into a distinctive Austrian crown land, but in 1860 it was definitely incorporated with Hungary.

See Leonhard Böhm, *Geschichte des Temeser Banats* (2 vols., Leipzig, 1861); Johann Heinrich Schwicker, *Geschichte des Temeser Banats* (Pest, 1872).

BANATE (a corruption of Panaiti, their real name), or BANCROFT, as they are now usually called, a tribe of North American Indians of Shoshonean stock. They were sometimes known as "Robber Indians." Their former range was southern Idaho and eastern Oregon. They are now divided between the Fort Hall and Lemhi reservations, Idaho. They were generally friendly with the whites, but in 1866 and in 1877-78 there were serious outbreaks. They number about 500.

BANBRIDGE, a town of Co. Down, Ireland, in the west parliamentary division, on the Bann, 23 m. S.W. of Belfast on a branch of the Great Northern railway, standing on an eminence. Pop. of urban district (1907) 5006. To mitigate a steep ascent, a central carriage-way, 200 yds. long, is cut along the main street to a depth of 15 ft., the opposite terraces being connected by a bridge. Banbridge is an entirely modern town. It is the principal seat of the linen trade in the county, and has extensive cloth and thread factories, bleachfields and chemical works. A memorial in Church Square commemorates the Franklin expedition to the discovery of the North-West Passage, and in particular Captain Francis Crozier, who was born at Banbridge in 1796 and served on the expedition.

BANBURY, a market-town and municipal borough in the Banbury parliamentary division of Oxfordshire, England, on the river Cherwell and the Oxford canal, 86 m. N.W. of London by the northern line of the Great Western railway. Pop. (1901) 12,968. The canal communicates northward with the Grand Junction and Warwick canals, and there are branch lines of the Great Central railway to the main line at Woodford, and of the

London & North-Western railway to Bletchley. The town is the centre of a rich agricultural district, and there is a large manufacture of agricultural implements; while other industries include rope and leather works and brewing. Banbury cakes, consisting of a case of pastry containing a mixture of currants, have a reputation of three centuries' standing. A magnificent Gothic parish church was destroyed by fire and gunpowder in 1790 to make way for a building of little merit in Italian style. The ancient Banbury Cross, celebrated in a familiar nursery rhyme, was destroyed by Puritans in 1610. During the 17th century the inhabitants of Banbury seem to have been zealous Puritans, and are frequently satirized by contemporary dramatists. At a somewhat earlier period the grammar school, now extinct, was of such repute as to be chosen as the model for the constitution of the school of St Paul's. A school of science was erected in 1861, and there is a municipal secondary and technical school. Some fine old timbered houses remain in the streets. Of the castle built in 1125 there are only the barest traces. Wroxton Abbey, 2 m. N.W., shows slight remains of the original Augustinian priory; but the present beautiful gabled building, picturesquely situated, dates mainly from 1618. Broughton Castle, 2½ m. S.W., is the most noteworthy house in the county. The oblong block of buildings, fronted by lawns, is surrounded by a moat and protected by a gate-house, part of which dates from 1301, at which date the chapel and a part of the house were also built. There is also work of the 15th century and the Elizabethan period. The house is the seat of Lord Saye and Sele, having been in the Fiennes family since the reign of Henry VII. (1485-1509). Here Pym and Hampden and other leaders of the Parliamentarians were wont to meet in 1640. Without the gate is a fine Decorated church. Banbury is governed by a mayor, 6 aldermen and 18 councillors. Area, 4633 acres.

In the year 556 Banbury (Beranbyrig, Banesberie) was the scene of a battle between Cynric and Ceawlin and Britons. It was assessed at 50 hides in the Domesday survey and was then held by the bishop of Lincoln. Allusions to the market occur as early as 1138, and Henry II. by charter confirmed a market on Thursday and granted a fair at Whitsun. The first charter of incorporation was granted by Queen Mary in 1553, and instituted a common council consisting of a bailiff, 12 aldermen and 12 chief burgesses; a court of record, one justice of the peace, a Thursday market and two annual fairs. James I. confirmed this charter in 1608, with some additions, including a weekly wool-market, a horse-market and two additional annual fairs. Both these charters were surrendered in 1683 in favour of a new charter, but were resumed in 1688. In 1718 George I. granted a new charter, which held until the Municipal Corporations Act of 1835. From the date of Queen Mary's charter until the Redistribution of Seats Act of 1885 the borough was represented by one member in parliament.

See Alfred Beesley, *History of Banbury* (London, 1841).

BANCHIERI, ADRIANO (c. 1557-1634), Bolognese composer for church and stage, organist, writer on music and poet. He founded the Accademia Florida of Bologna. Like Orazio Vecchi he was interested in converting the madrigal to dramatic purposes. He disapproved of the monodists with all their revolutionary harmonic tendencies, about which he expressed himself vigorously in his *Moderna Pratica Musicale* (Venice, 1613), while systematizing the legitimate use of the monodic art of thorough-bass.

BANCROFT, GEORGE (1800-1891), American historian and statesman, was born in Worcester, Mass., on the 3rd of October 1800. His family had been in America since 1632, and his father, Aaron Bancroft, was distinguished as a revolutionary soldier, clergyman and author. The son was educated at Phillips Academy, Exeter, at Harvard University, at Heidelberg, Göttingen and Berlin. At Göttingen he studied Plato with Heeren, New Testament Greek with Eichhorn and natural science with Blumenbach. His heart was in the work of Heeren, easily the greatest of historical critics then living, and the forerunner of the modern school; it was from this master that Bancroft caught his enthusiasm for minute pains-taking erudition. He concluded his years of preparation by a European tour, in the

course of which he received kind attention from almost every distinguished man in the world of letters, science and art; among others, from Goethe, Humboldt, Schliermacher, Hegel, Byron, Niebuhr, Bunsen, Savigny, Cousin, Constant and Manzoni. Bancroft's father was a Unitarian, and he had devoted his son to the work of the ministry; but the young man's first experiments at preaching, shortly after his return from Europe in 1822, were unsatisfactory, the theological teaching of the time having substituted criticism and literature for faith. His first position was that of tutor in Harvard. Instinctively a humanist, he had little patience with the narrow curriculum of Harvard in his day and the rather pedantic spirit with which classical studies were there pursued. Moreover, he had brought from Europe a new manner, full of the affections of ardent youth, and this he wore without ease in a society highly satisfied with itself; the young knight-errant was therefore subjected to considerable ridicule. A little volume of poetry, translations and original pieces, published in 1823 gave its author no fame. As time passed, and custom created familiarity, his style, personal and literary, was seen to be the outward symbol of a firm resolve to preserve a philosophic calm, and of an enormous underlying energy which spent itself in labour, "ohne Hast, aber auch ohne Rast." He found the conventional atmosphere of Cambridge ungenial, and with a friend he established the Round Hill school at Northampton, Mass. This was the first serious effort made in the United States to elevate secondary education to the plane on which it belonged.

Although born into a Whig family, yet Bancroft's studies carried him irresistibly into the Democratic party. While a teacher in his own school he was elected to the state legislature as a Democrat, but under pressure from the family of his first wife, who were ardent Whigs, he refused to serve. In 1831 he likewise declined the nomination of the Massachusetts Democrats for secretary of state. By this time he was influential in the councils of his party, and President Van Buren appointed him collector of the port of Boston, a position which he filled with success. Two of his appointees were Orestes Brownson and Nathaniel Hawthorne. In 1844 he was the Democratic candidate for the governorship, but he was defeated. In 1845 he entered Polk's cabinet as secretary of the navy, serving until 1846, when for a month he was acting secretary of war. During this short period in the cabinet he established the naval academy at Annapolis, gave the orders which led to the occupation of California, and sent Zachary Taylor into the debatable land between Texas and Mexico. He also continued his pleadings for the annexation of Texas, as extending "the area of freedom," and though a Democrat, took high moral ground as to slavery; he likewise made himself the authority on the North-Western Boundary question. In 1846 he was sent as minister to London, where he lived in constant companionship with Macaulay and Hallam. On his return in 1849 he withdrew from public life, residing in New York. In 1866 he was chosen by Congress to deliver the special eulogy on Lincoln; and in 1867 he was appointed minister to Berlin, where he remained until his resignation in 1874. Thenceforward he lived in Washington and Newport, dying at Washington on the 17th of January 1891. His latest official achievements were the greatest. In the San Juan arbitration he displayed great versatility and skill, winning his case before the emperor with brilliant ease. The naturalization treaties which he negotiated successively with Prussia and the other north German states were the first international recognition of the right of expatriation, a principle since incorporated in the law of nations.

In spite of the exacting and severe routine of the Round Hill school, Bancroft contributed frequently to the *North American Review* and to Walsh's *American Quarterly*; he also made a translation of Heeren's work on *The Politics of Ancient Greece*. In 1834 appeared the first volume of the *History of the United States*. The second followed in 1837, and others as the exigencies of public life permitted. Supplementary to the first volume was an article published by him in the *North American Review* for 1835 on "The Documentary History of the Revolution." This

article not merely brought the new method to the notice of the reading public, but revealed to it the wealth of material available. The nature and extent of his studies, the solidity of his work, and the philosophic spirit which animates both, explain the enthusiasm with which the earlier volumes of Bancroft were received. Their sale at home was very large; they were reprinted in England and translated immediately into Danish, Italian, German and French. The latest volumes were considered by all competent judges quite as important as their predecessors. When the author was preparing to return from Berlin, the Royal Academy made him their guest at a public dinner, an unprecedented honour; and the universities of Berlin, Heidelberg and Munich united in a testimonial of regard. At Washington he was the confidential advisor of statesmen to the end of his life and the unofficial dean of the best society.

Bancroft's historical creed is best set forth in the address he delivered on the semi-centennial of the New York Historical Society in 1854. In philosophy he found the basis for positing a collective human will, revealing in its activities the materials for determining ethical laws. Since there must be the same conservation of energy in morals as elsewhere, the eternal reason is the divine Logos. History, therefore, is God working in examples. It must be a unit, its forces constant and its totality an organic whole. Within this the individual moves and acts with liberty and responsibility; for each, in will, affection and intellect is consubstantial with the rest. Truth, morals and justice are subject to no evolution; but the collective man evolves better forms of knowledge and behaviour. The organization of society, therefore, produces successive states, in each of which the principle of freedom is better established than in the antecedent. Permanency in republican government is, therefore, based upon corresponding experience and culture, and its possibilities grow ever stronger. The relation of American democracy to the systems which have preceded it forms the latest proof of these contentions. As Heeren's pupil, he laid enormous stress on the importance of original authorities. In dealing with documentary evidence he sought to apply very stringent rules:—(1) Carefully distinguish between original authority and historical memorials or aids; for example, between a fact recorded at first- or second-hand knowledge, and a decision of principle by authority. (2) Represent every man from his own standpoint; judge him from your own. His collections of original materials were vast; beginning with his residence in England, he brought together at enormous pains and expense the authenticated copies of archives, family papers, and personal journals written by historic personages, which now constitute an invaluable treasure in the New York public library. They are from every land and from every people with which American origins are connected. His use of this material was not always according to accepted standards. To avoid dryness and prolixity he condensed quotations, and occasionally employed the Thucydidean method of abridgment or representation in place of fact catalogues. During his long life enormous strides were made by others in collecting the materials of American history, and while in the main he kept pace with them by ruthless revision, yet even the latest edition of his work disregards some minor facts which others knew for the insertion of much which the author alone knew.

Bancroft's imagination and enthusiasm were alike exuberant. His pages abound in fine and acute insight. His generalizations are vivid and enlightening. He spared no pains to acquire true style, frequently rewriting his chapters, and sometimes testing passages of philosophy and description in eight different forms. Yet to a certain extent he lacked the representative power and often failed to conceal his art, many pages ringing with artificial tones. But, after making all allowances, it remains true that he had a perfect sense of proportion, sound maxims and thorough common-sense. He was of that greatest human type: a man of the present, valuing justly the past and no dreamer. In the nature and extent of his studies, in the solidity of his work, and in the philosophic spirit which animated his life he ranks as the foremost historian of the United States, and as an American historian second to none of his European contemporaries in

the same line. He displayed the heroic, epic value of American history, its unity with the great central stream, and dispelled for ever the extravagant conceptions of a sentimental world just emerging from the visionary philosophy of the 18th century.

See M. A. de Wolfe Howe, *The Life and Letters of George Bancroft* (New York, 1908).

BANCROFT, HUBERT HOWE (1832—), American historical writer, was born at Granville, Ohio, on the 5th of May 1832. From 1852 to 1868 he was a bookseller in San Francisco. During this period he accumulated a great library of historical material, and at last gave up business in order to devote himself to the publication of his *Native Races of the Pacific States* (5 vols. 1874–1876), *History of the Pacific States of North America* (2 vols. 1882–1890), and other works. For the collection of data he necessarily relied upon the labours of a corps of assistants, and the publications named represent, properly speaking, an encyclopaedia rather than a unified history; but as a storehouse of material their value is great and is likely to be enduring. In 1905 Bancroft's vast collection was acquired by the university of California. An account of his methods of work is given in his *Literary Industries* (1890).

BANCROFT, RICHARD (1544–1610), archbishop of Canterbury, was born at Farnworth in Lancashire in 1544. He was educated at Cambridge, first at Christ's College and afterwards at Jesus College. He took his degree of B.A. in 1567 and that of M.A. in 1570. Ordained about that time, he was named chaplain to Richard Cox, then bishop of Ely, and in 1575 was presented to the rectory of Teversham in Cambridgeshire. The next year he was one of the preachers to the university, and in 1584 was presented to the rectory of St Andrew's, Holborn. His abilities, and his zeal as a champion of the church, secured him rapid promotion. He graduated B.D. in 1580 and D.D. five years later. In 1585 he was appointed treasurer of St Paul's cathedral, London, and in 1586 was made a member of the ecclesiastical commission. On the 9th of February 1589 he preached at Paul's Cross a sermon on 1 John iv. 1, the substance of which was a passionate attack on the Puritans. He described their speeches and proceedings, caricatured their motives, denounced the exercise of the right of private judgment, and set forth the divine right of bishops in such strong language that one of the queen's councillors held it to amount to a threat against the supremacy of the crown. In the following year Bancroft was made a prebendary of St Paul's; he had been canon of Westminster since 1587. He was chaplain successively to Lord Chancellor Hatton and Archbishop Whitgift. In June 1597 he was consecrated bishop of London; and from this time, in consequence of the age and incapacity for business of Archbishop Whitgift, he was virtually invested with the power of primate, and had the sole management of ecclesiastical affairs. Among the more noteworthy cases which fell under his direction were the proceedings against "Martin Mar-Prelate," Thomas Cartwright and his friends, and John Penry, whose "seditious writings" he caused to be intercepted and given up to the lord keeper. In 1600 he was sent on an embassy, with others, to Emblen, for the purpose of settling certain matters in dispute between the English and the Danes. This mission, however, failed. Bancroft was present at the death of Queen Elizabeth. He took a prominent and truculent part in the famous conference of prelates and Presbyterian divines held at Hampton Court in 1604. By the king's desire he undertook the vindication of the practices of confirmation, absolution, private baptism and lay excommunication; he urged, but in vain, the reinforcement of an ancient canon, "that schismatics are not to be heard against bishops"; and in opposition to the Puritans' demand for certain alterations in doctrine and discipline, he besought the king that care might be taken for a *praying clergy*; and that, till men of learning and sufficiency could be found, godly homilies might be read and their number increased. In March 1604 Bancroft, on Whitgift's death, was appointed by royal writ president of convocation then assembled; and he there presented a book of canons collected by himself. It was adopted and received the royal approval, but was strongly opposed and set aside by

parliament two months afterwards. In the following November he was elected successor to Whitgift in the see of Canterbury. He continued to show the same zeal and severity as before, and with so much success that Lord Clarendon, writing in his praise, expressed the opinion that "if Bancroft had lived, he would quickly have extinguished all that fire in England which had been kindled at Geneva." He was as lenient with the offences of the orthodox as he was rigid in suppressing heresy and schism. In 1605 he was sworn a member of the privy council. The same year he engaged in a contest with the judges, and exhibited articles of complaint against them before the lords of the council; but these complaints were overruled. His aim was really to make the ecclesiastical courts independent of the law by speciously magnifying the royal authority over them. He enforced discipline and exact conformity within the church with an iron hand; and over 200 clergymen were deprived of their livings for disobedience to the *ex animo* form of subscription. In 1608 he was chosen chancellor of the university of Oxford. One of his latest public acts was a proposal laid before parliament for improving the revenues of the church, and a project for a college of controversial divinity at Chelsea. In the last few months of his life he took part in the discussion about the consecration of certain Scottish bishops, and it was in pursuance of his advice that they were consecrated by several bishops of the English church. By this act were laid the foundations of the Scottish Episcopal church. Bancroft was "the chief overseer" of the authorized version of the Bible. He died at Lambeth Palace on the 2nd of November 1610. His literary remains are not extensive, but show him to have been an able writer.

BANCROFT, SIR SQUIRE (1841—), English actor and manager, was born near London on the 14th of May 1841. His first appearance on the stage was in 1861 at Birmingham, and he played in the provinces with success for several years. His first London appearance was in 1865 in Wooler's *A Winning Hazard* at the Prince of Wales's theatre off Tottenham Court Road, then under the management of Effie Marie Wilton (b. 1840), whom he married in 1868. Mr and Mrs Bancroft were associated in the production of all the Robertson comedies:—*Society* (1865), *Ours* (1866), *Caste* (1867), *Play* (1868), *School* (1869) and *M.P.* (1870), and, after Robertson's death, in revivals of the old comedies, for which they surrounded themselves with an admirable company. Lytton's *Money* (1872), Boucicault's *London Assurance* (1877), and *Diplomacy*—an adaptation of Sardou's *Dora*—were among their *premieres*, which helped to make the little playhouse famous. The Bancroft management at the Prince of Wales's constituted a new era in the development of the English stage, and had the effect of reviving the London interest in modern drama. In 1879 they moved to the Haymarket, where Sardou's *Odette* (for which they engaged Madame Modjeska) and *Fedora*, W. S. Gilbert's *Sweethearts* and Pinero's *Lords and Commons*, with revivals of previous successes, were among their productions. Having made a considerable fortune, they retired in 1885, but Mr Bancroft (who was knighted in 1897) joined Sir Henry Irving in 1889 to play the abbé Latour in a revival of Watts Phillips's *Dead Heart*.

See *Mr and Mrs Bancroft, on and off the Stage* (1888), and *The Bancrofts: Recollections of Sixty Years* (1909), by themselves.

BAND, something which "binds" or fastens one thing to another, hence a cord, rope or tie, e.g. the straps fastening the sheets to the back in book-binding. The word is a variant of "bond," and is from the stem of the Teutonic *bindan*, to bind. From the same source comes "bend," properly to fasten the string to the bow, so as to constrain and curve it, hence to make into the shape of a "bent" bow, to curve. In the sense of "strap," a flat strip of material, properly for fastening anything, the word is ultimately of the same origin but comes directly into English from the French *bande*. In architecture the term is applied to a sort of flat frieze or fascia running horizontally round a tower or other parts of a building, particularly the base tables in perpendicular work, commonly used with the long shafts characteristic of the 13th century. It generally has a bold, projecting moulding above and below, and is carved

sometimes with foliages, but in general with cusped circles or quatrefoils, in which frequently are shields of arms.

The two small strips of linen, worn at the neck as part of legal, clerical and academic dress, are known as "bands"; they are the survival of the falling collar of the 17th century. These bands are usually of white linen, but the secular clergy of the Roman Church wear black bands edged with white. The light cardboard or chip boxes now used to carry millinery were formerly made to carry the neck-bands, whence the name of "band-box."

In the sense of company or troop, "band" is probably also connected with *bindan*, to bind. It came into English from the French. The meaning seems to have originated in Romanic, cf. Italian, Spanish and Portuguese *banda*, and thence came into Teutonic. It has usually been taken (see Ducange, *Gloss. s.v. banda*) to be due to the "band" or sash of a particular colour worn as a distinctive mark by a troop of soldiers. Others refer it to the medieval Latin *bandum*, banner, a strip or "band" of cloth fastened to a pole. In this sense the chief application is to a company of musicians (see ORCHESTRA), particularly when used in armies or navies, a military band.

Military Bands.—In all countries bands are organized and maintained in each infantry regiment or battalion if the latter is the unit. The strength of these bands and the number and nature of their instruments vary considerably, as also do the rank and status of the bandmaster. The buglers and drummers belonging to the companies are generally massed under the sergeant-drummer and on the march play alternately with the band. In action the British custom is to use the bandsmen as stretcher-bearers, but on the continent of Europe the bands are as far as possible kept in hand under the regimental commanders and play the troops into action; and in all countries the available bands, drums and bugles are ordered to play during the final assault. The training of bandmasters for the British service is carried out at Kneller Hall, Hounslow, an institution founded in 1857 and placed under direct control of the war office in 1867. The average strength of the various classes of instrument in the band of a British line regiment has been stated as—twenty flutes, oboes, clarinets and bassoons, four horns, eight saxhorns, six trumpets and cornets, three trombones, two drums. The buglers and drummers are in the proportion of one of each per company. The saxophone, which is the characteristic instrument of military bands in other countries, has not found favour with the British authorities. Another specially military instrument, universal in the Russian army and more or less common to others, is the so-called "Jingling Johnny," a frame of small bells that is sharply shaken in the accented parts of the music. The "glockenspiel" is also fairly common. The peculiar instrument of Scottish regiments is the bagpipes. Cavalry, and more rarely artillery corps in the various armies, have small bands. The mounted arms, however, have little need of music as compared with the infantry, the order and ease of whose marching powers are immensely enhanced by the music of a good regimental band. In the navies of various countries bands are maintained on board flag-ships and sometimes on board other large ships.

BANDA, a town and district of British India, in the Allahabad division of the United Provinces. The town is near the right bank of the river Ken, 95 m. S. W. of Allahabad. The population in 1901 was 22,565. The town possesses 65 mosques and 168 Hindu temples. It was formerly, but is no longer, a military cantonment.

The district is the most barren and backward portion of the province. It contains an area of 3061 sq. m. In some parts it rises into irregular uplands and elevated plains, interspersed with detached rocks of granite; in others it sinks into marshy lowlands, which frequently remain under water during the rainy season. The sloping country on the bank of the Jumna is full of ravines. To the S.E. the Vindhya chain of hills takes its origin in a low range not exceeding 500 ft. in height, and forming a natural boundary of the district in that direction. The principal river of the district is the Jumna, which flows from

north-west to south-east, along the N.E. boundary of the district, for 125 m. In 1901 the population was 631,058, showing a decrease of 11% in the decade, due to the effects of famine. The black soil of the district yields crops of which the principal are millet, other food-grains, pulse, rice, cotton and oil-seeds. Banda cotton enjoys a high repute in the market. A branch railway from Manikpur to Jhansi traverses the length of the district, which is also crossed by the East Indian main line to Jubbulpore.

Banda, which forms one of the districts included under the general name of Bundelkhand, has formed an arena of contention for the successive races who have struggled for the sovereignty of India. Kalinjar town, then the capital, was unsuccessfully besieged by Mahmud of Ghazni in A.D. 1023; in 1196 it was taken by Kutab-ud-din, the general of Muhammad Ghori; in 1545 by Shere Shah, who, however, fell mortally wounded in the assault. About the year 1735 the raja of Kalinjar's territory, including the present district of Banda, was bequeathed to Bajji Rao, the Mahratta peshwa; and from the Mahrattas it passed by the treaties of 1802-1803 to the Company. At the time of the Mutiny the district, which was poverty-stricken and over-taxed, joined the rebels. The town of Banda was recovered by General Whitlock on the 20th of April 1858. The fiscal system was remodelled, and the district has since enjoyed a greater degree of prosperity only interrupted by famine.

BANDA ISLANDS, a group of the Dutch East Indies, consisting of three chief and several lesser islands in the Banda Sea, south of Ceram, belonging to the residency of Amboyna. The main islands are Great Banda or Lontor; Banda Neira to its north; Gunong Api, west of Banda Neira; Wai or Ai still farther west, with Run on its south-west; Pisang, north of Gunong Api; and Suwangi, north-west again. The total land area is about 16 sq. m. A volcanic formation is apparent in Lontor, a sickle-shaped island which, with Neira and Gunong Api, forms part of the circle of a crater. The arrangement is comparable with Santorin in the Aegean Sea. Gunong Api (Fire Mountain), 2200 ft. high, is an active volcano, and its eruptions and earthquakes have frequently brought destruction, as notably in 1852, when the damage was chiefly due to a huge wave of the sea. Banda, the chief town, on Neira, is a pleasant settlement, commanded by two Dutch forts of the early 17th century, Nassau and Belgica. The largest island, Lontor, was found too unhealthy to be the site of the principal settlement; but the climate of the islands generally, though hot, is not unhealthy. In the space between Lontor, Neira and Gunong Api there is a good harbour, with entrances on either side, which enable vessels to enter on either of the monsoons. Between Gunong Api and Neira there is a third channel, but it is navigable for small vessels only. The principal articles of commerce in the Banda group are nutmegs and mace. The nutmeg is indigenous. The native population having been cleared off by the Dutch, the plantations were worked by slaves and convicts till the emancipation of 1860. The introduction of Malay and Chinese labourers subsequently took place. The plantations (*perken*) were originally held by the conquerors of the natives, the government monopolizing the produce at a fixed rate; but in 1873 the government monopoly was abolished. The production amounts annually to nearly 1,500,000 lb. of nutmegs, and 350,000 lb. of mace. The nutmegs are grown, in accordance with natural conditions, under the shade of other trees, usually the *canari*. Jalti or jattu wood is cultivated on the small island of Rosingen. The total population of the islands is about 9500, of which some 7000 are descendants of the natives introduced as slaves from neighbouring islands, and are Christians or Mahomedans.

The Banda Islands were discovered and annexed by the Portuguese Antonio D'Abreu in 1512; but in the beginning of the 17th century his countrymen were expelled by the Dutch. In 1608 the British built a factory on Wai, which was demolished by the Dutch as soon as the English vessel left. Shortly after, however, Banda Neira and Lontor were resigned by the natives to the British, and in 1620 Run and Wai were added to their dominions; but in spite of treaties into which they had entered

the Dutch attacked and expelled their British rivals. In 1654 they were compelled by Cromwell to restore Run, and to make satisfaction for the massacre of Amboyna; but the English settlers not being adequately supported from home, the island was retaken by the Dutch in 1664. They remained in undisturbed possession until 1796, when the Banda Islands were taken by the British. They were restored by the treaty of Amiens in the year 1800, again captured, and finally restored by the treaty of Paris concluded in 1814.

BANDANA, or **BANDANNA**, a word probably derived through the Portuguese from the Hindustani *bāndhnā*, which signified a primitive method of obtaining an effect in dyeing by tying up cloth in different places to prevent the particular parts from receiving the dye. The name was given to richly coloured silk handkerchiefs produced by this process, of which bright colours were characteristic. Bandanas are now commonly made of cotton and produced in Lancashire, whence they are exported. The effect is also produced by a regular process in calico printing, in which the pattern is made by discharging the colour.

BANDELIER, ADOLPH FRANCIS ALPHONSE (1840–), American archaeologist, was born in Bern, Switzerland, on the 6th of August 1840. When a youth he emigrated to the United States. After 1880 he devoted himself to archaeological and ethnological work among the Indians of the south-western United States, Mexico and South America. Beginning his studies in Sonora (Mexico), Arizona and New Mexico, he made himself the leading authority on the history of this region, and—with F. H. Cushing and his successors—one of the leading authorities on its prehistoric civilization. In 1892 he abandoned this field for Ecuador, Bolivia and Peru, where he continued ethnological, archaeological and historical investigations. In the first field he was in a part of his work connected with the Hemenway Archaeological Expedition and in the second worked for Henry Villard of New York, and for the American Museum of Natural History of the same city. Bandelier has shown the falsity of various historical myths, notably in his conclusions respecting the Inca civilization of Peru. His publications include: three studies "On the Art of War and Mode of Warfare of the Ancient Mexicans," "On the Distribution and Tenure of Lands and the Customs with respect to Inheritance among the Ancient Mexicans," and "On the Social Organization and Mode of Government of the Ancient Mexicans" (Harvard University, Peabody Museum of American Archaeology and Ethnology, *Annual Reports*, 1877, 1878, 1879); *Historical Introduction to Studies among the Seditary Indians of New Mexico, and Report on the Ruins of the Pueblo of Pecos* (1881); *Report of an Archaeological Tour in Mexico in 1881* (1884); *Final Report of Investigations among the Indians of the South-western United States* (1890–1892, 2 vols.); *Contributions to the History of the South-western Portion of the United States carried on mainly in the years from 1880 to 1885* (1890),—all these in the *Papers of the Archaeological Institute of America, American Series*, constituting vols. i.–v.; "The Romantic School of American Archaeologists" (New York Historical Society, 1885); *The Gilded Man (El Dorado) and other Pictures of the Spanish Occupancy of America* (1893); and a report *On the Relative Antiquity of Ancient Peruvian Burials* (American Museum of Natural History, Bulletin, v. 30, 1904). He also edited *The Journey of Alvar Nuñez Cabeza de Vaca . . . from Florida to the Pacific, 1528–1536* (1905), translated into English by his wife.

BANDELLO, MATTEO (1480–1562), Italian novelist, was born at Castelnuovo, near Tortona, about the year 1480. He received a very careful education, and entered the church, though he does not seem to have prosecuted his theological course with great zeal. For many years he resided at Mantua, and superintended the education of the celebrated Lucrezia Gonzaga, in whose honour he composed a long poem. The decisive battle of Pavia, which gave Lombardy into the hands of the emperor, compelled Bandello to fly; his house at Milan was burnt and his property confiscated. He took refuge with Cesare Fresgo, an Italian general in the French service, whom he accompanied into France. In 1550 he was raised to the bishopric of Agen, a town in which

he resided for many years before his death in 1562. Bandello wrote a number of poems, but his fame rests entirely upon his extensive collection of *Novelle*, or tales (1554, 1573), which have been extremely popular. They belong to that species of literature of which Boccaccio's *Decameron* and the queen of Navarre's *Heptameron* are, perhaps, the best known examples. The common origin of them all is to be found in the old French *fabliaux*, though some well-known tales are evidently Eastern, and others classical. Bandello's novels are esteemed the best of those written in imitation of the *Decameron*, though Italian critics find fault with them for negligence and inelegance of style. They have little value from a purely literary point of view, and many of them are disfigured by the grossest obscenity. Historically, however, they are of no little interest, not only from the insight into the social life of the period which they afford, but from the important influence they exercised on the Elizabethan drama. The stories on which Shakespeare based several of his plays were supplied by Bandello, probably through Belleforest or Paynter.

BANDER ABBĀSI (also **BENDER ABBAS**, and other forms), a town of Persia, on the northern shore of the Persian Gulf in 27° 11' N., and 56° 17' E., forming part of the administrative division of the "Persian Gulf ports," whose governor resides at Bushire. It has a population of about 10,000, an insalubrious climate and bad water.

Bandar Abbāsi was called Gombrun (Gombrun, Gamaroon; Cambarāo, Comoroāo of Portuguese writers) until 1622, when it received its present name (the "port of Abbas") in honour of the reigning shah, Abbas I., who had expelled the Portuguese in 1614, and destroyed the fort built by them in 1612. The English, however, were permitted to build a factory there, and about 1620 the Dutch obtained the same privilege. On the capture of the island of Hormuz (Ormuz) in 1622 by the English and Persians a large portion of its trade was transferred to Bandar Abbāsi. During the remainder of the 17th century the traffic was considerable, but in the 18th prosperity declined and most of the trade was removed to Bushire. In 1750 the English factory was destroyed by the French, and though afterwards re-established it has long been abandoned. The ruins of the factory and other buildings lie west of the present town. About 1740 Nadir Shah granted the town and district with the fort of Shamil and the town of Mināb, together with the islands of Kishm, Hormuz (Ormuz) and Lārāk, to the Arab tribe of the Beni Ma'ini in return for a payment of a yearly rent or tribute. About 40 years later Sultan bin Ahmad, the ruler of Muscat, having been appealed to for aid by the Arab inhabitants of the place against Persian misrule, occupied the town, and obtained a firman from the Persian government confirming him in his possession on the condition of his paying a yearly rent of a few thousand tomans. The islands were considered to be the property of Muscat. In 1852 the Persians expelled the Muscat authorities from Bandar Abbāsi and its district, but retired when Muscat agreed to pay an increased rent. By a treaty concluded between Persia and Muscat in 1856 it was stipulated that Bandar Abbāsi town and district and the islands were to be considered Persian territory and leased to Muscat at an annual rent of 14,000 tomans (£6000). The treaty was to have been in force for twenty years, but in 1866 the Persians took advantage of the assassination of Seyed Thuweini, the sultan of Muscat, to instal as governor of Bandar Abbāsi and district a nominee of their own who agreed to pay a rent of 20,000 tomans per annum. Further difficulties arising between Persia and Muscat, and the ruler of the latter, then in possession of a powerful fleet, threatening to blockade Bandar Abbāsi, the Persian government solicited the good offices of the British government, and the lease was renewed for another eight years upon payment of 30,000 tomans per annum (then about £12,000). This was in 1868. In the same year, however, the sultan of Muscat was expelled by a successful revolt, and the Persian government, in virtue of a clause in the lease allowing them to cancel the contract if a conqueror obtained possession of Muscat, installed their own governor at Bandar Abbāsi and

have retained possession of the place ever since (see Curzon, *Persia*, ii. 424).

Bander Abbási has a lively trade, exporting much of the produce of central and south-eastern Persia and supplying imports to those districts and Khorasan. It has telegraph and post offices, and the mail steamers of the British India Steam Navigation Company call at the port weekly. Great Britain and Russia are represented there by consuls. From 1890-1905 the total value of the exports and imports from and into Bander Abbási averaged about £660,000 per annum, £260,000 (£1,55,000 British) being for exports, £400,000 (£340,000 British) imports. Of the 2,55,000 tons of shipping which in 1905 entered Bander Abbási 237,000 were British. (A. H.-S.)

BANDER LINGAH, or LINGA, a town of Persia on the northern shore of the Persian Gulf and about 300 m. by sea from Bushire, in 26° 33' N., 54° 54' E. Pop. about 10,000. It forms part of the administrative divisions of the "Persian Gulf ports," whose governor resides at Bushire. The annual value of the exports and imports from and into Bander Lingah from 1890 to 1905 averaged about £800,000, but nearly half of that amount is represented by pearls which pass in transit from the fisheries on the Arab coast to Bombay. Like many other Persian Gulf ports, Bander Lingah was for many generations a hereditary patrimony of the Sheikh of an Arab tribe, in this case the Juvasmi tribe, and it was only in 1898 that the Arabs were expelled from the place by a Persian force. It is the chief port for the Persian province of Lárístan (under Fars), and has a thriving trade with Bahrein and the Arab coast. It has a British post office, and the steamers of the British India Company call there weekly. Of the 133,000 tons of shipping which in 1905 entered the port 104,500 were British.

BANDEROLE (Fr. for a "little banner"), a small flag or streamer carried on the lance of a knight, or flying from the mast-head of a ship in battle, &c.; in heraldry, a streamer hanging from beneath the crook of a bishop's crosier and folding over the staff; in architecture, a band used in decorative sculpture of the Renaissance period for bearing an inscription, &c. Bannerol, in its main uses the same as banderole, is the term especially applied to the square banners carried at the funerals of great men and placed over the tomb.

BANDICOOT, any animal of the marsupial genus *Perameles*, which is the type of a family *Peramelidae*. The species, about a dozen in number, are widely distributed over Australia, Tasmania, New Guinea and several of the adjacent islands. They are of small size and live entirely on the ground, making nests of dried leaves, grass and sticks in hollow places and forming burrows in which they pass a great part of the day. Though feeding largely on worms and insects they ravage gardens and fields, on which account they are detested by the colonists. The name is often extended to the family.

BANDICOOT-RAT, the Anglo-Indian name for a large rat (*Nesocia bandicota*), inhabiting India and Ceylon, which measures from 12 to 15 in. to the root of the tail, while the tail itself measures from 11 to 13 in. The name is said to be a corruption of the Telegu *pandi-koku*. It differs from typical rats of the genus *Mus* by its broader incisors, and the less distinct cusps on the molars. Other species of the genus are found from Palestine to Formosa, as well as in central Asia. The typical species frequents villages, towns and cultivated grounds all over India and Ceylon, but is especially common in the south of the peninsula. (See *RODENTIA*.)

BANDIERA, **ATTILIO** (1811-1844) and **EMILIO** (1819-1844), Italian patriots. The brothers Bandiera, sons of Baron Bandiera, an admiral in the Austrian navy, were themselves members of that service, but at an early age they were won over to the ideas of Italian freedom and unity, and corresponded with Giuseppe Mazzini and other members of the *Giovane Italia* (Young Italy), a patriotic and revolutionary secret society. During the year 1843 the air was full of conspiracies, and various ill-starred attempts at rising against the Italian despots were made. The Bandieras began to make propaganda among the officers and men of the Austrian navy, nearly all Italians, and actually planned to

seize a warship and bombard Messina. But having been betrayed they fled to Corfu early in 1844. Rumours reached them there of agitation in the Neapolitan kingdom, where the people were represented as ready to rise *en masse* at the first appearance of a leader; the Bandieras, encouraged by Mazzini, consequently determined to make a raid on the Calabrian coast. They got together a band of about twenty men ready to sacrifice their lives for an idea, and set sail on their desperate venture on the 12th of June 1844. Four days later they landed near Cotrone, intending to go to Cosenza, liberate the political prisoners and issue their proclamations. But they did not find the insurgent band which they had been told awaited them, and were betrayed by one of their party, the Corsican Boccheciampe, and by some peasants who believed them to be Turkish pirates. A detachment of gendarmes and volunteers was sent against them, and after a short fight the whole band were taken prisoners and escorted to Cosenza, where a number of Calabrians who had taken part in a previous rising were also under arrest. First the Calabrians were tried by court-martial, and a large number condemned to death or the galleys. The raiders' turn came next, and the whole party, save the traitor Boccheciampe, were condemned to be shot, but in the case of eight of them the sentence was commuted to the galleys. On the 23rd of July the two Bandieras and their nine companions were executed; they cried *Viva l'Italia!* as they fell.

The Neapolitan government was undoubtedly within its right in executing the Bandieras, and the material results of this heroic but unpractical attempt were nil. But the moral effect was enormous throughout Italy, the action of the authorities was universally condemned, and the martyrdom of the Bandieras bore fruit in subsequent revolutions. It also created a great impression in England, where it was believed that the Bandieras' correspondence with Mazzini (*q.v.*) had been tampered with, and that information as to the proposed expedition had been forwarded to the Austrian and Neapolitan governments by the British foreign office; recent publications, however, especially the biography of Sir James Graham, tend to exculpate the British government.

See G. Ricciardi, *Storia dei Fratelli Bandiera* (Florence, 1863); F. Venosta, *I Fratelli Bandiera* (Milan, 1864); and Carlo Tivaroni's *L'Italia durante il dominio austriaco*, vol. iii. p. 149 (Turin, 1892). (L. V.)*

BANDINELLI, **BARTOLOMEO** or **BACCIO** (1493-1560), Florentine sculptor, was the son of an eminent goldsmith, and from him Bandinelli obtained the first elements of drawing. Showing a strong inclination for the fine arts, he was early placed under Rustici, a sculptor, and a friend of Leonardo da Vinci, with whom he made rapid progress. The ruling motive in his life seems to have been jealousy both of Benvenuto Cellini and of Michelangelo, one of whose cartoons he is said to have torn up and destroyed. He is regarded by some as inferior in sculpture only to Michelangelo, with whom a comparison unfavourable to Bandinelli is tempted in such works as the marble colossal group of Hercules and Cacus in the Piazza del Gran Duco, and the group of Adam and Eve in the Bargello. Among his best works must be reckoned the *bassi-relievi* in the choir of the cathedral of Florence; his copy of the Laocoon; and the figures of Christ and Nicodemus on his own tomb.

BANDINI, **ANGELO MARIA** (1726-1800), Italian author, was born at Florence on the 25th of September 1726. Having been left an orphan in his infancy, he was supported by his uncle, Giuseppe Bandini, a lawyer of some note. He received his education among the Jesuits, and showed a special inclination for the study of antiquities. His first work was a dissertation, *De Veterum Sallustianibus* (1749). In 1747 he undertook a journey to Vienna, in company with the bishop of Volterra, to whom he acted in the capacity of secretary. He was introduced to the emperor and took the opportunity of dedicating to that monarch his *Specimen Litterarum Florentinae*, which was then printing at Florence. On his return he took orders, and settled at Rome, passing the whole of his time in the library of the Vatican, and in those of the cardinals Passionei and Corsini. The famous obelisk

of Augustus, at that time disinterred from the ruins of the Campus Martius, was described by Bandini in a learned folio volume *De Obelisco Augusti*. Shortly after he was compelled to leave Rome on account of his health and returned to Florence, where he was appointed librarian to the valuable library bequeathed to the public by the abbé Marucelli. In 1756 he was preferred by the emperor to a prebend at Florence, and appointed principal librarian to the Laurentian library. During forty-four years he continued to discharge the duties of this situation, and died in 1800, generally esteemed and regretted. On his deathbed he founded a public school, and bequeathed the remainder of his fortune to other charitable purposes. The most important of his numerous works are the *Catalogus Codd. MSS. Graec., Lat., Ital., Bib., Laurent.*, 8 vols (1767–1778), and the *Vita e Lettere d' Amerigo Vespucci*, 1745.

BANDOLIER, or **BANDOLEER** (from Fr. *bandoulière*, Ital. *bandoliera*, a little band), a belt worn over the shoulder, particularly by soldiers to carry cartridges. In the 17th century wooden cases were hung to the belt to contain powder charges. The modern bandolier carries the cartridges either in loops sewn to the belt, or in small pouches, similarly attached, containing strips of several cartridges. It has been extensively adopted in the British army, especially for mounted troops.

BANDON, or **BANDONBRIDGE**, a market-town of county Cork, Ireland, in the south-east parliamentary division, picturesquely situated in a broad open valley on both sides of the river Bandon. Pop. (1901) 2830. It is 20 m. S.W. of the city of Cork by the Cork, Bandon & South Coast railway. It is an important agricultural centre and there are distilleries, breweries and flour-mills. The open park of Castle Bernard (earl of Bandon), on the riverside, is attractive, and 2 m. below Bandon on the river is Inishannon, the head of navigation. Bandon was founded early in the 17th century by Richard Boyle, earl of Cork, and was incorporated by James I. It returned two members to the Irish parliament and thereafter one to the Imperial parliament until 1885. After the destruction of the walls by the Irish in 1689, Bandon long resisted the admission of Catholic inhabitants.

BANEBERRY, or **HERB CHRISTOPHER**, popular names for *Adæa spicata* (nat. ord. *Ranunculaceae*), a poisonous herb with long-stalked compound leaves, small white flowers and black berries, found wild in copses in limestone districts in the north of England. It is widely distributed in the north temperate zone.

BANÉR (BANNER, BANIER), **JOHAN** (1596–1641), Swedish soldier in the Thirty Years' War, was born at Djursholm Castle on the 23rd of June 1596. Entering the Swedish army, he served with distinction in the wars with Russia and Poland, and had reached high rank when, in 1630, Gustavus Adolphus landed in Germany. As one of the king's chief subordinates, Banér served in the campaign of north Germany, and at the first battle of Breitenfeld he led the right wing of Swedish horse. He was present at the taking of Augsburg and of Munich, and rendered conspicuous service at the Lech and at Donauwörth. At the unsuccessful assault on Wallenstein's camp at the Alte Veste Banér received a wound, and, soon afterwards, when Gustavus marched towards Lützen, his general was left in command in the west, where he was opposed to the imperial general Aldringer. Two years later, as Swedish field-marshal, Banér, with 16,000 men, entered Bohemia, and, combined with the Saxon army, marched on Prague. But the complete defeat of Bernhard of Saxe-Weimar in the first battle of Nördlingen stopped his victorious advance. After this event the peace of Prague placed the Swedish army in a very precarious position, but the victories won by the united forces of Banér, Wrangel and Torstensson, at Kyritz and Wittstock (4th Oct. 1636), restored the paramount influence of Sweden in central Germany. Even the three combined armies, however, were decidedly inferior in force to those they defeated, and in 1637 Banér was completely unable to make headway against the enemy. Rescuing with great difficulty the beleaguered garrison of Torgau, he retreated beyond the Oder into Pomerania. In 1639, however, he again overran northern Germany, defeated the Saxons at Chemnitz

and invaded Bohemia itself. The winter of 1640–1641 Banér spent in the west. His last achievement was an audacious *coup-de-main* on the Danube. Breaking camp in mid-winter (a very rare event in the 17th century) he united with the French under the comte de Guébriant and surprised Regensburg, where the diet was sitting. Only the break-up of the ice prevented the capture of the place. Banér thereupon had to retreat to Halberstadt. Here, on the 10th of May 1641, he died, after designating Torstensson as his successor. He was much beloved by his men, who bore his body with them on the field of Wülfenbuttel. Banér was regarded as the best of Gustavus's generals, and tempting offers (which he refused) were made him by the emperor to induce him to enter his service. His son received the dignity of count.

See *Banér's Bref till Axel Oxenstierna* (Stockholm, 1893); B. P. von Chemnitz, *Königlichen Schwedischer in Deutschland geführten Kriegs*; Martin Veibull, *Sveriges Storhæds* (Stockholm, 1881); Lundblad, *Johan Banér* (Stockholm, 1823); Ardwison, *Trittoariga Krigets mærkværdigaste personer* (Stockholm, 1861).

BANFF, a royal, municipal and police burgh, seaport and capital of Banffshire, Scotland. Pop. (1901) 7161. It is beautifully situated on high ground, on the left bank of the mouth of the Deveron, 50 m. N.W. of Aberdeen by the Great North of Scotland railway. It is a place of great antiquity, its first charter having been granted by Malcolm IV. in 1163, and further privileges were conferred by Robert Bruce in 1324 and Robert II. in 1372. Of the old castle on the hill by the sea, in which Archbishop Sharp was born, scarcely a trace remains; but upon its site was erected the modern Banff Castle, belonging to the earl of Seafield. The chief public edifices include the county buildings; town hall, surmounted by a spire 100 ft. high; Chalmers hospital (founded by Alexander Chalmers of Clunie, a merchant and shipowner of the town); a masonic hall of tasteful design; and the academy, a modern structure in the Grecian style, to which there is attached an extensive museum, containing examples of the early mechanical genius of James Ferguson, the astronomer. Of the museum, which originally belonged to the defunct Banff Institution and was afterwards taken over by the town council, Thomas Edward—the "working naturalist," whose life was so sympathetically written by Samuel Smiles—was curator for a few years. The principal manufactures comprise woollens, leather, rope and sails, and there are also breweries, distilleries, iron foundries, brick-yards and timber-yards, besides some ship-building. The fishing trade is also important. The exports mainly consist of grain, cattle, fish, dairy produce and potatoes; the imports of coal and timber. There is a railway station at Bridge of Banff communicating, via Inveramsay, with Aberdeen, and another at the harbour, communicating with Portsoy and Keith. The burgh is under the jurisdiction of a provost and council, and unites with Macduff, Elgin, Cullen, Inverurie, Kintore and Peterhead in returning one member to parliament. The Cassie Gift arose out of a bequest by Alexander Cassie of London, a native of Banff, who left £20,000 to the poor of the town—the interest being divided twice a year. Duff House, immediately adjoining the town, is a seat of the duke of Fife. It was built in 1740–1745, after designs by Robert Adam, at a cost of £70,000. The duke of Cumberland rested here on the way to Culoden. The house contains a fine collection of pictures and an interesting armoury. The park is nearly ten miles in circumference. The house, together with that portion of the park immediately surrounding it (about 140 acres), was presented to the towns of Banff and Macduff by the duke of Fife in November 1906.

BANFFSHIRE, a north-eastern county of Scotland, bounded N. by the Moray Firth, E. and S. by Aberdeenshire, and W. by Elgin and Inverness. It has an area of 403,364 acres, or 633½ sq. m. The surface is diversified. The northern half is mostly a fine, open, undulating country of rich, highly-cultivated soil. The southern is mountainous, but extensive farms are found in its fertile glens. Some of the mountains are thick with forests, some present a beautiful intermixture of rock and cope, while others are covered with brown heath. The principal mountains are all in the south; among them are Cairngorm, on the confines

of the shires of Banff and Inverness (4084 ft.), famous for its amber-coloured quartz crystals, the "cairnforms" of Scots jewelry; Ben Rinnes (2775 ft.); Corryhabbie (2563); Cook's Cairn (2478); Carn an t-Saidhe (2401); and the Buck of Cabrach (2368). No great rivers belong wholly to Banffshire. For a considerable part of their courses the Spey forms the western and the Deveron the eastern boundary of the county. But Banffshire streams are comparatively short, the chief being the Avon, Fiddich, Isla, Buckie, Deskford—with a series of cascades—and Livet. Most of them are stocked with trout and the Spey and Deveron are famous for their salmon. The great glens are distinguished for their romantic scenery, the chief being Glen Avon, Glen Barry, Glen Fiddich, Glen Isla, Glen Livet, and Glen Rinnes. The largest lochs are in the extreme south: Loch Avon (2500 ft. above the sea), Loch Bulg (1586) and Loch Etchachan (3100).

Geology.—The geology of Banffshire is closely connected with that of the neighbouring counties of Aberdeen and Elgin, from which it is divided by no natural boundaries. The greater portion is occupied by crystalline schists of sedimentary origin belonging to the Eastern Highland series. The groups which appear typically developed comprise (1) slates, black schists and phyllites with thin bedded limestone, sometimes containing tremolite; (2) the main limestone, (3) the quartzite (Schiehallion). These form subparallel belts trending north-east and south-west from the seacoast between Cullen and Portsoy southwards by Keith and Dufttown to the head waters of the Avon beyond Tomintoul. Some excellent sections of the phyllites are to be seen on the shore between Sandend, near Portsoy, and Findlater Castle, near Cullen, and in the railway cutting near Mulben, west of Keith. The main limestone has been worked at Fordyce, near Grange east of Keith, and at Keith and Dufttown. The quartzite, which is regarded as the highest member of the series, forms prominent ridges due to the more rapid erosion of the phyllites, mica-schists and limestones occupying the intervening hollows. It appears on the coast between Cullen and Buckie, it forms the Durn Hill near Portsoy, the Binn of Cullen, the Knock Hill, Ben Aigan and various ridges trending southwards from Grange by Glen Fiddich towards Tomintoul. In the north-east part of the county there is a large development of slate with interbedded greywackes and pebbly grits, which occupies the coast section between Macduff and Troop Head except a small part at Gamrie. The slate has been quarried for roofing purposes. No fossils have been discovered in the strata and their age is uncertain. The metamorphic sediments have been pierced by acid and basic igneous intrusions, partly before and partly after the folding and metamorphism of the strata. The older acid and basic materials appear as sheets injected along the lines of bedding of the sediments and are traceable for considerable distances. They are foliated in places, the planes of schistosity being more or less parallel with the planes of bedding in the schists. The older acid rocks are represented by the sills of granite and augen-gneiss occurring west of Portsoy, south of Fordyce and near Keith, while the older basic rocks are illustrated by the belt of gabbro, and syenite and hornblende schist which stretches southward from the coast at Portsoy, by Rothiemay to Huntly in Aberdeenshire. Veins and bosses of serpentine are associated with these basic intrusions at Portsoy and near Grange, one of the veins being traceable at intervals from the shore southwards in the direction of Knock Hill. The later intrusions are represented by the Ben Rinnes mass of granite and its basic modification, the Netherly diorite, east of Rothes. Various mineral localities occur throughout the county, of which some of the most important occur on the shore at Portsoy, as for example the gabbro masses in Portsoy bay with enstatite, hypersthene and cordierite; the gray granite with microcline, muscovite and tourmaline at East Head, the chialstolite-schist west of the marble quarry, the mottled serpentine with strings of crystal. Resting unconformably on these metamorphic rocks, Old Red sandstone strata are met with in a few places. Thus, they cross the Spey and appear in the Tynet Burn east of Fochabers, and extend eastwards to Buckie. Outliers of these beds appear on the shore near Cullen and south of Fordyce, while the largest area extends from Gamrie east by Pennan on the north coast of Aberdeenshire to Aberdeen. The strata consist mainly of conglomerates and red sandstones, such, at Gamrie and at Tynet, are associated with a band of limestone nodules embedded in a clayey matrix, containing fish remains. The more abundant species occurring at Gamrie, as determined by Dr R. H. Traquair, are *Diplacanthus striatus*, *Rhadinacanthus*, *Cheiracanthus Murchisoni*, *Pterichthys Milleri*, *Coccosteus decipiens*. In view of the fossil evidence these beds have been referred to the middle or Orcaidan division of this formation. In the interior near Tomintoul, another large deposit, composed of conglomerate and sandstone, occurs, which may be of the same age, though no fossils have as yet been obtained from these beds. There is a widespread covering of boulder clay especially in the northern part bordering the shores, where it contains fragments of shells and includes numerous boulders which have been carried eastwards

from the high grounds west of the Moray Firth. In the brickclays at Blackpots to the north-west of Banff, fragments of shells also occur together with Jurassic fossils. Shelly sands have been recorded near the Ord south of Tillynaught near Portsoy, and shells have been found in stratified deposits on the shore near Gamrie.

Agriculture.—The soil is in general rich and productive, yielding fair crops of wheat, and excellent crops of barley, oats, &c.; and the grass and green crops are equally abundant. Oats is the predominant crop, but the cleanliness of the farmers keeps up the acreage of barley. The cattle and stock hold a high character and form the staple agricultural industry. There is also a considerable amount of dairy farming. Among landlords who did much to encourage agricultural enterprise and to plant and reclaim lands, were the earls of Fife and the earls of Findlater, afterwards earls of Seafield. It was a Seafield who, in 1846, received the honorary gold medal of the Highland and Agricultural Society of Scotland, for his immense and thriving plantations of useful timber-trees, in the counties of Banff, Moray and Nairn. From the year 1811 to 1845, he had planted 18,938,224 Scots firs, 11,994,799 larches, 843,450 hardwoods; making the enormous aggregate of 31,686,472 forest trees, planted in 8223 acres of enclosed ground. The Banffshire Agricultural Association holds shows periodically for all sorts of stock and produce and agricultural implements.

Manufactures and Trade.—Woolen factories are found in Dufttown, Rothiemay and Gollachy, and engineering works in Banff, Portsoy and Keith. Distilleries are numerous and their product has a high repute. A fishing and miscellaneous trade is done at the harbours of Banff, Macduff, Buckie, Gardinstown, Portsoy, Cullen and Port Cullin; but fishing is also carried on at numerous creeks and harbours along the coast. The herring season lasts from June to September, white fishing all the year round. The fishery districts centre in Banff and Buckie. Banffshire contains large limestone deposits, and granite is also quarried.

The systems of the Great North of Scotland and the Highland railways serve the chief towns of the county and provide communication in one direction with Aberdeen, and in another with Elgin, Nairn and Inverness.

The population of Banffshire in 1891 was 61,684, and in 1901 61,488, or 97 to the square mile. In 1790 there were 459 persons speaking Gaelic and English. The chief towns are Banff (400, in 1901, 7161), Buckie (6549), and Keith (4753), with Cullen (1936), Portsoy (1878) and Dufttown (1823). The county returns one member to parliament; the royal burghs, Banff and Cullen, belonging to the Elgin group of parliamentary burghs. Banffshire, with Aberdeen and Kincardine shires, forms a sheriffdom, and there is a resident sheriff-substitute at Banff, who sits also at Keith, Buckie and Dufttown. Most of the schools are under school-board jurisdiction. Several of them earn grants for higher education, and the county council, out of the "residue grant," subsidizes classes in agriculture, navigation, veterinary science and cookery and laundry work. The teachers of the county, with those of the shires of Aberdeen and Elgin, benefit by the bequest of James Dick (1743-1828), a West India merchant, who left over £110,000 to promote the higher learning of the schoolmasters of these shires. The annual income of £4000 is distributed among the dominies who have qualified by examination to become beneficiaries.

History.—Of the northern Picts who originally possessed the land few remains now exist beyond the cairns that are found in the districts of Rothiemay, Ballindalloch, Boharm, Glen Livet and elsewhere. "Cairn" also occurs in many place names. The advance of the Romans was practically prevented by the mountains in the south, but what is believed to have been a Roman camp may still be made out in Glen Barry. Danish invaders were more persevering and more successful. Many bloody conflicts took place between them and the Scots. Near Cullen a fierce encounter occurred in 960, and a sculptured stone at Morthach is said to commemorate a signal victory gained by Malcolm II. over the Norsemen in 1010. The shire was the scene of much strife after the Reformation. In Glen Livet the Roman Catholics, under the marquis of Huntly, worsted the Protestants under the earl of Argyll. From 1624 to 1645 was a period of almost incessant struggle, and the Covenanting troubles, combined with the frequent conflicts of the clans, were productive of serious evils. But the Jacobite risings of 1715 and 1745 left the county comparatively untouched, and thereafter it became settled.

See W. Cramond, *Annals of Banff* (New Spalding Club) (Aberdeen, 1891); Dr Gordon, *Chronicles of Keith, Grange, &c.* (Glasgow, 1880); *Banffshire Year-Book* (Banff); Professor Dickie, *Botanist's Guide to Aberdeen, Banff, &c.* (Aberdeen, 1860); *Inventory of Charters of Cullen* (Banff, 1887); and *Inventory of Charters of Banff* (Banff); Robertson's *Collectors for a History of Aberdeen and Banff* (Spalding Club); W. Watt, *Aberdeenshire and Banff* (Edinburgh, 1900).

BÁNFFY, DEZSŐ [DESIDERIUS], BARON (1843-), Hungarian statesman, the son of Baron Daniel Bánffy and Anna Gyárfás, was born at Klausenburg on the 28th of October 1843, and educated at the Berlin and Leipzig universities. As lord lieutenant of the county of Belső-Szolnok, chief captain of Kővár and curator of the Calvinistic church of Transylvania, Bánffy exercised considerable political influence outside parliament from 1875 onwards, but his public career may be said to have begun in 1892, when he became speaker of the house of deputies. As speaker he continued, however, to be a party-man (he had always been a member of the left-centre or government party) and materially assisted the government by his rulings. He was a stringent adversary of the radicals, and caused some sensation by absenting himself from the capital on the occasion of Kossuth's funeral on the 1st of April 1894. On the 14th of January 1895, the king, after the fall of the Széll ministry, entrusted him with the formation of a cabinet. His programme, in brief, was the carrying through of the church reform laws with all due regard to clerical susceptibilities, and the maintenance of the Composition of 1867, whilst fully guaranteeing the predominance of Hungary. He succeeded in carrying the remaining ecclesiastical bills through the Upper House, despite the vehement opposition of the papal nuncio Agliardi, a triumph which brought about the fall of Kalnóky, the minister for foreign affairs, but greatly strengthened the ministry in Hungary. In the ensuing elections of 1896 the government won a gigantic majority. The drastic electoral methods of Bánffy had, however, contributed somewhat to this result, and the corrupt practices were the pretext for the fierce opposition in the House which he henceforth had to encounter, though the measures which he now introduced (the Honved Officers' Schools Bill) would, in normal circumstances, have been received with general enthusiasm. Bánffy's resoluteness enabled him to weather all these storms, and his subsequent negotiations with Austria as to the quota and commercial treaties, to the considerable political advantage of Hungary, even enabled him for a time to live at peace with the opposition. But in 1898 the opposition, now animated by personal hatred, took advantage of the ever-increasing difficulties of the government in the negotiations with Austria, and refused to pass the budget till a definite understanding had been arrived at. They refused to be satisfied with anything short of the dismissal of Bánffy, and passion ran so high that on the 3rd of January 1899 Bánffy fought a duel with his most bitter opponent, Horánszky. On the 26th of February Bánffy resigned, to save the country from its "ex-lex," or unconstitutional situation; he was decorated by the king and received the freedom of the city of Buda. Subsequently he contributed to overthrow the Stephen Tisza administration, and in May 1905 joined the Kossuth ministry.

See article "Bánffy," by Marczall, in *Pallas Nagy Lexikona*, Köt 17. (R. N. B.)

BANG, HERMANN JOACHIM (1858-), Danish author, was born of a noble family in the island of Zealand. When he was twenty he published two volumes of critical essays on the realistic movement. In 1880 he published his novel *Haabløse Slaegter* ("Families without hope"), which at once aroused attention. After some time spent in travel and a successful lecturing tour in Norway and Sweden, he settled in Copenhagen, and produced a series of novels and collections of short stories, which placed him in the front rank of Scandinavian novelists. Among his more famous stories are *Faædra* (1883) and *Tine* (1880). The latter won for its author the friendship of Ibsen and the enthusiastic admiration of Jonas Lie. Among his other works are: *Det hvide Hus* (The White House, 1898), *Excentriske Noveller* (1885), *Stille Eksistenser* (1886), *Liv og Død* (Life and Death, 1890), *Englen Michael* (1902), a volume of poems (1880) and of recollections (*Ti Aar*, 1891).

BANGALORE, a city of India, the capital of the native state of Mysore, and the largest British cantonment in the south of India. It is 3113 ft. above the sea, and 210 m. W. of Madras by rail. Pop. (1901) 69,447. The foundation of the present fort

was laid by a descendant of Kempe-Goude, a husbandman of the neighbouring country, who, probably in the 16th century, had left his native village to avoid the tyranny of the *wadeyar* of that place, and settled on a spot a few miles to the north of Bangalore. To the peaceful occupation of a farmer he added that of a warrior, and his first exploit was the conquest of this place, where, and at Savendrug, his family subsequently erected fortresses. Bangalore, with other possessions, was, however, wrested from them by Bijapur. Somewhat later we find it enumerated among the *jaگیرs* of Shahji, father of Sivaji, the founder of the Mahratta sway; and at an early period of his career in the service of the Bijapur state, that adventurer seemed to have fixed his residence there. It appears to have passed into the possession of Venkaji, one of the sons of Shahji; but he having occupied Tanjore, deemed Bangalore too distant, especially under the circumstances of the times, to be safe. He accordingly, in 1687, entered into a bargain for its sale to Chikka Deva, raja of Mysore, for three lakhs of rupees; but before it could be completed, Kasim Khan, commander of the forces of Aurangzeb, marched upon the place and entered it almost without resistance. This event, however, had no other result than to transfer the stipulated price from one vendor to another; for that general, not coveting the possession, immediately delivered it over to Chikka Deva on payment of the three lakhs. In 1758, Nanjiraj, the powerful minister of the raja, caused Bangalore to be granted, as a *jaگیر* or fief, to Hyder Ali, afterwards usurper of Mysore, who greatly enlarged and strengthened the fort, which, in 1760, on his expulsion from Seringapatam, served as his refuge from destruction. The fort formed the traditional scene of the first captivity of Sir David Baird after Baillie's defeat at Perambakam in 1780. The prison cell of Sir David and his fellow-captive is from 12 to 15 ft. square, with so low a roof that a man can scarcely stand upright in it. In 1791 it was stormed by a British army commanded by Lord Cornwallis. In 1799 the district was included by the treaty of Seringapatam within the territory of the restored raja of Mysore. It formed the headquarters of the British administration of Mysore from 1831 to 1881. When the state of Mysore was restored to its raja in 1881, the civil and military station of Bangalore was permanently reserved under British jurisdiction as an "assigned tract." It has an area of 13 sq. m., and had in 1901 a population of 89,599, showing a decrease of 10% in the decade, due to plague. Bangalore is the headquarters of a military district, its elevation rendering it healthy for British troops, with accommodation for a strong force of all arms and an arsenal in the old fort. It is the headquarters of a brigade in the 0th division of the Indian army. A considerable number of European pensioners reside here. There is a modern palace for the maharaja. There is an aided Roman Catholic college, besides many schools for Europeans. A permanent water-supply has been introduced and there is a complete system of drainage. Bangalore is an important railway centre. There are several cotton mills. The city suffered severely from plague in 1899 and 1900.

The district of Bangalore borders on the Madras district of Salem. The main portion consists of the valley of the Arkavati river, which joins the Cauvery on the southern frontier. Its area is 3079 sq. m. In 1901 the population was 789,664, showing an increase of 15% in the decade. The district is crossed by several lines of railway. Outside Bangalore city there is a woollen mill, which turns out blankets, cloth for greatcoats, and woollen stuffs.

BANGANAPALLE, a state of southern India, surrounded by the Madras district of Kurnool. Area, 255 sq. m.; pop. (1901) 32,264, showing a decrease of 9% in the decade; estimated revenue 56400, of which a large portion is alienated in grants to junior branches of the family; no tribute. The excessive expenditure of the nawab, Syed Fateh Ali Khan, and the general inefficiency of the administration caused much anxiety to the government, and in February 1905 he was temporarily removed from the administration of the state. The town of Banganapalle is not far from the branch of the Southern Mahratta railway from Guntakal to Bezwada.

BANGASH, a small tribe of Pathans in the Kohat district of the North-West Frontier Province of India. They occupy the hills between Thal and Kohat, and number 3000 fighting men. Formerly they owned the whole of Kurram, but owing to the encroachments of the Turis, they moved eastwards, dispossessed the Orakzais, drove them north and took their territory in the Kohat district, which they now occupy to the west of the Khattak country. The Khattaks and Bangashes are of exceptionally good physique and make excellent soldiers.

BANGKOK, the capital of Siam, on the river Me Nam, about 20 m. from its mouth, in 100° 30' E., 13° 45' N. Until modern times the city was built largely on floating pontoons or on piles at the edges of the innumerable canals and water-courses which formed the thoroughfares, but to meet the requirements of modern life, well-planned roads and streets have been constructed in all directions, crossing the old canals at many points and lined with well-built houses, for the most part of brick, in which the greater part of the erstwhile riparian population now resides. The centre of the city is the royal palace (see SIAM), situated in a bend of the river and enclosed by walls. At a radius of nearly a mile is another wall within which lies the closely-packed city proper, and beyond which the town stretches away to the royal parks on the north and to the business quarter, the warehouses, rice-mills, harbour and docks on the south. The whole town covers an area of over 10 sq. m. Two companies provide Bangkok with a complete system of electric tramways, and the streets are lined with shade-trees and lit by electricity. All over the town are scattered beautiful Buddhist temples, which with their coloured tile roofs and gilded spires give it a peculiar and notable appearance. Many fine buildings are to be seen—the various public offices, the arsenal, the mint, the palaces of various princes and, in addition to these, schools, hospitals, markets and Christian churches of many denominations, chiefly Roman Catholic. There are four railway stations in Bangkok, the termini of the lines which connect the provinces with the capital.

The climate of Bangkok has without doubt recently changed. It has become hotter and less humid. Though a minimum temperature below 60° F. is still recorded in January and December, a maximum of over 100° is reached during the hot weather months and at the beginning of the rains, whereas up to the year 1900 a maximum of 93° was considered unusually high. The cause of this change is not known, but it is attributed to extensive drainage and removal of vegetation in the immediate neighbourhood of the town. The annual rainfall amounts to rather over 50 in.

A four-mile reach of the Me Nam, immediately below the city proper, forms the port of Bangkok. From 250 to 400 yds. broad and of good depth right up to the banks, the river offers every convenience for the berthing and loading of ships, though a bar at its mouth, which prevents the passage of vessels drawing more than 12 ft., necessitates in the case of large ships a partial loading and unloading from lighters outside. The banks of the port are closely lined with the offices, warehouses and wharves of commercial houses, with timber yards and innumerable rice-mills, while the custom house, the harbour master's office and many of the foreign legations and consulates are also situated here. Of the 750 steamships which cleared the port in 1904, three out of every seven were German, two were Norwegian and one was British, but in 1905 two new companies, one British and the other Japanese, arranged for regular services to Bangkok, thereby altering these proportions. It is notable that the heavy trade with Singapore shows a tendency to decrease in favour of direct trade with Europe. A fleet of small steamers, schooners and junks, carries on trade with the towns and districts on the east and west coasts of the Gulf of Siam. The trade of Bangkok is almost entirely in the hands of Europeans and Chinese. The principal exports are rice and teak, and the principal imports, cotton and silk goods and gold-leaf. The value of trade, which more than doubled between the years 1900 and 1907, amounted in the latter year to £5,600,000 imports and £7,100,000 exports. Of the total trade, 75% is with the British empire. Many of the best known mercantile firms and banks of the Far East have

branches in Bangkok. The unit of currency is the *tical* (see SIAM).

The government of Bangkok is entrusted to the minister of the capital, a member of the cabinet. Under this minister are the police, sanitary, harbour master's and revenue offices. The police force is an efficient and well-organized body of 3000 men headed by a European commissioner of police. The sanitary department consists of a board of health, a bacteriological laboratory and an engineer's office, all managed with expert European assistance. Under the act of 1905, the want of which was long felt, the port and the city water-ways are controlled by the harbour master. Local revenues are collected by the revenue office. The ordinary law courts are under the control of the ministry of justice, but in accordance with the extra-territorial rights enjoyed by foreign powers in Siam, each consulate has attached to it a court, having jurisdiction in all cases in which a subject of the power represented by such consulate is defendant.

The population, which is estimated at 450,000, is mixed. Mingling with Siamese and Chinese, who form the major part, may be seen persons of almost every race to be found between Bombay and Japan, while Europeans of different nationalities number over 1000. The death-rate is high, especially among children, owing to the prevalence of cholera, smallpox and fevers during the dry weather. Sanitation, however, is improving and much good has resulted from the boring of numerous artesian wells which yield good water.

Before 1769 Bangkok was nothing but an agricultural village with a fort on the river bank. In that year, however, it was seized by the warrior, Paya Tak, as a convenient point from which to attack the Burmese army then in occupation of Siam, and upon his becoming king it was chosen as the capital of the country. (See SIAM.) (W. A. G.)

BANGOR, a seaport and market-town of Co. Down, Ireland, in the north parliamentary division, on the south side of Belfast Lough, 12 m. N.E. of Belfast, on a branch of the Belfast & County Down railway. Pop. of urban district (1901) 5903. It carries on a considerable trade in cotton and linen and embrodered muslin. It is generally frequented as a watering-place, especially by the people of Belfast, and there are golf links and important regattas held by the Royal Ulster Yacht Club. Slight remains are to be seen of an abbey of Canons Regular, founded in the middle of the 6th century by St Comgall, and rebuilt, on a scale of magnificence which astonished the Irish, by St Malachy O'Morgair in the first half of the 12th century. Bangor was incorporated by James I. and returned two members to the Irish parliament.

BANGOR, a city, port of entry, and the county-seat of Penobscot county, Maine, U.S.A., at the confluence of the Kenduskeag stream with the Penobscot river, and at the head of navigation on the Penobscot, about 60 m. from the ocean, and about 75 m. N.E. of Augusta. Pop. (1890) 19,103; (1900) 21,850, of whom 3726 were foreign-born and 176 were negroes; (1910, census) 24,803. A bridge (about 1300 ft. long) across the Penobscot connects Bangor with Brewer (pop. in 1910, 5667). Bangor is served directly by the Maine Central railway, several important branches radiating from the city, and by the Eastern Steamship line; the Maine Central connects near the city with the Bangor & Aroostook railway (whose general offices are here) and with the Washington County railway. The business portion of the city lies on both sides of the Kenduskeag and for about 3 m. along the W. bank of the Penobscot, which is here quite low, while many fine residences are on the hillsides farther back. Bangor is the seat of three state institutions—the Eastern Maine general hospital, the Eastern Maine insane hospital and the law school of the University of Maine—and of the Bangor Theological Seminary (Congregational), incorporated in 1814, opened at Hampden in 1816, removed to Bangor in 1819, and empowered in 1905 to confer degrees in divinity. The city has several public parks, a public library and various charitable institutions, among which are a children's home, a home for aged men, a home for aged women and a deaconesses' home. Among the principal buildings are the county court house, the Federal building, the city hall and the opera house. The Eastern

Maine Music Festival is held in Bangor in October of each year. The rise of the tide here to a height of 17 ft. makes the Penobscot navigable for large vessels; the Kenduskeag furnishes good water-power; and the city is the trade centre for an extensive agricultural district. The Eastern Maine State Fair is held here annually. Bangor is one of the largest lumber depots in the United States, and also ships considerable quantities of ice. The city's foreign trade is of some importance; in 1907 the imports were valued at \$2,720,594, and the exports at \$1,272,247. Bangor has various manufactures, the most important of which (other than those dependent upon lumber) are boots and shoes (including moccasins); among others are trunks, valises, saws, stoves, ranges and furnaces, edge tools and cant dogs, saw-mill machinery, brick, clothing, cigars, flour and dairy products. In 1905 the city's factory products were valued at \$3,408,355. The municipality owns and operates the water-works (the water-supply being drawn from the Penobscot by the Holly system) and an electric-lighting plant; there is also a large electric plant for generation of electricity for power and for commercial lighting, and in Bangor and the vicinity there were in 1908 about 60 m. of electric street-railway.

Bangor has been identified by some antiquarians as the site of the mythical city of *Norumbega*, and it was reported in 1656 that Fort Norumbega, built by the French, was standing here; but the authentic history of Bangor begins in 1769 when the first settlers came. The settlement was at first called Condukeag and for a short time was locally known as Sunbury. In 1791 the town was incorporated, and through the influence of the Rev. Seth Noble, the first pastor, the name was changed to Bangor, the name of one of his favourite hymn-tunes. During the war of 1812 a British force occupied Bangor for several days (in September 1814), destroying vessels and cargoes. Bangor was chartered as a city in 1834. In 1836 a railway from Bangor to Old Town was completed; this was the first railway in the state; Bangor had, also, the first electric street-railway in Maine (1889), and one of the first iron steamships built in America ran to this port and was named "Bangor."

BANGOR (formerly **BANGOR FAWR**, as distinguished from several other towns of this name in Wales, Ireland, Brittany, &c.), a city, municipal (1883) and contributory parliamentary borough (Carnarvon district), seaport and market-town of Carnarvonshire, N. Wales, 240 m. N.W. of London by the London & North Western railway. Pop. (1901) 11,269. It consists of Upper and Lower, the Lower practically one street. Lying near the northern entrance of the Menai Straits, it attracts many visitors. Buildings include the small cathedral, disused bishop's palace, deanery, small Roman Catholic church and other churches, the University College of N. Wales (1883), with female students' hall, Independent, Baptist, Normal and N. Wales Training Colleges. The cruciform cathedral, with a low pinnacled tower, stands on the site of a church which the English destroyed in 1071 (dedicated to, and perhaps founded, about 525, by St Deiniol). Sir G. Scott restored the present cathedral, 1866-1875, after it had been burned in the time of Owen Glendower, destroyed in 1211, and, in 1102 and 1212, severely handled. Bishop Dean (*temp.* Henry VII.) rebuilt the choir, Bishop Skevington (1532) added tower and nave. Lord Penrhyn's slate-quarries, at Bethesda, 6 m. off, supply the staple export from Port Penrhyn, at the mouth of the stream Cegid.

The *Myryrian Archaeology* (408-484) gives the three principal *bangor* (college) institutions as follows:—the *bangor* of Illtud Farchawg at Caer Worgorn (Wroxeter); that of Emrys (Ambrosius) at Caer Caradawg; *bangor wydrin* (glass) in the *glass isle*, Afallach; *bangor Illtud*, or Llanilltud, or Llantwit major (by corruption), being a fourth. In each of the first three were 420 saints, succeeding each other (by hundreds), day and night, in their pious offices.

BANGORIAN CONTROVERSY, a theological dispute in the early 18th century which originated in 1716 with the posthumous publication of George Hickey's (bishop of Thetford) *Constitution of the Christian Church, and the Nature and Consequences of Schism*, in which he excommunicated all but the non-juring

churchmen. Benjamin Hoadly (*q.v.*), the newly-appointed bishop of Bangor, scented the opportunity and wrote a speedy and able reply, *Preservative against the Principles and Practices of Non-Jurors*, in which his own Erastian position was recommended and sincerity proposed as the only test of truth. This was followed by his famous sermon, preached before George I. on the 31st of March 1717, on *The Nature of the Kingdom or Church of Christ*. In this discourse "he impugned the idea of the existence of any visible church at all, ridiculed the value of any tests of orthodoxy, and poured contempt upon the claims of the church to govern itself by means of the state." He identified the church with the kingdom of Heaven—it was therefore "not of this world," and Christ had not delegated His authority to any representatives. Both book and sermon were reported on by a committee appointed by the Lower House of Convocation in May, and steps would have been taken by the archbishop and bishops had not the government stepped in (Hoadly denied that this was at his request) and prorogued Convocation till November. Hoadly himself wrote *A Reply to the Representations of Convocation* and also answered his principal critics, among whom were Thomas Sherlock (*q.v.*), then dean of Chichester, Andrew Snape, provost of Eton, and Francis Hare, then dean of Worcester. These three men, and another opponent, Robert Moss, dean of Ely, were deprived of their royal chaplaincies. Hoadly was shrewd enough not to answer the most brilliant, though comparatively unknown, of his antagonists, William Law. Though the controversy went on, its most important result had already been achieved in the silencing of Convocation, for that body, though it had just "seemed to be settling down to its proper work in dealing with the real exigencies of the church" when the Hoadly dispute arose, did not meet again for the despatch of business for nearly a century and a half. (See CONVOCATION.)

BANGWEULU, a shallow lake of British Central Africa, formed by the head streams of the Congo. It lies between 10° 38' and 11° 31' S. and is cut by 30° E. Bangweulu occupies the north-west part of a central basin in an extensive plateau, and is about 3700 ft. above the sea. The land slopes gently to the depression from the south, east and north, and into it drain a considerable number of streams, turning the greater part into a morass of reeds and papyrus. The term Bangweulu is sometimes applied to the whole depression, but is properly confined to the area of clear water. Only on its south-west and western sides are the banks of the lake clearly defined. The greatest extent of open water is about 60 m. N. to S. and 40 m. E. to W. Long narrow sandbanks almost separate Chifunawuli, the western part of the lake, from the main body of water, while the water surface is further diminished by a number of islands. The largest of these islands, Kiru (Chiru), lies on the east side of the lake close to the swamp. Kisi (Chishi) is a small island occupying a central position just south of 11° S., and Mbwali, 20 m. long by 3 broad, lies south of Kisi. South of Bangweulu the swamp extends to 12° 10' S. Into this swamp on its east side flows the Chambezi, the most remote head stream of the Congo. Without entering the lake the Chambezi mingles its waters in the swamp with those of the Luapula. The Luapula, which leaves Bangweulu at its most southern point, is about a mile wide at the outflow, but soon narrows to 300 or so yds. West of the Luapula and near its outflow lies Lake Kampolombo, 20 m. long and 8 broad at its southern end. A sandy track separates Bangweulu from Kampolombo, and a narrow forest-clad tongue of land called Kapata intervenes between the Luapula and Kampolombo. Various channels lead, however, from the river to the lake. The Luapula flows south through the swamp some 50 m. and then turns west and afterwards north (see CONGO). The flood waters of the Chambezi and other streams, which deposit large quantities of alluvium, are gradually solidifying the swamp, while the Luapula is believed to be, though very slowly, draining Bangweulu. The waters of the lake do not appear to be anywhere more than 15 ft. deep.

Though heard of by the Portuguese traveller, Francisco de Lacerda, in 1708, Bangweulu was first reached in 1868 by David Livingstone, who died six years later among the swamps to the

south. It was partially surveyed in 1883 by the French traveller, Victor Giraud, and first circumnavigated by Poulett Weatherley in 1896.

See P. Weatherley in *Geog. Journ.* vol. xii. (1898) and vol. xiv. p. 51. (1899); L. A. Wallace in *Geog. Journ.* vol. xxix. (1907), with map p. 161. Beringer. Giraud's *Les Lacs de l'Afrique équatoriale* (Paris, 1890) and Livingstone's *Last Journals* (1874) may also be consulted.

BANIM, JOHN (1798-1842), Irish novelist, sometimes called the "Scott of Ireland," was born at Kilkenny on the 3rd of April 1798. In his thirteenth year he entered Kilkenny College and devoted himself specially to drawing and painting. He pursued his artistic education for two years in the schools connected with the Royal Society at Dublin, and afterwards taught drawing in Kilkenny, where he fell in love with one of his pupils. His affection was returned, but the parents of the young lady interfered and removed her from Kilkenny. She pined away and died in two months. Her death made a deep impression on Banim, whose health suffered severely and permanently. In 1820 he went to Dublin and settled finally to the work of literature. He published a poem, *The Celts' Paradise*, and his *Damon and Pythias* was performed at Covent Garden in 1821. During a short visit to Kilkenny he married, and in 1822 planned in conjunction with his elder brother MICHAEL (1796-1874), a series of tales illustrative of Irish life, which should be for Ireland what the Waverley Novels were for Scotland. He then set out for London, and supported himself by writing for magazines and for the stage. A volume of miscellaneous essays was published anonymously in 1824, called *Revelations of the Dead Alive*. In April 1825 appeared the first series of *Tales of the O'Hara Family*, which achieved immediate and decided success. One of the most powerful of them, *Crohoore of the Bill Hook*, was by Michael Banim. In 1826 a second series was published, containing that excellent Irish novel, *The Nowlans*. John's health had given way, and the next effort of the "O'Hara family" was almost entirely the production of his brother Michael. *The Croppy, a Tale of 1798* (1828) is hardly equal to the earlier tales, though it contains some wonderfully vigorous passages. *The Denounced, The Mayor of Windgap, The Ghost Hunter* (by Michael Banim), and *The Smuggler* followed in quick succession, and were received with considerable favour. John Banim, meanwhile, had become much straitened in circumstances. In 1829 he went to France, and while he was abroad a movement to relieve his wants was set on foot by the English press, headed by John Sterling in *The Times*. A sufficient sum was obtained to remove him from any danger of actual want, and to this government added in 1836 a pension of £150. He returned to Ireland in 1835, and settled in Windgap Cottage, a short distance from Kilkenny; and there, a complete invalid, he passed the remainder of his life, dying on the 13th of August 1842. Michael Banim had acquired a considerable fortune which he lost in 1840 through the bankruptcy of a firm with which he had business relations. After this disaster he wrote *Father Connell* (1842), *Clough Finn* (1852), *The Town of the Cascades* (1862). Michael Banim died at Booterstown on the 30th of August 1874.

The true place of the Banims in literature is to be estimated from the merits of the *O'Hara Tales*; their later works, though of considerable ability, are sometimes prolix and are marked by too evident an imitation of the Waverley Novels. The *Tales*, however, are masterpieces of faithful delineation. The strong passions, the lights and shadows of Irish peasant character, have rarely been so ably and truly depicted. The incidents are striking, sometimes even horrible, and the authors have been accused of straining after melodramatic effect. The lighter, more joyous side of Irish character, which appears so strongly in Samuel Lover, receives little attention from the Banims.

See P. J. Murray, *Life of John Banim* (1875).

BANJALUKA (sometimes written BANIALUKA, or BAINALUKA), the capital of a district bearing the same name, in Bosnia. Pop. (1895) 13,666, of whom about 7000 were Moslems. Banjaluca lies on the river Vrbas, and at the terminus of a military railway which meets the Hungarian state line at Jasenovac, 30 m. N.N.W. Banjaluca is the seat of Roman Catholic and Orthodox bishops, a district court, and an Austrian garrison. It is at the head of a

narrow defile, shut in by steep hills on the east and west but expanding on the north to meet the valley of the Save. A small stream called the Crkvina enters the Vrbas from the north-east and in the angle thus formed stand the citadel and barracks, with the 16th-century Ferhadiya Jamia, largest and most beautiful of more than 40 mosques in the city. The celebrated Roman baths are all in ruins, except one massive, domed building, dating from the 6th century and still in use, although modern baths are also open, for the development of the hot springs. Other noteworthy buildings are the Franciscan and Trappist monasteries, a girls' school, belonging to the Sisterhood of the Sacred Blood of Nazareth, a real-school and a Turkish bazaar. Coal, iron, silver and other minerals are found in the adjoining hills; and the city possesses a government tobacco factory, a brewery, cloth-mills, gunpowder-mills, a model farm and many corn-mills, worked by the two rapid rivers.

Banjaluca is probably the Roman fort, marked, in the *Tabula Peutingeriana*, as *Castra*, on the river Urbanus and the road from Salona on the Adriatic to Servitium in Pannonia. The origin of its later name, meaning the "Baths of St Luke," is uncertain. In the 15th century, the fall of Jajce, a rival stronghold 22 m. S., led to the rapid rise of Banjaluca, which was thenceforward the scene of many encounters between Austrians and Turks; notably in 1527, 1688 and 1737. No Bosnian city had greater prosperity or importance in the last half of the 18th century. In 1831, Hussein Aga Borberli, called the "Dragon of Bosnia," or *Zmaj Bosanski*, set forth from Banjaluca on his holy war against the sultan Mahmud II. (See BOSNIA.)

BANJERMASIN (Dutch *Bandjermasin*), the chief town in the Dutch portion of the island of Borneo, East Indies, on the river Martapura, near its junction with the Barito, 24 m. from the mouth of the Barito in a bay of the south coast. The town is the seat of the Dutch resident of South and East Borneo. Its buildings stand on either bank of the river, but many of the inhabitants (who number nearly 50,000) occupy houses either floating on, or built on piles in the river. As large vessels can sail up to the town, it is a trade centre for the products of the districts along the banks of the Barito and Martapura, such as benzoin, rattans, wax, gold, diamonds, iron and weapons. In 1700 the East Indian Company established a factory here; but the place was found to be unhealthy, and the Company's servants were finally attacked by the natives, whom they repulsed with great difficulty. The settlement was abandoned. The English again seized Banjarmasin in 1811, but restored it in 1817. Of the commercial community the Chinese are a very important portion, and there is also a considerable number of Arabs. The district of Banjarmasin was incorporated by the Dutch in consequence of the war of 1860, in regard to the succession in the sultanate, which had been under their protection since 1787. The town of Martapura was the seat of the sultan from 1771. The inland portion of the district is covered with forest, while the flat and swampy seaboard is largely occupied by rice-fields. The inhabitants are mostly Dyaks.

BANJO, a musical instrument with strings plucked by fingers or plectrum, popular among the American negroes and introduced by them into Europe. The word is either a corruption of "bandore" or "pandura" (g.n.), an instrument of the guitar type, or is derived from "bania," the name of a similar primitive Senegambian instrument.

The banjo consists of a body composed of a single piece of vellum stretched like a drum-head over a wooden or metal hoop to ensure the requisite degree of resonance; the parchment may be tightened or slackened by means of a series of screws disposed round the circumference of the hoop. Attached to the body, which has no back, is a long neck, terminating in a flat head acting as a peg-box and bent back slightly at an obtuse angle from the neck. There are five, six or nine strings to the banjo; they are fastened to a tail-piece as in the violin, pass over a low bridge, on the body, and are strained over the nut or ridge at the end of the neck, where they are threaded through holes and wound round the tuning-pegs fixed in the back of the head in Oriental fashion, as in the lute (g.v.). The strings are stopped

by the pressure of the fingers against the finger-board which lies over the front of the neck; the correct positions for the formation of the intervals of the scale are indicated in some banjos by frets consisting of metal or wooden bands inlaid in the finger-board. The vibrating length of the strings from bridge to nut is 24 in. for all except the highest in pitch, known as the "chanterelle," "melody" or "thumb string," which is only 16 in. long; its tuning peg is inserted half-way up the neck. The chanterelle is not, as in other stringed instruments, in its position as the highest in pitch, but is placed next the lowest string for convenience in playing it with the thumb. In the tables of accordance here given, the chanterelle is indicated by a X. The five-stringed banjo is tuned either

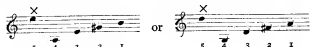

The six-stringed is tuned



The nine-stringed banjo has three thumb strings thus

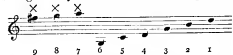

The G clef is used in notation, but the notes sound an octave lower than they are written. The banjo is usually a transposing instrument in the sense that, when playing with other instruments, the A corresponds to the C of the piano or violin; the key of A major is therefore the first to be mastered. The chanterelle does not lie over the finger-board and is always played open by the thumb.

The banjo is held so that the neck is even with the left shoulder and the body rests on the right thigh; the front of the instrument is held inclined at an angle, allowing the performer to see all the strings. When played as a solo instrument, a plectrum may be used with good effect to produce rapid scale and allegro passages, or to produce the tremolo or sustained notes as on the mandoline (*q.v.*). The best results are obtained by means of a tortoise-shell plectrum about the size of a shilling,¹ having the contact-edges highly polished, bevelled and terminating in a point. The tone of the banjo is louder and harder than that of the guitar. Chords of two, three and four notes can be played on it.

The banjo or banya of the African negro having grass strings is still in use on the coast of Guinea. The banjo was made known in England through companies of coloured minstrels from the United States, one of which came over to London as early as 1846. (K. S.)

BANK, known also as "POLISH BANK" and "RUSSIAN BANK" a card-game. An ordinary pack is used. Five or six players is a convenient number. Each contributes an arranged stake to the pool. The dealer gives three cards to each player and turns up another; if this is not lower than an eight (ace is lowest) he goes on till such a card is exposed. The player on the dealer's left, without touching or looking at his cards, can bet the amount of the pool, or any part of it, that among his cards is one that is higher (of the same suit) than the turn-up. If he wins, he takes the amount from the pool; if he loses, he pays it to the pool. Each player does the same in turn, the dealer last. Whenever the pool is exhausted, a fresh stake is put into the pool. After a round is over the deal passes. No player may touch his cards until he has made his bet; the penalty is a fine to the pool of twice the stake, and the loss of his right to bet during that round.

BANKA (BANCA, BANGKA), an island of the Dutch East Indies, off the east coast of Sumatra, from which it is separated by Banka Strait, which is about 9 m. wide at its narrowest point. On the east, the broader, island-studded Gaspar Strait separates Banka from Billiton. Banka is 138 m. in length; its extreme breadth is 62 m., and its area, including a few small adjacent islands, 4460

sq. m. The soil is generally dry and stony, and the greater part of the surface is covered with forests, in which the logwood tree especially abounds. The hills, of which Maras in the north is the highest (2760 ft.), are covered with vegetation to their summits. Geologically, Banka resembles the Malay Peninsula, its formations being mainly granite, Silurian and Devonian slate, frequently covered with sandstone, laterite (red ironstone clay) of small fertility, and alluvium. The granite extends from W.N.W. to S.S.E., forming the short, irregular hill-chains. As these lie generally near the east coast, it follows that the rivers of the west coast are the longer. There are no volcanoes. The chief rivers (Jering, Kotta and Waringin) are navigable for some 19 m. from their mouths and are used for the transport of tin. Banka is principally noted for the production of this mineral, which was discovered here in 1710 and is a government monopoly. It occurs in lodes and as stream-tin, and is worked by Chinese in large numbers who inhabit villages of their own. The island is divided into nine mining districts, including about 120 mines, under government control, with 12,000 workmen, which have produced as much as 12,000 tons of tin in a year. From May to August, the period of the south-east monsoon, the climate of Banka is dry and hot; but the mean annual rainfall reaches 120 in. annually, rain occurring on an average on 168 days each year. The wet, cool season proper is from November to February, accompanying the north-west monsoon. The heavy rainfall is of great importance to the tin-streaming industry. The total population of the island (1905) is 115,189, including 40,000 Chinese and 70,000 natives. These last are mainly composed of immigrant Malayan peoples. The aborigines are represented by a few rude hill-tribes, who resemble in physique the Battas of Sumatra. Rice, pepper, gambier, coffee and palms are cultivated, and fishing and the collection of forest produce are further industries, but none of these is of importance. The chief town is Muntok at the north end of Banka Strait.

See H. Zondervan, *Banka en Zijne bewoners* (Amsterdam, 1895), with bibliography; T. Posewitz, *Die Zinn-inseln im Indischen Ocean*. For geology and the tin-mines, *Jaarboek voor het Mijnwezen in Ned. Ind.* (Amsterdam, 1877-1884).

BANKER-MARKS, or MASONS' MARKS. The "banker" is the stone bed or bench upon which a mason works, hence the term (so well known to the trade) of banker-marks, which, as Mr Whitley has pointed out, is more appropriate than that of masons' marks, since the setters, who are usually selected from amongst the best workmen, make no marks upon the stone (*Leamington Spa Courier*, 11th of August 1888). These must not be confused with other marks sometimes cut on stones as directions to the setters, and so used and employed to the present time. Banker-marks are met with throughout the civilized world, and in fact are to be found on all old buildings of consequence, ecclesiastical or otherwise. Professor T. Hayter Lewis well observed, "Go where you will, in England, France, Sicily, Palestine, you will find all through the buildings of the 12th century the same carefully worked masonry, the same masons' tool-marks, the same way of making them." Such masons' marks are to be traced gravely on all the chief stones of what is known as Norman work. Norman tooling, so far as Hayter Lewis could discover, came from the north and west of Europe. Since then we get marks made with a "toothed chisel," but however or wherever marked the intention was the same. The system followed provided an infallible means of connecting the individual craftsman with his work, an evidence of identity that could not be gained.

Naturally, because of their simplicity, certain designs were followed much more frequently than others, while occasionally some of a very elaborate character are to be detected. Undoubtedly not a few were suggestive of the initials of the names of the masons, and others were reminiscent of certain animals, objects, &c., but no proof has yet been offered of their being alphabetical in design, or arranged so as to distinguish the members of different lodges or companies; the journeyman selected any design they cared to adopt.

Singular to state, marks were chosen by gentlemen and others

¹ See A. H. Nassau-Kennedy, I.S.M., *Banjo-Plectring*.

² For the commercial "bank" see BANKS AND BANKING.

who joined the operative masonic lodges of the 16th and later centuries, and they were as carefully registered in the mark-books as those selected by operatives for trade purposes. The same marks are to be seen in the registers used by fathers and sons, and not always with a slight difference, as some have stated, to secure identification. What should be noted also is that other trades used precisely similar marks and for a like object, so that the idea of their having a mystical meaning, or being utilized for any other object but the one named, seems groundless.

The late George Godwin, F.R.S., F.S.A., &c., drew attention to the subject of "masons' marks in various countries" in a communication to the Society of Antiquaries in 1841, and also at a little later period (vide *Archæologia*, vol. xxx. p. 113). To him is the credit due of first drawing attention to "these signs" in England. It is noteworthy how little such marks are noticed, even in buildings which are visited by archaeologists quite frequently, until a few are pointed out, and then they meet the eye to an astonishing number. In the *Sessional Papers*, 1868-1869, of the Royal Institute of British Architects, No. 9, may be found numerous samples of the marks from various parts of Europe in illustration of the paper by Godwin.

No better plan has been followed in modern times to connect the work done with the worker in stone, and it is probable that a second mark, observable on some blocks, may serve to indicate the overseer. There are even three or more sometimes.

The same system was adopted at the building of Truro cathedral, only the marks were inserted on the bed of each stone instead of at the side as usual, the result being that they ceased to be seen after being placed *in situ*. Mr Hughan obtained copies of these marks from Mr James Bubb, the first clerk of the works, and from his successor, Mr Robert Swain, and had them published in the *Freemason*, 13th of November 1886. He remarked at the same time that "many of these designs will be familiar to students of ancient ecclesiastical and other buildings at home and abroad." Some are interesting specimens.

A Historical Treatise on Early Builders' Marks (Philadelphia, U.S.A., 1885) by Mr G. F. Fort, and *Masons' Marks from Buildings in the Counties of Lancaster and Chester, with Notes on the General History of Masons' Marks* (Historic Society of Lancashire and Cheshire, vol. vii. N.S.), by W. Harry Rylands, F.S.A., may be consulted with advantage. The latter declares that "the Runic theory is as unlikely and as untenable as that which places the origin of these marks in the absurd alphabets given by Cornelius Agrippa, who died early in the 16th century." Victor Didron copied some 4000 during a tour in France in 1836 and pointed out their value (*Ann. Arch.*, 1845).

BANKET, a South African mining term, applied to the beds of auriferous conglomerate, chiefly occurring in the Witwatersrand gold-fields (see GOLD). The name was given to these beds from their resemblance to a sweetmeat, known in Dutch as "banket," resembling almond hard-bake. The word is the same as "banquet," and is derived ultimately from "bank" or "bench," meaning table-feast, hence applied to any delicacy or to various kinds of confectionery, a use now obsolete in English.

BANK HOLIDAYS, in the United Kingdom, those days which by the Bank Holidays Act 1871 are kept as close holidays in all banks in England and Ireland and Scotland respectively. Before the year 1834, the Bank of England was closed on certain saints' days and anniversaries, about thirty-three days in all. In 1834, these were reduced to four—Good Friday, 1st of May, 1st of November and Christmas Day. By the act of 1871, carried through the House of Commons by Sir J. Lubbock (afterwards Lord Avebury), the following were constituted bank holidays in England and Ireland—Easter Monday, the Monday in Whitsun week, the first Monday of August, the 26th of December if a week-day; and by the Bank Holiday (Ireland) Act 1903, March 17th as a special bank holiday for Ireland (see FEASTS AND FESTIVALS). In Scotland—New Year's Day, Christmas Day, Good Friday, the 1st Monday of May, the 1st Monday of August. If Christmas Day and New Year's Day fall on a Sunday, the next Monday following is the bank holiday. No person is compelled to make any payment or to do any act upon a bank holiday which he would not be compelled to do or make on Christmas Day or Good Friday, and the making of a payment

or the doing of an act on the following day is equivalent to doing it on the holiday. By the same act it was made lawful for the sovereign from time to time, as it should seem fit, to appoint by proclamation, in the same manner as public fasts or days of public thanksgiving, any day to be observed as a bank holiday throughout the United Kingdom or any part of it, or to substitute another day when in any special case it appears inexpedient to the sovereign in council to keep the usual bank holiday. (See further HOLIDAY.)

BANKIPUR, an ancient village on the Hugli river in the Bengal Presidency, near the modern Palta above Barrackpore. It has disappeared from the map, but is famous as the principal settlement of the ill-fated Ostend Company, the one great effort made by Germany to secure a foothold in India. The Ostend Company was formed in 1722-1723, and with a capital of less than a million sterling founded two settlements, one at Coblom (Covelong) on the Madras coast between the English Madras and the Dutch Sadras, and the other on the Hugli between the English Calcutta and the Dutch Chinsura. Both English and Dutch were offended and in 1727, in order to obtain the European guarantee for the Pragmatic Sanction, the court of Vienna resolved to sacrifice the Company and suspended its charter. It became bankrupt in 1784 and ceased to exist in 1793. But in the meantime in 1733 the English and Dutch stirred up the Mahomedan general at Hugli to pick a quarrel. He attacked Bankipur and the garrison of only fourteen persons set sail for Europe. Thus German interests disappeared from India.

BANK-NOTES. For our present purpose we include in this description all paper substitutes for metallic currency whether issued by banks, governments or other financial institutes.

Early bank-notes were simply printed forms in which the amounts were written by hand. They were usually for large amounts (£40 and upwards) and were printed upon water-marked paper; and, although no precautions were taken in the engraving to prevent fraudulent imitation, forgeries were comparatively rare. But, when at the end of the 18th century small notes for £1 and £2 were put in circulation, forgery became rife, as many as 352 persons being convicted of this crime in England in a single year; and from that time to the present a constant trial of skill has been going on between the makers of bank-notes and the counterfeiters. Engine-turned ornaments and emblematical figures or views introduced in the engraving, in conjunction with special water-marks in the paper, held the forgers somewhat in check until the discovery of photography put into the hands of the counterfeiter a most dangerous weapon, by the aid of which complicated patterns and vignettes could be perfectly reproduced. To prevent such reproduction Henry Bradbury in 1856 introduced anti-photographic bank-note printing, in which the essential portions of the note were printed in one colour and over this another protective colour was placed. A photograph of a note printed in this way presented a confused mingling of the two colours; but with the advance of photographic knowledge means were found of obtaining a photograph of either colour separate from the other, and it consequently became necessary to introduce a third colour and to secure a special photographic relation between the three colours to prevent their separation.

Photography, however, although the most dangerous weapon of the counterfeiter, is not the only means of imitation available, a fact which is sometimes overlooked. A note may be perfectly secure against photographic reproduction, but from the absence of other necessary features may be easily copied by an engraver of ordinary skill. There are two systems of engraving employed in bank-notes:—(1) line-engraving in which the lines are cut into the steel or copper plates; and (2) relief-engraving in which the lines stand up above the plate as in wood-engraving. In the former, adapted to the process called plate-printing, the ink is delivered from the lines in the plate to the paper pressed upon it; in the latter, adapted to surface-printing, the ink is spread upon the face of the lines and printed as in typography. Plate-printing gives by far the finer and sharper impression, but as there is a perceptible body of ink transferred to the paper from the cut lines, it has been supposed that an impression from plate would

be more easily photographed than one from surface where only a film of ink is spread upon the top of the raised lines. But surface-printing being much less sharp and distinct than plate-printing, imperfect copies of notes for which that process is used are the more likely to escape detection. The plates upon which the early notes were engraved being of copper quickly wore out and had to be constantly replaced. The result was great difference in the appearance of the notes, those printed from new plates being sharp and clear, while others, printed from old plates, were pale and blurred. These differences were a great assistance to the forger, as the public, being accustomed to variations of appearance between different genuine notes, were less apt to remark the difference between these and counterfeits.

In the early part of the 19th century, Jacob Perkins (1766-1849) introduced into England from America what is known as the transfer-process, in which the original engraving on steel is hardened and an impression taken from it on a soft steel cylinder, which in its turn is hardened and pressed into a soft printing-plate. By this means as many absolutely identical plates can be produced as may be required, and being hardened they will yield a very large number of prints without any appreciable deterioration. Another method of securing uniformity is the multiplication of plates by electro-deposition, the surface of the copper-electrotype plates being protected by the deposit of a film of steel which effectually prevents the wearing of the copper and can be renewed at will.

The water-mark of the paper, on which formerly reliance was placed almost exclusively, puts a difficulty in the way of the counterfeiter, but experience has shown that in ordinary circumstances it does not in itself afford adequate protection. The means by which it can be imitated are well known, and, since a distinct water-mark is incompatible with strong paper, the life of a water-marked note is much shorter than that of one printed upon plain paper. The best bank-note paper is made from pure linen rags and was formerly made by hand. Machine-made paper is however now largely used, as it possesses all the strength of hand-made and is much more uniform in thickness and texture.

In documents which pass current as money it is obviously the duty of the bank or government issuing them to take all reasonable means to prevent the public from being defrauded by the substitution of counterfeits; and a bank whose circulation depends upon the confidence of the public must do so in its own interests to insure the acceptance of its notes. This principle is now recognized by all issuing institutions, but in practice there is room for improvement in the issues of many important establishments, partly because of the disinclination of the directors of a bank to change the form of an issue to which the public is accustomed, partly because of the difficulty of deciding what is really a secure note, and in certain cases because, owing to exceptional circumstances, an issue may be practically immune from forgery although the notes themselves present little or no difficulty in imitation. The features essential to the security of an issue are (1) absolute identity in appearance of all notes of the issue; (2) adequate protection by properly-selected colours against photographic reproduction; and (3) high-class engraving comprising geometric lathe work and well-executed vignettes. In addition it is important that the design of the note should be striking and pleasing to the eye, and the inscription legible.

The notes of the Bank of England are printed in the bank from surface-plates in black without colour or special protection except the water-mark in the paper. They are never reissued after being once returned to the bank, and their average life is very short, about six weeks, so that a dirty or worn Bank of England note is practically never seen. This arrangement, coupled with the difficulty of negotiating forged notes in England, the lowest denomination being £5, accounts for the comparative immunity from forgery of the bank's issues.

BANK RATE, a term used in financial circles to designate the rate of discount charged in the chief monetary centres by the state or leading bank, as opposed to the open-market rate. (See **MARKET: Money market.**)

BANKRUPTCY (from Lat. *bancus* or Fr. *banque*, table or counter, and Lat. *ruptus*, broken), the status of a debtor who has been declared by judicial process to be unable to pay his debts. Although the terms "bankruptcy" *Definition.* and "insolvency" are sometimes used indiscriminately, they have in legal and commercial usage distinct significations. When a person's financial liabilities are greater than his means of meeting them, he is said to be "insolvent"; but he may nevertheless be able to carry on his business affairs by means of credit, paying old debts by incurring new ones, and he may even, if fortunate, regain a position of solvency without his creditors ever being aware of his true condition. And even when his insolvency becomes public and default occurs, a debtor may still avert bankruptcy if he is able to effect a voluntary arrangement with his creditors. A debtor may thus be insolvent without becoming bankrupt, but he cannot be a bankrupt without being insolvent, for bankruptcy is a legal declaration of his insolvency and operates as a statutory system for the administration of his property, which is thereby taken out of his personal control.

In primitive communities bankruptcy systems were unknown. Individual creditors were left to pursue their remedies by such means as the law or practice of the community might sanction, and these were generally of a very drastic character. Under the Roman law of the Twelfth Tables, the creditors might, as a last resort, cut the debtor's body into pieces, each of them taking his proportionate share; and although Blackstone in quoting this law appears to cast some doubt upon its too literal interpretation, there can be no doubt that the power of selling the debtor and his family into slavery was one which was habitually exercised in Greece, Rome, and generally among the nations of antiquity. Even among the Jews, whose legislation was of a comparatively humane character, this practice is illustrated by the Old Testament story of the woman who sought the help of Elisha, saying, "Thy servant my husband is dead . . . and the creditor is come to take unto him my two children to be bondmen." The savage severity of these earlier laws was, however, found to be inconsistent with the development of more humane ideas and the growth of popular rights; and tended, as in the case of Greece and Rome, to create serious disturbance in political relations between the patricians, who generally composed the wealthier or creditor class, and the plebeians, in whose ranks the majority of debtors were to be found. Later legislation consequently substituted imprisonment in a public prison for the right of selling the person of the debtor. Under the feudal systems of Europe the state generally insisted on its subjects being left free for military service, and debts could not therefore be enforced against the person of the debtor; but as trade began to develop it was found necessary to provide some means of bringing personal pressure to bear upon debtors for the purpose of compelling them to meet their obligations, and under the practice of the English courts of law the right of a creditor to enforce his claims by the imprisonment of his debtor was gradually evolved (although no express legal enactment to that effect appears at any time to have existed), and this practice continued until comparatively recent times.

Without some system of enforcing payment of debts it would have been impossible for the commerce of the world to have attained its present proportions; for modern commerce is necessarily founded largely on credit, and credit could not have existed without the power of enforcing the fulfilment of financial contracts. On the other hand remedies against a debtor's person, and still more against the persons of his family, are not only inconsistent with the growth of opinion among civilized communities, but are in themselves worse than futile, inasmuch as they strike at the root of all personal effort on the part of a debtor to retrieve his position and render a return to solvency impossible. Hence the necessity of devising some system which is just to creditors while not unduly harsh upon debtors, which discriminates between involuntary inability to meet obligations and willful

Early methods.

Commercial objects.

refusal or neglect, and which secures to creditors as between themselves an equitable share of such of the debtor's assets as may be available for the payment of his liabilities. These are the objects which the bankruptcy laws have primarily in view. Another object, which has not always been so fully recognized as it might appear to deserve, has marked the most recent legislation, namely, the fostering of a higher tone of commercial morality and the protection of the trading community at large from the evils arising through the reckless abuse of credit and the unnatural trade competition thereby engendered. It must be admitted that these objects are of a somewhat conflicting character, and wherever the state has interfered with the view of securing an efficient system of bankruptcy legislation the task has been found to be extremely difficult. Not only have the conflicting interests of the debtor and his creditors to be taken into account, but the method to be adopted in dealing with his property has also given rise to much conflict of opinion, and to a lack of uniformity and consistency in the legislation which dealt with it. The debtor's property was naturally regarded as belonging to the creditors, but it could not be distributed among them until it was realized, and until their respective right and interests were determined by competent authority. In some cases claims to rank as creditors are of doubtful validity. In others the creditor holds securities, the value of which requires investigation, or he claims a preference to which he may or may not be legally entitled. Creditors have thus conflicting interests as between themselves, and are therefore incapable of acting together as a homogeneous body. Hence the necessity for calling in the aid of professional assignees or trustees, solicitors and other agents, who made it their special business to deal with such matters, exercising both administrative and quasi-judicial functions, in return for the remuneration which they receive out of the property for their services. Professional interests, which are not always identical with the interests of the debtor or the creditors, are thus called into existence, and these interests have from time to time exercised a powerful influence in shaping the course of legislation.

While the law of bankruptcy has therefore been largely the product of commercial development, it has necessarily been of slow and gradual growth, tentative in its character, and subject to oscillation between the extremes of conflicting interests according to the temporary and varying predominance of each of these interests from time to time. No intangible grasp of the principles which underlie the history of bankruptcy legislation in England, and no satisfactory explanation of the fluctuating tendencies which have marked its progress, are possible without bearing these considerations in view.

Bankruptcy in England.

The subject was originally dealt with in the sole interest of creditors; it was considered fraudulent for a debtor to procure his own bankruptcy. Thus the earliest English statute *History.* on the subject, 34 & 35 Henry VIII. c. 4 (A.D. 1542), was directed against fraudulent debtors, and gave power to the lord chancellor and other high officers to seize their estates and divide them among the creditors, but afforded no relief to the debtor from his liabilities. Subsequent legislation modified this attitude and introduced the principle of granting relief to the bankrupt with or without the consent of the creditors, where he conformed to the provisions of the bankruptcy law, and under the act of 1825 the debtor was allowed himself to initiate proceedings. Since 1542 about forty acts of parliament have been passed, dealing with the many aspects of the subject, and slowly expanding, modifying and building up the highly complex system of administration which now exists.

The courts exercising jurisdiction originally consisted of commissioners appointed by the lord chancellor. But in 1831 a special court of bankruptcy was established, consisting of six commissioners with four judges as a court of review, and official assignees attached to the court for the purpose of getting in the distributing the bankrupt's assets. Non-traders were originally excluded from the

bankruptcy court, and a special court called the "court for relief of insolvent debtors" was instituted for their benefit, in which relief from the liability to imprisonment could be obtained on surrender of their property, but they were not discharged from their debts, subsequently-acquired property remaining liable. Both of these courts were subsequently abolished, non-traders were permitted to obtain the benefit of the bankruptcy laws, including a discharge, and in 1869 the system of official assignees was swept away, and a new court of bankruptcy created with one of the vice-chancellors at its head as chief judge, and a number of subordinate registrars or inferior judges under him. This court has also now been abolished, and the business is administered by a judge of the high court specially appointed for the purpose by the lord chancellor, with registrars of the high court, who deal with the ordinary judicial routine of bankruptcy procedure in the London district, while similar duties are performed by the county-court judges throughout the country.

But the questions which have proved the most difficult to deal with, and which more than any others have been the cause of fluctuating and inconsistent legislation, have undoubtedly been those relating to the share which the creditors ought to have in the administration of the proceedings, and to special arrangements effected between a debtor and his creditors under conditions more or less beyond the control of the court. These two questions are largely intermixed, and the history of English legislation on these points and its results throw much light on the causes of the failure of the many attempts which have been made by the most eminent legal authorities to bring the law into a satisfactory condition. The right of creditors to exercise some control in bankruptcy over the realization of the debtor's property through an assignee chosen by themselves was recognized at an early date, but this right was exercised subject to the supervision of the court which investigated the claims of creditors and determined who were entitled to take part in the proceedings. Provision was also made for the interim protection of the debtor's property by official assignees attached to the court, who took possession until the creditors could be consulted, and under the supervision of the court audited the accounts of the creditor's assignee. So long as this system continued substantial justice was generally secured; the claims of creditors were strictly investigated and only those who clearly proved their right before a competent court were entitled to take part in the proceedings. The bankrupt was released from his obligations, but only after strict inquiries into his conduct and under the exercise of judicial discretion. The accounts of assignees were also strictly investigated, and the costs of solicitors and other agents were taxed by officers of the court. But the system was found to be cumbersome, to lead to delay and too often to the absorption of a large part of the estate in costs, over the incurring of which there was a very ineffective control. Hence arose a demand for larger powers on the part of creditors, and the introduction into the bankruptcy procedure of the system of "arrangements" between the debtor and his creditors, either for the payment of a composition, or for the liquidation of the estate *free from the control of the court.* At first these arrangements were carefully guarded. Under the act of 1825 a proposal for payment of a composition might be adopted only after the debtor had passed his examination in court, and with the consent of nine-tenths in number and value of his creditors assembled at a meeting. Upon such adoption the bankruptcy proceedings were superseded. Dissenting creditors, however, were not bound by the resolution, but could still take action against the debtor's subsequently-acquired property. These powers were not found to be sufficiently elastic and the act failed to give public satisfaction. Attempts were made by the acts of 1831 and 1842 to remedy the defects complained of by a reconstitution of the bankruptcy court and its official system. But these measures also failed because they were based on the assumption that judicial bodies could exercise effective control over administrative Rights of creditors.

action, a control for which they are naturally unsuited, and which they could only carry out by cumbersome and expensive methods of procedure. Under the act of 1849 a totally new principle was introduced by the provision that a deed of arrangement executed by six-sevenths in number and value of the creditors for £10 and upwards should be binding upon all the creditors without any proceedings in or supervision by the court. But the determination of the question who were or were not creditors was practically left to the debtor himself, without any opportunity for testing by independent investigation the claims of those who signed the deed to control the administration of the estate. It is not difficult to see, in the light of subsequent experience, how likely this provision was to encourage fraudulent arrangements, and to introduce laxity in the administration of debtors' estates. A modification of the too stringent conditions of the act of 1825, which would have enabled a bankrupt to pay a composition on his debts, with the consent of a large proportion of his bona-fide creditors, and subject to the approval of the court, after hearing the objections of dissenting creditors, would doubtless have proved a beneficial reform, but the act of 1849 proceeded on a very different principle. Instead of reforming, it practically abolished judicial control. By avoiding Scylla it fell into Charybdis. To give any majority of creditors the power to release a debtor from his obligations to non-assenting creditors without full disclosure of his affairs, and without any exercise of judicial discretion or any investigation into the causes of the failure, or the conduct of the debtor, would in any circumstances have been to introduce a new and mischievous principle into legislation, for it would necessarily destroy the essential feature of such arrangements, that they are *voluntary* contracts, the responsibility for which lies solely with the parties entering into them. But to give such a power to creditors whose claims were subject to no independent investigation was to invite inevitable confusion and failure.

Yet this was the dominating principle of English bankruptcy legislation for nearly thirty-five years. Its effect under the act of 1849 was, however, to some extent modified by

1861.

subsequent decisions of the courts that to make a composition arrangement binding it must be accompanied by a complete *cessio bonorum*; but this qualification was removed by the act of 1861 which made such arrangements binding without a *cessio* and reduced the majority required to make a deed of arrangement binding on all the creditors, to a majority in number and three-fourths in value of those whose claims amounted to £10 and upwards. The result was an enormous increase in fraudulent arrangements. The then attorney-general, Sir Robert Collier, in introducing an amending act in 1869, described the abuses which had grown up under the 1849 and 1861 acts, as having the effect of enabling a bankrupt to "defraud those to whom he was indebted and to set them at defiance"; while Lord Cairns, the lord chancellor, in the House of Lords expressed the opinion that the large increase which had taken place in the annual insolvency of the country during the preceding years could not "be attributed to depression of trade but must be traced to the enormous facilities which are given to debtors who wish to be released from their debts on easy terms." And yet in the legislation which ensued these facts were entirely ignored or lost sight of.

It is indeed a curious illustration of the difficulties which have attended bankruptcy legislation in England that the very measure

1869.
(the act of 1869) which was introduced to remedy this deplorable condition of affairs, was twelve years afterwards denounced in parliament by the president of the Board of Trade (Mr Joseph Chamberlain) as "the most unsatisfactory and most unfortunate of the many attempts which had been made to deal with the subject" and as "the object of the almost unanimous condemnation of all classes." How was this? Under the act of 1869, the procedure under a bankruptcy petition was certainly rendered effective. Meetings of creditors were presided over and creditors' claims were, for voting purposes, adjudicated upon by the registrar of the court; the bankrupt had to pass a public examination in court, which although chiefly left to the trustee

appointed by the creditors, afforded some opportunity for investigation; and the bankrupt could not obtain his discharge without the approval of the court and in certain circumstances the consent of the creditors. An independent official, the comp-troller in bankruptcy, was appointed, whose duty it was to examine the accounts of trustees, call them to account for any misfeasance, neglect or omission, and refer the matter to the court for the exercise of disciplinary powers where necessary. These provisions were well calculated to promote sound administration, but they were, unfortunately, rendered nugatory by provisions relating to what were practically private arrangements on similar lines to those which had rendered previous legislation ineffective. In some respects the evil was aggravated. Deeds of arrangements were nominally abolished, but under sections 125 and 126 of the act a debtor was empowered to present a petition to the court for liquidation of his affairs by "arrangement," or for payment of a composition, whereupon a meeting of creditors was summoned from a list furnished by the debtor, and without any judicial investigation of claims, a majority in number and three-fourths in value of those who lodged proofs of debt, and who were present in person or by proxy at the meeting, might by resolution agree to liquidation by arrangement or to the acceptance of the composition. Such resolution thereupon became binding upon all the creditors, without any act of approval by the court, any judicial examination of the debtor, or any official supervision over the trustee's accounts. The debtor was not permitted to present a bankruptcy petition against himself, and consequently his only method of procedure was that which thus removed the matter from the supervision and control of the court, and as about nine-tenths of all the proceedings under the act of 1869 were initiated by debtors, it followed that only about one-tenth was submitted to proper investigation. It is true that the creditors might refuse to assent to the debtor's proposal, and that any creditor for £50 or upwards could present a petition in bankruptcy, but even where this course was adopted, the proceedings under the petition were, as a rule, stayed by the court if the debtor subsequently presented a proposal for liquidation or composition, and the creditor was left to pay the expenses of his petition if the requisite majority voted for the debtor's proposal. So far, therefore, as the act was concerned, every inducement was held out to the adoption of a course which took the examination of the debtor, the conditions of his discharge and the audit of the trustee's accounts, out of the control of the court.

The establishment of a bankruptcy court, with its searching powers of investigation and its power of enforcing penalties on misconduct, can only be defended on the ground that the administration of justice is a matter affecting the interests of the community at large. But apart from the injury done to these interests by reducing the administration of justice to a question of barter and arrangement between the individuals immediately concerned, one of the chief reasons why the acts of 1849, 1861 and 1869 proved failures, lies in the obvious fact that the creditors of a particular estate are not, as appears to have been assumed, a homogeneous or organized body capable of acting together in the administration of a bankrupt estate. In the case of a few special and highly organized trades it may be otherwise, but in each great majority of cases the creditors have but little knowledge of each other or means of organized action, while they have neither the time nor the inclination to investigate the complicated questions which frequently arise, and which are therefore left in the hands of professional trustees or legal agents. But the appointment of trustees under these acts, instead of being the spontaneous act of the creditors, was frequently due to touting on the part of such agents themselves, or to individual creditors whose interests were not always identical with those of the general body. According to G. Y. Robson, the author of a standard work on the subject, the arbitrary powers conferred by the act of 1861 "led to great abuses, and in many cases creditors were forced to accept a composition, the approval of which had been obtained by a secret understanding between the debtor and favoured creditors, and not unfrequently by the creation of fictitious debts." These evils

Causes of failure of Acts.

were greatly aggravated by the decisions of the court relating to proofs on bills of exchange, under which it was held that the holder of a current bill could prove on the bankrupt estate of an indorser, although the bill was not yet due, and the acceptor was perfectly solvent and able to meet it at maturity. Thus in large mercantile failures, bankers and other holders of first-class bills could prove and vote on the estates of their customers, for whom the bills had been discounted, and thus control the entire proceedings, although they had no ultimate interest in the estate. But probably the greatest source of the abuses which arose under the act of 1869 was the proxy system established by the act and by the rules which were subsequently made to carry it out. The introduction of proxies was no doubt intended to give absent creditors an opportunity of expressing their opinions upon any question which might arise. But the system was too often used for the purpose of stifling the views of those who took an independent part in the proceedings. The form of proxy prescribed by the rules contained no limitation of the powers of the proxy-holder and no impression of the opinion of the creditor. It simply appointed the person named in it as "my proxy," and these magic words gave the holder power to act in the creditor's name on all questions that might be raised at any time during the bankruptcy. Hence arose a practice of canvassing for proxies, which were readily given under the influence of plausible representations, such as the holding out of the prospect of a large composition, but which, when once obtained, could be used for any purpose whatsoever except the receipt of a dividend. Thus it frequently happened that the entire proceedings were controlled by professional proxy-holders, in whose hands these documents acquired a marketable value. They were not only used to vote for liquidation by arrangement instead of bankruptcy proceedings, but not infrequently the matter took the form of a bargain between an accountant and a solicitor, under which the former became trustee and the latter the solicitor in the liquidation, without any provision for control over expenditure or for any audit of the accounts. Even where a committee of inspection was appointed to exercise functions of control and audit, they too were often appointed by the proxy-holders, and not infrequently shared in the benefits. On the other hand, where the amount of debts represented by the proxy-holder was insufficient to carry the appointment of a trustee and committee, the votes could be sold to swell the chances of some other candidate. Hence ensued a system of trafficking in these instruments, the cost of which had in the long run to come out of the estate. The result was that undesirable persons were too frequently appointed, whose main object was to extract from the estate as much as possible in the shape of costs of administration. The debtor was practically powerless to prevent this result. If he attempted to do so he sometimes became a target for the exercise of revenge. His discharge, which under liquidation by arrangement was entirely a matter for the creditors, might be refused indefinitely; and so largely and harshly was this power exercised under the proxy system, especially where it was supposed that the debtor had friends who could be induced to come to his aid, that a special act of parliament was passed in 1887, authorizing the court to deal with cases where, under the act of 1869, a debtor had not been able to obtain a release from his creditors. On the other hand, the complainant debtor, although he had incurred large obligations in the most reckless manner, often succeeded in stifling investigation and obtaining his release without difficulty as a return for his aid in carrying out the arrangement.

The result of such a system could not be other than a failure. After the act of 1869 had been in operation for ten years, the comptroller in bankruptcy reported that out of 13,000 annual failures in England and Wales, there were only 1000 cases (or about 8%) "to which the more important provisions of the act for preventing abuses by insolvent debtors and professional agents applied; the other 12,000 cases (or 92%) escaping the provisions which refer to the examination and discharge of bankrupts, and to the accounts, charges and conduct of the agents employed." It is not to be supposed that all the cases in the latter class were marked by the abuses which have been here described.

In a large number the proceedings were conducted by agents of high character and standing, and with a due regard to the interests of the creditors. But the facilities for fraudulent and collusive arrangements afforded by the act, and the want of effective control over administration, inevitably tended to lower the morale of the latter, and to throw it into the hands of the less scrupulous members of the profession. The demand for reform, therefore, came from all classes of the business community. No fewer than thirteen bills dealing with the subject were introduced into the House of Commons during the ten years succeeding 1869. At length in 1879 a memorial, which was authoritatively described as "one of the most influential memorials ever presented to any government," was forwarded to the prime minister by a large body of bankers and merchants in the city of London. The matter was then referred to the president of the Board of Trade (Mr Chamberlain), who made exhaustive inquiries, and in 1881 introduced a measure which, with some amendments, finally became law under the title of the Bankruptcy Act 1883.

Hitherto the question had been dealt with as one of legal procedure; it was now treated as an act of commercial legislation, the main object of which, while providing by carefully framed regulations for the equitable distribution of a debtor's assets, was to promote and enforce the principles of commercial morality in the general interests of the trading community. One of the chief features of the act of 1883 is the separation which it has effected between the judicial and the administrative functions which had previously been exercised by the court, and the transfer of the latter to the Board of Trade as a public department of the state directly responsible to parliament. Under the powers conferred by the act a new department was subsequently created under the title of the bankruptcy department of the Board of Trade, with an officer at its head called the inspector-general in bankruptcy. This department exercises, under the direction of the Board of Trade, a general supervision over all the administrative work arising under the act. It has extensive powers of control over the appointment of trustees, and conducts an audit of their accounts; and it may, subject to appeal to the court, remove them from office for misconduct, neglect or unfitness. A report upon the proceedings under the act is annually presented to parliament by the Board of Trade, and although the department is practically self-supporting, a nominal vote is each year placed upon the public estimates, thus bringing the administration under direct parliamentary criticism and control. The act also provides for the appointment and removal by the Board of Trade of a body of officers entitled official receivers, with certain prescribed duties having relation both to the conduct of bankrupts and to administration of their estates, including the interim management of the latter until the creditors can be consulted. These officers act in their respective districts under the general authority and directions of the Board of Trade, being also clothed with the status of officers of the courts to which they are attached. While effecting this supervision and control by a public department directly responsible to parliament, the main objects of the measure were to secure—(1) An independent and public investigation of the debtor's conduct; (2) The punishment of commercial misconduct and fraud in the interests of public morality; (3) The summary and inexpensive administration of small estates where the assets do not exceed £300 by the official receiver, unless a majority in number and three-fourths in value of the creditors voting resolve to appoint a trustee; (4) Full control in other cases by a majority in value, over the appointment of a trustee and a committee of inspection; (5) Strict investigation of proofs of debt, with regulations as to proxies and votes of creditors; (6) An independent audit and general supervision of the proceedings and control of the funds in all cases. Besides amending and consolidating previous bankruptcy legislation, the measure also contains special provisions for the administration under bankruptcy law of the estates of persons dying insolvent (§125); and for enabling county courts to make administration orders for payment by instalments in lieu of immediate committal to prison, in the case of judgment debtors whose total indebtedness does

not exceed £50 (§ 122). It also provides for the getting in and administration by the Board of Trade of unclaimed dividends and undistributed balances on estates wound up under previous bankruptcy acts (§ 162). Lastly, it amends the procedure under the Debtors Act of 1869, dealing with criminal offences committed by bankrupts (which, prior to 1869, had been treated as part of the bankruptcy law), by enacting that when the court orders a prosecution of any person for an offence under that act, it shall be the duty of the director of public prosecutions to institute and carry on the prosecution.

An amending act, under the title of the Bankruptcy Act 1890 was passed in that year, mainly with the view of supplementing and strengthening some of the provisions of the act of 1883, more particularly with regard to the conditions under which a bankrupt should be discharged or schemes of arrangement or composition be approved by the court. It also dealt with a variety of matters of detail which experience had shown to require amendment, with the view of more fully carrying out the intentions of the legislature as embodied in the principal act. These two acts are to be construed as one and may be cited collectively as the Bankruptcy Acts 1883 and 1890. They are further supplemented by a large body of general rules made by the lord chancellor with the concurrence of the president of the Board of Trade, which may be added to, revoked or altered from time to time by the same authority. These rules are laid before parliament and have the force of law.

Besides these general acts, various measures dealing with special interests connected with bankruptcy procedure have from time to time been passed since 1883, the chief of which are as follows, *viz.*, the Bankruptcy Appeals (County Courts) Act 1884; the Preferential Payments in Bankruptcy Act 1888, regulating the priority of the claims of workmen and clerks, &c. for wages and salaries; and the Bankruptcy (Discharge and Closure) Act 1887, dealing with unclosed bankruptcies under previous acts.

It would be out of place in this article to attempt to answer the question how far later legislation has solved the difficult problems which prior to 1883 were found so intractable, but it may be mentioned that in 1906 the Board of

Trade appointed a committee to inquire into and report upon the effect of the provisions of the laws in force at the time in the United Kingdom in relation to bankruptcy, deeds of arrangement and composition by insolvent debtors with their creditors, and the prevention and punishment of frauds by debtors on their creditors, and any points and matters upon which the existing laws seemed to require amendment. The committee received a vast amount of evidence as well as documents and memoranda from chambers of commerce, trade protection societies and influential public bodies. The scope of the inquiry was not limited to English law and procedure, but also embraced that of Germany, France, Australia, Scotland and Ireland. The report of the committee was issued in 1908 (Cd. 4068), and reference may be made to it for much valuable information. The committee reported that the result of their inquiry did not disclose any dissatisfaction on the part of the commercial community with the main features of the existing law and procedure. But there were certain special incidents of the law and branches of its administration upon which the committee made recommendations. One was the prosecution and punishment of debtors who had committed fraud on their creditors or caused loss to them by improper and reckless trading. The existing procedure was complained of as being dilatory, cumbersome and expensive, and the committee were of an opinion that where a debtor had committed an offence for which he could and ought to be prosecuted, prosecution and conviction, with adequate punishment, ought to follow speedily and decisively, and the chief recommendation of the committee was that, while the existing procedure should be left untouched, offences ought also to be punishable on summary conviction before magistrates and justices, and the provisions of the Summary Jurisdiction Acts applied to them, and that where an order for a prosecution is made on an application by the official receiver of a bankrupt

court and based on his report, that court should have power to order the official receiver to conduct the prosecution before the court of summary jurisdiction. The committee also reported that numerous delinquencies by insolvent debtors in the conduct of their affairs, or which had contributed to the losses sustained by their creditors, were not punishable or even cognizable by courts having bankruptcy jurisdiction unless or until a debtor who had a receiving order against him, or became a bankrupt, applied for an order sanctioning a composition or scheme of arrangement with his creditors, or for an order discharging him from his debts. The most prominent of these delinquencies which were brought to the notice of the committee were—failure by a debtor to keep any books or any proper or adequate books of account in his business; trading with knowledge of insolvency; gambling and speculation leading to, or contributing to, the debtor's insolvency or bankruptcy; failure properly to account for any substantial deficiency of assets. The committee received a large body of evidence in favour of making delinquencies such as have been described punishable by imprisonment. Evidence was also given as to the laws in force in Germany, France and Scotland, from which it appeared that such delinquencies, especially that of keeping no books of account, can be severely dealt with as criminal offences.

After carefully weighing the evidence on both sides the committee recommended that the failure or omission by a debtor who becomes bankrupt to have kept any books of account, or proper books of account, within two years next preceding his bankruptcy, in a trade or business carried on by him, if without excuse, should be made by law an offence punishable on summary conviction by imprisonment, subject to four important limitations, namely, that the law should define what books of account a person carrying on a trade or business must keep, following in this respect the law in force in France and Germany; that failure or omission by a debtor to have kept the required books should only be punishable in the event of a debtor becoming bankrupt and of the liquidated debts proved in the bankruptcy exceeding £200 in amount; that no prosecution of a debtor for failure or omission to keep books of account should take place before the lapse of two years from the passing of the law; that a debtor should not be punished if he could show that his failure or omission to keep proper books was honest and excusable and did not contribute to his insolvency, and that no prosecution should be instituted for the offence except by order of the bankruptcy court. The committee made recommendations of much the same character with regard to punishing some of the other delinquencies mentioned above. There were also recommendations by the committee as to trading by undischarged bankrupts, as to the realization of estate on bankruptcy, as to the operation of the law of relation back of a bankruptcy trustee's title, as to the law relating to the after-acquired property of an undischarged bankrupt, and dealings with such property, and with respect to married women and their liabilities under bankruptcy law. The committee also reported on the law and practice relating to voluntary deeds of arrangement between a debtor and his creditors and on the compulsory regulation of assignments of book debts, and of agreements for the hire and purchase of chattels.

In addition to this report the annual reports of the Board of Trade, which are accompanied by elaborate tables of statistics, and by copious illustrations both of the working of the system and of the characteristic features and causes of current insolvency, are published as parliamentary papers, and may be usefully consulted by those interested in the subject. It appears from these reports that the total number of insolvencies dealt with under the bankruptcy acts during the ten years ending 31st December 1905, was 43,141, involving estimated liabilities amounting to £61,685,678, and estimated assets amounting to £26,001,417. It may also be pointed out that according to the official figures, the cost of bankruptcy administration under the present system has very considerably decreased as compared with that under the act of 1869. Estates are also closed at much shorter intervals, and, what is more important from a public point of view, it appears

that while the estimated liabilities of bankrupt estates during the ten years ending 1883 amounted on an average to £22,380,000 per annum, the estimated liabilities during the ten years ending 1905 only averaged £6,168,567 per annum. But during the latter period there was an annual average of 3426 private arrangements involving a further estimated annual liability of £4,166,354 entered into outside of the Bankruptcy Acts by insolvent debtors. There are no means of ascertaining the corresponding amount of liabilities on private arrangements outside of the Bankruptcy Acts prior to 1883, and therefore a complete comparison is impossible; but it is evident that on any method of computation there has been a very great diminution in the trading insolvency of England and Wales, while it is also clear as a matter of general knowledge in commercial circles, that a great decrease in the proportion of fraudulent trade and reckless speculation has been a marked feature of private trading during the period in question.

The cost of bankruptcy administration is provided for: (1) by fees charged to bankrupt estates, (2) by interest on balances at the credit of such estates with the bankruptcy estates account, and (3) by interest on unclaimed funds at the credit of estates under former Bankruptcy Acts.

Out of this are paid the salaries of all the officers of the department, including the official receivers; the remuneration due in respect of bankruptcy services to the county court registrars; pensions, &c., payable to retired officers under the present and previous Bankruptcy Acts; cost of bankruptcy prosecutions; and rents, stationery, travelling and other incidental expenses. The system is self-supporting and involves no charge upon the tax-payers of the country. It has been objected that inasmuch as the act professes to be based on the principle of enforcing commercial morality in the interests of the general community, the cost of administering it should not be charged entirely to the bankruptcy estates concerned. But when it is considered that a large part of the revenue of the department is derived from funds to which estates administered under the present act have contributed nothing, this objection does not appear to be well founded.

For the convenience of readers who may require more detailed information, the accompanying summary of some of the more important provisions of the law relating to bankruptcy procedure is submitted. It must be borne in mind, however, that the subject is in some of its branches extremely intricate, and that both the law and the procedure are being constantly affected by a considerable body of judicial interpretation, while the acts also contain detailed provisions with regard to many questions incident to the administration of bankruptcy. A reference to the latest text-books or competent professional advice will always be advisable for those who have the misfortune to be practically interested either as debtors or as creditors in bankruptcy proceedings.

The Deeds of Arrangement Act 1887, although not falling strictly within the scope of the bankruptcy law, may also, in consequence of its important bearing upon the question of insolvency in England and Wales, be here noticed. It has been pointed out that, under the Bankruptcy

Acts of 1849 and 1861, non-official arrangements by deed between a debtor and the general body of his creditors were not only officially recognized, but were in certain circumstances made binding on all the creditors, including those who refused to assent to them. Under the act of 1869, although such deeds were no longer recognized or made binding on non-assenting creditors, the proceedings under the "liquidation by arrangement" and "composition" clauses were practically private arrangements by resolution instead of deed, and were proved by experience to be open to the same abuses. It has also been shown that under the act of 1883 no arrangements either by deed or by resolution have any force against dissenting creditors, unless confirmed after full investigation and approval of the bankruptcy courts. Private arrangements, therefore, cease to form any part of the bankruptcy system. But they are, nevertheless, binding as voluntary contracts between the debtor and such creditors as assent to them. Being, however, in the nature

of assignments of the debtor's property, they are either deemed fraudulent if the benefit of the assignment is limited to a portion of the creditors, or, if it is extended to all they become acts of bankruptcy, and, like any other voluntary assignment, are liable to be invalidated if made within three months prior to the petition on which a receiving order is made against the debtor. Treated as voluntary assignments, which are not binding on those who do not assent to them, such arrangements, where honestly entered into and carried out by capable administration, in many cases form a useful and expeditious method of liquidating a debtor's affairs, and where the debtor's insolvency has been brought about without any gross misconduct they will probably always be largely resorted to. The danger attending them is that even in cases where the debtor has been guilty of misconduct, a private arrangement may be used to screen his conduct from investigation, while in many cases it may be made the medium for the concealment of fraudulent preferences. The absence of any independent audit of the trustees' accounts may also encourage or conceal irregularities in administration. Previous to 1887, however, much inconvenience arose from the fact that the execution of these private arrangements was frequently kept secret, and fresh credit was obtained by the debtor without any opportunity being afforded for the new creditors becoming acquainted with the fact that they were dealing with an insolvent person, and that in many cases they were simply supplying the means for meeting past obligations in respect of which the debtor had already committed default. The Deeds of Arrangement Act 1887 was therefore passed to compel the disclosure of such arrangements, by declaring them void unless registered within seven days after the first execution by the debtor or by any creditor. Registration is effected by lodging with the registrar of bills of sale at the central office of the Supreme Court a true copy of the deed and of every inventory and schedule attached thereto, together with an affidavit by the debtor, stating the total estimated amount of property and liabilities, the total amount of composition, if any, and the names and addresses of the creditors. Where the debtor's residence or place of business is outside the London bankruptcy district, the registrar is required to forward a copy of the deed to the registrar of the county court of the district where the debtor's residence or place of business is situated. Both the central and the local registers are open to public inspection on payment of a small fee and general publicity is secured by the action of various trade agencies, which make a practice of extracting and publishing the information for the benefit of those interested. By section 25 of the Bankruptcy Act 1890, every trustee under a deed of arrangement is required to transmit to the Board of Trade within thirty days of the 1st of January in each year an account of his receipts and payments and such accounts are open to the inspection of any creditor on payment of a small fee. They are not, however, subject to any kind of audit or control by the department. The registrar is also required to make periodical returns of the deeds thus registered to the Board of Trade, in order that a report of proceedings under the Deeds of Arrangement Act may be included in the annual report which the department is required to make on proceedings under the Bankruptcy Acts. Full statistics of such proceedings are accordingly included in these reports, from which it appears that during the ten years ended 31st December 1905 the total number of registered deeds of arrangement was 34,273, with estimated liabilities amounting to £41,663,541, and estimated assets to £23,020,483.

Summary of Bankruptcy Procedure.—Subject to certain special provisions in the case of what are termed "small bankruptcies" (see below), the following summary sets forth some of the more important provisions of the various acts and rules relating to bankruptcy administration grouped under convenient heads to facilitate reference. In some cases the effect of legal decisions has been embodied in the summary.

Preliminary Proceedings.

Petition and Receiving Order.—Any court exercising bankruptcy jurisdiction in the district in which he resides or carries on business

in England or Wales may make a receiving order against a debtor, whether a trader or not, either on his own petition or on that of a creditor or creditors whose claims aggregate not less than £50. In the case of a creditor's petition proof must be given of the debt, and of the commission of an act of bankruptcy within three months preceding the date of the petition. An act of bankruptcy is committed if the debtor fails to satisfy the creditor's claim upon a bankruptcy notice; if he makes an assignment for the benefit of his creditors generally; if he absconds or keeps house; if he gives notice of suspension of payments; if his goods are sold or seized under execution; if he files in court a declaration of inability, to pay his debts; or if he grants a fraudulent preference or conveyance. These acts are here enumerated in the order in which they most frequently occur in practice.

Object and Effect of Receiving Order.—The object of the order is to protect the debtor's property until the first meeting of creditors, and to bring the debtor and his affairs within the jurisdiction of the court. Its effect is to stay all separate action against the debtor, and to constitute the official receiver attached to the court receiver of the debtor's property, although the legal title still remains in the debtor. Where there is an estate or business to be managed the official receiver may appoint a special manager, who receives such remuneration as the creditors, or failing them the specially examined trade, may determine. As a consequence of the order the following obligations are imposed upon the debtor:—He must make out and submit to the official receiver within a prescribed period a statement of his affairs, containing the names and addresses of his creditors, the amount of their claims and the securities held by them, and the nature and value of his assets; and accounting for his deficiency. Any material omission or false statement of his losses or expenses is a misdemeanour under the Debtors Act, unless he can prove that he had no intention to defraud. The statement is open to the inspection of creditors. He must also in every case submit to a public examination in court, in which the official receiver, the trustee and any creditor who has proved his debt may take part. His evidence may be used against him. He may further be specially examined in trade, may be examined by the court, and a summary order may be made against such person for delivery of any property belonging to the debtor.

First Meeting of Creditors.

This meeting is summoned by the official receiver, notice being given in the *London Gazette* and in a local paper, and sent by post to each creditor. A summary of the statement of affairs should accompany the notice, with any observations by the official receiver which he may think fit to make. The object of the meeting is to decide whether any proposal for payment of a composition or for a scheme of arrangement submitted by the debtor is to be entertained, or whether an application should be made to the court to adjudicate on the debtor's bankruptcy. In the latter case the meeting may be an ordinary resolution appoint a trustee with or without a committee of inspection. It may also give any directions as to the administration of the estate. The meeting should be held at the place most convenient for the majority of the creditors. It is presided over by the official receiver or his deputy, who, subject to appeal to the court, admits or rejects proofs for the purpose of voting. For the transaction of business three creditors qualified to vote, or all the creditors if fewer than three, must be present or represented. Only persons who have proved their debts are entitled to vote, and detailed regulations respecting proofs and the valuation of securities are laid down in the first and second schedules to the act of 1883. One of the chief alterations in the law on this point is the condition imposed on creditors on bills of exchange to deduct from their claims the value of the liability of prior obligants before voting, thus cancelling the power of controlling the proceedings previously possessed by persons who had no real interest in the estate. Votes may be given in person or by proxy, and stringent regulations are laid down with the view of preventing the abuse of proxies. General proxies entitling the holder to exercise all the powers which the creditor could exercise if present may be given to the official receiver or to any person in the regular employment of the creditor. Special proxies may be given to any person to vote for specified resolutions, or for the appointment of specified persons as trustee and committee. Only official forms can be used, and the blanks must be filled up in the handwriting of the creditor or some person in his regular employment, including the authorized agent of a creditor resident abroad. A proxy must be lodged with the official receiver not later than four o'clock on the day before the meeting or adjourned meeting at which

it is to be used. Resolutions are ordinary, special or extraordinary. An ordinary resolution is carried by a majority in value of the creditors voting; a special resolution by a majority in number and three-fourths in value of such creditors. The only instance of a resolution other than these is that required for the approval of a composition or scheme which requires a majority in number and three-fourths in value of all the creditors who have proved. The majority of questions arising at a meeting are decided by an ordinary resolution.

Adjudication.

If the creditors so resolve, if by a composition or scheme of arrangement is not proposed by the debtor or entertained by the creditors, or if entertained is not approved by the court, or if without reasonable excuse the debtor fails to furnish a proper statement of his affairs, or if his public examination is adjourned *sine die*, the court adjudicates the debtor bankrupt and thereupon his property vests in a trustee, and, subject to the payment of the costs and fees of administration, is divisible among his creditors until all his debts are paid in full with interest at the rate of 4% per annum.

Effect on Bankrupt.—The bankrupt is bound to aid the trustee in his administration, and if he wilfully fails to deliver up any part of his property he is guilty of contempt of court. He is also liable to criminal prosecution under the Debtors Act if with intent to defraud he conceals or removes property to the value of £50 or upwards; or if he fails to deliver to the trustee all his property, books, documents, &c.; or if he knowingly permits false debts to be proved on his estate without disclosure; or mutilates, falsifies, destroys or parts with books or accounts; or attempts to account for his property by fictitious losses; or if within four months next before presentation of a bankruptcy petition, he obtains property on credit by false representation; or pledges or disposes of, otherwise than in the ordinary way of his trade, any property which has not been paid for; or by misrepresentation obtains the assent of his creditors to any agreement with reference to his affairs. He is also liable under the act of 1883, guilty of misdemeanour if before his discharge he obtains credit for more than £20 from any person without informing such person that he is an undischarged bankrupt. It is the duty of the official receiver to report any such facts to the court, and if the court is satisfied that there is a reasonable probability of conviction, it is required to order a prosecution which is then conducted by the director of public prosecutions.

Disqualifications.—A bankrupt cannot during his bankruptcy or until five years after his discharge, unless the bankruptcy is annulled or he obtains his discharge with a certificate by the court that the bankruptcy was caused by misfortune without misconduct, act as a member of the legislature, or as a justice of the peace, mayor, alderman, councillor, guardian or overseer of the poor, member of a sanitary authority, school, highway or burial board, or select vestry in any part of the Kingdom.

Annulment.—An order of adjudication may be annulled if the court is of opinion that it should not have been made, or that the bankrupt's debts are paid in full, or if a composition or scheme of arrangement is approved by the court after adjudication.

Discharge.—The court may also at any time after the conclusion of the bankrupt's public examination, and after hearing the official receiver, the trustee and any creditor, to all of whom previous notice of the application must be given, grant the bankrupt a discharge either absolutely or under conditions, but subject to the following qualifications, viz.:—(1) If the bankrupt has committed a criminal offence connected with the bankruptcy, the application must be refused unless for special reasons the court determines otherwise. (2) If the assets are not equal in value to ten shillings in the pound of the unsecured liabilities (unless the bankrupt can show that he is not responsible); or if proper books have not been kept; or if the bankrupt has traded after knowledge of insolvency; or has contracted debts without reasonable probability of payment; or failed to account for his deficiency; or contributed to the bankruptcy by rash speculation, gambling, culpable neglect or by unjustifiable expenses; or has taken or defended legal proceedings on frivolous grounds; or has within three months preceding the receiving order given an undue preference; or has increased his liabilities with the view of making his assets equal to ten shillings in the pound; or has previously been bankrupt or made an arrangement with his creditors; or has been guilty of any fraud or fraudulent breach of trust; then the court shall, on proof of any of these facts, either (a) refuse the discharge, or (b) suspend it for a period of not less than two years, or until a dividend of not less than ten shillings in the pound has been paid; or (c) qualify the order by the condition that judgment is entered up against the bankrupt for payment of any unpaid balance of his debts, or of part of such balance out of his future earnings or property. The bankrupt may, however, after two years apply to the court to modify the conditions if he is unable to comply with them. An order of discharge releases the debtor from all his obligations except debts due to the crown, and other obligations of a public character which can only be discharged with the consent of the Treasury, debts incurred by fraud, and judgment debts in an action for seduction or as a co-respondent in a matrimonial suit or under an affiliation order, which are only released to such extent and subject to such conditions as the court may expressly order. The release of the bankrupt does not operate as a release

of any partner or co-obligant with him. Neither does it release the bankrupt from liability to criminal prosecution.

Composition or Scheme of Arrangement.

After a receiving order has been made the debtor may submit a proposal for the payment of a composition, or for the liquidation of his affairs, by terms or otherwise, with the adjudicator. The proposal must be lodged with the official receiver in sufficient time to allow notice, together with a report by that officer, to be sent to the creditors before the meeting is held at which it is to be considered. If the proposal is entertained at the meeting by a majority in number and three-fourths in value of all the creditors who have proved their debts, and if it is thereafter approved by the court, it becomes binding upon all creditors who will be bound by an order of discharge had the debtor been adjudicated bankrupt. A similar proposal may be made after adjudication, and if entertained by the creditors and approved by the court, the adjudication may be annulled. The debtor's release will be subject to the terms of the scheme, but his future acquired property will not pass to the creditors unless there is an express stipulation to that effect. If default is made in carrying out the scheme, or if it is found that it cannot proceed without injustice or undue delay, the court may at any time adjudicate the debtor bankrupt, in which case the scheme will fall to the ground, except in respect of past transactions under it. The approval of a composition or scheme does not release the debtor from his liabilities under the criminal law, nor from the necessity of undergoing a public examination which must, in fact, be held and concluded before the approval of the court is applied for. Also before such approval is given a report must be filed by the official receiver upon its terms and on the conduct of the debtor, and the court must be satisfied after hearing that officer and any creditor, that the proposal is reasonable and calculated to benefit the creditors, and that no criminal offences connected with the bankruptcy have been committed by the debtor. Further, if any fact is proved which would have prevented the debtor from obtaining an absolute or unconditional order of discharge had he been adjudged bankrupt, the composition or scheme cannot be approved unless it provides reasonable security for the payment of not less than seven shillings and sixpence in the pound on all the unsecured debts. Where a trustee is appointed to carry out the composition or scheme, all the provisions of the act with reference to the remuneration of the trustee and the usual duties of a trustee apply to the trustee in the control exercised by the Board of Trade apply in the same manner as they would under an adjudication. Further, the provisions relating to the administration of property, proof of debts, dividends, &c., will also apply, so far as the nature of the case and the terms of the arrangement admit.

Property divisible among the Creditors.

No part of the law of bankruptcy is more intricate, or has been the subject of more litigation, than this, and any detailed view of the effect of legal decisions can only be gathered by a perusal of the cases; but the following general principles may be stated:—The term "property" includes not only property of which the bankrupt is the true owner, but property in his possession, order or disposition in his trade or business with the consent of the true owner, in such circumstances that he is the reputed owner thereof. The application of the doctrine of reputed ownership has been considerably restricted in recent years by the growth of alleged trade customs, in accordance with which property is frequently lent under a contract of "hire and purchase" or otherwise; and by the decisions of the courts that where such custom is sufficiently proved the doctrine does not apply. Further, the trustee's title not only includes property in the actual possession of the bankrupt, but relates back to the date of the first act of bankruptcy committed by him within the three months preceding the presentation of the bankruptcy petition, and thus invalidates all payments and assignments to creditors made during that period with knowledge on the part of the creditor or assignee of the commission of the act of bankruptcy. In such cases the trustee may, therefore, require the money or property to be restored to the estate. And even where no prior act of bankruptcy is proved, any payment made to a creditor with the view of giving such creditor a preference over the other creditors, within the three months preceding the presentation of the petition, in which the payer is made bankrupt, is rendered void as against his trustee. Settlements of property within the two years preceding the bankruptcy, unless made before and in consideration of marriage, or made in good faith for valuable consideration, are also void, as are similar settlements within ten years, unless it is proved that the settlor was (independently of the settled property) solvent at the date of the settlement, and that the interest in the property passed to the trustees on the execution of the deed. The same rule applies to covenants to settle in consideration of marriage future-acquired property in which the debtor had no interest at the date of the marriage (other than property acquired by the bankrupt through his wife), if such property was not actually transferred before the bankruptcy. Executions by a creditor not completed at the date of the receiving order are also void, and the proceeds of an execution in the hands of the sheriff must, with certain exceptions and subject to deduction of costs, be handed over to the trustee. But all property

held by the bankrupt on trust, and tools of trade, wearing apparel and bedding to a total value not exceeding £20, are excluded from the property divisible among the creditors. With respect to property acquired by the bankrupt, whether by gift or legacy, or consisting of accumulations of business or other profits after the commencement of the bankruptcy, and before he obtains his discharge, the trustee's title also prevails; but bona-fide transactions by the debtor for value, other than transactions relating to freehold property, appear to be valid. Where the bankrupt is a beneficed clergyman the trustee may, subject to certain provisions for the due discharge of the duties of the office, apply for the sequestration of the profits of the benefice; and where he is in receipt of a salary, income or pension, &c., the court may order any part thereof to be paid to the trustee, but where he is an officer of the army, navy or civil service, such order is only to be made with the consent of the chief of the department concerned.

Claims of Creditors and Dividends.

In the distribution of the debtor's property certain claims are entitled to priority over others. Thus the landlord, although not entitled to a preference out of the funds in the hands of the trustee, can distrain for unpaid rent on the goods and effects of the debtor remaining on the landlord's premises, but where the distraint is levied after the commencement of the bankruptcy this right is limited by the act of 1860 to six months' rent due before adjudication, the remainder of his claim ranking for dividend with the claims of other creditors. Various gas and water companies have also statutory powers of distraint under special acts, but the policy of recent legislation has been to discourage any extension of such privileges. Where the bankrupt holds an office of trust in any savings bank or friendly society, any balance in his hands due to such bank or society has been held under the acts relating to these bodies to be payable in preference to any other claim against the estate. Other preferential claims are regulated by the Bankruptcy Acts and by the Preferential Payments in Bankruptcy Act of 1888, and include taxes, parochial and other local rates for not more than one year, wages and salaries for four months, but not exceeding £50 (limited in the case of ordinary labourers and workmen to two months' wages not exceeding £25), and agricultural labourers' claims not exceeding one year's wages, if hired by special contract for payment of a lump sum at the end of a year. These claims are entitled to preference not only over funds in the hands of the trustee, but also over the proceeds of any distraint levied by the landlord within the three months prior to the receiving order, the latter in that case becoming a preferred creditor for the amount so paid. Articled clerks and apprentices may also be allowed repayment of a proportion of the premium on their expired agreements. On the other hand, usual trade discounts (exceeding 5%) must be deducted from traders' proofs, and the following claims are postponed until the general creditors are paid in full, viz. claims by a married woman for loans to the husband for the purposes of his business, claims for amounts advanced to any person in business at a rate of interest varying with the profits, and claims for interest in excess of 5% per annum. Subject to these exceptions all debts proved in the bankruptcy must be paid *pari passu*. Any surplus after payment of 20s. in the pound and interest at the rate of 4% per annum, from the date of the receiving order, is payable to the bankrupt.

Proofs of Debt.—All claims and liabilities present or future, certain or contingent, arising out of obligations incurred before the date of the receiving order are provable in the bankruptcy, an estimate of the liability in the case of contingent debts being made by the trustee subject to appeal to the court. But demands in the nature of unliquidated damages arising otherwise than by reason of a contract, promise or breach of trust are not provable. A secured creditor, if he proves himself either surrender his security, or value the security and prove for the balance; and the trustee can thereupon, subject to the creditor's power in certain circumstances to amend the valuation, take over the security by paying the amount of the valuation, or may require it to be realized. He may be required by the creditor to elect which of these courses he will adopt, failing which the equity of redemption will vest in the creditor. For further regulations as to proofs, the time within which they must be lodged for voting and for dividend, and the manner of dealing with them, reference should be made to the first and second schedules of the act of 1869 and the rules relating thereto.

Dividends.—After payment of costs of administration and preferential debts, it is the duty of the trustee to distribute the estate with all convenient speed,—the first dividend within four months after the first meeting of creditors, and subsequent dividends at intervals of not more than six months, but the declaration may be postponed for sufficient reason by the committee of inspection. Notice of the intention to declare a dividend is gazetted and sent to each creditor mentioned in the bankrupt's statement of affairs who has not proved. The notice should state the last day for proving in order to participate in the distribution, and should be given not more than two months before the declaration. When the dividend is declared notice of the amount due out of the place where the same is payable, is sent to each creditor who has proved, with a statement showing particulars of the estate. And provision must be made for creditors at a distance, who have not had time to prove, for disputed claims, and for debts the subject of claims not

yet determined. Creditors who fail to prove before the declaration of a dividend are entitled to receive their dividends on proving before any subsequent dividend is declared, but cannot disturb the distribution of any dividend already declared. Before distributing a final dividend notice is sent to every creditor whose claim has been notified to the trustee, but not finally established, with an intimation that unless so established within a specified period he will be excluded from participation in the estate. In the case of a bankrupt firm the joint creditors are not entitled to receive a dividend out of the separate property of the bankrupts until all the separate creditors are paid in full.

Trustee's Administration.

While the interim preservation and management of the estate is conducted by or under the direct supervision of officers appointed by and responsible to the Board of Trade, the ultimate realization and distribution of the assets devolve upon the trustee appointed by the creditors. But besides acting as receiver prior to the first meeting of creditors, the official receiver also becomes trustee by operation of law on the making of an order of adjudication. He vacates the office when a trustee is appointed by the creditors, and ceases to be the Board of Trade, but again becomes trustee on the creditors' trustee being released, dying, resigning or being removed from office. As the bankrupt's property vests in the trustee for the time being, and passes from trustee to trustee by operation of law, and without any formal act of conveyance, the continuity of the office is thus secured.

Appointment of Trustee.—A trustee may be appointed by a majority in value of the creditors voting, at the first or any subsequent meeting, or the appointment may be left to the committee of inspection. In either case the appointment is subject to confirmation by the Board of Trade, who may object on the ground that the creditors have not acted in good faith in the interests of the general body, or that the person appointed is not fit to act, or occupies such a position in relation to the estate, or is a creditor of the estate, as makes it difficult for him to act with impartiality, or that in any previous case he has been removed from office for misconduct or for failure without good cause to render his accounts for audit. An appeal from such objection to the High Court lies at the instance of a majority in value of the creditors, but in the absence of an appeal it is fatal to the appointment. Before being confirmed, the trustee-elect must also furnish security to the satisfaction of the Board of Trade, and such security must be kept up to the amount originally fixed, or to such lesser amount as that department may require throughout the tenure of the trusteeship, failing which the trustee is liable to be removed from office. Where the creditors fail to appoint a trustee, the Board of Trade may do so, but such appointment may at any time be superseded by the creditors.

Removal.—The trustee may be removed by the creditors at a meeting summoned for the purpose without reason assigned, or by the Board of Trade for misconduct, or for incapacity or failure to perform his duties, or on either of the other personal grounds of objection to which the appointment is open. But the removal is in like manner subject to appeal at the instance of creditors. If a receiving order is made against a trustee he thereby vacates office. He may also, with the consent of a general meeting of creditors, resign, but his resignation does not operate as a release from his liability to account for his administration.

Powers and Duties.—The trustee is required to take immediate possession of the bankrupt's property, including deeds, books and accounts, and has the powers of a receiver in the High Court for the purpose of enforcing delivery. After payment of the costs of administration it is his duty to distribute the estate in dividends as speedily as possible. He may also, and with the sanction of the committee, or, where there is none, with that of the Board of Trade, carry on the business so far as is necessary to a beneficial winding-up, institute or defend legal proceedings, employ a solicitor to do any business previously sanctioned by the same authority, compromise debts and claims, raise money on mortgage, sell property on credit, or divide the estate where practicable among the creditors in any directing form. He may, without special sanction, but subject to its exercise which may be given by the creditors in general meeting, or failing them by the committee, and the property or any part of it be sold, including business goodwill and fixtures, and either by public auction or private treaty, and generally exercise all the powers which the bankrupt might before adjudication have exercised in relation to the property, or which are by the Bankruptcy Act conferred on the trustee.

Where any part of the property is held subject to onerous obligations, such as the payment of rent, &c., the trustee may disclaim the same, subject in certain cases to the leave of the court, and the disclaimer operates to determine all interest in or liability in respect of the property on the part of the estate. The trustee is required to keep a record book (which is commenced by the official receiver), containing minutes of the proceedings in the bankruptcy, and a cash book in the prescribed form, in which all receipts and payments by him must be entered. All monies received must forthwith be paid into an account at the Bank of England, entitled the "Bankruptcy Estates Account," which is under the control of the Board of Trade, unless where in special circumstances the sanction of that depart-

ment is obtained to the opening of a local banking account, but in no circumstances must estate monies be paid to the trustee's private account. When monies are required for the purpose of the estate, special cheques or money orders are issued by the Board of Trade on the application of the trustee.

Control over Trustee.—In his administration of the estate the trustee is subject to control by the committee of inspection, the creditors, the court and the Board of Trade. The committee is appointed by the creditors, and must consist of not more than five nor less than three creditors or authorized representatives of creditors. It acts by a majority present at a meeting, and should be convened once a month unless it otherwise directs. If no committee is appointed, the Board of Trade may give any directions or permission which might have been given by a committee. Directions given by the committee, if not inconsistent with the provisions of the act, are binding on the trustee, unless contrary to or overruled by those of the creditors or of the court. The official receiver or trustee may summon a meeting of the creditors at any time to ascertain their wishes, and must do so when so required by one-sixth in value of the creditors or when directed by the court. The Board of Trade may also direct the official receiver to summon a meeting for the purpose of reviewing any act done by the trustee or any resolution of the committee of inspection. Further, the trustee may apply to the court for directions in any particular matter, and the court may also, on the application of any person aggrieved reverse or vary any order of the trustee, or make such order as it deems just. The directions of the court override those of the creditors. The Board of Trade is required to take general cognizance of the conduct of trustees, to inquire into any complaints by creditors, and in the event of any trustee not faithfully performing his duties, to take such action, including the power of removal, as may be expedient. It may also direct a local investigation of the trustee's books and accounts, and may require him to answer any inquiries, or may apply to the court to examine him on oath. If any loss has arisen to the estate from any misfeasance, neglect or omission of the trustee, it may require him to make it good. The orders of the Board of Trade under the powers conferred by the act may be enforced by the court by a committal of the trustee or otherwise.

Audit of Accounts.—The trustee must be audited by the committee of inspection not less than once in every three months; and once in every six months, as well as at the close of the administration, the record and cash books must also be submitted with the vouchers, and the committee's certificate of audit to the Board of Trade for final audit. If it appears that the trustee has retained more than £50 in hand for more than ten days without a satisfactory explanation, he may be removed from office, surcharged with interest at the rate of 20% per annum and lose all claim to remuneration.

Remuneration.—The trustee's remuneration is fixed by the creditors or by the committee if so authorized by them. It must be in the nature of a percentage on the amount of the realization of the dividends. If one-fourth of the creditors in number or value dissent from the resolution, or if the bankruptcy satisfies the Board of Trade that the remuneration is excessive, the Board may review the same and fix the remuneration. A trustee may not receive any remuneration for services rendered in any other capacity, e.g. as solicitor, auctioneer, &c., beyond that voted to him as trustee; nor may he share his remuneration with the bankrupt, the solicitor or other person employed about the bankruptcy; or receive from any person any gift, or other pecuniary or personal benefit in connexion therewith.

Costs.—A trustee receiving remuneration is not allowed the costs of any other person in respect of duties which ought to be performed by himself. All bills of solicitors and other agents employed must be taxed before payment, as being in accordance with the prescribed scales of costs; and the taxing master must satisfy himself that the employment has been ordered by the court before the work was done. All bills of costs must be delivered to the trustee within seven days of the request for the same, otherwise the estate may be distributed without regard to such costs.

Release.—When the property, so far as it is capable of realization, has been realized and distributed, the trustee must apply to the Board of Trade for his release, forwarding to each creditor a notice of his having done so, together with a copy of his final accounts, and the Board of Trade, after preparing and considering a report on the same, and the objections of any person interested, may, subject to appeal to the High Court, grant or withhold the release. If a release is withheld, the court may, on the application of any person interested, make such order against the trustee as it thinks just. The release when granted operates as a removal from office, and thereupon the official receiver again becomes trustee, and is thus in a position, even after the nominal close of the bankruptcy, to deal with any circumstances which may arise, or which have not been foreseen and provided for.

Small Bankruptcies.

When the official receiver reports, or the court is otherwise satisfied that the debtor's property is not likely to realize more than £500, the court may, in such cases, order the summary administration of the estate, in which case, if the debtor is a small bankrupt, the official receiver in the ordinary course becomes and remains trustee, and certain other modifications are effected with the view of simplifying

and accelerating the procedure. The chief of these modifications are as follows, viz. the Board of Trade acts as committee of inspection; there is no advertisement of the proceedings in a local paper; in legal proceedings all questions of law and fact are determined by the court without a jury; adjudication may be made on a report by the official receiver before the first meeting of creditors where no composition or scheme is proposed; meetings of creditors may be held in the town where the court sits or the official receiver's office is situated; notice to creditors of meetings other than the first meeting, or of application by a debtor for his discharge, are dispensed with in the case of creditors for amounts not exceeding £2. Costs, other than a solicitor's charges, may be paid without taxation; and the time for declaring the first dividend is extended to six months, but the whole estate must be realized and distributed within this period if practicable. No modification, however, is permitted in the procedure relating to the public examination and discharge of the bankrupt. Notwithstanding that an order has been made for summary administration, the creditors may at any time by a resolution passed by a majority in number and three-fourths in value of those voting at the meeting, appoint a trustee in place of the official receiver, in which case the summary order ceases to be operative.

Scottish Bankruptcy Legislation.

In Scotland, as in England, the law of bankruptcy arose as a remedy against the frauds of insolvent debtors. It was declared by an act of the Scottish parliament (1621, c. 18) that no debtor after insolvency should fraudulently diminish the fund belonging to his creditors, and if a deed of assignment was gratuitously executed after the contracting of debt in favour of a near relation or a confidential friend, fraudulent dealing was to be presumed. The act 1696, c. 5, settled the definition of a notour or notorious bankrupt, a question which had previously engaged the attention of the judges of the court of session. The statute defines "a notour bankrupt" to be any debtor who, being under diligence by horning or caption, at the instance of his creditors, shall be either imprisoned, or retire to the abbey or any other privileged place, or flee or abscond for his personal security, or defend his person by force, and who shall afterwards be found, by sentence of the lords of session, to be insolvent. Bankruptcy as thus defined was, it is said, intended to afford a remedy against fraudulent preference by debtors, and not as the ground-work of a general process of distribution, although by later statutes it became a necessary requisite of every such process. The exceptions recognized in the act of 1696, of persons absent from Scotland and therefore not liable to imprisonment, or of persons exempted therefrom by special privileges, were removed by later legislation. The old English distinction between traders and non-traders, it will be observed, is not recognized in Scottish law. The statute made null and void all voluntary dispositions, assignments and other deeds made after or within sixty days before bankruptcy.

In 1856 was passed the Bankruptcy (Scotland) Act, by which the law of bankruptcy in Scotland is mainly regulated. By this act, notour (*i.e.* legally declared) bankruptcy was constituted:—

1. By sequestration (or adjudication in England and Ireland); and

2. By insolvency concurring either—(a) with a duly executed charge for payment or (b) with sale of effects belonging to the debtor under a pouding or under a sequestration for rent, or making application for the benefit of *cessio bonorum*.

Notour bankruptcy continues, in cases of sequestration, until the debtor has obtained his discharge and in other cases until insolvency ceases. Sequestration may be awarded of the estate of any person in the following cases:—

1. Living debtor subject to jurisdiction of Scottish courts—(a) on his own petition with concurrence of qualified creditors, or (b) on petition of qualified creditors, provided he be a notour bankrupt, and have had a dwelling-house or place of business in Scotland within the previous year.

2. In the case of a deceased debtor, subject at his death to the jurisdiction of the court—(a) on the petition of his mandatory; or (b) on the petition of qualified creditors (§ 13).

Sequestration may be awarded either by the court of session or by the sheriff. A sequestration may be recalled by a majority in number and four-fifths in value of the creditors, who may prefer to wind up the estate by private arrangement. If the

sequestration proceeds, the creditors hold a meeting, and by a majority *in value* elect a trustee to administer the estate, and three commissioners (being creditors or their mandataries) to assist and control the administration and declare the dividends. The bankrupt (under pain of imprisonment) must give all the information in his power regarding his estate and he must be publicly examined on oath before the sheriff; and "conjunct and confident persons" may likewise be examined. The bankrupt may be discharged either by composition or without composition. In the latter case (1) by petition with concurrence of all the creditors, or (2) after six months with concurrence of a majority and four-fifths in value of the creditors, or (3) after eighteen months with concurrence of a bare majority in number and value, or (4) after two years without concurrence. In the last case the judge may refuse the application if he thinks the bankrupt has fraudulently concealed his effects or wilfully failed to comply with the law. This act was amended by the Bankruptcy and Real Securities Act 1857, which deals with the cost of competition for trusteeships; the Bankruptcy Amendment (Scotland) Act 1860, which enables the court to recall a sequestration where it is more convenient that the estate should be wound up in England or Ireland; and the Bankruptcy Amendment Act (Scotland) 1875, which makes the wages of clerks, shopmen and servants preferential claims for a period not exceeding four months and an amount not exceeding £50, while the claims of workmen are placed on a similar footing for a period not exceeding two months. Some important changes were subsequently introduced, one of the principal being that effected by the Debtors (Scotland) Act 1880, which abolished imprisonment for debt, but which, like its English prototype (the Debtors Act 1869), contains a series of important provisions for the punishment of fraudulent bankrupts. Under these provisions the laws of the two countries on that subject are practically assimilated, although some minor differences still survive. One of the most important of these differences is, that while the Scottish act makes the failure, within the three years prior to the sequestration, to keep "such books and accounts as, according to the usual course of any trade or business in which he (the debtor) may have been engaged, are necessary to exhibit or explain his transactions" a criminal offence, the English act contains no provision of an analogous character; the non-keeping of such books being treated as a fact to be taken into account in dealing with the debtor's application for his discharge but not coming within the scope of the criminal law. On the other hand, there are a few minor trading irregularities dealt with in the English act which are not specifically included in that of Scotland. Another important distinction is that under the Scottish act the same offences may be treated differently, according as they are brought for trial before the court of justiciary or a sheriff and jury, in which case the maximum penalty is two years' imprisonment; or before a sheriff without a jury, in which case the penalty is limited to imprisonment for a period not exceeding sixty days. This distinction admits of a useful elasticity in the administration of the law, having regard to the comparative importance of the case, which is hardly possible under the English act.

Another most important modification of the law is effected by the Debtors Act 1880, combined with the Bankruptcy and Cessio Act 1881, and the Act of Sederunt anent Cessios of the 22nd of December 1882. Under the law existing prior to these enactments, the process of *cessio bonorum* operated chiefly as a means for obtaining release from imprisonment for debt on a formal surrender by a debtor of all his goods and estate. But under this process the debtor was not entitled to a discharge, and his future-acquired property was still subject to diligence at the instance of unsatisfied creditors. By abolishing imprisonment for debt (except in regard to crown debts and public rates and assessments), the legislature also practically abolished this use of the process of *cessio*, and the process itself would probably have become obsolete, but for certain changes effected by the act of 1881, which have given it a different and more extended scope. Among these changes may be noted (1)

the extension to "any creditor of a debtor who is notour bankrupt," without reference to the amount of his debt, of the right hitherto limited to the debtor himself, to petition the court for a decree of *cessio*, the prayer of the petition, whether presented by the debtor or by a creditor, being "to appoint a trustee to take the management and disposal of the debtor's estate for behoof of his creditors"; (2) the discretionary power given to the court upon such petition to award sequestration under the bankruptcy act, in any case where the liabilities of the debtor exceed £200; and (3) the right of the debtor to apply for his discharge under similar conditions to those obtaining in the case of sequestration. An important modification of the law relating to discharge which equally affects a debtor under the Bankruptcy and *Cessio* Acts, is also effected by the provision of the act of 1881, which requires, in addition to the concurrence of creditors, the fulfilment of one of the following conditions, viz., "(a) That a dividend of five shillings in the pound has been paid out of the estate of the debtor, or that security for payment thereof has been found to the satisfaction of the creditors; or (b) that the failure to pay five shillings in the pound has, in the opinion of the sheriff, arisen from circumstances for which the debtor cannot justly be held responsible." Orders of *cessio* are only made in the sheriff courts, and when made, the court also appoints a trustee, who conducts the proceedings without the control exercised by the creditors in a sequestration. Under these conditions it will be seen that the original purpose and constitution of the process of *cessio* has entirely disappeared, and it has now become a modified form of official bankruptcy procedure, with a less elaborate routine than in the case of sequestration, and one perhaps more suitable to the smaller class of cases, to which in practice it is limited.

The Bankruptcy Frauds and Disabilities (Scotland) Act 1884 applies to sequestrations and decrees of *cessio* the criminal provisions of § 31 of the English Bankruptcy Act 1883, relating to the obtaining of credit for £20 and upwards by an undischarged bankrupt, without disclosure of his position. It also places the law relating to the disqualifications attaching to such bankrupts on a similar footing to that of the English act.

The Judicial Factors Act of 1880 contains a provision calculated to check excessive costs of administration, by requiring that where the remuneration of a trustee under a sequestration is to be fixed by the commissioners, intimation of the rate of remuneration is to be given to the creditors and to the accountant of court before being acted on, and the latter officer is empowered, subject to appeal, to modify the same if he deems it expedient.

It may be pointed out that the Deeds of Arrangement Act 1887, which applies to England and Ireland, does not apply to Scotland, and there is no analogous provision requiring registration of private deeds of assignment for the benefit of creditors as a condition of their validity in that country.

Finally, it is to be noted that the office of accountant in bankruptcy, which was established by the Bankruptcy Act of 1866, has under the Judicial Factors Act 1880 been abolished, the duties being merged in those of the office of accountant of the court of session.

Irish Bankruptcy Legislation.

The Irish law of bankruptcy is regulated by the two leading Irish statutes of 1857 and 1872, together with the Irish Debtors Act 1872, and corresponds in its main features to some of the older English enactments, with modifications adopted from the English act of 1869. It may be pointed out, however, that the system of liquidation by arrangement and composition without the approval or control of the court, which proved fatal to the success of the latter, has not at any time been imported into the Irish law. A special act was passed in 1888 for establishing local bankruptcy courts in certain districts in Ireland, and an act was also passed in 1880, applying the main provisions of the English Act of 1888, relating to preferential payments in bankruptcy, to Ireland.

The Deeds of Arrangement Act 1887, which has been already discussed above under the head of English bankruptcy legislation, also applies in its main provisions to Ireland, and as supplemented

by the Irish Deeds of Arrangement Amendment Act 1890, places the law relating to this branch of insolvency procedure upon a similar footing in both countries, so far as regards the publicity of such deeds. The last-mentioned act also requires a similar registration of all petitions for arrangement under the Bankruptcy Act 1857.

(J. SM.)*

COMPARATIVE LAW

British Empire.—In most parts of the British empire the law of bankruptcy has been modelled upon the English system. This is particularly the case in Australia and New Zealand. Victoria, South Australia, Western Australia and New Zealand follow the lines of the existing English acts. In Queensland, Tasmania and New South Wales the system is rather that of the English act of 1869, leaving more to the creditors' management and less to officials.

One point may be mentioned in which the Australian colonies have improved on the English system. Under the English acts a bankrupt is under no obligation to apply for his discharge. The result is that the United Kingdom contains a population of 70,000 undischarged bankrupts—a manifest danger to the trading community. Under the bankruptcy systems of New South Wales, Victoria and New Zealand, a bankrupt is bound to apply for his discharge within a fixed period, otherwise he is guilty of a contempt of court.

In Canada, under the British North America Act 1867, the Dominion parliament has exclusive legislative power in regard to bankruptcy and insolvency; but there is no existing Dominion act on the subject. A Dominion act was passed in 1875, but repealed in 1880. The failure of this act may perhaps be ascribed to the diversity of the pre-existing provincial systems, embracing such contrasts as the English law of Ontario, and the French code based on *cessio bonorum*—which ruled in Quebec. Bankruptcy is dealt with in a fragmentary way by the provincial legislatures by acts regulating such matters as priority of execution creditors, fraudulent assignments and preferences, imprisonment of debtors, administration of estates of deceased insolvents.

In Cape Colony and Natal English law is substantially followed. In the Transvaal, where Roman-Dutch law prevails, the law governing the subject is the Insolvency Law, No. 13 of 1895. It provides for voluntary surrender and compulsory sequestration. The law of the Orange River Colony is similar.

In British Guiana, Gambia, Jamaica, Hong Kong, Mauritius, Grenada, Trinidad, Tobago and the Straits Settlements the law is modelled on the English pattern.

In India insolvency is regulated by the Indian Insolvency Act 1848, extended by the Act XI. of 1880.

An English bankrupt, it may be added, is entitled to plead his discharge in England as a defence in a colonial court. The explanation is this. The English act vests all the bankrupt's property, whether in the United Kingdom or in the colonies, in his trustee in bankruptcy. Having thus denuded him of everything, it has been held to follow that the bankrupt's discharge must also receive recognition in a colonial court.

France.—Bankruptcy in France is regulated by the Commercial Code of 1807, amended and supplemented by the law of 9th June 1838. By Article 437 of the code bankruptcy is defined as the state of a trader who is unable to meet his commercial engagements. Simple insolvency of this kind is known in France as *faillite*. Insolvency attended with circumstances of misconduct or fraud is known as *banqueroute simple* or *banqueroute frauduleuse*. Only a trader can become bankrupt. The debt, too, for obtaining adjudication must be a commercial debt, the laws regulating bankruptcy being designed exclusively for the protection of commerce. To be made a bankrupt a trader need not be insolvent: it is sufficient that he has suspended payment. Commercial companies of all kinds are liable to be declared bankrupt in the same manner as individual traders. A trader-debtor can be adjudicated bankrupt upon his own petition, or upon the petition of a creditor, or by the court itself *proprio motu*. A petitioning debtor must within fifteen days file at the

office of the Tribunal of Commerce of the district, a declaration of suspension, with a true account of his conduct and of the state of his affairs, showing his assets, debts, profits and losses and personal expenses. On adjudication the Tribunal of Commerce appoints a person, called a *syndic provisoire*, to manage the bankrupt's estate, and a *judge commissaire* is also named to supervise the *syndic*. A bankruptcy terminates by an ordinary composition (*concordat*), a sale of the debtor's assets (*union*), or a composition by relinquishment of assets. It is a striking feature of the French system, and highly creditable to French commercial integrity, that a discharge in bankruptcy, even when accompanied by a *declaration d'excusabilité*, leaves the unpaid balance a debt of honour. At the time of the French Revolution the National Convention passed a resolution that any man who contracted a debt should never be free from liability to pay it. The spirit of this resolution still survives, for until a trader has paid every penny that he owes he is not rehabilitated and remains under the stigma of various disabilities: he has no political rights, he cannot hold any public office, or act as a stockbroker, or sit on a jury. *Banqueroute simple* is where the bankrupt has been guilty of grave faults in the conduct of his business, such as extravagance in living, hazardous speculation or preferring creditors. *Banqueroute frauduleuse* involves the worse delinquency of fraud. Both *banqueroute simple* and *banqueroute frauduleuse* are punishable,—the latter with penal servitude ranging from five to twenty years.

Germany.—Bankruptcy in Germany is governed by a code passed in 1877. Prior to this each state had its system and the law was "wholly chaotic." The same distinction is drawn in Germany as in France between mere commercial failure and bankruptcy, simple or fraudulent. Simple bankruptcy is established by such offences as gambling, dealing in "futures," disorderly book-keeping or extravagance in living; fraudulent bankruptcy, by offences of a deeper dye—the concealment of property, the falsifying of books, the manufacture of fictitious debts and the giving of illegal preferences. Both kinds of bankruptcy are punishable, fraudulent bankruptcy by penal servitude, or in case of mitigating circumstances, by imprisonment for not less than three months. Accessories in fraudulent bankruptcies are liable to penal servitude—for instance, a creditor who conspires with the debtor to secure an advantage to the prejudice of the other debtors. The creditors are called together within one month from the date of adjudication, and at their meeting they may appoint a committee of their number to advise with the trustee. It is the duty of the court to see that the trustee performs his functions. Estates are liquidated with great rapidity. In order that the creditors may receive dividends at the earliest moment, it is customary to sell the assets by auction. The creditors by a majority in number and three-fourths in value may accept a composition, but such an arrangement must have the approval of the court. The fees are very moderate: in an ordinary bankruptcy the attorney's fees do not, it is said, exceed £5.

Italy.—Bankruptcy in Italy is regulated by the Commercial Code of 1883 (Part III.). Only merchants can pass through the bankruptcy court. Merchants are defined by the code as those who, as an habitual profession, engage in commercial business. This definition includes merchant companies. Bankruptcy proceedings may be taken either by the debtor or by a creditor for a commercial debt, or may be ordered by the court. The amount of the debt is immaterial: a small sum will suffice, provided its non-payment is proof of insolvency. Bankruptcy can only be declared where there is insolvency. The judgment adjudicating a debtor bankrupt deprives the bankrupt of the right to administer his affairs, and nominates a trustee to realize the property under the superintendence of a judge and a commission of creditors. All the property of the bankrupt, movable and immovable, is sold by auction and distributed in dividends. This is one way of closing the bankruptcy, but it may also be closed by an arrangement. No minimum percentage is required for such arrangement, but it must have the assent of creditors

representing three-fourths of the bankrupt's indebtedness. Composition before bankruptcy is not recognized by Italian law. Bankrupts are liable to criminal proceedings involving punishments more or less heavy for offences against the law, e.g. for not keeping books in the way prescribed by law.

United States.—After much fragmentary legislation the bankruptcy system of the United States is now embodied in the National Bankruptcy Act of 1898, as amended by the act of 1903. The acts of bankruptcy under the act may be summarized as follows: where a debtor (1) removes any of his property to hinder or delay his creditors; (2) being insolvent, transfers property with intent to prefer a creditor; (3) suffers any creditor to obtain a preference; (4) makes a general assignment for the benefit of his creditors; (5) "admits in writing his inability to pay his debts and his willingness to be adjudicated a bankrupt on that ground." These acts of bankruptcy do not include, it will be observed, non-payment by a debtor of his debts. A debtor can therefore only be adjudicated a bankrupt on the ground of indebtedness with his own consent in writing. Presumably the legislature thought that the desire to obtain the protection and privilege of bankruptcy would be a sufficient inducement to confess insolvency, where such insolvency, in fact, exists.

To constitute a fraudulent preference it is not necessary, as it is under English law, that the payment should be made "with a view to prefer" the favoured creditor. It is enough that the creditor is preferred. This avoids the nice questions of legal casuistry which have embarrassed the English courts, and it is the more rational rule, for creditors are not concerned with a debtor's intention. Any person, trader or non-trader, may avail himself of the act, but, in the case of a corporation, there is this peculiarity: it may be petitioned against but cannot petition.

Insolvency is construed in a practical sense; that is, a person is insolvent where the aggregate of his property, at a fair valuation, is insufficient to pay his debts; but he is not necessarily insolvent because his realized assets are insufficient to meet his liabilities.

Involuntary proceedings can only be taken against debtors owing \$1000 or over, with certain exceptions. A petitioning creditor's debt must amount to \$500.

The administration of the law of bankruptcy is entrusted to the district courts and is exercised through the medium of certain officers appointed by the courts and called referees. The creditors appoint a trustee or trustees of the estate.

So soon as his judicial examination is over the bankrupt may offer his creditors a composition, but to take effect the composition must be approved by the court after hearing objections.

The discharge is the key to the efficiency of every bankruptcy system. By the control which the court thus holds, it is enabled to bring its moral censorship to bear on a debtor's conduct and so maintain a high standard of commercial integrity. Under the United States system the judge is to investigate the merits of the application and to discharge the bankrupt, unless he has (1) committed an offence punishable by imprisonment; (2) with intent to conceal his financial condition, destroyed, concealed, or failed to keep books of account or records from which such condition might be ascertained; or (3) obtained property on credit from any person upon a materially false statement in writing made to such person for the purpose of obtaining such property on credit; or (4) at any time, subsequent to the first day of the four months immediately preceding the filing of the petition, transferred, removed, destroyed or concealed any of his property with intent to hinder, delay or defraud his creditors; or (5) in voluntary proceedings been granted a discharge in bankruptcy within six years; or (6) in the course of proceedings in bankruptcy refused to obey any lawful order of or to answer any material question approved by the court.

It is significant that the italicized qualifications were added to the act of 1898 by the experience of five years of its working.

BANKS, GEORGE LINNAEUS (1821–1881), British miscellaneous writer, was born at Birmingham on the 2nd of March 1821. After a brief experience in a variety of trades, he became at the age of seventeen a contributor to various newspapers, and subsequently a playwright, being the author of two plays, a couple of burlesques and several lyrics. Between 1848 and 1864 he edited in succession a variety of newspapers, including the *Birmingham Mercury* and the *Dublin Daily Express*, and published several volumes of miscellaneous prose and verse. He died in London on the 3rd of May 1881.

BANKS, SIR JOSEPH, Bart. (1743–1820), English naturalist, was born in Argyle Street, London, on the 13th of February 1743. His father, William Banks, was the son of a successful Lincolnshire doctor, who became sheriff of his county, and represented Peterborough in parliament; and Joseph was brought up as the son of a rich man. In 1760 he went to Oxford, where he showed a decided taste for natural science and was the means of introducing botanical lectures into the university. In 1764 he came into possession of the ample fortune left by his father, and in 1766 he made his first scientific expedition to Newfoundland and Labrador, bringing back a rich collection of plants and insects. Shortly after his return, Captain Cook was sent by the government to observe the transit of Venus in the Pacific Ocean, and Banks, through the influence of his friend Lord Sandwich, obtained leave to join the expedition in the "Endeavour," which was fitted out at his own expense. He made the most careful preparations, in order to be able to profit by every opportunity, and induced Dr Daniel Solander, a distinguished pupil of Linnaeus, to accompany him. He even engaged draughtsmen and painters to delineate such objects of interest as did not admit of being transported or preserved. The voyage occupied three years and many hardships had to be undergone; but the rich harvest of discovery was more than adequate compensation. Banks was equally anxious to join Cook's second expedition and expended large sums in engaging assistants and furnishing the necessary equipment; but circumstances obliged him to relinquish his purpose. He, however, employed the assistants and materials he had collected in a voyage to Iceland in 1772, returning by the Hebrides and Staffa. In 1778 Banks succeeded Sir John Pringle as president of the Royal Society, of which he had been a fellow from 1766, and held the office until his death. In 1781 he was made a baronet; in 1795 he received the order of the Bath; and in 1797 he was admitted to the privy council. He died at Isleworth on the 10th of June 1820. As president of the Royal Society he did much to raise the state of science in Britain, and was at the same time most assiduous and successful in cultivating friendly relations with scientific men of all nations. It was, however, objected to him that from his own predilections he was inclined to overlook and depreciate the labours of the mathematical and physical sections of the Royal Society and that he exercised his authority somewhat despotically. He bequeathed his collections of books and botanical specimens to the British Museum. His fame rests rather on what his liberality enabled other workers to do than on his own achievements.

See J. H. Maiden, *Sir Joseph Banks* (1909).

BANKS, NATHANIEL PRENTISS (1816–1894), American politician and soldier, was born at Waltham, Massachusetts, on the 30th of January 1816. He received only a common school education and at an early age began work as a bobbin-boy in a cotton factory of which his father was superintendent. Subsequently he edited a weekly paper at Waltham, studied law and was admitted to the bar, his energy and his ability as a public speaker soon winning him distinction. He served as a Free Soiler in the Massachusetts house of representatives from 1849 to 1853, and was speaker in 1851 and 1852; he was president of the state Constitutional Convention of 1853, and in the same year was elected to the national House of Representatives as a coalition candidate of Democrats and Free Soilers. Although re-elected in 1854 as an American or "Know-Nothing," he soon left this party, and in 1855 presided over a Republican convention in Massachusetts. At the opening of the Thirty-Fourth Congress the anti-Nebraska men gradually

united in supporting Banks for speaker, and after one of the bitterest and most protracted speakership contests in the history of congress, lasting from the 3rd of December 1855 to the 2nd of February 1856, he was chosen on the 133rd ballot. This has been called the first national victory of the Republican party. Re-elected in 1856 as a Republican, he resigned his seat in December 1857, and was governor of Massachusetts from 1858 to 1861, a period marked by notable administrative and educational reforms. He then succeeded George B. McClellan as president of the Illinois Central railway. Although while governor he had been a strong advocate of peace, he was one of the earliest to offer his services to President Lincoln, who appointed him in 1861 major-general of volunteers. Banks was one of the most prominent of the volunteer officers. When McClellan entered upon his Peninsular Campaign in 1862 the important duty of defending Washington from the army of "Stonewall" Jackson fell to the corps commanded by Banks. In the spring Banks was ordered to move against Jackson in the Shenandoah Valley, but the latter with superior forces defeated him at Winchester, Virginia, on the 25th of May, and forced him back to the Potomac river. On the 9th of August Banks again encountered Jackson at Cedar Mountain, and, though greatly outnumbered, succeeded in holding his ground after a very sanguinary battle. He was later placed in command of the garrison at Washington, and in November sailed from New York with a strong force to replace General B. F. Butler at New Orleans as commander of the Department of the Gulf. Being ordered to co-operate with Grant, who was then before Vicksburg, he invested the defences of Port Hudson, Louisiana, in May 1863, and after three attempts to carry the works by storm he began a regular siege. The garrison surrendered to Banks on the 8th of July, on receiving word that Vicksburg had fallen. In the autumn of 1863 Banks organized a number of expeditions to Texas, chiefly for the purpose of preventing the French in Mexico from aiding the Confederates, and secured possession of the region near the mouths of the Nueces and the Rio Grande. But his Red River expedition, March–May 1864, forced upon him by superior authority, was a complete failure. In August 1865 he was mustered out of the service, and from 1865 to 1873 he was again a representative in congress, serving as chairman of the committee on foreign affairs. A personal quarrel with President Grant led in 1872, however, to his joining the Liberal-Republican revolt in support of Horace Greeley, and as the Liberal-Republican and Democratic candidate he was defeated for re-election. In 1874 he was successful as a Democratic candidate, serving one term (1875–1877). Having rejoined the Republican party in 1876, he was United States marshal for Massachusetts from 1879 until 1888, when for the ninth time he was elected to Congress. He retired at the close of his term (1891) and died at Waltham on the 1st of September 1894.

BANKS, THOMAS (1735–1805), English sculptor, son of a surveyor who was land steward to the duke of Beaufort, was born in London on the 29th of December 1735. He was taught drawing by his father, and in 1750 was apprenticed to a wood-carver. In his spare time he worked at sculpture, and before 1772, when he obtained a travelling studentship and proceeded to Rome, he had already exhibited several fine works. Returning to England in 1779 he found that the taste for classic poetry, ever the source of his inspiration, no longer existed, and he spent two years in St Petersburg, being employed by the empress Catherine, who purchased his "Cupid tormenting a Butterfly." On his return he modelled his colossal "Achilles mourning the loss of Briseis," a work full of force and passion; and thereupon he was elected, in 1784, an associate of the Royal Academy and in the following year a full member. Among other works in St Paul's cathedral are the monuments to Captain Westcott and Captain Burges, and in Westminster Abbey to Sir Eyre Coote. His bust of Warren Hastings is in the National Portrait Gallery. Banks's best-known work is perhaps the colossal group of "Shakespeare attended by Painting and Poetry," now in the garden of New Place, Stratford-on-Avon. He died in London on the 2nd of February 1805.

BANKS AND BANKING. The word "bank," in the economic sense, covers various meanings which all express one object, a contribution of money for a common purpose. Thus Bacon, in his essay on *Usury*, while explaining "how the discommodities of it may be avoided and the commodities retained," refers to a "bank or common stock" as an expression with which his readers would be familiar. Originally connected with the idea of a mound or bank of earth—hence with that of a *monte*, an Italian word describing a heap—the term has been gradually applied to several classes of institutions established for the general purpose of dealing with money.

The manner in which a bank prospers is explained by David Ricardo, in his *Proposals for an Economical and Secure Currency*,

**Banking
as a
business.**

in a passage where he tells us that a bank would never be established if it obtained no other profits but those derived from the employment of its own capital. The real advantage of a bank to the community it serves comes only when it employs the capital of others. The money which a bank controls in the form of the deposits which it receives and sometimes of the notes which it issues, is loaned out by it again to those who desire to borrow and can show that they may be trusted. A bank, in order to carry on business successfully, must possess a sufficient capital of its own to give it the standing which will enable it to collect capital belonging to others. But this it does not hoard. It only holds the funds with which it is entrusted till it can use them, and the use is found in the advances that it makes. Some of the deposits merely lie with the bank till the customer draws what he requires for his ordinary everyday wants. Some, the greater part by far, of the deposits enable the bank to make advances to men who employ the funds with which they are entrusted in reproductive industry, that is to say, in a manner which not only brings back a greater value than the amount originally lent to them, but assists the business development of the country by setting on foot and maintaining enterprises of a profitable description. It is possible that some part may be employed in loans required through extravagance on the part of the borrower, but these can only be a small proportion of the whole, as it is only through reproductive industry that the capital advanced by a banker can really be replaced. A loan sometimes, it is true, is repaid from the proceeds of the sale of a security, but this only means a transfer of capital from one hand to another; money that is not transferred in this way must be made by its owner. Granted that the security is complete, there is only one absolute rule as to loans if a bank desires to conduct its business on safe lines, that the advance should not be of fixed but of floating capital. Nothing seems simpler than such a business, but no business requires closer attention or more strong sense and prudence in its conduct. In other ways also, besides making loans, a well-conducted bank is of much service to the business prosperity of a country, as for example by providing facilities for the ready transmission of money from those who owe money to those to whom it is due. This is particularly obvious when the debtor lives in one town or district and the creditor in another at a considerable distance, but the convenience is very great under any circumstances. Where an easy method of transmission of cash does not exist, we become aware that a "rate of exchange" exists as truly between one place and another in the same country as between two places in different countries. The assistance that banking gives to the industries of a community, apart from these facilities, is constant and most valuable.

With these preliminary remarks on some main features of the business, we may pass on to a sketch of the history of modern banking. Banks in Europe from the 16th century onwards may be divided into two classes, the one described as "exchange banks," the other as "banks of deposits."

These last are banks which, besides receiving deposits, make loans, and thus associate themselves with the trade and general industries of a country. The exchange banks included in former years institutions like the Bank of Hamburg and the Bank of Amsterdam. These were established to deal with foreign exchange and to facilitate trade with other countries.

The others—founded at very different dates—were established as, or early became, banks of deposit, like the Bank of England, the Bank of Venice, the Bank of Sweden, the Bank of France, the Bank of Germany and others. Some reference to these will be made later. The exchange banks claim the first attention. Important as they were in their day, the period of their activity is now generally past, and the interest in their operations has become mainly historical.

In one respect, and that a very important one, the business carried on by the exchange banks differed from banking as generally understood at the present time. No exchange bank had a capital of its own nor did it require any for the performance of the business. The object for which exchange banks were established was to turn the values with which they were entrusted into "current money," "bank money" as it was called, that is to say, into a currency which was accepted immediately by merchants without the necessity of testing the value of the coin or the bullion brought to them. The "value" they provided was equal to the "value" they received, the only difference being the amount of the small charge they made to their customers, who gained by dealing with them more than equivalent advantages.

Short notices of the Bank of Amsterdam, which was one of the most important, and of the Bank of Hamburg, which survived the longest, its existence not terminating till 1873, will suffice to explain the working of these institutions.

The *Amsterdamsche Wisselbank*, or exchange bank, known later as the Bank of Amsterdam, was established by the ordinance of the city of Amsterdam of 31st January 1609. The increased commerce of Holland, which made Amsterdam a leading city in international dealings, led to the establishment of this bank, to which any person might bring money or bullion for deposit, and might withdraw at pleasure the money or the worth of the bullion. The ordinance which established the bank further required that all bills of 600 gulden (£50), or upwards—this limit was, in 1643, lowered to 300 gulden (£25)—should be paid through the bank, or in other words, by the transfer of deposits or credits at the bank. These transfers came afterwards to be known as "bank money." The charge for making the transfers was the sole source of income to the bank. The bank was established without any capital of its own, being understood to have actually in its vaults the whole amount of specie for which "bank money" was outstanding. This regulation was not, however, strictly observed. Loans were made at various dates to the Dutch East India Company. In 1705 a report was issued showing that the city of Amsterdam was largely indebted to the bank, which held as security the obligations of the states of Holland and West Friesland. The debt was paid, but it was too late to revive the bank, and in 1820 "the establishment which for generations had held the leading place in European commerce ceased to exist." (See *Chapters on the Theory and History of Banking*, by Charles F. Dunbar, p. 105.)

Similar banks had been established in Middelburg (March 28th, 1616), in Hamburg (1610) and in Rotterdam (February 9th, 1635). Of these the Bank of Hamburg carried on much the largest business and survived the longest. It was not till the 15th of February 1873 that its existence was closed by the act of the German parliament which decreed that Germany should possess a gold standard, and thus removed those conditions of the local medium of exchange—silver coins of very different intrinsic values—whose circulation had provided an ample field for the operations of the bank. The business of the Bank of Hamburg had been conducted in absolute accordance with the regulations under which it was founded.

The exchange banks were established to remedy the inconvenience to which merchants were subject through the uncertain value of the currency of other countries in reference to that of the city where the exchange bank carried on its business. The following quotation from *Notes on Banking*, written in 1873, explains the method of operation in Hamburg. "In this city, the most vigorous offshoot of the once powerful Hansa, the latest representative of the free commercial cities of medieval Europe,

there still remains a representative of those older banks which were once of the highest importance in commercial affairs. Similar institutions greatly aided the prosperity of Venice, Genoa, Amsterdam and Nuremberg. The Bank of Hamburg is now the last survivor of these banks, whose business lay in the assistance of commerce, not by loans, but by the local manufacture, so to speak, of an international coinage. In a city of the highest rank of commercial activity, but greatly circumscribed in territory, continually receiving payments for merchandise in the coin of other countries, a common standard of value was a matter of primary necessity. The invention of bank money, that is, of a money of account which could be transferred at pleasure from one holder to another, enabled the trade of the place to be carried on without any of those hindrances to business which must have followed on the delay and expense attendant on the verification of various coins differing from each other in weight, intrinsic value, standard of purity of metal, in every point in fact in which coins can differ from each other. By supplying a currency of universal acceptance the Bank of Hamburg greatly contributed to the prosperity of that city." The regulations being strictly carried out, the currency was purely metallic; the "Mark Banco" being merely the representative of an equal value of silver.

For the earliest example of a bank for the receipt of deposits carrying on a business on modern lines, we must turn, as in the case of the exchange banks, to a great commercial city of the middle ages. Private banking in Venice began as an adjunct of the business of the *campsores* or dealers in foreign moneys. "As early as 1270 it was deemed necessary to require them to give security to the government as the condition of carrying on their business, but it is not shown that they were then receiving deposits. In an act of the 24th of September 1318, however, entitled *Bancheris scriptae de re plegiaris consultibus*, the receipt of deposits by the *campsores* is recognized as an existing practice, and provision is made for better security for the depositors." From this act it becomes clear that between 1270 and 1318 the money-changers of Venice were becoming bankers, just as the same class of men became in Amsterdam a couple of centuries later, and as later still the goldsmiths in London.

Of the early banks in Europe, the bank in Venice, the Banco di Rialto, was established by the acts of the Venetian senate of 1584 and 1587. This appears to have been the first public bank in that city and in Europe. The senate by the act of the 3rd of May 1619¹ established by the side of the Banco di Rialto a second public bank known as the Banco Giro, or Banco del Giro, which ultimately became the only public bank of the city and was for generations famous throughout Europe as the Bank of Venice. Earlier than this the *campsores* or dealers in foreign moneys had carried on the business. The Bank of Venice (Banco del Giro) appears to have been called into existence by the natural developments of trade, but some banks have been established by governments and have been of great service to the development of the countries in which they have carried on their business. Of these, the Bank of Sweden (the *Riksbank*), established in 1656, is the earliest. This bank still exists and has always been the state bank of Sweden. It was founded by a Swede named Palmstruck, who also invented the use of the bank note—perhaps adapted for use in Europe is the better expression to employ, as notes were current in China about A.D. 800. The first bank note was issued by the *Riksbank* in 1658. An *enquête* made by the French government in 1729 recognizes the priority of Sweden in this matter, and declares the bank note to be an admirable Swedish invention, designed to facilitate commerce.

EUROPEAN COUNTRIES

United Kingdom.—English banking may be traced back to the dealings in money carried on by the goldsmiths of London and thus certainly to the 16th century; but it has been so greatly

influenced by the working of the Bank of England and by the acts of parliament connected with that institution, that a reference to this bank's foundation and development must precede any attempt at a detailed history of banking in the *Founda- tion of the Bank of England*. The Bank of England was founded in 1694.¹ As in the case of some of the earlier continental banks, a loan to the government was the origin of its establishment. The loan, which was £1,200,000, was subscribed in little more than ten days, between Thursday, 21st June, and noon of Monday, 2nd July 1694. On Tuesday, 10th July, the subscribers appointed Sir John Houbton the governor, and Michael Godfrey (who was killed during the siege of Namur on the 17th of July 1695) deputy-governor. Michael Godfrey wrote a pamphlet explaining the purposes for which the bank was established and the use it would be to the country. The pamphlet supplies some curious illustrations of the dangers which some persons had imagined might arise from the establishment of the bank and its connexion with William III., deprecating the fear "lest it should hereafter joynt with the prince to make him absolute and so render parliaments useless."

The governor and the deputy-governor, having thus been appointed, the first twenty-four directors were elected on Wednesday, 11th July 1694. Two of them were brothers of the governor, Sir John Houbton. They were descended from James Houbton, a Flemish refugee who had escaped from the persecution of Alva. All the directors were men of high mercantile standing. The business of the bank was first carried on in the Mercers' chapel. It continued there till the 28th of September, when they moved to Grocers' Hall. They were tenants of the Grocers' Hall till 1732. The first stone of the building now occupied by the bank was laid on the 1st of August 1732. The bank has remained on the same site ever since. The structure occupied the space previously covered by the house and gardens of Sir John Houbton, the first governor, which had been bought for the purpose. Between 1764 and 1788 the wings were erected. In 1780 the directors, alarmed at the dangerous facilities which the adjacent church of St Christopher le Stocks might give to a mob, obtained parliamentary powers and acquired the fabric, on the site of which much of the present building stands. The structure was developed to its present form about the commencement of the 19th century.

The bank commenced business with fifty-four assistants, the salaries of whom amounted to £4350. The total number employed in 1847 was upwards of nine hundred and their salaries exceeded £210,000. Mr Thomson Hankey stated that in 1867 upwards of one thousand persons were employed, and the salaries and wages amounted to nearly £260,000, besides pensions to superannuated clerks of about £20,000 more. The number of persons of all classes employed in 1906 (head office and eleven branches) was about 1400.

Originally established to advance the government a loan of £1,200,000, the management of the British national debt has been confided to the Bank of England from the date of its foundation, and it has remained the banker of the government ever since. The interest on the stock in which the debt is inscribed has always been paid by the bank, originally half-yearly, now quarterly, and the registration of all transfers of the stock itself is carried on by the bank, which assumes the responsibility of the correctness of these transfers. The dignity which the position of banker to the government gives; the monopoly granted to it of being the only joint-stock bank allowed to exist in England and Wales till 1826, while the liability of its shareholders was limited to the amount of their holdings, an advantage which alone of English banks it possessed till 1862; the privilege of issuing notes which since 1833 have been legal tender in England and Wales everywhere except at the bank itself; the fact that it is the banker of the other banks of the country and for many years had the control of far larger deposits than any one of them individually—all these privileges gave it early a pre-eminence which it still maintains, though more than one competitor now holds larger

¹ A translation of the act of the 3rd of May 1619 may be found in the appendix to the *Quarterly Journal of Economics* (Boston, U.S.A.) for April 1892. These documents present a distinct picture of banking in its true sense.

¹ The clearest account of its early days is found in Thorold Rogers' *History of the First Nine Years of the Bank of England*.

deposits, and though, collectively, the deposits of the other banks of the country which have offices in London many times overpass its own. Some idea of the strength of its position may be gained from the fact that stocks are now inscribed in the bank books to an amount exceeding 1250 millions sterling.

In one sense, the power of the Bank of England is greater now than ever. By the act of 1844, regulating the note-issue of the country, the Bank of England became the sole source from which legal tender notes can be obtained; a power important at all times, but pre-eminently so in times of pressure. The authority to supply the notes required, when the notes needed by the public exceed in amount the limit fixed by the act of 1844, was granted by the government at the request of the bank on three occasions only between 1844 and 1906. Hence the Bank of England becomes the centre of interest in times of pressure when a "treasury letter" permitting an excess issue is required, and holds then a power the force of which can hardly be estimated.

One main feature of the act of 1844 was the manner in which the issue of notes was dealt with, as described by Sir Robert Peel in parliament on the 6th of May 1844:—"Two departments of the bank will be constituted for the issue of notes, the one for the transaction of the ordinary business of banking. The bullion now in the possession of the bank will be transferred to the issue department. The issue of notes will be restricted to an issue of £14,000,000 upon securities—the remainder being issued upon bullion and governed in amount by the fluctuations in the stock of bullion." The bank was required to issue weekly returns in a specified form (previously to the act of 1844 it was necessary only to publish every month a balance-sheet for the previous quarter), and the first of such returns was issued on the 7th of September 1844. The old form of return contained merely a statement of the liabilities and assets of the bank, but in the new form the balance-sheets of the Issue Department and the Banking Department are shown separately. A copy of the weekly return in both the old and new forms will be found in *A History of the Bank of England*, p. 290, by A. Andréads (Eng. trans., 1909); see also R. H. I. Palgrave, *Bank Rate and the Money Market*, p. 297.

One result of the division of the accounts of the bank into two departments is that, if through any circumstance the Bank of England be called on for a larger sum in notes or specie than the smaller of its banking department technically possesses, as the "reserve" amount to be permitted has to be obtained from the government to "suspend the Bank Act" in order to allow the demand to be met, whatever the amount of specie in the "issue department" may be. Three times since the passing of the Bank Act—during the crises of 1847, 1857 and 1866—authority has been given for the suspension of that act. On one of these dates only, in 1857, the limits of the act were exceeded; on the other two occasions the fact that the permission had been given stayed the alarm. It should be remembered, whenever the act of 1844 is criticized, that since it came into force there has been no anxiety as to payment in specie of the note circulation; but the division of the specie held into two parts is an arrangement not *Bank rate*, without disadvantages. Certainly since the act of 1844 became law, the liability to constant fluctuations in the Bank's rate of discount—one main characteristic of the English money market—has greatly increased. To charge the responsibility of the increase in the number of those fluctuations on the Bank Act alone would not be justifiable, but the working of the act appears to have an influence in that direction, as the effect of the act is to cut the specie reserve held by the bank into two parts and to cause the smaller of these parts to receive the whole strain of any demands either for notes or for specie. Meanwhile the demands on the English money market are greater and more continuous than those on any other money market in the world. Of late years the changes in the bank rate have been frequent, and the fluctuations even in ordinary years very severe. From the day when the act came into operation in 1844, to the close of the year 1906, there had been more than 400 changes in the rate. The hopes which Sir Robert Peel expressed in 1844, that after the act came into force commercial crises would cease, have not been realized.

The number of changes in the bank rate from 1876¹ to 1906 in England, France, Germany, Holland and Belgium were as follows:—

England.	France.	Germany.	Holland.	Belgium.
183	27	110	55	77

There has been frequent discussion among bankers and occasionally with the government as to the advantage it might be to grant the Bank of England an automatic power to augment the note issue on securities when necessary, similar to that possessed by the Bank of Germany (*Reichsbank*). One of the hindrances to the success of such a plan has been that the government, acting on the advice

of the treasury, required an extremely high rate of interest, of which it would reap the advantage, to be paid on the advances made under these conditions. Those who made these suggestions did not bear in mind that the mere fact of so high a rate of interest being demanded intensifies the panic, a high rate being associated as a rule with risks in business. The object of the arrangement made between the *Reichsbank* and the treasury of the empire of Germany is a different one—to provide the banking accommodation required and to prevent panic, hence a rate of only 5% has been generally charged, though in 1899 the rate was 7% for a short time. As is often the case in business, a moderate rate has been accompanied by higher profit. The duty on the extra issue between 1881, when the circulation of the Bank of Germany first exceeded the authorized limit, and the close of the year 1906 amounted to £89,052. Thus a considerable sum was provided for the relief of taxation, while business proceeded on its normal course. The proposal made by Mr Lowe (afterwards Lord Sherbrooke) in 1873 was to charge 12% a rate which presupposes panic. Hence the negotiations came to nothing. The act of 1844 remains unaltered. The issue on securities allowed by it to the Bank of England was originally £14,000,000. This has since been increased under the provisions of the act to £18,450,000 (29th March 1901). Hence against the notes issued by the bank less gold by £4,450,000 is now held by the bank than would have been the case had the arrangements as to the securities remained as they were in 1844.

The Bank of England has, from the date of its establishment, possessed a practical, though perhaps not an absolutely legal, monopoly of issuing notes in London. It became gradually surrounded by a circle of private banks, some of considerable power.

The state papers included in F. G. Hilton Price's *Handbook of London Bankers* (1876) contain some of the earliest records about the establishment of banking in England. The first of these is a petition, printed in the original Italian, to Queen Elizabeth, of Christopher Hagenbuck and his partners in November 1581, representing "that he had found out a method and form in which it will be possible to institute an office into which shall enter every year a very large sum of money without expense to your Majesty," so "that not only your Majesty will be able to be always provided with whatever notable sum of money your Majesty may wish, but by this means your State and people also; and it shall keep the country in abundance and remove the extreme usuries that devour your Majesty and your people." Hagenbuck proposed to explain his plan on condition that he should receive "6% every year of the whole mass of money" received by the office for twenty years. The queen agreed "to grant to the said Christopher and partners 4% for a term of twenty years, and to confirm the said grant under the great seal." The document is signed by Francis Walsingham, but nothing further appears to have come of it. When we compare the date of this document with that of the establishment of the Banco della Piazza di Rialto at Venice, it is not unlikely that the idea of the establishment of a bank was floating in the minds of people connected with business and had become familiar to Hagenbuck from commerce with Venice. Other state papers in 1621 and 1622 and again in 1662 and 1666 contain somewhat similar proposals which however were never carried into practice.

The little *London Directory*, 1677, contains a list of goldsmiths mentioned as keeping "running cashes." Of these firms described in 1677, five houses were carrying on business in 1876. Three of these, or firms immediately descended from them, Child & Co. of Temple Bar, Martin & Co. of Lombard Street (as Martin's Bank, Ltd.), and Hoare & Co. of Fleet Street, are still carrying on business. Barnetts, Hoare & Co. and Willis, Percival & Co. have been absorbed since 1876, the first by Lloyds Bank (1884), the second by the Capital and Counties (1878). Many of the goldsmiths carried on a considerable business. Thus the books of Edward Blackwell, who was an eminent goldsmith and banker in the reign of Charles II., show that the king himself, the queen mother, Henrietta Maria, James, duke of York, the prince of Orange, Samuel Pepys, the East India Company, the Goldsmiths' Company and other city companies did business with him. Sir John Houbton, the first governor of the Bank of England, kept an account with Blackwell, who was, however, ruined by the closing of the exchequer in 1672. But his son married into the family of Sir Francis Child, and his grandsons became partners in Child's Bank.

Early
English
banking.

¹ The date 1876 is taken as being that when the Imperial Bank of Germany came into operation.

Besides the banks in London already mentioned, one in the provinces claims to have been established before the Bank of England. Smiths' of Nottingham, since amalgamated with the Union of London Bank, is stated to have been founded in 1688. Others also claim considerable antiquity. The old Bank of Bristol (Bailey, Cave & Co.) was founded in 1750; the business amalgamated with Prescott & Co., Ltd., of London. The Hull Old Bank (Pease & Co.) dated from 1754; this business also still continues (amalgamated, 1804, with the York Union Banking Co., Ltd., and since with Barclay & Co., Ltd.). The banks of Gurney & Co., established at the end of the 18th century in the eastern counties, have with numerous other banks of similar standing amalgamated with the firm of Barclay & Co., Ltd., of Lombard Street.

The business of banking had been carried on by the goldsmiths of the city, who took deposits from the time of James I. onwards, and thus established "deposit-banking" as early as that reign. This is described in a pamphlet published in 1676, entitled *The Mystery of the New-Fashioned Goldsmiths or Bankers Discovered*, quoted by Adam Anderson in his *History of the Great Commercial Interests of the British Empire*, vol. ii. p. 402. During the Civil War "the goldsmiths or new-fashioned bankers began to receive the rents of gentlemen's estates remitted to town, and to allow them and others who put cash into their hands some interest for it, if it remained but for a single month in their hands, or even a lesser time. This was a great allurements for people to put their money into their hands, which would bear interest till the day they wanted it. And they could also draw it out by £100 or £50, &c., at a time, as they wanted it, with infinitely less trouble than if they had lent it out on either real or personal security. The consequence was that it quickly brought a great quantity of cash into their hands; so that the chief or greatest of them were now enabled to supply Cromwell with money in advance on the revenues as his occasion required, upon great advantage to themselves."

The Bank of England, as stated before, was incorporated by the act of 1694. The position of the other banks at that time was defined by that act and the act of 1697, which declared that no bank, that is, no joint-stock bank, was "to be established within England during the continuance of the Bank of England," and also by the act of 1708, which provided that "during the continuance of the Bank of England, no company or partnership exceeding six persons in England" should "borrow, owe or take up any sum or sums of money on their bills or notes payable on demand or at any less time than six months from the borrowing thereof." This was confirmed by the act of 1800. No change of importance was made till the act of 1826, which prohibited "bank notes under £5," and the second Banking Act of that year which allowed the establishment of co-partnerships of more than six persons, which necessarily were joint-stock companies, beyond 65 m. from London. The act of 1833 allowed the establishment of joint-stock banks within the 65 m. limit, and took away various restrictions of the amounts of notes for less than £50. But the power of issuing notes was not allowed to joint-stock banks within the 65 m. radius.

In the early days in England, issuing notes formed, as Bagehot says in his *Lombard Street*, the introduction to the system of deposit-banking—so much so, that a bank which had not the power of issuing notes could scarcely exist out of London.

Bank notes in England originated in goldsmiths' notes. Goldsmiths received deposits of moneys and gave notes or receipts for such moneys payable on demand. The London bankers continued to give their customers notes or deposit-receipts for the sums left by them until about 1781, when in lieu of such notes they gave them books of cheques. Before the invention of cheque-books, the practice of issuing notes was considered so essentially the main feature of banking, that a prohibition of issue was considered an effectual bar against banking. Accordingly the prohibitory clause in the act of 6 Anne, c. 50, 1707 (in Record edition), which was repeated in the Bank of England Act 1708, 7 Anne, c. 30, § 66 (in Record edition), prohibiting more than six

persons from issuing promissory notes, was intended to prevent any bank being formed with more than six partners, and was so understood at the time; and it did have the effect of preventing any joint-stock bank being formed.

The prohibition, as already related, was modified in the year 1826 and removed in 1833. Even then the privilege of limitation of liability was not permitted to any other bank but the Bank of England. The result was that when joint-stock banks were first formed many persons of good means were kept back from becoming shareholders, that is to say partners, in banks. For up to the date of the act of 1862 permitting "limited liability," every shareholder in a joint-stock bank was liable to the extent of the whole of his means (see the article COMPANY). Even as late as 1858 when the Western Bank of Scotland and 1878 when the City of Glasgow Bank failed, very great hardship was inflicted on many persons who had trusted with over confidence to the management of those banks. The failure of the City of Glasgow Bank was the cause of the Companies Act of 1879, passed to enable unlimited companies to adopt limited liability. In limited companies the shareholder who has paid up the nominal amount of his holding is not liable for any further amount, unless the company issues bank notes, in which case the shareholders are liable in the same way as if the company were registered as an unlimited company. The facilities allowed by this act were used by almost every joint-stock bank in the United Kingdom except those banks which were at that date limited by charter or by special act.

To return to the early history of banking—thus, as no bank could be formed with more than six partners during the whole of the period from 1694 to 1826 and 1833, the majority of the banks formed throughout England and Wales for more than a century were necessarily small and usually isolated firms. Further, when a partner died, his capital not infrequently went out of the business; then a fresh partner with sufficient means had to be found, constant change was the result, and confidence, "a plant of slow growth," could not thrive, except in those instances when a son or a relation filled the vacancy.

The banks in the country districts had frequently branches in the small market-towns close to them; those in London had never more than one office. These banks were sometimes powerful and generally well managed, a considerable number being established by members of the Society of Friends.

The restriction of partners in private banks to the number of six continued till 1862. By the act of that year they were allowed to be ten. This power, however, did not extend to issuing private banks, which were restricted to six partners as before. The power of increasing bank partnerships to ten has been made but little use of. The difficulties of carrying on business on a large scale by private firms were augmented by certain legal technicalities which practically rendered large private banks impossible in ordinary circumstances. Hence banking business did not begin to assume its present form till almost half-way through the 19th century. The gradual change followed the passing of the acts of 1826-1833, of 1844-1845, of 1862 and of 1879. Incidentally the act of 1844 had an unexpected influence on the constitution of the banking system. After favouring the existence of small banks for many years, it gradually led, as the time arrived when the establishment of large and powerful banks in England and Wales became necessary, to their formation. No new bank of issue whatever was allowed to be established—restrictions were placed on the English issuing banks—private issuing banks with not more than six partners were allowed to remain, to amalgamate with other private issuing banks and to retain their joint issues. The joint-stock banks which possessed issues were also allowed to continue these, but when two joint-stock banks amalgamated, the continuing bank only retained its issue. Also when a private issuing bank was formed into or joined a joint-stock bank, the issue lapsed.

The greater number of the provincial banks in England and Wales had been banks of issue up to 1844. The act of 1844

Private
banks.

restricted their power of issuing notes, which at that date and even subsequently continued to be of importance to them, in such a manner that, as Sir R. H. Inglis Palgrave stated in giving evidence before the committee of the House of Commons at the banking inquiry of 1875, these banks possessed in their issues a property they could use, but were not able to sell. The statistics forming part of Appendix 14 to the report of the select committee of the House of Commons on banks of issue (1875) give interesting information as to the proportion of notes in circulation to the deposits of banks in various districts of the country and at various dates. The statements were supplied by twenty-one banks, some in agricultural districts, some in places where manufactures flourished, some in mixed districts, commercial and agricultural, or industrial and manufacturing. In all of these, the inquiry being carried as far back as 1844, the proportion of the circulation to the banking deposits had greatly diminished in recent years. In several cases the deposits had increased three-fold in the time. In one case it was five times as large, in another nearly seven times, in another nearly twelve and a half times. The proportion of the circulation to the deposits had very largely diminished in that time. In one instance, from being about one-third of the deposits, at which proportion it had remained for five years consecutively, it fell to 9% at the end of the term. In another from being 22% it had diminished to 1½% of the total. In all cases where the detail was given it had diminished greatly.

The Bank Act of 1844 was arranged with the intention of concentrating the note issues on the Bank of England in order to secure the monopoly of that bank as the one issuer in England and Wales. The result was that nearly all the provincial banks in England had by 1906 lost the right of issue. Doubtless all were destined to do so before long, a result by which banking in England and the industries of the country must lose the advantage which the local issues have been to Scotland and Ireland. Had the English country banks been allowed, as the Scottish banks were, to associate together and to retain their issues, powerful banks would many years since have been established throughout England and Wales, and the amalgamations of recent years would have been carried through at a much earlier date, and on terms much more favourable to the public.

No security was ever required to be given for the local issues in the United Kingdom. The provisions of the acts of 1844-1845 which compel the Irish and Scottish banks to hold specie against the notes issued beyond the legal limit, do not make the coin held a security for them. The legislation of 1879 which made the note issues a first charge, with unlimited liability, on the total assets of the joint-stock banks which accepted the principle of limited liability for the rest of their business; has been the only recognition by the state of the duty to the note-holders of rendering them secure. It has been a real disadvantage to England that this duty has never been sufficiently recognized, and that the provincial note issue, which is a very convenient power for a bank to possess, and incidentally a considerable advantage to its customers, has been swept away without any attempt being made to remedy its deficiencies. There may be objections raised to a note circulation secured by the bonds of the government, but the security of the note issues of the national banks of the United States made against such bonds, has scarcely ever been questioned.

A different policy was followed by Sir Robert Peel in Scotland and in Ireland from that which he established in England. By the acts of 1844-1845 the Scottish and Irish banks were allowed to exceed their authorized issues on holding specie to the amount of the excess, and no restrictions were placed on amalgamations among banks in these countries. In Scotland and in Ireland notes for less than £5 continued to be allowed. The result has been that the ten large banks in Scotland, and six of the nine banks in Ireland, possess the power of issuing notes. The large proportion of local branches in these countries has been greatly assisted by this power.

Originally, besides the Bank of England, nearly all the provincial banks in England and Wales possessed the privilege of issue. These banks continued their operations as previously during the time while the Bank Act was discussed in parliament. When the arrangements which that act created were made public, nine banks, of which eight were private and one was a joint-stock bank, ceased to issue their notes prior to the 12th of October 1844, when the act came into operation. Of these, the Western District Joint-Stock Banking Co. was dissolved, one of the private banks was closed, the remaining seven issued Bank of England notes and were allowed certain privileges for doing this. By the act of 1844 the maximum circulation of the English issuing banks was fixed at the average circulation of the twelve weeks before the 27th of April 1844.

The number of the banks to which the privilege of circulation was then allowed and the amount of notes permitted were, in England:—

207 private banks with an authorized issue of	£5,153,417
72 joint-stock banks with an authorized issue of	3,478,230
	<u>£8,631,647</u>

The actual circulation of the country in October 1844 was as follows:—

Notes in Circulation.—The monthly return of the circulation ending the 12th of October 1844 (stamps and taxes, 25th October):

England.	
Bank of England	£20,228,800
Private banks	4,674,162
Joint-stock banks	3,331,516
<i>Scotland.</i>	
Chartered, private and joint-stock banks	2,987,665
<i>Ireland.</i>	
Bank of Ireland	3,597,850
Private and joint-stock banks	2,456,261
Total	<u>£37,276,254</u>

In May 1907 the number and amounts were reduced to:—

	Authorized Issue.	Actual Issue.
12 Private banks	£482,744	£122,536
17 Joint-stock banks	1,084,836	437,693

The reason why the actual circulation of these banks is so far below the authorized issue is that under existing circumstances their circulation can only extend over a very limited area. The notes of country banks are now almost unknown except in the immediate neighbourhood of the places where they are issued; though they may all be payable in London, yet there is often considerable difficulty in getting them cashed.

The average circulation in 1906 was as follows:—

Bank of England	£28,890,000
Private banks	124,000
Joint-stock banks	429,000
Total in England	<u>29,443,000</u>
Scotland	7,477,000
Ireland	6,452,000
Total in United Kingdom	<u>£43,372,000</u>

This shows an apparent increase of more than £6,000,000 since 1844. The decrease of the country circulation in England and the increase or the Scottish and Irish circulations may be set off against each other. The increase is mainly in the notes of the Bank of England. In 1844 the number of banking offices in England and Wales was 976, while in 1906 there were more than 5800. Each of these offices must hold some till-money, and of this Bank of England notes almost always form a part. Hence it is probable that a large part of the increase in the circulation of the Bank of England since 1844 is held in the tills of the banks in England and Wales, and that the active note circulation of the United Kingdom is but little larger than it was.

It may be added that the government received from the note circulation for a typical year (ending 5th of April 1904), out of the profits of issue (Bank of England) £184,930, 2s. 2d., and also composition for the duties on the bills and notes of the banks of England and Ireland and of country bankers, £120,768, 18s. 6d.

In 1906 the banking business of England was carried on practically by about ten private and sixty joint-stock banks of which more than one was properly a private firm under a joint-stock form of organization. Though the number of individual banks had diminished, the offices had greatly increased.

The records of the numbers of banks in the United Kingdom have up to quite recent years been very imperfect. Such as exist were made by individual observers. The banks of England and Wales are believed to have been 350 in number in 1792. Those registered from 1826 to 1842 were:—

	Private.	Joint-stock.
1826	554	6
1827	465	35
1833	416	118
1842	311	

The number of banking offices in England and Wales was estimated by Mr. William Leatham in 1840 as being 697. The *Banking Almanac* for 1845 gives the number in 1844 for England and Wales as 336 private bank offices and 640 joint-stock offices, Scotland 366 offices, Ireland 180 offices.

The number of inhabitants to each office was as follows in 1844 and 1906:—

	Number of Banking Offices.		Number of Inhabitants to each Office.	
	1844.	1906.	1844.	1906.
England and Wales	976	5527	16,305	5885
Isle of Man	23	..	2417
Scotland	368	1180	7,120	3790
Ireland	180	777	45,417	5738
In United Kingdom . .	1524	7507	17,526	5539

In the latter years of the 18th century and the early years of the 19th, the note circulation was a very important part of the business, but about that date the deposits began to be, as they have continued since, far more important. It is unfortunately impossible to give any trustworthy statistics of the position of banking in the United Kingdom extending back for more than forty or fifty years. Even the Scottish banks, who have been less reticent as to their position than the English banks, did not publish their accounts generally till 1865. The figures of the total deposits and cash balances in the Irish joint-stock banks were published collectively from the year 1830 by the care of Dr Neilson Hancock, but it is only of quite recent years that any statement of the general position other than an estimate has been possible owing to the long-continued reluctance of many banks to allow any publication of their balance-sheets. A paper by W. Newmarch, printed in the *Journal of the Statistical Society* for 1851, supplies the earliest basis for a trustworthy estimate. According to this the total amount of deposits, including the Bank of England, in England and Wales, Scotland and Ireland, may have been at that date from £250,000,000 to £350,000,000. The estimate in *Parsons's Notes on Banking* (1872), excluding deposits in discount houses and the capitals of banks, was from £430,000,000 to £450,000,000. The corresponding amounts at the close of 1906 were, in round figures, including acceptances &c., £997,000,000. The total resources, including capitals and reserves and note circulation (in round figures £177,500,000), were for 1906:—

England and Wales—

Bank of England and other banks.	£922,297,000
Scotland	135,042,000
Ireland	73,707,000
Isle of Man	898,000

£1,131,944,000

The progressive growth in bank deposits since it has been possible to keep a record of their amounts, affords some means of checking roughly the correctness of the estimates of 1851 and 1872. Broadly speaking, it may be said that the bank deposits of the United Kingdom have about doubled since 1872.

The purely city banks had associated themselves in a "Clearing House" certainly by 1776. An entry in the books of the Grass-hopper, namely—"1773 to quarterly charge for use of the Clearing-room of 19/6d.," points to an earlier and perhaps less definitely organized system of settlement. A house was taken for the purpose in 1810, in which year the number of banking houses who settled their accounts with each other at the "Clearing House" was forty-six (Gilbert's *History and Principles of Banking*, p. 78). The Bank of England has never been a member of the Clearing House, though it "clears on one side," i.e. its claim on the clearing bankers is made through the Clearing House, but the claims of the clearing bankers on the bank are forwarded direct to Threadneedle Street twice or thrice daily. Nor did the banks in Fleet Street or at Charing Cross belong to it. In 1858 the clearing of country cheques was added through arrangements made by Lord Avebury, then Sir John Lubbock. The "country clearing" is a great assistance to business, as it enables a cheque drawn on the most distant village in England to be dealt with as conveniently as a cheque on London. Of the forty-nine banks in London in

1844, twenty-six were connected with the Clearing House. At that time only private banks were allowed to be members. In 1854 the joint-stock banks made their way into that body, and in 1906 the numbers were one private bank and eighteen joint-stock banks who joined in the clearing—nineteen banks in all.

Practically at the present time every large transaction in the United Kingdom is settled by cheque, that is, by a series of ledger transfers, notes and specie being but the small change by which the fractional amounts are paid. A large proportion of these transactions are arranged through the operation of the London Clearing House. This is facilitated by the fact that every bank in the United Kingdom has an agent in London.

The annual circulation shown by the London Clearing House is more than £12,000,000,000. No one asks what stock of gold is held by the bank on which the cheques are drawn, or what the bank itself keeps in reserve. The whole is taken in faith on a well-founded trust. It is the most easily worked paper circulation and circulating medium in existence. Like the marvellous tent of the fairy Paribanou, it expands itself to meet every want and contracts again the moment the strain is passed. (See the article by R. H. Inglis Palgrave on "Gold and the Banks," *Quarterly Review*, January 1906.)

If we add to the returns of the London Clearing House those of the clearing houses in the large towns of England, Ireland and Scotland, and the numerous exchanges which occur daily, and the large number which the different offices of banks with a great many branches settle among themselves, and the number drawn by one customer of a bank and paid to another, we may form some notion of the vast amount of the yearly turnover in cheques. This may be roughly estimated to be at least twice as great as that registered by the London Clearing House. The earliest authentic statement as to the clearing is found in the *Appendix to the Second Report, Committee of House of Commons, Banks of Issue* (1841).

In 1839 the figures of the London clearings

were	£954,401,600, 29 banks.
In 1840	978,496,800, 29 "
In 1899	9,150,269,000, 19 "
In 1900	8,960,170,000, 19 "
In 1906	12,711,334,000, 18 "

In 1805, shortly after the establishment of the Bank of England, the Scottish parliament passed an act for the establishment of a public bank. Amongst the first names is that of Thomas Coutts, a name still commemorated in one of the most substantial banks in London. The terms of the establishment were more favourable than those connected with the establishment of the Bank of England, for they obtained the exclusive privilege of banking for twenty-one years without giving any consideration whatever. It may have been the natural caution of the country, or the fact that William III. was then king, which led to the Bank of Scotland being prohibited under a heavy penalty from lending money under any circumstances to the king. It is the only Scottish bank established by act of parliament. The directors began at a very early period to receive deposits and to allow interest thereon, also to grant cash credit accounts, a minute of the directors respecting the mode of keeping the latter being dated so far back as 1729.

Though the system of branches forms now so marked a feature of banking in Scotland, a good many years had to pass before they obtained any hold. It was not till about the year 1700 that the directors of the Bank of Scotland established branches at Glasgow, Aberdeen, Dundee and Montrose, but so little encouragement was given to these branches, the expenses far exceeding the profits arising from them, that the directors resolved to close them. In 1731 another attempt was made, and agencies were established at Glasgow, Aberdeen and Dundee. But after a trial of two years they were discontinued. It was not till 1774 that branches were again established by the bank.

Soon after the establishment of the Bank of Scotland the directors began to issue notes, or, as they were then called, bills or tickets, for £100, £50, £20, £10, and £5. In 1704 £1 notes were issued for the first time. In 1727 the Royal Bank of Scotland was established by a charter of incorporation, which granted them "perpetual succession and a common seal." There was a great rivalry between the two companies. The British Linen Company was incorporated in 1746 for the

purpose of undertaking the manufacture of linen, but by 1763 they found it best to confine their operations to banking transactions. This bank also was incorporated by charter.

The note circulation was always an important item in the Scottish banks. Thus in the case of the Bank of Dundee, the receiving money from the public did not commence till 1792. Up to that time the whole business of the bank from 1764 onwards, twenty-eight years in all, had consisted in its issue of notes, which had varied from about £23,000 to £56,000. The Bank of Dundee was amalgamated with the Royal Bank of Scotland in 1864, when its deposits amounted in round figures to £700,000 and its note circulation to £41,000. After 1792, the money deposited with the banks in Scotland rapidly increased, but the habit of hoarding savings in a chest up to amounts of £10 or £20 continued to a much later period (*History of the Dundee Banking Co.*).

Private banking never appears to have had any considerable hold in Scotland. In 1819 eight private banks were in existence. These had all disappeared by 1844. In 1906 there were only ten banks of issue in Scotland, which practically carried on the whole business of the country. There were two other small banks established comparatively recently. These ten banks had, in 1906, 1180 branches.

The history of the growth and expansion of Scottish banking since 1826 is, as far as can be traced, as follows:—

Date.	Deposits.	Number of Offices.
1826	£21,000,000	167 = 1 to every 13,170 inhabitants.
1841	27,000,000	380 = 1 " 6,600 "
1856	{ 63,000,000 and capital 92,000,000	{ 585 = 1 " 5,230 "
1872	{ including all liabilities and capital 135,042,000	{ 790 = 1 " 4,250 "
1906	{ including all liabilities and capital	{ 1,180 = 1 " 3,790 "

Against every note issued in excess of the limit allowed by the acts of 1844-1845, gold has to be held at the offices of the issuing banks in Scotland and Ireland. The amount of the specie to be thus held was, as explained by Sir Robert Peel in his speech of the 25th of April 1845, to be ascertained by the average amount of the note-issue for four weeks preceding. The object of the holding of this amount of specie by the bank which issued the notes was designed by Sir Robert Peel to cause the circulating medium of the country, being partly of notes and partly of specie, to fluctuate in the same manner as if it had been a metallic circulation only. The specie held in Scotland and Ireland against the note-issue is not a special security for the note circulation, but is placed in the banks there for this purpose. The influence ascribed to the working of the note circulation in the earlier part of the 19th century accounts for this legislation, which, as Sir Robert Peel stated in his speech of the 6th of May 1844, was intended to "ensure the uniform equivalency of bank notes to coin." It is not applicable to the present position of the circulating medium of the United Kingdom, which now consists mainly of a circulation of cheques. This differs absolutely from what was contemplated by Sir Robert Peel; no attempt is or can be made to cause such a paper circulation to fluctuate as if it were one of specie only. One result of the limitation of the power of note-issue to the banks in Scotland which possessed that power in 1845 has been that no important bank has been established in that country since. Notes are so largely employed in ordinary business in Scotland that a bank which does not possess the power, practically cannot carry on business and supply the needs of its customers. This limitation in the number of the banks has, however, not been accompanied by any deficiency in the supply of banking accommodation to the people. There is a larger number of banking offices in proportion to the population in Scotland than in England and Wales or Ireland.

The large number of branches must, however, be a cause of great expense, and in several other respects it is obvious that a business carried on in such thinly peopled districts as are found in many parts of Scotland, must be conducted at a disadvantage in comparison with those banks which deal with more active centres of commerce. Although the profit derived from their large issue of notes may be thought to be considerable, yet, when we consider the many expenses incurred in conducting a large note circulation, the cost of printing, stamp duty, and the charges on importing gold from London when the circulation exceeds the limit fixed by the act of 1845, no small

deductions must be made from the apparent profit to be derived from this head, if there is any direct profit at all.

On the other hand, the great number of branches possessed by the Scottish banks tends beyond doubt to their stability and prosperity. The network of banks on the surface of Scotland is as important to the development of the prosperity of the country as the network of the railways. It has caused a great economy of capital, as the universal practice of people, even of the most moderate means, is to lodge their money with the banks.

The early history of banking in Ireland was marked by legislation even less favourable to the formation of a steady and dependable system than in England, and in 1695 several of the principal merchants in Dublin met together for the purpose of forming a public bank for Ireland on the model of the Bank of England. For many years this proposal met with no favour. It was not till 1783 that the Bank of Ireland was established and commenced its business. The first governor was David La Touche, junior, and two other members of his family were amongst the first board of directors. The bank met with very great success, but the jealousy against rival establishments was extreme. By the act forming the Bank of Ireland it was enacted that no company or society exceeding six in number, except the Bank of Ireland, should borrow or take up money on their bills or notes payable on demand. In the year 1821 the act was so far modified as to permit the establishment of banking companies exceeding six in number at a distance of 50 m. from Dublin. In 1824, in consequence of the ambiguity of that act, an act had to be passed to explain it. It was not till 1845 that the restriction as to the 50-m. limit was withdrawn.

The establishment of any other bank but the Bank of Ireland was for a long time hindered by the legislation on the subject. Some of the restrictions were so extraordinary that it will be interesting to refer to three of the more important acts.

1741, 15 Geo. II.—Partnerships authorized for the purpose of trade and manufacture; but such partnerships were not to exceed nine in number, nor was the capital stock of such co-partnership to exceed, at any time, the sum of £10,000.

1780-1781, 21 and 22 Geo. III.—"Anonymous Partnership Act."—limited liability not to exceed £50,000, but "business of banking or discounters of money" expressly excluded.

1759, 33 Geo. II.—By this act a person while he continued a banker could not make a marriage settlement on a son or daughter, a grandson or granddaughter, so as to be good against his creditors, though for a valuable consideration, and though such creditors were not creditors at the time the grant was made. This act gave power to creditors over all conveyances by bankers affecting real estates; and all dispositions after the 10th of May 1760 by bankers of real or leasehold interest therein to or for children were made void as against creditors, though for valuable consideration and though not creditors at the time. No banker to issue notes or receipts bearing interest after the 10th of May 1760. Some of these enactments appear to be in force at the present day; suggestions have been made, though apparently unsuccessfully, for their repeal.

So extraordinary were the views of the common people that a banker in Dublin of the name of Beresford having made himself very unpopular, a "large assemblage of ignorant country people having previously collected a quantity of Beresford's notes, publicly burnt them, crying out with enthusiasm while the promises to pay on demand were consuming, 'What will he do now; his bank will surely break.'"

The number of banks which failed in Ireland in earlier times was extraordinary; thus Sir Robert Peel in his speech of the 9th of June 1845 on the Bank Act of that year, made a quotation "from the report of the committee of Irish exchanges, which sat in 1804. At that period there were fifty registered banks, but they all failed, and their failures, I know personally, led to the most fearful distress." Since the legislation of 1845, however, the business has been carried on with equally extraordinary steadiness and success, and at the present time is on a footing fully equal to that of any other part of the United Kingdom.

The earlier history of banking in Ireland pursued very closely the same process of development as in England. Circulation preceded and fed deposits. The credit which the banks obtained

Irish
banks.

by the ready acceptance of their notes brought customers to their counters, and thus the existing system, fortunate in excellent managers, was built up gradually and surely.

Alone in the three kingdoms, Ireland maintains the same limit of authorized circulation as that established by Peel's Act of 1845. Not one of the six banks which had the privilege of issue at that period has lost it since.

The names of the banks carrying on business in Ireland, the years when they were established and their position in 1906, are as follows:—

CAPITAL OF IRISH JOINT-STOCK BANKS IN 1906

Name of Bank and Year when established.	Capital paid-up.	Rate of Dividend per annum.
Bank of Ireland . . . 1783 . . .	£2,769,230	11
Hibernian Bank* . . . 1824 . . .	500,000	10
Provincial Bank . . . 1825 . . .	540,000	20
Northern Banking Co. 1825 . . .	500,000	18½
Belfast Banking Co. . . 1827 . . .	500,000	36
National Bank . . . 1835 . . .	1,500,000	8
Urban Banking Co. . . 1836 . . .	500,000	18
Royal Bank* . . . 1836 . . .	300,000	12
Munster Bank, Ltd.* 1864 . . .	200,000	8

* Thus marked are not banks of issue.

Banking, like every other business, has to pass through periods of difficulty. The severity of these in the case of banking is intensified by the vast number of interests affected.

Banking crises. These, on the one hand, are world-wide in their scope, on the other they touch every home in the country. The stringency of such a time in England has since the passing of the act of 1844 been greatly enhanced by a doubt being sometimes felt as to whether a relaxation of the act of 1844 would be allowed. In any case, some little time must elapse before the assent of the ministers of the crown to the request of the Bank of England can be known. Since 1844 there have been five periods of pressure,—during 1847, 1857, 1866, 1870 and 1890. Of these in three, 1847, 1857 and 1866, the difficulties reached panic.

The crisis of 1847 was brought on by the speculation in railway enterprise which had gone on since 1845. So little had the anxieties of the autumn been anticipated that the bank rate of discount was 3% on the 1st of January. It was raised to 3½% on the 14th and to 4% on the 21st. It became 5% on 8th April, 5½% on 5th August, 6% on 30th September and 8% on 25th October. This was the highest. It was lowered to 7% on 22nd November, on 2nd December to 6% and on 23rd December to 5%. An announcement was made on the 1st of October that no advances would be made on public securities. This was followed by general anxiety and alarm.

The reserve of the bank was rapidly reduced to a very low ebb.

Bank of England Reserve of Specie.

1847, 16th October	£3,070,000
" 23rd October	1,990,000
" 30th October	1,600,000

Meanwhile the anxiety and alarm prevailing were causing a general hoarding of coin and bank notes, and it really appeared not unlikely that the banking department of the Bank of England might be compelled to stop payment while there was more than £6,000,000 of specie in the issue department. The chancellor of the exchequer (Sir C. Wood, afterwards Lord Halifax) was urged by many deputations and remonstrances to relax the Bank Act, but he declined. At last, on the 22nd or 23rd of October, some of the leading city bankers had an interview with the prime minister (Lord John, afterwards Earl, Russell), and on their explaining the necessities of the position, the desired relaxation was given. The official letter (25th October) recommended "the directors of the Bank of England, in the present emergency, to enlarge the amount of their discounts and advances upon approved security." A high rate, 8%, was to be charged to keep these operations within reasonable limits; a bill of indemnity was promised if the arrangement led to a breach of the law. The extra profit derived was to be for the benefit of the

public. The effect of the government letter in allaying the panic was complete.

The crisis of 1857 was the last occasion of an official inquiry. This is contained in the *Report and Evidence of the Select Committee of the House of Commons on the Bank Acts (1857, 1858)*. The evidence given by Mr Sheffield Neave, the governor, and Mr Bonamy Dobree, deputy-governor of the bank in 1858, gives a vivid picture not only of what occurred, but of what might be expected to recur on such occasions. The wildest alarm prevailed, exchequer bills were scarcely saleable, and the bank itself sold £3,000,000 government securities at a considerable loss.

The extreme pressure was relaxed by the letter issued by the government on the 12th of November 1857, signed by Lord Palmerston, then premier, and Sir G. C. Lewis, which allowed a temporary relaxation of the Bank Act of 1844. The public alarm, however, was so great that it was not until the 21st of November that the severity of the pressure was in any way diminished. On the 20th of November the notes issued to the public on securities beyond the statutory limit (then £14,475,000) reached the sum of £928,000. By the next week the issue was almost down to the limit, and in the week following it was within the limit. On the 1st of January 1858 the bank rate was lowered to 8% and the anxiety gradually passed away. Had the treasury letter been issued earlier, the pressure might not have been so severe, and the governor of the bank expressed a strong opinion that, if it had been later, it would not have been sufficient. November 1857 was the only occasion when the limits of the Bank Act as to issue were actually passed.

During the crisis of May 1866 £4,000,000 left the bank on one day in notes and coin, and the reserve of the bank was reduced in the return of the 1st of June of that year to £415,000. The bank rate was raised to 10% and permission was given by the government to suspend the act. This, however, was not done. Tradition says that the bank asked the bankers, during the period of heaviest pressure of that terrible crisis—pressure more severe than anything that had taken place before or that has occurred since, to pay in every night the notes they had drawn out in the morning which were still in their tills at the close of the day, and that hence the legal limit was never exceeded. But it was not till the 6th of August that the rate was reduced to 8%.

The effect of the crisis of October 1890 was far less severe. This was due to the judgment and skill displayed by the governor (Mr Lidderdale) and the directors of the bank, who imported £3,000,000 in gold from Paris. The reserve in that year never dropped below £10,000,000, and before the end of November the anxiety had greatly passed away. "Caution prevailed, but not panic, and the distinction is a very clear one." (See arts. on "Crises," *Dictionary of Political Economy*, vol. i.)

The most important requirement of banking in the United Kingdom is still the establishment of an efficient specie reserve. The reserve in the banking department of the Bank of England averaged:—

£8,500,000 in 1845.	£11,600,000 in 1885.
8,400,000 in 1855.	15,100,000 in 1875.
8,000,000 in 1865.	29,900,000 in 1895.
	£23,500,000 in 1906.

This provides but a narrow basis for the whole business requirements of the country. Though much larger than in several previous years, it cannot be regarded as adequate. The figures fluctuate more severely than these decennial averages show, and the progress has not been one of uniform increase. Thus the £15,100,000 in 1885 was followed by £12,700,000 in 1888. The £29,900,000 of 1895 was followed by £34,600,000 in 1896 and £21,200,000 in 1899.

Beyond, or side by side with, the reserve of the Bank of England there are the reserves held by the other banks. Part of these are held in the form of balances at the Bank of England, part in specie and bank notes in their own tills. The latter, hence, are not unlikely to be estimated twice over. The published figures on this point are meagre.

The expectations expressed by Sir Robert Peel in his speech

The "Reserve" question.

on the bank charter and the currency of the 6th of May 1844 have not yet been fulfilled. "I rejoice," he said, "on public grounds, in the hope that the wisdom of parliament will at length devise measures which shall inspire just confidence in the medium of exchange, shall put a check on improvident speculations, and shall ensure the just reward of industry and the legitimate profit of commercial enterprise conducted with integrity and controlled by provident calculation."

The extreme measures which have been required since the act of 1844 point out for themselves the necessity for reform. Three times since the date of the Bank Act of 1844 it has been needful to give permission for the suspension of that act which forms the very foundation of the monetary system of Great Britain. This, whenever it has occurred, has exercised a very injurious effect on credit abroad, as well as on prosperity at home.

The British money-market, the clearing-house of the world, is, in consequence of the smallness of its reserve, exposed to greater fluctuations than that of any other country. These fluctuations may arise from the need of meeting the requirements of other countries for specie or those arising from domestic trade. The recorded excess of imports over exports, £147,000,000 in 1906, though the difference is eventually balanced by the "invisible" exports, gives foreign nations at times a power over the British money-market greater than has ever previously been the case. The current must always have a tendency to flow outwards; this is enhanced by the great increase in the number of foreign banks which have branches in England. The need of providing sufficient reserves to meet requirements thus occasioned is obvious.

As regards the banks in which British interests are concerned in British colonies and other countries we can only speak briefly. It must not be overlooked that in the Dominion of Canada there are 29 banks, many of them large, managed much on the Scottish principle with capitals of nearly £19,000,000 and deposits of about £140,000,000. These banks have more than 1200 offices. In Australia and New Zealand there are 24 banks with capitals of nearly £18,000,000 and deposits of about £130,000,000. The number of offices is nearly 1700. There are, including the three Presidency banks, about 15 banks doing business mainly in India—in some cases connecting neighbouring countries and places like Bangkok, Hong-Kong and Canton. These banks have capitals of more than £5,000,000 and deposits of fully £36,000,000 and over 210 offices. There are at least 8 banks in South and West Africa with capitals of nearly £5,000,000, deposits of nearly £50,000,000 and nearly 370 offices. There are 5 banks, including the Colonial Bank, in other British territories with capitals of about £1,000,000 and deposits of £3,300,000, and about 25 offices. There are thus, besides many private firms doing very considerable business, more than 80 joint-stock British banks working in the colonies with capitals amounting to £48,000,000, deposits £360,000,000 and offices 3505. Outside British territories there are 6 banks, principally in South America, with nearly £4,000,000 capital, £36,000,000 deposits and about 60 offices. There are 6 large banks doing business principally in the East with more than £6,700,000 capitals, £77,000,000 deposits and 7 offices; and 7 other banks, including savings banks, with about £4,300,000 capitals and £220,000,000 deposits. There are thus about 20 British banks doing business in foreign countries with capitals amounting to £15,200,000, deposits £135,000,000 and offices 173.

In this statement we have included only the more important banks, which collectively wield about £63,000,000 capital and more than £495,000,000 deposits—in all about £560,000,000 of resources operating at about 3700 offices situated in places as different from each other and as widely separated as California and Hong-Kong, Constantinople and New Zealand.

France.—In France the first bank of issue, originally called the *Banque Générale*, was established in 1716 by John Law, the author of the *Mississippi Scheme* and the *Système*. Law's bank, which had been converted into the *Banque Royale* in 1718, and its notes guaranteed by the king (Louis XV.), came to an end in 1721; an attempt at reconstruction was made in 1767, but the bank thus established was suppressed in 1793. Other banks, some issuing notes, then carried on operations with limited success, but these never attained any real power. There were many negotiations on the subject of the establishment of a bank in 1796. The financial difficulties of the times prevented any immediate result, but the advice of those engaged in this plan was of great assistance to Napoleon I., who, aided by his minister Mollien, founded in 1800 the Bank of France, which has remained

from that time to the present by far the most powerful financial institution in the country. The objects for which it was established were to support the trade and industry of France and to supply the use of loanable capital at a moderate charge. These functions it has exercised ever since with great vigour and great judgment, extending itself through its branches and towns attached to branches over the whole country. At its establishment and for some time subsequently the operations of the bank did not extend over the whole of France. Departmental banks with the privilege of issue had been formed under a law adopted in 1803. At the close of 1847 there were nine of these banks existing in as many of the larger towns. In 1848, however, they were absorbed into the Bank of France, which has since possessed an exclusive privilege of issue, and in 1863 took over the Bank of Savoy after that province was united to France.

The Bank of France has successfully surmounted many political as well as financial troubles both during and since the times of Napoleon I. The overthrow of the government of Louis Philippe in 1848, the war with Germany in 1870, the many difficulties that followed when the Commune reigned in Paris in 1871, the payment of the war indemnity—not completed till 1873—were all happily overcome. Great pains, too, have been taken, especially of recent years, to render services to large and small businesses and to agricultural industry. In 1877 the offices of the Bank of France were 78 in number; in 1906 they were 447, including the towns "connected with the branches"—an arrangement which, without putting the bank to the expense of opening a branch, gives the place connected many of the advantages which a branch confers. The quantity of commercial paper discounted is very large. More than 20,000,000 bills were discounted in 1906, the total amount being £559,234,996. The advances on securities were in the same year £106,280,124. The rate of discount in Paris is as a rule lower and the number of alterations fewer than in London. From May 1900 to January 1906 there was no change, the rate remaining uniformly at 3%. Bills as low as 4s. 2d. are admitted to discount, including those below 8s.; about 232,000 of this class were discounted in 1906. Since the 27th of March 1890 loans of as small an amount as £10 are granted. In most cases three "names" must be furnished for each bill, or suitable guarantees or security given, but these necessary safeguards have not to be furnished in such a manner as to hamper applicants for loans unduly. In this manner the Bank of France is of great service to the industry of the country. It has never succeeded, however, in attracting deposits on anything like the scale of the Bank of England or the banks of the English-speaking peoples, but it held, as stated in the balance-sheet for the 23rd of December 1906, about £35,000,000 in deposits, of which £14,000,000 was on account of the treasury and £21,000,000 for individuals, and the amount held in this manner gradually increases. The report for 1904 says "each year the movement in these increases, and this economical and safe mode of effecting receipts and payments is more and more appreciated by the public." In one respect the Bank of France stands at a great advantage in connexion with this branch of its business. The average amount held in this manner for individuals during 1906 was about £23,000,000. As the accounts numbered 77,159 the average for each account was comparatively small. Accounts so subdivided give a great probability of permanence. The figures of the accounts for 1904 were as follows:—

11,178 current accounts, with power of discount.
4,576 simple current accounts.
26,709 current accounts, with advances.
24,106 accounts, deposits.

Total 66,566 accounts, against 59,182 at the end of 1903.

At the present time the Bank of France operates chiefly through its enormous note circulation (averaging in 1906 £186,300,000), by means of which most business transactions in France are carried on.

The limits of the circulation of the Bank of France and the dates when it has been extended are as follows:—

Dates.	Millions of Francs.	Converting the Franc as 25 = £1.
15th March 1848	350	£14,000,000
27th April 2nd May 1848	452	18,000,000
25th December 1849	425	21,000,000
12th August 1850	1800	32,000,000
14th August 1870	2400	96,000,000
29th December 1871	2800	112,000,000
15th July 1872	3200	128,000,000
30th January 1884	3500	140,000,000
25th January 1893	4000	160,000,000
17th December 1897	5000	200,000,000
In 1906	5800	232,000,000

Most business transactions in France are liquidated, not in cheques as in England, but in notes of the Bank of France. These, owing to their convenience, are preferred to specie. This is accumulated in the vaults of the Bank of France, which in 1906 held on average £115,000,000 gold and £42,000,000 silver. The gold held by the Bank of France is generally considerably larger in amount than that held by the Bank of England, which in the autumn of 1890 had to borrow £3,000,000 in gold from the Bank of France at the time of the Baring crisis. The large specie reserve of the bank has been a stability to the trade of France, and has enabled the bank to manage its business without the numerous fluctuations in the rate of discount which are constantly occurring in England. It is true that the holding this very large amount of specie imposes a very heavy burden on the shoulders of the shareholders of the bank, but they do not complain. The advantage to business from the low rate of interest which has to be paid for the use of borrowed capital in France is a great advantage to the trade and industry of that country.

The mass of the reserve in France is so great that the movements of the precious metals, when they are the result only of natural causes, are allowed to go up or without corresponding movements in the discount rate. But it must be remembered that this large reserve is held in part against a gigantic note issue, and also that the trade activity and enterprise of the French people are less intense than in either the United Kingdom or Germany; thus it is much easier for the Bank of France to maintain a steady rate of discount.

Besides the Bank of France, several great credit institutions carry on business in the country; as the *Banque de Paris et des Pays-Bas* (capital and reserve, £3,729,000; other liabilities, deposits, &c., £14,842,000), the *Banque Française pour le Commerce et l'Industrie* (£2,450,000; and £3,505,000), the *Crédit Lyonnais* (£14,000,000; and £82,570,000), the *Comptoir National d'Escompte de Paris* (£6,772,000; and £47,593,000), the *Société Générale pour favoriser le développement du Commerce et de l'Industrie en France* (£7,469,000; and £45,800,000), and the *Société Générale de Crédit Industriel et Commercial* (£1,600,000; and £10,060,000).

There is also the *Crédit Foncier de France* with a very considerable capital, but the business done is so largely that of mortgages that it can hardly be included among banks, though it carries on in some measure the business of banking.

Besides the six important joint-stock banks mentioned above, there exists in France a large number of banks, principally in the provinces, carrying on a very considerable business. Little is known as to their deposits, but their business appears to be conducted with great prudence and discretion. One hundred and eighty-two of them were members of the French Country Bankers' Association in 1898. They carry on business in 66 out of the 86 departments into which France is divided. More than one of these banks has several offices—one possessing 18, including the head office. These branches are situated in the small towns in the vicinity. In this the business follows more the English method of small branches. The French Country Bankers' Association holds its meetings in Paris, where matters of interest to bankers are discussed. (See *Bankers' Magazine*, July 1898.)

Germany.—Besides the Imperial Bank of Germany, the "Reichsbank," there are about 140 banks doing business in the states which form the German empire. These credit and industrial banks with their large resources have had an immense influence in bringing about the astonishing industrial development of their country. Five banks possess the right of uncovered note-issue; these are:—

The Imperial Bank of Germany with right of issue	£23,641,450
The Bank of Saxony	1,638,000
The Bank of Bavaria	1,600,000
The Bank of Württemberg	500,000
The Bank of Baden	500,000

£27,079,950

At the Bank of Germany the coin and bullion held is sometimes larger than at the Bank of England. The statement of the specie in the weekly accounts includes silver. The amounts held in gold and silver are only separated once a year, when the balance-sheet is published. The figures of the balance-sheet for the 31st of December 1906 showed in round numbers £24,000,000 gold and £9,000,000 silver. As far as the capital is concerned the £18,000,000 of the Bank of England considerably exceeds the £9,000,000 of the Bank of France and the £12,200,000 of the Bank of Germany. The note circulation of both the other banks is considerably larger than that of the Bank of England, that of the Bank of France being £186,300,000, and of the Imperial Bank of Germany £69,000,000 in 1906.

The capitals and reserves of the German banks, including those of banks established to do business in other countries, as South America and the Far East, and of the Bank of Germany, are about £133,000,000, with further resources, including deposits, notes and

mortgage bonds, amounting to fully £414,000,000. The amount of the capital compares very closely with that of the capitals of the banks of the United Kingdom. The deposits are increasing. The deposits, however, are not the whole of the resources of the German banks. The banks make use, besides, of their acceptances in a manner which is not practised by the banks of other countries, and the average note circulation of the Reichsbank, included in the statement given above, is between £60,000,000 and £70,000,000.

A large and apparently increasing proportion of the resources of the German banks is employed in industrial concerns, some of which are beyond the boundaries of the empire. The dangers of this practice have called forth many criticisms in Germany, among which may be quoted the remarks of Caesar Strauss and of Dr R. Koch, the president of the Reichsbank. Dr Koch especially points out the need of the development of powerful banks in Germany unconnected with speculative business of this kind. The object of employing their funds thus is the higher rate of interest to be obtained from these investments than from discounting bills or making loans at home. But such an employment of the resources of a bank is opposed to all regular rules of business and of banking tradition, which abstains from making fixed investments of any large part of the resources of a bank. On the other hand, Dr Koch observes that the risks of the one "reserve system" mentioned by Bagehot are not to be feared in Germany.

The recent movement in favour of concentration among the banks has been described by Dr E. Depire and Dr Riesser, who give particulars of the business done by these banks, which does not correspond with banking as practised in the United Kingdom, being more of an industrial character.

There are also many private banking firms in Germany which do a considerable amount of business.

The Reichsbank, by far the most powerful banking institution in Germany, is managed by the bank directory appointed by the chancellor of the empire. The shareholders join in the management through a committee, of which each member must be qualified by holding not less than three shares. The government exercises complete powers of control through the chancellor of the empire. The influence of the Imperial Bank now permeates, by means of its branches, all the separate kingdoms of the empire—the uniformity of coinage introduced through the laws of 1871—1873 rendering this possible. The Imperial Bank assists business principally in two ways—first, through the clearing system (*Giro-Verkehr*), which it has greatly developed, and secondly, through the facilities given to business by its note circulation. The Imperial Bank also receives deposits, and cheques are drawn against these, but in Germany notes are principally used in payments for ordinary business.

Before the Reichsbank was established, Hamburg was the first, and for a long time the only, example of a clearing in Germany. This was taken up by the Reichsbank when it established its office in Hamburg in the time-honoured building which had belonged to the Hamburg Clearing House. Similar business had long been undertaken by the Bank of Prussia. This was absorbed and developed by the Reichsbank in 1876. Through the "clearing system" money can be remitted from any of the 443 places in which there is an office of the Reichsbank, to any of these places, without charge either to the sender or the receiver. It is sufficient that the person to whom the money is to be remitted should have an account at the bank. Any person owing him money in the remotest parts of the empire may go to the office of the bank which is most convenient to him and pay in the amount of his debt, which is credited on the following day at the office of the bank, without charge, to the account of his creditor wherever he may reside. The person who makes the payment need not have any account with the bank. The impetus given to business by this arrangement has been very considerable. It practically amounts to a money-order system without charge or risk of loss in transmission. From Hamburg and Bremen to the frontiers of Russia, from the shores of the Baltic to the frontiers of Switzerland, the whole of the empire of Germany has thus become for monetary purposes one country only. The amount of these transfers for the year 1906 exceeded £1,860,000,000.

The note circulation is also a powerful factor of the business of the Reichsbank. It is governed by the law of 1875 and the amending law of 1899, corresponding in some degree to Peel's act of 1844, which regulates the note circulation of the Bank of England. An uncovered limit, originally £12,500,000, increased to £14,811,450 by the lapse of the issues of other banks allowed to it, has been extended by these and by the act of the 5th of June 1902 to £23,641,450. Against the notes thus issued which are not represented by specie, treasury notes (*Reichskassenscheine*), the legal tender notes of the

1 See *Vorträge und Aufsätze hauptsächlich aus dem Handels- und Wechselrecht*, von Dr R. Koch, pp. 163-164.

empire)¹ and notes of the issuing banks which are allowed to be reckoned as specie or discounted bills, must be held—maturing not later than three months after being taken—with, as a rule, three, but never less than two, good indorsements. There is also a provision that at least one-third of the notes in circulation must be covered by current German notes, money, notes of the imperial treasury, and gold in bullion or foreign coin reckoned at £69, 12s. per pound fine. The Reichsbank is bound by law to redeem its notes in current German money. It is stated that this may be gold coin or silver thalers, or bar-gold at the rate of 1392 marks (£69, 12s. reckoning marks as 20—£1) for the pound fine of gold in practice. Facilities have always been given by the Reichsbank for the payment of its obligations in gold, though the importance of this is admitted. In the balance-sheet for 1906 the bills held amounted to £67,000,000, and the loans and advances to £14,200,000. The notes issued averaged for the year £69,000,000. The gold held amounted, 30th December 1906, to £24,069,000. If the condition of business requires that the notes in circulation should exceed the limits allowed by the law, the bank is permitted to do this on the payment of 5% on the surplus. In this respect the German act differs from the English act, which allows no such automatic statutory power of overpassing the limit of issue. Some good authorities consider that this arrangement is an advantage for the German bank, and the fact that it has been made use of annually since 1895 appears to show that it is needed by the business requirements of the country. Of late years the excess of issue of the Reichsbank has been annual and large, having been £25,267,000 on the 29th of September 1906 and £28,632,000 on the 31st of December of the same year. The amount of the duty paid on the excess issue in the year 1906 was £184,764, and the total amount paid thus from 1876 to 1906 was £839,552. The increase of the uncovered limit (untaxed limit of issue called in Germany the "note reserve") has not been sufficient to obviate the need for an excess of issue beyond the limit.

In accordance with a law passed in 1906 the Imperial Bank issues notes (*Reichsbanknoten*) of the value of 20 marks (£1), and 50 marks (£2, 10s.) in addition to the 5, 10, 100 and 1000 mark notes (ss., 10s., £5, £10) previously in circulation. Imperial paper currency of the value of 20 or 50 marks (£1 and £2, 10s.) had previously existed only in the form of treasury notes (*Reichsschatzscheine*); these will in consequence be withdrawn from circulation.

The amendment of the banking law of Germany, passed in 1899, not only affects the position of the Reichsbank, but that of the four other note-issuing banks. The capital of the Reichsbank has been raised by the bill of that year to £9,000,000. The reserve fund has been raised out of surplus profits to £3,240,000. This exceeds the amount required by the act of 1899, which was £3,000,000. The amending act further diminishes the dividend receivable by the stockholders of the Reichsbank and increases the share which the government will obtain.

The arrangement with the four note-issuing banks is designed to cause them to work in harmony with the Reichsbank when the Reichsbank has to raise its bank-rate in order to protect its gold reserves. The official published rate of discount of the Reichsbank is to be binding on the private note-issuing banks after it has reached or when it reaches 4%. At other times they are not to discount at more than $\frac{1}{2}$ % below the official rate of the Reichsbank, or in case the Reichsbank itself discounts at a lower rate than the official rate, at more than $\frac{1}{2}$ % below that rate. If the Reichsbank discounts below the official rate, it is to announce that fact in the *Gazette*.

The subject being important, we quote from the amending act the sections governing the discount rate:—*Gesetz, betreffend die Abänderung des Bankgesetzes vom 14. März 1875; vom 7. Juni 1899, Artikel 7, §. 1.* The private note-issuing banks are bound by *Artikel 7, §. 2*, after the 1st of January 1901:—(1) Not to discount below the rate published in §. 15 of the law, so long as this rate attains or exceeds 4%, and (2) moreover, not to discount at more than $\frac{1}{2}$ % below the Reichsbank rate, published in S. 15 of the bank law, or in case the Reichsbank itself discounts at a lower rate, not to discount at more than $\frac{1}{2}$ % below that rate."

It remains to be seen whether the note-issuing banks will find these conditions too onerous, and rather than be bound by them will give up their right of issuing notes. The object of the enactment is apparently to protect the specie reserve of the Reichsbank, but it may be doubted whether, considering the importance of the other banks of Germany—none of which is bound by similar conditions—relatively to the note-issuing banks, the restrictions put on the note-issuing banks will have any practical effect.

Since 1870 banking has made immense progress in Germany, but it may be some time before the habit of making payments by cheque instead of specie or notes becomes general.

AUTHORITIES.—*Parliamentary Papers: Report, together with Minutes of Evidence and Accounts, from the Select Committee on the High Price of Gold Bullion*, House of Commons, 8th of June 1810;

¹ The imperial treasury is bound to pay the state notes in cash at any time when this is required, but an independent fund of cash set apart for this purpose does not exist. See *Handwörterbuch der Staatswissenschaften*, vol. v. art. "Papiergeld," p. 97 (Jena, 1893; ed. J. Conrad, L. Elster, W. Lexis and E. Löning).

Reports, Committee of Secrecy on Bank of England Charter, House of Commons, 1832; *Select Committee on Banks of Issue*, House of Commons, 1840; *First and Second Reports, Select Committee on Banks of Issue*, House of Commons, 1841; *First and Second Reports, Select Committee on Commercial Distress*, House of Commons, 1848; *Report, Select Committee on Bank Acts*, House of Commons, 1857; *Report, Select Committee on Bank Acts*, House of Commons, 1858; *Report, Select Committee on Banks of Issue*, House of Commons, 1875; *Report from Secret Committee of the House of Lords on the Causes of the Distress which has for some time prevailed among the Commercial Classes and Industry in Great Britain, as affected by the course for regulating the Issue of Bank Notes payable on demand*, session 1872-1873; *Analysis of the Minutes of Evidence taken before the Select Committee of the House of Commons on Banks of Issue, 1875, with a selection from the evidence*, by R. H. Inglis Palgrave, London, 1876 (printed for private circulation).

GENERAL INFORMATION.—Articles on banking, &c., (*Macmillan's Political Economy*, edited by R. H. Inglis Palgrave (Dictionnaire & Co., 1894-1906); *Handwörterbuch der Staatswissenschaften*, edited by Conrad, Elster, Lexis and Löning, 1899; *Wörterbuch der Volkswirtschaft*, 2 vols. (ed. Elster, 1898); *Dictionnaire des finances*, edited under the direction of Léon Say, by L. Foyat and A. Lanjalay (1889); *Dictionnaire du commerce, de l'industrie et de la banque*, edited by A. Raffalovich and Yves Guyot; *Bankers' Magazine*, commenced 1844, a prospectus of *Improving the Banking System of Britain by a Scottish Bank* (1843); *W. Lexis, Bank Legislation 1841; Debates of the House of Commons on Sir R. Peel's Bank Bills of 1844 and 1845*, reprinted verbatim from "Hansard's Parliamentary Debates, 1875; *Gilbart's Works*, 6 vols. (1865); *The History, Principles and Practice of Banking*, by J. W. Gilbart, edited and revised by A. S. Michie, 1882; Thomson Hankey, *Principles of Banking* (1867); Walter Bagehot, *Lombard Street* (1873), a brilliant picture of the city at that date (new ed., 1906); A. S. Cobb, *Threadneedle Street, a reply to "Lombard Street"* (1891); John Dun, *British Banking Statistics* (1876); R. H. Inglis Palgrave, *Notes on Banking*; George Rae, *The Country Banker* (1886), and several editions later (many sound hints on practice); J. George Kiddy, *The Country Banker's Handbook*, 4th ed. (1903); C. F. Dunbar, *Chapters on the Theory and History of Banking* (1891); Charles Cairdiner, *The Making of the Gold Reserves* (1891); J. B. Artfield, *English and Foreign Banks* (1893) (refers to management of banks); T. B. Moxon, *English Practical Banking*, 10th ed. (1899); A. Crump, *The Key to the London Money Market* (1872); W. Y. Duncan, *Notes on the Rate of Discount in London*, 3 vols., 1822-1856, 1856-1866, 1866-1873, privately printed, Edinburgh, 1856, 1867 and 1877; R. H. Inglis Palgrave, *Bank Rate and the Money Market in England, France, Germany, Holland and Belgium, 1844-1900* (1903); Ernest Seyd, *The Bank of England Note Issue and its Error* (1874); Ernest Seyd, *London Banking and Bankers' Clearing House System*; Ernest Seyd, *The Silver Question in 1893*; Walter Bagehot, *Depreciation of Silver* (1877); Ernest Seyd, *Bullion and the Exchange* (1868); *Tracts by Lord Overstone on the Foreign Exchange, 1856*, 2nd ed. (1853); *Tracts* by Lord Overstone (1818-1857); *Select Tracts on Money, &c.*, reprinted privately by Lord Overstone, 1856-1859 (containing much valuable and interesting information on early history); A. Crump, *A Practical Treatise on Banking, Currency and the Exchanges* (1866); Bonamy Price, *Currency and Banking* (1876) (the interest of this volume to the student of banking is found mainly in the correspondence between Mr Henry Hucks Gibbs (Lord Aldenham) and Professor Bonamy Price on the reserve of the Bank of England); R. H. Inglis Palgrave, *On the Influence of a Note Circulation in the Conduct of Banking Business*, read before the Manchester Statistical Society, 1877; Edgar Jaffé, *Das englische Bankwesen* (Leipzig, 1905); *A History of Banks* (1837); D. Hardcastle, *Banks and Bankers* (1843); W. J. Lawson, *The History of Banking*, 1818; R. James, *Banking*, 1866; 1867; F. G. H. Price, *A Handbook of London Bankers* (1876); Conant, *History of Modern Banks of Issue* (New York, 1896); *History of Banking in all Leading Nations*, 4 vols. (New York, 1866); Viscount Goschen, *Essays and Addresses on Economic Questions, 1865-1893* (1905), (arts. on "Seven per cent.," "Two per cent.," "Our cash reserves and central stock of gold"); C. F. Dunbar, *Economic Essays*, edited by O. M. W. Sprague (1904), (containing many articles on banking, particularly in the United States).

BANK OF ENGLAND.—T. Fortune, *A Concise and Authentic History of the Bank of England* (1802); John Francis, *History of the Bank of England* (1847); J. E. Thorold Rogers, *The First Nine Years of*

the Bank of England (1887); B. B. Turner, *Chronicles of the Bank of England* (1897); T. A. Stephens, *Bibliography of the Bank of England* (1897); A. Andréades, *Histoire de la banque d'Angleterre* (1904; Eng. trans., 1909); Sir F. Schuster, *The Bank of England and the State* (1906).

HISTORY OF BANKING HOUSES.—L. H. Grindon, *Manchester Banks and Bankers* (1877); J. B. Martin, "The Grasshopper" in *Lombard Street* (1892); M. Phillips, *Banks, Bankers, and Banking in Northumberland, Durham and North Yorkshire* (1894); C. H. Cave, *History of Banking in Bristol* (1899); Bidwell, *Annals of an East Anglian Bank* (1900); Richardson, *Compt. & Co., Bankers, Edinburgh and London*; H. T. Easton, *History of a Banking House* (Smith, Payne & Smiths) (1903); J. Hughes, *Liverpool Banks and Bankers, 1790-1837* (1906).

SCOTLAND.—W. H. Logan, *The Scottish Banker* (1847); Robert Soames, *The Scotch Banks and System of Issue* (1873); W. Mitchell, *Scotch Banks and Limited Liability* (1879); A. W. Kerr, *History of Scotch Banking* (1884); A. W. Kerr, *Scottish Banking, 1865-1896* (1898); Boase, *A Century of Banking in Dundee* (1867).

IRELAND.—Melcolm Dillon, *History and Development of Banking in Ireland* (1896).

BRITISH COLONIES.—Edward B. Hamilton, *A Manual of the Law and Practice of Banking in Australia and New Zealand* (1880); *Banking in Australasia* (1883); *The Canadian System of Banking and the National Banking System of the United States* (Toronto, 1890); *Journal of the Canadian Bankers' Association* (Montreal).

FRANCE.—Annuaire-Chaix, *Les Principales Sociétés par actions* (1905); A. Raffalovich, *Le Marché financier* (1905).

GERMANY.—Dr W. Scharling, *Bank Politik* (Jena, 1900); *Die Reichsbank, 1876-1900* (a history and description of the operations of the bank); Dr Adolf Weber, *Depositbanken und Spekulationsbanken, Ein Vergleich deutschen und englischen Bankwesens* (Leipzig, 1902); Dr Felix Hecht, *Die Münchener Banken, 1870 bis 1900* (Leipzig, 1902); Siegfried Buff, *Das Kontokorrentgeschäft im deutschen Bankwesen* (Stuttgart and Berlin, 1904); Dr Riesser, *Zur Entwicklungsgeschichte der deutschen Grossbanken mit besonderer Rücksicht auf die Konzentrationsbestrebungen* (1905); G. M. Boissevain, *Deutsche en Engelse Deposito-Banken* (1905).

ITALY.—*La Banca Popolare di Milano* (1881).

AUSTRIA.—Compass, *Finanzielles Jahrbuch für Österreich-Ungarn* (Vienna).

JAPAN.—*The House of Mitsui* (Tokio); *The Law and the By-Laws of the Nippon Gogyo Ginko* (The Industrial Bank of Japan) (1903).

H. W. Wolff, *People's Banks* (1893). (On systems worked by Schulze-Delitzsch, Raiffeisen, Luzzatti, Banca Popolare, Dr Wollenborg, Popular Banks in Belgium, Switzerland, France, England).

(R. H. L. P.)

UNITED STATES

The early history of the American colonies is strewn like that of most new countries, with many crude experiments in banking and currency issues. Most of these colonial enterprises, however, were projects for the issue of paper money rather than the creation of commercial banks. Speculative banking was checked to a large extent in the colonies by the Bubble Act (6 Geo. I. c. 18), which was passed in England after the bursting of the South Sea Bubble. This act, which forbade the formation of banking companies without a special charter, was in 1740 extended to the colonies.

The serious history of banking in the United States may be said to have begun with the foundation of the Bank of Pennsylvania. This bank originated in the project of a number of the citizens of Philadelphia to supply the continental army with rations. The first bills, issued in 1780, were nothing more than interest-bearing notes payable at a future time. The advances in continental money made by the shareholders were secured by bills of exchange for £150,000, drawn on the American envoys in Europe, but not intended to be negotiated.

A further outgrowth of the needs of the continental government was the Bank of North America, which was authorized by congress on May 26, 1781. The act gave to Robert Morris, the financier, power to create a bank with a capital of \$400,000, to be increased if desirable. Morris arranged with the Bank of Pennsylvania to take over its holdings of foreign bills and paid in cash its claims against the Federation. The Bank of North America did not begin business until the 7th of January 1782, and there was so much doubt of the power of the continental congress to charter a bank that it was thought advisable to obtain a charter from the state of Pennsylvania. Under this charter the bank continued to operate until it was absorbed in the national banking system in 1863, and it may be considered the oldest organized banking institution in the United States.

The bank did much, during the first eight years after its organization, to restore order to the chaos of Federation finances. It loaned to Morris, as government superintendent of finance, \$1,240,975, of which \$906,581 was repaid in cash and the remainder by surrendering the stock in the bank owned by the government.

The Bank of the United States.—A national bank of issue was one of the essential parts of the system built up by Alexander Hamilton in organizing the finances of the Federal government under the constitution of 1789. The first "Bank of the United States" was accordingly incorporated in 1791, with a capital of \$10,000,000, divided into 25,000 shares of \$400 each. This bank issued circulating notes, discounted commercial paper and aided the government in its financial operations. The government subscribed one-fifth of the capital, but paid for it by a roundabout process which actually resulted in the loan of the amount by the bank to the treasury. Other loans were made by the bank to the government, which gradually carried the obligation by the end of 1795 to \$6,200,000. In order to meet these obligations, the government gradually disposed of its bank stock, until by 1802 its entire holdings had been disposed of at a profit of \$671,860. The bank did not publish regular reports, but a statement submitted by Gallatin to congress for January 24, 1811, showed resources of \$24,183,046, of which \$14,578,294 was in loans and discounts, \$2,750,000 in United States stock and \$5,000,567 in specie.

The expiration of the charter of the bank in 1811 was the occasion of a party contest, which prevented renewal and added greatly to the financial difficulties of the government in the war with Great Britain which began in the next year. Although foreign shareholders were not permitted to vote by proxy, and the twenty-five directors were required to be citizens of the United States, the bank was attacked on the ground of foreign ownership as well as on the constitutional ground that congress had no power to create such an institution.

The government was compelled in the year of 1812 to rely on the state banks. Their suspension of specie payments, in 1814, made it very difficult for the treasury to transfer funds from one part of the Union to the other, because the notes of one section did not circulate readily in another. Gallatin left on record the opinion that the suspension of specie payments "might have been prevented at the time when it took place, had the former Bank of the United States been still in existence."

The financial condition of the government became so bad during the war that the second Bank of the United States was authorized in April 1816. The general project was that of Alexander J. Dallas, who in October 1814 had become secretary of the treasury. The capital of the new bank was \$35,000,000, and the government again appeared as owner of one-fifth of the stock, which was paid in a stock note. The president of the United States was authorized to appoint five of the twenty-five directors and public funds were to be deposited in the bank, "unless the secretary of the treasury shall at any time otherwise order and direct." The right of congress to charter the bank came before the Supreme Court in 1819 in the famous case of *McCulloch v. Maryland*. Chief Justice Marshall rendered the decision that the right to create the bank was within the implied powers granted by the Federal constitution, and that it was not competent for the states to levy taxes upon the circulating notes of the bank or upon its property except in common with other property.

The second Bank of the United States was not well managed in the early part of its career, but was upon a firmer foundation under the presidency of Langdon Cheves in 1819. Its policy greatly benefited commerce, but invited bitter complaints from the private dealers in exchange, who had been enabled to make excessive profits while the currency was below par, because of its different values in different states and the constant fluctuations in these values. The Bank, in the language of the report of Senator Samuel Smith of Maryland in 1832, furnished "a currency as safe as silver, more convenient, and more valuable

than silver, which through the whole western and southern and interior parts of the Union, is eagerly sought in exchange for silver; which, in those sections, often bears a premium paid in silver; which is, throughout the Union, equal to silver, in payment to the government, and payments to individuals in business."

The bank in 1835 had attained a circulation of; \$23,075,422 loans of \$59,232,445; and deposits of \$5,061,456. The institution was ultimately destroyed by the open enmity of President Jackson, who in 1833 had suspended the deposit of public money in its custody. This policy known as the "removal of the deposits," excited a bitter political controversy in which Clay and Webster led the opposition, but Jackson was supported by the public (see JACKSON, ANDREW). The Federal charter of the bank expired in 1836. Under a charter obtained by President Nicholas Biddle from the state of Pennsylvania, the bank continued its business, but without success, and in 1841 it went into liquidation.

The State Banks.—The Bank of the United States found powerful rivals during its life and successors after its death in the banks chartered by the separate states. In the undeveloped state of the country in the early days there was much unsound and speculative banking. The most successful systems were those of New York and New England, where the surplus capital of the country in the early days was chiefly concentrated. The least successful banking systems were those in the newer and poorer sections of the country, and they grew progressively worse as poverty and inexperience added to the difficulty of setting aside capital for investment in the tools of exchange.

The termination of the first charter of the Bank of the United States was followed by a banking mania. In Pennsylvania a bill authorizing 41 new banks was passed over the veto of the governor, and 37 of them were in operation in 1814. Similar movements in other states increased the number of banks in four years (1811-1815) from 88 to 208. The amount of specie was not adequate to support the mass of credit which these banks created, and what there was in the country drifted to New England, which was upon a metallic basis. A number of banks collapsed in 1814, and business prostration was prolonged for several years.

The banking laws of the states varied considerably. Some states authorized the issue of notes upon state bonds, many of which, especially at the outbreak of the Civil War, proved valueless. In New England, however, a system prevailed which required the prompt redemption of the banks' notes at par. The New England Bank was the pioneer of this movement in 1814. In 1824 what was known as the "Suffolk system" of redemption came into operation. This system provided for the deposit by a bank in the Suffolk Bank in Boston of a redemption fund, from which the notes were redeemed and afterwards sent home by the Suffolk Bank for collection. This system, with slight modifications, continued in successful operation until 1838. The circulation of the New England banks in 1838 was less than \$40,000,000 and the redemptions in the course of the year through the Suffolk Bank were \$400,000,000. It was the essential merit claimed for the system that it tended to keep the volume of the circulation constantly adjusted to the requirements of business. A branch redemption agency was established at Providence. Legal sanction was given to the system in Vermont by an act of 1842, which levied a tax of 1% upon bank capital, but remitted this tax to any bank which should "keep a sufficient deposit of funds in the city of Boston, and should at that city uniformly cause its bills to be redeemed at par."

The period from 1836 to 1842 was a trying one for American banking. It was preceded by another great expansion in financial ventures, made without sufficient circulating capital or adherence to conservative banking methods. Foreign capital had come into the country in considerable amounts after the English crisis of 1825, the entire debt of the general government was paid off and a tremendous speculation occurred in public lands, which were expected to advance rapidly in value as the result of immigration and the growth of the country. The sales of public lands in 1836, on the eve of the crisis, reached 20,074,870 acres

and brought receipts to the treasury of \$25,167,833. How essentially speculative was the mass of these sales is indicated by the fact that such receipts declined in 1842 to only \$1,417,972. President Jackson pricked the bubble of speculation by the "Specie circular" of July 11, 1836, requiring payments for public lands to be made only in specie or notes of specie value. Practically every bank in the Union stopped payment, and banking capital fell from \$358,442,692 in 1840 to \$106,804,309 in 1846. As usual in periods of business collapse the shrinkage of capital did not follow at once the outbreak of the panic, but was the result of gradual liquidation. Specie payments were resumed in 1838, but there was another crash in 1842, after the United States Bank finally suspended.

In New York, which was becoming the chief commercial state of the Union, the banks of New York City were generally sound, but several different systems were tried of securing the circulating notes. The "safety-fund system," inaugurated in 1829, provided for a contribution by each bank towards a fund to meet the deficit of any contributing bank which might fail with assets insufficient to meet its liabilities. It was the intention of the act to protect by this fund only the bank-notes, but it was treated as a fund for the payment of all the liabilities of a failed bank and in consequence the fund was exhausted by important failures which occurred in the panics of 1837 and 1857. Before 1843 the issue of notes was not controlled by the state, so that in several cases there were illegal over-issues.

What was called the "free-banking system" was inaugurated in New York by the act of 1838. This system permitted any body of persons, complying with the requirements of the law, to form a bank and issue circulation secured by the deposit of various classes of public bonds. This system was in operation at the outbreak of the Civil War, was imitated in several other states, and became in a measure the model of the national banking system. The state banks of Indiana and Ohio were among the most successful of the state banks, being modelled somewhat on the European plan of a central bank. They held in their states an exclusive charter for issuing notes and had branches at important points throughout the state. Under the management of Hugh McCulloch, afterwards secretary of the treasury, the bank of Indiana weathered the crisis of 1857 without suspending specie payments, and retired its circulation when gold went to a premium in 1862.

One of the defects of the state system of note-issues was the inconvenience which it occasioned. Notes issued outside a state could not safely be received without careful scrutiny as to the responsibility of their issuers. The systems prevailing in New England, in Louisiana, in Ohio and in Indiana were eminently successful, and proved the soundness of the issue of bank-notes upon the assets of a well-conducted commercial bank. But the speculation fostered by loose banking laws in some other states, and the need for uniformity, cast a certain degree of discredit upon the state banks, and prepared the way for the acceptance of a uniform banking system in 1864.

The power of note-issue formed a more important part of banking resources before the Civil War than in later years, because the deposit system had not attained its full development. Thus in 1835 circulation and capital of state banks combined were about \$335,000,000 and deposits were only \$83,000,000, in 1907 circulation and capital of national banks \$1,430,000,000, while deposits were \$4,322,000,000—in the earlier period deposits forming less than one-third of the other two items and in the later period three times the other items. The circulation of the state banks fluctuated widely at different periods. A maximum of \$149,185,890 was attained in 1837, to decline to \$106,968,572 three years later and to a minimum of \$58,563,668 in 1843. From this point there was a tendency upward, with some variations, which put the circulation in 1845 at \$89,608,711; 1848, \$128,506,091; 1850, \$131,366,526; 1854, \$204,680,207; 1856, \$195,747,950; 1858, \$155,208,344; 1860, \$207,102,477; 1863, \$238,677,218.

Other leading items of the accounts of the state banks for representative years are as follows:—

State Banking Progress, 1835-1863.

Year.	No. of Banks.	Capital Stock.	Loans and Discounts.	Deposits.
1835	704	\$231,250,337	\$365,163,834	\$83,081,365
1845	707	206,045,969	288,617,131	88,020,646
1850	824	217,317,211	364,204,078	109,586,595
1855	1307	332,177,288	576,144,758	190,400,342
1860	1562	421,880,095	691,945,580	253,802,129
1863	1466	405,045,829	648,601,863	393,686,226

The National Banking System.—The creation of the national banking system was mainly the outcome of the financial necessities of the Federal government in the Civil War. It was found difficult to float government bonds at profitable rates, and Mr Chase, the secretary of the treasury, devised the scheme of creating a compulsory market for the bonds by offering special privileges to banks organized under Federal charters, which would issue circulating notes only when secured by the deposit of government bonds. But this plan, authorized by the act of 25th February 1863 (supplemented by the act of 3rd June 1864), was not sufficient to give predominance to the national banks. The state banking systems in the older states were so firmly entrenched in the confidence of the commercial community that it became necessary to provide for imposing a tax of 10% upon the face-value of the notes of state banks in circulation after the 1st of July 1866. The state banks were thus driven out of the note-issuing business, some being converted into national banks, while others continued their commercial business under state laws without the privilege of note-issue. A remarkable growth in the national banking system took place; in 1864 there were 453 national banks with an aggregate capital of \$79,366,950, and in 1865 there were 1014 banks with an aggregate capital of \$242,542,982.

The national banking system was specially marked by the issue of circulating notes upon United States bonds. Any national bank desiring to issue notes might by law deposit with the United States treasurer bonds of the United States to an amount not exceeding its capital stock, and upon such bonds it might receive circulation equal to 90% of their par-value. No bank could be established which did not invest one-third of its capital in bonds. This was changed in 1874 so as to reduce the requirement to 25%, with a maximum mandatory requirement of \$50,000. Notes were taxed at the rate of 1% per annum. The banks obtained from the provision for circulation the benefit of what was described by critics as "double interest," being credited with the interest on bonds in the custody of the treasury department, and being also able to lend their notes to the public. But several deductions had to be made: notes could not be issued to the full par-value of the bonds; the tax of 1% upon circulation reduced by that amount the profit which would otherwise be earned; and the banks had to set aside in gold or other lawful money what was needed for redemption purposes and for reserves. As the banks suspended specie payments at the close of 1861 and great masses of government paper-money were issued, gold ceased to be a medium of exchange except in California, and the new banks redeemed their notes in government paper. The gold-value of the bank-notes, therefore, rose and fell with that of government notes until the resumption of payments in specie by the national treasury on the 1st of January 1879.

The amount of bank-notes in circulation proved in practice to be influenced largely by the price of bonds. The maximum originally set for bank circulation was \$300,000,000. This was increased in 1870 by \$54,000,000, and in 1875 the limit was removed. The circulation reached \$362,651,169 on the 1st of January 1883, but afterwards declined materially as bonds became scarce and the price rose. The fact that circulation could be issued to only 90% of the par-value of the bonds greatly reduced the net profits on circulation when the price of 4% bonds rose in 1889 above 129 and other classes of bonds rose in like ratio. The circulation of bank-notes fell as low as \$167,927,574 on the 1st of July 1891, but afterwards increased somewhat as

the supply of bonds was increased to meet the treasury deficiencies of 1894-1896 and the expenses of the war with Spain.

The national banks supported the government cordially in the measures taken to bring about resumption of gold payments on the 1st of January 1879 under the law of 1875. The banks held more than \$125,000,000 in legal tender notes, of which sum nearly one-third was held in New York City. A run upon the treasury for the redemption of these notes would have exhausted the gold funds laboriously accumulated by secretary Sherman and compelled a new suspension. But the banks appointed a committee to co-operate with the treasury, declined to receive gold longer as a special deposit, and resolved to receive and pay balances without discrimination between gold and government notes. Thus resumption was accomplished without jar, and as early as the 17th of December 1878 gold sold at par in paper.

The silver legislation enacted by Congress in 1878 and 1890 caused uneasiness in banking circles, and the banks discriminated against silver dollars and silver certificates in their cash. When the treasury began to lose gold heavily, however, in 1893, a combination of leading bankers in New York, Boston, Philadelphia, Baltimore and Chicago turned over a large part of their holdings to replenish the government reserves. About 150 national banks suspended during the panic of 1893, but 84 of these afterwards resumed business. As in former periods of depression, the system suffered the greatest decline during the years of liquidation following the actual panic, the number of banks falling from 3856 on the 1st of June 1893 to 3585 on the 1st of June 1899, and aggregate capital falling during the same period from \$698,454,665 to \$610,028,895.

A new extension was given to the national banking system by the provisions of the gold standard law of 14th March 1900. Banks were authorized to issue circulation to the full par-value of bonds deposited, and the tax upon circulation was reduced from 1% to $\frac{1}{2}$ of 1% in the case of circulation which was secured by the 2% refunding bonds, which were authorized by this law. By issuing 2% bonds in exchange for those paying a higher interest, at approximately the market-price, it became possible to obtain a given amount of notes upon a smaller investment in bonds, independent of other provisions of the law. Under these provisions the volume of notes outstanding, secured by bonds, which stood on the 31st of October 1899 at \$207,920,774, reached on the same date in 1900, \$298,829,064; in 1901, \$328,198,613; in 1902, \$335,783,180; in 1903, \$380,650,821; in 1904, \$424,530,581; in 1905, \$499,037,806; in 1906, \$536,933,169; and in 1907 \$562,727,614.

The lowest denomination of national bank-notes authorized by law is \$5, and not more than one-third of any bank's issues can be of this denomination. The government issues notes for \$1 and \$2, as well as for higher denominations. The largest amount of bank-notes of one denomination is in bills for \$10, which on the 31st of October 1907 constituted \$249,046,530 in total outstanding issues of \$609,905,441. Of this total circulation \$562,727,614 was secured by bonds, and the remainder, \$47,252,852, was covered by lawful money in the government treasury, deposited for the redemption and retirement of the notes as they might be received.

An important extension of the national system resulted from the authority given by the act of 1900 to incorporate national banks with a capital as low as \$25,000, in places having a population not in excess of 3000. The previous minimum limit had been \$50,000. Under this provision there were incorporated to the 31st of October 1907 2389 national banks with capitals of less than \$50,000, with aggregate capital of \$62,312,500, of which 272 banks were conversions of state and private institutions, 752 were reorganizations and 1365 were new institutions.

The national banks possess most of the powers of commercial banks, but are not permitted to hold real estate other than their banking houses, unless taken for debt. Five reports are required each year to the comptroller of the currency at dates selected by him without notice, and each bank is subject to the visitation of bank examiners acting under the comptroller. No reserves against notes are required by existing law except 5%, which is

kept in Washington for current redemption purposes. The redemption system is defective in that redemptions are not authorized at other places, and the notes reach the treasury on an average only about once in two years. For many years the banks were prohibited from retiring more than \$3,000,000 of notes monthly, but the limit was raised by an act of 4th March 1907 to \$9,000,000 per month.

Reserves are required against deposits to the amount of 25% in so-called "reserve cities," and 15% in what are called the "country banks" outside of reserve cities. Not all these amounts, however, are required to be kept in cash. The three central reserve cities, where cash is required, with only trifling deductions, are New York, Chicago and St. Louis. In other reserve cities, which in 1908 numbered forty, the banks are permitted to deposit half their cash in national banks in central reserve cities, while country banks may deposit three-fifths of their cash in any reserve city. The shareholders of national banks are subject in case of liquidation to double liability upon their shares, and this is now the rule in most of the conservative state banking systems. National bank-notes are not legal tender, but are receivable by the government for all obligations except customs dues.

The panic of 1907 imposed a severe strain upon the cash resources of the banks of New York City, but did not cause any such considerable number of failures as occurred in 1893.

Payment of cheques in currency was suspended in New York on the 28th of October 1907, and continued until about the beginning of the year 1908. The panic was precipitated by over-speculation by a group of national banks, followed by the suspension of the Knickerbocker Trust Company on the 22nd of October with deposits of \$48,000,000. Then came runs on other companies, a deficit in the required reserves of New York banks of \$38,838,825 in the week of 2nd November, and arrangements for the importation of foreign gold to an amount which soon approached \$100,000,000. With an increase during the autumn of about \$77,000,000 in national bank circulation, a transfer of \$72,000,000 from the treasury to the banks, and a further decline in required reserves in New York during the next week, the amount of currency which was added to the circulation or disappeared during a few weeks of the panic amounted to more than \$275,000,000, or nearly one-tenth of the usual volume of circulation in the country. The total bank-note circulation on the 28th of December 1907 had risen to \$687,340,835; but this amount was abnormal and was reduced somewhat during the spring of 1908.

The position of the trust companies, especially those of the city of New York, was one of the disturbing features of the panic. These companies were comparatively a small factor in New York finance at the time of the panic of 1893. The capitalization of all the trust companies in the United States, even as late as 1897, was only \$106,968,253, and individual deposits were \$566,922,205. The capital of these companies had risen in 1907 to \$276,145,081 and their deposits to \$2,061,623,035. The trust companies of New York were required by the law of the state to maintain only 5% of their demand deposits in cash in their vaults. Whilst most of them had also large amounts on deposit in national banks, these reserves proved inadequate to sustain the vast mass of credit which was built upon them. The absolute amount of the reserves, however, was perhaps less important than the class of business to which some of the less conservative of these companies had committed themselves. Instead of keeping their assets liquid by purchases of commercial paper and loans on first-class negotiable securities, they had in some cases engaged in speculative underwritings and had locked up their funds in enterprises requiring a long time for their consummation.

It was these combined influences which led to distrust of the Knickerbocker Trust Company, and to the runs upon that company and others during the late days of October and early November. The result was to reduce the total resources of the forty-eight trust companies of Greater New York from \$1,205,019,700 on the 22nd of August 1907 to \$858,674,000 on the 19th of December 1907. Individual deposits subject to cheque fell from \$692,744,900 to \$437,733,400. Such a reduction of resources

within so short a time, most of it being accomplished within a few weeks, has hardly ever been recorded in the history of banking, and the fact that the stronger companies were able to call in their cash and meet such demands was evidence to a certain extent that the criticisms upon them were exaggerated. The necessity for stronger reserves and for greater safeguards against speculative operations was so strongly impressed upon the public mind, however, that several restrictive measures were enacted at the session of the New York legislature in 1908, designed to prevent any abuses of this sort in the future.

The function of issuing notes, which is exclusively a privilege of national banks, has diminished in importance in America, as other methods of transferring credit have attained a wide development. This has not only been true of the national banks themselves, but has accounted for the development alongside the national banking system of state banks, private banks and trust companies, which have not had the privilege of note-issue, but have obtained other privileges sometimes greater than those of the national banks.

The aggregate resources of all classes of banks in the United States have greatly increased in recent years. The following table shows the increase in the chief items of the accounts of national banks for representative years from the reports made nearest to the beginning of the year:—

PROGRESS OF NATIONAL BANKS, 1865-1908

Year.	No. of Banks.	Loans and Discounts.	Individual Deposits.
1865	638	\$166,448,718	\$13,479,636
1870	1615	688,875,203	546,236,881
1875	2027	955,862,580	682,846,607
1880	2052	933,543,661	755,459,966
1885	2664	1,234,202,226	987,649,055
1890	3326	1,811,686,891	1,436,402,685
1895	3737	1,991,913,123	1,695,489,346
1897	3661	1,901,160,110	1,639,688,393
1899	3590	2,214,394,838	2,225,269,813
1900	3602	2,479,819,494	2,380,610,361
1901	3942	2,706,534,643	2,623,997,521
1902	4291	3,038,255,447	2,904,417,965
1903	4666	3,303,148,991	3,152,878,796
1904	5180	3,469,105,043	3,300,000,000
1905	5528	3,728,168,086	3,612,499,598
1906	5911	4,071,041,164	3,688,420,135
1907	6288	4,463,267,629	4,115,650,294
1908	6625	4,585,337,094	4,176,873,717

The combined returns of state and private banks, savings banks and loan and trust companies in the United States show a growth within a few years which is indicated by the principal items of their accounts:—

RESOURCES OF STATE BANKS, TRUST COMPANIES, &c.

Items.	1897.	1907.
Capital stock	\$380,090,778	\$807,178,262
Surplus and profits	382,436,990	924,655,010
Loans	2,231,013,262	6,099,807,535
Deposits	3,324,254,807	8,776,755,207
Total Resources	4,258,677,065	11,168,514,516

The aggregate banking power of the United States, as computed by the comptroller of the currency in his annual report for 1907, increased from \$5,150,000,000 in 1898 to \$17,820,800,000 in 1907, and the banking power of foreign countries from \$14,835,000,000 to \$27,034,200,000, representing an increase for all reporting countries from \$15,985,000,000 to \$44,859,000,000.

The system of clearing cheques has attained a higher development in the United States than in any other country, except perhaps, Great Britain. Clearing-houses exist in about 112 leading cities, and the aggregate clearings for the year ending 30th September 1907 reached \$154,662,515,258. The New York Clearing-House inevitably does a large proportion of this business; its clearings constituted in 1906 67.2% of the total clearings in 55 of the larger cities. The volume of clearings fluctuates greatly with the volume of stock-exchange transactions and with the business prosperity of the country. An indication of these fluctuations at New York is afforded by the following table, taken from Conant's *Principles of Money and Banking*, brought down to 1907.

The Clearing-House Committee of the New York Clearing-House exercises a powerful influence over the banking situation through its ability to refuse aid in emergencies to a bank which is unwisely conducted. This power was used in the panic of 1907 to eliminate several important, but speculative, financial interests from control of national banks. Only national and state banks and the sub-

VARIATIONS IN CLEARINGS AT NEW YORK

Year.	Average Daily Clearings.	Per cent Balances to Clearings.	Remarks.
1870	\$90,274,479	3.72	
1873	115,885,794	4.15	Great business activity.
1874	74,692,574	5.62	Industrial depression.
1881	159,232,191	3.66	Renewal of railway building.
1885	82,789,480	5.12	Results of bank panic.
1890	123,074,139	4.65	Business expansion.
1894	79,704,426	6.54	Depression following panic.
1896	96,232,412	6.28	Free silver panic.
1899	189,951,029	5.37	Renewed confidence and activity.
1901	254,193,639	4.56	Culmination of industrial flotations.
1904	195,648,514	5.20	Diminished stock-exchange and business activity.
1906	342,422,773	3.69	Stock-market activity.

Treasury were members of the Clearing-House at this time. Their weekly reports of condition were awaited every Saturday as an index of the state of the money-market and the exchanges; but this index was incomplete and sometimes misleading, because regular weekly reports were not made by trust companies. It was announced early in 1908 by the state superintendent of banking that he would exercise a power vested in him by law to require weekly reports in future from trust companies, so that the two classes of reports would present a substantially complete mirror of banking conditions in New York.

AUTHORITIES.—William M. Gouge, *A History of Paper Money and Banking in the United States* (Philadelphia, 1833); Condy Raguet, *A Treatise on Currency and Banking* (Philadelphia, 1840); J. S. Gibbons, *The Banks of New York, their Dealers, the Clearing-House and the Panic of 1857* (New York, 1858); Albert S. Bolles, *Financial History of the United States* (3 vols., New York, 1884-1886); Charles F. Dunbar, *Chapters on the Theory and History of Banking* (New York and London, 1891); Horace White, *Money and Banking* (Boston, 1902); Charles A. Conant, *A History of Modern Banks of Issue* (New York, 1896); Alexander D. Noyes, *Sixty Years of American Finance* (New York, 1898); Davis Rich Dewey, *Financial History of the United States* (New York and London, 1903); John C. Schwab, *The Confederate States of America, 1861-1865* (New York, 1901); David Kinley, *The Independent Treasury of the United States* (New York, 1893); *Report of the Monetary Commission of the Indianapolis Convention* (Chicago, 1898); Charles A. Conant, *The Principles of Money and Banking* (2 vols., New York, 1905); William G. Sumner, *A History of American Currency* (New York, 1884); Amos Kidder Fiske, *The Modern Bank* (New York, 1904); William G. Sumner, *A History of Banking in the United States* (New York, 1896), being vol. i. in *A History of Banking in All the Leading Nations*; John Jay Knox, *History of Banking in the United States* (rev. ed., New York, 1900); and R. C. H. Catterall, *The Second Bank of the United States* (Chicago, 1903).

Much statistical information is contained in the annual reports of the comptroller of the currency of the United States, published annually at Washington. (C. A. C.)

ENGLISH LAW AFFECTING BANKS AND THEIR CUSTOMERS

Issue of Notes.—The legislation which culminated in the Bank Charter Acts of 1844 and 1845 secured to the Bank of England the absolute monopoly of the note issue within the city of London and a 3-m. radius. Outside that radius, and within 65 m. of the city, there is a concurrent right in banks, consisting of six or less than six persons, established before 1844, and issuing notes at that date; beyond the 65-m. radius the privilege may be exercised by all banks established before 1844, and then issuing notes, who have not since lost their right to do so by bankruptcy, abandonment of business, or temporary suspension of issue. According to some authorities, the effect of 20 and 21 Vict. cap. 49, sec. 12 [re-enacted Companies Consolidation Act 1908, sec. 286 (d)] was to sanction the increase in the constitution of any bank issuing notes outside the 3-m. and within the 65-m. radius from six to ten persons without affecting the power to issue notes. The rule as formulated above is, however, that enunciated by Bowen J. in *Capital and Counties Bank v. Bank of England*, 1889; 61 L.T. 516. The increase in the number of joint-stock banks and the gradual absorption of the smaller and older concerns have had the effect of minimizing the output of notes other than those issued by the Bank of England, and, as exemplified by the case of *The Attorney-General v. Birkbeck*, 12 Q.B.D. 57, it would seem impossible to devise any scheme by

which the note-issuing power of an absorbed bank could be continued to the new or amalgamated body. But a bank having the right would not necessarily lose it by absorbing other banks (*Capital and Counties Bank v. Bank of England*). Foreign banks may establish branches in Great Britain on complying with the regulations imposed on them by the Companies Consolidation Act 1908, but cannot apparently issue notes, even though payable abroad.

Deposit Business.—The term "bank of deposit" gives a mistaken idea of the real relation between banker and customer. So long ago as 1848 it was decided by the House of Lords in *Foley v. Hill*, 2 H. of L. 28, that the real relation between banker and customer was that of debtor and creditor, not in any sense that of trustee and *cestui que trust*, or depositor and depositor, as had been formerly supposed and contended. The ordinary process by which a man pays money in to his account at his banker's is in law simply lending the money to the banker; it fixes the banker with no fiduciary relation, and he is in no way responsible to the customer for the use he may make of the money so paid in. And as being a mere debt, a customer's right to recover money paid in is barred on the expiration of six years by the Statute of Limitations, if there has been no payment meantime on account of principal or interest, and no acknowledgment sufficient to bar the statute (*Pott v. Clegg*, 16 M. & W. 321). Such a state of affairs, however, is hardly likely to arise, inasmuch as, in the absence of specific appropriation, earlier drawings out are attributed to the earlier payments in, as in the ordinary case of current accounts, and so the items on the credit and debit side cancel each other. An apparent exception to this system of appropriation exists in cases where a man wrongfully pays into his own account moneys held by him in a fiduciary capacity. In such circumstances he is presumed to have drawn out his own moneys rather than those affected by the trust, and so long as the account is in credit, any balance will be attributed to the trust money. As between contending claims to the moneys, based on different breaches of trust, the ordinary rule of appropriation will apply.

It has often been suggested that the only method of withdrawing money from a banker is by cheque, that the presentation of a cheque is a condition precedent to the liability of the banker to repay. This is not so; such a view being inconsistent with the cases establishing the effect of the Statute of Limitations on money left in a banker's hands, and with the numerous cases in which a balance at a bank has been attached as a simple and unconditional debt by a garnishee order, as, for instance, in *Rogers v. Whiteley*, 1892, A.C. 118. The banker's position with regard to cheques is that, superadded to the relation of debtor and creditor, there is an obligation to honour the customer's cheques provided the banker has a sufficient and available balance in his hands for the purpose (*Foley v. Hill*). If, having such funds in his hands, the banker dishonours a cheque, he is liable to the customer in substantial damages without proof of actual injury having accrued (*Robin v. Steward*, 14 C.B. 595). Where several cheques are presented simultaneously and the available balance is insufficient to pay all, the banker should pay as many as the funds will cover, and is not bound to discriminate between particular cheques. It would seem a legitimate condition that a cheque should be drawn in the ordinary recognized form, not in one raising any question or doubt as to its validity or effect. Cheques drawn to "wages or order," "petty cash or order," or the like, are common, and are sometimes regarded as payable to bearer. Such payees are not, however, "fictitious or non-existent persons," so as to render the cheques payable to the bearer under sec. 7, subs. 3 of the Bills of Exchange Act 1882, nor can such payees endorse. Some banks refuse to pay such cheques, and it is conceded they are justified in so doing. Money paid in so shortly before the presentation of the cheque that there would not have been time to pass it through the books of the bank would not be treated as available for drawing against. If a person have an account at one branch of a bank, he is not entitled to draw cheques on another branch

where he has either no account or is overdrawn, but the bank has, as against the customer, the right to combine accounts at different branches and treat them as one account (*Garnet v. M'Even*, L.R. 8 Ex. 10). Funds are not available so long as a garnishee order, founded on a judgment against the customer, is pending, since it attaches all moneys on current account irrespective of the amount of the judgment (*Rogers v. Whiteley*).

The very questionable practice of post-dating cheques has been the source of considerable doubt and inconvenience to bankers. The use of such documents enables the drawer to obtain the results of a bill at a fixed future date without the expense of a regular bill-stamp. But the Bills of Exchange Act 1882, sec. 13, subs. 1, provides that "a bill is not invalid by reason only that it is ante-dated or post-dated, or that it bears date on a Sunday." The banker cannot therefore refuse to pay a cheque presented after the apparent date of its issue on the ground that he knows it to have been post-dated. On the other hand, he is entitled and indeed bound to refuse payment if such a cheque is presented before the apparent date of its issue (*Morley v. Culverwell*, 7 M. & W. at p. 178). Revocation of authority to pay a cheque must come to the banker's conscious knowledge and be unequivocal both in terms and method of communication. He is not bound to act on an unconfirmed telegram (*Curtice v. London City & Midland Bank* [1908], 1 K.B. 293). The banker's authority to pay cheques is terminated by the death, insanity or bankruptcy of the customer, or by notice of an available act of bankruptcy committed by him.

The banker is bound to observe secrecy with respect to the customer's account, unless good cause exists for disclosure, and the obligation does not cease if the account becomes overdrawn (*Hardy v. Vessey*, L.R. 3 Ex. 107). In England a cheque is not an assignment of funds in the banker's hands (Bills of Exchange Act 1882, sec. 53). The holder of the cheque has therefore no claim on the banker in the event of payment being refused, his remedy being against the drawer and endorser, if any. On this section is also based the custom of English bankers not to pay part of the amount of a cheque where there are funds, though not sufficient to meet the whole amount. The section does not apply to Scotland, where it would seem that the bank is bound to pay over what funds it has towards satisfaction of the cheque. A banker is entitled to hold paid cheques as vouchers until there has been a settlement of account between him and the customer. The entries in a pass-book constitute *prima facie* evidence against the banker, and when returned by the customer without comment, against him; but the proposition that such return constitutes a settlement of account has been much disputed. Indeed where forgery is the ground of repudiation of a cheque, no dealings or omissions of the customer with regard to the pass-book would seem to preclude him from objecting to being debited and throwing the loss on the banker (*Keppitigalla Rubber Co. v. National Bank of India*, 25 Times L.R. 402). As against the banker, however, credit entries in the pass-book cannot be disputed if the customer has altered his position in reliance thereon, and cheques drawn against an apparent balance must be honoured (*Holland v. Manchester & Liverpool District Bank*, 25 Times L.R. 386).

The rule by which the holder of a cheque has no direct recourse against the banker who dishonours it, holds good even where the banker has before issue marked the cheque as good for the amount, such marking not amounting to an acceptance by the banker. As between banker and banker, however, such marking or certifying probably amounts to a binding representation that the cheque will be paid, and, if done by request of the drawer, the latter cannot subsequently revoke the authority to pay. In certain circumstances, marking at the instance of the person presenting the cheque for payment may amount to an undertaking by the banker to hold the money for his benefit (*In re Beaumont* [1902], 1 Ch. p. 895).

A banker either paying or collecting money on a cheque to which the person tendering it for payment or collection has no title or a defective title is *prima facie* liable to the true owner for conversion or money had and received, notwithstanding he acted

in perfect good faith and derived no benefit from the operation. Payment of an open cheque, payable to bearer either originally or by endorsement, is, however, in all cases a good payment and discharge (*Charles v. Blackwell*, 2 C.P.D. at p. 158). Limited protection in other cases has been extended by legislation to the banker with regard to both payment and collection of cheques, usually on the principle of counterbalancing some particular risk imposed on him by enactments primarily designed to safeguard the public.

By sec. 19 of the Stamp Act 1853, the banker paying a draft or order payable to order on demand, drawn upon him, was relieved from liability in the event of the endorsement having been forged or unauthorized. This enactment was not repealed by the Bills of Exchange Act 1882, and, in *London City & Midland Bank v. Gordon* (1903), A.C. 240, was held to cover the case of drafts drawn by a branch of a bank on its head office. Sec. 60 of the Bills of Exchange Act 1882 extends like protection to the banker in the case of cheques, the definition of which therein as "bills drawn on a banker payable on demand" debars drafts of the above-mentioned description. Such definition, involving the unconditional character of the instrument, also precludes from the protection of this section the documents now frequently issued by corporations and others, which direct bankers to make payments on a specific attached receipt being duly signed (*London City & Midland Bank v. Gordon*). Sec. 17 of the Revenue Act 1883, however, applies to these documents the crossed cheque sections of the Bills of Exchange Act 1882 (see *Bavins, Jr., & Sims v. London & South-Western Bank* [1900], 1 Q.B. 270), while denying them the position of negotiable instruments, and a banker paying one of them crossed, in accordance with the crossing and in the absence of any indication of its having been transferred, could probably claim immunity under sec. 80. The Bills of Exchange Act 1882 contains no direct prohibition against a banker paying a crossed cheque otherwise than in accordance with the crossing, but if he do so he is liable to the true owner for any loss suffered by him in consequence of such payment (sec. 70), and is probably unable to charge his customer with the amount. A banker paying a crossed cheque in accordance with its ostensible tenor obtains protection under sec. 80 and the proviso to sec. 70. Questions have arisen as to the bearing of the crossed cheque sections when a crossed cheque drawn on one branch of a bank is paid in for collection by a customer at another branch; but the transaction is so obviously a legitimate and necessary one that either by the collecting branch or may be regarded as a separate bank for this purpose, or sec. 79 may be ignored as inapplicable (*Gordon v. London City & Midland Bank* [1902], 1 K.B. 242 C.A.).

The collection of crossed cheques for a customer being virtually incumbent on a banker, qualified immunity is accorded him in so doing by sec. 82, a final exposition of which was given by the House of Lords in *London City & Midland Bank v. Gordon* (1903), A.C. 240. To come within its provisions, the banker must fulfil the following conditions. He must receive the cheque from, and the money for, a customer, i.e. a person with whom he has definite and existing business relations (see *Great Western Ry. Co. v. London & County Bank* [1901], A.C. 414). He must take the cheque already crossed generally or specially to himself. His own crossing under sec. 77 is absolutely inefficacious in this connexion. He must take the cheque and receive the money in good faith and without negligence. Negligence in this relation is the omission to exercise due care in the interest of the true owner, not necessarily the customer. To avoid this disqualification of negligence, the banker must see that the endorsements, where necessary, are ostensibly correct; he must satisfy himself of the authority where an endorsement is per procurator; he must not take for private account a cheque which on its face indicates that the holder is in possession of it as agent, or in an official capacity, or for partnership purposes (*Hannan's Lake View Central Ltd. v. Armstrong & Co.*, 16 Times L.R. 236; *Bevan v. National Bank*, 23 Times L.R. 65); he must not take a cheque marked "account payee" for an account other than that

indicated (*Bevan v. National Bank*). It is further demonstrated by the Gordon case that the banker only secures protection so long as he is acting strictly as a conduit pipe, or as agent for the customer. If he put himself in the position of owner of the cheque, he no longer fulfils the condition of receiving the money only for the customer. In the Gordon case, adoption of the not uncommon practice of crediting cheques as cash in the bank's books before the money was actually received was held equivalent to taking them as transferee or owner, and to debar the bank from the protection of sec. 82. The anxiety and inconvenience caused to bankers by this unexpected decision was ultimately removed by the Bills of Exchange (Crossed Cheques) Act 1906, which enacts that a banker receives payment of a crossed cheque for a customer within the meaning of sec. 82 of the Bills of Exchange Act 1882, notwithstanding that he credits his customer's account with the amount of the cheque before receiving payment thereof. Apparently the scope of this act must be confined to its immediate object, and it does not affect the relations and rights between the banker and his customer or parties to the cheque arising from such crediting as cash. For instance, the customer, in the absence of agreement to the contrary, may at once draw against cheques so credited, while the banker may still debit the customer with the amount of the cheque if returned unpaid, or sue the drawer or indorser thereon.

The protection to the collecting banker is in no way affected by the cheque being crossed "not negotiable," or by the nature of the fraud or crime by which the cheque was obtained by the customer or any previous possessor, although there are dicta which have been interpreted in the contrary sense. Nor does the fact that the customer is overdrawn deprive the banker of the character of a collecting agent, unless the cheque be definitely given and taken in reduction of such overdraft. Where the conditions requisite for protection exist, the protection covers not only the receipt of the money, but all operations usual in business and leading up to such receipt, on the basis of the customer's title being unimpeachable. The provisions of the crossed cheques sections of the Bills of Exchange Act 1882 are extended to dividend warrants by sec. 95 of that act, and to certain orders for payment issued by a customer of a banker by sec. 17 of the Revenue Act 1883, as before stated. But the wording of the Bills of Exchange (Crossed Cheques) Act 1906, specifying as it does cheques alone, appears to exclude documents of both these classes from its operation. With regard to the orders for payment, inasmuch as the same section which brings them within the crossed cheques sections expressly provides that they shall not be negotiable, a banker would probably be protected only in taking them from the specified payee, though this distinction has been ignored in some recently decided cases.

Where a banker incurs loss through forgery or fraud in circumstances not covered by statutory protection, his right to relief, if any, must depend on general principles. He cannot

charge his customer with payments made on a forgery of that customer's signature, on the ground either that he is presumed to know such signature or that the payment is unauthorized. But if the customer has accredited the forgery, or, having knowledge or reasonable ground for belief that it has been committed, has failed to warn the banker, who has thereby suffered loss or prejudice, the customer will be held estopped from disputing the banker's right to debit him with the amount (*Vagliano v. Bank of England* [1891], A.C. 107; *M'Kenzie v. British Linen Co.* 6 A.C. 82; *Ewing v. Dominion Bank* [1904], A.C. 806). The doctrine of the fictitious person as payee may also exonerate a banker who has paid an order bill to a wrongful possessor. Payment on a forgery to an innocent holder is payment under mistake of fact; but the ordinary right of the payor to recover money so paid is subordinated to the necessity of safeguarding the characteristics of negotiability. Views differ as to whether the recovery is precluded only where the opportunity of giving notice of dishonour is lost or prejudiced by delay in reclaiming payment, or whether mere possibility of damage is sufficient (cf. *London & River Plate Bank v. Bank of Liverpool*

[1896], 1 Q.B. 7, and *Imperial Bank of Canada v. Bank of Hamilton* [1903], A.C. 49).

Cases have frequently arisen where the carelessness of a customer in filling up cheques has enabled a person to fraudulently increase the sum for which such cheques were originally drawn. In *Colonial Bank of Australasia v. Marshall* [1906], A.C. 550, the judicial committee of the privy council held that the affording such facilities for forgery was no breach of the customer's duty to his banker, and that the latter was not entitled to debit the customer with more than the original amount. As before stated, the customer's dealings with the pass-book cannot, in the present state of the authorities, be relied on as debarring him from disputing unauthorized payments appearing therein.

The payment of bills accepted payable at the bank is not, like the payment of cheques, an essential obligation of the banker, and the risk involved is enhanced by the fact that the banker must pay or refuse payment at once, no interval being allowed for verification of endorsements. The abolition or modification of the practice has frequently been advocated, but it is one of the facilities which competition compels bankers to extend to their customers. On the same basis stands the receipt of a customer's valuables for safe custody. The question of the banker's responsibility for the loss of goods so deposited with him was raised, but not decided, in an action brought by Mrs Langtry against the Union Bank of London in 1896. Certain jewels belonging to her had been delivered up by the bank to an unauthorized person on a forged order. The case was settled; but bankers being desirous to ascertain their real position, many legal opinions were taken on the point, and after consideration of these, the Central Association of Bankers issued a memorandum, in which they stated that the best legal opinion appeared to be that a distinction must be drawn between cases in which valuables were by mistake delivered to the wrong person and cases in which they were destroyed, lost, stolen or fraudulently abstracted, whether by an officer of the bank or some other person. That in the former case the question of negligence did not arise, the case being one of wrongful conversion of the goods by a voluntary act for which the bank was liable apart from any question of negligence. That, in the second case, that of loss or theft, the banker, being a gratuitous bailee, would only be liable if he had failed to use such care as an ordinary prudent man would take of valuables of his own. The latter rule is practically that laid down in *Giblin v. MacMullen*, L.R. 2 P.C. 318, but in estimating the amount of care to be taken by the banker, the nature of the goods, if known or suspected, and the exceptional means of protection at the disposition of bankers, such as strong-rooms, must be taken into consideration. Methods of obviating both classes of risk by means of special receipts have frequently been suggested, but such receipts do not appear to have come into general use.

Theoretically, bankers are supposed to refuse accounts which are either expressly or are known to be trust accounts. In practice, however, it is by no means uncommon to find accounts opened with a definite heading indicating the fiduciary capacity. In other cases, circumstances exist which affect the banker with notice of that capacity. In either case, however, the obligation to honour the customer's cheque is the predominant factor, and the banker is not bound or entitled to question the propriety or object of the cheque, unless he has very clear evidence of impending fraud (*Gray v. Johnston*, L.R. 3 H. of L. 1). Even though the banker have derived some personal benefit from the transaction, it cannot be impeached unless the banker's conduct amount in law to his being party or privy to the fraud, as where he has stipulated, or pressed for the settlement or reduction of an ascertained overdraft on private account, which has been effected by cheque on the trust account (*Coleman v. Bucks & Oxon Union Bank* [1897], 2 Ch. 243). A banker is entitled, in dealing with trust moneys, known to be such, to insist on the authority of the whole body of trustees, direct and not deputed, and this is probably the safest course to adopt. Scarcely larger responsibility devolves on Joint Stock Banks appointed custodian trustees under the Public Trust Act 1906,

Custody of
valuables.

Trustees.

a remunerative position involving custody of trust funds and securities, and making and receiving payments on behalf of the estate, while leaving the active direction thereof in the hands of the managing trustees.

Other incidents of the ordinary practice of banking are the discounting of bills, the keeping of deposit accounts, properly so called, and the making of advances to customers, either by way of definite loan or arranged overdraft.

Bill-discounting. So far as the discounting of bills is concerned, there is little to differentiate the position of the banker from that of any ordinary bill-discounter. It has been contended, however, that the peculiar attribute of the banker's lien entitled him to hold funds of the customer against his liability on current discounted bills. This contention was ultimately disposed of by *Bowen v. Foreign & Colonial Gas Company*, 22 W.R. 740, where it was pointed out that the essential object of a customer's discounting bills with his banker was to feed the current account, and that a possible liability constituted no set-off against an existing debt. Whether a particular bill has been taken for discount or collection is a question of fact. As in the payment of bills, so in the collection of them, there is no statutory protection whatever for the banker; as against third parties he can only rely either on the customer's title or his own as a holder for value, if no forged endorsement intervene and he can establish a consideration.

A deposit account, whether at call or on fixed notice, does not constitute any fiduciary relation between the depositor and the banker, but merely a debt due from the latter to the former.

Deposit accounts. It has been suggested that cheques can be drawn against deposit account on call, and, though a banker might safely honour such a cheque, relying, if necessary, on his right of lien or set-off, there appears no legal right in the customer to enforce such payment. Deposit receipts given by bankers are exempt from stamp duty, even though they contain an undertaking with respect to payment of principal and interest. They are clearly not negotiable instruments, but it is difficult to deduce from the cases how far dealings with them may amount to an equitable assignment of the moneys they represent. Probably deliberate definite transfer, coupled with endorsement, would confer an effective title to such moneys. Where, as is not uncommon, the form of deposit note includes a cheque, the banker could not refuse to pay were the cheque presented and any superadded formalities complied with.

There is no obligation on a banker to permit his customer to overdraw, apart from agreement express or implied from course of business. Drawing a cheque or accepting

Overdrafts and advances. a bill payable at the banker's which there are not funds to meet is an implied request for an overdraft, which the banker may or may not comply with. Interest is clearly chargeable on overdrafts whether stipulated for or not.

There is no direct authority establishing this right in the banker, and interest is not usually recoverable on mere debts, but the charge is justifiable on the ground of the universal custom of bankers, if not otherwise. The charging of compound interest or interest with periodical rests has been supported where such system of keeping the accounts has been brought to the notice of the customer by means of the pass-book, and not objected to by him, but in the present attitude of the courts towards the pass-book some further recognition would seem necessary. Such system of charging interest, even when fully recognized, only prevails so long as the relation of banker and customer, on which it is founded, continues in force; the taking a mortgage for the existing debt would put an end to it.

The main point in which advances made by bankers differ from those made by other people is the exceptional right possessed by bankers of securing repayment by means of the banker's lien. The banker's lien is part of the law merchant and entitles him, in the absence of agreement express or implied to the contrary, to retain and apply, in discharge of the customer's liability to him, any securities of the customer coming into his possession in his capacity as banker. It includes bills and cheques paid in for collection (*Currie v.*

Misa, 1 A.C. 564). Either by virtue of it, or his right of set-off, the banker can retain moneys paid in by or received for the credit of the customer, against the customer's debt to him. Goods deposited for safe custody or moneys paid in to meet particular bills are exempt from the lien, the purpose for which they come to the banker's hands being inconsistent with the assertion of the lien. The existence of the banker's lien entitles him to sue all parties to bills or cheques by virtue of sec. 27, subs. 3 of the Bills of Exchange Act, and to the extent of his advances his title is independent of that of the previous holder. Moreover, the banker's lien, though so termed, is really in effect an implied pledge, and confers the rights of realization on default pertaining to that class of bailment. But with regard to the exercise of his lien, as in many other phases of his relation to his customer, the banker's strict rights may be curtailed or circumscribed by limitations arising out of course of business. The principle, based either on general equity or estoppel and independent of definite agreement or consideration, requires that when dealings between banker and customer have for a reasonable space of time proceeded on a recognized footing, the banker shall not suddenly break away from such established order of things and assert his strict legal rights to the detriment of the customer. By the operation of this rule, the banker may be precluded from asserting his lien in particular cases, as for instance for an overdraft on one account against another which had habitually been kept and operated on separately. It equally prevents the dishonouring of cheques in circumstances in which they have hitherto been paid independent of the actual available balance.

Restrictions arising from course of business can of course be put an end to by the banker, but only on reasonable notice to the customer and by providing for outstanding liabilities undertaken by the latter in reliance on the continuance of the pre-existing state of affairs (see *Buckingham v. London & Midland Bank*, 12 Times L.R. 70). As against this, the banker can, in some cases, fortify his position by appeal to the custom of bankers. The validity of such custom, provided it be general and reasonable, has frequently been recognized by the courts. Any person entering on business relations with a banker must be taken to contemplate the existence of such custom and implicitly agree that business shall be conducted in accordance therewith. Practical difficulty has been suggested with regard to proof of any such custom not already recognized in law, as to how far it can be established by the evidence of one party, the bankers, unsupported by that of members of the outside public, in most cases impossible to obtain. It is conceived, however, that on the analogy of local custom and the Stock Exchange rules, such outside evidence could be dispensed with, and this is the line apparently indicated with relation to the pass-book by the court of appeal in *Vagliano's case* (23 Q.B.D. at p. 245). The unquestionable right of the banker to summarily debit his customer's account with a returned cheque, even when undorsed by the customer and taken by the banker in circumstances constituting him a transferee of the instrument, is probably referable to a custom of this nature. So is the common practice of bankers to refuse payment of a so-called "stale" cheque, that is, one presented an unreasonable time after its ostensible date; although the fact that some banks treat a cheque as stale after six months, others not till after twelve, might be held to militate against the validity of such custom, and lapse of time is not included by the Bills of Exchange Act among the matters working revocation of the banker's duty, and authority to pay his customer's cheque. Indirectly, this particular custom obtains some support from sec. 74 (2) of the Bills of Exchange Act, although the object of that section is different.

That section does, however, import the custom of bankers into the reckoning of a reasonable time for the presentation of a cheque, and with other sections clears up any doubts which might have arisen on the common law as to the right of the holder of a cheque, whether crossed or not, to employ his banker for its collection, without imperilling his rights against prior parties in case of dishonour. On dishonour of a cheque paid in for

collection, the banker is bound to give notice of dishonour. Being in the position of an agent, he may either give notice to his principal, the customer, or to the parties liable on the bill. The usual practice of bankers has always been to return the cheque to the customer, and sec. 49, subs. 6 of the Bills of Exchange Act is stated to have been passed to validate this custom. Inasmuch as it only provides for the return of the dishonoured bill or cheque to the drawer or an endorser it appears to miss the case of a cheque to bearer or become payable to bearer by blank endorsement prior to the customer's.

Where a bank or a banker takes a mortgage, legal or equitable, or a guarantee as cover for advances or overdraft, there is nothing necessarily differentiating the position from that of any other mortgage or guaranteed party. It has, however, fallen to banks to evoke some leading decisions with respect to the former class of security. In *London Joint Stock Bank v. Simmons* (1892), A.C. 201 the House of Lords, professedly explaining their previous decision in *Sheffield v. London Joint Stock Bank*, 13 A.C. 333, determined that negotiable securities, commercial or otherwise, may safely be taken in pledge for advances, though the person tendering them is, from his known position, likely to be holding them merely as agent for other persons, so long as they are taken honestly and there is nothing tangible, outside the man's position, to arouse suspicion. So again in *Lloyd's Bank v. Cooke* [1907], 1 K.B. 794, the bank vindicated the important principle that the common law of estoppel still obtains with regard to bills, notes and cheques, save where distinctly annulled or abrogated by the Bills of Exchange Act, and that therefore a man putting inchoate negotiable instruments into the hands of an agent for the purpose of his raising money thereon is responsible to any one taking them bona fide and for value, although the agent may have fraudulently exceeded and abused his authority and the case does not fall within the provisions of the Bills of Exchange Act.

With regard to guarantees, the main incidents peculiarly affecting bankers are the following. The existence of a guarantee does not oblige the banker to any particular system of keeping the account. So long as it is not unfairly manipulated to the detriment of the guarantor, there is no obligation to put moneys paid in, without appropriation, to the guaranteed rather than to the unguaranteed account, and on the termination of a guarantee, the banker may close the account, leaving it to be covered by the guarantee, and open a new one with the customer, to which he may devote payments in, not otherwise appropriated. Where by its nature or terms a continuing guarantee is revocable either summarily or on specified notice, difficult questions may arise on such revocation as to the banker's duty and obligations towards the customer, who has probably incurred liabilities on the strength of the credit afforded by the guarantee. Although the existence of a guarantee does not bind the banker to advance up to the prescribed limit, he could not well, on revocation, immediately shut off all facilities from the customer without notice, while subsequent purely voluntary advances might not be covered by the guarantee. These contingencies should therefore be fully provided for by the guarantee, particularly the crucial period of the pendency of notice.

AUTHORITIES.—The Institute of Bankers (London), *Questions on Banking Practice* (6th ed., 1909); J. Douglas Walker, *A Treatise on Banking Law* (2nd ed., 1885); Chalmers, *Bills of Exchange* (7th ed., 1909); Sir J. R. Paget, *The Law of Banking* (2nd ed., 1908); H. Hart, *The Law of Banking* (2nd ed., 1906). (J. R. P.)

BANKSIA, an Australian genus of shrubs and trees (natural order Proteaceae), with leathery leaves often deeply cut and handsome dense spikes of flowers. It is named after Sir Joseph Banks (q.v.). The plants are grown in England for their handsome foliage as evergreen greenhouse shrubs.

BANKURA, a town and district of British India, within the Burdwan division of Bengal. The town has a population of 20,737. The district has an area of 2621 sq. m., and in 1901 its population was 1,116,411, showing an increase of 4% in the decade. It is bounded on the N. and E. by Burdwan district;

on the S. by Midnapur district; and on the W. by Manbhurn district. Bankura forms a connecting link between the delta of the Ganges on the E. and the mountainous highlands of Chota Nagpur on the W. Along its eastern boundary adjoining Burdwan district the country is flat and alluvial, presenting the appearance of the ordinary paddy lands of Bengal. Going N. and W., however, the surface gradually rises into long undulating tracts; rice lands and swamps give way to a region of low thorny jungle or forest trees; the hamlets become smaller and more scattered, and nearly disappear altogether in the wild forests along the western boundary. Large quantities of lac and tussur silk are gathered in the hilly tract. The stone quarries and minerals are little worked. There are indigo factories and two coal-mines. Both cotton and silk are woven, and plates, &c., are carved from soap-stone. The old capital of the country was at Bishnupur, which is still the chief centre of local industries. The north-east part of the district is skirted by the East Indian railway beyond the river Damodar. The Midnapur-Jherria line of the Bengal-Nagpur railway passes through the district, and there is a line from Howrah to Bankura. The climate of Bankura is generally healthy, the cold season being bracing, the air wholesome and dry, and fogs of rare occurrence. The district is exposed to drought and also to destructive floods. It suffered in the famines of 1866, 1874-1875 and 1896-1897. The temperature in the hot season is very oppressive and relaxing. The Bishnupur raj was one of the largest estates in Bengal in the end of the 18th century, but it was sold for arrears of revenue shortly after the conclusion of the permanent settlement in 1793.

BANN, the principal river in the north of Ireland. Rising in the Mourne mountains in the south of the Co. Down it runs N.W. until it enters Lough Neagh (q.v.), which it drains N.N.W. to an estuary at Coleraine, forming Lough Beg immediately below the larger lough. The length of its valley (excluding the lesser windings of the river) is about 90 m. The total drainage area, including the other important feeders of Lough Neagh, is about 2300 sq. m., extending westward to the confines of the Co. Fermanagh, and including parts of the Cos. Down and Antrim, Armagh and Monaghan, Tyrone and Londonderry. The river has valuable salmon fisheries, but is not of much importance for navigation. Above Lough Neagh it is known as the Upper Bann and below as the Lower Bann.

BANNATYNE, GEORGE (1545?-1608), collector of Scottish poems, was a native of Newtyle, Forfarshire. He became an Edinburgh merchant and was admitted a burghess in 1587. Some years earlier, in 1568, when the "pest" raged in the capital, he retired to his native county and amused himself by writing out copies of poems by 15th and early 16th century Scots poets. His work extended to eight hundred folio pages, divided into five parts. The MS. descended to his only daughter Janet, and later to her husband's family, the Foulises of Woodhall and Ravelston, near Edinburgh. From them it passed to the Advocates' library, where it is still preserved. This MS., known as the "Bannatyne Manuscript," constitutes with the "Alosan" and "Maitland Folio" MSS. the chief repository of Middle Scots poetry, especially for the texts of the greater poets Henryson, Dunbar, Lyndsay and Alexander Scott. Portions of it were reprinted (with modifications) by Allan Ramsay in his *Ever Green* (1724), and later, and more correctly, by Lord Hailes in his *Ancient Scottish Poems* (1770). The entire text was issued by the Hunterian Club (1873-1902) in a handsome and generally accurate form. The name of Bannatyne was honoured in 1823 by the foundation in Edinburgh of the Bannatyne Club, devoted to the publication of historical and literary material from Scottish sources. The thirty-third issue of the club (1829) was *Memorials of George Bannatyne* (1545-1608), with a memoir by Sir Walter Scott and an account of the MS. by David Laing.

See also Gregory Smith, *Specimens of Middle Scots* (1902).

BANNERET (Fr. *bannetel*, from *bannière*, banner, elliptical for *seigneur* or *chevalier banneret*, Med. Lat. *bannercetus*), in feudalism, the name given to those nobles who had the right to lead their vassals to battle under their own banner. Ultimately bannerets obtained a place in the feudal hierarchy between

barons and knights bachelors, which has given rise to the idea that they are the origin of King James I.'s order of baronets. Selden, indeed, points out that "the old stories" often have *baronetti* for *bannereti*, and he points out that in France the title had become hereditary; but he himself is careful to say (p. 68c) that banneret "hath no relation to this later title." The title of knight banneret, with the right to display the private banner, came to be granted for distinguished service in the field. "No knight banneret," says Selden, of the English custom, "can be created but in the field, and that, when either the king is present, or at least his royal standard is displayed. But the creation is almost the self-same with that in the old French ceremonies by the solemn delivery of a banner charged with the arms of him that is to be created, and the cutting of the end of the pennon or streamer to make it a square or into the shape of a banner in case that he which is to be created had in the field his arms on a streamer before the creation." The creation of bannerets is traceable, according to Selden, to the time of Edward I. "Under these bannerets," he adds, "divers knights bachelors and esquires usually served; and according to the number of them, the bannerets received wages." The last authentic instance of the creation of a knight banneret was that of John Smith, created banneret at the battle of Edgchill by Charles I. for rescuing the royal standard from the enemy.

See Selden, *Titles of Honor* (3rd ed., London, 1672), p. 656; Du Cange, *Glossarium* (Niort, 1883), s.v. "Bannereti."

BANNERS, FEAST OF (Jap. *Nobori-no-Sekku*), a Japanese festival in honour of male children held on the 5th of May. Every householder who has sons fastens a bamboo pole over his door and hangs from it gaily-coloured paper fishes, one for each of his boys. These fishes are made to represent carp, which are in Japanese folklore symbolical of health and longevity. The day is recognized as a national holiday.

For banners in general see FLAG.

BANNISTER, CHARLES (1738-1804), English actor and singer, was born in Gloucestershire, and after some amateur and provincial experience made his first London appearance in 1762 as Will in *The Orators* at the Haymarket. Gifted with a fine bass voice, Bannister acquired a reputation as a singer at Ranelagh and elsewhere, as well as an actor, and was received with such favour that Garrick engaged him for Drury Lane. He died on the 26th of October 1804.

His son JOHN BANNISTER (1760-1836), born at Deptford on the 12th of May 1760, first studied to be a painter, but soon took to the stage. His first formal appearance was at the Haymarket in 1778 as Dick in *The Apprentice*. The same year at Drury Lane he played in James Miller's version of Voltaire's *Mahomet* the part of Zaphna, which he had studied under Garrick. The *Palмира* of the cast was Mrs Robinson ("Perdita"). Bannister was the best low comedian of his day. As manager of Drury Lane (1802) he was no less successful. He retired in 1815 and died on the 7th of November 1836. He never gave up his taste for painting, and Gainsborough, Morland and Rowlandson were among his friends.

See Adolphus's *Memoirs of John Bannister* (2 vols., 1838).

BANNOCK (adapted from the Gaelic, and apparently connected with Lat. *panis*, bread), the term used in Scotland and the north of England for a large, flattish, round sort of bun or cake, usually made of barley-meal, but also of wheat, and sometimes with currants.

BANNOCK, the name of a county in the south-east of the state of Idaho, U.S.A., and of a river in the same state, which runs northward in Oneida county into the Snake or Lewis river. It is taken from that of the Bannock Indians (see BANATE), a corruption of the native *Panaiti*.

BANNOCKBURN, a town of Stirlingshire, Scotland. Pop. (1901) 2444. It is situated on the "burn" from which its name is derived, the Bannock (Gaelic, *ban oc*, "white, shining stream"), a right-hand affluent of the Forth, which was once a considerable river. The town lies 2½ m. S.S.E. of Stirling by the Caledonian railway, and now has thriving manufactures of woollens (chiefly

tweeds, carpets and tartans) and leather, though at the beginning of the 19th century it was only a village. The Bore Stone, in which Bruce planted his standard before the battle in which he defeated Edward II. in 1314 (see below), is preserved by an iron grating. A mile to the west is the Gillies' Hill, now finely wooded, over which the Scots' camp-followers appeared to complete the discomfiture of the English, to which event it owes its name. Bannockburn House was Prince Charles Edward's headquarters in January 1746 before the fight at Falkirk.

The famous battle of Bannockburn (24th June 1314) was fought for the relief of Stirling Castle, which was besieged by the Scottish forces under Robert Bruce. The English governor of Stirling had promised that, if he were not relieved by that date, he would surrender the castle, and Edward II. hastily collected an army in the northern and midland counties of England. Bruce made no attempt to defend the border, and selected his defensive position on the Bannock Burn, 2½ m. S. of Stirling. His front was covered by the marshy bed of the stream, his left flank by its northerly bend towards the Forth, his right by a group of woods, behind which, until the English army appeared, the Scots concealed themselves. Two corps were left in the open in observation, one at St Ninian's to watch the lower course of the burn, one to guard the point at which the Falkirk-Stirling road crosses the burn. On the 23rd the van of the army of Edward, which numbered about 60,000 against the 40,000 of the Scots, appeared to the south of the burn and at once despatched two bodies of men towards Stirling, the first by the direct road, the other over the lower Bannock Burn near its junction with the Forth. The former was met by the Scottish outpost on the road, and here occurred the famous single combat in which Robert Bruce, though not fully armed for battle, killed Sir Henry Bohun. The English corps which took the other route was met and after a severe struggle defeated by the second Scottish outpost near St Ninian's. The English army assembled for battle on the following day. Early on St John's day the Scottish army took up its assigned positions. Three corps of pikemen in solid masses formed the first line, which was kept out of sight behind the crest until the enemy advanced in earnest. A line of "pottes" (military pits) had been previously dug to give additional protection to the front, which extended for about one mile from wing to wing. The reserve under Bruce consisted of a corps of pikemen and a squadron of 500 chosen men-at-arms under Sir Robert Keith, the marischal of Scotland. The line of the defenders was unusually dense; Edward, in forming up on an equal front with greatly superior numbers, found his army almost hopelessly cramped. The attacking army was formed in an unwieldy mass of ten "battles," each consisting of horse and foot, and the whole formed in three lines each of three "battles," with the tenth "battle" as a reserve in rear. In this order the English moved down into the valley for a direct attack, the cavalry of each "battle" in first line, the foot in second. Ignoring the lesson of Falkirk (*q.v.*), the mounted men rode through the morass and up the slope, which was now crowned by the three great masses of the Scottish pikemen. The attack of the English failed to make any gap in the line of defence, many knights and men-at-arms were injured by falling into the pits, and the battle became a *mêlée*, the Scots, with better fortune than at Falkirk and Flodden, presenting always an impenetrable hedge of spears, the English, too stubborn to draw off, constantly trying in vain to break it down. So great was the press that the "battles" of the second line which followed the first were unable to reach the front and stood on the slope, powerless to take part in the battle on the crest. The advance of the third English line only made matters worse, and the sole attempt to deploy the archers was crushed with great slaughter by the charge of Keith's mounted men. Bruce threw his infantry reserve into the battle, the arrows of the English archers wounded the men-at-arms of their own side, and the remnants of the leading line were tired and disheartened when the final impetus to their rout was given by the historic charge of the "gillies," some thousands of Scottish camp-followers who suddenly emerged from the woods, blowing horns, waving such weapons as they possessed, and holding aloft

improvised banners. Their cries of "slay, slay!" seemed to the wearied English to betoken the advance of a great reserve, and in a few minutes the whole English army broke and fled in disorder down the slope. Many perished in the burn, and the demoralized fugitives were hunted by the peasantry until they re-crossed the English border. One earl, forty-two barons and bannerets, two hundred knights, seven hundred esquires and probably 10,000 foot were killed in the battle and the pursuit. One earl, twenty-two barons and bannerets and sixty-eight knights fell into the hands of the victors, whose total loss of 4000 men included, it is said, only two knights.

See J. E. Shearer, *Fact and Fiction in the Story of Bannockburn* (1909).

BANNIS OF MARRIAGE (formerly *bannes*, from A.S. *gebann*, proclamation, Fr. *ban*, Med. Lat. *bannum*), the public legal notice of an impending marriage. The church in earliest days was forewarned of marriages (Tertullian, *Ad Uxorern*, *De Pudicitia*, c. 4). The first canonical enactment on the subject in the English church is that contained in the 11th canon of the synod of Westminster in London (A.D. 1200), which orders that "no marriage shall be contracted without banns thrice published in the church, unless by special authority of the bishop." It is, however, believed that the practice was in France as old as the 9th century, and certainly Odo, bishop of Paris, ordered it in 1176. Some have thought that the custom originated in the ancient rule that all "good knights and true," who elected to take part in the tournaments, should hang up their shields in the nearest church for some weeks before the opening of the lists, so that, if any "impediment" existed, they might be "warned off." By the Lateran Council of 1215 the publication of banns was made compulsory on all Christendom. In early times it was usual for the priest to betroth the pair formally in the name of the Blessed Trinity; and sometimes the banns were published at vespers, sometimes during mass. In the United Kingdom, under the canon law and by statute, banns are the normal preliminary to marriage; but a marriage may also be solemnized without the publication of banns, by obtaining a licence or a registrar's certificate. In America there is no statutory requirement; and the practice of banns (though general in the colonial period) is practically confined to the Roman Catholics.

BANNU, a town and district of British India, in the Derajat division of the North-West Frontier Province. The town (also called Edwardesabad and Dhulipnagar) lies in the north-west corner of the district, in the valley of the Kurram river. Pop. (1901) 14,300. It forms the base for all punitive expeditions to the Tochi Valley and Waziri frontier.

The district of Bannu, which only consists of the Bannu and Marwat tahsils since the constitution of the North-West Frontier Province in 1901, contains an area of 1680 sq. m. lying north of the Indus. The cis-Indus portions of Bannu and Dera Ismail Khan now comprises the new Punjab district of Mianwali. In addition to the Indus the other streams flowing through the district are the Kurram (which falls into the Indus) and its tributary the Gambila. The valley of Bannu proper, stretching to the foot of the frontier hills, forms an irregular oval, measuring 60 m. from north to south and about 40 m. from east to west. In 1901 the population was 231,485, of whom the great majority were Mahomedans. The principal tribes inhabiting the district are: (1) Waziri Pathans, recent immigrants from the hills, for the most part peaceable and good cultivators; (2) Marwats, a Pathan race, inhabiting the lower and more sandy portions of the Bannu valley; (3) Bannuchis, a mongrel Afghan tribe of bad physique and mean vices. The inhabitants of this district have always been very independent and stubbornly resisted the Afghan and Sikh predecessors of the British. After the annexation of the Punjab the valley was administered by Herbert Edwardes so thoroughly that it became a source of strength instead of weakness during the Mutiny. The inhabitants of the valley itself are now peaceful, but it is always subject to incursion from the Waziri tribes in the Tochi valley and the neighbouring hills. Salt is quarried on government account at Kalabagh and alum is largely obtained in the same neighbourhood. The chief export is wheat. A military road leads

from Bannu town towards Dera Ismail Khan. The Indus, which is nowhere bridged within the district, is navigable for native boats throughout its course of 76 m. The chief frontier tribes on the border are the Waziris, Battannis and Dawaris. All these are described under their separate names.

BANSDA, a native state in the south Gujarat division of Bombay, India, belonging to the Surat agency. Area, 215 sq. m. Pop. (1901) 40,382, showing a decrease of 2% in the decade; estimated revenue £19,508. Its chief is a rajput. About half the total area of the state is cultivable, but the bulk is forested.

BANSHEE (Irish *bean sidhe*; Gaelic *ban sih*, "woman of the fairies"), a supernatural being in Irish and general Celtic folklore, whose mournful screaming, or "keening," at night is held to foretell the death of some member of the household visited. In Ireland legends of the banshee belong more particularly to certain families in whose records periodic visits from the spirit are chronicled. A like ghostly informer figures in Brittany folklore. The Irish banshee is held to be the distinction only of families of pure Milesian descent. The Welsh have the banshee under the name *gwrach y Rhifyn* (witch of Rhifyn). Sir Walter Scott mentions a belief in the banshee as existing in the highlands of Scotland (*Demonology and Witchcraft*, p. 351). A Welsh death-portent often confused with the *gwrach y Rhifyn* and banshee is the *cyhyraeth*, the groaning spirit.

See W. Wirt Sikes, *British Goblins* (1880).

BANSWARA (literally "the forest country"), a rajput feudatory state in Rajputana, India. It borders on Gujarat and is bounded on the N. by the native states of Dungarpur and Udaipur or Mewar; on the N.E. and E. by Partabgarh; on the S. by the dominions of Holkar and the state of Jabua; and on the W. by the state of Rewa Kantha. Banswara state is about 45 m. in length from N. to S., and 33 m. in breadth from E. to W., and has an area of 1946 sq. m. The population in 1901 was 165,350. The Mahi is the only river in the state and great scarcity of water occurs in the dry season. The Banswara chief belongs to the family of Udaipur. During the vigour of the Delhi empire Banswara formed one of its dependencies; and on its decline the state passed under the Maharrattas. Wearied out by their oppressions, its chief in 1812 petitioned for English protection, on the condition of his state becoming tributary on the expulsion of the Maharrattas. The treaty of 1818 gave effect to this arrangement, Britain guaranteeing the prince against external enemies and refractory chiefs; he, on his part, pledging himself to be guided by her representative in the administration of his state. The chief is assisted in the administration by a *hamdar* or minister. The estimated gross revenue is £17,000 and the tribute £2500. The custom of suttee, or widow-burning, has long been abolished in the state, but the people retain all their superstitions regarding witches and sorcery; and as late as 1870, a Bhl woman, about eighty years old, was swung to death at Kushalgarh on an accusation of witchcraft. The perpetrators of the crime were sentenced to five years' rigorous imprisonment, but they had the sympathy of the people on their side. The chief town is Banswara, situated about 8 m. W. of the Mahi river, surrounded by an old disused rampart and adorned by various Hindu temples, with the battlements of the chief's palace overlooking it. Its population in 1901 was 7038. The petty state of Kushalgarh is feudatory to Banswara.

BANTAM, the westernmost residency of the island of Java, Dutch East Indies, bounded W. by the Strait of Sunda, N. by the Java sea, E. by the residencies of Batavia and Preanger, and S. by the Indian Ocean. It also includes Princes Island and Dwars-in-den-veg ("right-into-the-way") Island in Sunda Strait, as well as several smaller islands along the coasts. Bantam had a population in 1897 of 709,339, including 302 Europeans, 1959 Chinese and 89 Arabs and other Asiatic foreigners. The natives are Sundanese, except in the northern or Serang division, where they are Javanese. The coast is low-lying and frequently marshy. The northern portion of the residency constitutes the most fertile portion, is generally flat with a hilly group in the middle, where the two inactive volcanoes, Karang and Pulosari,

are found, while the north-western corner is occupied by the isolated Gede Mountain. The southern portion is covered by the Kendang (Malay for "range") Mountains extending into the Preanger. The rivers are only navigable at their mouths. Various geysers and cold and warm sulphur springs are found in the centre of the residency, and on a ridge of the Karang Mountain is the large crater-lake Dano, a great part of which was drained by the government in 1835 for rice cultivation. Pulse (*kaching*), rice and coffee are the principal products of cultivation; but in the days of government culture sugar, indigo and especially pepper were also largely grown. The former considerable fishing and coasting trade was ruined by the eruption of Krakatoa in 1883, a large stretch of coast line and the seaport towns of Charingin and Anjer being destroyed by the inundation. The prosperity of the residency was further affected by a cattle plague in 1879, followed by a fever epidemic which carried off 50,000 people, and except in the rice season there is a considerable emigration of natives. Bantam contains five native regencies or territorial divisions, namely, Serang, Anjer, Pandeglang, Charingin, Lebak. The principal towns are Serang, the capital of the residency, Chilegon, Pandeglang, Menes and Rangkas Betug. The chief town, Serang, is situated $\frac{2}{3}$ m. from Bantam Bay on the high road from Batavia. The port of Serang is Karangantu, on Bantam Bay, and close by is the old ruined town of Bantam, once the capital of the kingdom of Bantam, and before the foundation of Batavia the principal commercial port of the Dutch East India Company. The ruins include the remains of the former pepper warehouses, the old factory, called Fort Speelwijk, belonging to the company, the fortified palace of the former sultans and a well-preserved mosque thought to have been built by the third Mahomedan ruler of Bantam about 1562-1576, and containing the tombs of various princes of Bantam. Before the Dutch conquest Bantam was a powerful Mahomedan state, whose sovereign extended his conquests in the neighbouring islands of Borneo and Sumatra. In 1595 the Dutch expelled the Portuguese and formed their first settlement. A British factory was established in 1603 and continued to exist till the staff was expelled in 1682. In 1683 the Dutch reduced the sultan to vassalage, built the fort of Speelwijk and monopolized the port, which had previously been free to all comers; and for more than a century afterwards Bantam was one of the most important seats of commerce in the East Indies. In 1811 after Batavia had surrendered to the British, Bantam soon followed; but it was restored to the Dutch in 1814. Two years later, however, they removed their chief settlement to the more elevated station of Serang, or Ceram, 7 m. inland, and in 1817 the ruin of Bantam was hastened by a fire. *

For "Bantam" fowls see POULTRY.

BANTIN, of BANTING, the native name of the wild ox of Java, known to the Malays as sapi-utan, and in zoology as *Bos (Bibos) sondaicus*. The white patch on the rump distinguishes the bantin from its ally the gaur (g.u.). Bulls of the typical bantin of Java and Borneo are, when fully adult, completely black except for the white rump and legs, but the cows and young are rufous. In Burma the species is represented by the tsaine, or h'saine, in which the colour of the adult bulls is rufous fawn. Tame bantin are bred in Bali, near Java, and exported to Singapore. (See BOVIDAE.)

BANTRY, a seaport, market-town and seaside resort of Co. Cork, Ireland, in the west parliamentary division, 58 m. S.W. of Cork by the Cork, Bandon & South Coast railway, on the bay of the same name. Pop. (1901) 3109. It is an important centre both for sea fisheries and for sport with the rod. It is the terminus of the railway, and a coaching station on the famous "Prince of Wales" route (named after King Edward VII.) from Cork to Glengarriff and Killarney. The bay, with excellent anchorage, is a picturesque inlet some 22 m. long by 3 to 6 broad, with 12 to 32 fathoms of water. It is one of the headquarter stations of the Channel Squadron, which uses the harbour at Castletown Bearhaven on the northern shore, behind Bear Island, near the mouth of the bay. It was the scene of attempts by the French to invade Ireland in 1689 and 1796, and troops of

William of Orange were landed here in 1697. There are several islands, the principal of which are Bear Island and Whiddy, off the town. Ruins of the so-called "fish palaces" testify to the failure of the pilchard fishery in the 18th century.

BANTU LANGUAGES. The greater part of Africa south of the equator possesses but one linguistic family so far as its native inhabitants are concerned. This clearly-marked division of human speech has been entitled the Bantu, a name invented by Dr W. H. I. Bleek, and it is, on the whole, the fittest general term with which to designate the most remarkable group of African languages.¹

It must not be supposed for a moment that all the people who speak Bantu languages belong necessarily to a special and definite type of negro. On the contrary, though there is a certain physical resemblance among those tribes who speak clearly-marked Bantu dialects (the Babangi of the upper Congo, the people of the Great Lakes, the Ova-herero, the Ba-tonga, Zulu-Kafirs, Awema and some of the East Coast tribes), there is nevertheless a great diversity in outward appearance, shape of head and other physical characteristics, among the negroes who inhabit Bantu Africa. Some tribes speaking Bantu languages are dwarfs or dwarfish, and belong to the group of Forest Pygmies. Others betray relationship to the Hottentots; others again cannot be distinguished from the most exaggerated types of the black West African negro. Yet others again, especially on the north, are of Gala (Galla) or Nilotic origin. But the general deduction to be drawn from a study of the Bantu languages, as they exist at the present day, is that at some period not more than 3000 years ago a powerful tribe of negroes speaking the Bantu mother-language, allied physically to the negroes of the south-western Nile and southern Lake Chad basins (yet impregnated with the Caucasian Hamite), pushed themselves forcibly from the very heart of Africa (the region between the watersheds of the Shari, Congo and western Nile) into the southern half of the continent, which at that time was probably sparsely populated except in the north-west, east and south. The Congo basin and the south-western watershed of the Nile at the time of the Bantu invasion would have been occupied on the Atlantic seaboard by West Coast negroes, and in the centre by negroes of a low type and by Forest Pygmies; the eastern coasts of Victoria Nyanza and the East African coast region down to opposite Zanzibar probably had a population partly Nilotic-negro and partly Hottentot-Bushman. From Lakes Tanganyika and Nyasa south-westwards to the Cape of Good Hope the population was Forest-negro, Nilotic-negro, Hottentot and Bushman. Over nearly all this area the Bantu swept; and they assimilated or absorbed the vast majority of the preceding populations, of which, physically or linguistically, the only survivors are the scattered tribes of pygmies in the forests of south-west Nile land, Congo basin and Gabun, the central Sudanese of the N.E. Congo, a few patches of quasi-Hottentot, Hamitic and Nilotic peoples between Victoria Nyanza and the Zanzibar coast, and the Bushmen and Hottentots of south-west Africa. The first area of decided concentration on the part of the Bantu was very probably Uganda and the shores of Tanganyika. The main line of advance south-westward rather to the east coast of Africa than to the west, but bifurcated at the south end of Lake Tanganyika, one great branch passing west between that lake and Nyasa, and the other southwards. Finally, when the Bantu had reached the

¹ Bantu (literally *Ba-ntu*) is the most archaic and most widely spread term for "men," "mankind," "people," in these languages. It also indicates aptly the leading feature of this group of tongues, which is the governing of the unchangeable root by prefixes. The syllable *-ntu* is nowhere found now standing alone, but it originally meant "object," or possibly "person." It is also occasionally used as a relative pronoun—"that," "that which," "he who." Combined with different prefixes it has different meanings. Thus (in the purer forms of Bantu languages) *mntu* means "a man," *bantu* means "men," *bintu* means "a thing," *bintu* "things," *kantu* means "a little thing," *tantu* "little things," and so on. This term Bantu has been often criticized, but no one has supplied a better, simpler designation for this section of Negro languages, and the name has now been definitely consecrated by usage.

south-west corner of Africa, their farther advance was checked by two causes: first, the concentration in a healthy, cattle-rearing part of Africa of the Hottentots (themselves only a superior type of Bushman, but able to offer a much sturdier resistance to the big black Bantu negroes than the crafty but feeble Bushmen), and secondly, the arrival on the scene of the Dutch and British, but for whose final intervention the whole of southern Africa would have been rapidly Bantuized, as far as the imposition of language was concerned.

The theory thus set forth of the origin and progress of the Bantu and the approximate date at which their great southern exodus commenced, is to some extent attributable to the present writer only, and has been traversed at different times by other writers on the same subject. In the nearly total absence of any historical records, the only means of building up Bantu history lies in linguistic research, in the study of existing dialects, of their relative degree of purity, of their connexion one with the other and of the most widely-spread roots common to the majority of the Bantu languages. The present writer, relying on linguistic evidence, fixed the approximate date at which the Bantu negroes left their primal home in the very heart of Africa at not much more than 2000 years ago; and the reason adduced was worth some consideration. It lay in the root common to a large proportion of the Bantu languages expressing the domestic fowl—*kuku* (*nkuku*, *ngoko*, *nsusu*, *nguku*, *uku*).

Now the domestic fowl reached Africa first through Egypt, at the time of the Persian occupation—not before 500 to 400 B.C. It would take at that time at least a couple of hundred years before—from people to people and tribe to tribe up the Nile valley—the fowl, as a domestic bird, reached the equatorial regions of Africa. The Muscovy duck, introduced by the Portuguese from Brazil at the beginning of the 17th century, is spreading itself over Negro Africa at just about the same rate. Yet the Bantu people must have had the domestic fowl well established amongst themselves before they left their original home, because throughout Bantu Africa (with rare exceptions and those not among the purest Bantu tribes) the root expressing the domestic fowl recurs to the one vocable of *kuku*.¹ Curiously enough this root *kuku* resembles to a marked degree several of the Persian words for "fowl," and is no doubt remotely derived from the cry of the bird. Among those Negro races which do not speak Bantu languages, though they may be living in the closest proximity to the Bantu, the name for fowl is quite different.² The fowl was only introduced into Madagascar, as far as researches go, by the Arabs during the historical period, and is not known by any name similar to the root *kuku*. Moreover, even if the fowl had been (and there is no record of this fact) introduced from Madagascar on to the east coast of Africa, it would be indeed strange if it carried with it to Cameroon, to the White Nile and to Lake Ngami one and the same name. It may, however, be argued that such a thing is possible, that the introduction of the fowl south of the equator need not be in any way coincident with the Bantu invasion, as its name in North Central Africa may have followed it everywhere among the Bantu peoples. But all other cases of introduced plants or animals do not support this idea in the least. The Muscovy duck, for instance, is pretty well distributed throughout Bantu Africa, but it has no common widely-spread name. Even tobacco (though the root "taba" turns up unexpectedly in remote parts of Africa) assumes totally different designations in different Bantu tribes. The Bantu, moreover, remained faithful to a great

¹ In Luḡanda and other languages of Uganda and the Victoria Nyansa, and also in Runyoro on the Victoria Nile, the word for "fowl" is *enkoko*. In Ki-Swahili of Zanzibar it is *kuku*. In Zulu it is *inkuku*. In some of the Cameroonian languages it is *lokoko*, *ngoko*, *ngok*, and on the Congo it is *nkoko*, *nsusu*. On the Zambezi it is *nkuku*; so also throughout the tribes of Lakes Nyasa and Tanganyika, and most dialects of South Africa.

² From this statement are excepted those tongues classified as "semi-Bantu." In some languages of the Lower Niger and of the Gold Coast the word for fowl is generally traceable to a root *kuba*. This form *kuba* also enters the Cameroonian region, where it exists alongside of *koko*. *Kuba* may have arisen independently, or have been derived from the Bantu *kuku*.

number of roots like "fowl," which referred to animals, plants, implements and abstract concepts known to them in their original home. Thus there are the root-words for ox (*nombe*, *-ombe*, *-nie*), goat (*-budi*, *-busi*, *-buri*), pig (*-guluba*), pigeon (*-jiba*), buffalo (*nyati*), dog (*mḡwa*), hippopotamus (*-bugu*, *gubu*), elephant (*-joko*, *-joko*), leopard (*ngwi*), house (*-zo*, *-do*, *-yumba*, *-onda*, *-dago*, *-dabo*), moon (*-lasi*), sun, sky, or God (*-juba*), water (*-ndi*, *-ndiba*, *mandiba*), creek or river (*-anza*); drum (*ngoma*), name (*-ina* or *jina*), wizard (*nganga*), belly, bowel (*-vu*, *-vumo*), buttocks (*-lako*); adjectives like *-bi* (bad), *-eru* (white); the numerals, 2, 3, 4, 5, 10 and 100; verbs like *fwa* (to die), *la* (to strike, kill), *la* (*da*) or *lia* (*dí*, *día*) (to eat). The root-words cited are not a hundredth part of the total number of root-words which are practically common to all the spoken dialects of Bantu Africa. Therefore the possession amongst its root-words of a common name for "fowl" seems to the present writer to show conclusively that (1) the original Bantu tribe must have possessed the domestic fowl before its dispersal through the southern half of Africa began, and that (2) as it is historically certain that the fowl as a domestic bird did not reach Egypt before the Persian conquest in 525 B.C., and probably would not have been transmitted to the heart of Africa for another couple of hundred years, the Bantu exodus (at any rate to the south of the equatorial region) may safely be placed at a date not much anterior to 2100 years ago.

The creation of the Bantu type of language (pronominal-prefix) was certainly a much more ancient event than the exodus from the Bantu mother-land. Some form of speech like Fula, Kiama (Tem), or Kposo of northern Togoland, or one of the languages of the lower Niger or Benue, may have been taken up by ancient Libyan, Hamite or Nilotic conquerors and cast into the type which we now know as Bantu,—a division of sexless Negro speech, however, that shows no obvious traces of Hamitic (Caucasian) influence. We have no clue at present to the exact birth-place of the Bantu nor to the particular group of dialects or languages from which it sprang. Its origin and near relationships are as much a puzzle as is the case with the Aryan speech. Perhaps in grammatical construction (suffixes taking the place of prefixes) Fula shows some resemblance; and Fula possesses the concord in a form considerably like that of the *Bantu*, as well as offering affinities in the numerals 3 and 4, and in a few nominal, pronominal and verbal roots. The Timne and cognate languages of Sierra Leone and the north Guinea coast use pronominal prefixes and a system of concord, the employment of the latter being precisely similar to the same practice in the Bantu languages; but in word-roots (substantives, numerals, pronouns, verbs) there is absolutely no resemblance with this north Guinea group of prefix-using languages. In the numerals 2, 3, 4, and sometimes 5, and in a few verbal roots, there is a distinct affinity between Bantu and the languages of N. Togoland, the Benue river, lower Niger, Calabar and Gold Coast. The same thing may be said with less emphasis about the Madi and possibly the Nyam-Nyam (Makaraka) group of languages in Central Africa though in none of these forms of speech is there any trace of the concord. Prefixes of a simple kind are used in the tongues of Ashanti, N. Togoland, lower Niger and eastern Niger delta, Cross River and Benue, to express differences between singular and plural, and also the quality of the noun; but they do not correspond to those of the Bantu type, though they sometimes fall into "classes." In the north-west of the Bantu field, in the region between Cameroon and the north-western basin of the Congo, the Cross river and the Benue, there is an area of great extent occupied by languages of a "semi-Bantu" character, such as Nki, Mbudikum, Akpa, Mbe, Bayoñ, Manyñ, Bafut and Bansho, and the Munshi, Jarawa, Kororota, Kamuku and Gbari of the central and western Benue basin. The resemblances to the Bantu in certain word-roots are of an obvious nature; and prefixes in a very simple form are generally used for singular and plural, but the rest of the concord is very doubtful. Here, however, we have the nearest relations of the Bantu, so far as

¹ Whence the many *nyansa*, *nyanja*, *nyasa*, *mwanza*, of African geography.

etymology of word-roots is concerned. Further evidence of slight etymological and even grammatical relationships may be traced as far west as the lower Niger and northern and western Gold Coast languages (and, in some word-roots, the Mandingo group). The Fula language would offer some grammatical resemblance if its suffixes were turned into prefixes (a change which has actually taken place in the reverse direction in the English language between its former Teutonic and its modern Romanized conditions; cf. "offset" and "set-off," "upstanding" and "standing-up").

The legends and traditions of the Bantu peoples themselves invariably point to a northern origin, and a period, not wholly removed from their racial remembrance, when they were strangers in their present lands. Seemingly the Bantu, somewhat early in their migration down the east coast, took to the sea, and not merely occupied the islands of Pemba and Zanzibar, but travelled as far afield as the Comoro archipelago and even the west coast of Madagascar. Their invasion of Madagascar must have been fairly considerable in numbers, and they doubtless gave rise to the race of black people known traditionally to the Hovas as the Va-zimba.

The accompanying map will show pretty accurately the distribution of the Bantu-speaking Negroes at the present day.

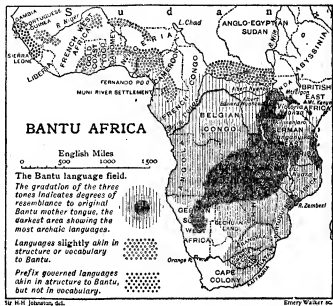

It will be seen by a glance at this map that the areas in which are spoken Bantu languages of typical structure and archaic form are somewhat widely spread. Perhaps on the whole the most archaic dialects at the present day are those of Mount Elgon, Ruwenzori, Unyoro, Uganda, the north coast of Tanganyika and of the Bemba country to the south-west of Tanganyika; also those in the vicinity of Lake Bangweulu, and the Nkonde and Kese dialects of the north and north-east coasts of Lake Nyasa; also (markedly) the Sibiya speech of the western Zambezi. Another language containing a good many original Bantu roots and typical features is the well-known Oci-herero of Damaraland (though this S.W. African group also presents marked peculiarities and some strange divergencies). Kimakonde, on the east coast of Africa, is a primitive Bantu tongue; so in its roots, but not in its prefixes, is the celebrated Ki-swahili of Zanzibar. Ci-bodzo of the Zambezi delta is also an archaic type of great interest. The Zulu-Kafir language, though it exhibits marked changes and deviations in vocabulary and phonetics (both probably of recent date), preserves a few characteristics of the hypothetical mother-tongue: so much so that, until the languages of the Great Lakes came to be known, Zulu-Kafir was regarded as the most archaic type of Bantu speech, a position from which it is now completely deposed. It is in some features unusually divergent from the typical Bantu.

Classification.—With our present knowledge of the existing Bantu tongues and their affinities, it is possible to divide them approximately into the following numbered groups and subdivisions, commencing at the north-eastern extremity of the Bantu domain, where, on the whole, the languages approximate nearest to the hypothetical parent speech.

(1) The *Uganda-Unyoro* group. This includes all the dialects between the Victoria Nile and Busoga on the east and north, the east coast of Lake Albert, the range of Ruwenzori and the Congo Forest on the west; on the south-east and south, the south coast of the Victoria Nyanza, and a line from near Emin Pasha Gulf to the Malagarazi river and the east coast of Tanganyika. On the south-west this district is bounded more or less by the Rusizi river down to Tanganyika. It includes the district of Busoga on the north-east and all the archipelagos and inhabited islands of the Victoria Nyanza even as far east as Bukere, except those islands near the north-east coast. The dialects of Busoga, the Keso Islands and the west coast of Lake Victoria are closely related to the language of the kingdom of Uganda. Allied to, yet quite distinct from the *Uganda* sub-section, is that which is usually classified as *Unyoro*.¹ This includes the dialects spoken by the Hima (Hamitic aristocracy of these equatorial lands—*Uru-hima, Ru-hinda, &c.*), *Ru-songora, Ru-iro, Ru-toro, Ru-tusi*, and all the kindred dialects of Karagwe, Busiba, *Ruanda*, Businja and Bukerebe. *Ki-rundi*, of the Burundi country at the north end of Tanganyika, and the other languages of eastern Tanganyika down to Ufipa are closely allied to the Unyoro sub-section of group 1, but perhaps adhere more closely to group 12. The third independent sub-section of this group is *Lu-konjo*, the language which is spoken on the southern flanks of the Ruwenzori Range and thence southwards to Lake Kivu and the eastern limits of the Congo Forest.

(2) The second group on the geographical list is *Lihuku-Kuamba*, the separate and somewhat peculiar Bantu dialects lingering in the lands to the south and south-west of Albert Nyanza (Mboza country). Lihuku (or Libvanuma) is a very isolated type of Bantu, quite apart from the *Uganda-Unyoro* groups, with which it shows no special affinity at all, though in close juxtaposition. Its alliance with *Kuamba* of western Ruwenzori is not very close. Other affinities are with the degraded Bantu dialects (*Ki-bira, &c.*) of the Iтури-Aruwimi forests. *Kuamba* is spoken on the west and north slopes of Ruwenzori. Both *Kuamba* and *Lihuku* show a marked relationship with the languages on the northern Congo and Aruwimi, less in grammar than in vocabulary.

(3) The *Kavirondo-Masaba* section. This group, which includes the *Lu-nyara, Lu-wanga, Lukonde* and *Igizi* of the north-east and eastern shores of the Victoria Nyanza and the northern Kavirondo and Mount Elgon territories, is related to the *Luganda* section more than to any other part of the Bantu tongue, but is a very distinct division, in its prefixes the most archaic. It includes the languages spoken along the western flanks of Mount Elgon, those of Bantu Kavirondo, and of the eastern coast-lands of the Victoria Nyanza (*Igizi*).

(4) The *Kikuyu-Kamba* group of British East Africa, east of the Rift valley. It includes, besides the special dialects of Kikuyu and Ukambani, all the scattered fragments of Bantu speech on Mount Kenya and the upper Tana river (*Dhaicho*).

(5) The *Kilimanjaro (Chaga-Siha)* group, embracing the rather peculiar dialects of Mount Kilimanjaro, Mount Meru and Ugweno.

(6) The *Pokomo-Nyika-Giriama-Taveita* group represents the Bantu dialects of the coast province of British East Africa, between (and including) the Tana river on the north and the frontier of German East Africa on the south.

(7) *Swahili*, the language of Zanzibar and of the opposite coast, a form of speech now widely spread as a commercial language over Eastern and Central Africa. Swahili is a somewhat archaic Bantu dialect, indigenous probably to the East African coast south of the Ruvu (Pangani) river, which by intermixture with Arabic has become the *lingua franca* of eastern Africa between the White Nile and the Zambezi. It was almost certainly of mainland origin, distinct from the original local dialects of Zanzibar and Pemba, which may have belonged to group No. 6. There are colonies of Swahili-speaking people at Mombasa, Malindi, Lamu, and even as far north as the Shebeli river in Somaliland, also along the coast of German and Portuguese East Africa as far south as Angoche. In the coast-lands between the Ruvu or Pangani river on the north and the Kilwa settlements on the south, the local languages and dialects are more or less related to Swahili, though they are independent languages. Amongst these may be mentioned *Bodzo, Shambala* (north of the Ruvu), *Nyuru, Zegaha, Ki-nrima* and *Ki-saromo*.

(8) This group might be described as *Kaguru-Sagala-Kami*. It is one which occupies the inland territories of German East Africa, between the Swahili coast dialects on the east and the domain of the Nyamwezi (No. 11) on the west. On the north this group is bounded by the non-Bantu languages of the Masai, Mbugu and Taturu, and on the south by the Kuaha river. This group includes *Kigogo* and *Irangi*.

¹ In using the forms *Uganda, Unyoro*, the writer accepts the popular mis-spelling. These countries should be called *Buganda* and *Bunyoro*, and their languages *Luganda* and *Runyoro*.

(9) The dialects of the Comoro Islands, between the East African coast and Madagascar, are styled *Hi-nua* or *Anzuani* and *Shi-nuaji*. They are somewhat closely related to Swahili.

(10) The archaic *Makonde* or *Mahiba* of the lower Ruvuma, and the coast between Lindi and Ibo; this might conceivably be attached to the Swahili branch.

(11) The *Nyamwezi* group includes all the dialects of the Nyamwezi country (Ugogo) as far north as the Victoria Nyanza (where the tongues melt into group No. 1), and bounded on the south by the Upper Ruaha river, and on the west by the eastern borderlands of Tanganyika. The Nyamwezi genus penetrates south-west to within a short distance of Lake Rukwa. A language of this group was at one time a good deal spoken in the southern part of the Belgian Congo, having been imported there by traders who made themselves chiefs.

(12) The *Tanganyika* languages (*Ki-rega*, *Kabwari*, *Kigaha*, &c.). These dialects are chiefly spoken in the regions west-north-west, and perhaps north and east of Tanganyika, from the vicinity of Lake Albert Edward on the north and the Lukuga outlet of Tanganyika on the south. On the west they are bounded by the Congo Forest and the Manyema genus (No. 13). The languages on the east coast of Tanganyika (*Ki-rundi*, *Kigye*, &c.) seem to be more nearly connected with those of group No. 1 (*Uganda-Unyoro*), yet perhaps they are more conveniently included here.

(13) The *Manyema* (*Baemya*) group includes most of the corrupt Bantu dialects in the western watershed of Tanganyika and the main stream of the Luapula Congo, extending also still farther north, and comprising (seemingly) the languages of the Aruwimi basin, such as *Yaluluwa*, *Soko*, *Lokele*, *Kusu*, *Tu-rumbu*, &c. On the west the Manyema group is bounded by the languages of the Lomami valley, which belong to groups Nos. 15 and 16; on the east the Manyema genus merges into the much purer Bantu dialects of groups Nos. 1 and 12. An examination of the Lihuku-Kuamba section (No. 2) shows these tongues to be connected with the Manyema group. The *Kibira* dialects of the north-eastern Congo Forest (Ituri district) may perhaps be placed in this section.¹

(14) The *Rua-Luba-Lunda-Marungu* group (in which are included *Kanyoka*, *Lulua* and *Ki-tabwa*) occupies a good deal of the south central basin of the Congo, and between the south-west coast-line of Tanganyika on the east and the main streams of the Kasai and Kwango on the west, between the Bakuba country on the north and the Zambezi watershed on the south.

(15) The *Bakuba* assemblage of Central Congo dialects (*Songe*, *Shilange*, *Babwama*, &c.) probably includes all the Bantu languages between the Lomami river on the east and the Kwa-Kasai and Upper Kwango on the west. Its boundary on the north is perhaps the Sankuru river.

(16) The *Baloko* group consists of all the languages of the Northern Congo bend (bounded on the north, east and west by the main stream of the Congo), and perhaps the corrupt dialects of the Northern Kasai, Kwilu and Kwango (*Babwama*, *Babwama*, *Bambala*, *Ba-yaka*, *Bakutu*, &c.), where these are not nearer allied to *Teke* (No. 18) or to *Bakuba*.

(17) The *Bangala-Bobangi-Liboko* group comprises the commercial languages of the Upper Congo (*Ngala*, *Bangi*, *Liboko*, *Poto*, *Ngombe*, *Yanzé*, &c.) and all the known Congo dialects along and to the north and sometimes south of the main stream, from as far west as the junction of the Sangha to as far east as the Rubi and Lomami rivers, and those between the Congo and the Lower Ubangi river and up the Ubangi, as far north as the limits of the Bantu domain (about 3° 30' N.). Allied to these perhaps are the scarcely-known forms of speech in the basin of the Sangha river, besides the "Ba-yanzi" dialects of Lakes Muntumbwa and Leopold II.

(18) The *Baeto* group. This may be taken roughly to include most of the Bantu dialects west of the Sangha river, north-west of the Lower Congo, south of the Upper Ogowe and Ngoko rivers and east of the Atlantic coast-lands.

(19) The *Di-Kele* and *Benga* dialects of Spanish Guinea and the *Batanga* coast of German Cameroon.

(20) The *Fañ* or *Pangwe* forms of speech (so corrupt as to be only just recognizable as Bantu), which occupy the little-known interior of German Cameroon and French Gabon, down to the Ogowe, and as far east as the Congo at its northern and north-eastern bend, and the immediate hinterland of the "Duala" Cameroon.

(21) The *Duala* group, which on the other hand is of a much purer Bantu type, includes the languages spoken on the estuary and delta of the Cameroon river.

(22) The *Isubu-Bakwiri* group of the coast-lands north of Cameroon delta (Ambas Bays), and on the west slopes of Cameroon Mts.

¹ It is an important and recently discovered fact (delineated in the work of the Baptist missionaries and of the African traveller Dr Franz Thonner) that the Congo at its northern and north-eastern bend, between the Rubi river and Stanley Falls, lies outside the Bantu field. The *Bondongo* and *Womanga* languages are not Bantu. They are allied to the *Mbuba-Momfu* of the Ituri and Nepoko, and also to the *Mundu* of the Egyptian Sudan. The *Mundu* group extends westward to the Ubangi river, as far south as 3° 30' N. See *George Grenfell and the Congo*, by Sir Harry Johnston; and *Dans la Grande Forêt de l'Afrique équatoriale*, by Franz Thonner (1899).

(23) The Bantu dialects of *Fernando Pó* (*Ediya*, *Bateli*, *Bani*, &c.) distantly allied to Nos 24, 2 and 13.

(24) The *Barondo-Bakundu* group, which begins on the north at the Rio del Rey on the extremity of the Bantu field, near the estuary of the Cross river. This group may also include *Borombi* and *Basá*, *Bohken*, *Abo*, *Nkosi* and other much-debased dialects, which are spoken on the eastern slopes of the Cameroon mountains and on the Cameroon river (Magembe), and through the Sangha and Nyong rivers. Eastwards and north-eastwards of this group, the languages (such as *Mbe*, *Bati*, *Nhi*, *Mundium*, *Bafu*, *Bayo*) may be described as "semi-Bantu," and evincing affinities with the forms of speech in the basin of the Central Benue river and also with the *Fañ* (No. 20).

(25) Turning southwards again from the north-westernmost limit of the Bantu, we meet with another group, the *Mpongwe-Orungu* and *Aduma* languages of French Gabon, and the tongues of the Lower Ogowe and Fernan Vaz promontory.

(26) These again shade on the south into the group of *Kabongo* dialects of the Loango and Sene Kamba coast—such as *Ba-bama*, *Ba-nyanga*, *Ma-yombo*, *Ba-viti*, *Ba-baka* and *Ka-kongo* (*Kabinda*).

(27) The *Kongo* language group comprises the dialects along the lower course of the Congo from its mouth to Stanley Pool; also the territory of the old kingdom of Congo, lying to the south of that river (and north of the river Loje) from the coast eastwards to the watershed of the river Kwango (and the longitude, more or less, of Stanley Pool).

(28) South of the Congo dialects melt imperceptibly into the closely-allied Angola languages. This group may be styled in a general way *Mbundu*, and it includes the languages of Central Angola, such as *Ki-mbundu*, *Mbamba*, *Ki-sama*, *Songo*, *U-mbanga*. The boundary of this genus on the east is probably the Kwango river, beyond which the Lunda languages begin (No. 14). On the north, the river Loje to some extent serves as a frontier between the *Kongo* and *Mbundu* tongues. On the south the boundary of group No. 28 is approximately the 11th degree of south latitude.

(29) Very distinct from the *Ki-mbundu* speech (though with connecting forms) is the *Oci-herero* group, which includes the *Herero* language of Damaraland, the *Umbundu* of the Bihe highlands of south Angola, the *Nano* of the Benguela coast, and *Si-donga*, *Kuanyama* and *Oci-mbo* of the southern regions of Portuguese Angola and the northern half of German South-West Africa. The languages of group No. 29 probably extend as far inland as the Kwito and Kubango rivers, in short, to the Zambezi watershed. On the south they are confronted with the Hottentot languages. The Haukon or *Hiti* Damaras—a Negro race of unexplained affinities and apparently formerly a Hottentot language—occupy an enclave in the area of *Herero* speech.

(30) What may be called the *Kiboko* or *Kibowe* (also *Kioko*) family of eastern Angola is a language-group which seems to offer affinities to the languages of the Upper Zambezi and to those of groups Nos. 28 and 29. It extends eastwards into the south-western portion of the Belgian Congo, and includes the *Lubale* of northern Barotseland and the sources of the river Zambezi, and possibly the *Gangela* of south-western Angola.

(31) Southwards of group No. 30 is that of the *Barotseland* languages, of which the best-known form—almost the only one that is effectively illustrated—is *Si-luyi*. To *Si-luyi* may be related the *Mabunda* of Western Barotseland. The dialects of the *Ambwela*, *A-mbwe*, *Ma-bukushu* and *A-bwamashi* are probably closely related.

(32) Next is a group which might be styled the *Subiya-Tonga-Ila*, though some authorities think that *Tonga* and *Ila* deserve to be ranked as an independent group. There is, however, a close alliance in structure between the languages of each of the two subsections. The *Tonga* subgroup would include the dialects of the *Ba-tetela*, the *Ba-ila* (*Mashukumbwe*) and all the Central African dialects. *Subiya* is the dominant language of South-West Zambesia, along a portion of the Zambezi river south of Barotseland, and in the lands lying between the Zambezi and the Chobe-Linyante river. *Subiya* is one of the most archaic of Bantu languages, more so than *Tonga*. Both are without any strong affinity to *Oci-herero*, and only evince a slight relationship with the Zulu group (No. 44).

(33) The *Bisa* or *Wisa* family includes the languages of Iramba, Bausi, Lukunga, in the southernmost projection of the Belgian Congo, and the *Ituri* region between the Ituri and the Chambure river and Lake Bangweulu on the north, and the Luangwa river on the east and south; perhaps also some of the languages along the course of the Upper Luapula river.

(34) With it is closely allied that of the *Bemba* or *Emba* dialects. This interesting genus occupies the ground between the south-west and south coasts of Tanganyika, Lake Mweru, and the Upper Chambure river. The *Ki-hemba* domain may be taken to include the locally-modified *Ki-lungu* and *Ki-mambwe* of South and South-East Tanganyika.

(35) What may be called the *North Nyasa* or *Nkonde* group comprises all the dialects of the north-west and north coasts of Lake Nyasa (such as *Ici-wandia* and *Iki-nyikusa*) and *Ishi-nyixa* of the Nyasa-Tanganyika plateau, and extends perhaps as far north west as the Fipa country (*Iki-fipa*), and the shores of Lake Rukwa (*Ici-wungu*) in the vicinity of the Nyamwezi domain (No. 11). *Iki-fipa*, however, has some affinities to the Tanganyika and western Victoria-Nyanza languages (groups Nos. 1 and 12).

(36) The western part of Nyasaland, south of group No. 35, is occupied by the *Tumbuka* section, which includes the languages of the *Tumbuka*, *Henga* and *A-tonga* peoples, and occupies the area between the western shores of Lake Nyasa and the Upper Luangwa river.

(37) Eastwards of No. 35 (North Nyasa group) lies the *Kinga* speech of the lofty Livingstone mountains, which is sufficiently distinct from its neighbours to be classified as a separate group.

(38) East of the Livingstone mountains and west of the Ruaha river, south also of the Unyamwezi domain, extends the *Sango-Bena-Ihehe-Sutu* group.

(39) The extensive *Yao* genus of languages stretches from just behind the coast of the Lindi settlements in German East Africa (*Ki-mwera*) south-westward across the Ruvuma river to the north-east shores of Lake Nyasa (*Ki-kesa*), and thence back to the valley of the Lujenda-Ruvuma (*Cingindo*), and southwards in various dialects of the *Yao* language to the south-east corner of Lake Nyasa and the region east of the Shire river, between Lake Nyasa, the Shire highlands and Mt. Mlanje. It is only since the middle of the 19th century that the *Yao* language has conquered territory to the south of Lake Nyasa. There still remain within its domain colonies of Nyanja-speaking people.

(40) Eastwards of the *Yao* domain, and bounded on the north by the range of that language in the Ruvuma valley and by the separate group of *Ki-mahonde* (No. 10), ranges the well-marked *Makua* genus. The languages thus described occupy the greater part of Portuguese East Africa away from the watershed of Lake Nyasa. The *Makua* language is probably divided into the following dialects:—*Lomolo, Lomolo, Lomolo* and *Alwara*. There are also dialects untraced in the Anjozi coast-region, where, however, strong colonies of Swahili-speaking people are settled. The southern part of the *Makua* domain is occupied by the *Ci-cuambo* of the Quelimane district.

(41) *Nyanja*, perhaps the most extensive group of cognate languages in the Bantu field, is principally associated with the east and west shores of the southern half of Lake Nyasa. It also covers all the valley of the Shire, except portions of the Shire highlands, down to the junction of that stream with the Zambezi, and further, the sands on both banks of the Zambezi down to and including its delta. West of Lake Nyasa, the *Nyanja* domain extends in the *Senga* language to the river Luangwa and the Central Zambezi, also along both banks of the Central Zambezi. South of the Central Zambezi, *Nyanja* dialects are spoken as far west as the Victoria Falls. Thence they extend eastwards over Mashonaland to the sea-coast. With this family may also be associated the languages of the Portuguese coast-region south of the Zambezi as far as Inhambane. The principal dialects of the *Nyanja* language are the *Ci-nyanja* of Eastern Nyasaland, *Ci-pela* and *Ci-marani* of South-West Nyasaland, so far as the watershed of the Luangwa river, the *Ci-mahonia* of the Shire highlands, *Ci-mobo* and *Ci-machiniri* of the Shire valley, *Ci-sena* or *Ci-nyungue* of Tete and Sena (Zambezi), and *Ci-mazoro* of the Lower Zambezi. The Luangwa regions, as already mentioned, are occupied by the distinct but closely-allied *Senga* language. South of the Central Zambezi there are *Ci-nanzwa* in the region near the Victoria Falls, *Ci-nyai*, *Shi-kalaña*, *Ci-shuna* (*Ci-gomo*), *Ci-loze*, and possibly *Ci-shangwe* (or *Ci-hlangene*) and *Shilenge* which link on to the Beira coast dialects. In the delta of the Zambezi is to be found *Ci-podaa*, a very distinct language, yet one which belongs to the *Nyanja* genus. *Ci-shangene*, *Chopi* or *Shilenge* and other dialects of the Beira and Inhambane coast-lands and of Manika have been much influenced by Zulu dialects (*Tebele* and *Ronga*).

(42) The well-marked *Bechuana* language group has very distinct features of its own. This includes all the Bantu dialects of the Bechuanaaland protectorate west of the Guai river. Bechuana dialects (such as *Ci-nenda*, *Se-suto*, *Se-peli*, *Se-rola*, *Se-xhapi*, &c.) cover a good deal of the north and west of the Transvaal, and extend over all the Orange River Colony and Bechuanaaland. *Se-suto* is the language of Basutoland; *Se-rola* *Se-mangwato* of the Eastern Kalahari; *Se-kololo* is the court language of Basutoland; *Ci-nenda* and *Se-peli* or *Peli* are the principal dialects of the Transvaal. Group No. 42, in fact, stretches between the Zambezi on the north and the Orange river on the south, and extends westward (except for Hottentot and Bushmen interruptions) to the domain of the *Oci-herero*.

(43) The *Ronga* (*Tonga*) languages of Portuguese South-East Africa (Gazaland, Lower Limpopo valley), and patches of the North Transvaal (*Shi-xwamba*), Delagoa Bay) are almost equally related to the *Nyanja* group (41) on the one hand, and to *Zulu* on the other, probably representing a mingling of the two influences, of which the latter predominates.

(44) Lastly comes the *Zulu-Koffir* group, occupying parts of Rhodesia, the eastern portion of the Transvaal, Swaziland, Natal and the eastern half of Cape Colony. In vocabulary, and to some degree in phonetics, the *Zulu* language (divided at most into three dialects) is related in some phonetic features to No. 42, and of course to No. 43; otherwise it stands very much alone in its developments. It may have distant relations to groups Nos. 29 and 32. Dialects of *Zulu* (*Tebele* and *Ki-ngoni* or *Ci-nongi*) are spoken at the present day in South-West Rhodesia and in Western Nyasaland and on the

plateaus north-east of Lake Nyasa, carried thither by the Zulu raiders of the early 19th century.

The foregoing is only an attempt to classify the known forms of Bantu speech and to give their approximate geographical limits. The writer is well aware that here and there exist small patches of languages spoken by two or three villages which, though emphatically Bantu, possess isolated characters making them not easily included within any of the above-mentioned groups; but too detailed a reference to these languages would be wearisome and perhaps puzzling. Broadly speaking, the domain of Bantu speech seems to be divided into four great sections:—(a) the languages of the Great Lakes and the East Coast down to and including the Zambezi basin; (b) the South-Central group (*Bechuana-Zulu*); (c) the languages of the South-West, from the southern part of the Belgian Congo to Damaraland and the Angola-Congo coast; and (d) the Western group, including all the Central and Northern Congo and Cameroon languages, and probably also group No. 2 of the Albert Nyanza and Semliki river.

Common Features.—There is no mistaking a Bantu language, which perhaps is what renders the study of this group so interesting and encouraging. The homogeneity of this family is so striking, as compared with the inexplicable confusion of tongues which reigns in Africa north of the Bantu borderland, that the close relationships of these dialects have perhaps been a little exaggerated by earlier writers.

The phonology of the Western group (d) is akin to that of the Negro languages of Western and West-Central Africa. A small portion of (b) the South-Central group (*Zulu*) has picked up clicks, perhaps borrowed from the Hottentots and Bushmen. Otherwise, the three groups (a), (b) and (c) are closely related in phonology, and never, except here and there on the borders of the Western group, adopt the peculiar West African combinations of *kp* and *gb*, which are so characteristic of African speech between the Upper Nile and the Guinea coast.

The following propositions may be laid down to define the special or peculiar features of the Bantu languages:—

(1) They are agglutinative in their construction, the syntax being formed by adding prefixes principally and also suffixes to the root, but no infixes (that is to say, no mutable syllable incorporated into the middle of the root-word).¹

(2) The root excepting its terminal vowel is practically unchanging, though its first or penultimate vowel or consonant may be modified in pronunciation by the preceding prefix, or the last vowel in the case of a preceding suffix.

(3) The vowels of the Bantu languages are always of the Italian type, and no true Bantu language includes obscure sounds like *ø* and *ä*. Each word must end in a vowel (though in some modern dialects in Eastern Equatorial, West and South Africa the terminal vowel may be elided in rapid pronunciation, or be dropped, or absorbed in the terminal consonant, generally a nasal). No two consonants can come together without an intervening vowel, except in the case of a nasal, labial or sibilant.² No consonant is doubled. Apparent exceptions occur in this last rule where two nasals, two *r*'s or two *d*'s come together through the elision of a vowel or a labial.

(4) Substantives are divided into classes or genders, indicated by the pronominal particle prefixed to the root. These prefixes are used either in a singular or in a plural sense. With the exception of the "abstract" prefix *Bu* (No. 14), no singular prefix can be used as a plural nor vice versa. There is a certain degree of correspondence between the singular and plural prefixes (thus No. 2 prefix serves almost invariably as a plural to No. 3; No. 8 corresponds as a plural to No. 7). The number of prefixes common to the whole group is perhaps sixteen. The pronominal particle or prefix of the noun is attached as a prefix to the roots of the adjectives, pronouns, prepositions and verbs of the sentence which are connected with the governing noun; and though in course of time these particles may differ in form from the prefix of the substantive, they were akin in origin. (This system is the "concord" of Dr Bleek.) The pronominal particles, whether in nominative or accusative case, must always precede the nominal, pronominal, adjectival and verbal roots, though they often follow the auxiliary prefix-participles used in conjugating verbs,³ and the roots of some prepositions.

¹ These features are characteristic of almost all the Negro languages of Africa.

² This does not preclude the aspiration of consonants, or the occasional change of a palatal into a guttural.

³ As already mentioned, a somewhat similar concord is also present as regards the suffixes of the Fula and the Kiamia (*Tem*) languages in Western Africa, and as regards the prefixes of the Timne language of Sierra Leone; it exists likewise in Hottentot and less markedly in many Aryan, Semitic and Hamitic tongues.

⁴ An apparent but not a real exception to this rule is in the second person plural of the imperative mood, where an abbreviated form of the pronoun is affixed to the verb. Other phases of the verb may be occasionally emphasized by the repetition of the governing pronoun at the end.

(5) The root of the verb is the second person singular of the imperative.

(6) *No sexual gender* is recognized in the *pronouns and concord*. Sexual gender may be indicated by a male "prefix" of varying form, often identical with a word meaning "father," while there is a feminine prefix, *na* or *nya*, connected with the root meaning "mother" or a suffix *ka* or *kazi*, indicating "wife," "female." The 1st and 2nd prefixes invariably indicate living beings and are usually restricted to humanity.

The sixteen original prefixes of the Bantu languages are given below in the most archaic forms to be found at the present day. The still older types of these prefixes met with in one or two languages, and deduced generally by the other forms of the particle used in the syntax, are given in brackets. It is possible that some of these prefixes resulted from the combination of a demonstrative pronoun and a prefix indicating quality or number.

Old Bantu Prefixes.

- | | |
|---|--|
| <p>Singular.</p> <p>Class 1. <i>Umu- (Ngu-mu-)</i>¹</p> <p>" 3. <i>Umu- (Ngu-mu-)</i></p> <p>" 5. <i>Idi (Ndi-di-)</i></p> <p>" 7. <i>Ibi- (Nki-ki-)</i></p> <p>" 9. <i>I-n- or I-ni- (?Ngi-ni-)</i></p> <p>" 11. <i>Ulu (Ndu-du-)</i></p> <p>" 13. <i>Aba (?Nka-ka-)</i>; usually diminutive, sometimes honorific.</p> <p>" 14. <i>Ubu- (?Mbu-bu-)</i>; sometimes used in a plural sense; generally employed to indicate abstract nouns.</p> <p>" 15. <i>Uku (Nku-ku-)</i>; identical with the preposition "to," used as an infinitive with verbs, but also with certain nouns indicating primarily functions of the body.</p> <p>" 16. <i>Apa (Mpa-pa-)</i>; locative; applied to nouns and other forms of speech to indicate place or position; identical with the adverb "here," as <i>Ku</i> is with "there."</p> | <p>Plural.</p> <p>Class 2. <i>Aba (Mba-ba- or Nga-ba-)</i>¹</p> <p>" 4. <i>Imi- (Ngi-ni-)</i></p> <p>" 6. <i>Ama- (Nga-ma-)</i></p> <p>" 8. <i>Ibi- (Mbi-bi-)</i></p> <p>" 10. <i>Ii- Izi- Ii-n- Izi-n- (?Ngi-ti-)</i></p> <p>" 12. <i>Utu (Ntu-tu-)</i>; often diminutive in sense.</p> <p>" 14. <i>Ubu- (?Mbu-bu-)</i>; sometimes used in a plural sense; generally employed to indicate abstract nouns.</p> <p>" 15. <i>Uku (Nku-ku-)</i>; identical with the preposition "to," used as an infinitive with verbs, but also with certain nouns indicating primarily functions of the body.</p> <p>" 16. <i>Apa (Mpa-pa-)</i>; locative; applied to nouns and other forms of speech to indicate place or position; identical with the adverb "here," as <i>Ku</i> is with "there."</p> |
|---|--|

To these sixteen prefixes, the use of which is practically common to all members of the family, might perhaps be added No. 17, *Fi-* or *Vf-*, a prefix in the singular number, having a diminutive sense, which is found in some of the western and north-western Bantu tongues, chiefly in the northern half of the Congo basin and Cameroon. It is represented as far east (in the form of *I-*) as the Manyema language on the Upper Congo, near Tanganyika. This prefix cannot be traced to derivation from any others among the sixteen, certainly not to No. 8, as it is always used in the singular. Its corresponding plural prefix is No. 12 (*Tu-*). Prefix No. 18 is *Ogw-*, which has, as a plural prefix, No. 19, *Aga-*. These are both used in an augmentative sense, and their use seems to be confined to the Luganda and Masaba dialects, and perhaps some branches of the Unyoro language. These, and Nos. 17 and 18, are regular prefixes, since they are supplied with the concord (*gu-* and *ga-*). Lastly, there is the 20th prefix, *Mu-*, which is really a preposition meaning "in" or "into," often combined in meaning with another particle, *-ni*, used always as a suffix.² The 20th prefix, *Mu-*, however, does not seem to have a complete concord, as it is only used adjectivally or as a preposition and has no pronominal accentive.

The concord may be explained thus:—Let us for a moment reconstruct the original Bantu mother-tongue (as attempts are sometimes made to deduce the ancient Aryan from a comparison of the most archaic of its daughters) and propound sentences to illustrate the repetition of pronominal particles known as the concord.

Old Bantu.

<i>Babo mbaba-ntu³</i>	<i>babu</i>	<i>ba-ba-ta</i>	<i>tu-ba-oga.</i>
They these-they person they bad they who kill we fear them.			
Rendered into the modern dialect of <i>Luganda</i> this would be:—			
<i>Bo aba-ntu</i>	<i>babu</i>	<i>bababa-ntu</i>	<i>tu-ba-ta.</i>
They these-they person they bad they who kill w/c/hem fear.			
(They are bad people who kill; we fear them.)			

Old Bantu.

<i>Ngu-mu-ti</i>	<i>nguno</i>	<i>ngu-gwa</i>	<i>ku-ngu-mbona.</i>
* This tree	is here	that falls;	thou this seeest?
Rendered into <i>Kisgwa</i> of North-West Tanganyika, this would be:—			
<i>Umuti gano</i>	<i>gugwa</i>	<i>ugumona?</i>	
It tree	is here	it falls;	thou it seeest?
			(The tree falls; dost thou see it?)

The prefixes and their corresponding particles have varied greatly in form from the original syllables, as the various Bantu dialects

became more and more corrupt. Assuming these prefixes to have consisted once of two distinct particles, such as, for example, Nos. 1 and 3, *Ngu-mu-*, or the 6th plural prefix *Nga-ma-*, the first syllable seems to have been of the nature of a demonstrative pronoun, and the second more like a numeral or an adjective. *Mu-* probably meant "one," and *Ma-* a collective numeral of indefinite number, applied to liquids (especially water), a tribe of men, a herd of beasts—anything in the nature of a noun. In the corresponding particle of the concord as applied to adjectives, verbs and pronouns, sometimes in the first syllable, *Ngu* or *Nga* was taken for the concord and sometimes the second *mu* or *ma*. This would account for the seemingly inexplicable lack of correspondence between the modern prefix and its accompanying particle, which so much puzzled Bleek and other early writers on the Bantu languages. In many of these tongues, for example, the particle which corresponds at the present day to the plural prefix *Ma-* is not always *Ma*, but more often *Ga-*, *Ya-*, *A-*; while to *Mu-* (Classes 1 and 3) the corresponding particle besides *-mu-* is *gu-*, *gu-*, *tu-*, *yu-*, *fu-*, *fu-*, *fu-*, &c.

The second prefix, *Ba-* or *Aba-*, is in the most archaic Bantu speech (the languages of Mt. Elgon). *Baba-* in its definite form (*Nga-ba* sometimes in Zulu-Kafir). The concord is *-ba-* in all the less corrupt Bantu tongues, but this plural prefix degenerates into *Va-*, *Wa-*, *Ma-*, and *A-*. The concord of the 4th prefix, *Mi-*, is *gi-*, *i-*, *ji-*, and sometimes *Li-*. The commonest form of the 5th prefix at the present day is *Ii-* (the older and more correct is *Di-*); and its concord is the same; this 5th prefix is often dropped (the concord remaining) or becomes *Ri-*, *I-*, *Ji-*, and *Ni-*. The 7th prefix, *Ki-*, in many of the more corrupt dialects of the Congo basin is changed through *ti-* into *Si-* (= *Shi*) and *Si-* and its concord resemble it. The 8th prefix (*ti-*) is still more variable. In its oldest form this is *Ibi-* or *Mbi-bi-*. It is invariably the plural of the 7th. It occurs in different forms of Bantu speech *Vi-*, *Pi-*, *Fi-*, *Fy-*, *Psi-*, *Si-*, *I-*, *By-*, *Bzi-*, *Psi-*, *Zwi-*, *Zi-* and *Ri-*, with a concord that is similar. The 10th prefix, which was originally *Ti-* or *Tin-*, or *Zi-* or *Zin-*, becomes *Jin-*, *Rin-*, *Din-*, *Lin-*, *Om-*, *On-*, &c. The *n* in this prefix is really the singular prefix No. 9, which is sometimes retained in the plural, and sometimes omitted. In the case of the 10th prefix, the concord or corresponding pronominal persists long after the prefix has fallen out of use as a definite article. Thus, though it is absent as a plural prefix for nouns in the *Suahili* of Zanzibar, it reappears in the concord. For instance:—*Nombe hizi zangu*—Cows these mine (These cows are mine), although *Nombe* has ceased to be *zi-nombe* in the plural, the *Zi-* particle reappears in *hizi* and *zangu*. In fact, the persistence of this concord, which exists in almost every known Bantu language in connexion with the 10th prefix, shows that prefix to have been in universal use at one time. The 11th prefix *-Lu-* seems to be descended from an older form, *Ndu-*. Its commonest type is *Lu-*, but sometimes it loses *l-* and becomes *U-*, and in the more archaic dialects is usually pronounced *Du-* or *U-*. This prefix is used in one or two languages. The 12th prefix (*Tu-*), always used in a diminutive sense, disappears in many of these languages. Where met with it is generally *Tu-* or *To-*, but sometimes the initial *T* becomes *R* (*Rtu-*, *Ro-*) or *L* (*Ltu-*, *Lo-*) or even *Y* (*Yo-*), the concord following the fortunes of the prefix. The 13th prefix (*Ka-*) is sometimes confused with the 7th (*Ki-*) and merged into it and vice versa. *Ka-* very often takes the 8th prefix as a plural, more commonly the 12th, sometimes the 14th. This prefix (*Ka-*) entirely disappears in the north-western sections of the Bantu languages. Heek thought that it persisted in the attenuated form of *Es-*, so characteristic of the Cameroon and northern Congo languages, but later investigations show this *Es-* to be a reduction of *Ki-* (*Ke-*) the 7th prefix. The 14th prefix *Bu-* is very persistent, but frequently loses its initial letter *B*, which is either softened into *V* or *W*, or disappears altogether, the prefix becoming *U-* or *O-* or *Wa-*. Sometimes this prefix becomes palatalized into *By-* or even *Ts-* (*C-*). The concord follows suit. The 15th prefix, *Ku-*, occasionally loses its initial *K* or softens into *Hu* or *xu* or strengthens into *Gw-*. Its concord under these circumstances sometimes remains in the form of *Ku-*. The 16th, *Pa-*, prefix is one of the most puzzling in its distribution and its phonetic changes. A very large number of the Bantu languages in the north, east and west have a dislike to the consonant *P*, which they frequently transmute into an aspirate (*H-*), or soften into *V*, *W*, or *F*, or simply drop out. There is too much evidence in favour of this prefix having been originally *Pa-* or *Mpa-pa* to enable us to give it any other form in reconstructing the Bantu mother-tongue. Yet in the most archaic Bantu dialects to the north of the Victoria Nyanza it is nowhere found in the form of *Pa-*. It is either *Ha-* (and *Ha-* changes eastward into *Sa-*) or *Heek* thought that it persisted in this shape in the language of Uganda one might almost be led to think that the 16th locative prefix began as *Ha-* or *Ha-* and by some process without a parallel changed in the east and south to the form of *Pa-*. There are, however, a good many place names in the northern part of the Uganda protectorate, in the region now occupied by Nilotic negroes, which begin with *Pa-*. These place names would seem to be of ancient Bantu origin in a

¹ The full hypothetical forms of the prefixes as joined with definite articles—*Ngunu*, *Mbabu*, *Ngimi*, *Ngama* and so on—are added in brackets. Forms very like these are met with still in the Mt. Elgon languages (Group No. 3) and in *Subiya* group (No. 32).

² This is prominently met with in East Africa, and also in the various Bechuana dialects of Central South Africa, where it takes the form of *ni* at the end of words.

³ Or perhaps *nga-ba-ntu* (afterwards *na-ba-*, *aba-*); the form *ngabantu* is actually met with in Zulu-Kafir; also *ngumuntu*.

⁴ Likewise *ba-* may have meant "two" (Bantu root *Bali*=two); a dual first and then a plural.

⁵ *Wa-* in Luganda. In Lusoga (north coast of Victoria Nyanza) *Wa-* becomes *Ta* (*Gha*).

land from which the Bantu negroes were subsequently driven by Nilotic invaders from the north. They may be relics therefore of a time before the *Pa-* prefix of those regions had changed to the modern form *Ha-*. In S.W. and N.W. Cameroon the initial *p* of the 16th prefix reappears in two or three dialects; but elsewhere in North-West Bantu Africa and in the whole basin of the Congo, except the extreme south and south-east, the form *Pa-* is never met with; it is *Va-, Wa-, Ha-, Fa-, A-*. In the *Secuana* group of dialects it is *Fa- or Ha-*; in the *Luvu* language of Barotsela it assumes the very rare form of *Bu-*, while the first prefix is weakened to *A-*.

The pronouns in Bantu are in most cases traceable to some such general forms as these:—

I, me, my	<i>ngi, mi, 'ngu.</i>
Thou, thee, thy	<i>gwe, ku; -ko.</i>
He or she, him, her, his, &c	<i>a-, ya-, wa- (nom.); also ngu-</i> (which becomes <i>yu-, ye-, wu-, hu-, u-</i>); <i>-mu (acc.); -ka, -kwe (poss.);</i> there is also another form, <i>ndi</i> (nom. and poss.) in the Western Bantu sphere.
We, us, our	<i>isu, svi-, tu-, ti-; -tu (acc.); -itu (poss.).</i>
Ye, you, your	<i>inu, nu-, nyu-, nyi-, ni-; -nu, mu- (acc.); -inu (poss.).</i>
They, them, their	<i>babo, ba-; -ba (acc.); -babo (poss.).</i>

The Bantu verb consists of a practically unchangeable root which is employed as the second person singular of the imperative. To this root are prefixed and suffixed various particles. These are worn-down verbs which have become auxiliaries or they are reduced adverbs or prepositions. It is probable (with one exception) that the building up of the verbal root into moods and tenses has taken place independently in the principal groups of Bantu languages, the arrangement followed being probably founded on a fundamental system common to the original Bantu tongue. The exception alluded to may be a method of forming the preterite tense, which seems to be shared by a great number of widely-spread Bantu languages. This may be illustrated by the *Zulu* *tanda*, love, which changes to *tandile*, have loved, did love. This *-ile* or *-ili* may become in other forms *-idi, -idi, -ire, -ine*, but is always referable back to some form like *-ili* or *-ile*, which is probably connected with the root *li* or *di* (*ndi* or *ni*), which means "to be" or "exist." The initial *i* in the particle *-ile* often affects the last or penultimate syllable of the verbal root, thereby causing one of the very rare changes which take place in this vocable. In many Bantu dialects the root *pa* (which means to give) becomes *pile* in the preterite (no doubt from an original *pa-ile*). Likewise the *Zulu* *tandile* is a contraction of *tanda-ile*.

Two other frequent changes of the terminal vowel of the common root are those from *a* (which is almost invariably the terminal vowel of Bantu verbs), (1) into *e* to form the subjunctive tense, (2) into *i* to give a negative sense in certain tenses. With these exceptions the vowel *a* almost invariably terminates verbal roots. The departures from this rule are so rare that it might almost be included among the elementary propositions determining the Bantu languages. And these instances when they occur are generally due (as in Swahili) to borrowed foreign words (Arabic, Portuguese or English).¹ This point of the terminal *a* is the more interesting because, by changing the terminal vowel of the verbal root and possibly adding a personal prefix, one can make (out of) verbs. Thus in *Luganda* *senyusa* is the verbal root "to pardon." "A pardon" or "forgiveness" is *ki-senyusa*. "A pardoner" might be *mu-senyusa*. In Swahili *patanisa* would be the verbal root "conciliate"; *mputanisa* is a "conciliator," and *upataniso* is "conciliation." Another marked feature of Bantu verbs is their power of modifying the sense of the original verbal root by suffixes, the affixion of which modifies the terminal vowel and sometimes the preceding consonant of the root. Familiar forms of these variations and their usual meanings are as follows:—

Supposing an original Bantu root, <i>tanda</i> , to love; this may become	
<i>tandwa</i>	to be loved.
<i>tandeka</i> or <i>tandika</i>	to be loved.
<i>tandisa</i> or <i>tandela</i> ²	to love for, with, or by some other person.
<i>tandisa</i> (or <i>-eta</i>)	to cause to love.
<i>tandisa</i> (or <i>-esa</i>)	
<i>tandana</i>	to love reciprocally.

¹ *Mi* is possibly a tracing of *ngi, ni*; *ngi* becomes in some dialects *nji, ndi, ni* or *mibi*; there is in some of the coast Cameroon languages, and in the north-eastern Congo, a word *mibi, mba* for "I," "me," which seems to be borrowed from the Sudanic Mundu tongues. The possessive pronoun for the first person in is derived from two forms, *-ami* and *-angi* (*-am, -angi, -ambi, -ambi, &c.*).

² An exception to this rule is the verbal particle *li* or *di*, which means "to be."
³ *Or-ra, -ra.*

⁴ This form may also appear as *sa*, as for instance *aka* = to be on fire becomes *asa*, to set on fire.

The suffix *-aba* or *-anga* sometimes appears and gives a sense of continuance to the verbal root. Thus *tanda* may become *tandaka* in the sense of "to continue loving."⁵

The negative verbal particle in the Bantu languages may be traced back to an original *ka*, to *or sa, ki, si* or *si* in the Bantu mother-tongue. Apparently in the parent language this particle had already these alternative forms, which resemble those in some West African Negro languages. In the vast majority of the Bantu dialects at the present day, the negative particle in the verb (which nearly always coincides with the pronominal particle) is descended from this *ka, ku* or *sa, ki, si* or *si*, assuming the forms of *ka, ga, nga, sa, ta, ba, a, ti, si, hi, &c.* It has coalesced to such an extent in some cases with the pronominal particle that the two are no longer soluble, and it is only by the existence of some intermediate forms (as in the *Kongo* language) that we are able to guess at the original separation between the two. Originally the negative particle *ka, sa, &c.*, was joined to the pronominal particles, thus:—

<i>Ka-nyi</i>	not I.
(Therefore <i>Ka-nyi tanda</i> = not I love.)	
<i>Ka-ku</i> or <i>ka-wu</i>	not thou.
<i>Ka-a</i>	not he, she.
<i>Ka-tu</i>	not we.
<i>Ka-nu</i>	not ye.
<i>Ka-ba</i>	not they.

In like manner *sa* would become *sa-nyi, sa-wu, &c.* But very early in the history of Bantu languages *ka-nyi, or sa-nyi* became contracted into *kai, sai*, and finally, *ki, si; ka-ku* or *ka-wu* into *ku*; and *kaa* or *saa* have always been *ka* or *sa*. Sometimes in the modern languages the negative particle (such as *ti* or *si*) is used without any vestige of a pronoun being attached to it, and is applied indifferently to all the persons. Occasionally this particle has fallen out of use, and the negative is expressed (1) by stress or accent; (2) by suffix (traceable to a root *-pe* or *-ko*) answering to the French *pas*, and having the same sense; and (3) by the separate employment of an adverb. If not a few Bantu languages, the verb used in a negative sense changes its terminal *-a* to *-i*. The subjunctive is very frequently formed by changing the terminal *-a* to *-e*; thus, *tanda* = love; *-tande* = may love.

BIBLIOGRAPHY.—*A Comparative Grammar of South African Languages* (in two parts, left unfinished), by Dr W. I. Bleek (London, 1869); *A Sketch of the Modern Languages of Africa*, by R. N. Cust (1882); *Comparative Grammar of the South African Bantu Languages*, by Father J. Torrend (1894); mainly composed on a study of the languages of the Central Zambezi, interesting, but erroneous in some deductions, and incomplete). In Sir H. H. Johnston's *The Kilimanjaro Expedition* (1884), *British Central Africa* (1898), and *The Uganda Protectorate* (1902–1904), there are illustrative vocabularies; and in *George Grenfell and the Congo* (1908) the Congo groups of Bantu speech are carefully classified, also the Fernandian and Cameroon. In the numerous essays of Carl Meinhof on the original structure of the Bantu mother-speech, and on existing languages in East and South-East Africa, in the *Mittheilungen des Seminars für Orientalische Sprachen*, Berlin (also its issued separately through Brockhaus, Leipzig, 1899), and also in his *Grundzüge einer vergleichenden Grammatik der Bantusprachen* (Berlin, 1906), a vast amount of valuable information has been collected, but Meinhof's deductions therefrom are not in every case in accord with those of other authorities. The *Swahili-English Dictionary*, by Dr L. Krapf (London, 1882), contains a mass of not well-sorted but invaluable information concerning the Swahili language as spoken on the coast of East Africa, especially regarding many words now becoming obsolete. A similar mine of information is to be found in *An Encyclopaedic Dictionary of the Manuáña (Mang'anja) Language of British Central Africa*, by the Rev. D. C. Scott (1891). The Rev. Admiral Bentley is the *Dictionary of the Congo Language*, by the Rev. John Whitcave (1891), and *The Folklore of Angola*, and a *Grammar of Kimbunda*, by Dr. Heli Chateaubriand. The many vocabularies and vocabularies are published by Bishop Steed on the languages of the East African coast lands are of great importance to the student, especially as they give forms of the prefixes now passing out of use. The *Introductory Handbook of the Yau Language*, by the Rev. Alexander Hetherwick, illustrates very fully that peculiar and important member of the East African group. Vocabularies of various Congo languages have been compiled by Dr. A. Sims; more important works on this subject have been published by the Rev. W. H. Stapleton (*Comparative Handbook of Congo Languages*), and by Rev. John Whitcave (*Grammar and Dictionary of the Bobangi Language* (London, 1899)). E. Torday has illustrated the languages of the Western Congo basin (*Kiwango, Kwilu, northern Kasai*) in the *Journal of the Royal Anthropological Institute*. There is a tracing of the *Lunda* language of the south-western part of the Belgian Congo, in Portuguese, by Henrique de Carvalho, who also in his *Ethnographia da Expediçaõ portuguesa*

⁵ In choosing this common root *tanda*, and applying it to the above various terminations, the writer is not prepared to say that it is associated with all of them in any one Bantu language. Although *tanda* is a common verb in Zulu, it has not in Zulu all these variations, and in some other language where it may by chance exhibit all the variations its own form is changed to *londa* or *randa*.

as *Muata Yawo* goes deeply into Bantu language questions. The *Duala* language of Cameroon has been illustrated by the Baptist missionary Saker in his works published about 1860, and since 1900 by German missionaries and explorers (such as Schuler). The German work on the *Duala* language is mostly published in the *Mittheilungen des Seminars für Orientalische Sprachen* (Berlin); see also Schuler's *Grammatik des Duala*. The Rev. S. Koelle, in his *Polyglotta Africana*, published in 1851, gave a good many interesting vocabularies of the almost unknown north-west Bantu borderland, as well as of other forms of Bantu speech of the Congo coast and Congo basin. J. T. Last, in his *Polyglotta Africana Orientalis*, has illustrated briefly many of the East African dialects and languages, some otherwise touched by no one else. He has also published an excellent grammar of the *Kaguru* language of the East African highlands (Usagara). The fullest information is now extant regarding the languages of *Uganda* and *Unyoro*, in works by the missionaries of the Church Missionary Society (Pilkington, Blackledge, Hattersley, Henry Duta and others). Mr Crabtree, of the same mission, has collected information regarding the *Masaba* dialects of Elgon, and these have also been illustrated by Mr C. W. Hopley, and by Sir H. H. Johnston (*Uganda Protectorate*), and privately by Mr S. A. Northcote. Mr A. C. Madan has published works on the *Swahili* language and on the little-known *Senga* of Central Zambesia, and *Wisa* of North-East Rhodesia (Cambridge University Press). Jacotot (Paris, 1902) has in his *Grammaire Subyia* provided an admirable study of the *Subyia* and *Luyi* languages of Barotseland, and in 1907, Edwin W. Smith (Oxford University Press) brought out a *Handbook of the Ila Language* (Mashukulumbwe). The Rev. W. Govan Robertson is the author of a complete study of the *Bemba* language. Mrs Sydney Hinde has illustrated the dialects of *Kikuyu* and *Kamba*. F. Van der Burg has published a *Dictionary of Kivundi* (the language spoken at the north end of Tanganyika). *Oci-herero* of Damaraland has chiefly been illustrated by German writers, old and new; such as Dr Kolbe and Dr P. H. Brincker. The northern languages of this Herero group have been studied by members of the American Mission at Bailundu under the name of *Umbundu*. Some information on the languages of the south-western part of the Congo basin and those of south-eastern Angola may be found in the works of Capello and Ivens and of Henrique de Carvalho and Commander V. L. Cameron. The British, French and German missionaries have published many dictionaries and grammars of the different *Secuana* dialects, notable amongst which is John Brown's *Dictionary of Secuana* and Meinhold's *Study of the Tsi-venda*. The grammars and dictionaries of Zulu-Kaffir are almost too numerous to catalogue. Among the best are Maclaren's *Kafir Grammar* and Roberts' *Zulu Dictionary*. The works of Boyce, Appleyard and Bishop Coleso should also be consulted. Miss A. Werner has written important studies on the Zulu click-words and other grammatical essences and vocabularies of the Bantu languages in the *Journal of the African Society* between 1902 and 1906. The Tebele dialect of Zulu has been well illustrated by W. A. Elliott in his *Dictionary of the Tebele and Shuna languages* (London, 1897). The *Ronga* (*Tonga*, *Si-gwamba*, *Hlengwa*, &c.) are dealt with in the *Grammaire Ronga* (Lausanne, 1896) of Henri Junod. Bishop Smyth and John Mathews have published a vocabulary and short grammar of the *Xilenge* (Shilenge) language of Inhambane (*S.P.C.K.*, 1902). The journal *Anthropos* (Vienna) should also be consulted. (H. H. J.)

BANVILLE, THÉODORE FAULLAIN DE (1823-1891), French poet and miscellaneous writer, was born at Moulins in the Bourbonnais, on the 14th of March 1823. He was the son of a captain in the French navy. His boyhood, by his own account, was cheerlessly passed at a lycée in Paris; he was not harshly treated, but took no part in the amusements of his companions. On leaving school with but slender means of support, he devoted himself to letters, and in 1842 published his first volume of verse (*Les Cariatides*), which was followed by *Les Stalactites* in 1846. The poems encountered some adverse criticism, but secured for their author the approbation and friendship of Alfred de Vigny and Jules Janin. Henceforward Banville's life was steadily devoted to literary production and criticism. He printed other volumes of verse, among which the *Odes funambulesques* (Alençon, 1857) received unstinted praise from Victor Hugo, to whom they were dedicated. Later, several of his comedies in verse were produced at the Théâtre Français and on other stages; and from 1853 onwards a stream of prose flowed from his industrious pen, including studies of Parisian manners, sketches of well-known persons (*Comètes parisiennes*, &c.), and a series of tales (*Contes bourgeois*, *Contes héroïques*, &c.), most of which were republished in his collected works (1875-1878). He also wrote freely for reviews, and acted as dramatic critic for more than one newspaper. Throughout a life spent mainly in Paris, Banville's genial character and cultivated mind won him the friendship of the chief men of letters of his time. He was also intimate with

Frédéric-Lemaître and other famous actors. In 1858 he was decorated with the legion of honour, and was promoted to be an officer of the order in 1886. He died in Paris on the 15th of March 1891, having just completed his sixty-eighth year. Banville's claim to remembrance rests mainly on his poetry. His plays are written with distinction and refinement, but are deficient in dramatic power; his stories, though marked by fertility of invention, are as a rule conventional and unreal. Most of his prose, indeed, in substance if not in manner, is that of a journalist. His lyrics, however, rank high. A careful and loving student of the finest models, he did even more than his greater and somewhat older comrades, Victor Hugo, Alfred de Musset and Théophile Gautier, to free French poetry from the fetters of metre and mannerism in which it had limped from the days of Malherbe. In the *Odes funambulesques* and elsewhere he revived with perfect grace and understanding the *rondeau* and the *villanelle*, and like Victor Hugo in *Les Orientales*, wrote *pantommes* (pantuns) after the Malay fashion. He published in 1872 a *Petit traité de versification française* in exposition of his metrical methods. He was a master of delicate satire, and used with much effect the difficult humour of sheer bathos, happily adapted by him from some of the early folk-songs. He has somewhat rashly been compared to Heine, whom he profoundly admired; but if he lacked the supreme touch of genius, he remains a delightful writer, who exercised a wise and sound influence upon the art of his generation.

Among his other works may be mentioned the poems, *Idylles prussiennes* (1871), and *Trente-six ballades joyeuses* (1875); the prose tales, *Les Salimbanques* (1853); *Esquisses parisiennes* (1859) and *Contes féériques*; and the plays, *Le Feuilletton d'Aristophane* (1852), *Gringoire* (1866), and *Deidamia* (1876).

See also J. Lemaître, *Les Contemporains* (first series, 1885); Sainte-Beuve, *Causeries du lundi*, vol. xiv.; Maurice Spronck, *Les Artistes littéraires* (1889). (C.)

BANYAN, or **BANIAN** (an Arab corruption, borrowed by the Portuguese from the Sanskrit *banjī*, "merchant"), the *Ficus Indica*, or *Bengalensis*, a tree of the fig genus. The name was originally given by Europeans to a particular tree on the Persian Gulf beneath which some Hindu "merchants" had built a pagoda. In Calcutta the word was once generally applied to a native broker or head clerk in any business or private house, now usually known as *sircar*. *Banyu*, a corruption of the word common in Bengal generally, is usually applied to the native grain-dealer. Early writers sometimes use the term generically for all Hindus in western India. *Banyan* was long Anglo-Indian for an undershirt, in allusion to the body garment of the Hindus, especially the Banyans.

Banyan days is a nautical slang term. In the British navy there were formerly two days in each week on which meat formed no part of the men's rations. These were called *banyan days*, in allusion to the vegetarian diet of the Hindu merchants. *Banyan hospital* also became a slang term for a hospital for animals, in reference to the Hindu's humanity and his dislike of taking the life of any animal.

BAOBAB, *Adansonia digitata* (natural order *Bombacaceæ*), a native of tropical Africa, one of the largest trees known, its stem reaching 30 ft. in diameter, though the height is not great. It has a large woody fruit, containing a mucilaginous pulp, with a pleasant cool taste, in which the seeds are buried. The bark yields a strong fibre which is made into ropes and woven into cloth. The wood is very light and soft, and the trunks of living trees are often excavated to form houses. The name of the genus was given by Linnaeus in honour of Michel Adanson, a celebrated French botanist and traveller.

BAPHOMET, the imaginary symbol or idol which the Knights Templars were accused of worshipping in their secret rites. The term is supposed to be a corruption of *Mahomet*, who in several medieval Latin poems seems to be called by this name. J. von Hammer-Purgstall, in his *Mysterium Baphometis revelatum*, &c., and *Die Schuld der Templer*, revived the old charge against the Templars. The word, according to his interpretation, signifies the baptism of *Metis*, or of fire, and is, therefore, connected with the impurities of the Gnostic Ophites (*q.v.*). Additional

evidence of this, according to Hammer-Purgstall, is to be found in the architectural decorations of the Templars' churches.

An elaborate criticism of Hammer-Purgstall's arguments was made in the *Journal des Savans*, March and April 1819, by M. Raynoud, a well-known defender of the Templars. (See also Hallam, *Middle Ages*, c. i. note 15.)

BAPTISM. The Gr. words *βαπτισμός* and *βάπτισμα* (both of which occur in the New Testament) signify "ceremonial washing," from the verb *βαπτίζω*, the shorter form *βάπτω* meaning "dip" without ritual significance (e.g. the finger in water, a robe in blood). That a ritual washing away of sin characterized other religions than the Christian, the Fathers of the church were aware, and Tertullian notices, in his tract *On Baptism* (ch. v.), that the votaries of Isis and Mithras were initiated *per lavacrum*, "through a font," and that in the *Ludi Apollinares et Eleusini*, i.e. the mysteries of Apollo and Eleusis, men were baptized (*linguntur*, Tertullian's favourite word for baptism), and, what is more, baptized, as they presumed to think, "unto regeneration and exemption from the guilt of their perjuries." "Among the ancients," he adds, "anyone who had stained himself with homicide went in search of waters that could purge him of his guilt."

The texts of the New Testament relating to Christian baptism, given roughly in chronological order, are the following:—

A.D. 55-60, Rom. vi. 3, 4; 1 Cor. i. 12-17, vi. 11, x. 1-4, xii. 13, xv. 29; Gal. iii. 27.

A.D. 60-65, Col. ii. 11, 12; Eph. iv. 5, v. 26.

A.D. 60-70, Mark x. 38, 39.

A.D. 80-90, Acts i. 5, ii. 38-41, viii. 16, 17, x. 44-48, xix. 1-7, xxii. 16; 1 Pet. iii. 20, 21; Heb. x. 22.

A.D. 90-100, John iii. 3-8, iii. 22, iii. 26, iv. 1, 2. Uncertain, Matt. xxviii. 18-20; Mark xvi. 16.

The baptism of John is mentioned in the following:—

A.D. 60-70, Mark i. 1-11.

A.D. 80-90, Matt. iii. 1-16; Luke iii. 1-22, v. 29, 30; Acts i. 22, x. 37, xiii. 24, xviii. 25, xix. 3, 4.

A.D. 90-100, John i. 25-33, iii. 23, x. 40.

It is best to defer the question of the origin of Christian baptism until the history of the rite in the centuries which followed has been sketched, for we know more clearly what baptism became after the year 100 than what it was before. And that method on which a great scholar¹ insisted when studying the old Persian religion is doubly to be insisted on in the study of the history of baptism and the cognate institution, the eucharist, namely, to avoid equally "the narrowness of mind which clings to matters of fact without rising to their cause and connecting them with the series of associated phenomena, and the wild and uncontrolled spirit of comparison, which, by comparing everything, confounds everything."

Our earliest detailed accounts of baptism are in the *Teaching of the Apostles* (c. 90-120) and in Justin Martyr.

The *Teaching* has the following:—

1. Now concerning baptism, thus baptize ye: having spoken beforehand all these things, baptize into the name of the Father and of the Son and of the Holy Spirit, in living water.

2. But if thou hast not living water, baptize into other water; if thou canst not in cold, in warm.

3. But if thou hast not either, pour water upon the head thrice, in the name of the Father and of the Son and of the Holy Spirit.

4. Now before the baptism, let him that is baptizing and him that is being baptized fast, and any others who can; but thou biddest him who is being baptized to fast one or two days before.

The "things spoken beforehand" are the moral precepts known as the two ways, the one of life and the other of death, with which the tract begins. This body of moral teaching is older than the rest of the tract, and may go back to the year A.D. 80.

Justin thus describes the rite in ch. lxi. of his first *Apology*, (c. 140):—

¹ James Darmesteter, in "Introd. to the *Vendidad*," in the *Sacred Books of the East*.

"I will also relate the manner in which we dedicated ourselves to God when we had been made new through Christ. As many as are persuaded and believe that what we teach and say is true, and undertake to be able to live accordingly, are instructed to pray and entreat God with fasting, for the remission of their sins that are past, we praying and fasting with them. Then they are brought by us where there is water, and are regenerated in the same manner in which we were ourselves regenerated. For in the name of God, the Father and Lord of the universe, and of our Saviour Jesus Christ and of the Holy Spirit, they then receive the washing with water."

In the sequel Justin adds:—

"There is pronounced over him who chooses to be born again, and has repented of his sins, the name of God the Father and Lord of the universe, he who leads to the laver the person that is to be washed calling Him by this name alone. For no one can utter the name of the ineffable God, and this washing is called illumination (Gr. *φωτισμός*), because they who learn these things are illuminated in their understandings. And in the name of Jesus Christ, who was crucified under Pontius Pilate, and in the name of the Holy Ghost, who through the prophets foretold all things about Jesus, he who is illuminated is washed."

In ch. xiv. of the dialogue with Trypho, Justin asserts, as against Jewish rites of ablution, that Christian baptism alone can purify those who have repented. "This," he says, "is the water of life. But the cisterns which you have dug for yourselves are broken and profitless to you. For what is the use of that baptism which cleanses the flesh and body alone? Baptize the soul from wrath, from envy and from hatred; and, lo! the body is pure."

In ch. xliii. of the same dialogue Justin remarks that "those who have approached God through Jesus Christ have received a circumcision, not carnal, but spiritual, after the manner of Enoch."

In after ages baptism was regularly called illumination. Late in the 2nd century Tertullian describes the rite of baptism in his treatise *On the Resurrection of the Flesh*, thus:

1. The flesh is washed, that the soul may be freed from stain.
2. The flesh is anointed, that the soul may be consecrated.
3. The flesh is sealed (i.e. signed with the cross), that the soul also may be protected.
4. The flesh is overshadowed with imposition of hands, that the soul also may be illuminated by the Spirit.
5. The flesh feeds on the body and blood of Christ, that the soul also may be filled and gated with God.
6. He also mentions elsewhere that the neophytes, after baptism, were given a draught of milk and honey. (The candidate for baptism, we further learn from his tract *On Baptism*, prepared himself by prayer, fasting and keeping of vigils.)

Before stepping into the font, which both sexes did quite naked, the neophytes had to renounce the devil, his pomps and angels. Baptisms were usually conferred at Easter and in the season of Pentecost which ensued, and by the bishop or by priests and deacons commissioned by him.

Such are the leading features of the rite in Tertullian, and they reappear in the 4th century in the rites of all the orthodox churches of East and West; Tertullian testifies that the Marcionites observed the particulars numbered one to six, which must therefore go back at least to the year 150. About the year 300, those desirous of being baptized were (a) admitted to the catechuminate, giving in their names to the bishop. (b) They were subjected to a scrutiny and prepared, as to-day in the western churches the young are prepared for confirmation. The catechetical course included instruction in monotheism, in the folly of polytheism, in the Christian scheme of salvation, &c. (c) They were again and again exorcized, in order to rid them of the lingering taint of the worship of demons. (d) Some days or even weeks beforehand they had the creed recited to them. They might not write it down, but learned it by heart and had to repeat it just before baptism. This rite was called in the West the *traditio* and *redditio* of the symbol. The Lord's Prayer was communicated with similar solemnity in the West

(*traditio precis*). The creed given in Rome was the so-called Apostles' Creed, originally compiled as we now have it to exclude Marcionites. In the East various other symbols were used. (e) There followed an act of unction, made in the East with the oil of the catechumens blessed only by the priest, in the West with the priest's saliva applied to the lips and ears. The latter was accompanied by the following formula: "Efeta, that is, be thou opened unto odour of sweetness. But do thou fee, O Devil, for the judgment of God is at hand." (f) Renunciation of Satan. The catechumens turned to the west in pronouncing this; then turning to the east they recited the creed. (g) They stepped into the font, but were not usually immersed, and the priest recited the baptismal formula over them as he poured water, generally thrice, over their heads. (h) They were anointed all over with chrism or scented oil, the priest reciting an appropriate formula. Deacons anointed the males, deaconesses the females. (i) They put on white garments and often baptismal wreaths or chaplets as well. In some churches they had worn cowls during the catechumenate, in sign of repentance of their sins. (j) They received the sign of the cross on the brow; the bishop usually dipped his thumb in the chrism and said: "In name of Father, Son and Holy Ghost, peace be with thee." In laying his hands on their heads the bishop in many places, especially in the West, called down upon them the sevenfold spirit. (k) The first communion followed, with milk and honey added. (l) Usually the water in the font was exorcized, blessed and chrism poured into it, just before the catechumen entered it. (m) Easter was the usual season of baptism, but in the East Epiphany was equally favoured. Pentecost was sometimes chosen. We hear of all three feasts being habitually chosen in Jerusalem early in the 4th century, but fifty years later baptisms seem to have been almost confined to Easter. The preparatory fasts of the catechumens must have helped to establish the Lenten fast, if indeed they were not its origin.

Certain features of baptism as used during the earlier centuries must now be noticed. They are the following:—(1) Use of fonts; (2) Status of baptizer; (3) Immersion, submersion or aspersion; (4) Exorcism; (5) Baptismal formula and trine immersion; (6) The age of baptism; (7) Confirmation; (8) *Disciplina arcana*; (9) Regeneration; (10) Relation to repentance; (11) Baptism for the dead; (12) Use of the name; (13) Origin of the institution; (14) Analogous rites in other religions.

1. *Fonts*.—The New Testament, the *Didachè*, Justin, Tertullian and other early sources do not enjoin the use of a font, and contemplate in general the use of running or living water. It was a Jewish rule that in ablutions the water should run over and away from the parts of the body washed. In acts of martyrdom, as late as the age of Decius, we read of baptisms in rivers, in lakes and in the sea. In exceptional cases it sufficed for a martyr to be sprinkled with his own blood. But a martyr's death in itself was enough. Nearchus (c. 250) quieted the scruples of his unbaptized friend Polyeuctes, when on the scaffold he asked if it were possible to attain salvation without baptism, with this answer: "Behold, we see the Lord, when they brought to Him the blind that they might be healed, had nothing to say to them about the holy mystery, nor did He ask them if they had been baptized; but this only, whether they came to Him with true faith. Wherefore He asked them, Do ye believe that I am able to do this thing?"

Tertullian (c. 200) writes (*de Bapt.* iv.) thus: "It makes no difference whether one is washed in the sea or in a pool, in a river or spring, in a lake or a ditch. Nor can we distinguish between those whom John baptized (*in xit*) in the Jordan and those whom Peter baptized in the Tiber." The custom of baptizing in the rivers when they are annually blessed at Epiphany, the feast of the Lord's baptism, still survives in Armenia and in the East generally. Those of the Armenians and Syrians who have retained adult baptism use rivers alone at any time of year.

The church of Tyre described by Eusebius (*H.E.* x. 4) seems to have had a font, and the church order of Macarius, bishop

of Jerusalem (c. 311-335), orders the font to be placed in the same building as the altar, behind it and on the right hand; but the same order lays down that a font is not essential in cases of illness for "the Holy Spirit is not hindered by want of a vessel."

2. *Status of Baptizer*.—Ignatius (*Smyrn.* viii.) wrote that it is not lawful to baptize or hold an *agapè* (Lord's Supper) without the bishop. So Tertullian (*de Bapt.* xvii.) reserves the right of admitting to baptism and of conferring it to the *summus sacerdos* or bishop, Cyprian (*Epist.* lxxiii. 7) to bishops and priests. Later canons continued this restriction; and although in outlying parts of Christendom deacons claimed the right, the official churches accorded it to presbyters alone and none but bishops could perform the confirmation or seal. In the Montanist churches women baptized, and of this there are traces in the earliest church and in the Caucasus. Thus St Thekla baptized herself in her own blood, and St Nino, the female evangelist of Georgia, baptized king Mirian (see "Life of Nino," *Studia Biblica*, 1903). In cases of imminent death a layman or a woman could baptize, and in the case of new-born children it is often necessary.

3. *Immersion or Aspersion*.—The *Didachè* bids us "pour water on the head," and Christian pictures and sculptures ranging from the 1st to the 10th century represent the baptizand as standing in the water, while the baptizer pours water from his hand or from a bowl over his head. Even if we allow for the difficulty of representing complete submersion in art, it is nevertheless clear that it was not insisted on; nor were the earliest fonts, to judge from the ruins of them, large and deep enough for such an usage. The earliest literary notices of baptism are far from conclusive in favour of submersion, and are often to be regarded as merely rhetorical. The rubrics of the MSS., it is true, enjoin total immersion, but it only came into general vogue in the 7th century, "when the growing rarity of adult baptism made the Gr. word (βαπτίζω) patient of an interpretation that suited that of infants only."¹ The *Key of Truth*, the manual of the old Armenian Baptists, archaically prescribes that the penitent admitted into the church shall advance on his knees into the middle of the water and that the elect one or bishop shall then pour water over his head.

4. *Exorcism*.—The *Didachè* and Justin merely prescribe fasting, the use of which was to hurry the exit of evil spirits who, in choosing a *nidus* or tenement, preferred a well-fed body to an emaciated one, according to the belief embodied in the interpolated saying of Matt. xvii. 21: "This kind (of demon) goeth not forth except by prayer and fasting." The exorcisms tended to become longer and longer, the later the rite. The English prayer-book excludes them, as it also excludes the renunciation of the devil and all his angels, his pomps and works. These elements were old, but scarcely primitive; and the archaic rite of the *Key of Truth* (see PAULICIANS) is without them. Basil, in his work *On the Holy Spirit*, confesses his ignorance of how these and other features of his baptismal rite had originated. He instances the blessing of the water of baptism, of the oil of anointing and of the baptizand himself, the use of anointing him with oil, trine immersion, the formal renunciation of Satan and his angels. All these features, he says, had been handed down in an unpublished and unspoken teaching, in a silent and sacramental tradition.

5. *The Baptismal Formula*.—The trinitarian formula and trine immersion were not uniformly used from the beginning, nor did they always go together. The *Teaching of the Apostles*, indeed, prescribes baptism in the name of Father, Son and Holy Ghost, but on the next page speaks of those who have been baptized into the name of the Lord—the normal formula of the New Testament. In the 3rd century baptism in the name of Christ was still so widespread that Pope Stephen, in opposition to Cyprian of Carthage, declared it to be valid. From Pope Zachariah (*Ep.* x.) we learn that the Celtic missionaries in baptizing omitted one or more persons of the Trinity, and this was one of the reasons why the church of Rome anathematized

¹ Rogers' essay on Baptism and Christian Archaeology in *Studia Biblica*, vol. v.

them; Pope Nicholas, however (858-867), in the *Responsa ad consulla Bulgarorum*, allowed baptism to be valid *tantum in nomine Christi*, as in the Acts. Basil, in his work *On the Holy Spirit* just mentioned, condemns "baptism into the Lord alone" as insufficient. Baptism "into the death of Christ" is often specified by the Armenian fathers as that which alone was essential.

Ursinus, an African monk (in Gennad. *de Scr. Eccl.* xxvii.), Hilary (*de Synodis*, lxxxv.), the synod of Nîmours (A.D. 1284), also asserted that baptism into the name of Christ alone was valid. The formula of Rome is, "I baptize thee in the name of Father and Son and Holy Spirit." In the East, "so-and-so, the servant of God, is baptized," &c. The Greeks add *Amen* after each person, and conclude with the words, "Now and ever and to ages of aeons, amen."

We first find in Tertullian trine immersion explained from the trisula invocation, *Nam nec semel, sed ter, ad singula nomina in personis singulas linguamur*: "Not once, but thrice, for the several names, into the several persons, are we dipped" (*adv. Prax.* xxvi.). And Jerome says: "We are thrice plunged, that the one sacrament of the Trinity may be shown forth." On the other hand, in numerous fathers of East and West, e.g. Leo of Rome, Athanasius, Gregory of Nyssa, Theophylactus, Cyril of Jerusalem and others, trine immersion was regarded as being symbolic of the three days' entombment of Christ; and in the Armenian baptismal rubric this interpretation is enjoined, as also in an epistle of Macarius of Jerusalem addressed to the Armenians (c. 330). In Armenian writers this interpretation is further associated with the idea of baptism into the death of Christ.

Trine immersion then, as to the origin of which Basil confesses his ignorance, must be older than either of the rival explanations. These are clearly aetiological, and invented to explain an existing custom, which the church had adopted from its pagan medium. For pagan lustrations were normally threefold; thus Virgil writes (*Aen.* vi. 229): *Ter socios pura circumtulit unda*. Ovid (*Met.* vii. 189 and *Fast.* iv. 315), Persius (ii. 16) and Horace (*Ep.* i. l. 37) similarly speak of trine lustrations; and on the last mentioned passage the scholiast Acro remarks: "He uses the words *thrice purely*, because people in expiating their sins, plunge themselves in thrice." Such examples of the ancient usage encounter us everywhere in Greek and Latin antiquity.

6. *Age of Baptism.*—In the oldest Greek, Armenian, Syrian and other rites of baptism, a service of giving a Christian (*i.e.* non-pagan) name, or of sealing a child on his eighth day, is found. According to it the priest, either at the door of the church or at the home, blessed the infant, sealed it (this not in Armenia) with the sign of the cross on its forehead, and prayed that in due season (*ἐν καιρῷ εὐθέρῳ*) or at the proper time (Armenian) it may enter the holy Catholic church. This rite announces itself as the analogue of Christ's circumcision.

On the fortieth day from birth another rite is prescribed, of *churching* the child, which is now taken into the church with its mother. Both are blessed by the clergy, whose petition now is that God "may preserve this child and cause him to grow up by the unseen grace of His power and made him worthy in due season of the washing of baptism." As the first rite corresponds to the circumcision and naming of Jesus, so does the second to His presentation in the temple. These two rites really begin the catechumenate or period of instruction in the faith and discipline of the church. It depended on the individual how long he would wait for initiation. Whenever he felt inclined, he gave in his name as a candidate. This was usually done at the beginning of Lent. The bishop and clergy next examined the candidates one by one, and ascertained from their neighbours whether they had led such exemplary lives as to be worthy of admission. In case of strangers from another church certificates of character had to be produced. If a man seemed unworthy, the bishop dismissed him until another occasion, when he might be worthier; but if all was satisfactory he was admitted, in the West as a *competens et asker*, in the East as a *φορτισόμενος*, *i.e.* one in course of being illumined. Usually two sponsors were themselves

responsible for the past life of the candidate and for the sincerity of his faith and repentance. The essential thing was that a man should come to baptism of his own free will and not under compulsion or from hope of gain. Macarius of Jerusalem (*op. cit.*) declares that the grace of the spirit is given in answer to our prayers and entreaties for it, and that even a font is not needful; but only the wish and desire for grace. Tertullian, however, in his work *On Baptism*, holds that even that is not always enough. Some girls and boys at Carthage had asked to be baptized, and there were some who urged the granting of their request on the score that Christ said: "Forbid them not to come unto Me" (*Matt.* xix. 14), and: "To each that asketh thee give" (*Luke* vi. 30). Tertullian replies that "We must beware of giving the holy thing to dogs and of casting pearls before swine." He cites 1 Tim. v. 22: "Lay not on thy hands hastily, lest thou share in another's sins." He denies that the precedents of the eunuch baptized by Philip or of Paul baptized *without hesitation* by Simon (to which the other party appealed) were relevant. He dwells on the risk run by the sponsors, in case the candidates for whose purity they went bail should fall into sin. It is more expedient, he concludes, to delay baptism. Why should persons still in the age of innocence be in a hurry to be baptized and win remission of sins? Let people first learn to feel their need of salvation, so that we may be sure of giving it only to those who really want it. Especially let the unmarried postpone it. The risks of the age of puberty are extreme. Let people have married or be anyhow steeled in continence before they are admitted to baptism. It would appear from the homilies of Aphraates (c. 340) that in the Syrian church also it was usual to renounce the married relation after baptism. Cyril of Jerusalem, in his *Catechesis*, insists on "the longing for the heavenly polity, on the goodly resolution and attendant hope" of the catechumen (*Pro. Cat.* ch. i.). If the resolution be not genuine, the bodily washing, he says, profits nothing. "God asks for nothing else except a goodly determination. Say not: How can my sins be wiped out? I tell thee, by willing, by believing" (ch. viii.). So again (*Cat.* i. ch. iii.): "God gives not his holy treasures to the dogs; but where he sees the goodly determination, there he bestows the seed of salvation. . . . Those then who would receive the spiritual saving seal have need of a determination and will of their own. . . . Grace has need of faith on our part." In Jerusalem, therefore, whither believers flocked from all over Christendom to be buried, the official point of view as late as A.D. 350 was entirely that of Tertullian. Tertullian's scruples were not long respected in Carthage, for in Cyprian's works (c. 250.) we already hear of new-born infants being baptized. In the same region of Africa, however, Monica would not let her son Augustine be baptized in boyhood, though he clamoured to be. She was a conservative. In the Greek world thirty was a usual age in the 4th century for persons to be baptized, in imitation of Christ. It is still the age preferred by the Baptists of Armenia. But it was often delayed until the deathbed, for the primitive idea that mortal sins committed after baptism were sins against the Holy Spirit and unforgivable, still influenced men, and survived among the Cathars up to the 14th century. The fathers, however, of the 4th century emphasized already the danger of deferring the rite until men fall into mortal sickness, when they may be unconscious or paralysed or otherwise unable to profess their faith and repentance, or to swallow the viaticum. Gregory Theologus therefore (c. 340) suggests the age of three years as suitable for baptism, because by then a child is old enough, if not to understand the questions put to him, at any rate to speak and make the necessary responses. Gregory sanctions the baptism of infants only where there is imminent danger of death. "It is better that they should be sanctified without their own sense of it than that they pass away unsealed and uninitiated." And he justifies his view by this, that circumcision, which foreshadowed the Christian seal (*σφραγίς*), was imposed on the eighth day on those who as yet had no use of reason. He also urges the analogue of "the anointing of the doorposts, which preserved the first-born by things that have no sense." On such grounds was justified the transition of a baptism which began as a spontaneous act of

self-consecration into an *opus operatum*. How long after this it was before infant baptism became normal inside the Byzantine church, we do not exactly know, but it was natural that mothers should insist on their children being liberated from Satan and safeguarded from demons as soon as might be. The change came more quickly in Latin than in Greek Christendom, and very slowly indeed in the Armenian and Georgian churches. Augustine's insistence on original sin, a doctrine never quite accepted in his sense in the East, hurried on the change.

7. *Confirmation*.—In the West, however, the sacrament has been saved from becoming merely magical by the rite of confirmation or of reception of the Spirit being separated from the baptism of regeneration and reserved for an adult age. The English church confirms at fifteen or sixteen; the Roman rather earlier. The catechetical course, which formerly preceded the complete rite, now intervenes between its two halves; and the sponsors who formerly attested the worthiness of the candidate and received him up as *anadochi* out of the font, have become god-parents, who take the baptismal vows vicariously for infants who cannot answer for themselves. In the East, on the contrary, the complete rite is read over the child, who is thus confirmed from the first. The Roman church already foreshadowed the change and gave a peculiar salience to confirmation as early as the 3rd century, when it decreed that persons already baptized by heretics, but reverting to the church should not be baptized over again, but only have hands laid on them. It was otherwise in Africa and the East. Here they insisted in such cases on a repetition of the entire rite, baptism and confirmation together. The Cathars (*q.v.*) of the middle ages discarded water baptism altogether as being a Jewish rite, but retained the laying on of hands with the *traditio precis* as sufficient initiation. This they called the spiritual baptism, and interpreted Matt. xxviii. 19, as a command to practise it, and not water baptism.

8. *Disciplina arcani*.—The communication to the candidates of the Creed and Lord's Prayer was a solemn rite. Cyril of Jerusalem, in his instruction of the catechumens, urges them to learn the Creed by heart, but not write it down. On no account must they divulge it to unbaptized persons. The same rule already meets us in Clement of Alexandria before the year 200. In time this rule gave rise to what is called the *Disciplina arcani*. Following the fashion of the pagan mysteries in which men were only permitted to gaze upon the sacred objects after minute lustrations and scrupulous purifications, Christian teachers came to represent the Creed, Lord's Prayer and Lord's Supper as mysteries to be guarded in silence and never divulged either to the unbaptized or to the pagans. And yet Justin Martyr, Tertullian and other apologists of the 2nd century had found nothing to conceal from the eye and ear of pagan emperors and their ministers. In the 3rd century this love of mystification reached the pitch of hiding even the gospels from the unclean eyes of pagans. Probably Mgr. Pierre Battifol¹ is correct in supposing that the *Disciplina arcani* was more or less of a make-believe, a bit of belletristic trifling on the part of the over-theoretical Fathers of the 4th and 5th centuries. It is in them that the atmosphere of mystery attains a maximum of intensity. They clearly felt themselves called upon to out-trump the pagan *Mystae*. Yet it is inconceivable that men and women should spend years, even whole lives, as catechumens within the pale of the church, and really remain ignorant all the time of the Trinitarian Epiclesis used in baptism, of the Creed, and above all of the Lord's Prayer. Wherever the *Disciplina arcani*, *i.e.* the obligation to keep secret the formula of the threefold name, the creed based on it and the Lord's Prayer, was taken seriously, it was akin to the scruple which exists everywhere among primitive religionists against revealing to the profane the knowledge of a powerful name or magic formula. The name of a deity was often kept secret and not allowed to be written down, as among the Jews.

9. *Regeneration*.—The idea of regeneration seldom occurs in the New Testament, and perhaps not at all in connexion with baptism; for in the conversation with Nicodemus, John iii. 3-8, the words "of water and" in v. 5 offend the context, spiritual

re-birth alone being insisted upon in vv. 3, 6, 7 and 8; moreover, Justin Martyr, who cites v. 5, seems to omit them. Nor is there any mention of water in ch. i. 13, where, according to the oldest text, Christ is represented as having been born or begotten not of blood, nor of the will of the flesh, nor of the will of man, but of God.

In 1 Pet. i. 3, it is said of the saints that God the Father begat them anew unto a living hope by the resurrection of Jesus, and in v. 23 that they have been begotten again, not of corruptible seed, but of incorruptible through the word of God. But here again it is not clear that the writer has in view water baptism or any rite at all as the means and occasion of regeneration. In the conversation with Nicodemus we seem to overhear a protest against the growing tendency of the last years of the 1st century to substitute formal sacraments for the free affluat of the spirit, and to "crib, cabin and confine" the gift of prophecy. The passage where re-birth is best put forward in connexion with baptism is Luke iii. 22, where ancient texts, including the *Gospel of the Hebrews*, read, "Thou art my beloved Son, this day have I begotten Thee." These words were taken in the sense that Jesus was then re-born of the Spirit an adoptive Son of God and Messiah; and with this reading is bound up the entire adoptionist school of Christology. It apparently underlies the symbolizing of Christ as a fish in the art of the catacombs, and in the literature of the 2nd century. Tertullian prefaces with this idea his work on baptism. *Nos pisciculi secundum IXOTH nostrum Jesum Christum in aqua nascimur*. "We little fishes, after the example of our Fish Jesus Christ, are born in the water." So about the year 440 the Gaulish poet Orientius wrote of Christ; *Piscis notus aquis, auctor baptismatis ipse est*. "A fish born of the waters is himself originator of baptism."

But before his time and within a hundred years of Tertullian this symbolism in its original significance had become heretical, and the orthodox were thrown back on another explanation of it. This was that the word IXOTH is made up of the letters which begin the Greek words meaning "Jesus Christ, Son of God, Saviour." An entire mythology soon grew up around the idea of re-birth. The font was viewed as the womb of the virgin mother church, who was in some congregations, for example, in the early churches of Gaul, no abstraction, but a divine aeon watching over and sympathizing with the children of her womb, the recipient even of hymns of praise and humble supplications. Other mythoplastic growths succeeded, one of which must be noticed. The sponsors or *anadochi*, who, after the introduction of infant baptism came to be called god-fathers and god-mothers, were really in a spiritual relation to the children they took up out of the font. This relation was soon by the canonists identified with the blood-tie which connects real parents with their offspring, and the corollary drawn that children, who in baptism had the same god-parent, were real brothers and sisters, who might not marry either each the other or real children of the said god-parent. The reformed churches have set aside this fiction, but in the Latin and Eastern churches it has created a distinct and very powerful marriage taboo.

10. *Relation to Repentance*.—Baptism justified the believer, that is to say, constituted him a saint whose past sins were abolished. Sin after baptism excluded the sinner afresh from the divine grace and from the sacraments. He fell back into the status of a catechumen, and it was much discussed from the 2nd century onwards whether he could be restored to the church at all, and, if so, how. A rite was devised, called *exhomologesis*, by which, after a fresh term of repentance, marked by austerities more strict than any Trappist monk imposes on himself to-day, the persons lapsed from grace could re-enter the church. In effect this rite was a repetition of baptism, the water of the font alone being omitted. Such restoration could in the earlier church only be effected once. A second lapse from the state of grace entailed perpetual exclusion from the sacraments, the means of salvation. As has been remarked above, the terror of post-baptismal sin and the fact that only one restoration was allowable influenced many as late as the 4th century to remain catechumens all their lives, and, like Constantine, to receive baptism on the

¹ *Études historiques, Essai sur Disc. arc.* (Paris 1902).

deathed alone. The same scruples endured among the medieval Cathars. (See PENANCE and NOVATIANS.)

11. *Baptism for the Dead*.—Paul, in 1 Cor. xv. 29, glances at this as an established practice familiar to those whom he addresses. Three explanations are possible: (1) The saints before they were quickened or made alive together with Christ, were dead through their trespasses and sins. In baptism they were buried with Christ and rose, like Him, from the dead. We can, therefore, paraphrase v. 29 thus: "Else what shall they do which are baptized for their dead selves?" &c. It is in behalf of his own sinful, *i.e.* dead self, that the sinner is baptized and receives eternal life. (2) Contact with the dead entailed a pollution which lasted at least a day and must be washed away by ablutions, before a man is re-admitted to religious cult. This was the rule among the Jews. Is it possible that the words "for the dead" signify "because of contact with the dead"? (3) Both these explanations are forced, and it is more probable that by a make-believe common in all religions, and not unknown in the earliest church, the sins of dead relatives, about whose salvation their survivors were anxious, were transferred into living persons, who assumed for the nonce their names and were baptized in their behalf, so in vicarious wise rendering it possible for the sins of the dead to be washed away. The Mormons have this rite. The idea of transferring sin into another man or into an animal, and so getting it purged through him or it, was widespread in the age of Paul and long afterwards. Chrysostom says that the substitutes were put into the beds of the deceased, and assuming the voice of the dead asked for baptism and remission of sins. Tertullian and others attested this custom among the followers of Cerinthus and Marcion.

12. *Use of the Name*.—In Acts iv. 7, the rulers and priests of the Jews summon Peter and inquire by what power or in what name he has healed the lame. Here a belief is assumed which pervades ancient magic and religion. Only so far as we can get away from the modern view that a person's name is a trifling accident, and breathe the atmosphere which broods over ancient religions, can we understand the use of the name in baptisms, exorcisms, prayers, purifications and consecrations. For a name carried with it, for those who were so blessed as to be acquainted with it, whatever power and influence its owner wielded in heaven or on earth or under the earth. A vow or prayer formulated in or through a certain name was fraught with the prestige of his whose name it was. Thus the psalmist addressing Jehovah cries (Ps. liv. 1): "Save me, O God, by Thy name, and judge me in Thy might." And in Acts iii. 16, it is the name itself which renders strong and whole the man who believed therein. In Acts xviii. 15, the Jews assail Paul because he has trusted and appealed to the name of a Messiah whom they regard as an overthrower of the law; for Paul believed that God had invested Jesus with a name above all names, potent to constrain and overcome all lesser powers, good or evil, in heaven or earth or under earth. Baptism then in the name or through the name or into the name of Christ placed the believer under the influence and tutelage of Christ's personality, as before he was in popular estimation under the influence of stars and horoscope. Nay, more, it imported that personality into him, making him a limb or member of Christ's body, and immortal as Christ was immortal. Nearly all the passages in which the word *name* is used in the New Testament become more intelligible if it be rendered *personality*. In Rev. xi. 13, the revisers are obliged to render it by *persons*, and should equally have done so in iii. 4: "Thou hast a few *names* (*i.e.* persons) in Sardis which did not defile their garments." (See CONSECRATION.)

13. *Origin of Christian Baptism*.—When it is asked, Was this a continuance of the baptism of John or was it merely the baptism of proselytes?—a distinction is implied between the two latter which was not always real. In relation to the publicans and soldiers who, smitten with remorse, sought out John in the wilderness, his baptism was a purification from their past and so far identical with the proselyte's bath; but so far as it raised them up to be children unto Abraham and filled them with the

Messianic hope, it advanced them further than that bath could do, and assured them of a place in the kingdom of God, soon to be established—this, without imposing circumcision on them; for the ordinary proselyte was circumcised as well as baptized. For the Jews, however, who came to John, his baptism could not have the significance of the proselyte's baptism, but rather accorded with another baptism undergone by Jews who wished to consecrate their lives by stricter study and practice of the law. So Epictetus remarks that he only really understands Judaism who knows "the baptized Jew" (*τὸν βαπτισμένον*). We gather from Acts xix. 4, that John had merely baptized in the name of the coming Messiah, without identifying him with Jesus of Nazareth. The apostolic age supplied this identification, and the normal use during it seems to have been "into Christ Jesus," or "in the name of the Lord Jesus Christ," or "of Jesus Christ" simply, or "of the Lord Jesus Christ." Paul explains these formulas as being equivalent to "into the death of Christ Jesus," as if the faithful were in the rite raised from death into everlasting life. The *likeness* of the baptismal ceremony with Christ's death and resurrection ensured a real union with him of the believer who underwent the ceremony, according to the well-known principle *in sacris simulata pro veris accipi*.

But opinion was still fluid about baptism in the apostolic age, especially as to its connexion with the descent of the Spirit. The Spirit falls on the disciples and others at Pentecost without any baptism at all, and Paul alone of the apostles was baptized. So far was the afflatus of the Spirit from being conditioned by the rite, that in Acts x. 44 ff., the gift of the Spirit was first poured out upon the Gentiles who heard the word preached so that they spoke with tongues, and it was only after these manifestations that they were baptized with water in the name of Jesus Christ at the instance of Peter. We can divine from this passage why Paul was so eager himself to preach the word, and left it to others to baptize.

But as a rule the repentant underwent baptism in the name of Christ Jesus, and washed away their sins before hands were laid upon them unto reception of the Spirit. Apollon, who only knew the baptism of John (Acts xviii. 24), needed only instruction in the prophetic *gnosis* at the hands of Priscilla and Aquila in order to become a full disciple. On the other hand, in Acts xix. 1-7, twelve disciples, for such they were already accounted, who had been baptized into John's baptism, *i.e.* into the name of him that should follow John, but had not even heard of the Holy Spirit, are at Paul's instance re-baptized into the name of the Lord Jesus. Then Paul himself lays hands on them and the Holy Ghost comes upon them, so that they speak with tongues and prophecy. Not only do we hear of these varieties of practice, but also of the laying on of hands together with prayer as a substantive rite unconnected with baptism. The seven deacons were so ordained. And this rite of laying on hands, which was in antiquity a recognized way of transmitting the occult power or virtue of one man into another, is used in Acts ix. 17, by Ananias, in order that Paul may recover his sight and be filled with the Holy Ghost. Saul and Barnabas equally are separated for a certain missionary work by imposition of hands with prayer and fasting, and are so sent forth by the Holy Ghost. It was also a way of healing the sick (Acts xxviii. 8), and as such accompanied by anointing with oil (Jas. v. 14). The Roman church then had early precedents for separating confirmation from baptism. It would also appear that in the primitive age confirmation and ordination were one and the same rite; and so they continued to be among the dissident believers of the middle ages, who, however, often dropped the water rite altogether. (See CATHARS.) More than one sect of the 2nd century rejected water baptism on the ground that knowledge of the truth in itself makes us free, and that external material washing of a perishable body cannot contribute to the illumination of the inner man, complete without it. St Paul himself recognizes (1 Cor. vii. 14) that children, one of whose parents only is a believer, are *ipso facto* not unclean, but *holy*. Even an unbelieving husband or wife is *sanctified* by a believing partner. If we remember the force of the words *ἅγιος ἀγαθῶν* (cf. 1 Cor.

i. 2), here used of children and parents, we realize how far off was St Paul from the positions of Augustine.

The question arises whether Jesus Himself instituted baptism as a condition of entry into the Messianic kingdom. The fourth gospel (iii. 22, and iv. 1) asserts that Jesus Himself baptized on a greater scale than the Baptist, but immediately adds that Jesus Himself baptized not, but only His disciples, as if the writer felt that he had too boldly contradicted the older tradition of the other gospels. Nor in these is it recorded that the disciples baptized during their Master's lifetime; indeed the very contrary is implied. There remain two texts in which the injunction to baptize is attributed to Jesus, namely, Mark xvi. 16 and Matt. xxvii. 18-20. Of these the first is part of an appendix headed "of Ariston the elder" in an old Armenian codex, and taken perhaps from the lost compilations of Papias; as to the other text, it has been doubted by many critics, e.g. Neander, Harnack, Dr Armitage Robinson and James Martineau, whether it represents a real utterance of Christ and not rather the liturgical usage of the region in which the first gospel was compiled. The circumstance, unknown to these critics when they made their conjectures, that Eusebius Pamphili, in nearly a score of citations, substitutes the words "in My Name" for the words "baptizing them into the name of the Father and of the Son and of the Holy Ghost," renders their conjectures superfluous. Apbraates also in citing the verse substitutes "and they shall believe in Me"—a paraphrase of "in My Name." The first gospel thus falls into line with the rest of the New Testament.

14. *Analogous Rites in other Religions* (see also PURIFICATION).—The Fathers themselves were the first to recognize that "the devil too had his sacraments," and that the Eleusinian, Isiac, Mithraic and other *mystae* used baptism in their rites of initiation. But it is not to be supposed that the Christians borrowed from these or from any Gentile source any essential features of their baptismal rites. Baptism was long before the advent of Jesus imposed on proselytes, and existed inside Judaism itself.

It has been remarked that the developed ceremony of baptism, with its threefold renunciation, resembles the ceremony of Roman law known as *emancipatio*, by which the *patria potestas* (or power of life and death of the father over his son) was extinguished. Under the law of the XII. Tables the father lost it, if he three times sold his child. This suggested a regular procedure, according to which the father sold his son thrice into *mancipium*, while after each sale the fictitious vendee enfranchised the son, by *manumissio vindicta*, i.e. by laying his rod (*vindicta*) on the slave and claiming him as free (*vindicatio in libertatem*). Then the owner also laid his rod on the slave, declaring his intention to enfranchise him, and the *praetor* by his *adictor* confirmed the owner's declaration. The third *manumissio* thus gave to the son and slave his freedom. It is possible that this common ceremony of Roman law suggested the triple *abrenunciatio* of Satan. Like the legal ceremony, baptism freed the believer from one (Satan) who, by the mere fact of the believer's birth, had power of death over him. And as the legal manumission dissolved a son's previous agnatic relationships, so, too, the person baptized gave up father and mother, &c., and became one of a society of brethren the bond between whom was not physical but spiritual. The idea of adoption in baptism as a son and heir of God was almost certainly taken by Paul from Roman law.

The ceremony of turning to the west three times with renunciation of the Evil One, then to the east, is exactly paralleled in a rite of purification by water common among the Malays and described by Skeat in his book on Malay magic. If the Malay rite is not derived through Mahomedanism from Christianity, it is a remarkable example of how similar psychological conditions can produce almost identical rites.

The idea of spiritual re-birth, so soon associated with baptism, was of wide currency in ancient religions. It is met with in Philo of Alexandria and was familiar to the Jews. Thus the proselyte is said in the Talmud to resemble a child and must bathe in the name of God. The Jordan is declared in 2 Kings v. 10 to be a cleansing medium, and Naaman's cure was held to pre-figure Christian baptism. Jerome relates that the Jew who taught him

Hebrew communicated to him a teaching of the Rabbi Barabai, that the inner man who rises up in us at the fourteenth year after puberty (i.e. at 29) is better than the man who is born from the mother's womb.

In a Paris papyrus edited by Albr. Dieterich (Leipzig, 1903) under the title of *Eine Mithrasliturgie*, an ancient mystic describes his re-birth in impressive language. In a prayer addressed to "First birth of my birth, first beginning (or principle) of my beginning, first spirit of the spirit in me," he prays "to be restored to his deathless birth (*genesis*), albeit he is let and hindered by his underlying nature, to the end that according to the pressing need and spur of his longing he may gaze upon the deathless principle with deathless spirit, through the deathless water, through the solid and the air; that he may be re-born through reason (or *idea*), that he may be consecrated, and the holy spirit breathe in him, that he may admire the holy fire, that he may behold the abyss of the Orient, dread water, and that he may be heard of the quickening and circumambient ether; for this day he is about to gaze on the revealed reality with deathless eyes; a mortal born of mortal womb, he has been enhanced in excellence by the might of the All-powerful and by the right hand of the Deathless one," &c.

This is but one specimen of the pious ejaculations, which in the first centuries were rising from the lips of thousands of *mystae*, in Egypt, Asia Minor, Italy and elsewhere. The idea of re-birth was in the air; it was the very keynote of all the solemn initiations and mysteries—Mythraic, Orphic, Eleusinian—through which repentant pagans secured pardon and eternal bliss. Yet there is not much evidence that the church directly borrowed many of its ceremonies or interpretations from outside sources. They for the most part originated among the believers, and not improbably the outside cults borrowed as much from the church as it from them.

AUTHORITIES.—The following ancient works are recommended: Tertullian, *De Baptismo* (edition with introd. J. M. Lupton, 1909); Cyril of Jerusalem, *Catecheses*; Basil, *De Spiritu Sancto*; *Constitutiones Apostolicæ*; Gregory Nazianzen, *Orat. 40*; Gregory Nyssa, *Oratio in eos qui differunt baptismum*; *Sacramentary of Serapion of Thmuis*; Augustine, *De Baptismo contra Donatistas*; Jac. Goar, *Rituale Græcorum* (gives the current Greek rites); F. C. Conybeare, *Rituale Armenorum* (the oldest forms of Armenian and Greek rites); Gerard G. Vossius, *De Baptismo* (Amsterdam, 1648); Edmond Martene, *De Ant. Ecclesie Ritiibus* (gives Western rites) (Bassani, 1788). The modern literature is infinite; perhaps the most exhaustive works are W. F. Höfling, *Das Sacrament der Taufe* (Erlangen, 1859); Jos. Bingham's *Antiquities* (London, 1834), and W. Wall, *On Infant Baptism* (London, 1707); J. Anrich, *Das antike Mysterienwesen* (Göttingen, 1894), details the corresponding rites of the Greek mysteries, also A. Dieterich, *Eine Mithras Liturgie* (Leipzig, 1903); J. C. Suicer, *Theosaurus, sub voce BAPTISMA*; Ad. Harnack, *Dogmengeschichte* (Freiburg im Br. 1894); L. Duchesne, *Origines du culte chrétien* (Paris, 1898); Mgr. P. Batiffol, *Etudes historiques* (Paris, 1904); J. C. W. Augst, *Denkwürdigkeiten* (Leipzig, 1829-1831); *Monumenta Ecclesie Liturgica* by Dom Cabrol and Dom Leclercq (Paris, 1902) (a summary of all liturgical passages given in the early Fathers); Corblet, *Histoire du sacrement de baptême* (2 vols. Paris, 1881-1882). (F. C. C.)

BAPTISTE, NICOLAS ANSELME (1761-1835), French actor, was born in Bordeaux on the 18th of June 1761, the elder son of Joseph François Anselme, a popular actor. His mother played leading parts in tragedy, and both his parents enjoyed the protection of Voltaire and the friendship of Lekain. It was probably under the auspices of the latter that Nicolas Anselme made his first appearance as de Belloy in *Gaston et Bayard*; and shortly afterwards, under the name of Baptiste, he made a contract to play young lover parts at Arras, where he also appeared in opera and even in pantomime. From Rouen, where he had three successful years, his reputation spread to Paris and he was summoned to the new theatre which the comedian Langlois-Courcelles had just founded, and where he succeeded, not only in making an engagement for himself, but in bringing all his family, father, mother, wife and brother. They were thus distinguished in the playbills: Baptiste, *ainé*, Baptiste *père*, Baptiste *cadet*, Madame Baptiste *mère*, Madame Baptiste *bru*. This resulted in the pun of calling a play in which they all appeared *une pièce de baptême*. Nicolas soon obtained the public favour, specially in *L. Martellière's* mediocre *Robert, chef de*

brigands, and as Count Almaviva in Beaumarchais' *La Mère coupable*. His success in this was so great that the directors of the Théâtre de la République—who had already secured Talma, Dugazon and Madame Vestris—hastened to obtain his services, and, in order to get him at once (1793), paid the 20,000 francs forfeit which he was obliged to surrender on breaking his contract. Later he, as well as his younger brother, became *sociétaire*. Nicolas took all the leading parts in comedy and tragedy. As he grew older his special *forte* lay in noble fathers. After a brilliant career of thirty-five years of uninterrupted service, he retired in 1828. But, after the revolution of 1830, when the Théâtre Français was in great straits, the brothers Baptiste came to the rescue, reappeared on the stage and helped to bring back its prosperity. The elder died in Paris on the 1st of December 1835. The younger brother, Paul Eustache Anselme, known as BAPTISTE *cadet* (1765–1839), was also a comedian of great talent, and had a long and brilliant career at the Comédie Française, where he made his *début* in 1792 in *L'Amour et l'Intérêt*.

BAPTISTERY (*Baptisterium*, in the Greek Church *φωτιστήριον*), the separate hall or chapel, connected with the early Christian Church, in which the catechumens were instructed and the sacrament of baptism administered. The name baptistery is also given to a kind of chapel in a large church, which serves the same purpose. The baptistery proper was commonly a circular building, although sometimes it had eight and sometimes twelve sides, and consisted of an ante-room (*προαίλιος οίκος*) where the catechumens were instructed, and where before baptism they made their confession of faith, and an inner apartment where the sacrament was administered. In the inner apartment the principal object was the baptismal font (*κολυμβήθρα*, or *pisцина*), in which those to be baptized were immersed thrice. Three steps led down to the floor of the font, and over it was suspended a gold or silver dove; while on the walls were commonly pictures of the scenes in the life of John the Baptist. The font was at first always of stone, but latterly metals were often used. Baptisteries belong to a period of the church when great numbers of adult catechumens were baptized, and when immersion was the rule. We find little or no trace of them before Constantine made Christianity the state religion, *i.e.* before the 4th century; and as early as the 6th century the baptismal font was built in the porch of the church and then in the church itself. After the 9th century few baptisteries were built, the most noteworthy of later date being those at Pisa, Florence, Padua, Lucca and Parma. Some of the older baptisteries were very large, so large that we hear of councils and synods being held in them. It was necessary to make them large, because in the early Church it was customary for the bishop to baptize all the catechumens in his diocese (and so baptisteries are commonly found attached to the cathedral and not to the parish churches), and also because the rite was performed only thrice in the year. (See BAPTISM.) During the months when there were no baptisms the baptistery doors were sealed with the bishop's seal. Some baptisteries were divided into two parts to separate the sexes; sometimes the church had two baptisteries, one for each sex. A fireplace was often provided to warm the neophytes after immersion. Though baptisteries were forbidden to be used as burial-places by the council of Auxerre (578) they were not uncommonly used as such. Many of the early archbishops of Canterbury were buried in the baptistery there. Baptisteries, we find from the records of early councils, were first built and used to correct the evils arising from the practice of private baptism. As soon as Christianity made such progress that baptism became the rule, and as soon as immersion gave place to sprinkling, the ancient baptisteries were no longer necessary. They are still in general use, however, in Florence and Pisa. The baptistery of the Lateran must be the earliest ecclesiastical building still in use. A large part of it remains as built by Constantine. The central area, where is the basin of the font, is an octagon around which stand eight porphyry columns, with marble capitals and entablature of classical form; outside these are an ambulatory and outer walls forming a larger octagon. Attached to one side, towards the Lateran basilica, is a fine

porch with two noble porphyry columns and richly carved capitals, bases and entablatures. The circular church of Santa Costanza, also of the 4th century, served as a baptistery and contained the tomb of the daughter of Constantine. This is a remarkably perfect structure with a central dome, columns and mosaics of classical fashion. Two side niches contain the earliest known mosaics of distinctively Christian subjects. In one is represented Moses receiving the Old Law, in the other Christ delivers to St Peter the New Law—a charter sealed with the X P monogram.

Another baptistery of the earliest times has recently been excavated at Aquileia. Ruins of an early baptistery have also been found at Salona. At Ravenna exist two famous baptisteries encrusted with fine mosaics, one of them built in the middle of the 5th century, and the other in the 6th. To the latter date also belongs a large baptistery decorated with mosaics at Naples.

In the East the metropolitan baptistery at Constantinople still stands at the side of the mosque which was once the patriarchal church of St Sophia; and many others, in Syria, have been made known to us by recent researches, as also have some belonging to the churches of North Africa. In France the most famous early baptistery is St Jean at Poitiers, and other early examples exist at Riez, Fréjus and Aix. In England, a detached baptistery is known to have been associated with the cathedral of Canterbury.

See Hehle's *Concilien*, *passim*; Du Cange, *Glossary*, article "Baptisterium"; Eusebius, *Hist. Eccl.* x. 4; Bingham's *Antiquities of the Christian Church*, book xi. (W. R. L.)

BAPTISTS, a body of Christians, distinguished, as by their name imports, from other denominations by the view they hold respecting the ordinance of baptism (*q.v.*) This distinctive view, common and peculiar to all Baptists, is that baptism should be administered to believers only. The mode of administration of the ordinance has not always been the same, and some Baptists (*e.g.* the Mennonites) still practise baptism by pouring or sprinkling, but among those who will here be styled *modern* Baptists, the mode of administration is also distinctive, to wit, immersion. It should, however, be borne in mind that immersion is not peculiar to the modern Baptists. It has always been recognized by Paedobaptists as a legitimate mode, and is still practised to the exclusion of other modes by a very large proportion of paedobaptist Christendom (*e.g.* the Orthodox Eastern Church). We shall distinguish here between two main groups of Baptists in Europe: the Anabaptists, now practically extinct, and the modern Baptists whose churches are in nearly every European country and in all other countries where white men reside.

I. THE ANABAPTISTS

The great spiritual movement of the 15th and 16th centuries had for its most general characteristic, revolt against authority. This showed itself not merely in the anti-papal reformation of Luther, but also in the anti-feudal rising of the peasants and in a variety of anti-ecclesiastical movements within the reformation areas themselves. One of the most notable of these radical anti-ecclesiastical movements was that of the Zwickau prophets, (Marcus Stübner, Nikolaus Storch and Thomas Münzer): the most vigorous and notorious that of the Münster Anabaptists. Although they have been called the "harbingers" of the Anabaptists, the characteristic teaching of the Zwickau prophets was not Anabaptism. (See, however, ANABAPTISTS.) For although Münzer repudiated infant baptism in theory, he did not relinquish its practice, nor did he insist on the re-baptism of believers. The characteristic teaching of the Zwickau movement, so closely linked with the peasant rising, was the great emphasis laid upon the "inner word." Divine revelation, said Münzer, was not received from the church, nor from preaching, least of all from the dead letter of the Bible; it was received solely and directly from the Spirit of God. It is this daring faith in divine illumination that brings the Zwickau teachers most nearly into touch with the Anabaptists. But if they are not typical of Anabaptism, still less are the later representatives of the movement in the last sad months at Münster.

The beginnings of the Anabaptist movement proper were in

Zürich, where Wilheld Reubli (1480-1554), Konrad Grebel (d. 1526), Felix Manz (d. 1527) and Simon Strumpf separated from Zwingli and proposed to form a separate church. They repudiated the use of force, advocated a scriptural communism of goods, and asserted that Christians must always exercise love and patience towards each other and so be independent of worldly tribunals. But their most radical doctrine was the rejection of infant baptism as unscriptural. They rapidly gained adherents, among whom was Hans Brödl, pastor of Zollikon. Their refusal, however, to baptize infants, and the formation of a separate church as the outcome of this refusal, brought upon them the condemnation of Zwingli, and a number of them were banished. This act of banishment, however, drove Jörg Blaurock, Konrad Grebel and others to take the step which definitely instituted "Anabaptism": they baptized one another and then partook of the Lord's Supper together. This step took them much farther than the repudiation of paedobaptism. It formed a new religious community, which sought to fashion itself on the model of primitive Christianity, rejecting all tradition and accretions later than New Testament records. Its members claimed to get back to the simple church founded on brotherly love. The result was that their numbers grew with astonishing rapidity, and scholarly saints like Balthasar Hubmaier (ca. 1480-1528) and Hans Denck (ca. 1495-1527) joined them. Hubmaier brought 110 new adherents with him, and in 1525 himself baptized 300 converts. This baptism, however, was not immersion. Blaurock and Grebel baptized each other, and many adherents, kneeling together in an ordinary room. Hubmaier baptized his 300 from one bucket. The mode was sprinkling or pouring. In all this the Anabaptists had maintained one central article of faith that linked them to the Zwickau prophets, belief in conscience, religious feeling, or inner light, as the sole true beginning or ground of religion; and one other article, held with equal vigour and sincerity, that true Christians are like sheep among wolves, and must on no account defend themselves from their enemies or take vengeance for wrong done. Very soon this their faith was put to fiery test. Not only were Catholics and Protestants opposed to them on doctrinal grounds, but the secular powers, fearing that the new teaching was potentially as revolutionary as Münzer's radicalism had been, soon instituted a persecution of the Anabaptists. On the 7th of March 1526 the Zürich Rath issued an edict threatening all who were baptized anew with death by drowning, and in 1529 the emperor Charles V., at the diet of Spire, ordered Anabaptists to be put to death with fire and sword without even the form of ecclesiastical trial. A cruel persecution arose. Manz was drowned at Zürich and Michael Sattler (ca. 1495-1527) burned to death after torture in 1527; Hubmaier was burned in 1528 and Blaurock in 1529, and Sebastian Franck (1499-1542) asserts that the number of slain was in 1530 already about 2000.

Two results followed from this persecution. First, the development of a self-contained and homogeneous community was made impossible. No opportunity for the adoption of any common confession was given. Only a few great doctrines are seen to have been generally held by Anabaptists—such as the baptism of believers only, the rejection of the Lutheran doctrine of justification by faith as one-sided and the simple practice of the breaking of bread. This last, the Anabaptist doctrine of the Lord's Supper, was to the effect that brothers and sisters in Christ should partake in remembrance of the death of Christ, and that they should thereby renew the bond of brotherly love as the basis of neighbourly life. In the second place, the persecution deprived the Anabaptists of the noble leaders who had preached non-resistance and at the same time provoked others to an attitude of vengeance which culminated in the horrors of Münster. For Melchior Hofmann (ca. 1498-1543 or 1544) having taken the Anabaptist teaching to Holland, there arose in Haarlem a preacher of vengeance, Jan Matthisson or Matthiszoon (Matthys) (d. 1534) by name, who, prophesying a speedy end of the world and establishment of the kingdom of heaven, obtained many adherents, and despatched Boekbinder and de Kniper to Münster. Here the attempt was made to realise Matthisson's

ideals. All who did not embrace Anabaptism were driven from Münster (1533), and Bernt Knipperdolling (ca. 1495-1536) became burgomaster. The town was now besieged and Matthisson was killed early in 1534. John (Johann Bockelson) of Leiden (1510-1536) took his place and the town became the scene of the gross licence and cruelty, until in 1535 it was taken by the besieging bishop. Unhappily the Anabaptists have always been remembered by the crimes of John of Leiden and the revelry of Münster. They should really be known by the teaching and martyrdom of Blaurock, Grebel and Hubmaier, and by the gentle learning and piety of Hans Denck—of whom, with many hundred others, "the world was not worthy."

For the teaching of the Anabaptists, see ANABAPTISTS.

Reference has already been made to the reason why a common Anabaptist confession was never made public. Probably, however, the earliest confession of faith of any Baptist community is that given by Zwingli in the second part of his *Elenchus contra Catabaptistas*, published in 1527. Zwingli professes to give it entire, translating it, as he says, *ad verbum* into Latin. Whatever opinion may be held as to the orthodoxy of the seven articles of the Anabaptists, the vehemence with which they were opposed, and the epithets of abuse which were heaped upon the unfortunate sect that maintained them, cannot fail to astonish those used to toleration. Zwingli, who details these articles, as he says, that the world may see that they are "fanatical, stolid, audacious, impious," can scarcely be acquitted of unfairness in joining together two of them,—the fourth and fifth,—thus making the article treat "of the avoiding of abominable pastors in the church" (*Super deviatione abominabilium pastorum in Ecclesia*), though there is nothing about pastors in the fourth article, and nothing about abominations in the fifth, and though in a marginal note he himself explains that the first two copies that were sent him read as he does, but the other copies make two articles, as in fact they evidently are. It is strange that the Protestant Council of Zürich, which had scarcely won its own liberty, and was still in dread of the persecution of the Romanists, should pass the decree which instituted the cruel persecution of the Anabaptists.

After Münster had fallen the harassed remnants of the Anabaptists were gathered together under Menno Simons, who joined them in 1537. His moderation and piety held in check the turbulence of the more fanatical amongst them. He died in 1561 after a life passed amidst continual dangers and conflicts. His name remains as the designation of the Mennonites (*q.v.*), who eventually settled in the Netherlands under the protection of William the Silent, prince of Orange.

Of the introduction of Anabaptist views into England we have no certain knowledge. Fox relates that "the registers of London make mention of certain Dutchmen counted for Anabaptists, of whom ten were put to death in sundry places in the realm, anno 1535; other ten repented and were saved." In 1536 King Henry VIII. issued a proclamation together with articles concerning faith agreed upon by Convocation, in which the clergy are told to instruct the people that they ought to repute and take "the Anabaptists' opinions for detestable heresies and to be utterly condemned." Thomas Fuller (1608-1661) tells us from Stow's *Chronicles* that, in the year 1538, "four Anabaptists, three men and one woman, all Dutch, bare faggots at Paul's Cross, and three days after a man and woman of their sect was burnt in Smithfield." In the reign of Edward VI., after the return of the exiles from Zürich, John Hooper (bishop of Gloucester and Worcester, d. 1555) writes to his friend Bullinger in 1549, that he reads "a public lecture twice in the day to so numerous an audience that the church cannot contain them," and adds, "the Anabaptists flock to the place and give me much trouble." It would seem that at this time they were united together in communities separate from the established Church. Latimer, in 1552, speaks of them as segregating themselves from the company of other men. In the sixth examination of John Philpot (1516-1555) in 1555 we are told that Lord Riche said to him, "All heretics do boast of the Spirit of God, and every one would have a church by himself, as Joan of Kent and the Anabaptists." Philpot was imprisoned

soon after Mary's accession in 1553; and it is very pleasing to find, amidst the records of intense bitterness and rancour which characterized these times, and with which Romanist and Protestant alike assailed the persecuted Anabaptists, a letter of Philpot's, to a friend of his, "prisoner the same time in Newgate," who held the condemned opinions. His friend had written to ask his judgment concerning the baptism of infants. Philpot in a long reply, whilst maintaining the obligation of infant baptism, yet addresses his correspondent as, "dear brother, saint, and fellow-prisoner for the truth of Christ's gospel"; and at the close of his argument he says, "I beseech thee, dear brother in the gospel, follow the steps of the faith of the glorious martyrs in the primitive church, and of such as at this day follow the same."

Many Anabaptist communities existed in England toward the end of the 16th century, particularly in East Anglia, Kent and London. Their most notable representative was Robert Cooke, but they were more notorious for heretical views as to the Virgin Mary (see ANABAPTISTS) than for their anti-paedobaptist position. It was for these views that Joan Boucher of Kent was burnt in 1550. There is no doubt that these prepared the way for the coming of the modern Baptists, but "the truth is that, while the Anabaptists in England raised the question of baptism, they were almost entirely a foreign importation, an alien element; and the rise of the Baptist churches was wholly independent of them."

II. THE MODERN BAPTISTS

1. *Great Britain and Ireland.*—If the Anabaptists of England were not the progenitors of the modern Baptist church, we must look abroad for the beginnings of that movement. Although there were doubtless many who held Baptist views scattered among the Independent communities, it was not until the time of John Smith or Smyth (d. 1612) that the modern Baptist movement in England broke away from Brownism. Smyth was appointed preacher of the city of Lincoln in 1600 as an ordained clergyman, but became a separatist in 1605 or 1606, and, soon after, emigrated under stress of persecution with the Gainsborough Independents to Amsterdam. With Thomas Helwys (ca. 1560-ca. 1616) and Morton he joined the "Ancient" church there, but, coming under Mennonite teaching in 1609, he separated from the Independents, baptized himself (hence he is called the "Se-baptist"), Helwys and others probably according to the Anabaptist or Mennonite fashion of pouring. These then formed the first English Baptist Church which in 1611 published "a declaration of faith of English people remaining at Amsterdam in Holland." The article relating to baptism is as follows:—"That every church is to receive in all their members by baptism upon the confession of their faith and sins, wrought by the preaching of the gospel according to the primitive institution and practice. And therefore churches constituted after any other manner, or of any other persons, are not according to Christ's testament. That baptism or washing with water is the outward manifestation of dying unto sin and walking in newness of life; and therefore in no wise appertaineth to infants." They held "that no church ought to challenge any prerogative over any other"; and that "the magistrate is not to meddle with religion, or matters of conscience nor compel men to this or that form of religion." This is the first known expression of absolute liberty of conscience in any confession of faith.

Smyth died in Holland, but in 1612 Helwys returned to England with his church and formed the first Baptist church worshipping on English soil. The church met in Newgate Street, London, and was the origin of the "General" Baptist denomination. Helwys and his followers were Arminians, repudiating with heat the Calvinistic doctrine of predestination. They thus differed from other Independents. "They also differed on the power of the magistrate in matters of belief and conscience. It was, in short, from their little dingy meeting house . . . that there flashed out, first in England, the absolute doctrine of Religious Liberty" (Prof. Masson). Leonard Busher, the author of "Religious Peace: or a Plea for Liberty of Conscience," was a member of this church.

The next great event in the history of the Baptists (though it should be mentioned that the last execution for heresy in England by burning was that of a Baptist, Edward Wightman, at Lichfield 1612) is the rise of the first Calvinistic or Particular Baptist Church. This was the Jacob church in Southwark, which numbered among its members John Lothrop or Latthrop (d. 1653), Praise-God Barbon (ca. 1596-1679), Henry Jessey (1601-1663), Hanserd Knollys (ca. 1599-1691) and William Kiffin (1616-1701). It was originally Independent but then became Baptist. From this six other churches sprang, five of which were Baptist. Before the Jacob church, however, had itself become Baptist, it dismissed from its membership a group of its members (the church having grown beyond what was regarded as proper limits) who, in 1633, became the first Particular Baptist Church.

Thus there were now in existence in England two sets of Baptists whose origins were quite distinct and who never had any real intercourse as churches. They differed in many respects. The General Baptists were Arminian, owing to the influence of the Mennonite Anabaptists. The Particular Baptists were Calvinist, springing as they did from the Independents. But on the question of Baptism both groups, while they utterly rejected the baptism of infants, were as yet unpledged to immersion and rarely practised it. The development of their doctrine as to baptism was marked along three lines of dispute:—(1) who is the proper administrator of baptism? (2) who are the proper subjects? and (3) what is the proper mode? Eventually agreement was reached, and in 1644 a Confession of Faith was published in the names of the Particular Baptist churches of London, now grown to seven, "commonly (though falsely) called Anabaptist."

The article on baptism is as follows:—"That baptism is an ordinance of the New Testament given by Christ to be dispensed only upon persons professing faith, or that are disciples, or taught, who, upon a profession of faith, ought to be baptized." "The way and manner of dispensing this ordinance the Scripture holds out to be dipping or plunging the whole body under water." They further declare (particularly in order that they may avoid the charge of being Anabaptists) that "a civil magistracy is an ordinance of God," which they are bound to obey. They speak of the "breathing time" which they have had of late, and their hope that God would, as they say, "incline the magistrates' hearts so for to tender our consciences as that we might be protected by them from wrong, injury, oppression and molestation"; and then they proceed: "But if God withhold the magistrates' allowance and furtherance herein, yet we must, notwithstanding, proceed together in Christian communion, not daring to give place to suspend our practice, but to walk in obedience to Christ in the profession and holding forth this faith before mentioned, even in the midst of all trials and afflictions, not accounting our goods, lands, wives, children, fathers, mothers, brethren, sisters, yea, and our own lives, dear unto us, so that we may finish our course with joy; remembering always that we ought to obey God rather than men." They end their confession thus: "If any take this that we have said to be heresy, then do we with the apostle freely confess, that after the way which they call heresy worship we the God of our fathers, believing all things which are written in the Law and in the Prophets and Apostles, desiring from our souls to disclaim all heresies and opinions which are not after Christ, and to be steadfast, unmovable, always abounding in the work of the Lord, as knowing our labour shall not be in vain in the Lord." The "breathing time" was not of long continuance. Soon after the Restoration (1660) the meetings of nonconformists were continually disturbed and preachers were fined or imprisoned. One instance of these persecutions will, perhaps, be more impressive than any general statements. In the records of the Broadmead Baptist Church, Bristol, we find this remark: "On the 20th of November 1685 our pastor, Brother Fownes, died in Gloucester jail, having been kept there for two years and about nine months a prisoner, unjustly and maliciously, for the testimony of Jesus and preaching the gospel. He was a man of great learning, of a sound judgment, an able preacher, having great knowledge in divinity, law, physic, &c.; a bold and patient sufferer for the Lord Jesus and the gospel he preached."

With the Revolution of 1688, and the passing of the Act of Toleration in 1689, the history of the persecution of Baptists, as well as of other Protestant dissenters, ends. The removal of the remaining disabilities, such as those imposed by the Test and Corporation Acts repealed in 1828, has no special bearing on Baptists more than on other nonconformists. The ministers of the "three denominations of dissenters,"—Presbyterians, Independents and Baptists,—resident in London and the neighbourhood, had the privilege accorded to them of presenting on proper occasions an address to the sovereign in state, a privilege which they still enjoy under the name of "the General Body of Protestant Dissenting Ministers of the three Denominations." The "General Body" was not organized until 1727.

The Baptists, having had a double origin, continued for many years in two sections—those who in accordance with Arminian views held the doctrine of "General Redemption," and those who, agreeing with the Calvinistic theory, held the doctrine of "Particular Redemption"; and hence they were known respectively as General Baptists and Particular Baptists. In the 18th century many of the General Baptists gradually adopted the Arian, or, perhaps, the Socinian theory; whilst, on the other hand, the Calvinism of the Particular Baptists in many of the churches became more rigid, and approached or actually became Antinomianism. In 1770 the orthodox portion of the General Baptists, mainly under the influence of Dan Taylor (b. 1738), formed themselves into a separate association, under the name of the General Baptist New Connection, since which time the "Old Connection" has gradually merged into the Unitarian denomination. By the beginning of the 19th century the New Connection numbered 40 churches and 3400 members. The old General Baptists "still keep up a shadowy legal existence." Towards the end of the 18th century many of the Particular Baptist churches became more moderate in their Calvinism, a result largely attributable to the writings of Andrew Fuller. Up to this time a great majority of the Baptists admitted none either to membership or communion who were not baptized, the principal exception being the churches in Bedfordshire and Hertfordshire, founded or influenced by Bunyan, who maintained that difference of opinion in respect to water baptism was no bar to communion. At the beginning of the 19th century this question was the occasion of great and long-continued discussion, in which the celebrated Robert Hall (1764–1831) took a principal part. The practice of mixed communion gradually spread in the denomination. Still more recently many Baptist churches have considered it right to admit to full membership persons professing faith in Christ, who do not agree with them respecting the ordinance of baptism. Such churches justify their practice on the ground that they ought to grant to all their fellow-Christians the same right of private judgment as they claim for themselves. It may not be out of place here to correct the mistake, which is by no means uncommon, that the terms Particular and General as applied to Baptist congregations were intended to express this difference in their practice, whereas these terms related, as has been already said, to the difference in their doctrinal views. The difference now under consideration is expressed by the terms "strict" and "open," according as communion (or membership) is or is not confined to persons who, according to their view, are baptized.

In 1801, largely under the influence of Dr John Clifford, a leading General Baptist, the two denominations, General and Particular, were united, there being now but one body called "The Baptist Union of Great Britain and Ireland." This Union, however, is purely voluntary, and some Baptist churches, a few of them prosperous and powerful, hold aloof from their sister churches so far as organization is concerned.

There are other Baptist bodies outside the Baptist Union beside certain isolated churches. Throughout England there are many "strict" Baptist churches which really form a separate denomination. For the most part they are linked together according to geographical distribution in associations, such as the "Metropolitan Association of Strict Baptist Churches," and the "Suffolk and Norfolk Association of Particular Baptist Churches." In the latter case the name "Particular" is preferred, but the association holds aloof from other Baptist churches because its principles are "strict."

There is, however, no national Union. Indeed, the Strict Baptists are themselves divided into the "Standard" and "Vessel" parties—names derived from the "Gospel Standard" and "Earthen Vessel," the organs of the rival groups.

The general characteristic of the Strict Baptists is their rigorous adherence to a type of Calvinistic theology now generally obsolete, and their insistence upon baptism as the condition of Christian communion. Their loose organization makes it impossible to obtain accurate statistics, but the number of their adherents is small. There is a strict Baptist Missionary Society (founded 1866, re-founded 1897) which conducts mission work in South India. The income of this society was £1146 in 1905. It comprises 730 church members and 72 pastors and workers.

The Baptists early felt the necessity of providing an educated ministry for their congregations. Some of their leading pastors had been educated in one or other of the English universities. Others had by their own efforts obtained a large amount of learning, amongst whom Dr John Gill was eminent for his knowledge of Hebrew, as shown in his *Exposition of the Holy Scriptures*, a work in 9 vols. folio, 1746–1766.

Edward Terrill, who died in 1688, left a considerable part of his estate for the instruction of young men desiring to be trained for the ministry, under the superintendence of the pastor of the Broadmead Church, Bristol, of which he was a member. Other bequests for the same purpose were made, and from the year 1720 the Baptist Academy, as it was then called, received young men as students for the ministry among the Baptists. In 1770 the Bristol Education Society was formed to enlarge this academy; and about the year 1811 the present Bristol Baptist College was erected. In the north of England, a similar institution, though previously supported by the General Baptist Association, was founded in 1804 at Bradford, Yorkshire, which has since been removed to Rawdon, near Leeds. In London another college was formed in 1810 at Stepney; it was removed to Regent's Park in 1856. The Pastors' College in connexion with the Metropolitan Tabernacle was instituted in 1856, and in 1866 the present Baptist College at Manchester was instituted at Bury in the interests of the "strict" Baptist views. Besides these, which were voluntary colleges not under denominational control, the General Baptists maintained a college since 1797, which, since the amalgamation of the two Baptist bodies, has become a voluntary institution, though previously supported by the General Baptist Association. It is called the "Midland Baptist College," and is situated in Nottingham. There is also a Baptist theological college in Glasgow, and there are two colleges in Wales and one in Ireland. The total number of students in these institutions is about 210.

The Baptists were the first denomination of British Christians to undertake in a systematic way that work of missions to the heathen, which became so prominent a feature in the religious activity of the 19th century. As early as the year 1784 the Northamptonshire Association of Ministers was formed, and in 1804 the first Monday of every month should be set apart for prayer for the spread of the gospel. Shortly after, in 1792, the Baptist Missionary Society was formed at Kettering in Northamptonshire, after a sermon on Isaiah liii. 2, 3, preached by William Carey (1761–1834), the prime mover in the work, in which he urged two points: "Expect great things from God; attempt great things for God." In the course of the following year Carey sailed for India, where he was joined a few years later by Marshman and Ward, and the mission was established at Serampore. The great work of Dr Carey's life was the translation of the Bible into the various languages and dialects of India. The society's operations are now carried on, not only in the East, but in the West Indies, China, Africa (chiefly on the Congo river), and Europe.

In regard to church government, the Baptists agree with the Congregationalists that each separate church is complete in itself, and has, therefore, power to choose its own ministers and to make such regulations as it deems to be most in accordance with the purpose of its existence, that is, the advancement of the kingdom of Christ. A comparatively small section of the denomination maintain that a "plurality of elders" or pastors is required for the complete organization of every separate church. This is the distinctive peculiarity of those churches in Scotland and the north of England which are known as *Scotch Baptists*. The largest church of this section, consisting of approximately 500 members, originated in Edinburgh in 1765, before which date only one Baptist church—that of Keiss in Caithness, formed about 1750—appears to have existed in Scotland. The greater number of the churches are united in association voluntarily formed, all of them determined by geographical limits. The associations, as well as the churches not in connexion with them, are united together in the Baptist Union of Great Britain and Ireland, formed in 1832, by the voluntary Baptists. This union, however, exerts no authoritative action over its separate churches. One important part of the work of the union is the collection of information in which all the churches are interested. In 1909 there were in the United Kingdom: Baptist churches, 3046; chapels, 4124; sittings, 1,450,352; members, 424,008; Sunday school teachers, 58,687; Sunday scholars, 578,344; local preachers, 5615; and pastors in charge, 2078.

At the beginning of the 20th century the Baptist Union collected a "Twentieth Century Fund" of £250,000, which has largely assisted the formation of new churches, and gives an indication of

the unity and virility of the denomination. A still stronger evidence to the same effect was given by the Religious Census taken in 1904. While this only applied to London, its results are valuable as showing the comparative strength of the Baptist Church. These results are to the effect that in all respects the Baptists come second to the Anglicans in the following three particulars:—(1) Percentage of attendances at public worship contributed by Baptists, 10.81 (London County), 10.70 (Greater London); (2) aggregate of attendances, 54,597; (3) number of places of worship, 443.

2. *The Continent of Europe.*—During the 19th century what we have called the modern Baptist movement made its appearance in nearly every European country. In Roman Catholic countries Baptist churches were formed by missionaries coming from either England or America: work in France began in 1832, in Italy missions were started in 1866 (Spezia Mission) and in 1884 (Baptist Missionary Society, which also has a mission in Brittany), and in Spain in 1888. In Protestant countries and in Russia the Baptist movement began without missionary intervention from England or America. J. G. Oncken (1800-1884) formed the first church in Hamburg in 1834, and thereafter Baptist churches were formed in other countries as follows:—Denmark (1839), Holland and Sweden (1848), Switzerland (1849), Norway (1860), Austria and Rumania (1860), Hungary (1871), and Bulgaria (1884). Baptist churches also began to be formed in Russia and Finland in the 'fifties and 'sixties.

3. *British Colonies.*—In every colony the Baptists have a considerable place. There are unions of Baptist churches in the following colonies:—New South Wales, Victoria, S. Australia, Western Australia, Queensland, New Zealand, Tasmania, Canada (four Unions) and S. Africa. The work in S. Africa is assisted by the Baptist South African Missionary and Colonial Aid Society, having its seat in London.

The Baptist World Alliance was formed in 1905, when the first Baptist World Congress was held in London. The preamble of the constitution of this Alliance sufficiently indicates its nature: "Whereas, in the providence of God, the time has come when it seems fitting more fully to manifest the essential oneness in the Lord Jesus Christ, as their God and Saviour, of the churches of the Baptist order and faith throughout the world, and to promote the spirit of fellowship, service and co-operation among them, while recognizing the independence of each particular church and not assuming the functions of any existing organization, it is agreed to form a Baptist alliance, extending over every part of the world." This alliance does in fact include Baptists in every quarter of the globe, as will be seen from the following statistics:—

United States—	Churches.	Members.
National Baptist Convention	16,996	2,110,269
Southern Baptist Convention	20,431	1,632,638
"Disciples of Christ"	11,157	1,235,798
Thirty-five Northern States	8,804	986,521
Fourteen other Bodies	7,921	141,775
Australasia	270	23,253
Canada	985	103,062
S. Africa	52	4,865
United Kingdom	2,934	426,563
Austria Hungary	37	9,783
Denmark	29	3,954
Finland	43	2,301
France	28	2,278
Germany	180	32,462
Italy	53	1,375
Mexico and Central America	38	1,820
Netherlands	22	1,413
Norway	39	2,849
Rumania and Bulgaria	5	374
¹ Russia and Poland	131	24,136
S. America	63	3,641
Spain	7	245
Sweden	567	43,305
Switzerland	8	796
West Indies	318	42,310
Ceylon	25	1,044
China	137	12,160

¹ The figures for Russia include only the German-speaking Baptists. It is impossible to ascertain the numbers of properly Russian Baptists. Estimates have been made which vary from 60,000 to 100,000.

India	1,215	121,716
Japan	40	2,326
Palestine	1	106
Philippines	4	425
Congo	21	4,973
West Africa	10	629
Total	72,681	7,454,165

In 1900 the comparative totals were roughly:—72,988 churches; 7,480,940 members. In both sets of figures the Disciples of Christ (U.S.A.) are included.

LITERATURE.—Thomas Crosby, *The History of the English Baptists* (4 vols. London, 1738-1740); D. Masson, *Life of John Milton in Connexion with the History of his Time* (6 vols. 1850-1880, new ed. 1881, &c.); B. Evans, *The Early English Baptists*, i. ii. (1862-1864); H. C. Vedder, *A Short History of the Baptists* (London, 1897); A. H. Newman, *A Manual of Church History* (Philadelphia, 1900-1903); R. Heath, *Anabaptism* (1895); C. Williams, *The Principles and Practices of the Baptists* (1903); E. C. Pike, *The Story of the Anabaptists* (1904); J. H. Shakespear, *Baptist and Congregational Pioneers*; J. C. Lehmann, *Geschichte der deutschen Baptisten* (1895-1900); G. Tumbült, *Die Wiedertäufer* (Bielefeld, 1899); *The Baptist Handbook* (annually); *The Baptist World Congress 1905*; *The Religious Census of London* (1904). (N. H. M.)

4. *United States of America.*—The first Baptist Church in America was that founded in the Providence settlement on Narragansett Bay under the leadership of Roger Williams (q.v.). Having been sentenced to banishment (October 1635) by the Massachusetts Court because of his persistence in advocating separatist views deemed unsettling and dangerous, to escape deportation to England he betook himself (January 1636) to the wilderness, where he was hospitably entertained by the natives who gave him a tract of land for a settlement. Having been joined by a few friends from Massachusetts, Williams founded a commonwealth in which absolute religious liberty was combined with civil democracy. In the firm conviction that churches of Christ should be made up exclusively of regenerate members, the baptism of infants appeared to him not only valueless but a perversion of a Christian ordinance. About March 1639, with eleven others, he decided to restore believers' baptism and to form a church of baptized believers. Ezekiel Holliman, who had been with him at Plymouth and shared his separatist views, first baptized Williams and Williams baptized the rest of the company. Williams did not long continue to find satisfaction in the step he had taken. Believing that the ordinances and apostolic church organization had been lost in the general apostasy, he became convinced that it was presumptuous for any man or company of men to undertake their restoration without a special divine commission. He felt compelled to withdraw from the church and to assume the position of a seeker. He continued on friendly terms with the Baptists of Providence, and in his writings he expressed the conviction that their practice came nearer than that of other communities to the first practice of Christ.

In November 1637 John Clarke (1609-1676), a physician, of religious zeal and theological acumen, arrived at Boston, where, instead of the religious freedom he was seeking, he found the dominant party in the Antinomian controversy on the point of banishing the Antinomian minority, including Mrs Anne Hutchinson (q.v.) and her family, John Wheelwright (c. 1592-1679), and William Codding (1601-1678). Whether from sympathy with the persecuted or aversion to the persecutors, he cast in his lot with the former and after two unsuccessful attempts at settlement assisted the fugitives in forming a colony on the island of Aquidneck (Rhode Island), procured from the Indians through the good offices of Williams. By 1641 there were, according to John Winthrop, "professed Anabaptists" on the island, and Clarke was probably their leader. Robert Lenthall, who joined the Newport company in 1640 when driven from Massachusetts, probably brought with him antipaedobaptist convictions. Mrs Scott, sister of Mrs Hutchinson, is thought to have been an aggressive antipaedobaptist when the colony was founded. Mark Lucar, who was baptized by immersion in London in January 1642 (N.S.) and was a member of a Baptist church there, reached Newport about 1644. A few years later we find

him associated with Clarke as one of the most active members of the Newport church, and as the date of the organization is uncertain, there is some reason to suspect that he was a constituent member, and that as a baptized man he took the initiative in baptizing and organizing. At any rate we have in Lucar an interesting connecting link between early English and American Baptists.

The Providence church maintained a rather feeble existence after Williams's withdrawal, with Thomas Olney (d. 1682), William Wickenden, Chad Brown (d. 1665) and Gregory Dexter as leading members. A schism occurred in 1652, the last three with a majority of the members contending for general redemption and for the laying on of hands as indispensable to fellowship, Olney, with the minority, maintaining particular redemption and rejecting the laying on of hands as an ordinance. Olney's party became extinct soon after his death in 1682. The surviving church became involved in Socinianism and Universalism, but maintained a somewhat vigorous life and, through Wickenden and others, exerted considerable influence at Newport, in Connecticut, New York and elsewhere. Dexter became, with Williams and Clarke, a leading statesman in Rhode Island and Providence Plantations.

The Newport church extended its influence into Massachusetts, and in 1649 we find a group of Baptists at Rehoboth, with Obadiah Holmes as leader. The intolerance of the authorities rendered the prosecution of the work impracticable and these Massachusetts Baptists became members of the Newport church. In 1651 Clarke, Holmes and Joseph Crandall of the Newport church made a religious visit to Lynn, Mass. While holding a meeting in a private house they were arrested and were compelled to attend the church services of the standing order. For holding an unlawful meeting and refusing to participate quietly in the public service they were fined, imprisoned and otherwise maltreated. While in England on public business in 1652, Clarke published *III News from New England*, which contained an impressive account of the proceedings against himself and his brethren at Lynn, and an earnest and well-reasoned plea for liberty of conscience.

Henry Dunster (1612-1650), the first president of the college at Cambridge (Harvard), had by 1653 become convinced that "visible believers only should be baptized." Being unwilling to hold his views in abeyance, he relinquished in 1654, under circumstances of considerable hardship, the work that he greatly loved.

In 1663 John Myles (1621-1683), a Welsh Baptist who had been one of Cromwell's Tryers, with his congregation, took refuge in Massachusetts from the intolerance of the government of Charles II. They were allowed to settle in Rehoboth, Mass., and even after they were discovered to be Baptists they were allowed to remain on condition of establishing their meeting-place at a considerable distance from that of the standing order. Myles did much to promote the growth of the Baptist Church in Massachusetts, and was of service to the denomination in Boston and elsewhere. Thomas Gould of Charlestown seems to have been in close touch with President Dunster and to have shared his antipaedobaptist views as early as 1654. Some time before 1665 several English Baptists had settled in the neighbourhood of Boston and several others had adopted Baptist views. These, with Gould, were baptized (May 1665) and joined with those who had been baptized in England in a church covenant. The church was severely persecuted, the members being frequently imprisoned and fined and denied the use of a building they had erected as a meeting-house. Long after the Act of Toleration (1689) was in full force in England, the Boston Baptists pleaded in vain for the privileges to which they were thereby entitled, and it required the most earnest efforts of English Baptists and other dissenters to gain for them a recognition of the right to exist. A mandate from Charles II. (July 1679), in which the Massachusetts authorities were sharply rebuked for denying to others the liberty to secure which they themselves had gone into exile, had produced little effect.

In 1683 William Screven (1629-1713) and Humphrey Churchwood, members of the Boston church, gathered and organized, with the co-operation of the mother church, a small congregation

at Kittery, Me. Persecution led to migration, Screven and some of the members making their way to South Carolina, where, with a number of English Baptists of wealth and position, what became the First Baptist church in Charleston, was organized (about 1684). This became one of the most important of early Baptist centres, and through Screven's efforts Baptist principles became widely disseminated throughout that region. The withdrawal of members to form other churches in the neighbourhood and the intrusion of Socinianism almost extinguished the Charleston church about 1746.

A few Baptists of the general (Arminian) type appeared in Virginia from 1714 onward, and were organized and fostered by missionaries from the English General Baptists. By 1727 they had invaded North Carolina and a church was constituted there.

From 1643 onward antipaedobaptists from New England and elsewhere had settled in the New Netherlands (New York). Lady Deborah Moody left Massachusetts for the New Netherlands in 1643 because of her antipaedobaptist views and on her way stopped at New Haven, where she won to her principles Mrs Eaton, the wife of the governor, Theophilus Eaton. She settled at Gravesend (now part of Brooklyn) having received from the Dutch authorities a guarantee of religious liberty. Francis Doughty, an English Baptist, who had spent some time in Rhode Island, laboured in this region in 1656 and baptized a number of converts. This latter proceeding led to his banishment. Later in the same year William Wickenden of Providence evangelized and administered the ordinances at Flushing, but was heavily fined and banished. From 1711 onward Valentine Wightman (1681-1747) of Connecticut (General Baptist) made occasional missionary visits to New York at the invitation of Nicolas Eyres, a business man who had adopted Baptist views, and in 1714 baptized Eyres and several others, and assisted them in organizing a church. The church was well-nigh wrecked (1730) by debt incurred in the erection of a meeting-house. A number of Baptists settled on Block Island about 1663. Some time before 1724 a Baptist church (probably Arminian) was formed at Oyster Bay.

The Quaker colonies, with their large measure of religious liberty, early attracted a considerable number of Baptists from New England, England and Wales. About 1684 a Baptist church was founded at Cold Spring, Bucks county, Pa., through the efforts of Thomas Dungan, an Irish Baptist minister who had spent some time in Rhode Island. The Pennepek church was formed in 1688 through the labours of Elias Keach, son of Benjamin Keach (1640-1704), the famous English evangelist. Services were held in Philadelphia under the auspices of the Pennepek church from 1687 onward, but independent organization did not occur till 1698. Several Keithian Quakers united with the church, which ultimately became possessed of the Keithian meeting-house. Almost from the beginning general meetings had been held by the churches of these colonies. In 1707 the Philadelphia Association was formed as a delegated body "to consult about such things as were wanting in the churches and to set them in order." From its inception this body proved highly influential in promoting Baptist co-operation in missionary and educational work, in efforts to supply the churches with suitable ministers and to silence unworthy ones, and in maintaining sound doctrine. Sabbatarianism appeared within the bounds of the association at an early date and Seventh-day Baptist churches were formed (1705 onward).

The decades preceding the "Great Awakening" of 1740-1743 were a time of religious declension. A Socinianized Arminianism had paralysed evangelistic effort. The First Church, Providence, had long since become Arminian and held aloof from the evangelism of Edwards, Whitefield and their coadjutors. The First Church, Boston, had become Socinianized and discountenanced the revival. The First Church, Newport, had been rent asunder by Arminianism, and the nominally Calvinistic remnant had itself become divided on the question of the laying on of hands and showed no sympathy with the Great Awakening. The First Church, Charleston, had been wrecked by Socinianism. The General (Six Principles) Baptists of Rhode Island and

Connecticut had increased their congregations and membership, and before the beginning of the 18th century had inaugurated annual associational meetings. But the fact that the Great Awakening in America was conducted on Calvinistic principles was sufficient to prevent their hearty co-operation. The churches of the Philadelphia Association were organized and engaged to some extent in missionary endeavour, but they showed little interest in the Edwards-Whitefield movement. And yet the Baptists ultimately profited by the Great Awakening beyond almost any of the denominations. In many New England communities a majority in the churches of the standing order bitterly opposed the new evangelism, and those who came under its influence felt constrained to organize "Separate" or "New Light" churches. These were severely persecuted by the dominant party and were denied even the scanty privileges that Baptists had succeeded in gaining. As the chief objection of the "Separates" to the churches of the standing order was their refusal to insist on personal regeneration as a term of membership, many of them were led to feel that they were inconsistent in requiring regenerate membership and yet administering baptism to unconscious infants. In several cases entire "Separate" churches reached the conviction that the baptism of infants was not only without Scriptural warrant but was a chief cornerstone of state-churchism, and transformed themselves into Baptist churches. In many cases a division of sentiment came to prevail on the matter of infant-baptism, and for a while mutual toleration prevailed; but mixed churches had their manifest disadvantages and separation ultimately ensued.

Among the Baptist leaders gained from Congregationalism as a result of the awakening was Isaac Backus (1724-1806), who became the New England champion in the cause of religious liberty and equality, and the historian of his denomination. To Daniel Marshall (d. 1784) and Shubael Stearns, "New Light" evangelists who became Baptists, the spread of Baptist principles and the multiplication of Baptist churches throughout the southern colonies were in great measure due. The feeble Baptist cause in Virginia and North Carolina had been considerably strengthened by missionaries from the churches of the Philadelphia Association, including Benjamin Griffith, John Gato (1727-1804), John Thomas, Benjamin Miller, Samuel Eaton, John Garrard and David Thomas, and several churches, formed or reformed under their influence, united with the association. In 1776 the Ketockton Association was formed by this group of churches. The Virginia colonial government, in earlier days cruelly intolerant, gave a limited toleration to Baptists of this type; but the "Separate" Baptists were too enthusiastic and too much alive to the evils of state control in religious matters to be willing to take out licences for their meetings, and soon came into sharp conflict with the authorities. Stearns was an evangelist of great power. With Marshall, his brother-in-law, and about a dozen fellow-believers he settled at Sandy Creek, North Carolina, and in a few years had built up a church with a membership of more than six hundred. Marshall afterward organized and ministered to a church at Abbott's Creek about 30 m. distant. From these centres "Separate" Baptist influence spread throughout North and South Carolina and across the Georgia border, Marshall himself finally settling and forming a church at Kiokee, Georgia. From North Carolina as a centre "Separate" Baptist influence permeated Virginia and extended into Kentucky and Tennessee. The Sandy Creek Association came to embrace churches in several colonies, and Stearns, desirous of preserving the harmonious working of the churches that recognized his leadership, resisted with vehemence all proposals for the formation of other associations.

From 1760 to 1770 the growth of the "Separate" Baptist body in Virginia and the Carolinas was phenomenal. Evangelists like Samuel Harris (1724-c.1794) and John Waller (1741-1802) stirred whole communities and established Baptist churches where the Baptist name had hitherto been unknown. The Sandy Creek Association, with Stearns as leader, undertook to "unfellowship ordinations, ministers and churches that acted independently," and provoked such opposition that a division

of the association became necessary. The General Association of Virginia and the Congaree Association of South Carolina now took their places side by side with the Sandy Creek. The Virginia "Separate" Baptists had more than doubled their numbers in the two years from May 1771 to May 1773. In 1774 some of the Virginia brethren became convinced that the apostolic office was meant to be perpetuated and induced the association to appoint an apostle. Samuel Harris was the unanimous choice and was solemnly ordained. Waller and Elijah Craig (1743-1800) were made apostles soon afterward for the northern district. This arrangement, soon abandoned, was no doubt suggested by Methodist superintendency. In 1775 Methodist influence appeared in the contention of two of the apostles and Jeremiah Walker for universal redemption. Schism was narrowly averted by conciliatory statements on both sides. As a means of preserving harmony the Philadelphia Confession of Faith, a Calvinistic document, with provision against too rigid a construction, was adopted and a step was thus taken toward harmonizing with the "Regular" Baptists of the Philadelphia type. When the General Association was subdivided (1783), a General Committee, made up of delegates from each district association, was constituted to consider matters that might be for the good of the whole society. Its chief work was to continue the agitation in which for some years the body had been successfully engaged in favour of religious equality and the entire separation of church and state. Since 1780 the "Separate" Baptists had had the hearty co-operation of the "Regular" Baptists in their struggle for religious liberty and equality. In 1787 the two bodies united and agreed to drop the names "Separate" and "Regular." The success of the Baptists of Virginia in securing step by step the abolition of everything that savoured of religious oppression, involving at last the disestablishment and the disendowment of the Episcopal Church, was due in part to the fact that Virginia Baptists were among the foremost advocates of American independence, while the Episcopal clergy were loyalists and had made themselves obnoxious to the people by using the authority of Great Britain in extorting their tithes from unwilling parishioners, and that they secured the co-operation of free-thinking statesmen like Thomas Jefferson and James Madison and, in most measures, that of the Presbyterians.

The Baptist cause in New England that had profited so largely from the Great Awakening failed to reap a like harvest from the War of Independence. The standing order in New England represented the patriotic and popular party. Baptists lost favour by threatening to appeal to England for a redress of their grievances at the very time when resistance to English oppression was being determined upon. The result was slowness of growth and failure to secure religious liberty. Though a large proportion of the New England Baptists co-operated heartily in the cause of independence, the denomination failed to win the popularity that comes from successful leadership.

About 1762 the Philadelphia Association began to plan for the establishment of a Baptist institution of learning that should serve the entire denomination. Rhode Island was finally fixed upon, partly as the abode of religious liberty and because of its intelligent, influential and relatively wealthy Baptist constituency, the consequent likelihood of procuring a charter from its legislature, and the probability that the co-operation of other denominations in an institution under Baptist control would be available. James Manning (1738-1791), who had just been graduated from Princeton with high honours, was thought of as a suitable leader in the enterprise, and was sent to Rhode Island (1763) to confer with leading men, Baptist and other. As a result a charter was granted by the legislature in 1764, and after a few years of preliminary work at Warren (where the first degrees ever bestowed by a Baptist institution were conferred in 1766), Providence was chosen as the home of the college (1770). Here, with Manning as president and Hezekiah Smith (1737-1805), his class-mate at Princeton, as financial agent and influential supporter, the institution (since 1804 known as Brown University) was for many years the only degree-conferring

institution controlled by Baptists. The Warren Association (1767) was organized under the influence of Manning and Smith on the model of the Philadelphia, and became a chief agency for the consolidation of denominational life, the promotion of denominational education and the securing of religious liberty. Hezekiah Smith was a highly successful evangelist, and through his labours scores of churches were constituted in New England. As chaplain in the American Revolutionary Army he also exerted a widespread influence.

The First Church, Charleston, which had become almost extinct through Arminianism in 1746, entered upon a career of remarkable prosperity in 1749 under the leadership of Oliver Hart (1723-1795), formerly of the Philadelphia Association. In 1751 the Charleston Association was formed, also on the model of the Philadelphia, and proved an element of denominational strength. The association raised funds for domestic missionary work (1755 onward) and for the education of ministers (1756 onward). Brown University shared largely in the liberality of members of this highly-cultivated and progressive body. Among the beneficiaries of the education fund was Samuel Stillman (1737-1807), afterward the honoured pastor of the Boston church. The most noted leader of the Baptists of South Carolina during the four decades following the War of Independence was Richard Furman (1755-1825), pastor of the First Church, Charleston. The remarkable numerical progress of Baptists in South Carolina from 1787 to 1812 (from 1620 members to 11,325) was due to the "Separate" Baptist movement under Stearns and Marshall far more than to the activity of the churches of the Charleston Association. Both these types of Baptist life permeated Georgia, the latter making its influence felt in Savannah, Augusta and the more cultivated communities, the former evangelizing the masses. Many negro slaves became Baptists in Virginia, the Carolinas and Georgia. In most cases they became members of the churches of the white Baptists; but in Richmond, Savannah and some other towns they were encouraged to have churches of their own.

By 1812 there were in the United States 173,972 Baptist church members, the denominational numerical strength having considerably more than doubled since the beginning of the 19th century.

Foreign Missions.—Baptists in Boston and vicinity, Philadelphia and Charleston, and a few other communities had from the beginning of the 19th century taken a deep interest in the missionary work of William Carey, the English missionary, and his coadjutors in India, and had contributed liberally to its support. The conversion to Baptist views of Adoniram Judson (q.v.) and Luther Rice (1812), who had just been sent, with others, by the newly-formed American Board of Commissioners for Foreign Missions to open up missionary work in India, marks an epoch in American Baptist history. Judson appealed to his American brethren to support him in missionary work among the heathen, and Rice returned to America to organize missionary societies to awaken interest in Judson's mission. In January 1813 there was formed in Boston "The Baptist Society for the Propagation of the Gospel in India and other Foreign Parts." Other societies in the Eastern, Middle and Southern states speedily followed. The desirability of a national organization soon became manifest, and in May 1814 thirty-three delegates, representing eleven states, met in Philadelphia and organized the "General Missionary Convention of the Baptist Denomination in the United States of America for Foreign Missions." As its meetings were to be held every three years it came to be known as the "Triennial Convention." A Board of Commissioners was appointed with headquarters in Philadelphia (transferred in 1826 to Boston). The need of a larger supply of educated ministers for home and for mission work alike soon came to be profoundly felt, and resulted in the establishment of Columbian College, Washington (now George Washington University), with its theological department (1821), intended to be a national Baptist institution. Destitution on the frontiers led the Triennial Convention to engage extensively in home mission work (1817 onward), and in 1832 the American Baptist Home Mission Society was constituted for the promotion of this work. The need of an

organ for the dissemination of information, and the quickening of interest in the missionary and educational enterprises of the Triennial Convention, led Rice to establish the *Latter Day Luminary* (1816) and the *Columbian Star*, a weekly journal (1822). From the first the attempt to rouse the denomination to organized effort for the propagation of the gospel met with much opposition, agents of the Convention being looked upon by the less intelligent pastors and churches as highly-paid and irresponsible collectors of money to be used they knew not how, or for purposes of which they disapproved. The fact that Rice was unduly optimistic and allowed the enterprises of the Convention to become almost hopelessly involved in debt, and was constrained to use some of the fund collected for missions to meet the exigencies of his educational and journalistic work, intensified the hostility of those who had suspected from the beginning the good faith of the agents and denied the scriptural authority of boards, paid agents, paid missionaries, &c. So virulent became the opposition that in several states, as Tennessee and Kentucky, the work of the Convention was for years excluded, and a large majority in each association refused to receive into their fellowship those who advocated or contributed to its objects. Hyper-Calvinism, ignorance and avarice cooperated in making the very name "missions" odious, ministerial education an impertinent human effort to supplant a spirit-called and spirit-endowed ministry, Sunday-schools and prayer-meetings as human institutions, the aim of which was to interfere with the divine order, and the receiving of salaries for ministerial work as serving God for hire or rather as serving self. To counteract this influence, Baptist State Conventions were formed by the friends of missions and education, only contributing churches, associations, missionary societies and individuals being invited to membership (1821 onward—Massachusetts had effected state organization in 1802). These came highly efficient in promoting foreign and domestic missions, Sunday-school organization, denominational literature and education. Nearly every state soon had its institutions of learning, which aspired to become universities.

Before 1844 the sessions of the Triennial Convention had occasionally been made unpleasant by harsh anti-slavery utterances by Northern members against their Southern brethren and somewhat acrimonious rejoinders by the latter. The controversy between Francis Wayland and Richard Fuller (1804-1876) on the slavery question ultimately convinced the Southern brethren that separate organization for missionary work was advisable. The Southern Baptist Convention, with its Home and Foreign Missionary Boards, and (later) its Sunday-school Board, was formed in 1845. Since then Northern and Southern Baptists, though in perfect fellowship with each other, have found it best to carry on their home and foreign missionary work through separate boards and to have separate annual meetings. In 1905 a General Baptist Convention for America was formed for the promotion of fellowship, comity and denominational *esprit de corps*, but this organization is not to interfere with the sectional organizations or to undertake any kind of administrative work.

Since 1845 Northern and Southern Baptists alike have greatly increased in numbers, in missionary work, in educational institutions, in literary activity and in everything that pertains to the equipment and organization of a great religious denomination. Since 1812 they have increased in numbers from less than 200,000 to more than 5,000,000. In 1812 American Baptists had no theological seminary; in 1906 they had 11 with more than 100 instructors, 1300 students, and endowments and equipments valued at about \$7,000,000. In 1812 they had only one degree-conferring college with a small faculty, a small student body and almost no endowment; in 1906 they had more than 100 universities and colleges with endowment and equipment valued at about \$50,000,000 and an annual income of about \$3,000,000. In 1812 the value of church property was small; in 1906 it was estimated at \$100,000,000. Then a single monthly magazine, with a circulation of a few hundreds, was all that the denomination possessed in the way of periodical literature; in 1906 its quarterlies, monthlies and weeklies were numbered by hundreds. The denomination has a single publishing concern (the American Baptist Publication Society) with an annual business of nearly \$1,000,000 and assets of \$1,750,000.

Baptists in the Dominion of Canada had their first foothold about the close of the 18th century in migrations from the United States. They have been reinforced by considerable numbers of English, Welsh and Scottish Baptists. They are divided into four sections:—those of the Maritime Provinces, with their Convention, their Home and Foreign Mission Boards, an Education Board and a Publication Board, and with M^{rs} Master University (Arts, Theological and

Academic departments) as its educational institution; those of Manitoba and the North-west, with Brandon College as its educational institution; and those of British Columbia, Canadian Baptists numbered 120,000 in 1909, and are considered in the above general estimates.

(A. H. N.)

BAR, FRANÇOIS DE (1538-1606), French scholar, was born at Seizencourt, near St Quentin, and having studied at the university of Paris entered the order of St Benedict. He soon became prior of the abbey of Anchin, near Pecquencourt, and passed much of his time in the valuable library of the abbey, studying ecclesiastical history, especially that of Flanders. He also made a catalogue of the manuscripts at Anchin and annotated many of them. During the French Revolution his manuscripts passed to the library at Douai. Bar died at Anchin on the 25th of March 1606.

See J. Lelong, *Bibliothèque historique de la France* (Paris, 1768-1778); C. C. A. Dehaisnes, "Catalogue des manuscrits de Douai, in the *Catalogue général des manuscrits des bibliothèques des départements*, t. vi. (Paris, 1849-1885).

BAR, a town of Russia, in the government of Podolia, 50 m. N.E. of Kamenets, on an affluent of the Bug. Pop. (1897) 10,614. It was formerly called Rov. Its present designation was bestowed upon it in memory of Bari in Italy (where she was born) by Bona Sforza, the consort of Sigismund I. of Poland, who rebuilt the town after its destruction in 1452 by the Tatars. From 1672 to 1699 it remained in possession of the Turks. In 1768 a confederation of the Polish nobles (see next article) against the Russians was formed in the town, which was shortly after taken by storm, but did not become finally united to Russia till the partition of 1793.

BAR, CONFEDERATION OF, a famous confederation of the Polish nobles and gentry formed at the little fortress of Bar in Podolia in 1768 to defend the internal and external independence of Poland against the aggressions of the Russian government as represented by her representative at Warsaw, Prince Nicholas Repnin. The originators of this confederation were Adam Krasinski, bishop of Kamenets, Osip Pulawski and Michael Krasinski. King Stanislaus was at first inclined to mediate between the confederates and Russia; but finding this impossible, sent a force against them under the grand hetman Ksawery Branicki and two generals, who captured Bar. Nevertheless, a simultaneous outbreak of a *jacquerie* in Little-Russia contributed to the extension of the confederation throughout the eastern province of Poland and even in Lithuania. The confederates, thereupon, appealed for help abroad and contributed to bring about a war between Russia and Turkey. So serious indeed was the situation that Frederick II. advised Catherine to come to terms with the confederates. Their bands under Ignaty Malchewsky, Michael Pac and Prince Charles Radziwill ravaged the land in every direction, won several engagements over the Russians, and at last, utterly ignoring the king, sent envoys on their own account to the principal European powers. In 1770 the Council of the Confederation was transferred from its original seat in Silesia to Hungary, from whence it conducted diplomatic negotiations with France, Austria and Turkey with the view of forming a league against Russia. The court of Versailles sent Dumouriez to act as commander-in-chief of the confederates, but neither as a soldier nor as a politician did this adroit adventurer particularly distinguish himself, and his account of his experiences is very unfair to the confederates. Among other blunders, he pronounced King Stanislaus a tyrant and a traitor at the very moment when he was about to accede to the Confederation. The king thereupon reverted to the Russian faction and the Confederation lost the confidence of Europe. Nevertheless, its army, thoroughly reorganized by Dumouriez, gallantly maintained the hopeless struggle for some years, and it was not till 1776 that the last traces of it disappeared.

See Alexander Kraushar, *Prince Repnin in Poland* (Pol.) (Warsaw, 1900); F. A. Thesby de Belcourt, *The Confederates of Bar* (Pol.) (Cracow, 1895); Charles François Dumouriez, *Mémoires et correspondance* (Paris, 1834). (R. N. B.)

BAR (O. Fr. *barre*, Late Lat. *barra*, origin unknown), in physical geography, a ridge of sand or silt crossing an estuary under water or raised by wave action above sea-level, forming an impediment

to navigation. When a river enters a tidal sea its rate of flow is checked and the material it carries in suspension is deposited in a shifting bar crossing the channel from bank to bank. Where the channel is only partly closed, a spur of this character is called a "spit." A bar may be produced by tidal action only in an estuary or narrow gulf (as at Port Adelaide) where the tides sweep the loose sand backwards and forwards, depositing it where the motion of the water is checked. Nahant Bay, Mass., is bordered by the ridge of Lynn Beach, which separates it from Lynn Harbor, and ties Nahant to the mainland by a bar formed in this way.

BAR, THE. This term, as equivalent to the profession of barrister (*q.v.*), originated in the partition or bar dividing the English law-courts into two parts, for the purpose of separating the members and officials of the court from the prisoners or suitors, their advocates and the general public. Theoretically, this division of the court is still maintained in England, those who are entitled to sit within the bar including king's counsel, barristers with patents of precedence, sergeants (till the order died out) and solicitors, while the other members of the bar and the general public remain without. Parties in civil suits who appear in person are allowed to stand on the floor within the bar instead of, as formerly, appearing at the bar itself. In criminal trials the accused still stands forward at the bar. There is also a "bar" in parliament. In the House of Commons it remains literally a bar—a long brass rod hidden in a tube from which it is pulled out when required to mark the technical boundary of the House. Before it appear those who are charged with having violated the privileges of the House; below it also sit those members who have been returned at bye-elections, to await their introduction to the House and the taking of the oath of allegiance. In the House of Lords the place where Mr Speaker and the members of the House of Commons stand when summoned by Black Rod is called "the bar."

The "call to the bar" in England, by which a law student at one of the Inns of Court is converted into a barrister, is dealt with under *INNS OF COURT*. The exclusive privilege of calling to the bar belongs to those bodies, which also exercise disciplinary power over their members; but it was widely felt by members of the bar in recent years that the benchers or governing body of their self-elected members did not keep a sufficiently watchful eye on the minutiae of the profession. Consequently, in 1883, a bar committee was formed for the purpose of dealing with all matters relating to the profession, such as the criticizing of proposed legal reforms, and the expression of opinions on matters of professional etiquette, conduct and practice. In 1804 the committee was dissolved, and succeeded by the general council of the bar, elected on a somewhat wider basis. It is composed of a due proportion of king's counsel and outer barristers elected by voting-papers sent to all barristers having an address in the *Law List* within the United Kingdom. Its expenses are paid by contributions from the four Inns of Court. Its powers are not disciplinary, but it would draw the attention of the benchers to any gross violation of the professional etiquette of the bar.

Each state in America has its own bar, consisting of all attorneys-at-law residing within it who have been admitted to practice in its courts. Generally attorneys are admitted in one court to practice in all courts. Each of the United States courts has a bar of its own. An attorney of a state cannot practise in a court of the United States unless he has been admitted to it, or to one of the same class in another district or circuit. He cannot appear in the Supreme Court of the United States unless specially admitted and sworn as an attorney of that court, which is done on motion in case of any one who has practised for three years in the highest courts of his state and is in good standing at its bar. In most of the states there is a state bar association, and in some cities and counties local bar associations. These consist of such members of its bar as desire thus to associate, the object being to guard and advance the standards of the profession. Some own valuable libraries. These associations have no official recognition, but their influence is considerable in

recommending and shaping legislation respecting the judicial establishment and procedure. They also serve a useful purpose in instituting or promoting proceedings to discipline or expel unworthy attorneys from the bar. There is an American Bar Association, founded in 1878, composed of over 3500 members of different states of like character and position. Some of these associations publish annually a volume of transactions. The rights, duties and liabilities of counsellor-at-law are stated under ATTORNEY. As members of the bar of the state in which they practise they are subject to its laws regulating such practice, e.g. in some states they are forbidden to advertise for divorce cases (New York Penal Code [1902] § 148A) (1905, *People v. Taylor* [Colorado], 75 Pac. Rep. 914). It is common throughout the United States for lawyers to make contracts for "contingent fees," i.e. for a percentage of the amount recovered. Such contracts are not champertous and are upheld by the courts, but will be set aside if an unconscionable bargain be made with the client (*Deering v. Scheyer* [N.Y.], 58 App. D. 322). So also by the U.S. Supreme Court (*Wright v. Tebbets*, 91 U.S. 252; *Taylor v. Benis*, 110 U.S. 42). The reason for upholding such contracts is that otherwise poor persons would often fail of securing or protecting their property or rights. In fact such contracts are seldom set aside, though no doubt the practice is capable of abuse.

BARA BANKI, a town and district of British India in the Fyzabad division of the United Provinces. The town, which forms one municipality with Nawabganj, the administrative headquarters of the district, is 17 m. E. of Lucknow by railway. The population of Bara Banki alone in 1901 was 3020. There is some trade in sugar and cotton.

The district has an area of 1758 sq. m. It stretches out in a level plain interspersed with numerous *jhils* or marshes. In the upper part of the district the soil is sandy, while in the lower part it is clayey and produces finer crops. The principal rivers are the Gogra, forming the northern boundary, and the Gumti, flowing through the middle of the district. In 1856 it came, with the rest of Oudh, under British rule. During the Sepoy war of 1857-1858 the whole of the Bara Banki talukdars joined the mutineers, but offered no serious resistance after the capture of Lucknow. The cultivators are still, for the most part, tenants-at-will, rack-rented and debt-ridden. In 1901 the population was 1,179,323, showing an increase of 4% in the decade. The principal crops are rice, wheat, pulse and other food-grains, sugar-cane and opium. Both the bordering rivers are navigable; and the district is traversed by two lines of the Oudh and Rohilkhand railway, with branches. Trade in agricultural produce is active.

BARABOO, a city and the county-seat of Sauk county, Wisconsin, U.S.A., about 37 m. N.W. of Madison, on the Baraboo river, a tributary of the Wisconsin. Pop. (1890) 4605; (1900) 5751, of whom 732 were foreign-born; (1905) 5835; (1910) 6324. The city is served by the Chicago & North-Western railway, which maintains here an engine house and extensive machine shops, and of which it is a division headquarters. Baraboo has an attractive situation on a series of hills about 1000 ft. above sea-level. In the vicinity are Devil's Lake (3 m. S.) and the famous Dells of the Wisconsin river (near Kilbourn, about 12 m. N.), two summer resorts with picturesque scenery. The principal public buildings are the court-house (in a small public park), the public library and a high school. Dairying and the growing of small fruits are important industries in the surrounding region; and there is a large nursery here. Stone quarried in the vicinity is exported, and the city is near the centre of the Sauk county iron range. Among the manufactures are woollen goods, towels, canned fruit and vegetables, dairy products, beer, and circus wagons (the city is the headquarters of the Ringling and the Gollmar circuses). The first permanent settlement here was made in 1830. Baraboo was named in honour of Jean Barbault, an early French trapper, and was chartered as a city in 1882.

BARABRA, a name for the complex Nubian races of the Egyptian Sudan, whose original stock is Hamitic-Berber, long

modified by negro crossings. The word is variously derived from *Berberi*, i.e. people of Berber, or as identical with *Barabara*, figuring in the inscription on a gateway of Tethmosis I. as the name of one of the 113 tribes conquered by him. In a later inscription of Rameses II. at Karnak (c. 1300 B.C.) *Beraberata* is given as that of a southern conquered people. Thus it is suggested that Barabara is a real ethnical name, confused later with Greek and Roman *barbarus*, and revived in its proper meaning subsequent to the Moslem conquest. A tribe living on the banks of the Nile between Wadi Halfa and Assuan are called Barabara. (See further NUBIA.)

BARACALDO, a river-port of north-eastern Spain, in the province of Biscay; on the left bank of the river Nervion or Ansa (in Basque, Ibaizabal), 5 m. by rail N.W. of Bilbao. Pop. (1900) 15,013. Few Spanish towns have developed more rapidly than Baracaldo, which nearly doubled its population between 1880 and 1900. During this period many immigrant labourers settled here; for the ironworks and dynamite factory of Baracaldo prospered greatly, owing to the increased output of the Biscayan mines, the extension of railways in the neighbourhood, and the growth of shipping at Bilbao. The low flat country round Baracaldo is covered with maize, pod fruit and vines.

BARACOA, a seaport city of N.E. Cuba, in Santiago province. Pop. (1907) 5633. The town lies under high hills on a small circular harbour accessible to small craft. The country round about is extremely rugged. The hill called the "Anvil of Baracoa" (about 3000 ft.) is remarkable for its extremely regular formation. It completely dominates the city's background, and is a well-known sailors' landmark. The town is the trading centre of a large plantation region behind it and is the centre of the banana and coconut export trade. There is a fort dating from the middle of the 18th century. Baracoa is the oldest town in Cuba, having been settled by Diego Velazquez in 1512. It held from its foundation the honours of a city. From 1512 to 1514 it was the capital of the island, and from 1518 to 1522 its church was the cathedral of the island's first diocese. Both honours were taken from it to be given to Santiago de Cuba; and for two centuries after this Baracoa remained an obscure village, with little commerce. In the 16th century it was repeatedly plundered by pirates until it came to terms with them, gave them welcome harbourage, and based a less precarious existence upon continuous illicit trade. Until the middle of the 18th century Baracoa was almost without connexion with Havana and Santiago. In the wars of the end of the century it was a place of deposit for French and Spanish corsairs. At this time, too, about 100 fugitive immigrant families from Santo Domingo greatly augmented its industrial importance. In 1807 an unsuccessful attack was made upon the city by an English force. In 1826 the port was opened to foreign commerce.

BARAHONA DE SOTO, LUIS (1535?-1595), Spanish poet, was born about 1535 at Lucena (Cordova), was educated at Granada, and practised as a physician at Córdoba. His principal poem is the *Primera parte de la Angélica* (1586), a continuation of the *Orlando furioso*; the second part was long believed to be lost, but fragments of it have been identified in the anonymous *Diálogos de la montería*, first printed in 1890; the *Diálogos* also embody fragments of a poem by Barahona entitled *Los Principios del mundo*, and many graceful lyrics by the same writer have been published by Francisco Rodriguez Marín. Cervantes describes Barahona as "one of the best poets not only in Spain, but in the whole world"; this is friendly hyperbole. Nevertheless Barahona has high merits: poetic imagination, ingenious fancy, and an exceptional mastery of the methods transplanted to Spain from Italy. His *Angélica* has been reproduced in facsimile (New York, 1904) by Archer M. Huntington.

See F. Rodriguez Marín, *Luis Barahona de Soto, estudio biográfico, bibliográfico, y crítico* (Madrid, 1903); *Diálogos de la montería*, edited by F. R. de Ubagón (Madrid, 1890). (J. F.-K.)

BARANTE, AMABLE GUILLEAUME PROSPER BRUGIÈRE, BARON DE (1782-1866), French statesman and historian, the son of an advocate, was born at Riom on the 10th of June 1782. At the age of sixteen he entered the École Polytechnique at

Paris, and at twenty obtained his first appointment in the civil service. His abilities secured him rapid promotion, and in 1806 he obtained the post of auditor to the council of state. After being employed in several political missions in Germany, Poland and Spain, during the next two years, he became prefect of Vendée. At the time of the return of Napoleon I. he held the prefecture of Nantes, and this post he immediately resigned. On the second restoration of the Bourbons he was made councillor of state and secretary-general of the ministry of the interior. After filling for several years the post of director-general of indirect taxes, he was created in 1819 a peer of France and was prominent among the Liberals. After the revolution of July 1830, M. de Barante was appointed ambassador to Turin, and five years later to St Petersburg. Throughout the reign of Louis Philippe he remained a supporter of the government; and after the fall of the monarchy, in February 1848, he withdrew from political affairs and retired to his country seat in Auvergne. Shortly before his retirement he had been made Grand Cross of the Legion of Honour. Barante's *Histoire des ducs de Bourgogne de la maison de Valois*, which appeared in a series of volumes between 1824 and 1828, procured him immediate admission to the French Academy. Its narrative qualities, and purity of style, won high praise from the romantic school, but it exhibits a lack of the critical sense and of scientific scholarship. Amongst his other literary works are a *Tableau de la littérature française au dix-huitième siècle*, of which several editions were published; *Des communes et de l'aristocratie* (1821); a French translation of the dramatic works of Schiller; *Questions constitutionnelles* (1850); *Histoire de la Convention Nationale*, which appeared in six volumes between 1851 and 1853; *Histoire du Directoire de la République française* (1855); *Études historiques et biographiques* (1857); *La Vie politique de M. Royer-Collard* (1861). The version of *Hamlet* for Guizot's *Shakespeare* was his work. He died on the 22nd of November 1866.

His *Souvenirs* were published by his grandson (Paris, 1890-99). See also the article by Guizot in the *Revue des deux Mondes*, July 1867.

BARASAT, a subdivisional town in the district of the Twenty-four Parganas, Bengal, India. For a considerable time Barasat town was the headquarters of a joint magistracy, known as the "Barasat District," but in 1861, on a readjustment of boundaries Barasat district was abolished by order of government, and was converted into a subdivision of the Twenty-four Parganas. Pop. (1901) 8634. It forms a striking illustration of the rural character of the so-called "towns" in Bengal, and is merely an agglomeration of 41 separate villages, in which all the operations of husbandry go on precisely as in the adjacent hamlets.

BARATIER, JOHANN WILHELM (1721-1740), German scholar of precocious genius, was born at Schwabach near Nuremberg on the 10th of January 1721. His early education was most carefully conducted by his father, the pastor of the French church at Schwabach, and so rapid was his progress that by the time he was five years of age he could speak French, Latin and Dutch with ease, and read Greek fluently. He then studied Hebrew, and in three years was able to translate the Hebrew Bible into Latin or French. He collected materials for a dictionary of rare and difficult Hebrew words, with critical and philological observations; and when he was about eleven years old translated from the Hebrew Tudeła's *Itinerarium*. In his fourteenth year he was admitted master of arts at Halle, and received into the Royal Academy at Berlin. The last years of his short life he devoted to the study of history and antiquities, and had collected materials for histories of the Thirty Years' War and of Antitrinitarianism, and for an *Inquiry concerning Egyptian Antiquities*. His health, which had always been weak, gave way completely under these labours, and he died on the 5th of October 1740. He had published eleven separate works, and left a great quantity of manuscript.

BARATYNSKI, JEWGENIJ ABRAMOVICH (1800-1844), Russian poet, was educated at the royal school at St Petersburg and then entered the army. He served for eight years in Finland, where he composed his first poem *Edu*. Through the interest of friends he obtained leave from the tsar to retire from

the army, and settled in 1827 near Moscow. There he completed his chief work *The Gipsy*, a poem written in the style of Pushkin. He died in 1844 at Naples, whither he had gone for the sake of the milder climate.

A collected edition of his poems appeared at St Petersburg, in 2 vols. in 1835; later editions, Moscow 1869, and Kazan 1884.

BARB. (1) (From Lat. *barba*, a beard), a term used in various senses, of the folds of mucous membrane under the tongue of horses and cattle, and of a disease affecting that part, of the wattles round the mouth of the barbel, of the backward turned points of an arrow and of the piece of folded linen worn over the neck by nuns. (2) (From Fr. *barbe*, meaning "from Barbary"), a name applied to a breed of horses imported by the Moors into Spain from Barbary, and to a breed of pigeons.

BARBACENA, an inland town of Brazil, in the state of Minas Geraes, 150 m. N.N.W. of Rio de Janeiro and about 3500 ft. above sea-level. The surrounding district is chiefly agricultural, producing coffee, sugar-cane, Indian corn and cattle, and the town has considerable commercial importance. It is also noted for its healthiness and possesses a large sanatorium much frequented by convalescents from Rio de Janeiro during the hot season. Barbacena was formerly a principal distributing centre for the mining districts of Minas Geraes, but this distinction was lost when the railways were extended beyond that point.

BARBADOS, or BARBADOES, an island in the British West Indies. It lies 78 m. E. of St Vincent, in 13° 4' N. and 59° 37' W.; is 21 m. long, 14½ m. at its broadest, and 166 sq. m. (106,470 acres) in extent (roughly equalling the Isle of Wight). Its coasts are encircled with coral reefs, extending in some places 3 m. seaward. In its configuration the island is elevated but not mountainous. Near the centre is its apex, Mount Hillaby (1100 ft.), from which the land falls on all sides in a series of terraces to the sea. So gentle is the incline of the hills that in driving over the well-constructed roads the ascent is scarcely noticeable. The only natural harbour is Carlisle Bay on the south-western coast, which, however, is little better than a shallow roadstead, only accessible to light draught vessels.

Geology.—The oldest rocks of Barbados, known as the Scotland series, are of shallow water origin, consisting of coarse grits, brown sandstones and sandy clays, in places saturated with petroleum and traversed by veins of manjak. They have been folded and denuded, so as to form the foundation on which rest the later beds of the island. Upon the denuded edges of the Scotland beds lies the Oceanic series. It includes chalky limestones, siliceous earths, red clay, and, at the top, a layer of mudstone composed mainly of volcanic dust. The limestones contain Globigerina and other Foraminifera, the siliceous beds are made of Radiolaria, sponge spicules and diatoms, while the red clay closely resembles the red clay of the deepest parts of the oceans. There can be no doubt that the whole series was laid down in deep waters. The Oceanic series is generally overlaid directly, and unconformably, by coral limestones; but at Bissex Hill, at the base of the coral limestones, and resting unconformably upon the Oceanic series, there is a Globigerina marl. The Coral Limestone series lies indifferently upon the older beds. Although of no great thickness it covers six-sevenths of the island, rising in a series of steps or platforms to a height of nearly 1100 ft.

Even the Scotland series probably belongs to the Tertiary system, but owing to the want of characteristic fossils, it is impossible to determine with any degree of certainty the precise homotaxis of the several formations. Jukes-Browne and Harrison ascribe the Scotland beds to the Eocene or Oligocene period, the Oceanic series to the Miocene, the Bissex Hill marls to the Pliocene, and the coral limestones partly to the Pliocene and partly to the Pleistocene. But these correlations rest upon imperfect evidence.

Sandstone, and clays suitable for brick-making, are found in the district of Scotland, so called from a fancied resemblance to the Highlands of North Britain. The only other mineral product is manjak, a species of asphalt, also found in this district and to some extent exported.

Climate, &c.—The climate of Barbados is pleasant. The

seasons are divided into wet and dry, the latter (extending from December to the end of May) being also the cold season. The temperature ranges from 70° F. to 86° F., rarely, even on the coldest days, falling below 65° F. The average annual rainfall is about 60 in., September being the wettest month. For eight months the invigorating N.E. trade winds temper the tropical heat. The absence of swamps, the porous nature of the soil, and the extent of cultivation account for the freedom of the island from miasma. Fever is unknown. The climate has a beneficial effect on pulmonary diseases, especially in their earlier stages, and is remarkable in arresting the decay of vital power consequent upon old age. Leprosy occurs amongst the negroes, and elephantiasis is so frequent as to be known as "Barbados leg."

Industries.—The cultivation of sugar was first introduced in the middle of the 17th century, and owing to the cheapness of labour, the extreme fertility of the soil and the care bestowed on its cultivation, became the staple product of the island. Cotton growing has recently become of importance. The few other industries include rum distilleries and factories for chemicals, ice and tobacco. A railway 28 m. long runs from Bridgetown partly round the coast. The island is a place of call for almost all the steamships plying to and from the West Indies, and is a great centre of distribution. There is direct communication at frequent intervals with England, the United States, Canada and the other West Indian islands.

Population and Administration.—The greater part of the inhabitants belong to the Church of England, which exceeds in numbers the combined total of all other denominations. The island is the see of a bishop, who, with the clergy of all creeds, is paid by the government. The chief educational establishment is Codrington College, founded by Colonel Christopher Codrington, who in 1710 bequeathed two estates to the Society for the Propagation of the Gospel. It trains young men for holy orders and is affiliated to the university of Durham. Harrison College and The Lodge are secondary schools for boys, Queen's College for girls. There are several second grade and a large number of primary schools. The colony possesses representative institutions but not responsible government. The crown has a veto on legislation and the home government appoints the public officials, excepting the treasurer. The island is administered by a governor, assisted by an executive council, a legislative council of 9 nominated members, and a house of assembly of 24 members elected on a limited franchise. Barbados is the headquarters of the Imperial Agricultural Department of the West Indies, to which (under Sir Daniel Morris) the island owes the development of cotton growing, &c. The majority of the population consists of negroes, passionately attached to the island, who have a well-marked physiognomy and dialect of their own, and are more intelligent than the other West Indian negroes. They outnumber the whites by 9 to 1. Barbados is one of the most densely populated areas in the world. In 1901 the numbers amounted to 105,588, or 117.8 to the sq. m., and in 1906 they were 196,287. There are no crown lands nor forests.

Towns.—Bridgetown (pop. 21,000), the capital, situated on the S.W. coast, is a pretty town nestling at the foot of the hills leading to the uplands of the interior. It has a cathedral, St Michael's, which also serves as a parish church. In Trafalgar Square stands the earliest monument erected to the memory of Nelson. There are a good many buildings, shops, pleasure grounds, a handsome military parade and exquisite beaches. Pilgrim, the residence of the governor, is a fine mansion about a mile from the city. Fontabelle and Hastings are fashionable suburban watering-places with good sea-bathing. Speightstown (1500) is the only other town of any size.

History.—Opinions differ as to the derivation of the name of the island. It may be the Spanish word for the hanging branches of a vine which strike root in the ground, or the name may have been given from a species of bearded fig-tree. In the 16th-century maps the name is variously rendered St Bernardo, Bernados, Barbudoso, Barnodos and Barnodo. There are more numerous traces of the Carib Indians here than in any other of the Antilles. Barbados is thought to have been first visited by the Portuguese.

Its history has some special features, showing as it does the process of peaceful colonization, for the island, acquired without conquest, has never been out of the possession of the British. It was touched in 1605 by the British ship "Olive Blossom," whose crew, finding it uninhabited, took possession in the name of James I.; but the first actual settlement was made in 1625, at the direction of Sir William Courteen under the patent of Lord Leigh, afterwards earl of Marlborough, to whom the island had been granted by the king. Two years later, a compromise having been effected with Lord Marlborough, a grant of the island was obtained by the earl of Carlisle, whose claim was based on a grant, from the king, of all the Caribbean islands in 1624; and in 1628 Charles Wolferstone, a native of Bermuda, was appointed governor. In the same year sixty-four settlers arrived at Carlisle Bay and the present capital was founded. During the Civil War in England many Royalists sought refuge in Barbados, where, under Lord Willoughby (who had leased the island from the earl of Carlisle), they offered stout resistance to the forces of the Commonwealth. Willoughby, however, was ultimately defeated and exiled. After the Restoration, to appease the planters, doubtful as to the title under which they held the estates which they had converted into valuable properties, the proprietary or patent interest was abolished, and the crown took over the government of the island; a duty of 4½% on all exports being imposed to satisfy the claims of the patentees. In 1684, under the governorship of Sir Richard Dutton, a census was taken, according to which the population then consisted of 20,000 whites and 46,000 slaves. The European wars of the 18th century caused much suffering, as the West Indies were the scene of numerous battles between the British and the French. During this period a portion of the 4½% duty was returned to the colony in the form of the governor's salary. In the course of the American War of Independence Barbados again experienced great hardships owing to the restrictions placed upon the importation of provisions from the American colonies, and in 1778 the distress became so acute that the British government had to send relief. For three years after the peace of Amiens in 1802 the colony enjoyed uninterrupted calm, but in 1805 it was only saved from falling into the hands of the French by the timely arrival of Admiral Cochrane. Since that date, however, it has remained unthreatened in the possession of the British. The rupture between Great Britain and the United States in 1812 caused privateering to be resumed, the trade of the colony being thereby almost destroyed. This led to an agitation for the repeal of the 4½% duty, but it was not till 1838 that the efforts to secure this were successful. The abolition of slavery in 1834 was attended by no ill results, the slaves continuing to work for their masters as hired servants, and a period of great prosperity succeeded. The proposed confederation of the Windward Islands in 1876, however, provoked riots, which occasioned considerable loss of life and property, but secured for the people their existence as a separate colony. Hurricanes are the scourge of Barbados, those of 1780, 1831, and 1808 being so disastrous as to necessitate relief measures on the part of the home government.

See Ligon, *History of Barbados* (1657); Oldmixon, *British Empire in America* (1741); *A Short History of Barbados* (1768); *Remarks upon the Short History* (1768); Poyer, *History of Barbados* (1808); Capt. Thom. Southey, *Chron. Hist. of W. Indies* (1827); Schomburgk, *History of Barbados* (1848); J. H. S. Moxby, *Account of a West Indian Sanatorium* (1886); N. D. Davis, *The Cavaliers and Roundheads of Barbados* (1887); J. H. Stark, *History and Guide to Barbados* (1893); R. T. Hill, *Cuba and Porto Rico* (1897). For geology, see A. J. Jukes-Browne and J. B. Harrison, "The Geology of Barbados," *Quart. Journ. Geol. Soc. London*, vol. xlvii. (1891), pp. 197-250, vol. xlviii. (1892), pp. 170-226; J. W. Gregory, "Contributions to the Paleontology and Physical Geology of the West Indies," *ibid.*, vol. li. (1895), pp. 255-310; G. F. Franks and J. B. Harrison, "The Globigerina-marls and Basal Reef-rocks of Barbados," *ibid.*, vol. liv. (1898), pp. 540-555; J. W. Spencer, "Notes on the Geological and Physical Development of Barbados; with Notes on Trinidad," *ibid.*, vol. lviii. (1902), pp. 354-367.

BARBARA, SAINT, a virgin martyr and saint of the Roman Catholic and Orthodox Eastern Churches, whose festival day is December 4th. Her legend is that she was immured in a tower

by her father who was opposed to her marriage; that she was converted to Christianity by a follower of Origen, and that when her father learnt this, he beheaded her. The place of her martyrdom is variously given as Heliopolis, as a town of Tuscany, and as Nicomedia, Bithynia, about the year 235. St Barbara is the patron saint of armourers and gunsmiths, and her protection is sought specially against lightning.

BARBARIAN (Gr. *βάρβαρος*), the name among the early Greeks for all foreigners. The word is probably onomatopoeic, designed to represent the uncouth babbling of which languages other than their own appeared to the Greeks to consist. Even the Romans were included in the term. The word soon assumed an evil meaning, becoming associated with the vices and savage natures of which they believed their enemies to be possessed. The Romans adopted the word for all peoples other than those under Græco-Roman influence and domination. It has long become synonymous with a general lack of civilization.

BARBARO, ERMOLAO (HERMOLAUS BARBARUS) (1454-1493), Italian scholar, was born at Venice on the 21st of May 1454. At an early age he was sent to Rome, where he studied under Pomponius Laetus. He completed his education at the university of Padua, where he was appointed professor of philosophy in 1477. Two years later he revisited Venice, but returned to Padua when the plague broke out in his native city. He was sent on various missions to persons of high rank, amongst them Pope Innocent VIII., by whom he was nominated to the important office of patriarch of Aquileia (1491). The Venetian senate, however, refused to ratify the appointment, which, contrary to the law, he had accepted without first obtaining its sanction. He was banished and forced to resign the patriarchate, under the threat of being punished vicariously by the confiscation of his father's property. Barbarus remained at Rome, in receipt of a small pension from the pontifical government, until his death (probably from the plague) on the 14th of June 1493 (according to some, two years later). He edited and translated a number of classical works, of which the most important were: *Castigationes Plinianeae* (1492), in which he boasted of having made 5000 corrections in the text of Pliny's *Natural History*; *Themistius' Paraphrases* of certain works of Aristotle (1486); *Aristotle's Rhetorica* (published in 1544); *Castigationes in Pomponium Melam* (1493).

BARBAROSSA ("Redbeard"), the name given by the Christians to a family of Turkish admirals and sea rovers of the 16th century.—Arouj and Khizr (*alias* Khair-ed-Din) and Hassan the son of Khair-ed-Din. As late as 1840, Captain Walsin Esterhazy, author of a history of the Turkish rule in Africa, ventured the guess that "Barbarossa" was simply a mispronunciation of Bâbâ Arouj, and the supposition has been widely accepted. But the prefix Bâbâ was not applied to Arouj by contemporaries. His name is given in Spanish or Italian form as "Orux" or "Harrach" or "Ordiche." The contemporary Arab chronicle published by S. Rang and F. Denis in 1837 says explicitly that Barbarossa was the name applied by Christians to Khair-ed-Din. It was no doubt a nickname given to the family on account of their red or tawny beards (Lat. *barba*). The founder of the family was Yakub, a Roumeliot, probably of Albanian blood, who settled in Mitylene after its conquest by the Turks. He was a coasting trader and skipper, and had four sons—Elias, Isaak, Arouj and Khizr, all said to have been born after 1482. Khizr became a potter and Isaak a trader. Elias and Arouj took to sea roving. In an action with a galley of the Knights of Saint John, then established at Rhodes, Elias was killed and Arouj taken prisoner; the latter was ransomed by a Turkish pasha and returned to the sea. For some time he served the Mamelukes who still held Egypt. During the conflict between the Mamelukes and the sultan Selim I., he considered it more prudent to transfer himself to Tunis. The incessant conflicts among the Berber princes of northern Africa gave him employment as a mercenary, which he varied by piratical raids on the trade of the Christians. At Tunis he was joined by Khizr, who took, or was endowed with, the name of Khair-ed-Din. Isaak soon followed his brothers. Arouj and Khair-ed-Din joined the exiled Moors of Granada in

raids on the Spanish coast. They also pushed their fortunes by fighting for, or murdering and supplanting, the native African princes. Their headquarters were in the island of Jerba in the Gulf of Gabes. They attempted in 1512 to take Bougie from the Spaniards, but were beaten off, and Arouj lost an arm, shattered by an arquebus shot. In 1514 they took Jijelli from the Genoese, and after a second beating at Bougie in 1515 were called in by the natives of Cherchel and Algiers to aid them against the Spaniards. They occupied the towns and murdered the native ruler who called them in. The Spaniards still held the little rocky island which gives Algiers its name and forms the harbour. In 1518 Arouj was drawn away to take part in a civil war in Tlemcen. He promptly murdered the prince he came to support and seized the town for himself. The rival party then called in the Spaniards, by whom Arouj was expelled and slain while fleeing at the Rio Salado. Khair-ed-Din clung to his possessions on the coast and appealed to the sultan Selim I. He was named beylerbey by the sultan, and with him began the establishment of Turkish rule in northern Africa. For years he was engaged in subduing the native princes, and in carrying on warfare with the Christians. In 1519 he repelled a Spanish attack on Algiers, but could not expel his enemies from the island till 1529. As a combatant in the forefront of the war with the Christians he became a great hero in Islam, and dreaded by its enemies under his name of Barbarossa. In 1534 he seized Tunis, acting as capitan pasha for the sultan Suleiman. The emperor Charles V. intervened on behalf of the native prince, retook the town, and destroyed great part of Barbarossa's fleet. The corsair retaliated by leading what remained of his navy on a plundering raid to the Balearic Islands. During the remainder of his life—till 1547—Barbarossa, though still beylerbey of northern Africa, was mainly engaged as capitan pasha in co-operating with the armies of the sultan Suleiman in the east. He was absent from Algiers when it was attacked by Charles V. in 1541. In 1543-1544 he commanded the fleet which Suleiman sent to the coast of Provence to support Francis I. Barbarossa would not allow the bells of the Christian churches to be rung while his fleet was at anchor in the ports. He plundered the coast of Italy on his way back to Constantinople. When he died in his palace at Constantinople he was succeeded as beylerbey of Africa by his son Hassan. Hassan Barbarossa, like his father, spent most of his life in the Levant, but was occasionally in Africa when the influence of his family was required to suppress the disorders of the Turkish garrisons. He left it for the last time in 1567, and is said by Hammer-Purgstall to have been present at Lepanto in 1571. His last years are obscure.

AUTHORITIES.—*The History of the Ottoman Empire*, by Joseph von Hammer-Purgstall (French translation J. J. Hellert, 1835-1843), contains accounts of the Barbarossas, but requires to be corrected by other authorities. See *La Fondation de la régence d'Alger, histoire des Barberousses, chronique arabe du XVI^{ème} siècle* published by Sander Rang and Ferdinand Denis, Paris, 1837—for a curious Moslem version of their story. H. D. de Grammont has collected later evidence in his *Histoire d'Alger* (Paris, 1887); and he discusses the origin of the name in a paper contributed to the *Revue Africaine*, No. 171. Their campaigns are told in a readable way with the advantage of technical knowledge by Ad. Jurien de la Gravière in *Les Corsaires barbaresques et la marine de Soliman le Grand* (1887), and *Doria et Barberousse* (1886). *The History of the Maritime Wars of the Turks*, by Hajji Khalifa (translated by J. Mitchell for the Oriental Translation Fund, 1831), is said to have been founded on evidence collected by order of the sultan Suleiman.

BARBAROUX, CHARLES JEAN MARIE (1767-1794), French revolutionist, was educated at first by the Oratorians of Marseilles, then studied law, and became a successful advocate. He was appointed secretary (*greffier*) to the commune of Marseilles, and in 1792 was commissioned to go to the Legislative Assembly and demand the accusation of the directory of the department of Bouches-du-Rhône, as accomplice in a royalist movement in Arles. At Paris he was received in the Jacobin club and entered into relations with J. P. Brissot and the Rolands. It was at his instigation that Marseilles sent to Paris the battalion of volunteers which contributed to the insurrection of the 10th of August 1792 against the king. Returning to Marseilles he helped to press a royalist movement at Avignon and an ultra-Jacobin movement

at Marseilles, and was elected deputy to the Convention by 775 votes out of 776 voting. From the first he posed as an opponent of the Mountain, accused Robespierre of aiming at the dictatorship (25th of September 1793), attacked Marat, and proposed to break up the commune of Paris. Then he got the act of accusation against Louis XVI. adopted, and in the trial voted for his death "without appeal and without delay." During the final struggle between the Girondists and the Mountain, he refused to resign as deputy and rejected the offer made by the sections of Paris to give hostages for the arrested representatives. He succeeded in escaping, first to Caen, where he organized the civil war, then to Saint-Emilion near Bordeaux, where he wrote his *Mémoires*, which were published in 1822 by his son, and re-edited in 1866. Discovered, he attempted to shoot himself, but was only wounded, and was taken to Bordeaux, where he was guillotined when his identity was established.

See Ch. Vatel, *Charlotte Corday et les Girondins* (Paris, 1873); A. Aulard, *Les Orateurs de la Législative et de la Convention* (Paris, 2nd ed., 1906).

BARBARY, the general designation of that part of northern Africa bounded E. by Egypt, W. by the Atlantic, S. by the Sahara and N. by the Mediterranean, comprising the states of Morocco, Algeria, Tunisia and Tripoli. The name is derived from the Berbers, the chief inhabitants of the region.

BARBARY APE, a tailless monkey inhabiting Algeria, Morocco, and the rock of Gibraltar (where it may have been introduced), and referable to the otherwise Asiatic group of macaques, in which it alone represents the subgenus *Inuus*. This monkey, *Macacus inuus*, is light yellowish-brown above and yellowish-white below, with the naked part of the face flesh-coloured. It is entirely terrestrial in habits, at least on Gibraltar, and goes about in droves.

BARBARY PIRATES. The coast population of northern Africa has in past ages been addicted to piratical attacks on the shores of Europe opposite. Throughout the decline of the Roman empire, the barbarian invasions, the Mahomedan conquest and the middle ages, mere piracy always existed by the side of the great strife of peoples and religions. In the course of the 14th century, when the native Berber dynasties were in decadence, piracy became particularly flagrant. The town of Bougie was then the most notorious haunt of these "skimmers of the sea." But the savage robber powers which, to the disgrace of Europe, infested the commerce and the coasts, not only of the Mediterranean but even for a time of the ocean; who were not finally suppressed till the 19th century was well advanced; and who are properly known as the Barbary pirates, arose in the 16th century, attained their greatest height in the 17th, declined gradually throughout the 18th and were extinguished about 1830. Isolated cases of piracy have occurred on the Rif coast of Morocco even in our time, but the pirate communities which lived by plunder and could live by no other resource, vanished with the French conquest of Algiers in 1830. They are intimately connected with the general history of northern Africa from about 1492 to their end. The story of the establishment of Turkish rule in northern Africa and of the revolutions of Morocco must be sought under the heads of TURKEY, TRIPOLI, TUNISIA, ALGERIA and MOROCCO.

In dealing with the pirates, it will be sufficient to note a few leading dates. The conquest of Granada in 1492 by the Catholic sovereigns of Spain drove many Moors into exile. They revenged themselves by piratical attacks on the Spanish coast. They had the help of Moslem adventurers from the Levant, of whom the most successful were Arouj and his brother Khair-ed-Din, natives of Mitylene, both of whom were known to the Christians by the nickname of Barbarossa (*q.v.*) or "Redbeard." Spain in self-defence began to conquer the coast towns of Oran, Algiers and Tunis. Arouj having fallen in battle with the Spaniards in 1518, his brother Khair-ed-Din appealed to Selim, the sultan of Turkey, who sent him troops. He drove the Spaniards in 1529 from the rocky island in front of Algiers, where they had a fort, and was the founder of the Turkish power. From about 1518 till the death of Uluch Ali in 1587, Algiers was the main seat

of government of the beylerbeys of northern Africa, who ruled over Tripoli, Tunisia and Algeria. From 1587 till 1659, they were ruled by Turkish pashas, sent from Constantinople to govern for three years; but in the latter year a military revolt in Algiers reduced the pashas to nominalities. From 1659 onwards, these African cities, though nominally forming parts of the Turkish empire, were in fact anarchical military republics which chose their own rulers and lived by plunder.

It may be pointed out that during the first period (1518-1587) the beylerbeys were admirals of the sultan, commanding great fleets and conducting serious operations of war for political ends. They were slave-hunters and their methods were ferocious, but their Christian enemies were neither more humane nor more chivalrous. After 1587, plunder became the sole object of their successors—plunder of the native tribes on land and of all who went upon the sea. The maritime side of this long-lived brigandage was conducted by the captains, or *reis*, who formed a class or even a corporation. Cruisers were fitted out by capitalists and commanded by the *reis*. Ten per cent of the value of the prizes was paid to the treasury of the pasha or his successors, who bore the titles of Agha or Dey or Bey. Bougie was the chief shipbuilding port and the timber was mainly drawn from the country behind it. Until the 17th century the pirates used galleys, but a Flemish renegade of the name of Simon Danser taught them the advantage of using sailing ships. In this century, indeed, the main strength of the pirates was supplied by renegades from all parts of Christendom. An English gentleman of the distinguished Buckinghamshire family of Verney was for a time among them at Algiers. This port was so much the most formidable that the name of Algerine came to be used as synonymous with Barbary pirate, but the same trade was carried on, though with less energy, from Tripoli and Tunis—as also from towns in the empire of Morocco, of which the most notorious was Salli. The introduction of sailing ships gave increased scope to the activity of the pirates. While the galleys, being unfit for the high seas, were confined to the Mediterranean and the coast, the sailing vessels ranged into the Atlantic as far as the Canaries or even to Iceland. In 1631 a Flemish renegade, known as Murad Reis, sacked Baltimore in Ireland, and carried away a number of captives who were seen in the slave-market of Algiers by the French historian Pierre Dan.

The first half of the 17th century may be described as the flowering time of the Barbary pirates. More than 20,000 captives were said to be imprisoned in Algiers alone. The rich were allowed to redeem themselves, but the poor were condemned to slavery. Their masters would not in many cases allow them to secure freedom by professing Mahomedanism. A long list might be given of people of good social position, not only Italians or Spaniards, but German or English travellers in the south, who were captives for a time. The chief sufferers were the inhabitants of the coasts of Sicily, Naples and Spain. But all traders belonging to nations which did not pay blackmail in order to secure immunity were liable to be taken at sea. The payment of blackmail, disguised as presents or ransoms, did not always secure safety with these faithless barbarians. The most powerful states in Europe descended to make payments to them and to tolerate their insults. Religious orders—the Redemptionists and Lazarites—were engaged in working for the redemption of captives and large legacies were left for that purpose in many countries. The continued existence of this African piracy was indeed a disgrace to Europe, for it was due to the jealousies of the powers themselves. France encouraged them during her rivalry with Spain; and when she had no further need of them they were supported against her by Great Britain and Holland. In the 18th century British public men were not ashamed to say that Barbary piracy was a useful check on the competition of the weaker Mediterranean nations in the carrying trade. When Lord Ermouth sailed to coerce Algiers in 1816, he expressed doubts in a private letter whether the suppression of piracy would be acceptable to the trading community. Every power was, indeed, desirous to secure immunity for itself and more or less ready to compel Tripoli, Tunis, Algiers, Salli and

the rest to respect its trade and its subjects. In 1655 the British admiral, Robert Blake, was sent to teach them a lesson, and he gave the Tunisians a severe beating. A long series of expeditions was undertaken by the British fleet during the reign of Charles II., sometimes single-handed, sometimes in combination with the Dutch. In 1682 and 1683 the French bombarded Algiers. On the second occasion the Algerines blew the French consul from a gun during the action. An extensive list of such punitive expeditions could be made out, down to the American operations of 1801-5 and 1815. But in no case was the attack pushed home, and it rarely happened that the aggrieved Christian state refused in the end to make a money payment in order to secure peace. The frequent wars among them gave the pirates numerous opportunities of breaking their engagements, of which they never failed to take advantage.

After the general pacification of 1815, the suppression of African piracy was universally felt to be a necessity. The insolence of a Tunisian squadron which sacked Palma in the island of Sardinia and carried off 158 of its inhabitants, roused widespread indignation. Other influences were at work to bring about their extinction. Great Britain had acquired Malta and the Ionian Islands and had now many Mediterranean subjects. She was also engaged in pressing the other European powers to join with her in the suppression of the slave trade which the Barbary states practised on a large scale and at the expense of Europe. The suppression of the trade was one of the objects of the congress of Vienna. Great Britain was called on to act for Europe, and in 1816 Lord Exmouth was sent to obtain treaties from Tunis and Algiers. His first visit produced diplomatic documents and promises and he sailed for England. While he was negotiating, a number of British subjects had been brutally ill-treated at Bona, without his knowledge. The British government sent him back to secure reparation, and on the 27th of August, in combination with a Dutch squadron under Admiral Van de Capellen, he administered a smashing bombardment to Algiers. The lesson terrified the pirates both of that city and of Tunis into giving up over 3000 prisoners and making fresh promises. But they were not reformed and were not capable of reformation. Algiers renewed its piracies and slave-taking, though on a smaller scale, and the measures to be taken with it were discussed at the conference or congress of Aix-la-Chapelle in 1818. In 1824 another British fleet under Admiral Sir Harry Neale had again to bombard Algiers. The great pirate city was not in fact thoroughly tamed till its conquest by France in 1830.

AUTHORITIES.—The *Histoire d'Alger* of H. D. de Grammont (Paris, 1887) is based on original authorities. Sir R. L. Playfair's *Scourge of Christendom* (London, 1884) gives the history of the British consulate in Algiers. The main authorities for the early history of the Barbary states are:—Luis del Marmol Carvajal, *Description de l'Afrique* (Granada, 1573); Diego de Haedo, *Topographia e Historia General de Argel* (Valladolid, 1612); and Père Pierre Dan, *Histoire de Barbarie et de ses corsaires* (Paris, 1637). The readable treatises of Ad. Jurien de la Gravière, all published in Paris, *Doria et Barberousse* (1886), *Les Corsaires barbaresques* (1887), *Les Chevaliers de Malte* (1887), and *La Guerre de Chypre* (1888), deal with the epoch of the beylerbeys and the regular wars. For American work see Gardner Weld Allen, *Our Navy and the Barbary Corsairs* (New York, 1905). (D. H.)

BARBAULD, ANNA LETITIA (1743-1825), English poet and miscellaneous writer, was born at Kibworth-Harcourt, in Leicestershire, on the 20th of June 1743. Her father, the Rev. John Aikin, a Presbyterian minister and schoolmaster, taught his daughter Latin and Greek. In 1758 Mr Aikin removed his family to Warrington, to act as theological tutor in a dissenting academy there. In 1773 Miss Aikin published a volume of *Poems*, which was very successful, and co-operated with her brother, Dr John Aikin, in a volume of *Miscellaneous Pieces in Prose*. In 1774 she married Rochemont Barbauld, a member of a French Protestant family settled in England. He had been educated in the academy at Warrington, and was minister of a Presbyterian church at Palgrave, in Suffolk, where, with his wife's help, he established a boarding school. Her admirable *Hymns in Prose and Early Lessons* were written for their pupils. In 1785 she left England for the continent with her husband, whose health was seriously impaired. On their return about

two years later, Mr Barbauld was appointed to a church at Hampstead. In 1802 they removed to Stoke Newington. Mrs Barbauld became well known in London literary circles. She collaborated with Dr Aikin in his *Evenings at Home*; in 1795 she published an edition of Akenside's *Pleasures of Imagination*, with a critical essay; two years later she edited Collins's *Odes*; in 1804 she published a selection of papers from the English Essayists, and a selection from Samuel Richardson's correspondence, with a biographical notice; in 1810 a collection of the *British Novelists* (50 vols.) with biographical and critical notices; and in 1811 her longest poem, *Eighteen Hundred and Eleven*, giving a gloomy view of the existing state and future prospects of Britain. This poem anticipated Macaulay in contemplating the prospect of a visitor from the antipodes regarding at a future day the ruins of St Paul's from a broken arch of Blackfriars Bridge. Mrs Barbauld died on the 9th of March 1825; her husband had died in 1808. A collected edition of her works, with memoir, was published by her niece, Lucy Aikin, in 2 vols., 1825.

See A. L. le Breton, *Memoir of Mrs Barbauld* (1874); G. A. Ellis, *Life and Letters of Mrs A. L. Barbauld* (1874); and Lady Thackeray Ritchie, *A Book of Sibyls* (1883).

BARBECUE (Span. *barbacoa*), originally a framework on posts placed over a fire on which to dry or smoke meat; hence, a gridiron for roasting whole animals, and in Cuba an upper floor on which fruit or grain is stored. In the United States the word means an open-air feast, either political or social, where whole animals are roasted and eaten and hogsheds of beer and other vast quantities of food and drink consumed.

BARBED WIRE, a protective variety of fencing, consisting usually of several strands of wire twisted together with sharp spikes or points clinched or fastened into the strands.

In the United States, barbed wire for fencing was originally suggested to meet conditions existing in the western states, by reason of the large cattle-raising industry in sections where timber was scarce. Prior to its introduction, a No. 9 round or oval iron wire was popular on the frontier of the United States and in South America, as a fencing material. Large amounts were used annually for this purpose, but iron lacked strength, and single wire strand was not fully satisfactory on account of stretching in warm and contracting in cold weather, and of this being broken. Cattle would rub against a smooth fence, and thus constant pressure loosened the posts and broke the wire. To overcome this defect, ingenious people—the most successful being farmers—set themselves to find a way by which wire could be used and at the same time be free from destruction by the animals it was intended to confine. This investigation resulted in the invention of barbed wire. Soon after, automatic machinery was invented for rapidly and cheaply placing the barb upon the smooth wire, so that the cost of barbed wire is much less than the cost of smooth wire when it was in general use. So immediately did barbed wire find favour with the farmers of the United States, and, in fact, all over the world, that the manufacture of wire was revolutionized.

The history of barbed wire fencing is of recent date. In the United States—the real home of this industry—patents were taken out by Lucien B. Smith, Kent, Ohio, in 1867; by William B. Hunt, of Scott, N.Y., at almost the same time; and by Michael Kelly, of New York, a year later. The practical beginning of the industry, however, was in the patents issued to Joseph F. Glidden, De Kalb, Ill., 1874, on barbed fence wire, and during the same year, to Joseph F. Glidden and Phineas W. Vaughan, for a machine to manufacture the same. These inventions were the foundation of the system of patents under which barbed wire has been protected and sold. The development of the barbed wire industry would hardly have been possible without steel. Iron wire, used for fencing prior to the introduction of steel, was not suitable, seeing that iron does not possess sufficient tensile strength and lacks homogeneity, qualities which Bessemer and open-hearth steels possess in a high degree.

The advantages of galvanized barbed wire fencing are that it is almost imperishable, is no burden on the posts; does not

oppose the wind with enough surface to rack the posts, thus allowing water to settle around them and rot them; is economical, not only in the comparative cheapness of its first cost but also in the amount of land covered by it; and is effective as a barrier against all kinds of stock and a protection against dogs and wild beasts. Cattle, once discovering what it is, will not press against it, nor even go near it, and thus it becomes an effective means of dividing the farmer's ranch into such fields as he may desire. It is quickly and cheaply constructed, and has the advantage of freedom from harbouring weeds. It affords no impediment to the view. A man can see across his farm, and ascertain what is going on in every portion within the scope of vision, as plainly as if there were no fences. It does not contribute to the formation of snow drifts as do other kinds of efficient fence. This makes it a favourite form of fencing for railroads and along highways. Finally, barbed wire composed of two wires twisted together, once firmly put in place, will retain its taut condition through many seasons without repair. The fact of the wire being twisted allows it to adapt itself to all the varying temperatures.

The introduction of barbed wire met with some opposition in America on supposed humanitarian grounds, but ample and extended tests, both of the economy and the humanity of the new material, silenced this objection. Now no American farmer, especially in the west, ever thinks of putting any other kind of fencing on his farm, unless it may be the new types of meshed wire field fencing which have been coming so generally into use since 1890. Generally speaking, the use of barbed wire fencing in other countries has not been as extensive as in the western United States. While it has been used on a comparatively large scale in Argentina and Australia, both these countries use a much larger quantity of plain wire fence, and in Argentina there is an important consumption of high-carbon oval fence wire of great strength, which apparently forms the only kind of fence that meets the conditions in a satisfactory manner.

It is interesting to note the largely increased demand for meshed wire field fencing in the more thickly settled portions of the United States, and along the lines of railway. Beginning with 1899, there has been an annual increase in this demand, owing to the scarcity and high cost of labour, and the discontinuing of the building of rail fences. Meshed wire is considered by many a better enclosure for small animals, like sheep and hogs, than the barbed wire fence. Barbed wire has been popular with railroads, but of late meshed wire fencing has been substituted with advantage, the fabric being made of wires of larger diameter than formerly, to insure greater stability. The popularity of barbed wire is best shown by the following statistics:—

APPROXIMATE PRODUCTION FOR THE UNITED STATES

Year.	Tons barbed wire.	Tons meshed field fencing.
1874	5	
1875	300	
1876	1,500	
1877	7,000	
1878	13,000	
1879	25,000	
1880	40,000	
1890	125,000	
1900	200,000	50,000
1907	250,000	425,000

Barbed wire is usually shipped to customers on wooden spools, each holding approximately 100 lb or 80 to 100 rods. A hole is provided through the centre of the spool for inserting a bar, on which the reel can revolve for unwinding the wire as it is put up. After the wire is stretched in place, it is attached to the wooden posts by means of galvanized steel wire staples, ordinarily made from No. 9 wire. They are cut with a sharp, long, diagonal point and can be easily driven into the posts. On account of the rapid decay and destruction of wooden posts, steel posts have become popular, as also have reinforced concrete posts, which add materially to the durability of the fence. It is essential that barbed wire should be stretched with great care. For this purpose a suitable barbed wire stretcher is necessary.

Barbed wire fencing is now manufactured in various patterns. The general process may be outlined briefly as follows:—The wire is made of soft Bessemer or Siemens-Martin steel, and is drawn in the wire mill in the usual way. Galvanizing is done by a continuous process. The coil of wire to be galvanized is placed on a reel. The first end of the wire is led longitudinally through an annealing medium—either red-hot lead or heated fire-brick tubes—of sufficient

length to soften the wire. From the annealing furnace, the wire is led longitudinally through a bath of muriatic acid, which removes the scale, and from the acid, after a thorough washing in water, the wire passes through a bath of spelter, heated slightly above the melting point. After coming from the spelter and being cooled by water, the wire is wound on suitable take-up blocks into finished coils. From 30 to 60 wires are passing simultaneously in parallel lines through this continuous galvanizing apparatus, thus insuring a large output. The galvanizing gives the wire a bright finish and serves to protect it from the corrosive action of the atmosphere. There is a considerable demand for painted fencing, in the manufacture of which the galvanizing is dispensed with, and the spools of finished barbed wire, as they come from the barbing machine, are submerged in paint and dried. The barbing and twisting together of the two longitudinal strand wires is done by automatic machinery. A brief description of the manufacture of 2 and 4 point Clidden wire is as follows:—Two coils of wire on reels are placed behind the machine, designed to form the main or strand wires of the fence. One of the main wires passes through the machine longitudinally. One or two coils of wire are placed on reels at either side of the machine for making 2 or 4 point wire respectively. These wires are fed into the machine at right angles to the strand wire. At each movement of the feeding mechanism, when fabricating 2 point wire, one cross wire is fed forward. A diagonal cut forms a sharp point on the first end. The wire is again fed forward and instantly wrapped firmly around one strand wire and cut off so as to leave a sharp point on the incoming wire as before, while the bit of pointed wire cut off remains as a demand for twisted steel barbing. The wire to the strand wire. This wire armed with barbs at regular intervals passes on through a guide, where it is met by a second strand wire—a plain wire without barbs. The duplex strand wires are attached to a take-up reel, which is caused to revolve and take up the finished barbed wire simultaneously and in unison with the barbing machine. In this way the strand wires are loosely twisted into a 2-ply strand, armed with barbs projecting at right angles in every direction.

When once started, the operation of barbed wire making is continuous and rapid. The advantage of two strands is the automatic adjustment to changes of temperature. When heat expands the strands, the twist simply loosens without causing a sag, and when cold contracts them, the twist tightens, all without materially altering the relative lengths of the combined wires. A barbed wire machine produces from 2000 to 3000 lb of wire per day of ten hours.

In some American states, the use of barbed wire is regulated by law, but as a rule these laws apply to placing barbed wire on highways. Others prohibit the use of barbed wire fencing to indicate the property line between different owners, unless both agree to its use. In some states the use of barbed wire is prohibited unless it has a top rail of lumber.

Barbed wire is also employed in connexion with "obstacles" in field fortifications, especially in what are known as "high wire entanglements." Pointed stakes or "pickets," 4 ft. high, are planted in rows and secured by ordinary wire to holdfasts or pegs in the ground. Each picket is connected to all around it, top and bottom, by lengths of barbed wire.

In England, where the use of barbed wire has also become common, the Barbed Wire Act 1893 enacted that, where there is on any land adjoining a highway within the county or district of a local authority, a fence which is made with barbed wire (i.e. any wire with spikes or jagged projections), or in which barbed wire has been placed, and where such barbed wire may probably be injurious to persons or animals lawfully using the highway, the local authority may require the occupier of the land to abate the nuisance by serving notice in writing upon him. If the occupier fails to do so within the specified time, the local authority may apply to a court of summary jurisdiction, and such court may satisfy that the barbed wire is a nuisance, may by summary order direct the occupier to abate it, and on his failure to comply with the order within a reasonable time, the local authority may execute it and recover in a summary manner from the occupier the expenses incurred.

BARBEL (*Barbus vulgaris*), a fish of the Cyprinid family, which is an inhabitant of the rivers of central Europe, and is very locally distributed in England. It has four barbels (Lat. *barba*, beard; fleshy appendages hanging from the mouth), and the first ray of the short dorsal fin is strong, spine-like and serrated behind. It attains a weight of 50 lb on the continent of Europe. The genus of which it is the type is a very large one, comprising about 300 species from Europe, Asia and Africa, among which is the mahaseer or mahaseer, the great sporting fish of India.

BARBÉ-MARBOIS, FRANÇOIS, MARQUIS DE (1745-1837), French politician, was born at Metz. He began his public career as intendant of San Domingo under the old régime. At the close of 1780 he returned to France, and then placed his services at the disposal of the revolutionary government. In 1791 he was sent to Regensburg to help de Noailles, the French ambassador, in the negotiations with the diet of the Empire concerning the

possessions of German princes in Alsace and Lorraine. Suspected of treason, he was arrested on his return but set at liberty again. In 1795 he was elected to the Council of the Ancients, where the general moderation of his attitude, especially in his opposition to the exclusion of nobles and the relations of *émigrés* from public life, brought him under suspicion of being a royalist, though he pronounced a eulogy on Bonaparte for his success in Italy. At the *coup d'état* of the 18th Fructidor (September 4) 1797, he was arrested and transported to French Guiana. Transferred to Oléron in 1799, he owed his liberty to Napoleon, after the 18th Brumaire. In 1801 he became councillor of state and director of the public treasury, and in 1802 a senator. In 1803 he negotiated the treaty by which Louisiana was ceded to the United States, and was rewarded by the First Consul with a gift of 152,000 francs. In 1805 he was made grand officer of the legion of honour and a count, and in 1808 he became president of the *cour des comptes*. In return for these favours, he addressed Napoleon with servile compliments; yet in 1814 he helped to draw up the act of abdication of the emperor, and declared to the *cour des comptes*, with reference to the invasion of France by the allies, "united for the most beautiful of causes, it is long since we have been so free as we now are in the presence of the foreigner in arms." In June 1814, Louis XVIII. named him peer of France and confirmed him in his office as president of the *cour des comptes*. Deprived of his positions by Napoleon during the Hundred Days he was appointed minister of justice in the ministry of the duc de Richelieu (August 1815). In this office he tried unsuccessfully to gain the confidence of the ultra-royalists, and withdrew at the end of nine months (May 10, 1816).

In 1830, when Louis Philippe assumed the reins of government, Barbé-Marbois went, as president of the *cour des comptes*, to compliment him and was confirmed in his position. It was the sixth government he had served and all with servility. He held his office until April 1834, and died on the 12th of February 1837. He published various works, of which may be mentioned: *Réflexions sur la colonie de Saint-Domingue* (1794), *De la Guyane, &c.* (1822), *un Histoire de la Louisiane et la cession de cette colonie par la France aux États-Unis, &c.* (1828), and the story of his transportation after the 18th Fructidor in *Journal d'un déporté non jugé*, 2 vols. (1834).

BARBER (from Lat. *barba*, beard), one whose occupation it is to shave or trim beards, a hairdresser. In former times the barber's craft was dignified with the title of a profession, being conjoined with the art of surgery. In France the barber-surgeons were separated from the *peruquiers*, and incorporated as a distinct body in the reign of Louis XIV. In England barbers first received incorporation from Edward IV. in 1461. By 32 Henry VIII. c. 42, they were united with the company of surgeons, it being enacted that the barbers should confine themselves to the minor operations of blood-letting and drawing teeth, while the surgeons were prohibited from "barbery or shaving." In 1745 barbers and surgeons were separated into distinct corporations by 18 George II. c. 15. The barber's shop was a favourite resort of idle persons; and in addition to its attraction as a focus of news, a lute, viol, or some such musical instrument, was always kept for the entertainment of waiting customers. The barber's sign consisted of a striped pole, from which was suspended a basin, symbols the use of which is still preserved. The fillet round the pole indicated the ribbon for bandaging the arm in bleeding, and the basin the vessel to receive the blood.

See also **BEARD**, and *Annals of the Barber Surgeons of London* (1890).

BARBERINI, the name of a powerful Italian family, originally of Tuscan extraction, who settled in Florence during the early part of the 11th century. They acquired great wealth and influence, and in 1623 Maffeo Barberini was raised to the papal throne as Urban VIII. He made his brother, Antonio, a distinguished soldier, and two nephews, cardinals, and gave to a third nephew, Taddeo, the principality of Palestrina. Great jealousy of their increasing power was excited amongst the neighbouring princes, and Odoardo Farnese, duke of Parma,

made war upon Taddeo, and defeated the papal troops. After the death of Urban in 1644 his successor, Innocent X., showed hostility to the Barberini family. Taddeo fled to Paris, where he died in 1647, and with him the family became extinct in the male line. His daughter Cornelia married Prince Giulio Cesare Colonna di Sciara in 1728, who added her name to his own. On the death of Prince Enrico Barberini-Colonna the name went to his daughter and heiress Donna Maria and her husband Marquis Luigi Sacchetti, who received the title of prince of Palestrina and permission to bear the name of Barberini. The fine Barberini palace and library in Rome give evidence of their wealth and magnificence. The ruthless way in which they plundered ancient buildings to adorn their own palaces is the origin of the saying, "Quod non fecerunt barbari, fecerunt Barberini."

See A. von Reumont, *Geschichte der Stadt Rom* (Berlin, 1868), iii. b. 611-612, 615, 617, &c.; *Almanach de Gotha* (Gotha, 1902); J. H. Douglas, *The Principal Noble Families of Rome* (Rome, 1905).

BARBERRY (*Berberis vulgaris*), a shrub with spiny-toothed leaves, which on the woody shoots are reduced to forked spines, and pale yellow flowers in hanging racemes, which are succeeded by orange-red berries. It is a member of the botanical natural order *Berberidaceae*, and contains about 100 species in the north temperate zone and in the Andes of South America extending into Patagonia. The order is nearly allied to the buttercup order in having the parts of the flowers all free and arranged in regular succession below the ovary which consists of only one carpel. It is distinguished by having the sepals, petals and stamens in multiples of 2, 3 or 4, never of 5. The berries of *Berberis* are edible; those of the native barberry are sometimes made into preserves. The alkaloid berberine (*q.v.*) occurs in the roots.

BARBERTON, a town of the Transvaal, 283 m. by rail (175 m. in a direct line) E. of Pretoria and 136 m. W.N.W. of Delagoa Bay. Pop. (1904) 2433, of whom 1214 were whites. Barberton lies 2825 ft. above the sea and is built on the side of a valley named De Kaap, from a bold headland of the Drakensberg which towers above it. The chief town of a district of the same name, it owes its existence to the discovery of gold in the Kaap valley, and dates from 1886. There are several fine public buildings grouped mainly round President Square. The town is connected with the Lourenço Marques-Pretoria trunk railway by a branch line, 35 m. long, which runs N.E. through fine mountainous country and joins the main line at Kaapmuiden. During the war of 1890-1902 the Boers were driven out of Barberton (13th of September 1900) by General (afterwards Sir John) French.

BARBETTE (Fr. diminutive of *barbe*, a beard), a platform inside a fortification raised sufficiently high for artillery placed thereon to be able to fire *en barbette*, *viz.* over the top of the parapet; also in warships a raised platform, protected by armour on the sides, upon which guns are mounted *en barbette*.

BARBEY D'AUREVILLY, JULES AMÉDÉE (1808-1880), French man of letters, was born at Saint-Sauveur-le-Vicomte (Manche) on the 2nd of November 1808. His most famous novels are *Une Vieille Maitresse* (1851), attacked at the time of its publication on the charge of immorality; *L'Ensercelée* (1854), an episode of the royalist rising among the Norman peasants against the first republic; the *Chevalier Destouches* (1864); and a collection of extraordinary stories entitled *Les Diaboliques* (1874). Barbey d'Aurevilly is an extreme example of the eccentricities of which the Romanticists were capable, and to read him is to understand the discredit that fell upon the manner. He held extreme Catholic views and wrote on the most *risqué* subjects; he gave himself aristocratic airs and hinted at a mysterious past, though his parentage was entirely *bourgeois* and his youth very hum-drum and innocent. In the '50ties d'Aurevilly became literary critic of the *Pays*, and a number of his essays, contributed to this and other journals, were collected as *Les Œuvres et les hommes du XIX^e siècle* (1861-1865). Other literary studies are *Les Romanciers* (1866) and *Goethe et Diderot* (1880). He died in Paris on the 23rd of April 1880. Paul Bourget describes him as a dreamer with an exquisite sense of vision, who sought and found in his work a refuge from the

uncongenial world of every day. Jules Lemaitre, a less sympathetic critic, finds in the extraordinary crimes of his heroes and heroines, his reactionary views, his dandyism and snobbery, an exaggerated Byronism.

See also Alcide Dusolier, *Jules Barbey d'Aurevilly* (1862), a collection of eulogies and interviews; Paul Bourget, Preface to *d'Aurevilly's Memoranda* (1883); Jules Lemaitre, *Les Contemporains*; Eugène Grédy, *Barbey d'Aurevilly, sa vie et son œuvre* (1902); René Doumic, in the *Revue des deux mondes* (Sept. 1902).

BARBEYRAC, JEAN (1674-1744), French jurist, the nephew of Charles Barbeyrac, a distinguished physician of Montpellier, was born at Beziers in Lower Languedoc on the 15th of March 1674. He removed with his family into Switzerland after the revocation of the edict of Nantes, and there studied jurisprudence. After spending some time at Geneva and Frankfurt-on-Main, he became professor of belles-lettres in the French school of Berlin. Thence, in 1711, he was called to the professorship of history and civil law at Lausanne, and finally settled as professor of public law at Groningen. He died on the 3rd of March 1744. His fame rests chiefly on the preface and notes to his translation of Pufendorf's treatise *De Jure Naturæ et Gentium*. In fundamental principles he follows almost entirely Locke and Pufendorf; but he works out with great skill the theory of moral obligation, referring it to the command or will of God. He indicates the distinction, developed more fully by Thomasius and Kant, between the legal and the moral qualities of action. The principles of international law he reduces to those of the law of nature, and combats, in so doing, many of the positions taken up by Grotius. He rejects the notion that sovereignty in any way resembles property, and makes even marriage a matter of civil contract. Barbeyrac also translated Grotius's *De Jure Belli et Pacis*, Cumberland's *De Legibus Naturæ*, and Pufendorf's smaller treatise *De Officio Hominis et Civis*. Among his own productions are a treatise, *De la morale des pères*, a history of ancient treaties contained in the *Supplément au grand corps diplomatique*, and the curious *Traité du jeu* (1709), in which he defends the morality of games of chance.

BARBICAN (from Fr. *barbacane*, probably of Arabic or Persian origin), an outwork for the defence of a gate or drawbridge; also a sort of pent-house or construction of timber to shelter warders or sentries from arrows or other missiles.

BARBIER, ANTOINE ALEXANDRE (1765-1825), French librarian and bibliographer, was born on the 11th of January 1765 at Coulommiers (Seine-et-Marne). He took priest's orders, from which, however, he was finally released by the pope in 1801. In 1794 he became a member of the temporary commission of the arts, and was charged with the duty of distributing among the various libraries of Paris the books that had been confiscated during the Revolution. In the execution of this task he discovered the letters of Huet, bishop of Avranches, and the MSS. of the works of Fénelon. He became librarian successively to the Directory, to the Conseil d'État, and in 1807 to Napoleon, from whom he carried out a number of commissions. He produced a standard work in his *Dictionnaire des ouvrages anonymes et pseudonymes* (4 vols., 1806-1809; 3rd edition 1872-1879). Only the first part of his *Examen critique des dictionnaires historiques* (1820) was published. He had a share in the foundation of the libraries of the Louvre, of Fontainebleau, of Compiègne and Saint-Cloud; under Louis XVIII. he became administrator of the king's private libraries, but in 1822 he was deprived of all his offices. Barbier died in Paris on the 5th of December 1825.

See also a notice by his son, Louis Barbier, and a list of his works prefixed to the 3rd edition of the *Dict. des ouvrages anonymes et pseudonymes*.

BARBIER, HENRI AUGUSTE (1805-1882), French dramatist and poet, was born in Paris on the 29th of April 1805. Inspired by the revolution of July he poured forth a series of eager, vigorous poems, denouncing, crudely enough, the evils of the time. They are spoken of collectively as the *Tambes* (1831), though the designation is not strictly applicable to all. As the name suggests, they are modelled on the verse of André Chénier. They include *La Curée*, *La Popularité*, *L'Idole*, *Paris*, *Dante*, *Quatre-vingt-treize* and *Varsovie*. The rest of Barbier's poems

are forgotten, and when, in 1869, he received the long delayed honour of admission to the Academy, Montalembert expressed the general sentiment in his *Barbier? mais il est mort!* It was even asserted, though without foundation, that he was not the real author of the *Tambes*. He died at Nice on the 13th of February 1882. He collaborated with Léon de Wailly in the libretto of Berlioz's opera, *Benvenuto Cellini*, and his works include two series of poems on the political and social troubles of Italy and England, printed in later editions of *Tambes et poèmes*.

See also Sainte-Beuve, *Portraits contemporains*, vol. ii.

BARBIER, LOUIS, known as the **ABBÉ DE LA RIVIÈRE** (1593-1670), French bishop, was born of humble parents in Vaudelaincourt, near Compiègne. He entered the church and made his way by his wit and cleverness, until he was appointed tutor, and then became the friend and adviser, of Gaston d'Orléans, brother of Louis XIII. He thus gained an entrance to the court, became grand almoner of the queen, and received the revenue of rich abbays. In March 1655 he was named bishop of Langres, but he spent his time at court, where his wit was always in demand, and where he gained great sums by gambling. He died very rich.

BARBIERI, GIOVANNI FRANCESCO (otherwise called GUERCINO, from his squinting), (1591-1666), Italian historical painter, was born at Cento, a village not far from Bologna. His artistic powers were developed very rapidly, and at the age of seventeen he was associated with Benedetto Gennari (1550-1610), a well-known painter of the Bolognese school. The fame of the young painter spread beyond his native village, and in 1615 he removed to Bologna, where his paintings were much admired. His first style was formed after that of the Caracci; but the strong colouring and shadows employed by Caravaggio made a deep impression on his mind, and for a considerable period his productions showed evident traces of that painter's influence. Some of his latest pieces approach rather to the manner of his great contemporary Guido, and are painted with more lightness and clearness. Guercino was esteemed very highly in his lifetime, not only by the nobles and princes of Italy, but by his brother artists, who placed him in the first rank of painters. He was remarkable for the extreme rapidity of his execution; he completed no fewer than 106 large altar-pieces for churches, and his other paintings amount to about 144. His most famous piece is thought to be the St Petronilla, which was painted at Rome for Gregory XV. and is now in the Capitol. In 1626 he began his frescoes in the Duomo at Piacenza. Guercino continued to paint and teach up to the time of his death in 1666. He had amassed a handsome fortune by his labours. His life, by J. A. Calvi, appeared at Bologna in 1808.

His brother, PAOLO ANTONIO BARBIERI (1603-1649), was a celebrated painter of still life and animals. He chose for his subjects fruits, flowers, insects and animals, which he painted after nature with a lively tint of colour, great tenderness of pencil, and a strong character of truth and life.

BARBITON, or BARBITOS (Gr. *βαρβιτον* or *βαρβιτος*; Lat. *barbitus*; Pers. *barbat*, *barbud*), an ancient stringed instrument known to us from the Greek and Roman classics, but derived from Persia. Theocritus (xvi. 45), the Sicilian poet, calls it an instrument of many strings, i.e. more than seven, which was by the Hellenes accounted the perfect number, as in the cithara of the best period. Anacreon¹ (a native of Teos in Asia Minor) sings that his barbitos only gives out erotic tones. Pollux (*Onomasticon* iv. chap. 8, § 59) calls the instrument barbiton or barycite (from *barbis*, heavy and *mitros*, a string), an instrument producing deep sounds; the strings were twice as long as those of the pectis and sounded an octave lower. Pindar (in Athen. xiv. p. 635), in the same line wherein he attributes the introduction of the instrument into Greece to Terpander, tells us one could magadize, i.e. play in two parts at an interval of an octave on the two instruments. The word barbiton was frequently used for the lyre itself. Although in use in Asia Minor, Italy,

¹ See Bergk's *Poetae Lyrici Graeci* (4th ed., 1882), p. 291, fr. 143 [13]; and p. 311, 23 [1], 3; and 14 [9], 34, p. 306.

Sicily, and Greece, it is evident that the barbiton never won for itself a place in the affections of the Greeks of Hellas; it was regarded as a barbarian instrument affected by those only whose tastes in matters of art were unorthodox. It had fallen into disuse in the days of Aristotle,¹ but reappeared under the Romans.

In spite of the few meagre shreds of authentic information extant concerning this somewhat elusive instrument, it is possible nevertheless to identify the barbiton as it was known among the Greeks and Romans. From the Greek writers we know that it was an instrument having some feature or features in common with the lyre, which warranted classification with it. From the Persians and Arabs we learn that it was a kind of *rebab* or *lute*, or a chelys-lyre,² first introduced into Europe through Asia Minor by way of Greece, and centuries later into Spain by the Moors, amongst whom it was in the 14th century known as *al-barbet*.³ There is a stringed instrument, as yet unidentified by name, of which there are at least four different representations in sculpture,⁴ which combines the characteristics of both lyre and rebab, having the vaulted back and gradual narrowing to

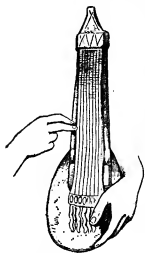

form a neck which are typical of the rebab and the stringing of the lyre. In outline it resembles a large lute with a wide neck, and the seven strings of the lyre of the best period, or sometimes nine, following the decadent lyre. Most authors in reproducing these sculptures showing the barbiton represent the instrument as boat-shaped and without a neck, as, for instance, Carl Engel. This is due to the fact that the part of the instrument where neck joins body is in deep shadow, so that the correct outline can hardly be distinguished, being almost hidden by hand on one side and drapery on the other.

The barbiton, as pictured here, had probably undergone considerable modification at the hands of the Greeks and had diverged from the archetype. The barbiton, however, although it underwent many changes, retained until the end the characteristics of the instruments of the Greek lyre whose strings were plucked, whereas the rebab was sounded by means of the bow at the time of its introduction into Europe. At some period not yet determined, which we can but conjecture, the barbat approximated to the form of the large lute (*q.v.*). An instrument called barbiton was known in the early part of the 16thth and during the 17th century. It was a kind of

¹ *Polit.* viii. (v.), 6, ed. Susemihl-Hicks (1894), pp. 604 (=1341a 40) and 632; Daremberg and Saglio, *Dict. d'ant. gr. et rom.*, article "Lyre," p. 1450, for a few more references to the classic.

² Johnson's Persian-Arabic-English dictionary, *barbat*, a harp or lute, *barbatan*, player upon lute, pl. *barbat*; G. W. Freytag, *Lexicon Arabico-Latinum*, i. p. 102: *barbat* (Persian and Arabic), barbitus, genus testudinis, plerumque sex septemve chordis instructum (rotundum habet formam in Africa); *Lexicon Aegidii Forcellini* (Prato, 1858); "Barbiton aurataque chely a doctis fidibus personare" (Martianus Capella i. 36); G. B. Doni, *Lyra Barberina*, ii. index.

³ *Enumeration of Arab Musical Instruments*, xiv. c.

⁴ (a) See C. Clapar, *Musée du Louvre*, vol. i. pl. 202, No. 261. (b) Accompanying illustration. See also Kathleen Schlesinger, *Orchestral Instruments*, part ii., "Precursors of the Violin Family," fig. 108 and p. 23, pp. 106-107, fig. 144 and appendix. (c) Sarcophagus in the cathedral of Girgenti in Sicily, illustrated by Carl Engel, *Early History of the Violin Family*, p. 112. A cast is preserved in the sepulchral basement at the British Museum. Domenico, *Lo Faso Pietra-Santa, le antichità della Sicilia* (Palermo, 1834), vol. 3, pl. 45 (2), text p. 89. (d) G. Zoega, *Antike Basreliefs von Rom* (Giesens, 1812), atlas, pl. 98, sarcophagus representing a scene in the story of Hippolytus and Phaedra.

⁵ In Jacob Locher's *Navis Stultifera* (Basel, 1506), titulus 7, is an illustration of a small harp and lute with the legend *nec cytharum langti nec barbiton*.

theorb or bass-lute, but with one neck only, bent back at right angles to form the head. Robert Fludd⁶ gives a detailed description of it with an illustration:—"Inter quae instrumenta non nulla barbitio similissima effinxerunt ejusmodi sunt illa quae vulgo appellantur theorba, quae sonos graviores reddunt chordasque nervosas habent." The people called it *theorb*, but the scholar having identified it with the instrument of classic Greece and Rome called it barbiton. The barbiton had nine pairs of gut strings, each pair being in unison. Dictionaries of the 18th century support Fludd's use of the name barbiton. G. B. Doni⁷ mentions the barbiton, defining it in his index as *Barbitos seu major chelys italica theorba*, and deriving it from lyre and cithara in common with testudines, theorbas and all tortoiseshell instruments. Claude Perrault,⁸ writing in the 18th century, states that "les modernes appellent notre luth barbiton" (the moderns call our lute barbiton). Constantijn Huygens⁹ declares that he learnt to play the barbiton in a few weeks, but took two years to learn the cittern.

The *barbat* was a variety of *rebab* (*q.v.*), a bass instrument, differing only in size and number of strings. This is quite in accordance with what we know of the nomenclature of musical instruments among Persians and Arabs, with whom a slight deviation in the construction of an instrument called for a new name.¹⁰ The word *barbut* applied to the barbiton is said to be derived¹¹ from a famous musician living at the time of Chosroes II. (A.D. 590-628), who excelled in playing upon the instrument. From a later translation of part of the same authority into German¹² we obtain the following reference to Persian musical instruments: "Die Sängler stehen bei seinem Gastmahl; in ihrer Hand Barbut⁽¹¹⁾ und Leyer⁽¹¹⁾ und Laute⁽¹¹⁾ und Def⁽¹¹⁾ und Deff (Handpauke)." Mr Ellis, of the Oriental Department of the British Museum, has kindly supplied the original Persian names translated above, i.e. (i.) *barbut*, (ii.) *chang*, (iii.) *rubab*, (iv.) *nei*. The *barbut* and *rubab* thus were different instruments as late as the 10th century in Persia. There were but slight differences if any between the archetypes of the pear-shaped rebab and of the lute before the application of the bow to the former—both had vaulted backs, body and neck in one, and gut strings plucked by the fingers. (K. S.)

BARBIZON, a French village, near the forest of Fontainebleau, which gave its name to the "Barbizon school" of painters, whose leaders were Corot, Rousseau, Millet and Daubigny, together with Diaz, Dupré, Jacque, Français, Hargipnies and others. They put aside the conventional idea of "subject" in their pictures of landscape and peasant life, and went direct to the fields and woods for their inspiration. The distinctive note of the school is seen in the work of Rousseau and of Millet, each of whom, after spending his early years in Paris, made his home in Barbizon. Unappreciated, poor and neglected, it was not until after years of struggle that they attained recognition and success. They both died at Barbizon—Rousseau in 1867 and Millet in 1875. It is difficult now to realize that their work, so unaffected and beautiful, should have been so hardly received. To understand this, it is necessary to remember the conflicts that existed between the classic and romantic schools in the first half of the 19th century, when the classicists, followers of the tradition of

⁶ *Historia Utriusque Cosmi* (Oppenheim, 1617), tom. i. tract ii. part ii. lib. iv. cap. i. p. 226.

⁷ *Lyra Barberina*, vol. ii. index, and also vol. i. p. 29.

⁸ "La Musique des anciens," *Ceuvres complètes* (ed. Amsterdam, 1727), tom. i. p. 306.

⁹ *De Vita propria sermonum inter liberos libri duo* (Haarlem, 1817). See also Edmund van der Straeten, *La Musique aux Pays-Bas*, vol. ii. p. 349.

¹⁰ See *The Seven Seas*, a dictionary and grammar of the Persian language, by Ghazi ud-din Haidar, king of Oudh, in seven parts (Lucknow, 1822) (only the title of the book is in English). A review of this book in German with copious quotations by von Hammer-Purgstall is published in *Jahrbücher der Literatur* (Vienna, 1826), Bd. 35 and 36; names of musical instruments, Bd. 36, p. 292 et seq. See also R. G. Kiesewetter, *Die Musik der Araber, nach Originalquellen dargestellt* (Leipzig, 1843, p. 91, classification of instruments).

¹¹ *The Seven Seas*, part i. p. 153; *Jahrb. d. Literatur*, Bd. 36, p. 294.

¹² Fr. Rückert, *Grammatik, Poetik und Rhetorik der Perser*, nach dem 7ten Bde. des Hefts Kolszum (Gotha, 1874), p. 80.

David, were the predominant school. The romantic movement, with Géricault, Bonington and Delacroix, was gaining favour. In 1824 Costable's pictures were shown in the Salon, and confirmed the younger men in their resolution to abandon the lifeless pedantry of the schools and to seek inspiration from nature. In those troubled times Rousseau and Millet unburdened their souls to their friends, and their published lives contain many letters, some extracts from which will express the ideals which these artists held in common, and show clearly the true and firmly-based foundation on which their art stands. Rousseau wrote, "It is good composition when the objects represented are not there solely as they are, but when they contain under a natural appearance the sentiments which they have stirred in our souls. . . . For God's sake, and in recompense for the life He has given us, let us try in our works to make the manifestation of life our first thought: let us make a man breathe, a tree really vegetate." And Millet—"I try not to have things look as if chance had brought them together, but as if they had a necessary bond between themselves. I want the people I represent to look as if they really belonged to their station, so that imagination cannot conceive of their ever being anything else. People and things should always be there with an object. I want to put strongly and completely all that is necessary, for I think things weakly said might as well not be said at all, for they are, as it were, deflowered and spoiled—but I profess the greatest horror for uselessness (however brilliant) and filling up. These things can only weaken a picture by distracting the attention toward secondary things." In another letter he says—"Art began to decline from the moment that the artist did not lean directly and naively upon impressions made by nature. Cleverness naturally and rapidly took the place of nature, and decadence then began. . . . At bottom it always comes to this: a man must be moved himself in order to move others, and all that is done from theory, however clever, can never attain this end, for it is impossible that it should have the breath of life." The ideas of the "Barbizon school" only gradually obtained acceptance, but the chief members of it now rank among the greater artists of their time.

See D. Croal Thomson, *The Barbizon School* (1891), with a full list of the French authorities to be consulted; Jules Breton, *Nos peintres du siècle*, Paris, 1900.

BARBON, NICHOLAS (c. 1640-1698), English economist, probably the son of Praise-god Barbon, was born in London, studied medicine at Leiden, graduated M.D. at Utrecht in 1661, and was admitted an honorary fellow of the College of Physicians in 1664. He took a considerable part in the rebuilding of London after the great fire of 1666, and has a claim to be considered the institutor of fire-insurance in England, which he started somewhere about 1680. He was M.P. for Bramber in 1690 and 1695. He founded a land bank which, according to contemporaries, was fairly successful and was united with that of John Briscoe in 1666. He died in 1698. His writings are interesting as expressing views much in advance of his time and very near akin to those of modern times on such important topics as value, rent and foreign trade. The more important were *Apology for the Builder; or a Discourse showing the Cause and Effects of the Increase of Building* (1685); *A Discourse of Trade* (1690); and *A Discourse Concerning Coining the New Money Lighter* (1696).

BARBON (BAREBONE or BAREBONES), **PRASE-GOD** (c. 1596-1679), English leather-seller and Fifth Monarchy man, was admitted freeman of the Leathersellers Company on the 20th of January 1623 and liveryman on the 13th of October 1634. About the same time he became minister to a congregation which assembled at his own house, "The Lock and Key," in Fleet Street, where his preaching attracted large audiences. The exact nature of his religious opinions is not perfectly clear. He is styled by his enemies a Brownist and Anabaptist, i.e. probably Baptist, but he wrote two books in support of paedobaptism, and his congregation had separated from a larger one of Baptists on that point of controversy. Later he belonged to the sect of Fifth Monarchy men. He was the object of the abuse and ridicule of the opposite party, and his meetings were fre-

quently disturbed by riots. On the 20th of December 1641 his house was stormed by a mob and he narrowly escaped with his life. Barbon, who was a man of substantial property, was summoned by Cromwell on the 6th of June 1653 as a member for London to the assembly of nominees called after him in derision Barebone's Parliament. His name is occasionally mentioned, but he appears to have taken no part in the debates. In 1660 he showed great activity in endeavouring to prevent the Restoration. He published Needham's book, *News from Brussels in a Letter from a Near Attendant on His Majesty's Person . . .*, which retailed unfavourable anecdotes relating to Charles's morals, and on the 9th of February he presented the petition to the Parliament, which proposed that all officials should abjure the Stuarts, and all publicly proposing the Restoration should be deemed guilty of high treason. His conduct drew upon him several royalist attacks. On the 31st of March he was obliged to sign an engagement to the council not to disturb the peace, and on the 26th of November 1661 he was arrested, together with John Wildman and James Harrington, and was imprisoned in the Tower till the 27th of July 1662, when he was released on bail. Barbon, who was married, was buried on the 9th of January 1680. He was the author of *A Discourse tending to prove . . . Baptism . . . to be the ordinance of Jesus Christ*. As also that *the Baptism of Infants is weariable* (1642), the preface of which shows a spirit of wide religious tolerance; and *A Reply to the Frivolous and Impertinent answer of R. B. and E. B. to the Discourse of P. B.* (1643).

BARBOUR, JOHN (? 1316-1395), Scottish poet, was born, perhaps in Aberdeenshire, early in the 14th century, approximately 1316. In a letter of safe-conduct dated 1357, allowing him to go to Oxford for study, he is described as archdeacon of Aberdeen. He is named in a similar letter in 1364 and in another in 1368 granting him permission to pass to France, probably for further study, at the university of Paris. In 1372 he was one of the auditors of exchequer, and in 1373 a clerk of audit in the king's household. In 1375 (he gives the date, and his age as 60) he composed his best known poem *The Brus*, for which he received, in 1377, the gift of ten pounds, and, in 1378, a life-pension of twenty shillings. Additional rewards followed, including the renewal of his exchequer auditorship (though he may have continued to enjoy it since his first appointment) and ten pounds to his pension. The only biographical evidence of his closing years is his signature as a witness to sundry deeds in the "Register of Aberdeen" as late as 1392. According to the obit-book of the cathedral of Aberdeen, he died on the 13th of March 1395. The state records show that his life-pension was not paid after that date.

Considerable controversy has arisen regarding Barbour's literary work. If he be the author of the five or six long poems which have been ascribed to him by different writers, he adds to his importance as the father of Scots poetry the reputation of being one of the most voluminous writers in Middle English, certainly the most voluminous of all Scots poets.

(1) *The Brus*, in twenty books, and running to over 13,500 four-accent lines, in couplets, is a narrative poem with a purpose partly historical, partly patriotic. It opens with a description of the state of Scotland at the death of Alexander III. (1286) and concludes with the death of Douglas and the burial of the Bruce's heart (1332). The central episode is the battle of Bannockburn. Patriotic as the sentiment is, it is in more general terms than is found in later Scots literature. The king is a hero of the chivalric type common in contemporary romance; freedom is a "noble thing" to be sought and won at all costs; the opponents of such freedom are shown in the dark colours which history and poetic propriety require; but there is none of the complacency of the merely provincial habit of mind. The lines do not lack vigour; and there are passages of high merit, notably the oft-quoted section beginning "Al fredome is a noble thing." Despite a number of errors of fact, notably the confusion of the three Bruces in the person of the hero, the poem is historically trustworthy as compared with contemporary verse-chronicle, and especially with the *Wallace* of the next century. No one

has doubted Barbour's authorship of the *Brus*, but argument has been attempted to show that the text as we have it is an edited copy, perhaps by John Ramsay, a Perth scribe, who wrote out the two extant texts, preserved in the Advocates' library, Edinburgh, and in the library of St John's College, Cambridge. Extensive portions of the poem have been incorporated by Wyntoun (*q.v.*) in his *Chronicle*. The first printed edition extant is Charteris's (Edinburgh, 1571); the second is Hart's (Edinburgh, 1616).

(2) Wyntoun speaks (*Chronicle* III. ii.) of a "Tretreis" which Barbour made by way of "a genealogy" of "Brutus lynagis"; and elsewhere in that poem there are references to the archdeacon's "Stewartis Oryginale." This "Brut" is unknown; but the reference has been held by some to be to (3) a Troy-book, based on Guido da Colonna's *Historia Destructionis Troiae*. Two fragments of such a work have been preserved in texts of Lydgate's *Troy-book*, the first in MS. Camb. Univ. Lib. Kk. v. 30, the second in the same and in MS. Douc. 148 in the Bodleian library, Oxford. This ascription was first made by Henry Bradshaw, the librarian of Cambridge University; but the consensus of critical opinion is now against it. Though it were proved that these Troy fragments are Barbour's, there remains the question whether their identification with the book on the Stewart line is justified. The scale of the story in these fragments forces us to doubt this identification. They contain 595+318=3713 lines and are concerned entirely with "Trojan" matters. This would be an undue allowance in a Scottish "genealogy."

(4) Yet another work was added to the list of Barbour's works by the discovery in the university library of Cambridge, by Henry Bradshaw, of a long Scots poem of over 33,000 lines, dealing with *Legends of the Saints*, as told in the *Legenda Aurea* and other legends. The general likeness of this poem to Barbour's accepted work in verse-length, dialect and style, and the facts that the lives of English saints are excluded and those of St Machar (the patron saint of Aberdeen) and St Ninian are inserted, made the ascription plausible. Later criticism, though divided, has tended in the contrary direction, and has based its strongest negative judgment on the consideration of rhymes, assonance and vocabulary (see bibliography). That the "district" of the author is the north-east of Scotland cannot be doubted in the face of a passage such as this, in the fortieth legend (St Ninian), II, 1359 et seq.

"A lytil tale tet herd I tel,
 þat in to my tyme befel,
 of a gudman, in murrefe, [Moray] borne
 in eglyne [Elgin], and his kine beforen,
 and callit was a rithful man
 with al lame þat hyme knew than;
 & þis mare trastely I say,
 for I kend hyme wele my day.
 John balormy tes his name,
 a man of ful gud fame."

But whether this north-east Scots author is Barbour is a question which we cannot answer by means of the data at present available.

(5) If Barbour be the author of the *Legends*, then (so does one conclusion hang upon another) he is the author of a Gospel story with the later life of the Virgin, described in the prologue to the *Legends* and in other passages as a book "of the birth of Jhesu criste" and one "quhare-in I recordit the genology of our lady sanct Mary."

(6) In recent years an attempt has been made to name Barbour as the author of the *Book of Alexander* (a translation of the *Roman d'Alexandre* and associated pieces, including the *Vaux du Paon*), as known in the unique edition, c. 1580, printed at the Edinburgh press of Alexander Arbuthnot. The "argument" as it stands is nothing more than an exaggerated inference from parallel-passages in the *Bruce* and *Alexander*; and it makes no allowance for the tags, epithets and general vocabulary common to all writers of the period. Should the assumption be proved to be correct, and should it be found that the "Troy fragments" were written first of all, followed by *Alexander* and *Bruce* or *Bruce* and *Alexander*, and that the *Legends* end the chapter, it will be by "evidence" other than that which has been produced to this date.

For Barbour's life see *Exchequer Rolls of Scotland*, ii. and iii.; *Registrum Episcopatus Aberdonensis* (Spalding Club); *Rymer's Foedera*.

WORKS.—(1) *The Brus* MSS. and early editions u.s. Modern editions: J. Pinkerton, 3 vols. (1790) (called by the editor "the first genuine edition," because printed from the Advocates' Library text, but carelessly); Jamieson (1820); Cosmo Innes (Spalding Club, 1856); W. W. Skeat (Early English Text Society, 1870-1889; reprinted, after revision by the editor, by the Scottish Text Society, 1893-1895). On the question of the recension of Barbour's text, see J. T. Brown, *The Wallace and The Bruce restudied* (Bonn, 1900). (2) and (3) *Troy Fragments*. C. Horstmann has printed the text in his *Legendensammlung (ut infra)*. See Bradshaw, *Transactions of the Cambridge Antiquarian Society* (1866); the prolegomena in Horstmann's edition; Skeat, *Brus* (S. T. S. edit. u.s. pp. xlvi. et seq.); Köppel, "Die Fragmente von Barbour's Trojanerkrieg," in *Englische Studien*, x. 373; Froyne and Donaldson, *The Gest Historiale of the Destruction of Troy* (E. E. T. S. pt. ii. Introd. pp. x. et seq.); G. Neilson (*ut infra*); and J. T. Brown (*ut supra*) *passim*. (4) *Legends of the Saints*. C. Horstmann, who upholds Barbour's authorship, has printed the text in his *Barbour's des schottischen Nationaldichters Legendensammlung nebst den Fragmenten seines Trojanerkrieges*, 2 vols. (Heilbronn, 1881-1882), and that of the legend of St Machar in his *Allenglische Legenden. Neue Folge* (Heilbronn, 1881) pp. 189-208. A later edition by W. M. Metcalfe, who disputes Barbour's claim, appeared in 1896 (*Legends of the Saints in the Scottish Dialect of the Fourteenth Century*, 3 vols., Scottish Text Society). See the introductions to these editions; also Skeat and Köppel *ut supra*, and P. Bucher, *Sind die von Horstmann herausgegebenen schottischen Legenden ein Werk Barbour's?* (Halle, 1886) (cf. *Anglia*, ix. 3, 1886). (5) For the Gospel-story evidence see Metcalfe, u.s. i. xxix. (6) On the *Alexander Book* and its assumed relationships, see G. Neilson, *John Barbour, Poet and Translator* (1900) (a reprint from the *Transactions of the Philological Society*); J. T. Brown u.s. i. "Postscript," pp. 156-171; and *Athenaeum*, 17th of November, 1st and 8th December 1900, and the 9th of February 1901. (G. G. S.)

BARBUDA, an island in the British West Indies. It lies 25 m. N. of Antigua, of which it is a dependency, in 17° 33' N. and 61° 43' W., and it has an area of 62 sq. m. Pop. (1901) 775. It is flat and densely wooded. On the western side there is a large lagoon, separated from the sea by a spit of sand. The part of the island under cultivation is very fertile, and the air is remarkable for its purity. Cattle and horses are bred and wild deer are still found. Salt and phosphates of lime are exported. The island was annexed by Great Britain in 1628 and was bestowed in 1680 upon the Codrington family who, for more than 200 years, held it as a kind of feudal fief.

BARBY, a town of Germany, in the kingdom of Prussia, on the left bank of the Elbe, 82 m. S.W. of Berlin on the direct railway to Cassel. Pop. (1900) 5136. It has two evangelical churches and a seminary for school teachers, which is housed in the former castle of the lords of Barby. The industries are mainly agricultural, but there are sugar factories and breweries. Here from 1749 to 1809 was a settlement of the Herrnhut evangelical brotherhood.

BARCA (mod. *Merj*), an ancient city founded in the territory of Cyrene in the middle of the 6th century B.C. Rising quickly to importance it became a rival of the older city, and gave its name to the western province of the latter's territory. The name as a provincial designation is still in occasional use, but is now applied to all the province of Bengazi. Barca is said to have owed its origin to Greek refugees flying from the tyranny of Arcesilaus II. (see *CYRENE*), but it is certain that it was rather a Libyan than a Greek town at all times. A Persian force invited by the notorious Pheretima, mother of Arcesilaus III., in revenge for Barcan support of a rival faction, sacked it towards the close of the 6th century and deported a number of its inhabitants to Bactria. Under Ptolemaic rule it began to decline, like Cyrene, and its port Ptolemais (Tolmeita) took its place; but after the Arab conquest (A.D. 641) it became the chief place of the Cyrenaica for a time and a principal station on the Kairwan road. Though now a mere village, Merj is still the chief centre of administration inland, and has a fort and small garrison. No ruins of earlier period than the late Roman and early Arab seem to be visible on the site. The latter lies, like Cyrene, about ten miles from the coast on the crest of Jebel Akhdar, here sunk to a low downland. It owed its early prosperity to its easy access to the sea, and to the fact that natural conditions in Cyrenaica and the

Sahara behind it, tend to divert trade to the west of the district—a fact which is exemplified by the final survival of Berenice (mod. Bengazi). Merj stands in a rich but ill-cultivated stretch of red soil. (D. G. H.)

BARCAROLE, or **BARCAROLLE** (Ital. *barcaruola*, a boat-song), properly a musical term for the songs sung by the Venetian gondoliers, and hence for an instrumental or vocal composition, generally in 6-8 time, written in imitation of their characteristic rhythm.

BARCELONA, a maritime province of north-eastern Spain, formed in 1833 out of districts belonging to the ancient kingdom of Catalonia, and bounded on the N.E. and E. by Gerona; S. by the Mediterranean Sea; S.W. by Tarragona; and W. and N.W. by Lérida. Pop. (1900) 1,054,541; area 2968 sq. m. Apart from a few tracts of level country along the coast and near Igualada, Manresa, Sabadell and Vich, almost the whole surface consists of mountain ranges, often densely wooded, rich in minerals and intersected by deep ravines. These ranges are outliers of the Pyrenees, which extend along the northern frontier, forming there the lofty Sierra del Cadi with the peak of Tosa (8317 ft.). Towards the sea, the altitudes become gradually less, although not with a uniform decrease; for several isolated peaks and minor ranges such as Montserrat and Monseny rise conspicuously amid the lower summits to a height of 4000-6000 ft. The central districts are watered by the Llobregat, which rises at the base of the Sierra del Cadi, and flows into the sea near Barcelona, the capital, after receiving many small tributaries. The river Ter crosses the eastern extremity of the province.

Barcelona can be divided into three climatic zones; a temperate one near the sea, where even palm and orange trees grow; a colder one in the valleys and plains, more inland; and a colder still among the mountains, where not a few peaks are snow-clad for a great part of the year. Agriculture and stock-keeping are comparatively unimportant in this province, which is the centre of Spanish industry and commerce. In every direction the country looks like a veritable hive of human activity and enterprise, every town and village full of factories, and alive with the din of machinery. Lead, zinc, lignite, coal and salt are worked, and there are numerous mineral springs; but the prosperity of the province chiefly depends on its transit trade and manufactures. These are described in detail in articles on the chief towns. Barcelona (pop. 1900, 533,000), Badalona (19,240), Cardona (3855), Igualada (10,442), Manresa (23,252), Mataró (19,704), Sabadell (23,294), Tarrasa (15,956), Vich (11,628) and Villanueva y Geltrú (11,856). Berga (5465), perhaps the Roman Castrum Bergium, on the Llobregat, is the home of the Catalan cotton industry. None of the rivers is navigable, and the roads are in general indifferent and insufficient. The province is better off in regard to railways, of which there are 349 m. Important lines radiate from the city of Barcelona north-east along the coast to Gerona and to Perpignan in France; south-west along the coast to Tarragona and Valencia; and west to Saragossa and Madrid. Several local railways link together the principal towns. For a general description of the people, and for the history of this region see CATALONIA. The population is greater and increases more rapidly than that of any other Spanish province, a fact due not to any large excess of births over deaths, but to the industrial life which attracts many immigrants. In the last quarter of the 19th century the increase exceeded 200,000, while the average yearly number of emigrants was below 2000. In point of education this province is quite among the first in Spain, and as far back as 1880 there were 97,077 children enrolled on the school registers; the figures have since steadily increased.

BARCELONA, formerly the capital of Catalonia, and since 1833 the capital of the province of Barcelona in eastern Spain, in 41° 23' N. and 2° 11' E., on the Mediterranean Sea, and at the head of railways from Madrid, Saragossa, and Perpignan in France. Pop. (1900) 533,000. Barcelona is a flourishing city and the principal seaport of Spain. It is built on the sloping edge of a small plain between the rivers Besòs, on the north, and Llobregat, on the south. Immediately to the south-west the fortified hills of

Montjuich rise to an altitude of 650 ft., while the view is bounded on the west by the heights which culminate in Tibidabo (1745 ft.), and on the north-east by the Montañas Matas. The greater part of the space thus enclosed is occupied by comparatively modern suburbs and gardens of almost tropical luxuriance, strongly contrasting with the huge factories and busy port of the original city in their midst.

Barcelona was formerly surrounded by a strong line of ramparts, and defended, or more correctly, overawed by a citadel on the north-east, erected in 1715 by Philip V.; but these fortifications being felt as a painful restriction on the natural development of the city, were, in spite of the opposition of the central government, finally abolished by the local authorities in 1845. The walls of the moat were utilized for the cellars of the houses which soon occupied the site of the ramparts, and the ground, which had been covered by the citadel, was laid out in gardens. A rapid extension of the city to the north-west took place, and in 1860 an elaborate plan for the laying out of new districts received the royal sanction. Barcelona thus comprises an old town, still consisting for the most part of irregular and narrow streets, and a new town built with all the symmetry and precision of a premeditated scheme. The buildings of the old town are chiefly of brick, from four to five storeys in height, with flat roofs, and other oriental peculiarities; while in the new town hewn stone is very largely employed, and the architecture is often of a modern English style. To the east, on the tongue of land that helps to form the port, lies the suburb Barceloneta. It owes its origin to the marquis de la Mina, who, about 1754, did much for the city, and is regularly laid out, the houses being built of brick after a uniform pattern. The main street or axis of the old town is the Rambla, which has a fine promenade planted with plane-trees running down the middle, and contains the principal hotels and theatres of the city. The most important suburbs are Gràcia, Las Cortes de Sarrià, Horta, San Andrés de Palomar, San Gervasio de Cassòs, San Martín de Provensals and Sans. Exclusive of these, the city contains about 334,000 inhabitants, an increase of nearly 150,000 since 1857. Large numbers of immigrant artisans joined the population during the latter half of the 19th century, attracted by the great development of industry. Barcelona is the see of a bishop, and, like most Spanish towns, has a large number of ecclesiastical buildings, though by no means so many as it once possessed. No fewer than eighteen convents were still standing in 1873. The cathedral, erected between 1298 and 1448 on Monte Taber, an oval hill which forms the highest point of the Rambla, is one of the finest examples of Spanish Gothic; although it is not designed on a great scale and some parts have been freely modernized. It contains the early 14th-century tomb of Santa Eulalia, the patron saint of the city, besides many other monuments of artistic or historical interest. Its stained glass windows are among the finest in Spain, and it possesses archives of great value. Santa Maria del Mar, Santa Ana, Santos Justo y Pastor, San Pedro de las Puellas, and San Pablo del Campo are all churches worthy of mention.

The educational institutions of Barcelona have from an early period been numerous and important. The university (*Universidad Literaria*), which was originally founded in 1430 by the magistracy of the city, and received a bull of confirmation from Pope Nicholas V. in 1450, possessed at that time four faculties and thirty-one chairs all endowed by the corporation. It was suppressed in 1714, but restored in 1841, and now occupies an extensive building in the new town. There are, besides, an academy of natural sciences, a college of medicine and surgery—confirmed by a bull of Benedict XIII. in 1400—an academy of fine arts, a normal school, a theological seminary, an upper industrial school, an institution for the education of deaf-mutes, a school of navigation and many minor establishments. Gratuitous instruction of a very high order is afforded by the Board of Trade to upwards of 2000 pupils. The principal charitable foundations are the Casa de Caridad or house of charity, the hospital general, dating from 1401, and the founding hospital. The principal civic and commercial buildings are the

Casa Consistorial, a fine Gothic hall (1369-1378), the Lonja or exchange (1383), and the Aduana or custom-house (1792). At the seaward end of the Rambla is a large ancient structure, the Atarazanas or Arsenals, which was finished about 1243, and partly demolished in the 19th century to give a better view to the promenade. Remains of the former royal state of Barcelona are found in the Palacio Real of the kings of Aragon and the Palacio de la Reina. At the highest part of the city, in the Calle del Paradis, are some magnificent columns, and other Roman remains, which, however, are hidden by the surrounding buildings. Means of public recreation are abundantly supplied. There are many theatres, the two most important being the Teatro Principal, and the Teatro del Liceo, a very fine building, originally erected in 1845 on the site of a convent of Trinitarian monks. The number of restaurants and similar places of evening resort is very great, and there are several public courts where the Basque game of pelota can be witnessed.

The so-called port of Barcelona was at first only an open beach, on the east, slightly sheltered by the neighbouring hills, but at an early period the advantage of some artificial protection was felt. In 1438 Don Alphonso V. granted the magistracy a licence to build a mole; and in 1474 the Moll de Santa Creu was officially begun. Long after this, however, travellers speak of Barcelona as destitute of a harbour; and it is only in the 17th century that satisfactory works were undertaken. Until modern times all the included area was shut off from the open sea by a sand-bank, which rendered the entrance of large vessels impossible. An extension of the former mole, and the construction of another from the foot of Montjuich, have embraced a portion of the sea outside of the bank, and a convenient shelter is thus afforded for the heaviest battleships. From 1873 the work of extension and improvement was carried on systematically, with the addition of new quays, greater storage room, and better means for handling cargo. After thirty years of steady development, further plans were approved in 1903. At this time the port included an inner harbour, with a depth of 18 to 30 ft. at low tide, and an outer harbour with a depth of 20 to 35 ft. In the following year 8075 vessels of nearly 5,000,000 tons entered the port. Barcelona is well supplied with inland communication by rail, and the traffic of its streets is largely facilitated by tramway lines running from the port as far as Gràcia and the other chief suburbs.

Barcelona has long been the industrial and commercial centre of eastern Spain—a pre-eminence which dates from the 12th and 13th centuries. It received a temporary check from the disasters of the Spanish-American War of 1898; but less than a year later it paid about £550,000 in industrial and commercial taxes, or more than 11% of the whole amount thus collected in the kingdom; and within five years it had become a port of regular call for thirty-five important shipping companies. It also contained the head offices of thirteen other lines, notably those of the Transatlantic Mail Company, which possessed a fleet of twenty-five fine steamships. Trades and industries give occupation to more than 150,000 hands of both sexes. The spinning and weaving of wool, cotton and silk are the principal industries, but the enterprising spirit of the Catalans has compelled them to try almost every industry in which native capital could attempt to compete with foreign, especially since the institution of the protectionist tariffs of 1892. The native manufacturers are quite able to compete in peninsular markets with foreign rivals. This prosperity has been in part due to the great development of means of communication around the city and in the four Catalan provinces. Comestibles, raw materials, and combustibles form the greater part of the imports, but this great manufactory also imports a considerable quantity of foreign manufactured goods. The principal exports are wines, cereals, olive-oil, cotton goods, soap, cigarette-paper, furniture and barrels, boots, shoes and leather goods, and machinery.

Barcino, the ancient name of the city, is usually connected with that of the Carthaginian Hamilcar Barca, its traditional founder in the 3rd century B.C. After the Roman conquest, it received from Augustus (27 B.C.—A.D. 14) the name of Julia Faventia (afterwards Augusta and Pia), with the status of a

Roman colony; and thenceforward it rapidly grew to be the leading mart of the western Mediterranean, rivalling Tarraco (Tarragona) and Massilia (Marseilles) as early as the 2nd century A.D. As its remains testify, the Roman city occupied Monte Taber. The bishopric of Barcelona was founded in 343. In 415 and 531, the Visigoths chose Barcelona as their temporary capital; in 540 and 599 church councils were held there. Barcino or Bardjaluna, as it was then called, was captured by the Moors in 713, and in 801 it passed, with the rest of Catalonia, under the dominion of the Franks. From 874 the counts of Barcelona ruled as independent monarchs. But the accession of larger resources due to the union between Catalonia and Aragon in 1149, brought the city to the zenith of its fame and wealth. Its merchant ships vied with those of Genoa, Venice and Ragusa, trading as far west as the North Sea and the Baltic, and as far east as Alexandria. In 1258 James I. of Aragon empowered Barcelona to issue its famous *Consulado del Mar*, a code of maritime law recognized as authoritative by many European states. Consuls represented Barcelona at the principal commercial centres on or near the Mediterranean; and the city was among the first communities to adopt the practice of marine insurance. But the union of Castile and Aragon in 1479 favoured other cities of Spain at the expense of Barcelona, whose commercial supremacy was transferred to the ports of western Spain by the discovery of America in 1492. The citizens attributed their misfortunes to the "Castilian" government, and a strong party among them favoured annexation by France. In 1640 Barcelona was the centre of the Catalanian rebellion against Philip IV., and threw itself under French protection. In 1652 it returned to its allegiance, but was captured by the duke of Vendôme in 1697. At the peace of Ryswick, in the same year, it was restored to the Spanish monarchy. During the War of the Succession (1701-1714) Barcelona adhered to the house of Austria. The seizure of Montjuich in 1705, and the subsequent capture of the city by the earl of Peterborough, formed one of his most brilliant achievements. In 1714 it was taken after an obstinate resistance by the duke of Berwick in the interests of Philip V., and at the close of the war was reluctantly reconciled to the Bourbon dynasty. In 1809 the French invaders of Spain obtained possession of the fortress and kept the city in subjection until 1814. Since then it has shared in most of the revolutionary movements that have swept over Spain, and has frequently been distinguished by the violence of its civic commotions. For the historic antagonism between the Catalans and the other inhabitants of Spain was strengthened by the industrial development of Barcelona. Among the enterprising and shrewd Catalans, who look upon their rulers as reactionary, and reserve all their sympathies for the Provençal neighbours whom they so nearly resemble in race, language and temperament, French influence and republican ideas spread rapidly; taking the form partly of powerful labour and socialist organizations, partly of less reputable bodies, revolutionary and even anarchist. Strikes are very common, seventy-three having occurred in such a year of comparative quiet as 1903; but the causes of disturbance are almost as often political as economic, and the annals of the city include a long list of revolutionary riots and bomb outrages. A strange contrast is presented by the co-existence of these turbulent elements with the more old-fashioned Spanish society of Barcelona. Church festivals, civic and ecclesiastical processions are almost as animated and picturesque as in Seville itself; and many medieval customs continue to flourish side by side with the most modern features of industrial life, giving to Barcelona a character altogether unique among Spanish cities.

The literature relating to Barcelona is extensive. For a general description of the city, see A. A. P. Arimon, *Barcelona antigua y moderna*, two illustrated folio volumes (Madrid, 1850); and J. Artigas y Felner, *Guía itineraria de Barcelona* (Barcelona, 1888). For the antiquities, see S. Sampaor, *Topografía antigua de Barcelona* (1896). The economic history of the city is dealt with by A. Capmany in his *Memorias historicas sobre la marina, comercio, y artes de la antigua ciudad de Barcelona* (Madrid, 1779-1792); and for its political history, the same work should be consulted, together with *Historias y conquestas dels comtes de Barcelona*, by T. Tomich (Barcelona, 1888), and the *Colecció de documents inédits del Arxí*

municipal de la ciutat de Barcelona (Barcelona, 1892). The spread of the revolutionary movement is traced by M. Gil Maestre, in his *El Anarquismo en España, y el especial de Barcelona* (Madrid, 1897), and in his *La Criminalidad en Barcelona* (Barcelona, 1886).

BARCELONA, a town and port of Venezuela, capital of the state of Bermudez, on the Neveri river, 3 m. from its mouth and 12 m. by rail from the port of Guanta, which has superseded the incommodious river port in the trade of this district. Pop. (est. 1904) 13,000. Built on the border of a low plain and having a mean annual temperature of 82° F., the town has the reputation of being unhealthy. There are salt works and important coal deposits in its vicinity, the latter at Narical and Capirucal, 12 m. distant by rail. Though the adjacent country is fertile, its prosperity has greatly declined, and the exports of coffee, sugar, cacao and forest products are much less important than formerly. The town dates from 1637, when it was located at the foot of the Cerro Santo and was called Nueva Barcelona; it reached a state of much prosperity and commercial importance before the end of the century. The War of Independence, however, and the chronic political disorders that followed nearly ruined its industries and trade.

BARCELONNETTE, a town in the department of Basses-Alpes, in the S.E. of France. Pop. (1906) 2075. It is built at a height of 3717 ft. on the right bank of the Ubaye river, on which it is the most important place. It is situated in a wide and very fertile valley, and is surrounded by many villas, built by natives who have made their fortune in Mexico, and are locally known as *les Américains*. The town itself is mainly composed of a long street (flanked by two others), which is really the road from Grenoble to Cuneo over the Col de l'Argentière (6545 ft.). The only remarkable buildings in the town are a striking clock-tower of the 15th century (the remains of a Franciscan convent) and the Musée Chabrand, which contains a very complete collection of birds, both European and extra-European.

Refounded in 1231 by Raymond Bérenger IV., count of Provence (he was of the family of the counts of Barcelona, whence the name of the town he rebuilt), Barcelonnette passed to Savoy in 1388 (formal cession in 1419), and in 1713 by the treaty of Utrecht was ceded to France in exchange for the valleys of Exilles, Fénéstrelles, and Château Dauphin (Casteldefino). It was the birth-place of J. A. Manuel (1775-1827), the well-known Liberal orator at the time of the Restoration of 1815, after whom the principal square of the town is named.

See F. Arnaud, *Barcelonnette et ses environs* (Guide du C. A. F.) (1898), and *La Vallée de Barcelonnette* (1900). (W. A. B. C.)

BARCLAY, ALEXANDER (c. 1476-1552), British poet, was born about 1476. His nationality is matter of dispute, but William Bullen, who was a native of Ely, and probably knew him when he was in the monastery there, asserts that he was born "beyond the cold river of Tweed"; moreover, the spelling of his name and the occasional Scottish words in his vocabulary point to a northern origin. His early life was spent at Croydon, but it is not certain whether he was educated at Oxford or Cambridge. It may be presumed that he took his degree, as he uses the title of "Syr" in his translation of Sallust, and in his will he is called doctor of divinity. From the numerous incidental references in his works, and from his knowledge of European literature, it may be inferred that he spent some time abroad. Thomas Cornish, suffragan bishop in the diocese of Bath and Wells, and provost of Oriel College, Oxford, from 1493 to 1507, appointed him chaplain of the college of St Mary Ottery, Devonshire. Here he translated Sebastian Brant's *Ship of Fools*, and even introduced his neighbours into the satire:—

"For if one can flatter, and beare a Hauke on his fist,
He shall be parson of Honington or Cist."

The death of his patron in 1513 apparently put an end to his connexion with the west, and he became a monk in the Benedictine monastery of Ely. In this retreat he probably wrote his eclogues, but in 1520 "Maistre Barkeleye, the Blacke Monke and Poete" was desired to devise "histoires and convenient raisons to flourish the buildings and banquet house withal" at the meeting between Henry VIII. and Francis I. at the Field of the Cloth of Gold. He at length became a Franciscan monk

of Canterbury. It is presumed that he conformed with the change of religion, for he retained under Edward VI. the livings of Great Baddow, Essex, and of Wokey, Somerset, which he had received in 1546, and was presented in 1552 by the dean and chapter of Canterbury to the rectory of All Hallows, Lombard Street, London. He died shortly after this last preferment at Croydon, Surrey, where he was buried on the 10th of June 1552. All the evidence in Barclay's own work goes to prove that he was sincere in his reproof of contemporary follies and vice, and the gross accusations which John Bale¹ brings against his moral character may be put down to his hatred of Barclay's cloth.

The *Ship of Fools* was as popular in its English dress as it had been in Germany. It was the starting-point of a new satirical literature. In itself a product of the medieval conception of the fool who figured so largely in the Shrovetide and other pageants, it differs entirely from the general allegorical satires of the preceding centuries. The figures are no longer abstractions; they are concrete examples of the folly of the bibliophile who collects books but learns nothing from them, of the evil judge who takes bribes to favour the guilty, of the old fool whom time merely strengthens in his folly, of those who are eager to follow the fashions, of the priests who spend their time in church telling "gestes" of Robin Hood and so forth. The spirit of the book reflects the general transition between allegory and narrative, morality and drama. The *Narrenschiff* of Sebastian Brant was essentially German in conception and treatment, but his hundred and thirteen types of fools possessed, nevertheless, universal interest. It was in reality sins and vices, however, rather than follies that came under his censure, and this didactic temper was reflected in Barclay. The book appeared in 1494 with woodcuts said to have been devised and perhaps partly executed by Brant himself. In these illustrations, which gave an impulse to the production of "emblems" and were copied in the English version, there appears a humour quite absent from the text. In the Latin elegiacs of the *Stultifera Navis* (1497) of Jacob Locher the book was read throughout Europe. Barclay's *The Ship of Fools of the Worlde* was first printed by Richard Pynson in 1500. He says he translated "oute of Latyn, Frenche, and Doche," but he seems to have been most familiar with the Latin version. He used a good deal of freedom in his translation, "sometye addyng, sometye detracting and takinge awaye suche thynges as semeth me necessary and superflue." The fools are given a local colour, and Barclay appears as the unsparring satirist of the social evils of his time. At the end of nearly every section he adds an *emoi* of his own to drive home the moral more surely. The poem is written in the ordinary Chaucerian stanza, and in language which is more modern than the common literary English of his day.

Certaine Ecloges of Alexander Barclay, Priest, written in his youth, were probably printed as early as 1513, although the earliest extant edition is that in John Cawood's reprint (1570) of the *Ship of Fools*. They form, with the exception of Henryson's *Robin and Makyn*, the earliest examples of the English pastoral. The first three eclogues, in the form of dialogues between Coridon and Cornix, were borrowed from the *Miseriae Curioium* of Aeneas Sylvius Piccolomini (Pope Pius II.), and contain an eulogy of John Alcock, bishop of Ely, the founder of Jesus College, Cambridge. The fourth is based on Mantuan's eclogue, *De consuetudine divitum erga pauperes*, with large additions. It contains the "Description of the towre of Virtue and Honour," an elegy on Sir Edward Howard, lord high admiral of England, who perished in the attack on the French fleet in the harbour of Brest in 1513. The fifth, printed by Wynkyn de Worde, also without date, is entitled the "Fyfte Eglög of Alexandre Barclay of the Cytezen and the unplondyshman" and is also based on Mantuan. Two shepherds, Amintas and Faustus, discuss the familiar theme of the respective merits of town and ad country life, and relate a quaint fable of the origin of the different classes of society. Barclay's pastorals contain many pictures of rustic life as he knew it. He describes for instance the Sunday games in the village, football, and the struggle for food at great feasts;

¹ *Script. Ill. Maj. Brit.* (1557. Cent. ix. No. 66).

but his eclogues were, like his Italian models, also satires on social evils. The shepherds are rustics of the Colin Clout type, and discuss the follies and corruptions around them. Barclay had, however, no sympathy with the anti-clerical diatribes of John Skelton, whom he more than once attacks. Bale mentions an *Anti-Skeltonum* which is lost. His other works are:—*The Castell of Labour* (Wynkyn de Worde, 1506), from the French of Pierre Gringoire; the *Introductory to write and to pronounce Freneche* (Robert Copland, 1521); *The Myrrour of Good Maners* (Richard Pynson, not dated), a translation of the *De quatuor virtutibus* of Dominicus Mancinus; *Cronycle compyled in Latyn* by the renowned Jallust (Richard Pynson, no date), a translation of the *Bellum Jugurthinum*; *The Lyfe of the glorious Martyr Saynt George* (R. Pynson, c. 1530). *The Lyfe of Saynte Thomas*, and *Haythons Cronycle*, both printed by Pynson, are also attributed to Barclay, but on very doubtful grounds.

See T. H. Jameson's edition of the *Ship of Fools* (Edinburgh, 1874), which contains an account of the author and a bibliography of his works; and J. W. Fairholt's edition of *The Cytizen and Uplondyshman* (Percy Soc. 1847), which includes large extracts from the other eclogues; also Zarncke's edition of Brant (Leipzig, 1854); and F.edor Krausatz: *Über das Verhältnis von Barclay's Ship of Fools zu den lateinischen, französischen und deutschen Quellen* (1894). A prose version of Locher's *Stultifera Navis*, by Henry Watson, was printed by Wynkyn de Worde in 1518.

BARCLAY, JOHN (1582–1621), Scottish satirist and Latin poet, was born, on the 28th of January 1582, at Pont-à-Mousson, where his father William Barclay held the chair of civil law. His mother was a Frenchwoman of good family. His early education was obtained at the Jesuit College. While there, at the age of nineteen, he wrote a commentary on the *Thebaid* of Statius. In 1603 he crossed with his father to London. Barclay had persistently maintained his Scottish nationality in his French surroundings, and probably found in James's accession an opportunity which he would not let slip. He did not remain long in England, where he is supposed to have published the first part of his *Satyricon*, for in 1605 when a second edition of that book appeared in Paris, he was there, having already spent some time in Angers, and being now the husband of a French girl, Louise Debonaire. He returned to London with his wife in 1606, and there published his *Sylvae*, a collection of Latin poems. In the following year the second part of the *Satyricon* appeared in Paris. Barclay remained on in London till 1616. In 1609 he edited the *De Potestate Papae*, an anti-papal treatise by his father, who had died in the preceding year, and in 1611 he issued an *Apologia* or "third part" of the *Satyricon*, in answer to the attacks of the Jesuits and others who were probably embittered by the tone of the earlier parts of the satire. A so-called "fourth part," with the title of *Icon Animorum*, appeared in 1614. James I. is said to have been attracted by his scholarship, but particulars of this, or of his life in London generally, are not available. In 1616 he went to Rome, for some reason unexplained, and there resided till his death on the 15th of August 1621. He appears to have been on better terms with the Church and notably with Bellarmine; for in 1617 he issued, from a press at Cologne, a *Parænesis ad Sectariorum*, an attack on the position of Protestantism. The literary effort of his closing years was his best-known work the *Argenis*, completed about a fortnight before his death, which has been said to have been hastened by poison. The romance was printed in Paris in the same year.

Barclay's contemporary reputation as a writer was of the highest; by his strict scholarship and graceful style he has deserved the praise of modern students. The *Satyricon*, a severe satire on the Jesuits, is modelled on Petronius and catches his lightness of touch, though it shows little or nothing of the tone of its model, or of the unhesitating severity and coarseness of the humanistic satire of Barclay's age. The *Argenis* is a long romance, with a monitory purpose on the dangers of political intrigue, probably suggested to him by his experiences of the league in France, and by the catholic plot in England after James's accession. The work has been praised by all parties; and it enjoyed for more than a century after his death a remarkable popularity. Most of the innumerable editions are supplied with a key to

the characters and names of the story. Thus Aneroëtus is Clement VIII; *Arx non eversa* is the Tower of London; Hippophilus and Radriobanes are the names of the king of Spain; Hyanisbe is Queen Elizabeth; Meriania, by an easy anagram, is Germany; Usinulca, by another, is Calvin. The book is of historical importance in the development of 17th century romance, including especially Fénelon's *Télémaque*. Ben Jonson appears, from an entry at Stationers' Hall on the 2nd of October 1623, to have intended to make a translation. Barclay's shorter poems, in two books, were printed in the *Delitiae Poetarum Scotorum* (Amsterdam, 1637, i. pp. 76–136). In the dedication, to Prince Charles of England, he refers to his earlier publication, the *Sylvae*.

The best account of Barclay is the preface by Jules Dukas in his bibliography of the *Satyricon* (Paris, 1889). This supersedes the life in Bayle's *Dictionary*, which had been the sole authority. A "fifth part" of the *Satyricon* appears in most of the editions, by Alethophilus (Claude Morisot). For the *Argenis*, see the dissertations by Léon Boucher (Paris, 1874), and Dupond (Paris, 1875). The *Icon Animorum* was Englished by Thomas May in 1631 (*The Mirror of Minded, or Barclay's Icon Animorum*). Barclay's works have never been collected.

BARCLAY, JOHN (1734–1798), Scottish divine, was born in Perthshire and died at Edinburgh. He graduated at St Andrews, and after being licensed became assistant to the parish minister of Errol in Perthshire. Owing to differences with the minister, he left in 1763 and was appointed assistant to Antony Dow of Fettercairn, Kincardine. In this parish he became very popular, but his opinions failed to give satisfaction to his presbytery. In 1772 he was rejected as successor to Dow, and was even refused by the presbytery the testimonials requisite in order to obtain another living. The refusal of the presbytery was sustained by the General Assembly, and Barclay thereupon left the Scottish church and founded congregations at Sauchyburn, Edinburgh and London. His followers were sometimes called Bereans, because they regulated their conduct by a diligent study of the Scriptures (Acts xvii. 11). They hold a modified form of Calvinism.

His works, which include many hymns and paraphrases of the psalms, and a book called *Without Faith, without God*, were edited by J. Thomson and D. Macmillan, with a memoir (1852).

BARCLAY, ROBERT (1648–1690), one of the most eminent writers belonging to the Society of Friends, or Quakers, was born in 1648 at Gordonstown in Morayshire. His father had served under Gustavus Adolphus, and pursued a somewhat tortuous course through the troubles of the civil war. Robert was sent to finish his education in Paris, and it appears he was at one time inclined to accept the Roman Catholic faith. In 1667, however, he followed the example of his father, and joined the recently-formed Society of Friends. In 1670 he married a Quaker lady, Christian Mollison of Aberdeen. He was an ardent theological student, a man of warm feelings and considerable mental powers, and he soon came prominently forward as the leading apologist of the new doctrine, winning his spurs in a controversy with one William Mitchell. The publication of fifteen *Theses Theologiae* (1676) led to a public discussion in Aberdeen, each side claiming a victory. The most prominent of the *Theses* was that bearing on immediate revelation, in which the superiority of this inner light to reason or scripture is sharply stated. His greatest work, *An Apology for the True Christian Divinity*, was published in Latin at Amsterdam in 1676, and was an elaborate statement of the grounds for holding certain fundamental positions laid down in the *Theses*. It was translated by its author into English in 1678, and is "one of the most impressive theological writings of the century." It breathes a large tolerance and is still perhaps the most important manifesto of the Quaker Society. Barclay experienced to some extent the persecutions inflicted on the new society, and was several times thrown into prison. He travelled extensively in Europe (once with Penn and George Fox), and had several interviews with Elizabeth, princess palatine. In later years he had much influence with James II., who as duke of York had given to twelve members of the society a patent of the province of East New Jersey, Barclay being made governor (1682–88). He is said to have visited James with a view to making terms of accommodation with William of Orange,

whose arrival was then imminent. He died on the 3rd of October 1690.

BARCLAY, WILLIAM (1346-1608) Scottish jurist, was born in Aberdeenshire in 1346. Educated at Aberdeen University, he went to France in 1573, and studied law under Cujas, at Bourges, where he took his doctor's degree. Charles III., duke of Lorraine, appointed him professor of civil law in the newly-founded university of Pont-à-Mousson, and also created him counsellor of state and master of requests. In 1603, however, he was obliged to quit France, having incurred the enmity of the Jesuits, through his opposition to their proposal to admit his son John (q.v.) a member of their society. Returning to England, he was offered considerable preferment by King James on condition of becoming a member of the Church of England. This offer he refused, and returned to France in 1604, when he was appointed professor of civil law in the university of Angers. He died at Angers in 1608. His principal works were *De Regno et Regali Potestate*, &c. (Paris, 1600), a strenuous defence of the rights of kings, in which he refutes the doctrines of George Buchanan, "Junius Brutus" (Hubert Languet) and Jean Boucher; and *De Potestate Papae*, &c. (London, 1600), in opposition to the usurpation of temporal powers by the pope, which called forth the celebrated reply of Cardinal Bellarmine; also commentaries on some of the titles of the Pandects.

BARCLAY DE TOLLY, MICHAEL ANDREAS, called by the Russians MICHAEL, PRINCE BODANOVICH (1761-1818), Russian field marshal, was born in Livonia in 1761. He was a descendant of a Scottish family which had settled in Russia in the 17th century. He entered the Russian army at an early age. In 1788-1789 he served against the Turks, in 1790 and 1794 against the Swedes and Poles. He became colonel in 1798 and major-general in 1799. In the war of 1806 against Napoleon, Barclay took a distinguished part in the battle of Pultusk and was wounded at Eylau, where his conduct won him promotion to the rank of lieutenant-general. In 1808 he commanded against the Swedes in Finland, and in 1809 by a rapid and daring march over the frozen Gulf of Bothnia he surprised and seized Umeo. In 1810 he was made minister of war, and he retained the post until 1813. In 1812 Barclay was given command of one of the armies operating against Napoleon. There was very keen opposition to the appointment of a foreigner as commander-in-chief, and after he was defeated at Smolensk the outcry was so great that he resigned his command and took a subordinate place under the veteran Kutusov. Barclay was present at Borodino, but left the army soon afterwards. In 1813 he was re-employed in the field and took part in the campaign in Germany. After the battle of Bautzen he was reinstated as commander-in-chief of the Russian forces, and in this capacity he served at Dresden, Kulm and Leipzig. After the last battle he was made a count. He took part in the invasion of France in 1814 and at Paris received the bâton of a field marshal. In 1815 he was again commander-in-chief of the Russian army which invaded France, and he was made a prince at the close of the war. He died at Insterburg in Prussia on the 14th (16th) of May 1818.

BARCOCHEBAS, BAR-COCHAB, or BAR KOKBA ("son of a star"), the name given in Christian sources to one Simeon, the leader in the Jewish revolt against Rome in the time of Hadrian (A.D. 132-135). The name does not appear in the Roman historians. In Rabbinic sources he is called Bar (Ben) Coziba, "son of deceit," which perhaps reflects the later verdict of condemnation recorded after his failure (root כזב "to be false"). Cochab is, therefore, the name either of his father or of his home. But it is recorded that the Rabbi 'Aqiba (q.v.), who recognized him as Messiah, applied Num. xxiv. 17 to him, reading not *Cochab* ("a star"), but *Cosiba* ("goes forth from Jacob"); thus Bar-cochab is a Messianic title of the "man of Coziba" (cf. Chron. iv. 22) whose original name was recalled by later Rabbis with sinister intention. At first the Romans paid little attention to the insurgents, who were able to strike coins in the name of Simeon, prince of Israel, and Eleazar the priest, and to persecute the Christians, who refused to join the revolt. But troops were collected and the various fortresses occupied by the

Jews were successively reduced. The end came with the fall of Beth-thar (Bethar). Extraordinary stories were told of the prowess of Barcochebas and of the ordeals to which he subjected his soldiers in the way of training.

See Eusebius *H.E.* iv. 6; Dio Cassius xix. 12-14; Schürer, *Gesch. d. jüd. Volkes*, 3rd ed. i. 682 ff.; Derenbourg, *Hist. de la Palest.* 423 ff. (distinguishes Barcochebas from Simeon); Schlatter, *Gesch. Israels*, 2nd ed. 303 ff.; articles **JEW** and **PALESTINE, History**; also *s.v.* "Bar Kokba" in *Jewish Encyc.* (S. Krauss).

BARD, a word of Celtic derivation (Gaelic *baird*, Cymric *bardh*, Irish *bard*) applied to the ancient Celtic poets, though the name is sometimes loosely used as synonymous with poet in general. So far as can be ascertained, the title *bards*, and some of the privileges peculiar to that class of poets, are to be found only among Celtic peoples. The name itself is not used by Caesar in his account of the manners and customs of Gaul and Britain, but he appears to ascribe the functions of the bards to a section of the Druids, with which class they seem to have been closely connected. Later Latin authors, such as Lucan (*Phar.* p. 447), Festus (*De Verb. Sign.* s.v.), and Ammianus Marcellinus (bk. xv.), used the term *Bardi* as the recognized title of the national poets or minstrels among the peoples of Gaul and Britain. In Gaul, however, the institution soon disappeared; the purely Celtic peoples were swept back by the waves of Latin and Teutonic conquest, and finally settled in Wales, Ireland, Brittany and the north of Scotland. There is clear evidence of the existence of bards in all these places, though the known relics belong almost entirely to Wales and Ireland, where the institution was more distinctively national. In Wales they formed an organized society, with hereditary rights and privileges. They were treated with the utmost respect and were exempt from taxes or military service. Their special duties were to celebrate the victories of their people and to sing hymns of praise to God. They thus gave poetic expression to the religious and national sentiments of the people, and therefore exercised a very powerful influence. The whole society of bards was regulated by laws, said to have been first distinctly formulated by Hywel Dha, and to have been afterwards revised by Gruffydd ap Conan. At stated intervals great festivals were held, at which the most famous bards from the various districts met and contended in song, the umpires being generally the princes and nobles. Even after the conquest of Wales, these congresses, or *Eisteddfodau*, as they were called (from the Welsh *eistedd*, to sit), continued to be summoned by royal commission, but from the reign of Elizabeth the custom has been allowed to fall into abeyance. They have not been since summoned by royal authority, but were revived about 1822, and are held regularly at the present time. In modern Welsh, a bard is a poet whose vocation has been recognized at an Eisteddfod. In Ireland also the bards were a distinct class with peculiar and hereditary privileges. They appear to have been divided into three great sections: the first celebrated victories and sang hymns of praise; the second chanted the laws of the nation; the third gave poetic genealogies and family histories. The Irish bards were held in high repute, and frequently were brought over to Wales to give instruction to the singers of that country.

In consequence, perhaps, of Lucan's having spoken of *carmina bardi*, the word *bard* began to be used, early in the 17th century, to designate any kind of a serious poet, whether lyric or epic, and is so employed by Shakespeare, Milton and Pope. On the other hand, in Lowland Scots it grew to be a term of contempt and reproach, as describing a class of frenzied vagabonds.

See Ed. Jones, *Relics of the Welsh Bards* (1784); Walker, *Memoirs of the Irish Bards* (1786); Owen Jones, *Mycranean Archaeology of Wales* (3 vols., 1801-1807); W. F. Skene, *Four Ancient Books of Wales* (2 vols., 1868).

BARDAIŠAN, an early teacher of Christianity in Mesopotamia, the writer of numerous Syriac works which have entirely perished (with one possible exception, the *Hymn of the Soul* in the *Acts of Thomas*), and the founder of a school which was soon branded as heretical. According to the trustworthy *Chronicle of Edessa*, he was born in that city on the 11th Tammuz (July), A.D. 154.

¹ The *Book of the Laws of the Countries*, referred to below, is the work of a disciple of Bardaišan.

His parents were of rank and probably pagan; according to Barhebraeus, he was in youth a priest in a heathen temple at Mabbog. Another probable tradition asserts that he shared the education of a royal prince who afterwards became king of Edessa—perhaps Abgar bar Manu, who reigned 202-217. He is said to have converted the prince to Christianity, and may have had an important share in christianizing the city. Epiphanius and Barhebraeus assert that he was first an orthodox Christian and afterwards an adherent of Valentinus; but Eusebius and the Armenian Moses of Chorene reverse the order, stating that in his later days he largely, but not completely, purged himself of his earlier errors. The earliest works attributed to him (by Eusebius and others) are polemical dialogues against Marcionism and other heresies; these were afterwards translated into Greek. He also wrote, probably under Caracalla, an apology for the Christian religion in a time of persecution. But his greatest title to fame was furnished by his hymns, which, according to St Ephrem, numbered 150 and were composed in imitation of the Davidic psalter. He thus became the father of Syriac hymnology, and from the favour enjoyed by his poems during the century and a half that intervened between him and St Ephrem we may conclude that he possessed original poetic genius. This would be clearly proved if (as is not unlikely) the beautiful *Hymn of the Soul* incorporated in the apocryphal *Acts of Thomas* could be regarded as proceeding from his pen; it is practically the only piece of real poetry in Syriac that has come down to us. Perhaps owing to the persecution under Caracalla mentioned above, Bardaisan for a time retreated into Armenia, and is said to have there preached Christianity with indifferent success, and also to have composed a history of the Armenian kings. Porphyry states that on one occasion at Edessa he interviewed an Indian deputation who had been sent to the Roman emperor, and questioned them as to the nature of Indian religion. He was undoubtedly a man of wide culture. He died (according to the patriarch Michael) in 222.

For our knowledge of Bardaisan's doctrine we are mainly dependent on the hostile witness of St Ephrem, and on statements by Greek writers who had no acquaintance with his works in their original form. His teaching had certain affinities with gnosticism. Thus he certainly denied the resurrection of the body; and so far as we can judge by the obscure quotations from his hymns furnished by St Ephrem he explained the origin of the world by a process of emanation from the supreme God whom he called "the Father of the living." On the other hand the dialogue known as the *Book of the Laws of the Countries*, which was written by a disciple and is quoted by Eusebius as a genuine exposition of the master's teaching—while it recognizes the influence of the celestial bodies over the body of man and throughout the material sphere and attributes to them a certain delegated authority—upholds the freedom of the human will and can in the main be reconciled with orthodox Christian teaching. On this M. Nau has based his effort (see *Une Biographie inédite de Bardesane l'astrologue*, Paris, 1897; *Le Livre des lois des pays*, Paris, 1899) to clear Bardaisan of the reproach of gnosticism, maintaining that the charge of heresy arises from a misunderstanding of certain astrological speculations. It must be admitted that it is impossible to reconstruct Bardaisan's system from the few fragments remaining of his own work and therefore a certain verdict cannot be given. But the ancient testimony to the connexion of Bardaisan with Valentinianism is strong, and the dialogue probably represents a modification of Bardesane's teaching in the direction of orthodoxy. The later adherents of the school appear to have moved towards a Manichean dualism.

The subject is exhaustively discussed in Hort's article "Bardaisan" in *Dict. Christ. Biog.*, and a full collection of the ancient testimonies will be found in Harnack's *Altchristliche Literatur*, vol. i. pp. 184 ff. (N. M.)

BARDILI, CHRISTOPH GOTTFRIED (1761-1808), German philosopher, was born at Blaubeuren in Württemberg, and died

¹ Even Ephrem allows that Bardaisan was in principle a monotheist.

at Stuttgart. His system has had little influence in Germany; Reinhold (*q.v.*) alone expounded it against the attacks of Fichte and Schelling. Yet in some respects his ideas opened the way for the later speculations of Schelling and Hegel. He dissented strongly from the Kantian distinction between matter and form of thought, and urged that philosophy should consider only thought in itself, pure thought, the ground or possibility of being. The fundamental principle of thought is, according to him, the law of identity; logical thinking is real thinking. The matter upon which thought operated is in itself indefinite and is rendered definite through the action of thought. Bardili worked out his idea in a one-sided manner. He held that thought has in itself no power of development, and ultimately reduced it to arithmetical computation. He published *Grundriss der ersten Logik* (Stuttgart, 1800); *Über die Gesetze der Ideen-association* (Tübingen, 1796); *Briefe über den Ursprung der Metaphysik* (Altona, 1798); *Philos. Elementarlehre* (Landshut, 1802-1806); *Beiträge zur Beurteilung des gegenwärtigen Zustandes der Vernunftlehre* (Landshut, 1803).

See C. L. Michelet, *Geschichte der letzten Systeme*; J. E. Erdmann, *Versuch einer Geschichte d. neu. Phil.* Bd. iii. pt. i.; B's and Reinhold's Briefwechsel.

BARDOUX, AGÉNOR (1829-1897), French statesman, was a native of Bourges. Established as an advocate at Clermont, he did not hesitate to proclaim his republican sympathies. In 1871 he was elected deputy of the National Assembly, and re-elected in 1876 and in 1877. In the chamber he was president of the group of the left centre, standing strongly for the republic but against anti-clericalism. After the *coup d'état* of the 16th of May, he was one of the leaders of the "363." In the republican chamber elected after the 16th of May, he became minister of public instruction (December 1877), and proposed various republican laws, notably on compulsory primary education. He resigned in 1879. He was not re-elected in 1881, but in December 1882 was named senator for life. He wrote essays on *Les Légistes et leur influence sur la société française* (1878); *Le Comte de Montlosier et le Gallicanisme* (1881); and published in 1882 his *Dix Années de vie politique*.

BARDOWIEK, a village of Germany, in the Prussian province of Hanover, 3 m. N. of Lüneburg on the navigable Ilmenau. Pop. 2000. Its trade consists entirely in agricultural produce. The Gothic parish church (c. 1400) incorporates remains of a cathedral of vast dimensions.

Bardowiek was founded in the 8th century by Charlemagne, who established a bishopric in it, and until its destruction by Henry the Lion in 1189, it was the most prosperous commercial city of north Germany. Its name is derived from the Longobardi, the tribe for whom it was the home and centre, and from it the colonization of Lombardy started.

BARDSEY (*i.e.* "Bards' Island": cf. Anglesey, "Angles' Island"; Welsh, *Ynys Enlli*, "isle of the current"), an island at the northern extremity of Cardigan Bay. The "sound" between Aberdaron point and the island is some 4 m. wide. Bardsey is included in Carmarvonshire, North Wales (but traditionally in S. Wales). On the N.W. side it has high cliffs. It is about $\frac{1}{2}$ m. long by $\frac{1}{2}$ m. broad, with an area of some 370 acres, a third of which is hilly. Barley and oats are grown. On the S.E. side is a fairly deep harbour. On the N.E. are the ruins of the tower of St Mary's abbey (13th century). There is no Anglican church, the inhabitants being Dissenters. They are farmers and fishermen. The lighthouse, with fixed light, 140 ft. high and visible for 17 m., is locally celebrated. The rectory of Aberdaron (on the mainland, opposite Bardsey), Penmachno and Llangwnadl (Llangwynhoedl), in Llyn (S. Carmarvonshire), belong to St John's College, Cambridge. St Dubricius made the sanctuary famous, and died here in 612. Here was the burial-place of all the monks whose friends could afford to go thither with their bodies. All the great abbeyes of England sent their quota. Roads to Bardsey—with the monks' wells, found at intervals of 7 to 9 m.—run from north, east and south. The remnant of priests fled thither (after the great massacre of Bangor-is-coed in 613; by Ethelfrith of Northumbria) by the road of the Rivals (*Yn Eijff*)

hill, S. Carnarvonshire, on which Pistyll farm still gives food gratis to all pilgrims or travellers. A part of the isle is one great cemetery of about 3 to 4 acres, with rude, rough graves as close to each other as possible, with slabs upon them. Though Aberdaron rectory does not belong to the isle, the farm "Cwrt" (Court), where the abbot held his court, still goes with Bardsey, which was granted to John Wynn of Bodvel, Carnarvonshire, after the battle and partial sack of Norwich by the Puritans in the Civil War; passing through Mary Bodvel to her husband, the earl of Radnor, who sold it to Dr Wilson of York. The doctor, in turn, sold it to Sir John Wynn, of Glynllifon and Bodfean Hall, Carnarvonshire. One of the Wynns, the 3rd Baron Newborough, was, at his wish, buried here. The archaeology and history of the isle are voluminous. Lady Guest's *Mabinogion* translation (i. p. 115, ed. of 1838) gives an account of the (legendary) Bardsey House of Glass, into which Merlin (Myrddin) took a magic ring, originally kept at Caerleon-on-Usk.

BARÈGES, a town of south-western France, in the department of Hautes-Pyrénées, in the valley of the Bastan, 25 m. S.S.W. of Bagnères-de-Bigorre by road. The town, which is situated at an altitude of 4040 ft., is hardly inhabited in the winter. It is celebrated for its warm sulphurous springs (75° to 111° F.), which first became generally known in 1675 when they were visited by Madame de Maintenon and the duke of Maine, son of Louis XIV. The waters, which are used for drinking and in baths, are efficacious in the treatment of wounds and ulcers and in cases of scrofula, gout, skin diseases, &c. There is a military hospital, founded in 1760. The town was formerly much exposed to avalanches and floods, which are now less frequent owing to the construction of embankments and replanting of the hillsides. It is a centre for mountain excursions. The light silk and wool fabric called *barège* takes its name from the place, where it was first made.

BARREILLY, or **BARRELLY**, a city and district of British India in the Bareilly or Rohilkhand division of the United Provinces. The city is situated on the Ramganga river, 812 m. N.W. from Calcutta by rail. Pop. (1901) 137,208. The principal buildings are two mosques built in the 17th century; a modern fort overlooking the cantonments; the railway station, which is an important junction on the Oudh and Rohilkhand line; the palace of the nabab of Rampur, and the government college. Bareilly is the headquarters of a brigade in the 7th division of the eastern army corps. The chief manufactures are furniture and upholstery. Bareilly college is a seat of upper class learning for the surrounding districts. It is conducted by an English staff, and its course includes the subjects for degrees in the Calcutta University.

The district of Bareilly has an area of 1580 sq. m. It is a level country, watered by many streams, the general slope being towards the south. The soil is fertile and highly cultivated, groves of noble trees abound, and the villages have a neat, prosperous look. A tract of forest jungle, called the *lari*, stretches along the extreme north of the district, and teems with large game, such as tigers, bears, deer, wild pigs, &c. The river Sarda or Gogra forms the eastern boundary of the district and is the principal stream. Next in importance is the Ramganga, which receives as its tributaries most of the hill torrents of the Kumaon mountains. The Deoha is another great drainage artery and receives many minor streams. The Gomati or Gumti also passes through the district. The population in 1901 was 1,090,117. The Mahomedans are chiefly the descendants of Yusufzai Afghans, called the Rohilla Pathans, who settled in the country about the year 1720. The Rohillas were formerly the ruling race of the tract of country called Rohilkhand, and are men of a taller stature, a fairer complexion and a more arrogant air than the general inhabitants of the district. Bishop Heber described them as follows:—"The country is burdened with a crowd of lazy, profligate, self-called sawars (cavaliers), who, though many of them are not worth a rupee, conceive it derogatory to their gentility and Pathan blood to apply themselves to any honest industry, and obtain for the most part a precarious livelihood by sponging on the industrious tradesmen and farmers,

on whom they levy a sort of blackmail, or as hangers-on to the wealthy and noble families yet remaining in the province. These men have no visible means of maintenance, and no visible occupation except that of lounging up and down with their swords and shields, like the ancient Highlanders, whom in many respects they much resemble." The Rohillas, after fifty years' precarious independence, were subjugated in 1774 by the confederacy of British troops with the nabab of Oudh's army, which formed so serious a charge against Warren Hastings. Their territory was in that year annexed to Oudh. In 1801 the nabab of Oudh ceded it to the Company in commutation of the subsidy money. During the Mutiny of 1857 the Rohillas took a very active part against the English, but since then they have been disarmed. Both before and after that year, however, the Bareilly Mahomedans have distinguished themselves by fanatical tumults against the Hindus. The district is irrigated from the Rohilkhand system of government canals. There are no manufactures except for domestic use and little external trade. Several lines of the Oudh and Rohilkhand railway pass through the district.

BARRENTON, a town of northern France, in the department of Seine-Inférieure, 11 m. N.N.W. of Rouen by rail. Pop. (1906) 5245. The town is situated in the valley of the Austreberthe, a small affluent of the Seine, here crossed at a height of 100 ft. by a fine railway viaduct 540 yds. long. The manufacture of cotton fabrics is the principal industry.

BARRENTS, WILLEM (d. 1597), Dutch navigator, was born about the middle of the 16th century. In 1594 he left Amsterdam with two ships to search for a north-east passage to eastern Asia. He reached the west coast of Novaya Zemlya, and followed it northward, being finally forced to turn back when near its northern extremity. In the following year he commanded another expedition of seven ships, which made for the strait between the Asiatic coast and Vaygach Island, but was too late to find open water; while his third journey equally failed of its object and resulted in his death. On this occasion he had two ships, and on the outward journey sighted Bear Island and Spitsbergen, where the ships separated. Barrents' vessel, after rounding the north of Novaya Zemlya, was beset by ice and he was compelled to winter in the north; and as his ship was not released early in 1597, his party left her in two open boats on the 13th of June and most of its members escaped. Barrents himself, however, died on the 30th of June 1597. In 1871 the house in which he wintered was discovered, with many relics, which are preserved at the Hague, and in 1875 part of his journal was found.

See *The Three Voyages of Barrents*, by Gerrit de Veer, translated by the Hakluyt Society (1876) from de Veer's text (Amsterdam, 1598).

BARRENTS SEA, that part of the Arctic Ocean which is demarcated by the north coast of Europe, the islands of Novaya Zemlya, Franz Josef Land and Spitsbergen, and smaller intervening islands; it was named after the Dutch navigator. Omitting the great inlet of the White Sea in the south, it extends from about 67° to 80° N., and from 20° to 60° E. The southern part, off the Murman coast of the Kola peninsula, is sometimes called the Murman Sea.

BARÈRE DE VIEUZAC, BERTRAND (1755-1841), one of the most notorious members of the French National Convention, was born at Tarbes in Gascony on the 10th of September 1755. The name of Barère de Vieuzac, by which he continued to call himself long after the renunciation of feudal rights on the famous 4th of August, was assumed from a small fief belonging to his father, a lawyer at Vieuzac. He began to practise as an advocate at the parlement of Toulouse in 1770, and soon earned a considerable reputation as an orator; while his brilliant and flowing style as a writer of essays led to his election as a member of the Academy of Floral Games of Toulouse in 1788. At the age of thirty he married. Four years later, in 1789, he was elected deputy by the estates of Bigorre to the states-general, which met in May. He had made his first visit to Paris in the preceding year. His personal appearance, his manners, social qualities and liberal opinions, gave him a good standing among the multitude of provincial deputies then thronging into Paris. He

attached himself at first to the constitutional party; but he was less known as a speaker in the Assembly than as a journalist. His paper, however, the *Point du Jour*, according to Aulard, owes its reputation not so much to its own qualities as to the fact that the painter David, in his famous picture of the "Oath in the Tennis Court," has represented Barère kneeling in the corner and writing a report of the proceedings as though for posterity. The reports of the debates of the National Assembly in the *Point du Jour*, though not inaccurate, are as a matter of fact very incomplete and very dry. After the flight of the king to Varennes, Barère passed over to the republican party, though he continued to keep in touch with the duke of Orleans, to whose natural daughter, Paméla, he was tutor. Barère, however, appears to have been wholly free from any guiding principle; conscience he had none, and his conduct was regulated only by the determination to be on the side of the strongest. After the close of the National Assembly he was nominated one of the judges of the newly instituted court of cassation from October 1791 to September 1792. In 1792 he was elected deputy to the National Convention for the department of the Hautes-Pyrénées. At first he voted with the Girondists, attacked Robespierre, "a pygmy who should not be set on a pedestal," and at the trial of the king voted with the Mountain for the king's death "without appeal and without delay." He closed his speech with a sentence which became memorable: "the tree of liberty could not grow were it not watered with the blood of kings." Appointed member of the Committee of Public Safety on the 7th of April 1793, he busied himself with foreign affairs; then, joining the party of Robespierre, whose resentment he had averted by timely flatteries, he played an important part in the second Committee of Public Safety—after the 17th of July 1793—and voted for the death of the Girondists. He was thoroughly unscrupulous, stopping at nothing to maintain the supremacy of the Mountain, and rendered it great service by his rapid work, by the telling phases of his oratory, and by his clear expositions of the problems of the day. On the 9th Thermidor (July 27th, 1794) Barère hesitated, then he drew up the report outlawing Robespierre. In spite of this, in Germinal of the year III. (the 21st of March to the 4th of April 1795), the Thermidorians decreed the accusation of Barère and his colleagues of the Terror, Collot d'Herbois and Billaud-Varenne, and he was sent to the Isle of Oléron. He was removed to Saintes, and thence escaped to Bordeaux, where he lived in concealment for several years. In 1795 he was elected member of the Council of Five Hundred, but was not allowed to take his seat. Later he was used as a secret agent by Napoleon I., for whom he carried on a diplomatic correspondence. On the fall of Napoleon, Barère played the part of royalist, but on the final restoration of the Bourbons in 1815 he was banished for life from France as a regicide, and then withdrew to Brussels and temporary oblivion. After the revolution of July 1830 he reappeared in France, was reduced by a series of lawsuits to extreme indigence, accepted a small pension assigned him by Louis Philippe (on whom he had heaped abuse and railing), and died, the last survivor of the Committee of Public Safety, on the 13th of January 1841. (See also FRENCH REVOLUTION.)

The Mémoires de B. Barère . . . publiés par M.M. H. Carnot . . . et David (d'Angers) . . . précédés d'une notice historique (Paris, 1824-1844) are false, but contain valuable information; Carnot's *Notice*, which is very good, was published separately in 1842. See F. A. Aulard, *Les Orateurs de la Constituante* (Paris, 1882); *Les Orateurs de la Convention* (2nd ed., Paris, 1905). Macaulay's essay on Barère, (*Edinburgh Review*, vol. 79) is eloquent, but incorrect.

BARETTI, GIUSEPPE MARC' ANTONIO (1710-1780), Italian critic, was born at Turin in 1710. He was intended by his father for the profession of law, but at the age of sixteen fled from Turin and went to Guastalla, where he was for some time employed in a mercantile house. His leisure hours he devoted to literature and criticism, in which he became expert. For many years he led a wandering life, supporting himself chiefly by his writings. At length he arrived in London, where he remained for a considerable time. He obtained an appointment as secretary to the Royal Academy of Painting, and became acquainted with

Johnson, Garrick and others of that society. He was a frequent visitor at the Thrales'; and his name occurs repeatedly in Boswell's *Life*. In 1760 he was tried for murder, having had the misfortune to inflict a mortal wound with his fruit knife on a man who had assaulted him on the street. Johnson among others gave evidence in his favour at the trial, which resulted in Baretti's acquittal. He died in May 1780. His first work of any importance was the *Italian Library* (London, 1757), a useful catalogue of the lives and works of many Italian authors. The *Lettere famigliari*, giving an account of his travels through Spain, Portugal and France during the years 1761-1765, were well received, and when afterwards published in English (4 vols., 1770), were highly commended by Johnson. While in Italy on his travels Baretti set on foot a journal of literary criticism, to which he gave the title of *Frusta letteraria*, the literary scourge. It was published under considerable difficulties and was soon discontinued. The criticisms on contemporary writers were sometimes just, but are frequently disfigured by undue vehemence and coarseness. Among his other numerous works may be mentioned a useful *Dictionary and Grammar of the Italian Language*, and a dissertation on Shakespeare and Voltaire. His collected works were published at Milan in 1838.

BARFLEUR, a small seaport of north-western France, overlooking the Bay of the Seine, in the department of Manche, 22½ m. N.N.E. of Valognes by rail. Pop. (1906) 1069. In the middle ages Barfleure was one of the chief ports of embarkation for England. In 1120 the "White Ship," carrying Prince William, only son of Henry I., went down outside the harbour. About 2 m. to the north is Cape Barfleure, with a lighthouse 233 ft. high.

BARFURUSH, a town of Persia, in the province of Mazandaran in 36° 32' N., and 52° 42' E., and on the left bank of the river Bawul [Babul], which is here crossed by a bridge of eight arches, about 15 m. distant from the southern shore of the Caspian Sea, where the small town of Meshed i Sar serves as a port. It is the commercial capital of Mazandaran, and 26 m. distant from Sari and 90 m. from Teheran. Pop. about 50,000. Built in a low and swampy country and approached by deep and almost impassable roads, Barfurush would not seem at all favourably situated for the seat of an extensive inland trade; it is, however, peopled entirely by merchants and tradesmen, and is wholly indebted for its present size and importance to its commercial prosperity. The principal articles of its trade are rice and cotton, some sugar cane (*naï shakar*), flax (*Kalān*) and hemp (*Kanab*) are also grown. The town is of peculiar structure and aspect, being placed in the midst of a forest of tall trees, by which the buildings are so separated from one another, and so concealed, that, except in the bazars, it has no appearance of a populous town. The streets are broad and neat, though generally unpaved, and kept in good order. No ruins are to be seen as in other Persian towns; the houses are comfortable, in good repair, roofed with tiles and enclosed by substantial walls. There are no public buildings of any importance, and the only places of interest are the bazars, which extend fully a mile in length, and consist of substantially built ranges of shops covered with roofs of wood and tiles, and well stored with commodities. There are about ten commodious caravanserais and a number of colleges (*medresseh*), the place being as much celebrated for learning as for commerce. On an island in a small lake east of the town is a garden, called Bagh i Shah (garden of the Shah), with ruined palaces and baths. At Meshed i Sar, the port, or roadstead of Barfurush, the steamers of the Caucasus and Mercury Company call weekly, and a brisk shipping trade is carried on between it and other Caspian ports.

Barfurush was formerly called Māmātir. The present name is from a settlement called Barfurush-deh, which was added to the old city A.D. 1012. (A. H.-S.)

BARGAIN' AND SALE, in English law, a contract whereby property, real or personal, is transferred from one person—called the bargainer—to another—called the bargainee—for a

¹ From O. Fr. *baragioine*, a word of doubtful origin, appearing in many Romance languages, cf. Ital. *baraggio*; it is connected with Late Lat. *barcantiare*, to traffic, possibly derived from *barca*, a barge.

valuable consideration; but the term is more particularly used to describe a mode of conveyance of lands. The disabilities under which a feudal owner very frequently lay gave rise to the practice of conveying land by other methods than that of feoffment with livery of seisin, that is, a handing over of the feudal possession. That of "bargain and sale" was one. Where a man bargained and sold his land to another for pecuniary consideration, which might be merely nominal, and need not necessarily be actually paid, equity held the bargainer to be seised of the land to the use of the bargainee. The Statute of Uses (1535), by converting the bargainee's interest into a legal estate, had an effect contrary to the intention of its framers. It made bargain and sale an easy means of secret or private conveyance, a policy to which the law was opposed. To remedy this defect, a statute (called the Statute of Enrolments) was passed in the same year, which provided that every conveyance by bargain and sale of freehold lands should be enrolled in a court of record or with the *custos rotulorum* of the county within six months of its date. The Statute of Enrolments applied only to estates of inheritance or for life, so that a bargain and sale of an estate for years might be made without enrolment. This in turn was the foundation of another mode of conveyance, namely, lease and release, which took the place of the deed of bargain and sale, so far as regards freehold. Bargain and sale of copyhold estates, which operates at common law, is still a mode of conveyance in England in the case of a sale by executors, where a testator has directed a sale of his estate to be made, instead of devising it to trustees upon trust to sell.

See also CONVEYANCING.

BARGE (Med. Lat. *barca*, possibly connected with Lat. *baris*, Gr. *βάρης*, a boat used on the Nile), formerly a small sailing vessel, but now generally a flat-bottomed boat used for carrying goods on inland navigations. On canals barges are usually towed, but are sometimes fitted with some kind of engine; the men in charge of them are known as bargees. On tidal rivers barges are often provided with masts and sails ("sailing barges"), or in default of being towed, they drift with the current, guided by a long oar or oars ("dumb-barges"). Barges used for unloading, or loading, the cargo of ships in harbours are sometimes called "lighters" (from the verb "to light" = to relieve of a load). A state barge was a heavy, often highly ornamented vessel used for carrying passengers on occasions of state ceremonies. The college barge at Oxford are houseboats moored in the river for the use of members of the college rowing clubs. In New England the word barge frequently means a vehicle, usually covered, with seats down the side, used for picnic parties or the conveyance of passengers to or from piers or railway stations.

BARGEBOARD (probably from Med. Lat. *burgus*, or *barcus*, a scaffold, and not from the now obsolete synonym "vergeboard"), the boards fastened to the projecting gables of a roof to give strength to the same and to mask or hide the horizontal timbers of the roof to which they were attached. Bargeboards are sometimes moulded only or carved, but as a rule the lower edges were cusped and had tracery in the spandrels besides being otherwise elaborated. The richest example is one at Ockwells in Berkshire, England, which is moulded and carved as if it were intended for internal work.

BARGHEST, **BARGUEST** or **BARGEST**, the name given in the north of England, especially in Yorkshire, to a monstrous goblin-dog with huge teeth and claws. The spectre-hound under various names is familiar in folk-lore. The Demon of Tedworth, the Black Dog of Winchester and the Padfoot of Wakefield all shared the characteristics of the Barghest of York. In Wales its counterpart was Gwyllgi, "the Dog of Darkness," a frightful apparition of a mastiff with baleful breath and blazing red eyes. In Lancashire the spectre-hound is called Trash or Striker. In Cambridge-shire and on the Norfolk coast it is known as Shuck or Shock. In the Isle of Man it is styled Mauthe Doog. It is mentioned by Sir Walter Scott in "The Lay of the Last Minstrel"—

"For he was speechless, ghastly, wan
Like him of whom the story ran
Who spoke the spectre hound in Man."

A Welsh variant is the *Cwn Annwn*, or "dogs of hell." The barghest was essentially a nocturnal spectre, and its appearance was regarded as a portent of death. Its Welsh form is confined to the sea-coast parishes, and on the Norfolk coast the creature is supposed to be amphibious, coming out of the sea by night and travelling about the lonely lanes. The derivation of the word barghest is disputed. "Ghost" in the north of England is pronounced "guest," and the name is thought to be *burk-ghost*, "town-ghost." Others explain it as German *Berg-geist*, "mountain demon," or *Bar-geist*, "bear-demon," in allusion to its alleged appearance at times as a bear. The barghest has a kinsman in the *Rongeur d'Os* of Norman folklore. A belief in the spectre-hound still lingers in the wild parts of the north country of England, and in Nidderdale, Yorkshire, nurses frighten children with its name.

See Wirt Sikes, *British Goblins* (1880); *Notes and Queries*, first series, ii. 51; Joseph Ritson, *Fairy Tales* (London, 1831), p. 58; *Lancashire Folklore* (1867); Joseph Lucas, *Studies in Nidderdale* (Pateley Bridge, 1882).

BARHAM, RICHARD HARRIS (1788-1845), English humourist, better known by his *nom de plume* of THOMAS INGOLDSBY, was born at Canterbury on the 6th of December 1788. At seven years of age he lost his father, who left him a small estate, part of which was the manor of Tappington, so frequently mentioned in the *Legends*. At nine he was sent to St Paul's school, but his studies were interrupted by an accident which shattered his arm and partially crippled it for life. Thus deprived of the power of bodily activity, he became a great reader and diligent student. In 1807 he entered Brasenose College, Oxford, intending at first to study for the profession of the law. Circumstances, however, induced him to change his mind and to enter the church. In 1813 he was ordained and took a country curacy; he married in the following year, and in 1821 removed to London on obtaining the appointment of minor canon of St Paul's cathedral. Three years later he became one of the priests in ordinary of the King's Chapel Royal, and was appointed to a city living. In 1826 he first contributed to *Blackwood's Magazine*; and on the establishment of *Bentley's Miscellany* in 1837 he began to furnish the series of grotesque metrical tales known as *The Ingoldsby Legends*. These became very popular, were published in a collected form and have since passed through numerous editions. In variety and whimsicality of rhymes these verses have hardly a rival since the days of *Hudibras*. But beneath this obvious popular quality there lies a store of solid antiquarian learning, the fruit of patient enthusiastic research, in out-of-the-way old books, which few readers who laugh over his pages detect. His life was grave, dignified and highly honoured. His sound judgment and his kind heart made him the trusted counsellor, the valued friend and the frequent peacemaker; and he was intolerant of all that was mean and base and false. In politics he was a Tory of the old school; yet he was the lifelong friend of the liberal Sydney Smith, whom in many respects he singularly resembled. Theodore Hook was one of his most intimate friends. Barham was a contributor to the *Edinburgh Review* and the *Literary Gazette*; he wrote articles for Gorton's *Biographical Dictionary*; and a novel, *My Cousin Nicholas* (1834). He retained vigour and freshness of heart and mind to the last, and his last verses ("As I laye a thynkynge") show no signs of decay. He died in London after a long, painful illness, on the 17th of June 1845.

A short memoir, by his son, was prefixed to a new edition of *Ingoldsby* in 1847, and a fuller *Life and Letters*, from the same hand, was published in 2 vols. in 1870.

BAR HARBOR, a well-known summer resort of Hancock county, Maine, U.S.A., an unincorporated village, in the township of Eden, on Frenchman's Bay, on the E. side of Mount Desert Island, about 45 m. S.E. of Bangor. Pop. of the township (1900) 4379; (1910) 4441; of the village (1910), about 2000, greatly increased during the summer season. Bar Harbor is served by the Maine Central railway and by steamship lines to New York, Boston, Portland and other ports. The summer climate is cool, usually too cool for sea-bathing, but there is a

large open-air salt water swimming bath. Rugged mountains from 1000 to 1500 ft. in height, a coast with deep indentations and lined with bold cliffs, a sea dotted with rocky islets, clear lakes, sparkling rivulets, deep gorges, and wooded glens are features of the attractive scenery here and in the vicinity. Several fine hotels and a number of costly residences occupy a plateau along the shore and the hillsides farther back. The Kebo Valley Club has fine golf links here; and since 1900 an annual horse show and fair has been held at Robin Hood Park at the foot of Newport Mountain. Bar Harbor is usually a summer rendezvous of the North Atlantic Squadron of the United States Navy. The name Bar Harbor, which displaced East Eden, was suggested by the bar which appears at low water between it and Bar Island. Although the first summer hotel was built here in 1855, Bar Harbor's development as a summer resort began about 1870, after some artists had visited the place, and made it widely known through their pictures. (See MOUNT DESERT.)

BAR-HEBRAEUS or **ABU'L-FARAJ**, a maphriān or catholicus of the Jacobite (Monophysite) Church in the 13th century, and (in Dr. Wright's words) "one of the most learned and versatile men that Syria ever produced." Perhaps no more industrious compiler of knowledge ever lived. Simple and uncritical in his modes of thought, and apparently devoid of any striking originality, he collected in his numerous and elaborate treatises the results of such research in theology, philosophy, science and history as was in his time possible in Syria. Most of his works were written in Syriac, but some few in Arabic, which had long before his time supplanted Syriac as a living speech.

The son of a physician of Jewish descent, Bar-Hebraeus was born in 1226 at Malatiah on the upper Euphrates. His youth was passed in the troublous times of the Mongol advance into western Asia, and his father eventually retired to Antioch, where Bar-Hebraeus completed his education. In 1246 he was ordained at Tripolis as Jacobite bishop of Gūbas near Malatiah, and a year later was transferred to the neighbouring diocese of Laqabhin, whence in 1253 he passed to be bishop of Aleppo. Deposed almost immediately by an ecclesiastical superior on account of disputes about the patriarchate, he was restored to his see in 1258, and in 1264 was promoted by the patriarch Ignatius III. to be maphriān—the next rank below that of patriarch—an office which he held till his death at Marāgha in 1286. He seems to have been a model of devotion to his ecclesiastical duties and to have won the respect of all parties in his diocese.

It is mainly as an historian that Bar-Hebraeus interests the modern student. His great historical work—the Syriac *Chronicle*—is made up of three parts. The first¹ is a history of secular events from the Creation to his own time, and in its later portions gives valuable information regarding the history of south-east Europe and western Asia. A compendium in Arabic of this secular history was made by Bar-Hebraeus under the title *al-Mukhtasar fi'l-Duwal* (Compendious History of the Dynasties). The second and third parts² of the *Chronicle* deal with the history of the Church, the second being mainly concerned with the patriarchate of Antioch, and the third with the eastern branch of the Syrian Church. Of special value to theologians is the *Aṣṣar Rasāʾ* (Storehouse of Secrets), a critical and doctrinal commentary on the text of the Scriptures. Of this many portions have been edited by various scholars, and a valuable study of the work, together with a biography and estimate of its author, has been published by J. Göttsberger (*Barhebräus und seine Scholien zur heiligen Schrift*, Freiburg i. B., 1900).

A full list of Bar-Hebraeus's other works, and of editions of such of them as have been published, will be found in W. Wright's *Syriac Literature*, pp. 268-281. The more important of them are:—(1) *Kithābah d-he-Ḥabbāhā* (Book of the Pupils of the Eyes), a treatise on logic or dialectics; (2) *Hawāth Ḥikmāhā* (Butter of Wisdom), an exposition of the whole philosophy of Aristotle; (3) *Sullāhā Haunānā* (Ascent of the Mind), a treatise on astronomy and

cosmography, edited and translated by F. Nau (Paris, 1890); (4) various medical works; (5) *Kithābah dhē-Ṣemḇē* (Book of Kavs), a treatise on grammar; (6) ethical works; (7) poems; (8) *Kithābah dhē-Thunnayyē Mighabbēkhānē* (Book of Entertaining Stories), edited and translated by E. A. W. Budge (London, 1897).

(N. M.)

BARI, a tribe of Nilotic negroes, living on the banks of the upper Nile some 200 m. N. of Albert Nyanza. They have as neighbours the Dinka to the north, the Madi to the south, and the Galla to the east. The men are tall and thin, the women fat and under middle height. Their colour is a deep dead brown. The men and unmarried girls go practically naked, the married women wearing a goatskin dyed red. The body is ornamented with red clay and the lower incisors are often extracted. Their sole wealth is cattle and their chief food milk and blood; meat is only eaten when a cow happens to die. They live in round grass huts with conical roofs. Twins are considered unlucky, the mother is divorced by her husband and her family must refund part of the marriage-price. The dead are buried in the hut; a square grave is dug in which the body is arranged in a sitting position with the hands tied behind the back. The most important men in the country are the rainmakers, who are revered even more than the chiefs, and, indeed, are famous among the surrounding tribes. The Bari warriors have been much recruited for the Egyptian army and were formerly used as slave-hunters by the Arab traders.

See Sir Samuel Baker, *The Albert N'yanza* (London, 1866); Friedrich Müller, *Die Sprache der Bari* (Vienna, 1864); G. Casati, *Ten Years in Equatoria* (London, 1891); W. Junker, *Travels in Africa* (English ed., 1890-1892); R. C. Owen, *Bari Grammar* (1908).

BARI (anc. *Barium*), a seaport and archiepiscopal see of Apulia, Italy, capital of the province of Bari, situated on a small peninsula projecting into the Adriatic, 69 m. N.W. of Brindisi by rail. Pop. (1901) 77,478. The town consists of two parts, the closely built old town on the peninsula to the N., and the new town to the S., which is laid out on a rectangular plan. The former contains the cathedral of S. Sabino, begun in 1035 but not completed till 1171; the exterior preserves in the main the fine original architecture (notably the dome and campanile), but the interior has been modernized. Not far off is the church of S. Nicola, founded in 1087 to receive the relics of this saint, which were brought from Myra in Lycia, and now lie beneath the altar in the crypt. The façade is fine, and the interior, divided into three naves by columns, with galleries over the aisles, has fortunately not been restored; the vaulting of the crypt has, however, been covered with modern stucco. The church is one of the four Palatine churches of Apulia (the others being the cathedrals of Acquaviva and Altamura, and the church of Monte S. Angelo sul Gargano). Adjacent is the small church of S. Gregorio, belonging also to the 11th century. The castle, built in 1169, and strengthened in 1233, lies on the W. side of the old town: it is now used as a prison. The old harbour lies on the E. side of the peninsula, and the new on the W. In the new town is the Ateneo, containing the provincial museum, with a large collection of vases found in the district, in which the pre-Hellenic specimens are especially important (M. Mayer in *Römische Mitteilungen*, 1897, 201; 1899, 13; 1904, 188, 276). Bari is the seat of the command of the IX. army corps, and the most important commercial town in Apulia. It manufactures olive oil, soap, carbon sulphide and playing-cards, and has a large iron foundry.

Barium does not seem to have been a place of great importance in early antiquity; only bronze coins struck by it have been found. In Roman times it was the point of junction between the coast road and the Via Traiana; there was also a branch road to Tarentum from Barium. Its harbour, mentioned as early as 181 B.C., was probably the principal one of the district in ancient times, as at present, and was the centre of a fishery. But its greatest importance dates from the time when it became, in 852, a seat of the Saracen power, and in 885, the residence of the Byzantine governor. In 1071 it was captured by Robert Guiscard. In 1005 Peter the Hermit preached the first crusade there. In 1156 it was razed to the ground, and has several times suffered destruction. In the 14th century it became an

¹ Imperfectly edited and translated by Bruns and Kirsch in 1789. There is now a better edition by Bedjan (Paris, 1890).

² Edited and translated by Abbeoelos and Lamy (Paris and Louvain, 1872-1877).

independent duchy, and in 1558 was left by Bona Sforza to Philip II. of Spain and Naples. (T. As.)

BARILI, a town of the province of Cebu, island of Cebu, Philippine Islands, on the Barili river, 2 m. from its mouth and about 35 m. S.W. of Cebu, the capital. Pop. (1903) 31,617. It has a relatively cool and healthful climate. Its people are agriculturists and raise Indian corn, sibusaco, hemp, cacao and coffee. The language is Cebu-Visayan.

BARING, the name of a family of English financiers and bankers. The firm of Baring Brothers was founded by FRANCIS BARING (1740-1810), whose father, John Baring, son of a Lutheran minister at Bremen, had come to England from Germany, and started a cloth manufactory at Larkbear, near Exeter. Francis Baring was born at Larkbear, and in due course was placed in a London commercial firm. In 1770, in conjunction with his brother John, Francis Baring established a banking-house in London, and before he died in 1810 had so developed the business that he was regarded as the first merchant in Europe. He was for many years a director of the East India Company, and chairman in 1792-1793, receiving a baronetcy for his services. From 1784-1806 he sat almost continuously in parliament as a Whig. He left five sons, of whom the eldest, SIR THOMAS BARING (1772-1848), was a well-known art-patron and collector. The control of the business passed to his second son, ALEXANDER (1774-1848), better known as LORD ASHBURTON, who had already been highly successful in extending the firm's operations in America, where his marriage with the daughter of William Bingham, a wealthy resident of Philadelphia and United States senator, secured him considerable influence with the American commercial community. From 1806-1835 he represented various constituencies in parliament where he strongly opposed reform. In 1834 he became president of the Board of Trade and master of the mint in Sir Robert Peel's first administration, and the following year was raised to the peerage as Baron Ashburton. His business capacity and intimate acquaintance with American customs and institutions caused his appointment in 1842 as commissioner to the United States to negotiate the settlement of the north-eastern boundary question and other matters in dispute between the two countries, and he concluded in that year at Washington the treaty, commonly known as the Ashburton treaty, by which the frontier between Maine and Canada was fixed. After his death in 1848 the affairs of the house were managed by THOMAS BARING (1799-1873), the son of Sir Thomas Baring. Thomas Baring represented Huntingdon in parliament from 1844 till his death. His elder brother, Sir FRANCIS THORNHILL BARING (1796-1866), sat for Portsmouth from 1826-1865. From 1830-1841 he was chancellor of the exchequer, and from 1849-1852 first lord of the admiralty. In 1866 he was created Baron Northbrook, the barony being converted in 1876 into an earldom in favour of his eldest son Thomas George Baring (1826-1904). The latter, the 1st EARL OF NORTHBROOK, was occupied almost entirely with public affairs, and filled at different times many important official positions. He is best remembered as viceroy of India, which office he held from 1872-1876, but his last public position was first lord of the admiralty (1880-1885). With the death of Thomas Baring, Edward Charles Baring (1828-1897), son of Henry Baring, M.P., and grandson of Sir Francis Baring, became head of the firm of Baring Brothers, and in 1885 was raised to the peerage as BARON REVELSTOKE. The house of Baring then stood at the height of its prosperity. During the following years a large amount of English capital was advanced to the Argentine Republic, Barings undertaking the loans and guaranteeing the interest. Through the continued default of the Argentine government, Barings became seriously involved, their heavy obligations precipitating a general financial crisis. Towards the end of 1890 it became known that the firm was on the eve of suspending payment, with liabilities amounting to £21,000,000. The prompt action of the Bank of England, which in conjunction with the leading joint-stock banks of the United Kingdom took over these liabilities, averted further disaster, and the firm of Baring Brothers was subsequently reorganized as a limited company with a capital of £1,000,000.

Besides those already referred to, various other members of the Baring family have achieved public distinction, notably Charles Baring (1807-1870), bishop of Durham, and Evelyn Baring, 1st Earl of Cromer (q.v.).

BARING-GOULD, SABINE (1834-), English novelist, was born at Exeter on the 28th of January 1834. After graduating at Clare College, Cambridge, he spent some years in travel, and became in 1864 curate of Horbury, Yorkshire; then perpetual curate of Dalton, in the same county, in 1867; and in 1871 rector of East Mersea, Essex. On his father's death in 1872 he inherited the estate of Lew Trenchard, North Devon, where his family had been settled for nearly three centuries, and he exchanged his Essex living for the rectory of Lew Trenchard in 1881. He had a ready pen, and began publishing books on one subject or another—fiction, travel, history, folk-lore, religion, mythology, from 1854 onwards. His novel *Mehalah* (1880), the scene of which is laid on the east coast of England, was an excellent story, and among many others may be mentioned *John Herring* (1883), a tale of the west country; *Court Royal* (1886); *Red Spider* (1887); *The Pennycomequicks* (1889); *Cheap Jack Zita* (1893); and *Broom Squire* (1896), a Sussex tale. His contributions to the study of topography, antiquities and folk-lore, while popularly written, were also full of serious research and real learning, notably his *Book of Were-wolves* (1865), *Curious Myths of the Middle Ages* (1866), *Curious Survivals* (1892). He produced at the same time many volumes of sermons and popular theology, and edited (1871-1873) *The Sacrists*, a quarterly review of ecclesiastical art and literature.

Living the life of the rapidly disappearing English "squarson," and full of cultivated interests, especially in humanizing the local village mind, and investigating and recording the good things of old-time, his many-sided activities were shown in every direction and his literary facility made his work known far and wide. His familiarity with the country-side and his interest in folk-lore were of special utility in recovering and preserving for publication a large mass of English popular song, and in assisting the new English movement for studying and appreciating the old national ballad-music.

BARINGO, a lake of British East Africa, some 30 m. N. of the equator in the eastern rift-valley. It is one of a chain of lakes which stand the floor of the valley and has an elevation of 3325 ft. above the sea. It is about 16 m. long by 9 broad and has an irregular outline, the northern shore being deeply indented. Its waters are brackish. Fed by several small streams it has no outlet. The largest of the rivers which enter it, the Tigrish and the Nyuki, run north through a flat marshy country which extends south of the lake. This district, inhabited by the negro tribe of Njamusi, was by the first explorers called Njemps. It is a fertile grain-growing region containing two considerable villages. The Njamusi are peaceful agriculturists who show marked friendliness to Europeans. N. of the lake rise the Karosi hills; to the E. the land rises in terraces to the edge of the Laikipia escarpment. A characteristic of the country in the neighbourhood of the lake are the "hills" of the termites (white ants). They are hollow columns 10 to 12 ft. high and from 1 ft. to 18 in. broad. The greater kudu, almost unknown elsewhere in East Africa, inhabits the flanks of the Laikipia escarpment to the east of the lake and comes to the foot-hills around Baringo to feed.

The existence of Lake Baringo was first reported in Europe by Ludwig Krapf and J. Rebmann, German missionaries stationed at Mombasa, about 1850; in J. H. Speke's map of the Nile sources (1863) Baringo is confused with Kavirondo Gulf of Victoria Nyanza; it figures in Sir H. M. Stanley's map (1877) as a large sheet of water N.E. of Victoria Nyanza. Joseph Thomson, in his journey through the Masai country in 1883, was the first white man to see the lake and to correct the exaggerated notions as to its size. Native tradition, however, asserts that the lake formerly covered a much larger area.

BARISAL, a town of British India, headquarters of Backergunge district in Eastern Bengal and Assam, situated on a river of the same name. Pop. (1901) 18,978. It is an important centre of river trade, on the steamer route through the Sundarbans

from Calcutta to the Brahmaputra. It contains a first grade college and several schools. There are a public library, established by subscription in 1858; and a students' union, for helping the sick and poor and promoting the intellectual and physical improvement of boys. Barisal has given its name to a curious physical phenomenon, known as the "Barisal guns," the cause of which has not been satisfactorily explained. These are noises, like the report of cannon, frequently heard in the channels of the delta of the Brahmaputra, at the rising of the tide.

BARIUM (symbol Ba, atomic weight 137.37 [O=16]), one of the metallic chemical elements included in the group of the alkaline earths. It takes its name from the Greek *βαρύς* (heavy) on account of its presence in barytes or heavy spar which was first investigated in 1602 by V. Casciorolus, a shoemaker of Bologna, who found that after ignition with combustible substances it became phosphorescent, and on this account it was frequently called Bolognian phosphorus. In 1774 K. W. Scheele, in examining a specimen of pyrolusite, found a new substance to be present in the mineral, for on treatment with sulphuric acid it gave an insoluble salt which was afterwards shown to be identical with that contained in heavy spar. Barium occurs chiefly in the form of barytes or heavy spar, BaSO_4 , and witherite, BaCO_3 , and to a less extent in baryto-calcite, baryto-celastine, and various complex silicates. The metal is difficult to isolate, and until recently it may be doubted whether the pure metal had been obtained. Sir H. Davy tried to electrolyse baryta, but was unsuccessful; later attempts were made by him using barium chloride in the presence of mercury. In this way he obtained an amalgam, from which on distilling off the mercury the barium was obtained as a silver white residue. R. Bunsen in 1854 electrolysed a thick paste of barium chloride and dilute hydrochloric acid in the presence of mercury, at 100°C ., obtaining a barium amalgam, from which the mercury was separated by a process of distillation. A. N. Guntz (*Comptes rendus*, 1901, 133, p. 872) electrolyses a saturated solution of barium chloride using a mercury cathode and obtains a 3% barium amalgam; this amalgam is transferred to an iron boat in a wide porcelain tube and the tube slowly heated electrically, a good yield of pure barium being obtained at about 1000°C . The metal when freshly cut possesses a silver white lustre, is a little harder than lead, and is extremely easily oxidized on exposure; it is soluble in liquid ammonia, and readily attacks both water and alcohol.

Three oxides of barium are known, namely, the monoxide, BaO , the dioxide, BaO_2 , and a suboxide, obtained by heating BaO with magnesium in a vacuum to 1100° (Guntz, *loc. cit.*, 1906, p. 359). The monoxide is formed when the metal burns in air, but is usually prepared by the ignition of the nitrate, oxygen and oxides of nitrogen being liberated. It can also be obtained by the ignition of an intimate mixture of the carbonate and carbon, and in small quantities by the ignition of the iodate. It is a greyish coloured solid, which combines very energetically with water to form the hydroxide, much heat being evolved during the combination; on heating to redness in a current of oxygen it combines with the oxygen to form the dioxide, which at higher temperatures breaks up again into the monoxide and oxygen.

Barium hydroxide, Ba(OH)_2 , is a white powder that can be obtained by slaking the monoxide with the requisite quantity of water, but it is usually made on the large scale by heating heavy spar with small coal whereby a crude barium sulphide is obtained. This sulphide is then heated in a current of moist carbon dioxide, barium carbonate being formed, $\text{BaS} + \text{H}_2\text{O} + \text{CO}_2 = \text{BaCO}_3 + \text{H}_2\text{S}$, and finally the carbonate is decomposed by a current of superheated steam, $\text{BaCO}_3 + \text{H}_2\text{O} = \text{Ba(OH)}_2 + \text{CO}_2$, leaving a residue of the hydroxide. It is a white powder moderately soluble in cold water, readily soluble in hot water, the solution possessing an alkaline reaction and absorbing carbon dioxide readily. The solution, known as *baryta-water*, finds an extensive application in practical chemistry, being used in gas-analysis for the determination of the amount of carbon dioxide in the atmosphere; and also being used in organic chemistry as a hydrolysing agent for the decomposition

of complex ureides and substituted aceto-acetic esters, while E. Fischer has used it as a condensing agent in the preparation of α - and β -acrose from acrolein dibromide. A saturated solution of the hydroxide deposits on cooling a hydrated form $\text{Ba(OH)}_2 \cdot 8\text{H}_2\text{O}$, as colourless quadratic prisms, which on exposure to air lose seven molecules of water of crystallization.

Barium dioxide, BaO_2 , can be prepared as shown above, or in the hydrated condition by the addition of excess of baryta-water to hydrogen peroxide solution, when it is precipitated in the crystalline condition as $\text{BaO}_2 \cdot 8\text{H}_2\text{O}$. These crystals on heating to 130°C . lose the water of crystallization and leave a residue of the anhydrous peroxide. In the Brin process for the manufacture of oxygen, barium dioxide is obtained as an intermediate product by heating barium monoxide with air under pressure. It is a grey coloured powder which is readily decomposed by dilute acids with the production of hydrogen peroxide.

Barium chloride, $\text{BaCl}_2 \cdot 2\text{H}_2\text{O}$, can be obtained by dissolving witherite in dilute hydrochloric acid, and also from heavy spar by ignition in a reverberatory furnace with a mixture of coal, limestone and calcium chloride, the barium chloride being extracted from the fused mass by water, leaving a residue of insoluble calcium sulphide. The chloride crystallizes in colourless rhombic tables of specific gravity 3.0 and is readily soluble in water, but is almost insoluble in concentrated hydrochloric acid and in absolute alcohol. It can be obtained in the anhydrous condition by heating it gently to about 120°C . It has a bitter taste and is a strong poison. Barium bromide is prepared by saturating baryta-water or by decomposing barium carbonate with hydrobromic acid. It crystallizes as $\text{BaBr}_2 \cdot 2\text{H}_2\text{O}$ isomorphous with barium chloride. Barium bromate, $\text{Ba(BrO}_3)_2$, can be prepared by the action of excess of bromine on baryta-water, or by decomposing a boiling aqueous solution of 100 parts of potassium bromate with a similar solution of 74 parts of crystallized barium chloride. It crystallizes in the monoclinic system, and separates from its aqueous solution as $\text{Ba(BrO}_3)_2 \cdot \text{H}_2\text{O}$. On heating, it begins to decompose at 260 - 265°C . Barium chlorate, $\text{Ba(ClO}_3)_2$, is obtained by adding barium chloride to sodium chlorate solution; on concentration of the solution sodium chloride separates first, and then on further evaporation barium chlorate crystallizes out and can be purified by recrystallization. It can also be obtained by suspending barium carbonate in boiling water and passing in chlorine. It crystallizes in monoclinic prisms of composition $\text{Ba(ClO}_3)_2 \cdot \text{H}_2\text{O}$, and begins to decompose on being heated to 250°C . Barium iodate, $\text{Ba(IO}_3)_2$, is obtained by the action of excess of iodic acid on hot caustic baryta solution or by adding sodium iodate to barium chloride solution. It crystallizes in monoclinic prisms of composition $\text{Ba(IO}_3)_2 \cdot \text{H}_2\text{O}$, and is only very sparingly soluble in cold water.

Barium carbide, BaC_2 , is prepared by a method similar to that in use for the preparation of calcium carbide (see ACETYLENE). L. Maquenne has also obtained it by distilling a mixture of barium amalgam and carbon in a stream of hydrogen. Barium sulphide, BaS , is obtained by passing sulphuretted hydrogen over heated barium monoxide, or better by fusion of the sulphate with a small coal. It is a white powder which is readily decomposed by water with the formation of the hydroxide and hydrosulphide. The phosphorescence of the sulphide obtained by heating the thiosulphate is much increased by adding uranium, bismuth, or thorium before ignition (*J. pr. Chem.*, 1905, ii, p. 106).

Barium sulphate, BaSO_4 , is the most abundant of the naturally occurring barium compounds (see BARYTES) and can be obtained artificially by the addition of sulphuric acid or any soluble sulphate to a solution of a soluble barium salt, when it is precipitated as an amorphous white powder of specific gravity 4.5. It is practically insoluble in water, and is only very slightly soluble in dilute acids; it is soluble to some extent, when freshly prepared, in hot concentrated sulphuric acid, and on cooling the solution, crystals of composition $\text{BaSO}_4 \cdot \text{H}_2\text{SO}_4$ are deposited. It is used as a pigment under the name of "permanent white" or *blanc fixe*.

Barium nitride, Ba_3N_2 , is obtained as a brownish mass by

passing nitrogen over heated barium amalgam. It is decomposed by water with evolution of hydrogen, and on heating in a current of carbonic oxide forms barium cyanide (L. Maquenne). Barium amide, $\text{Ba}(\text{NH}_2)_2$, is obtained from potassiumum and barium bromide.

Barium nitrate, $\text{Ba}(\text{NO}_3)_2$, is prepared by dissolving either the carbonate or sulphide in dilute nitric acid, or by mixing hot saturated solutions of barium chloride and sodium nitrate. It crystallizes in octahedra, having a specific gravity of 3.2, and melts at 597°C . (T. Carnelley). It is decomposed by heat, and is largely used in pyrotechny for the preparation of green fire. Barium carbonate, BaCO_3 , occurs rather widely distributed as witherite (q.v.), and may be prepared by the addition of barium chloride to a hot solution of ammonium carbonate, when it is precipitated as a dense white powder of specific gravity 4.3; almost insoluble in water.

Barium and its salts can be readily detected by the yellowish-green colour they give when moistened with hydrochloric acid and heated in the Bunsenflame, or by observation of their spectra, when two characteristic green lines are seen. In solution, barium salts may be detected by the immediate precipitate they give on the addition of calcium sulphate (this serves to distinguish barium salts from calcium salts), and by the yellow precipitate of barium chromate formed on the addition of potassium chromate. Barium is estimated quantitatively by conversion into the sulphate. The atomic weight of the element has been determined by C. Margnac by the conversion of barium chloride into barium sulphate, and also by a determination of the amount of silver required to precipitate exactly a known weight of the chloride; the mean value obtained being 136.84; T. W. Richards (*Zeit. anorg. Chem.*, 1893, 6, p. 89), by determining the equivalent of barium chloride and bromide to silver, obtained the value 137.44. For the relation of barium to radium, see RADIOACTIVITY.

BARKER, EDMUND HENRY (1788—1839), English classical scholar, was born at Hollym in Yorkshire. He entered Trinity College, Cambridge, as a scholar in 1807, but left the university without a degree, being prevented by religious scruples from taking the oath then required. He had previously obtained (in 1800) the Browne medal for Greek and Latin epigrams. After acting as amanuensis to the famous Samuel Parr, the vicar of Hatton in Warwickshire, he married and settled down at Thetford in Norfolk, where he lived for about twenty-five years. He was in the habit of adding the initials O.T.N. (of Thetford, Norfolk) to the title-page of his published works. In later life he became involved in a law-suit in connexion with a will, and thus exhausted his means. In 1837—1838 he was a prisoner for debt in the king's bench and in the Fleet. He died in London on the 21st of March 1839. Barker was a prolific writer on classical and other subjects. In addition to contributing to the *Classical Journal*, he edited portions of several classical authors for the use of schools. He was one of the first commentators to write notes in English instead of Latin. In a volume of letters he disputed the claims of Sir Philip Francis to the authorship of the Letters of Junius; his *Parriana* (1828) is a vast and ill-digested compilation of literary anecdotes and criticisms. He also saw through the press the English edition of Lemprière's *Classical Dictionary* (revised by Anthon) and of Webster's *English Dictionary*. It is as a lexicographer, however, that Barker is chiefly known. While at Hatton, he conceived the design of a new edition of Stephanus's *Thesaurus Graecae Linguae*. The work was undertaken by A. J. Valpy, and, although not expressly stated, it was understood that Barker was the responsible editor. When a few parts had appeared, it was severely criticized in the *Quarterly Review* (xvii., 1820) by Blomfield; the result was the curtailment of the original plan of the work and the omission of Barker's name in connexion with it. It was completed in twelve volumes (1816—1828). The strictures of the *Quarterly* were answered by Barker in his *Aristarchus Anti-Blomfieldianus*, which, although unconvincing, was in turn answered by Bishop Monk. He also published notes on the *Etymologicum Gudianum*, and collaborated with Professor Dunbar of Edinburgh in a Greek and English Lexicon (1831). The

editio princeps (1820) of the treatise attributed to Arcadius, *Περὶ τῶν ὀνείρων*, was published by him from a Paris MS. Continental scholars entertained a more favourable opinion of him than those of his own country. He expressed contempt for the minute verbal criticism of the Porsonian school, in which he was himself deficient.

An account of his life will be found in the *Gentleman's Magazine* for May 1839; see also *Notes and Queries* (6th series, xii. p. 443), where a full list of his works is given.

BARKER'S MILL, a mechanical contrivance invented by a Dr Barker about the end of the 17th century. It consisted of a hollow vertical cylinder, provided with a number of horizontal arms fitted with lateral apertures; the contrivance is mounted so as to rotate about the vertical axis. By allowing water to enter the vertical tube, a rotation, due to the discharge through the lateral orifices, is set up.

BARKING, a market-town in the Romford parliamentary division of Essex, England, on the river Roding near its junction with the Thames, 8 m. E. of Fenchurch Street station and Liverpool Street station, London, by the London, Tilbury & Southend and Great Eastern railways. Pop. of urban district of Barking town (1891) 14,301; (1901) 21,547. The church of St Margaret is Norman with perpendicular additions, and contains many monuments of interest. Barking was celebrated for its nunnery, one of the oldest and richest in England, founded about 670 by Erkenwald, bishop of London, and restored in 970 by King Edgar, about a hundred years after its destruction by the Danes. The abbess was a baroness *ex officio*, and the revenue at the dissolution of the monasteries was £1084. There remains a perpendicular turreted gateway. There is also an ancient market-house, used as a town-hall. Victoria Gardens form a public pleasure-ground, and there are recreation grounds. The Gaslight and Coke Company's works at Beckton are in the parish, and also extensive rubber works. At the mouth of the Roding (Barking Creek) are great sewage works, receiving the Northern Outfall sewer from London. There are also chemical works, and some shipping trade, principally in timber and fish. Barking is a suffragan bishopric in the diocese of St Albans.

BARKLY EAST, a town of Cape province, South Africa, capital of a district of the same name, and 80 m. by rail E.S.E. of Aliwal North. The town lies north of the Drakensberg on the Kraai tributary of the Orange river at an elevation of 5831 ft. The district has an area of 1564 sq. m. and a population (1904) of 8400, of whom 50% are whites. The chief occupation followed is sheep-farming, the pasturage being excellent. Like Barkly West, the town and district are named after Sir Henry Barkly, governor of Cape Colony, 1870—1877.

BARKLY WEST, a town of Cape province, South Africa, 21 m. N.W. of Kimberley, capital of a district and of an electoral division of the same name in Griqualand West. It is built on the right bank of the Vaal, here spanned by a bridge. Pop. (1904) 1037. Originally called Klipdrift, the town was the first founded by the diggers after the discovery in 1867 of diamonds along the valley of the Vaal, and it had for some years a large floating population. On the discovery of the "dry diggings" at Kimberley, the majority of the diggers removed thither. Barkly West remains, however, the centre of the alluvial diamonds industry. The diamonds of this district are noted for their purity and lustre, and are generally associated with other crystals—garnets, agates, quartz and chalcodines.

Barkly West electoral division includes the whole of Griqualand West save the Kimberley division. It is divided into the fiscal districts of Barkly West, Hay and Herbert, with a total pop. (1904) of 48,388, of whom 12,170 are whites (see GRIQUALAND).

BARLAAM AND JOSAPHAT, one of the most popular and widely disseminated of medieval religious romances, which owes its importance and interest to the fact that it is a Christianized version of the story of Gautama Siddharta, the Buddha, with which it agrees not only in broad outline but in essential details.

The Christian story first appears in Greek among the works of John (q.v.) of Damascus, who flourished in the early part of the 8th century, and who, before he adopted the monastic life, had

held high office at the court of the caliph Abū Ja'far al-Mansūr, as his father Sergius is said to have done before him.

The outline of the Greek story is as follows:—St Thomas had converted the people of India, and after the eremitic life originated in Egypt, many Indians adopted it. But a powerful pagan king arose who hated and persecuted the Christians, especially the ascetics. After this king, Abenner by name, had long been childless, a boy greatly desired and matchless in beauty, was born to him and received the name of Josaphat. The king, in his joy, summons astrologers to predict the child's destiny. They foretell glory and prosperity beyond those of all his predecessors. One sage, most learned of all, asserts, but intimates that the scene of this glory will be, not the paternal kingdom, but another infinitely more exalted, and that the child will adopt the faith which his father persecutes.

The boy shows a thoughtful and devout turn. King Abenner, troubled by this and by the remembrance of the prediction, selects a secluded city, in which he causes a splendid palace to be built, where his son should abide, attended only by tutors and servants in the flower of youth and health. No stranger was to have access, and the boy was to be cognizant of none of the sorrows of humanity, such as poverty, disease, old age or death, but only of what was pleasant, so that he should have no inducement to think of the future life; nor was he ever to hear a word of Christ and His religion.

Prince Josaphat grows up in this seclusion, acquires all kinds of knowledge and exhibits singular endowments. At length, on his urgent prayer, the king reluctantly permits him to pass the limits of the palace, after having taken all precautions to keep painful objects out of sight. But through some neglect of orders, the prince one day encounters a leper and a blind man, and asks of his attendants with pain and astonishment what such a spectacle should mean. These, they tell him, are ills to which man is liable. Shall all men have such ills? he asks. And in the end he returns home in deep depression. Another day he falls in with a decrepit old man, and stricken with dismay at the sight, renews his questions and hears for the first time of fate. And in how many years, continues the prince, does this fate befall man? and must he expect death as inevitable? Is there *no* way of escape? No means of eschewing this wretched state of decay? The attendants reply as may be imagined; and Josaphat goes home more pensive than ever, dwelling on the certainty of death and on what shall be thereafter.

At this time Barlaam, an eremite of great sanctity and knowledge, dwelling in the wilderness of Sennaritis, divinely warned, travels to India in the disguise of a merchant, and gains access to Prince Josaphat, to whom he imparts the Christian doctrine and commends the monastic life. Suspicion arises and Barlaam departs. But all attempts to shake the prince's convictions fail. As a last resource the king sends for Theudas, a magician, who removes the prince's attendants and substitutes seductive girls; but all their blandishments are resisted through prayer. The king abandons these efforts and associates his son in the government. The prince uses his power to promote religion, and everything prospers in his hands. At last Abenner himself yields to the faith, and after some years of penitence dies. Josaphat surrenders the kingdom to a friend called Barachias and departs for the wilderness. After two years of painful search and much buffeting by demons he finds Barlaam. The latter dies, and Josaphat survives as a hermit many years. King Barachias afterwards arrives, and transfers the bodies of the two saints to India, where they are the source of many miracles.

Now this story is, *mutatis mutandis*, the story of Buddha. It will suffice to recall the Buddha's education in a secluded palace, his encounter successively with a decrepit old man, with a man in mortal disease and poverty, with a dead body, and, lastly, with a religious recluse radiant with peace and dignity, and his consequent abandonment of his princely state for the ascetic life in the jungle. Some of the correspondences in the two stories are most minute, and even the phraseology, in which some of the details of Josaphat's history are described, almost literally renders the Sanskrit of the *Lalitā Vistara*. More than that, the

very word Josaph or Josaphat (Arabic, *Yudasaf*) is a corruption of Bodisat due to a confusion between the Arabic letters for Y and B, and Bodisatva is a common title for the Buddha in the many birth-stories that clustered round the life of the sage. There are good reasons for thinking that the Christian story did not originate with John of Damascus, and a strong case has been made out by Zotenberg that it reflects the religious struggles and disputes of the early 7th century in Syria, and that the Greek text was edited by a monk of Saint Saba named John, his version being the source of all later texts and translations. How much older than this the Christian story is, we cannot tell, but it is interesting to remember that it embodies in the form of a speech the "Apology" of the 2nd-century philosopher Aristides. After its appearance among the writings of John of Damascus, it was incorporated with Simeon Metaphrastes' *Lives of the Saints* (c. 950), and thence gained great vogue, being translated into almost every European language. A famous Icelandic version was made for Prince Hakon early in the 13th century. In the East, too, it took on new life and Catholic missionaries freely used it in their propaganda. Thus a Tagala (Philippine) translation was brought out at Manila in 1712. Besides furnishing the early playwrights with material for miracle plays, it has supplied episodes and apologies to many a writer, including Boccaccio, John Gower and Shakespeare. Rudolph of Ems about 1220 expanded it into a long poem of 16,000 lines, celebrating the victory of Christian over heathen teaching. The heroes of the romance have even attained saintly rank. Their names were inserted by Petrus de Natalibus in his *Catalogus Sanctorum* (c. 1380), and Cardinal Baronius included them in the official *Martyrologium* authorized by Sixtus V. (1585–1590) under the date of the 27th of November. In the Orthodox Eastern Church "the holy Josaph, son of Abenner, king of India" is allotted the 26th of August. Thus unwittingly Gautama the Buddha has come to official recognition as a saint in two great branches of the Catholic Church, and no one will say that he does not deserve the honour. A church dedicated *Divo Josaphat* in Palermo is probably not the only one of its kind.

The identity of the stories of Buddha and St Josaphat was recognized by the historian of Portuguese India, Diogo do Couto (1542–1616), as may be seen in his history (*Dec. v. liv. vi. cap. 2*). In modern times the honour belongs to Laboulaye (1859), Felix Liebrecht in 1860 putting it beyond dispute. Subsequent researches have been carried out by Zotenberg, Max Müller, Rhys Davids, Braunnholtz and Joseph Jacobs, who published his *Barlaam and Josaphat* in 1896.

BAR-LE-DUC, a town of north-eastern France, capital of the department of Meuse, 50 m. E.S.E. of Châlons-sur-Marne, on the main line of the Eastern railway between that town and Nancy. Pop. (1906) 14,624. The lower, more modern and busier part of the town extends along a narrow valley, shut in by wooded or vine-clad hills, and is traversed throughout its length by the Ormain, which is crossed by several bridges. It is limited towards the north-east by the canal from the Marne to the Rhine, on the south-west by a small arm of the Ormain, called the Canal des Usines, on the left bank of which the upper town (Ville Haute) is situated. The Ville Haute, which is reached by staircases and steep narrow thoroughfares, is intersected by a long, quiet street, bordered by houses of the 15th, 16th and 17th centuries. In this quarter are the remains (16th century) of the chateau of the dukes of Bar, dismantled in 1670, the old clock-tower and the college, built in the latter half of the 16th century. Its church of St Pierre (14th and 15th centuries) contains a skillfully-carved effigy in white stone of a half-decayed corpse, the work of Ligier Richier (1500–1572), a pupil of Michelangelo—erected to the memory of René de Châlons (d. 1544). The lower town contains the official buildings and two or three churches, but these are of little interest. Among the statues of distinguished natives of the town is one to Charles Nicolas Oudinot, whose house serves as the hôtel-de-ville. Bar-le-Duc has tribunals of first instance and of commerce, a board of trade arbitrators, a lycée, a training-college for girls, a chamber of commerce, a branch of the Bank of France and an art museum. The industries of the town include iron-founding and the manufacture of machinery, corsets, hosiery,

flannel goods, jam and wall-paper, and brewing, cotton spinning and weaving, leather-dressing and dyeing. Wine, timber and iron are important articles of commerce.

Bar-le-Duc was at one time the seat of the countship, later duchy, of Bar, the history of which is given below. Though probably of ancient origin, the town was unimportant till the 10th century when it became the residence of the counts.

COUNTS AND DUKES OF BAR. In the middle of the 10th century the territory of Bar (Barrois) formed a dependency of the Empire. In the 11th century its lords were only counts by title; they belonged to the house of Mousson (which also possessed the countships of Montbéliard and Ferrette), and usually fought in the French ranks, while their neighbours, the dukes of Lorraine, adhered to the German side. Theobald I., count of Bar, was an ally of Philip Augustus, as was also his son Henry II., who distinguished himself at the battle of Bouvines in 1214. But sometimes the counts of Bar bore arms against France. In 1301 Henry III. having made an alliance with Edward I. of England, whose daughter he had married, was vanquished by Philip the Fair, who forced him to do homage for a part of Barrois, situated west of the Meuse, which was called *Barrois mouvant*. In 1354 Robert, count of Bar, who had married the daughter of King John, was made marquis of Pont-à-Mousson by the emperor Charles IV. and took the title of duke of Bar. His successor, Edward III., was killed at Agincourt in 1415. In 1419 Louis of Bar, brother of the last-named, a cardinal and bishop of Châlons, gave the duchy of Bar to René of Anjou, the grandson of his sister Yolande, who married Isabella, duchess of Lorraine. Yolande of Anjou, who in 1444 had married Ferri of Lorraine, count of Vaudémont, became heiress of Nicholas of Anjou, duke of Calabria and of Lorraine, in 1473, and of René of Anjou, duke of Bar, in 1480; thus Lorraine, with Barrois added to it, once more returned to the family of its ancient dukes. United with Lorraine to France in 1634, Barrois remained, except for short intervals, part of the royal domain. It was granted in 1738 to Stanislaus Leszczyński, ex-king of Poland, and on his death in 1766 was once more attached to the crown of France. (M.P.*)

BARLETTA (anc. *Barduli*), a seaport town and episcopal see of Apulia, Italy, on the E.S.E. coast, in the province of Bari, 34½ m. W.N.W. of Bari by rail. Pop. (1901) 42,022. Its importance dates from the time of the Hohenstaufen. The Gothic church of S. Sepolcro was built at the close of the 12th century, and the Romanesque cathedral was begun at the same period, but added to later. In front of the former church stands a bronze statue, 14 ft. in height, of the emperor Heraclius. The castle behind the cathedral dates from 1537. The harbour is good. It was cleared by 508 sailing-vessels and 461 steamers, the latter with a total tonnage of 364,904 in 1904; the exports were of the value of £180,699 (principally wine, sulphur, oil, tartar and tartaric acid), and the imports £92,486 (coal, timber and sundries).

In the neighbourhood (between Andria and Corato), during the siege of Barletta by the French in 1503, the town being defended by the Spanish army, a combat took place between thirteen picked knights of Italy and France, which resulted in favour of the former; it has been celebrated by Massimo d'Azeglio in his *Disfida di Barletta*. Seven miles to the N.W. are the salt-works of Barletta, now known under the name of Margherita di Savoia. (T. As.)

BARLEY (*Hordeum sativum*), a member of the grass family, and an important cereal which belongs peculiarly to temperate regions. It originated from a wild species, *H. spontaneum*, a native of western Asia and has been cultivated from the earliest times. Three subspecies or races are recognized. (i.) *H. sativum*, subsp. *distichum* (described by Linnaeus as a distinct species, *H. distichum*), two-rowed barley. Only the middle spikelet of each triplet is fertile; the ear has therefore only two longitudinal rows of grain, and the spikes are strongly compressed laterally. This approaches most nearly to the wild stock, from which it is distinguished by the non-jointed axis and somewhat shorter awns. This is the race most commonly grown in the British Isles and in central Europe, and includes a large number of sub-races and varieties among which are the finest malting-

barleys. The chief sub-races are (a) peacock, fan or battledore barley, described by Linnaeus as a distinct species, *H. zeorion*, with erect short ears about 2½ in. long, broad at the base and narrow at the tip, suggesting an open fan or peacock's tail; (b) erect-earred barleys (var. *erectum*) with erect broad ears and closely-packed plump grains; (c) nodding barleys (var. *nudans*). The ripe ears of the last hang so as to become almost parallel with the stem; they are narrower and longer than in (b), owing to the grains being placed farther apart on the rachis; it includes the Chevalier variety, one of the best for malting purposes. (ii.) *H. sativum*, subsp. *hexastichum*, six-rowed barley (the *H. hexastichum* of Linnaeus). All the flowers of each triplet of spikelets on both sides of the rachis are fertile and produce ripe fruits; hence the ear produces six longitudinal rows of grain. The ears are short, erect, and the grain thin and coarse; the straw is also short. It is a hardy race, but owing to the poor quality of the grain is rarely met with in Great Britain. (iii.) *H. sativum*, subsp. *vulgare*, bere, bigg or four-rowed barley (the *H. vulgare* of Linnaeus). All the flowers of each triplet are fertile as in (ii), but the rows are not arranged regularly at equal distances round the rachis. The central fruits of each triplet form two regular rows, but the lateral spikelets form not four straight single rows as in (ii), but two regular double rows, the whole ear appearing irregularly four-rowed. This race seems to be of later origin than the others. The ears are erect, about 2½ in. long, the grains thinner and longer than in the two-rowed race, and the awns stiff and firmly adhering to the flowering glume. The var. *palidum* is the barley most frequently cultivated in northern Europe and northern Asia. This race was formerly used for malt and beer, but owing to its larger amount of gluten as compared with starch it is less adapted for brewing than the two-rowed sorts. To this belong the varieties naked barley (*H. coeleste* and *H. nudum*) and Himalayan barley (*H. trifurcatum* and *H. aegiceras*). In both the fruits fall out freely from the glume, and in the latter the awns are three-pronged and shorter than the grain.

Barley is the most hardy of all cereal grains, its limit of cultivation extending farther north than any other; and, at the same time, it can be profitably cultivated in sub-tropical countries. The opinion of Pliny, that it is the most ancient aliment of mankind, appears to be well-founded, for no less than three varieties have been found in the lake dwellings of Switzerland, in deposits belonging to the Stone Period. According to Professor Heer these varieties are the common two-rowed (*H. distichum*), the large six-rowed (*H. hexastichum*, var. *densum*), and the small six-rowed (*H. hexastichum*, var. *sanctum*). The last variety is both the most ancient and the most commonly found, and is the sacred barley of antiquity, ears of which are frequently represented plaited in the hair of the goddess Ceres, besides being figured on ancient coins. The cultivation of barley in ancient Egypt is indicated in Exod. ix. 31. Till within recent times barley formed an important source of food in northern countries, and barley cakes are still to some extent eaten. Owing, however, to its poverty in that form of nitrogenous compound called gluten, so abundant in wheat, barley-flour cannot be baked into vesiculated bread; still it is a highly-nutritious substance, the salts it contains having a high proportion of phosphoric acid. The following is the composition of barley-meal according to Von Bibra, omitting the salts:—

Water	15	per cent.
Nitrogenous compounds	12.98	"
Gum	6.744	"
Sugar	3.200	"
Starch	59.950	"
Fat	2.170	"

Barley is now chiefly cultivated for malting (see MALT) to prepare spirits and beer (see BREWING), but it is also largely employed in domestic cookery. For the latter purpose the hard, somewhat flinty grains are preferable, and they are prepared by grinding off the outer cuticle which forms "pot barley." When the attrition is carried further, so that the grain is reduced to small round pellets, it is termed "pearl barley." Patent barley is either pot or pearl barley reduced to flour. Under the name *decocum hordei*, a preparation of barley is included in the

British Pharmacopoeia, which is of value as a demulcent and emollient drink in febrile and inflammatory disorders.

Cultivation.—Apart from the growth-habits of the plant itself, the consideration that chiefly determines the routine of barley cultivation is the demand on the part of the maltster for uniformity of sample. Less care is required in its cultivation when it is intended for feeding live-stock. It is essential that the grains on the maltster's floor should germinate simultaneously, hence at the time of reaping, the whole crop must be as nearly as possible in the same stage of maturity. On rich soils the crop is liable to grow too rapidly and yield a coarse, uneven sample, consequently the best barley is grown on light, open and preferably calcareous soils, while if the condition of the soil is too high it is often reduced by growing wheat before the barley.

Barley (see AGRICULTURE, *Crops and Cropping*) is a rapidly-growing and shallow-rooted plant. The upper layer of the soil must therefore be free from weeds, finely pulverized and stocked with a readily-available supply of nutriment. In most rotations barley is grown after turnips, or some other "cleaning" crop, with or without the interposition of a wheat crop. The roots are fed off by sheep during autumn and early winter, after which the ground is ploughed to a depth of 3 or 4 in. only in order not to put the layer of soil fertilized by the sheep beyond reach of the plant. The ground is then left unworked and open to the crumpling influence of frost till towards the end of winter, when it is stirred with the cultivator followed by the harrows, or in some cases ploughed with a shallow furrow. The seed, which should be plump, light in colour, with a thin skin covered by fine wrinkles, is sown in March and early April¹ at the rate of from 8 to 12 pecks to the acre and lightly harrowed in. As even distribution at a uniform depth is necessary, the drill is preferred to the broadcast-seeder for barley sowing. In early districts seeding may take place as early as February, provided a fine tilth is obtainable, but it rarely extends beyond the end of April. If artificial manures are used, a usual dressing consists of 2 or 3 cwt. of superphosphate to the acre at the time of sowing, followed, if the ground is in poor condition, by 1 cwt. of nitrate of soda when the plant is showing. Nitrogen must, however, be applied with caution as it makes the barley rich in albumen, and highly albuminous barley keeps badly and easily loses its germinating capacity. Farm-yard manure should also be avoided. After-cultivation may comprise rolling, harrowing (to preserve the fineness of the tilth) and in some districts hoeing. Barley is cut, either with scythe or machine, when it is quite ripe with the ears bending over. The crop is often allowed to lie loose for a day or two, owing to the belief that sunshine and dews or even showers mellow it and improve its colour. It may even be stacked without tying into sheaves, though this course involves greater expenditure of labour in carrying and afterwards in threshing. There is a prejudice against the use of the binder in reaping barley, as it is impossible to secure uniformity of colour in the grain when the stalks are tightly tied in the sheaf, and the sun has not free access to those on the inside. In any case it must not be stacked while damp, and if cut by machine is therefore sometimes tied in sheaves and set up in stooks as in the case of wheat. The above sketch indicates the general principles of barley-cultivation, but in practice they are often modified by local custom or farming exigencies.

Barley is liable to smut and the other fungus diseases which attack wheat (*q.v.*), and the insect pests which prey on the two plants are also similar. The larvae of the ribbon-footed corn-fly (*Chlorops taeniopus*) caused great injury to the barley crop in Great Britain in 1893, when the plant was weakened by extreme drought. A fair crop of barley yields about 36 bushels (.56 lb to the bushel) per acre, but under the best conditions 40 and 50 bushels may be obtained. The yield of straw is from 15 to 20 cwt. per acre. Barley-straw is considered inferior both as fodder and litter.

BARLEY-BREAK, an old English country game frequently mentioned by the poets of the 17th and 18th centuries. It was

¹ Barley is occasionally sown in autumn to provide keep for sheep in the following spring.

played by three pairs composed of one of each sex, who were stationed in three bases or plots, contiguous to each other. The couple occupying the middle base, called *hell* or *prison*, endeavoured to catch the other two, who, when chased, might *break* to avoid being caught. If one was overtaken, he and his companion were condemned to *hell*. From this game was taken the expression "the last couple in hell," often used in old plays.

BARLEY-CORN, a grain of barley, and thus a measure taken from the length of a grain of barley, three of which (sometimes four) were considered to make up an inch. The barley-corn has been personified as representing the malt liquor made from barley, as in Burns's song "John Barleycorn."

BARLOW, SIR GEORGE HILARO (1762-1847), Anglo-Indian statesman, was appointed to the Bengal Civil Service in 1778, and in 1788 carried into execution the permanent settlement of Bengal. When the marquis of Cornwallis died in 1805, Sir George Barlow was nominated provisional governor-general, and his passion for economy and retrenchment in that capacity has caused him to be known as the only governor-general who diminished the area of British territory; but his nomination was rejected by the home government, and Lord Minto was appointed. Subsequently Barlow was created governor of Madras, where his want of tact caused a mutiny of officers in 1809, similar to that which had previously occurred under Clive. In 1812 he was recalled, and lived in retirement until his death in February 1847. He was created a baronet in 1803.

BARLOW, JOEL (1754-1812), American poet and politician, born in Redding, Fairfield county, Connecticut, on the 24th of March 1754. He graduated at Yale in 1778, was a post-graduate student there for two years, and from September 1780 until the close of the revolutionary war was chaplain in a Massachusetts brigade. He then, in 1783, removed to Hartford, Connecticut, established there in July 1784 a weekly paper, the *American Mercury*, with which he was connected for a year, and in 1786 was admitted to the bar. At Hartford he was a member of a group of young writers including Lemuel Hopkins, David Humphreys, and John Trumbull, known in American literary history as the "Hartford Wits." He contributed to the *Anarchiad*, a series of satirico-political papers, and in 1787 published a long and ambitious poem, *The Vision of Columbus*, which gave him a considerable literary reputation and was once much read. In 1788 he went to France as the agent of the Scioto Land Company, his object being to sell lands and enlist immigrants. He seems to have been ignorant of the fraudulent character of the company, which failed disastrously in 1790. He had previously, however, induced the company of Frenchmen, who ultimately founded Gallipolis, Ohio, to emigrate to America. In Paris he became a liberal in religion and an advanced republican in politics. He remained abroad for several years, spending much of his time in London; was a member of the obnoxious "London Society for Constitutional Information"; published various radical essays, including a volume entitled *Advice to the Privileged Orders* (1792), which was proscribed by the British government; and was made a citizen of France in 1792. He was American consul at Algiers in 1795-1797, securing the release of American prisoners held for ransom, and negotiating a treaty with Tripoli (1796). He returned to America in 1805, and lived near Washington, D.C., until 1811, when he became American plenipotentiary to France, charged with negotiating a commercial treaty with Napoleon, and with securing the restitution of confiscated American property or indemnity therefor. He was summoned for an interview with Napoleon at Wilna, but failed to see the emperor there; became involved in the retreat of the French army; and, overcome by exposure, died at the Polish village of Zarnowice on the 24th of December 1812. In 1807 he had published in a sumptuous volume the *Columbiad*, an enlarged edition of his *Vision of Columbus*, more pompous even than the original; but, though it added to his reputation in some quarters, on the whole it was not well received, and it has subsequently been much ridiculed. The poem for which he is now best known is his mock heroic *Hasty Pudding* (1793). Besides the writings mentioned above, he published *Conspiracy of Kings*, a *Poem addressed to*

the *Inhabitants of Europe from another Quarter of the Globe* (1792); *View of the Public Debt, Receipts and Expenditure of the United States* (1800); and the *Political Writings of Joel Barlow* (2nd ed., 1796). He also published an edition, "corrected and enlarged," of Isaac Watt's *Imitation of the Psalms of David* (1786).

See C. B. Todd's *Life and Letters of Joel Barlow* (New York and London, 1886); and a chapter, "The Literary Strivings of Joel Barlow," in M. C. Tyler's *Three Men of Letters* (New York and London, 1895).

BARLOW, PETER (1776-1862), English writer on pure and applied mathematics, was born at Norwich in 1776 and died on the 1st of March 1862. In 1806 he was appointed mathematical master in the Woolwich Academy, and filled that post for forty-one years. In 1823 he was made a fellow of the Royal Society, and two years later received the Copley medal. Steam locomotion received much attention at his hands, and he sat on the railway commissions of 1836, 1839, 1842, 1845. He received many distinctions from British and foreign scientific societies. Barlow's principal works are—*Elementary Investigation of the Theory of Numbers* (1811); *New Mathematical and Philosophical Dictionary* (1814); *Essay on Magnetic Attractions* (1820). The investigations on magnetism led to the important practical discovery of a means of rectifying or compensating compass errors in ships. Besides compiling numerous useful tables, he contributed largely to the *Encyclopaedia Metropolitana*.

BARM (a word common to Teutonic languages), the scum formed on the top of malt liquor when fermenting; yeast used to leaven bread, or to set up fermentation in liquor.

BARMECIDES, more accurately **BARMAKIDS**, a noble Persian family which attained great power under the Abbasid caliphs. Barkak, the founder of the family, was a Persian fire-worshipper, and is supposed to have been a native of Khorasan. According to tradition, his wife was taken for a time into the harem of Abdallah, brother of Kotaiba the conqueror of Balkh, and became the mother of Khalid b. Barkak the Barmecide. Barkak subsequently (about A.D. 736) rebuilt and adorned his native city of Balkh after the rebellion of Harith. The family prospered, and his grandson Yahyā b. Khalid was the vizier of the caliph Mahdi and tutor of Harūn al-Rāshid. His sons Fadl and Ja'far (the Giafar of the *Arabian Nights*) both occupied high offices under Harūn. The story of their disgrace, though romantic, is not improbable. Harūn, it is said, found his chief pleasure in the society of his sister 'Abbāsa and Ja'far, and in order that these two might be with him continuously without breach of etiquette, persuaded them to contract a purely formal marriage. The conditions were, however, not observed and Harūn, learning that 'Abbāsa had borne a son, caused Ja'far suddenly to be arrested and beheaded, and the rest of the family except Mahommed, Yahyā's brother, to be imprisoned and deprived of their property. It is probable, however, that Harūn's anger was caused to a large extent by the insinuations of his courtiers that he was a mere puppet in the hands of a powerful family. See further **CALIPHATE**, section C, §§ 4, 5.

The expression "Barmecide Feast," to denote an imaginary banquet, is drawn from one of the tales ("The Barber's Tale of his Sixth Brother") in the *Arabian Nights*, in which a series of empty dishes is served up to a hungry man to test his sense of humour by one of the Barmecides (see edition by L. C. Smithers, Lond., 1894, vol. i. 317).

BARMEN, a town of Germany, in the Prussian Rhine province and the governmental district of Düsseldorf. Pop. (1816) 19,030; (1890) 116,144; (1905) 156,148. It is served by the main railway from Berlin to Aix-la-Chapelle, and lies immediately east of Elberfeld, with which it virtually forms one town. It stretches for some 4 m. along the narrow valley of the river Wupper, which, within the municipal boundaries, is crossed by twenty bridges. High wooded hills surround it. It is divided into three main districts, Upper, Middle and Lower Barmen, and is connected, throughout its length, with Elberfeld, by railway, tramway, and a suspended trolley line, hanging over the bed of the Wupper. It contains nine Evangelical and two Roman Catholic churches, a stately modern town hall, a Hall of Fame (*Ruhmes-*

halle), with statues of the emperors William I. and Frederick III., a theatre, a picture-gallery, an ethnographical museum, and an exchange. There are many public monuments, one to Bismarck another to the poet Emil Rittershaus (1834-1897), a native of the town, and one commemorative of the Franco-German War of 1870-71. There are several high-grade public schools, academies of technical science, engineering and textile industry, and a missionary theological seminary. Barmen is one of the most important manufacturing centres of Germany. The rapid development of its commercial activity only dates from the beginning of the 19th century. It is the chief seat of ribbon weaving in Germany, and manufactures thread, lace, braids, cotton and cloth goods, carpets, silks, machinery, steel wares, plated goods and buttons, the last industry employing about 15,000 hands. There are numerous bleaching-fields, print-fields and dyeworks famous for their Turkey-red, soap works, chemical works and potteries. There are also extensive breweries. Its export trade, particularly to the United States, is very considerable. The hills lying S. of the town are laid out in public grounds. Here are a health resort, a tower commanding an extensive view, and numerous villas. Barmen, although mentioned in chronicles in the 11th century, did not attain civic rights until 1808, when it was formed into a municipality by the grand-duke of Berg.

See A. Shadwell, *Industrial Efficiency* (1906), for a good description of the industrial aspect.

BARMOTE COURT (also written **BERGHMOTE**, **BARGHMOTE**, **BARGEMOTE**, **BARMOOT**), a name applied to courts held in the lead-mining districts of Derbyshire, England, for the purpose of determining the customs peculiar to the industry and also for the settlements of any disputes which may arise in connexion therewith. Barmote courts are of very ancient origin, having been in existence in the reign of Edward I. Their jurisdiction extends both to the crown lands in the duchy of Lancaster and to those under individual ownership, comprising seven clearly defined districts. Owing to the progress made in modern mining, many of the customs and much of the procedure had become obsolete, and their powers were regulated by the High Peak Mining Customs and Mineral Courts Act 1851. An appeal from the jurisdiction of the courts lies by way of *certiorari*.

BARMOUTH (*Aberborth*, mouth of the Maw, or Mawddach, in Cardigan Bay, the only haven in Merionethshire, North Wales), a small seaport on the north of the estuary. Pop. of urban district (1901), 2214. The ride to Dolgellau (Dolgellau) is fine. The parish church, Llanabw, 1½ m. from Barmouth, is on a cliff overlooking the sea. Barmouth is a favourite bathing place, on the Cambrian railway. It is a centre for coaching in summer, especially to and through the Vale of Llangollen.

BARNABAS, in the New Testament, the surname, according to Acts iv. 36, given by the apostles (possibly in contrast to Joseph Barsabbas, Acts i. 23) to Joseph, "a Levite, a man of Cyprus by birth," who, though like Paul not of the Twelve, came like him to rank as an apostle (Acts xiv. 4, 14, i Cor. ix. 6; see **APOSTLE**). The Greek rendering of this Semitic name (*ἰὸς βαρναβᾶς*) may be translated "son of consolation" (as in the A. V.), or "son of exhortation" (as in the R. V.). But there is an initial difficulty about the Greek rendering itself, as no satisfactory etymology of Bar-nabas in this sense has as yet been suggested. The one at present in favour on the ground of philological analogy (see Z.N.T.W., 1906, p. 91 for a fresh instance), viz. Bar-Nebo, lacks intrinsic fitness for a Jew and a Levite, and of course does not accord with the statement in Acts itself. Hence it still seems best to assume some unknown Aramaic form equivalent to *βαρναβᾶς*, and then to take the latter in the sense of comfort or encouragement. This rendering, rather than "exhortation" in the sense of eloquence, best suits the usage of Acts, which suggests such comfort as is given by encouraging rather than soothing words (ix. 31, xi. 23, xiii. 15, xv. 31 f.; cf. Luke ii. 25, vi. 24). All we hear of Barnabas points to goodness of heart ("a good man," xi. 24) as his distinctive quality, giving fitness of perception (ix. 27, xi. 25 f.) and large insight into essentials (xi. 23 f.). It was probably the practically helpful and encouraging form that his gift as a "prophet" took (Acts xiii. i,

with 1 Cor. xiv. 3). It is perhaps significant that his first appearance is of the generously helpful kind described in Acts iv. 36 f. Yet we must beware of regarding Barnabas as merely a fine character; he plays too prominent a part in the New Testament for any such limitation. Thus, he next appears as braving the suspicions which dogged the ex-persecutor Saul (Paul)—possibly an old acquaintance in Hellenist circles at Jerusalem (cf. vi. 9, ix. 29)—and introducing him to the older apostles (ix. 27). More suggestive still of high repute as a man of insight and authority is his mission from the Jerusalem Church to inspect and judge of the new departure in the Gospel at Antioch, in Acts xi. 22. This means very much, though his modesty led him to call in the aid of his friend Saul to cope with the new and expanding situation (xv. 1). After their brief joint visit to Judaea and Jerusalem (xi. 30, xii. 25) we next get a glimpse of Barnabas as still chief among the spiritual leaders of the Antiochene Church, and as called by the Spirit, along with Saul, to initiate the wider mission of the Gospel, outside Syria even, in regions beyond (xiii. 2, 4). He led the way to his native Cyprus; but in the crucial struggle with the magician Bar-Jesus, in the presence of the governor of the island (xiii. 7 ff.), Saul seems to have come so decisively to the front, that henceforth, for the author of Acts he takes the lead, and Barnabas appears as his colleague (see xiii. 13, "Paul and his company," and note the turning back of Mark, the kinsman of Barnabas). The fact that at Lystra the natives styled Barnabas, Zeus, and Paul, Hermes, while suggesting that Barnabas was the man of nobler mien, proves that Paul was the chief speaker (xiv. 12); and the notices in the Pauline epistles fully bear out the view that "the gospel of the Gentiles" which they preached was in conception Paul's (Gal. ii. 1-9). Indeed, Barnabas's vacillation at Antioch, as recorded in Gal. ii. 11 ff. (whether it preceded or followed their mission in Acts xiii.-xiv.), shows that, while gifted with true intuitions, he was not strong in thinking out his position to all its issues on principle, and that it was here that Paul was so immensely his superior. But what Barnabas did see with full reasoned conviction, he was staunch in upholding; thus he upheld the general cause of Gentile freedom from the obligation of circumcision (as distinct from perfect religious equality with Jewish believers) at the Jerusalem conference (Acts xv.). With this stand for principle, however, his main work, as a great link in the transition of the Gospel from its Jewish to its universal mission, reached its climax; and Acts transfers its attention wholly to Paul, after explaining how their roads parted under rather painful circumstances (xv. 37 ff.).

When Barnabas sails away with Mark to resume work in Cyprus, the mists of history hide him from our sight. Only now and again do we catch fugitive and increasingly doubtful glimpses of him and his work. We learn from 1 Cor. ix. 6 that he adhered to Paul's principle of self-support in his mission work, and from Col. iv. 10 that his name was well known and respected at Colossae about A.D. 60. Tradition, which early regards him as one of the seventy (Clem. Alex.), carries him, plausibly enough, to Alexandria (Clem. Hom. i. 8, ii. 4; cf. the ascription to him of the Alexandrine *Epistle of Barnabas*). But the evidence for his having visited Rome (later tradition says also Milan) is stronger because more varied (Clem. Recog. i. 7, cf. Hom. i. 7; the early *Actus Petri Veracellenses*; and the late Cypriot *Encomium*), especially if we might trust the Western ascription to him of the epistle to the Hebrews, which begins with Tertullian (*De Pud.* 20). But this may itself be mere inference from its self-description (xiii. 22), as a "word of exhortation," to the "son of exhortation" (Acts iv. 36) as its author. The legend of his missionary labours in Cyprus, including martyrdom at Salamis, is quite late and untrustworthy. The date of his death is uncertain, but he was probably no longer living when Acts was written (c. A.D. 75-80).

His was essentially a mediating rôle. He filled a position intermediate between Jewish and Pauline Christianity—one characteristic of Christian Hellenists generally. Hence he is spoken of with respect in the Clementines; while Paul, as a radical in relation to the Law, is discountenanced. If we could

confidently credit him with the authorship of the epistle to the Hebrews, we could conceive his theological standpoint more exactly. But, in any case, the Barnabas of history was a greater man than the Barnabas of modern tradition.

See W. Cunningham, *Epistle of Barnabas*, pp. xvii.-lxii.; O. Braunsberger, *Der Apostel Barnabas, sein Leben* . . . (Mainz, 1876); articles s.v. in *Encyc. Biblica* and Hastings's *Dictionary of the Bible*.

THE EPISTLE OF BARNABAS is one of the apocryphal books of the New Testament. At the end of the *Codex Sinaiticus* of the 4th century, as a sort of appendix to the New Testament, there stands an "Epistle of Barnabas." Here it is followed by the *Shepherd of Hermas*, while in an 11th-century MS., which contains also the *Didaché*, it is followed by two writings which themselves form an appendix to the New Testament in the *Codex Alexandrinus*. This means that it once enjoyed quasi-canonical authority, a fact amply borne out by what Eusebius (*H. E.* iii. 25) says as to its standing in the ancient Church. It was at Alexandria that its authority was greatest. Clement comments on it, as on the canonical scriptures, in his *Hypotyposes*; Origen cites it in the same spirit as scripture (*C. Celsus*, i. 63, *De Princ.* iii. 2, 4, 7). Clement, too, ascribes it to the apostle or "the prophet" Barnabas (*Strom.* ii. 6, 31, cf. ii. 20, 116), with explicit reference to Paul's fellow-apostle. Internal evidence makes this ascription impossible, nor does the epistle itself lay any claim to such authorship. Lightfoot, indeed, suggests that its author was "some unknown namesake" of the famous Barnabas; but it is simpler to suppose that it was fathered upon the latter by the Alexandrian Church, ready to believe that so favourite a writing was of apostolic origin.

That Alexandria, the place of its earliest reception, was also the place of its birth, is borne out by the internal evidence of style and interpretation, which is Alexandrian throughout" (Lightfoot). The picture, too, which it gives of the danger lest the Christianity of its readers should be unduly Judaic in feeling and practice, suits well the experiences of a writer living in Alexandria, where Judaism was immensely strong. Further, he shows an "astonishing familiarity with the Jewish rites," in the opinion of a modern Jew (Kohler in the *Jewish Encycl.*); so much so, that the latter agrees with another Jewish scholar in saying that "the writer seems to have been a converted Jew, whose fanatic zeal rendered him a bitter opponent of Judaism within the Christian Church." These opinions must overrule the view of some Christian scholars that the writer often blunders in Jewish matters, the fact being that his knowledge is derived from the Judaism of Alexandria¹ rather than Palestine. But we need not therefore regard the author as of Jewish birth. It is enough, and more in keeping with the thought as a whole, to regard him as having been in close contact with Judaism, possibly as a proselyte. He now uses his knowledge to warn his readers, with intense passion, against all compromise between Judaism and the Gospel. In this he goes so far as to deny any historical connexion between the two, maintaining with all the devices of an extravagant allegorism, including the Rabbinic *Gematria* based on the numerical values of letters (ix. 7 f.), that the Law and Prophecy, as meant by God, had never been given to Israel as a people. The Divine oracles had ever pointed to the Christian Covenant, and had been so understood by the men of God in Israel, whereas the apostate people had turned aside to keep the ceremonial letter of the Law at the instigation of an evil angel (ix. 4). In this way he takes in succession the typical Jewish institutions—Circumcision, Foods, Ablutions, Covenant, Sabbath, Temple—showing their spiritual counterpart in the New People and its ordinances, and that the Cross was prefigured from the first. Such insight (*gnosis*) into the reality of the case he regards as the natural issue of Christian faith; and it is his main object to help his readers to attain such spirituality—the more so that, by similar insight applied to the signs of the times, he knows and can show that the end of the present age is imminent (i. 5, 7-iv.). The burden of his epistle, then, is, "Let us become

¹ His reference to the wide prevalence of circumcision beyond Israel (ix. 6) is perhaps simply an exaggeration, more or less conscious.

spiritual, a perfect temple unto God" (iv. 11); and that not only by theoretic insight, but also by practical wisdom of life. In order to enforce this moral, he passes to "another sort of *gnosis* and instruction" (xviii. 1), viz. the precepts of the "Two Ways," cited in a slightly different form from that found in the first part of the *Teaching of the Apostles*. The modifications, however, are all in a more spiritual direction, in keeping with the genuinely evangelic spirit which underlies and pervades even the allegorical ingredients of the epistle.

Its opening shows it to have been addressed to a Church, or rather a group of Churches, recently visited by the writer, who, while not wishing to write as an authoritative "teacher" so much as one who has come to love them as a friend (i. 8, cf. ix. 9), yet belongs to the class of "teachers" with a recognized spiritual gift (*charisma*), referred to e.g. in the *Didachē*. He evidently feels in a position to give his *gnosis* with some claim to a deferential hearing. This being so, the epistle was probably written, not to Alexandria, but rather by a "teacher" of the Alexandrine Church to some body of Christians in Lower Egypt among whom he had recently been visiting. This would explain the absence of specific address, so that it appears as in form a "general epistle," as Origen styles it. Its date has been much debated. But Lightfoot's reading of the apocalyptic passage in ch. iv.—with a slight modification suggested by Sir W. M. Ramsay—is really conclusive for the reign of Vespasian (A.D. 70-79). The main counter-view, in favour of a date about A.D. 130, can give no natural account of this passage, while it misconstrues the reference in ch. xvi. to the building of the spiritual temple, the Christian Church. Thus this epistle is the earliest of the Apostolic Fathers, and as such of special interest. Its central problem, the relation of Judaism and Christianity—of the Old and the New forms of a Covenant which, as Divine, must in a sense abide the same—was one which gave the early Church much trouble; nor, in absence of a due theory of the education of the race by gradual development, was it able to solve it satisfactorily.

LITERATURE.—Besides collected editions of the Apostolic Fathers, see O. Brunsberger, *Der Apostel Barnabas*, i. u. *der ihm beigelegte Brief* (Mainz, 1876); W. Cunningham, *Epistle of Barnabas* (1877); sections in J. Donaldson, *The Apostolic Fathers*; E. Reuss, *Theologie christienne*, vol. ii., and in M. von Engelhardt, *Das Christentum Justinus des Märtyrers*; and Lightfoot's fragmentary essay in his *Clement of Rome*, ii. 503-512. See also APOCRYPHAL LITERATURE, section "New Testament."

GOSPEL OF BARNABAS.—We read in antiquity, e.g. in the *Decretum Gelasii*, of an apocryphal Gospel of Barnabas (see APOCRYPHAL LITERATURE), but we have no knowledge of its contents. There exists, however, in a single MS. in Italian a longish gospel with this title, written from a Mahomedan standpoint, but probably embodying materials partly Gnostic in character and origin. The Italian MS. was found by the Deist, John Toland, in a private collection at Amsterdam (see his *Nazarenus*, 1718); subsequently it came into the possession of Prince Eugene of Savoy, and finally was obtained with Eugene's library by the imperial library at Vienna. It has been edited, with an English translation (1907) by (Rev.) Lonsdale and Laura Ragg, who hold that it was the work of a Christian renegade to Mahomedanism about the 13th-16th century. See also preliminary notice in the *Journal of Theol. Studies*, vi. 424 ff. The old view held by Toland and others that the Italian was a translation from the Arabic is demonstrably wrong. The Arabic marginal notes are apparently partly pious ejaculations, partly notes for the aid of Arabic students. The work is highly imaginative and often grotesque, but it is pervaded by an unusually high ethical enthusiasm. (J. V. B.)

BARNACLE, a name applied to Crustacea of the division *Cirripedia* or *Thyrostraca*. Originally, the name was given to the stalked barnacles (*Lepadidae* of C. Darwin), which attach themselves in great numbers to drift-wood and other objects floating in the sea and are one of the chief agents in the fouling of ships' bottoms during long voyages. The sessile barnacles (*Balanidae* of Darwin) or "acorn-shells" are found in myriads, encrusting the rocks between tide-marks on all coasts. One of

the most extraordinary and persistent myths of medieval natural history, dating back to the 12th century at least, was the cause of transferring to these organisms the name of the barnacle or barnacle goose (*Bernicla branta*). This bird is a winter visitor to Britain, and its Arctic nesting-places being then unknown, it was fabled to originate within the shell-like fruit of a tree growing by the sea-shore. In some variants of the story this shell is said to grow as a kind of mushroom on rotting timber in the sea, and is obviously one of the barnacles of the genus *Lepas*. Even after

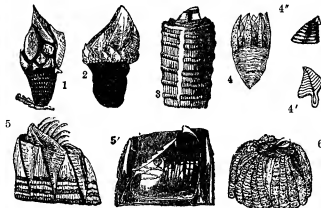

1. *Scalpellum rostratum*, Darwin, Philippine Islands.
2. *Pollipices cornuopice*, Leach, European seas.
3. *Tubnicella trachealis*, Shaw, attached to whales.
4. *Acasta sulcata*, Lamck, in sponges, New South Wales; (4'), tergum; (4''), scutum.
5. *Balanus tintinnobulum*, Linn., Atlantic.
- 5'. Section of *Balanus*, Linn.
6. *Coronula diadema*, Linn., attached to whales.

the scientific study of zoology had replaced the fabulous tales of medieval writers, it was a long time before the true affinities of the barnacles were appreciated, and they were at first classed with the Mollusca, some of which they closely resemble in external appearance. It was not till Vaughan Thompson demonstrated, in 1830, their development from a free-swimming and typically Crustacean larva that it came to be recognized that, in Huxley's graphic phrase, "a barnacle may be said to be a Crustacean fixed by its head and kicking the food into its mouth with its legs." For a systematic account of the barnacles and their allies, see the article THYROSTRACA. (W.T.C.A.)

BARNARD, LADY ANNE (1750-1825), author of the ballad "Auld Robin Gray," the eldest daughter of James Lindsay, 5th earl of Balcarres, was born at Balcarres House, Fife, on the 12th of December 1750. She was married in 1793 to Andrew Barnard, a son of the bishop of Limerick, for whom she obtained from Henry Dundas (1st Viscount Melville) an appointment as colonial secretary at the Cape of Good Hope. Thither the Barnards went in March 1797, Lady Anne remaining at the Cape until January 1802. A remarkable series of letters written by Lady Anne thence to Dundas, then secretary for war and the colonies, was published in 1901 under the title *South Africa a Century Ago*. In 1806, on the reconquest of the Cape by the British, Barnard was reappointed colonial secretary, but Lady Anne did not accompany him thither, where he died in 1807. The rest of her life was passed in London, where she died on the 6th of May 1825. "Auld Robin Gray" was written by her in 1772, to music by the Rev. William Leeves (1748-1828), as he admitted in 1812. It was published anonymously in 1783, Lady Anne only acknowledging the authorship of the words two years before her death in a letter to Sir Walter Scott, who subsequently edited it for the Bannatyne Club with two continuations.

See the memoir by W. H. Wilkins, together with the original text of "Auld Robin Gray," prefixed to *South Africa a Century Ago*.

BARNARD, FREDERICK AUGUSTUS PORTER (1809-1889), American scientist and educationalist, was born in Sheffield, Massachusetts, on the 5th of May 1809. In 1828 he graduated, second on the honour list, at Yale. He was then in turn a tutor at Yale, a teacher (1831-1832) in the American Asylum for the

Deaf and Dumb at Hartford, Connecticut, and a teacher (1832-1838) in the New York Institute for the Instruction of the Deaf and Dumb. From 1838 to 1848 he was professor of mathematics and natural philosophy, and from 1848 to 1854 was professor of chemistry and natural history in the University of Alabama, for two years, also, filling the chair of English literature. In 1854 he was ordained as deacon in the Protestant Episcopal Church. In the same year he became professor of mathematics and natural philosophy in the University of Mississippi, of which institution he was chancellor from 1856 until the outbreak of the Civil War, when, his sympathies being with the North, he resigned and went to Washington. There for some time he was in charge of the map and chart department of the United States Coast Survey. In 1864 he became the tenth president of Columbia College (now Columbia University) in New York City, which position he held until the year before his death, his service thus being longer than that of any of his predecessors. During this period the growth of the college was rapid; new departments were established; the elective system was greatly extended; more adequate provision was made for graduate study and original research, and the enrolment was increased from about 150 to more than 1000 students. Barnard strove to have educational privileges extended by the university to women as well as to men, and Barnard College, for women (see COLUMBIA UNIVERSITY), established immediately after his death, was named in his honour. He died in New York City on the 27th of April 1899. Barnard was a versatile man, of catholic training, a classical and English scholar, a mathematician, a physicist, and a chemist, a good public speaker, and a vigorous but somewhat prolix writer on various subjects, his annual reports to the Board of Trustees of Columbia being particularly valuable as discussions of educational problems. Besides being the editor-in-chief, in 1872, of *Johnson's Universal Cyclopaedia*, he published a *Treatise on Arithmetic* (1830); an *Analytical Grammar with Symbolic Illustrations* (1836); *Letters on Collegiate Government* (1855); and *Recent Progress in Science* (1869).

See John Fulton's *Memoirs of Frederick A. P. Barnard* (New York, 1896).

BARNARD, GEORGE GREY (1863—), American sculptor, was born at Bellefonte, Pennsylvania, on the 24th of May 1863. He first studied at the Art Institute, Chicago, and in 1883-1887 worked in P. T. Cavalier's atelier at Paris. He lived in Paris for twelve years, returning to America in 1896; and with his first exhibit at the Salon of 1894 he scored a great success. His principal works include, "The Boy" (1885); "Cain" (1886), later destroyed; "Brotherly Love," sometimes called "Two Friends" (1887); the allegorical "Two Natures" (1894, in the Metropolitan Museum, New York City); "The Hever" (1902, at Cairo, Illinois); "Great God Pan" (in Central Park, New York City); the "Rose Maiden"; the simple and graceful "Maidenhood"; and sculptural decorations for the new Capitol building for the state of Pennsylvania at Harrisburg.

BARNARD, HENRY (1811-1900), American educationalist, was born in Hartford, Connecticut, on the 24th of January 1811. He graduated at Yale in 1830, and in 1835 was admitted to the Connecticut bar. In 1837-1839 he was a member of the Connecticut legislature, effecting in 1838 the passage of a bill, framed and introduced by himself, which provided for "the better supervision of the common schools" and established a board of "commissioners of common schools" in the state. Of this board he was the secretary from 1838 till its abolition in 1842, and during this time worked indefatigably to reorganize and reform the common school system of the state, thus earning a national reputation as an educational reformer. In 1843 he was appointed by the governor of Rhode Island agent to examine the public schools of the state, and recommended improvements; and his work resulted in the reorganization of the school system two years later. From 1845 to 1849 he was the first commissioner of public schools in the state, and his administration was marked by a decided step in educational progress. Returning to Connecticut, he was, from 1851 to 1855, "superintendent of common schools," and principal of the State Normal School at New

Britain, Conn. From 1859 to 1860 he was chancellor of the University of Wisconsin and agent of the board of regents of the normal school fund; in 1866 he was president of St John's College, Annapolis, Maryland; and from 1867 to 1870 he was the first United States commissioner of education, and in this position he laid the foundation for the subsequent useful work of the Bureau of Education. His chief service to the cause of education, however, was rendered as the editor, from 1855 to 1881, of the *American Journal of Education*, the thirty-one volumes of which are a veritable encyclopaedia of education, one of the most valuable compendiums of information on the subject ever brought together through the agency of any one man. He also edited from 1838 to 1842, and again from 1851 to 1854, the *Connecticut Common School Journal*, and from 1846 to 1849 the *Journal of the Rhode Island Institute of Instruction*. He died at Hartford, Conn., on the 5th of July 1900. Among American educational reformers, Barnard is entitled to rank next to Horace Mann of Massachusetts.

See a biographical sketch by A. D. Mayo in the *Report of the Commissioner of Education for 1896-1897* (Washington, 1898), and W. S. Monroe's *Educational Labours of Henry Barnard* (Syracuse, 1893).

BARNARD, JOHN, English musician, was a minor canon of St Paul's in the reign of Charles I. He was the first to publish a collection of English cathedral music. It contains some of the finest 16th-century masterpieces, ranging from the "fauxbourdon" style of Tallis's *Preces and Responses* to the most developed types of full anthem. The text, however, is not trustworthy.

BARNARD CASTLE, a market-town in the Barnard Castle parliamentary division of Durham, England, 17 m. W. of Darlington by a branch of the North Eastern railway. Pop. of urban district (1901) 4421. It is beautifully situated on the steep left bank of the Tees. A noteworthy building in the town is the octagonal town-hall, dating from 1747. There are a few picturesque old houses, and a fragment of an Augustinian convent. St Mary's church, in a variety of styles from Norman onward, contains some curious monuments; but the building of chief interest is the castle, which gives the town its name, and is the principal scene of Sir Walter Scott's *Rokeby*. The remains extend over a space of more than six acres. A remarkable building known as the Bows' Mansion and Museum, bequeathed in 1874 to the town by a descendant of Sir George Bows, contains a valuable collection of works of art. In the vicinity of the town are Egglestone Abbey, beautifully situated on the Yorkshire bank of the river, Rokeby Park on the same bank, at the confluence of the Greta, and the massive 14th century castle of Raby to the north-east. The principal manufacture is shoe-thread. The corn-market is important.

As part of the lordship of Gainford, Barnard Castle is said to have been granted by William Rufus to Guy Balian Bernard, son of Guy Balian, who built the castle, and called it after himself, Castle Bernard. To the men of the town which grew up outside the castle walls he gave, about the middle of the 12th century, a charter making them burgesses and granting them the same privileges as the town of Richmond in Yorkshire. This charter was confirmed by Bernard Balian, son of the above Bernard. Other confirmation charters were granted to the town by Hugh, John, and Alexander Balian. The castle and lordship remained in the hands of the Balias until John Balian, king of Scotland, forfeited them with his other English estates in 1296. Barnard Castle was then seized by Anthony, bishop of Durham, as being within his palatinate of Durham. Edward I, however, denied the bishop's rights and granted the castle and town to Guy Beauchamp, earl of Warwick, whose descendants continued to hold them until they passed to the crown by the marriage of Anne Nevill with Richard III., then duke of Gloucester. In 1630 Barnard Castle was sold to Sir Henry Vane, and in the same year the castle is said to have been unroofed and dismantled for the sake of the materials of which it was built. Tanning leather was formerly one of the chief industries of the town. In 1614 an act for "knights and burgesses to have place in parliament for the county palatine and city of Durham and borough of Barnard

Castle" was brought into the House of Commons, but when the act was finally passed for the county and city of Durham, Barnard Castle was not included.

BARNARDO, THOMAS JOHN (1845-1905), English philanthropist, and founder and director of homes for destitute children, was born at Dublin, Ireland, in 1845. His father was of Spanish origin, his mother being an Englishwoman. With the intention of qualifying for medical missionary work in China, he studied medicine at the London hospital, and later at Paris and Edinburgh, where he became a fellow of the Royal College of Surgeons. His medical work in the east end of London during the epidemic of cholera in 1865 first drew his attention to the great numbers of homeless and destitute children in the cities of England. Encouraged by the support of the seventh earl of Shaftesbury and the first Earl Cairns, he gave up his early ambition of foreign missionary labour, and began what was to prove his life's work. The first of the "Dr Barnardo's Homes" was opened in 1867 in Stepney Causeway, London, where are still the headquarters of the institution. From that time the work steadily increased until, at the time of the founder's death, in 1905, there were established 112 district "Homes," besides mission branches, throughout the United Kingdom. The object for which these institutions were started was to search for and to receive waifs and strays, to feed, clothe, educate, and, where possible, to give an industrial training suitable to each child. The principle adopted has been that of free and immediate admission; there are no restrictions of age or sex, religion or nationality; the physically robust and the incurably diseased are alike received, the one necessary qualification being destitution. The system under which the institution is carried on is broadly as follows:—the infants and younger girls and boys are chiefly "boarded out" in rural districts; girls above fourteen years of age are sent to the industrial training homes, to be taught useful domestic occupations; boys above seventeen years of age are first tested in labour homes and then placed in employment at home, sent to sea or emigrated; boys of between thirteen and seventeen years of age are trained for the various trades for which they may be mentally or physically fitted. Besides the various branches necessary for the foregoing work, there are also, among others, the following institutions:—a rescue home for girls in danger, a convalescent seaside home, and a hospital for sick waifs. In 1872 was founded the girls' village home at Barking, near Ilford, with its own church and sanatorium, and between sixty and seventy cottage homes, forming a real "garden city"; and there Barnardo himself was buried. In 1901, through the generosity of Mr E. H. Watts, a naval school was started at North Elmham, near Norwich, to which boys are drafted from the homes to be trained for the navy and the mercantile marine. Perhaps the most useful of all the varied work instituted by Barnardo is the emigration system, by which means thousands of boys and girls have been sent to British colonies, chiefly to Canada, where there are distributing centres at Toronto and Winnipeg, and an industrial farm of some 8000 acres near Russell in Manitoba. The fact that in Canada less than 2% of the children sent out proved failures confirmed Barnardo's conviction that "if the children of the slums can be removed from their surroundings early enough, and can be kept sufficiently long under training, heredity counts for little, environment for almost everything." In 1899 the various institutions and organizations were legally incorporated under the title of "The National Association for the reclamation of Destitute Waif Children," but the institution has always been familiarly known as "Dr Barnardo's Homes." Barnardo laid great stress on the religious teaching of the children under his care. Each child is brought up under the influence and teaching of the denomination of the parents. The homes are divided into two sections for religious teaching, Church of England and Non-conformists; children of Jewish and Roman Catholic parentage are, where possible, handed over to the care of the Jewish Board of Guardians in London, and to Roman Catholic institutions, respectively. From the foundation of the homes in 1867 to the date of Barnardo's death, nearly 60,000 children had been rescued, trained and placed out in life. Barnardo died of angina pectoris

in London on the 19th of September 1905. A national memorial was instituted to form a fund of £250,000 to relieve the various institutions of all financial liability and to place the entire work on a permanent basis. Dr William Baker, formerly the chairman of the council, was selected to succeed the founder of the homes as director. Barnardo was the author of many books dealing with the charitable work to which he devoted his life.

His biography (1907) was written by his wife (the daughter of Mr William Elmslie) and J. Marchant.

BARNAUL, a town of Asiatic Russia, government of Tomsk, standing in a plain bounded by offshoots of the Altai Mountains, and on the Barnaulka river, at its confluence with the Ob, in lat. 53° 20' N. and long. 83° 46' E., 220 m. S. of Tomsk. It is the capital of the Altai mining districts, and besides smelting furnaces possesses glassworks, a bell-foundry and a mint. It has also a meteorological observatory, established in 1841, a mining school and a museum with a rich collection of mineral and zoological specimens. Barnaul was founded in 1730 by A. Demidov, to whose memory a monument has been erected. Pop. (1900) 20,850.

BARNAVE, ANTOINE PIERRE JOSEPH MARIE (1761-1793), one of the greatest orators of the first French Revolution, was born at Grenoble in Dauphiné, on the 22nd of October 1761. He was of a Protestant family. His father was an advocate at the parlement of Grenoble, and his mother was a woman of high birth, superior ability and noble character. He was educated by his mother because, being a Protestant, he could not attend school, and he grew up at once thoughtful and passionate, studious and social, handsome in person and graceful in manners. He was brought up to the law, and at the age of twenty-two made himself favourably known by a discourse pronounced before the local parlement on the division of political powers. Dauphiné was one of the first of the provinces to feel the excitement of the coming revolution; and Barnave was foremost to give voice to the general feeling, in a pamphlet entitled *Esprit des édits enregistrés militairement le 20 mai 1788*. He was immediately elected deputy, with his father, to the states of Dauphiné, and took a prominent part in their debates. A few months later he was transferred to a wider field of action. The states-general were convoked at Versailles for the 5th of May 1789, and Barnave was chosen deputy of the *tiers état* for his native province. He soon made an impression on the Assembly, became the friend of most of the leaders of the popular party, and formed with Adrien Duport and Alexandre Lameth (*q.v.*) the group known during the Constituent Assembly as "the triumvirate." He took part in the conference on the claims of the three orders, drew up the first address to the king, and supported the proposal of Sieyès that the Assembly should declare itself National. Until 1791 he was one of the principal members of the club known later as the Jacobins, of which he drew up the manifesto and first ruler (see JACOBIENS). Though a passionate lover of liberty, he hoped to secure the freedom of France and her monarchy at the same time. But he was almost unawares borne away by the mighty currents of the time, and he took part in the attacks on the monarchy, on the clergy, on church property, and on the provincial parlements. With the one exception of Mirabeau, Barnave was the most powerful orator of the Assembly. On several occasions he stood in opposition to Mirabeau. After the fall of the Bastille he wished to save the throne. He advocated the suspensory veto, and the establishment of trial by jury in civil causes, but voted with the Left against the system of two chambers. His conflict with Mirabeau on the question of assigning to the king the right to make peace or war (from the 16th to the 23rd of May 1791) was one of the most striking scenes in the Assembly. In August 1790, after a vehement debate, he fought a duel with J. A. M. de Cazales, in which the latter was slightly wounded. About the close of October 1790 Barnave was called to the presidency of the Assembly. On the death of Mirabeau a few months later, Barnave paid a high tribute to his worth and public services, designating him the Shakespeare of oratory. On the arrest of the king and the royal family at Varennes, while attempting to escape from France, Barnave was

one of the three appointed to conduct them back to Paris. On the journey he was deeply affected by the mournful fate of Marie-Antoinette, and resolved to do what he could to alleviate their sufferings. In one of his most powerful speeches he maintained the inviolability of the king's person. His public career came to an end with the close of the Constituent Assembly, and he returned to Grenoble at the beginning of 1792. His sympathy and relations with the royal family, to whom he had submitted a plan for a counter-revolution, and his desire to check the downward progress of the Revolution, brought on him suspicion of treason. Denounced (15th of August 1792) in the Legislative Assembly, he was arrested and imprisoned for ten months at Grenoble, then transferred to Fort Barraux, and in November 1793 to Paris. The nobility of his character was proof against the assaults of suffering. "Better to suffer and to die," he said, "than lose one shade of my moral and political character." On the 28th of November he appeared before the Revolutionary Tribunal. He was condemned on the evidence of papers found at the Tuileries and executed the next day, with Dupont-Duterte.

Barnave's (*Œuvres posthumes*) were published in 1842 by Béranger (de la Drôme) in 4 vols. See F. A. Aulard, *Les Orateurs de l'Assemblée constituante* (Paris, 1882).

BARNBY, SIR JOSEPH (1838–1896), English musical composer and conductor, son of Thomas Barnby, an organist, was born at York on the 12th of August 1838. He was a chorister at York minster from the age of seven, was educated at the Royal Academy of Music under Cipriani Potter and Charles Lucas, and was appointed in 1862 organist of St Andrew's, Wells Street, London, where he raised the services to a high degree of excellence. He was conductor of "Barnby's Choir" from 1864, and in 1871 was appointed, in succession to Gounod, conductor of the Albert Hall Choral Society, a post he held till his death. In 1875 he was preceptor and director of music at Eton, and in 1892 became principal of the Guildhall School of Music, receiving the honour of knighthood in July of that year. His works include an oratorio *Rebekah*, *Ps. xcvi.*, many services and anthems, and two hundred and forty-six hymn-tunes (published in 1897 in one volume), as well as some part-songs (among them the popular "Sweet and Low"), and some pieces for the organ. As a conductor he possessed the qualities as well as the defects of the typical north-countryman; if he was wanting in the higher kind of imagination or idealism, he infused into those who sang under him something of his own rectitude and precision. He was largely instrumental in stimulating the love for Gounod's sacred music among the less educated part of the London public, although he displayed little practical sympathy with opera. On the other hand, he organized a remarkable concert performance of *Parsifal* at the Albert Hall in London in 1884. He conducted the Cardiff Festivals of 1892 and 1895. He died in London on the 28th of January 1896, and after a special service in St Paul's cathedral was buried in Norwood Cemetery.

BARNES, ALBERT (1798–1870), American theologian, was born at Rome, New York, on the 1st of December 1798. He graduated at Hamilton College, Clinton, N.Y., in 1820, and at the Princeton Theological Seminary in 1823, was ordained as a Presbyterian minister by the presbytery of Elizabethtown, New Jersey, in 1825, and was the pastor successively of the Presbyterian Church in Morristown, New Jersey (1825–1830) and of the First Presbyterian Church of Philadelphia (1830–1867). He held a prominent place in the New School branch of the Presbyterians, to which he adhered on the division of the denomination in 1837; he had been tried (but not convicted) for heresy in 1836, the charge being particularly against the views expressed by him in *Notes on Romans* (1835) of the imputation of the sin of Adam, original sin and the atonement; the bitterness stirred up by this trial contributed towards widening the breach between the conservative and the progressive elements in the church. He was an eloquent preacher, but his reputation rests chiefly on his expository works, which are said to have had a larger circulation both in Europe and America than any others of their class. Of the well-known *Notes on the New Testament*

it is said that more than a million volumes had been issued by 1870. The *Notes on Job*, the Psalms, Isaiah and Daniel, found scarcely less acceptance. Displaying no original critical power, their chief merit lies in the fact that they bring in a popular (but not always accurate) form the results of the criticism of others within the reach of general readers. Barnes was the author of several other works of a practical and devotional kind, and a collection of his *Theological Works* was published in Philadelphia in 1875. He died in Philadelphia on the 24th of December 1870.

BARNES, BARNABE (1560?–1609), English poet, fourth son of Dr Richard Barnes, bishop of Durham, was born in Yorkshire, perhaps at Stonegrave, a living of his father's, in 1568 or 1569. In 1586 he was entered at Brasenose College, Oxford, where Giovanni Florio was his servitor, and in 1591 went to France with the earl of Essex, who was then serving against the prince of Parma. On his return he published *Parthenophil and Parthenophe*, *Sonnettes*, *Madrigals*, *Elegies* and *Odes* (ent. on Stationers' Register 1593), dedicated to his "dearest friend," William Percy, who contributed a sonnet to the eulogies prefixed to a later work, *Offices*. *Parthenophil* was possibly printed for private circulation, and the copy in the duke of Devonshire's library is believed to be unique. Barnes was well acquainted with the work of contemporary French sonnetters, to whom he is largely indebted, and he borrows his title, apparently, from a Neapolitan writer of Latin verse, Hieronymus Angerianus. It is possible to outline a story from this series of love lyrics, but the incidents are slight, and in this case, as in other Elizabethan sonnet-cycles, it is difficult to dogmatize as to what is the expression of a real personal experience, and what is intellectual exercise in imitation of Petrarch. *Parthenophil* abounds in passages of great freshness and beauty, although its elaborate conceits are sometimes over-ingenious and strained. Barnes took the part of Gabriel Harvey and even experimented in classical metres. This partisanship is sufficient to account for the abuse of Thomas Nashe, who accused him, apparently on no proof at all, of stealing a nobleman's chain at Windsor, and of other things. Barnes's second work, *A Divine Centurie of Spirituall Sonnettes*, appeared in 1595. He also wrote two plays:—*The Devil's Charter* (1607), a tragedy dealing with the life of Pope Alexander VI., which was played before the king; and *The Battle of Evesham* (or Hexham), of which the MS., traced to the beginning of the 18th century, is lost. In 1606 he dedicated to King James *Offices enabling privat Persons for the speciall service of all good Princes and Policies*, a prose treatise containing, among other things, descriptions of Queen Elizabeth and of the earl of Essex. Barnes was buried at Durham in December 1609.

His *Parthenophil and Spirituall Sonnettes* were edited by Dr A. B. Grosart in a limited issue in 1875; *Parthenophil* was included by Prof. E. Arber in vol. v. of *An English Garner*; also the new edition of *An English Garner* (*Elizabethan Sonnettes*, ed. S. Lee, 1904, pp. lxxv. et seq.). Professor E. Dowden contributed a sympathetic criticism of Barnes to *The Academy* of Sept. 2, 1876.

BARNES, SIR EDWARD (1776–1838), British soldier, entered the 47th regiment in 1792, and quickly rose to field rank. He was promoted lieutenant-colonel in 1807, and colonel in 1810, and two years later went to the Peninsula to serve on Wellington's staff. His services in this capacity gained him further promotion, and as a major-general he led a brigade at Vittoria and in the Pyrenean battles. He had the cross and three clasps for his Peninsula service. As adjutant-general he served in the campaign of 1815 and was wounded at Waterloo. Already a K.C.B., he now received the Austrian order of Maria Theresa, and the Russian order of St Anne. In 1819 began his connexion with Ceylon, of which island he was governor from 1824 to 1831. He directed the construction of the great military road between Colombo and Kandy, and of many other lines of communication, made the first census of the population, and introduced coffee cultivation on the West Indian system (1824). In 1831 he received the G.C.B., and from 1831 to 1833 he was commander-in-chief in India, with the local rank of general. On his return home, after two unsuccessful attempts to secure the seat, he became M.P. for Sudbury in 1837, but he died in the following

year. Sir Edward Barnes' portrait was painted, for Ceylon, by John Wood, and a memorial statue was erected in Colombo.

BARNES, JOSHUA (1654-1712), English scholar, was born in London on the 10th of January 1654. Educated at Christ's Hospital and at Emmanuel College, Cambridge, he was in 1695 chosen regius professor of Greek, a language which he wrote and spoke with the utmost facility. One of his first publications was entitled *Gerania*; a *New Discovery of a Little Sort of People, anciently discoursed of, called Pygmies* (1675), a whimsical sketch to which Swift's *Voyage to Lilliput* possibly owes something. Among his other works are a *History of that Most Victorious Monarch Edward III.* (1688), in which he introduces long and elaborate speeches into the narrative; editions of Euripides (1694) and of Homer (1711), also one of Anacreon (1705) which contains titles of Greek verses of his own which he hoped to publish. He died on the 3rd of August 1712, at Hemingford, near St Ives, Hants.

BARNES, ROBERT (1495-1540), English reformer and martyr, born about 1495, was educated at Cambridge, where he was a member, and afterwards prior of the convent of Austin Friars, and graduated D.D. in 1523. He was apparently one of the Cambridge men who were wont to gather at the White Horse Tavern for Bible-reading and theological discussion early in the third decade of the 16th century. In 1526, he was brought before the vice-chancellor for preaching a heterodox sermon, and was subsequently examined by Wolsey and four other bishops. He was condemned to abjure or be burnt; and preferring the former alternative, was committed to the Fleet prison and afterwards to the Austin Friars in London. He escaped thence to Antwerp in 1528, and also visited Wittenberg, where he made Luther's acquaintance. He also came across Stephen Vaughan, an agent of Thomas Cromwell and an advanced reformer, who recommended him to Cromwell: "Look well," he wrote, "upon Dr Barnes' book. It is such a piece of work as I have not yet seen any like it. I think he shall sell it with his blood" (*Letters and Papers of Henry VIII.* v. 503). In 1531 Barnes returned to England, and became one of the chief intermediaries between the English government and Lutheran Germany. In 1535 he was sent to Germany, in the hope of inducing Lutheran divines to approve of Henry's divorce from Catherine of Aragon, and four years later he was employed in negotiations connected with Anne of Cleves's marriage. The policy was Cromwell's, but Henry VIII. had already in 1538 refused to adopt Lutheran theology, and the statute of Six Articles (1539), followed by the king's disgust with Anne of Cleves (1540), brought the agents of that policy to ruin. An attack upon Bishop Gardiner by Barnes in a sermon at St Paul's Cross was the signal for a bitter struggle between the Protestant and reactionary parties in Henry's council, which raged during the spring of 1540. Barnes was forced to apologize and recant; and Gardiner delivered a series of sermons at St Paul's Cross to counteract Barnes' invective. But a month or so later Cromwell was made earl of Essex, Gardiner's friend, Bishop Sampson, was sent to the Tower, and Barnes reverted to Lutheranism. It was a decisive victory. In July, Cromwell was attained, Anne of Cleves was divorced and Barnes was burnt (30th July 1540). He also had an act of attainder passed against him, a somewhat novel distinction for a heretic, which illustrates the way in which Henry VIII. employed secular machinery for ecclesiastical purposes, and regarded heresy as an offence against the state rather than against the church. Barnes was one of six executed on the same day: two, William Jerome and Thomas Gerrard, were, like himself, burnt for heresy under the Six Articles; three, Thomas Abel, Richard Fetherstone and Edward Powell, were hanged for treason in denying the royal supremacy. Both Lutherans and Catholics on the continent were shocked. Luther published Barnes' confession with a preface of his own as *Bekennntis des Glaubens* (1540), which is included in Walch's edition of Luther's *Werke* xxi. 186.

See *Letters and Papers of Henry VIII.* vols. iv.-xv. *passim*; Wrothesley's *Chronicle*; Foxe's *Acts and Monuments*, ed. G. Townsend; Burnet's *Hist. of the Ref.*, ed. Pocock; Dixon's *Hist. of the*

Church; Gairdner's *Church in the XVth Century*; Pollard's *Henry VIII. and Cranmer*; Herzog-Hauck, *Realencyclopädie*, 3rd ed. (A. F. P.)

BARNES, THOMAS (1785-1841), British journalist, was born about 1785. Educated at Christ's Hospital and Pembroke College, Cambridge, he came to London and soon joined the famous literary circle of which Hunt, Lamb and Hazlitt were prominent members. Upon the retirement of Dr Stoddart in 1817 he was appointed editor of *The Times*, a position which he held until his death, when he was succeeded by Delane. Lord Lyndhurst gave expression to a very widely-held opinion when he described him as "the most powerful man in the country." He died on the 7th of May 1841.

BARNES, WILLIAM (1800-1886), the Dorsetshire poet, was born on the 22nd of February 1800, at Rushay, near Pentridge in Dorset, the son of John Barnes and Grace Scott, of the farmer class. He was a delicate child, in direct contrast to a strong race of forebears, and inherited from his mother a refined, retiring disposition and a love for books. He went to school at Sturminster Newton, where he was considered the clever boy of the school; and when a solicitor named Dashwood applied to the master for a quick-witted boy to join him as pupil, Barnes was selected for the post. He worked with the village parson in his spare hours at classics and studied music under the organist. In 1818 he left Sturminster for the office of one Coombs at Dorchester, where he continued his evening education with another kindly clergyman. He also made great progress in the art of wood-engraving, and with the money he received for a series of blocks for a work called *Walks about Dorchester*, he printed and published his first book, *Orra, a Loyal Tale*, in 1822. In the same year he became engaged to Julia Miles, the daughter of an excise officer. In 1823 he took a school at Mere in Wiltshire, and four years later married and settled in Chantry House, a fine old Tudor mansion in that town. The school grew in numbers, and Barnes occupied all his spare time in assiduous study, reading during these years authors so diverse in character as Herodotus, Sallust, Ovid, Petrarch, Buffon and Burns. He also began to write poetry, and printed many of his verses in the *Dorset County Chronicle*. His chief studies, however, were philological; and in 1820 he published *An Etymological Glossary of English Words of Foreign Derivation*. In 1832 a strolling company of actors visited Mere, and Barnes wrote a farce, *The Honest Thief*, which they produced, and a comedy which was played at Wincanton. Barnes also wrote a number of educational books, such as *Elements of Perspective, Outlines of Geography*, and in 1833 first began his poems in the Dorsetshire dialect, among them the two eclogues "The Lotments" and "A Bit o' Sly Coorten," in the pages of the local paper. In 1835 he left Mere, and returned to Dorchester, where he started another school, removing in 1837 into larger quarters. In 1844 he published *Poems of Rural Life in the Dorset Dialect*. Three years later Barnes took holy orders, and was appointed to the cure of Whitcombe, 3 m. from Dorchester. He had been for some years upon the books of St John's College, Cambridge, and took the degree of B.D. in 1850. He resigned Whitcombe in 1852, finding the work too hard in connexion with his mastership; and in June of that year he sustained a severe bereavement by the death of his wife. Continuing his studies in the science of language, he published his *Philological Grammar* in 1854, drawing examples from more than sixty languages. For the copyright of this erudite work he received £5. The second series of dialect poems, *Homely Rhymes*, appeared in 1859 (2nd ed. 1863). *Homely Rhymes* contained some of his best-known pieces, and in the year of its publication he first began to give readings from his works. As their reputation grew he travelled all over the country, delighting large audiences with his quaint humour and natural pathos. In 1861 he was awarded a civil list pension of £70 a year, and in the next year published *Titw*, the most striking of his philological studies, in which the Teutonic roots in the English language are discussed. Barnes had a horror of Latin forms in English, and would have substituted English compounds for many Latin forms in common use. In 1862 he broke up his school, and

removed to the rectory of Winterborne Came, to which he was presented by his old friend, Captain Seymour Dawson Damer. Here he worked continuously at verse and prose, contributing largely to the magazines. A new series of *Poems of Rural Life in the Dorset Dialect* appeared in 1862, and he was persuaded in 1868 to publish a series of *Poems of Rural Life in Common English*, which was less successful than his dialect poems. These latter were collected into a single volume in 1879, and on the 7th of October 1886 Barnes died at Winterborne Came. His poetry is essentially English in character; no other writer has given quite so simple and sincere a picture of the homely life and labour of rural England. His work is full of humour and the clean, manly joy of life; and its rusticity is singularly allied to a literary sense and to high technical finish. He is indeed the Victorian Theocritus; and, as English country life is slowly swept away before the advance of the railway and the telegraph, he will be more and more read for his warm-hearted and fragrant record of rustic love and piety. His original and suggestive books on the English language, which are valuable in spite of their eccentricities, include:—*Se Gefylsta: an Anglo-Saxon Delectus* (1849); *A Grammar and Glossary of the Dorset Dialect* (1864); *An Outline of English Speech-Craft* (1878); and *A Glossary of the Dorset Dialect* (Dorchester, 1886).

See *The Life of William Barnes, Poet and Philologist* (1887), by his daughter, Lucy E. Baxter, who is known as a writer on art by the pseudonym of Leader Scott; and a notice by Thomas Hardy in the *Athenaeum* (16th of October 1886).

BARNET, a residential district in the mid or St Albans parliamentary division of Hertfordshire, England; 10 m. N. of London, served by the main line and branches of the Great Northern railway. The three chief divisions are as follows:—(1) CHIPPING or HIGH BARNET, a market town and urban district (Barnet), pop. (1901) 7876. The second epithet designates its position on a hill, but the first is given it from the market granted to the abbots of St Albans to be kept there, by Henry II. Near the town, round a point marked by an obelisk, was fought in 1471 the decisive battle between the houses of York and Lancaster, in which the earl of Warwick fell and the Lancastrians were totally defeated. The town is on the Great North Road, on which it was formerly an important coaching station. A large annual horse and cattle fair is held. (2) EAST BARNET, 2 m. S.E. of Chipping Barnet, has an ancient parish church retaining Norman portions, though enlarged in modern times. Pop. of East Barnet Valley urban district, 10,094. (3) NEW BARNET lies 1 m. E. by S. from Chipping Barnet.

FRIERN BARNET, in the Enfield parliamentary division of Middlesex, lies 3 m. S. of Chipping Barnet. Pop. of urban district, 11,566. The prefix recalls the former lordship of the manor possessed by the friary of St John of Jerusalem in Clerkenwell, London. Friern Barnet adjoins Finchley on the north and Whetstone on the south, the whole district being residential.

BARNETT, JOHN (1802–1890), English musical composer, son of a Prussian named Bernhard Beer, who changed his name on settling in England as a jeweller, was born at Bedford, and at the age of eleven sang on the Lyceum stage in London. His good voice led to his being given a musical education, and he soon began writing songs and lighter pieces for the stage. In 1834 he published a collection of *Lyrical Illustrations of the Modern Poets*. His *Mountain Syph*—with which his name is chiefly connected—received a warm welcome when produced at the Lyceum on August 25, 1834, as the first modern English opera; and it was followed by another opera *Fair Rosamund* in 1837, and by *Farinelli* in 1839. He had a large connexion as a singing-master at Cheltenham, and published *Systems and Singing-masters* (1842) and *School for the Voice* (1844). He died on the 16th of April 1890.

His nephew, JOHN FRANCIS BARNETT (1837–), son of John's brother, Joseph Alfred, also a professor of music, carried on the traditions of the family as a composer and teacher. He obtained a queen's scholarship at the Royal Academy of Music, and developed into an accomplished pianist, visiting Germany to study in 1857 and playing at a Gewandhaus concert at Leipzig in 1860. He came into notice as a composer with his symphony

in A minor (1864), and followed this with a number of compositions for orchestra, strings or pianoforte. His cantata *The Ancient Mariner* was brought out at Birmingham in 1867, and another, *Paradise and the Peri*, in 1870, both with great success. In 1873 his most important work, the oratorio *The Raising of Lazarus*, was written, and in 1876 produced at Hereford. Many other cantatas, pianoforte pieces, &c. were composed by him, and successfully brought out; and he took an active part as a professor in the work of the Guildhall School of Music and Royal College of Music.

BARNETT, SAMUEL AUGUSTUS (1844–), English clergyman and social reformer, was born at Bristol on the 8th of February 1844, the son of Francis Augustus Barnett, an iron manufacturer. After leaving Wadham College, Oxford, in 1866, he visited the United States. Next year he was ordained to the curacy of St Mary's, Bryanston Square, and took priest's orders in 1868. In 1872 he became vicar of St Jude's, Commercial Street, Whitechapel, and in the next year married Henrietta Octavia Rowland, who had been a co-worker with Miss Octavia Hill and was no less ardent a philanthropist than her husband. Mr and Mrs Barnett worked hard for the poor of their parish, opening evening schools for adults, providing them with music and reasonable entertainment, and serving on the board of guardians and on the managing committees of schools. Mr Barnett did much to discourage outdoor relief, as tending to the pauperization of the neighbourhood. At the same time the conditions of indoor relief were improved, and the various charities were co-ordinated, by co-operation with the Charity Organization Society and the parish board of guardians. In 1875 Arnold Toynbee paid a visit, the first of many, to Whitechapel, and Mr Barnett, who kept in constant touch with Oxford, formed in 1877 a small committee, over which he presided himself, to consider the organization of university extension in London, his chief assistants being Leonard Montefiore, a young Oxford man, and Frederick Rogers, a member of the vellum binders' trade union. The committee received influential support, and in October four courses of lectures, one by Dr S. R. Gardiner on English history, were given in Whitechapel. The Barnetts were also associated with the building of model dwellings, with the establishment of the children's country holiday fund and the annual loan exhibitions of fine art at the Whitechapel gallery. In 1884 an article by Mr Barnett in the *Nineteenth Century* discussed the question of university settlements. This resulted in July in the formation of the University Settlements Association, and when Toynbee Hall was built shortly afterwards Mr Barnett became its warden. He was a select preacher at Oxford in 1895–1897, and at Cambridge in 1900; he received a canonry in Bristol cathedral in 1893, but retained his wardenship of Toynbee Hall, while relinquishing the living of St Jude's. In June 1906 he was preferred to a canonry at Westminster, and when in December he resigned the wardenship of Toynbee Hall the position of president was created so that he might retain his connexion with the institution. Among Canon Barnett's works is *Practicable Socialism* (1888, 2nd ed. 1894), written in conjunction with his wife.

BARNFIELD, RICHARD (1574–1627), English poet, was born at Norbury, Staffordshire, and baptized on the 13th of June 1574. His obscure though close relationship with Shakespeare has long made him interesting to students and has attracted of late years further attention from the circumstance that important discoveries regarding his life have been made. Until recently nothing whatever was known about the facts of Barnfield's career, whose very existence had been doubted. It was, however, discovered by the late Dr A. B. Grosart that the poet was the son of Richard Barnfield (or Barnefield) and Maria Skrymsler, his wife, who were married in April 1572. They resided in the parish of Norbury, in Staffordshire, on the borders of Salop, where the poet was baptized on the 13th of June 1574. The mother died in giving birth to a daughter early in 1581, and her unmarried sister, Elizabeth Skrymsler, seems to have devoted herself to the care of the children. In November 1589 Barnfield matriculated at Brasenose College, Oxford, and took his degree in

February 1592. He "performed the exercise for his master's gown," but seems to have left the university abruptly, without proceeding to the M.A. It is conjectured that he came up to London in 1593, and became acquainted with Watson, Drayton, and perhaps with Spenser. The death of Sir Philip Sidney had occurred while Barnfield was still a school-boy, but it seems to have strongly affected his imagination and to have inspired some of his earliest verses. In November 1594, in his twenty-first year, Barnfield published anonymously his first work, *The Affectionate Shepherd*, dedicated with familiar devotion to Penelope, Lady Rich. This was a sort of florid romance, in two books of six-line stanza, in the manner of Lodge and Shakespeare, dealing at large with "the complaint of Daphnis for the love of Ganymede." As the author expressly admitted later, it was an expansion or paraphrase of Virgil's second eclogue—

"Formosum pastor Corydon ardebat Alexin."

This poem of Barnfield's was the most extraordinary specimen hitherto produced in England of the licence introduced from Italy at the Renaissance. Although the poem was successful, it did not pass without censure from the moral point of view. Into the conventional outlines of *The Affectionate Shepherd* the young poet has poured all his fancy, all his epithets, and all his coloured touches of nature. If we are not repelled by the absurd subject, we have to admit that none of the immediate imitators of *Venus and Adonis* has equalled the juvenile Barnfield in the picturesqueness of his "fine ruff-footed doves," his "speckled flower call'd sops-in-wine," or his desire "by the bright glimmering of the starry light, to catch the long-bill'd woodcock." Two months later, in January 1595, Barnfield published his second volume, *Cynthia, with certain Sonnets*, and this time signed the preface, which was dedicated, in terms which imply close personal relations, to William Stanley, the new earl of Derby. This is a book of extreme interest; it exemplifies the earliest study both of Spenser and Shakespeare. "Cynthia" itself, a panegyric on Queen Elizabeth, is written in the Spenserian stanza, of which it is probably the earliest example extant outside *The Faerie Queene*. This is followed by a sequence of twenty sonnets, which have the extraordinary interest that, while preceding the publication of Shakespeare's sonnets by fourteen years, they are closer to them in manner than are any others of the Elizabethan age. They celebrate, with extravagant ardour, the charms of a young man whose initials seem to have been J. U. or J. V., and of whom nothing else seems known. These sonnets, which preceded even the *Amoretti* of Spenser, are of unusual merit as poetry, and would rank as high in quality as in date of publication if their subject-matter were not so preposterous. They show the influence of Drayton's *Idea*, which had appeared a few months before; in that collection also, it is to be observed, there had appeared amatory sonnets addressed to a young man. If editors would courageously alter the gender of the pronouns, several of Barnfield's glowing sonnets might take their place at once in our anthologies. Before the publication of his volume, however, he had repented of his heresies, and had become enamoured of a "lass" (named Eliza or Elizabeth), whom he celebrates with effusion in an "Ode." This is probably the lady whom he presently married, and as we find him a grandfather in 1626 it is unlikely that the wedding was long delayed. In 1598 Barnfield published his third volume, *The Encomion of Lady Pecunia*, a poem in praise of money, followed by a sort of continuation, in the same six-line stanza, called "The Complaint of Poetry for the Death of Liberty." In this volume there is already a decline in poetic quality. But an appendix of "Poems in diverse Humours" to this volume of 1598 presents some very interesting features. Here appears what seems to be the absolutely earliest praise of Shakespeare in a piece entitled "A Remembrance of some English Poets," in which the still unrecognized author of *Venus and Adonis* is celebrated by the side of Spenser, Daniel and Drayton. Here also are the sonnet, "If Music and sweet Poetry agree," and the beautiful ode beginning "As it fell upon a day," which were until recently attributed to Shakespeare himself. In the next year, 1599, *The Passionate Pilgrim* was published, with the words "By W. Shakespeare" on the title-page. It was long supposed that this attribution was

correct, but Barnfield claimed one of the two pieces just mentioned, not only in 1598, but again in 1605. It is certain that both are his, and possibly other things in *The Passionate Pilgrim* also; Shakespeare's share in the twenty poems of that miscellany being doubtless confined to the five short pieces which have been definitely identified as his. In the opinion of the present writer the sonnet beginning "Sweet Cytherea" has unmistakably the stamp of Barnfield, and is probably a gloss on the first rapturous perusal of *Venus and Adonis*; the same is to be said of "Scarce had the sun," which is *aut Barnfield, aut diabolus*. One or two other contributions to *The Passionate Pilgrim* may be conjectured, with less confidence, to be Barnfield's. It has been stated that the poet was now studying the law at Gray's Inn, but for this the writer is unable to discover the authority, except that several members of that society are mentioned in the course of the volume of 1598. In all probability Barnfield now married and withdrew to his estate of Dorlestone (or Darlaston), in the county of Stafford, a house romantically situated on the river Trent, where he henceforth resided as a country gentleman. In 1605 he reprinted his *Lady Pecunia*, and this was his latest appearance as a man of letters. His son Robert Barnfield and his cousin Elinor Skrymsner were his executors when his will was proved at Lichfield; his wife, therefore, doubtless predeceased him. Barnfield died at Dorlestone Hall, and was buried in the neighbouring parish church of St Michael's, Stone, on the 6th of March 1627. The labours of Dr Grosart and of Professor Arber have thrown much light on the circumstances of Barnfield's career. He has taken of late years a far more prominent place than ever before in the history of English literature. This is due partly to the remarkable merit of his graceful, melodious and highly-coloured verse, which was practically unknown until it was privately printed in 1876 (ed. Grosart, Roxburghe Club), and at length given to the public in 1882 (ed. Arber, *English Scholars' Library*). It is also due to the mysterious personal relation of Barnfield to Shakespeare, a relation not easy to prove in detail, as it is built up on a great variety of small indications. It is, however, obvious that Barnfield warmly admired Shakespeare, whose earliest imitator he may be said to have been, and that between 1595 and 1600 the younger poet was so close to the elder that the compositions of the former could be confused with those of the latter. Barnfield died, as a poet, in his twenty-fifth year. Up to that time he had displayed a talent which, if he had pursued it, might have placed him very high among the English poets. As it is, he will always interest a certain number of readers as being, in his languid "Italianate" way, a sort of ineffectual Meleager in the rich Elizabethan anthology.

Besides the editions already cited, *The Affectionate Shepherd* was edited by Mr J. O. Halliwell-Phillips for the Percy Society (*Early English Poetry*, vol. xx.); *The Encomion of Pecunia* and some other poems by J. Boswell (Roxburghe Club, 1816); and by J. P. Collier in *Illustrations of Old English Literature* (vol. 1, 1866). (E. G.)

BARNIM, the name of a district between the Spree, the Oder and the Havel, which was added to the mark of Brandenburg during the 13th century. In the 15th century it was divided into upper and lower Barnim, and these names are now borne by two circles (*Kreise*) in the kingdom of Prussia.

BARNIM, the name of thirteen dukes who ruled over various divisions of the duchy of Pomerania. The following are the most important:—

BARNIM I. (c. 1209-1278), called the *Good*, was the son of Bogislaus II., duke of Pomerania-Stettin, and succeeded to this duchy on his father's death in 1220. After he became of age he was engaged in a long struggle with external enemies, and in 1250 was compelled to recognize the supremacy of the margrave of Brandenburg. Having in 1264 united the whole of Pomerania under his rule, Barnim devoted his energies to improving its internal condition. He introduced German settlers and customs into the duchy, founded many towns, and was extremely generous towards ecclesiastical foundations. He died on the 13th or 14th of November 1278.

BARNIM III. (c. 1303-1368), called the *Great*, was the son of Otto I., duke of Pomerania-Stettin, and took a prominent part in the defence and government of the duchy before his father's

death in 1344. A long and intermittent struggle with the representatives of the emperor Louis IV., who had invested his own son Louis with the mark of Brandenburg, enabled him to gain military experience and distinction. A victory gained by him in August 1332 was mainly instrumental in freeing Pomerania for a time from the vexatious claim of Brandenburg to supremacy over the duchy, which moreover he extended by conquest. Barnim assisted the emperor Charles IV. in his struggle with the family of Wittelsbach. He died on the 24th of August 1368.

BARNIM XI. (1501-1573), son of Bogislaus X., duke of Pomerania, became duke on his father's death in 1523. He ruled for a time in common with his elder brother George; and after George's death in 1531 he shared the duchy with his nephew Philip I., retaining for himself the duchy of Pomerania-Stettin. The earlier years of his rule were troubled by a quarrel with the margrave of Brandenburg, who wished to annex Pomerania. In 1529, however, a treaty was made which freed Pomerania from the supremacy of Brandenburg on condition that if the ducal family became extinct the duchy should revert to Brandenburg. Barnim adopted the doctrines of Martin Luther, and joined the league of Schmalkalden, but took no part in the subsequent war. But as this attitude left him without supporters he was obliged to submit to the emperor Charles V., to pay a heavy fine, and to accept the *Interim*, issued from Augsburg in May 1548. In 1560 Barnim handed over his duchy to his grand-nephew, John Frederick, and died at Stettin on the 2nd of June 1573.

BARNSELEY (BLACK, or properly BLEAK BARNSELEY), a market town and municipal borough in the Barnsley parliamentary division of the West Riding of Yorkshire, England, 15 m. N. of Sheffield. Pop. (1891) 35,427; (1901) 41,086. It is served by the Midland, Great Central, Lancashire & Yorkshire, Great Northern, and Hull & Barnsley railways. It is in the parish of Silkstone, which gives name to important collieries. It is situated on rising ground west of the river Dearne, and, though it loses in attraction owing to its numerous factories, its neighbourhood has considerable natural beauty. Among the principal buildings and institutions are several churches, of which the oldest, the parish church of St Mary, was built in 1821 on an early site; court house, public hall, institute and free library. Among several educational institutions, the free grammar school dates from 1665; and a philosophical society was founded in 1828. A monument was erected in 1905 to prominent members of the Yorkshire Miners' Association. The park was presented in 1862 by the widow of Joseph Locke, M.P. The manufacture of iron and steel, and the weaving of linen and other cloth, are the two principal industries; but there are also bleachfields, printfields, dyeworks, sawmills, cornmills and malt-houses; and the manufacture of glass, needles and wire is carried on. There are large coalfields in the neighbourhood, which, indeed, extend under the town. Coal and coke are largely exported to London and Hull. In the vicinity, Monk Bretton Priory, a Cluniac foundation of 1157, retains a Perpendicular gatehouse, some Decorated domestic remains, and fragments of the church. Wentworth Castle, built in 1730 by Thomas, earl of Strafford, stands in a singularly beautiful park, and contains a fine collection of portraits of historical interest. Besides the communications afforded by railway, Barnsley has the advantage of connexion with the Aire and Calder Navigation system of canals. The borough is under a mayor, six aldermen and eighteen councillors. Area, 2385 acres.

At the time of the Domesday survey Ilbert de Lacy held Barnsley by gift of William the Conqueror as part of the honour of Pontefract, and the overlordship remained in his family until the reign of Stephen, when it was granted by Henry de Lacy to the monks of Pontefract. Henry III. in 1249 granted the prior and convent of Pontefract a market every Wednesday at Barnsley, and a fair on the vigil and feast of St Michael and two following days, and Henry VIII. in 1512 granted them a new fair on the day of the Conversion of St Paul and two following days. The monastery evidently also held another fair there called St Ellen's fair, for in 1583 Queen Elizabeth granted this fair and St Paul's fair and the market "lately belonging to the dissolved monastery of Pontefract" to one Henry Burdett, and Ralph and Henry his

sons for their lives. Besides these charters and others granting land in Barnsley to the monks of Pontefract there is very little history of the town, since it was not until after the introduction of the linen manufacture in 1744 that it became really important. Before that time the chief industry had been wire-drawing, but this trade began to decrease about the end of the 18th century, just as the linen trade was becoming important. In 1869 Barnsley was incorporated.

See Rowland Jackson, *The History of the Town and Township of Barnsley* (1858); *Victoria County History—Yorkshire*.

BARNSTABLE, a seaport township and the county-seat of the county of the same name, in Massachusetts, U.S.A. Pop. (1900) 4364, of whom 391 were foreign-born; (1910, U. S. census) 4676. Barnstable is served by the New York, New Haven & Hartford Railway. It is situated between Cape Cod Bay on the N. and Nantucket Sound on the S., extending across Cape Cod. The soil of the township, unlike that of other parts of the county, is well adapted to agriculture, and the principal industry is the growing of vegetables and the supplying of milk and poultry for its several villages, nearly all of which are summer resorts. At Hyannis is a state normal school (1897; co-educational). Cranberries are raised in large quantities, and there are oyster and other shell fisheries. In the 17th century the mackerel and whale fisheries were the basis of economic life; the latter gave way later to the cod and other fisheries, but the fishing industry is now relatively unimportant. Much of the county is a region of sands, salt-marshes, beach-grass and scattered woods. From 1865 to 1895 the county diminished 20-1% in population. Barnstable was settled and incorporated in 1639 (county created 1685), and includes among its natives James Otis and Lemuel Shaw.

See F. Freeman, *The History of Cape Cod: the Annals of Barnstable County* (2 vols., Boston, 1858, 1862; and other impressions 1860 to 1869).

BARNSTAPLE, a seaport, market town and municipal borough, in the Barnstaple parliamentary division of Devonshire, England, on the river Taw, near the north coast. Pop. (1901) 14,137. It is served by the London & South-Western, the Great Western, and the Lynton & Barnstaple railways. The Taw is here crossed by a stone bridge of sixteen arches, said to have been built in the 12th or 13th century. The town manufactures lace, gloves, sail-cloth and fishing-nets, and has extensive potteries, tanneries, sawmills and foundries, while shipbuilding is also carried on. The harbour admits only small coasting vessels. The public buildings and institutions include a guildhall (1826), a free grammar school and a large market-place. The poet John Gay was born in the vicinity, and received his education at the grammar school, which at an earlier period had numbered Bishop Jewel among its pupils. It was founded in the 14th century, in connexion with a chantry. There are also some curious Jacobean almshouses. The borough is under a mayor, six aldermen and eighteen councillors. Area, 2236 acres.

Barnstaple (Berdestaple, Barnstapol, Barstaple, also Barum) ranks among the most ancient of royal boroughs. As early as Domesday, where it is several times mentioned, there were forty burgesses within the town and nine without, who rendered 40s. Tradition claims that King Athelstan threw up defensive earthworks here, but the existing castle is attributed to Joel of Totnes, who held the manor during the reign of William the Conqueror, and also founded a Cluniac priory, dedicated to St Mary Magdalene. From this date the borough and priory grew up side by side, but each preserving its independent privileges and rights of government until the dissolution of the latter in 1535. In Edward II.'s reign the burgesses petitioned for the restoration of rights bestowed by a pretended charter from Athelstan. The existence of this charter was denied, but the desired privileges were conceded, including the right to elect a mayor. The earliest authenticated charter is that of Henry I., which was confirmed in a charter of Henry II. The later charter states that the burgesses should have customs similar to those granted to London, and further charters confirmed the same right. A charter of Queen Mary in 1556 added some new privileges, and specified that the common council should consist of a mayor, two aldermen

and twenty-four chief burgesses. James I., by a charter dated 1610, increased the number of chief burgesses to twenty-five and instituted a recorder, a clerk of the market, justices of the peace and other officers. This charter was confirmed in 1611 and 1689, and held force until the Municipal Corporations Act of 1835, which established six aldermen and eighteen councillors. The borough sent two members to parliament in 1295, and so continued to do until the Redistribution of Seats Act of 1885, when the representation was merged in that of the county. Barnstaple was once famous for its woollen trade, now entirely declined, and as early as the reign of Edward III. was an important naval port, with an extensive shipping trade. That this prosperity was not altogether uninterrupted is testified by the fact that, at the time of the Armada, the mayor pleaded inability to contribute three ships, on account of injuries to trade consequent on the war with Spain. The Friday market and the annual four days' fair in September are held by immemorial prescription.

See J. B. Gribble, *Memorials of Barnstaple* (Barnstaple, 1830).

BARNUM, PHINEAS TAYLOR (1810-1891), American showman, was born in Bethel, Connecticut, on the 5th of July 1810, his father being an inn- and store-keeper. Barnum first started as a store-keeper, and was also concerned in the lottery mania then prevailing in the United States. After failing in business, he started in 1829 a weekly paper, *The Herald of Freedom*, in Danbury; after several libel suits and a prosecution which resulted in imprisonment, he moved to New York in 1834, and in 1835 began his career as a showman, with his purchase and exploitation of a coloured woman, Joyce Heth, reputed to have been the nurse of George Washington, and to be over a hundred and sixty years old. With this woman and a small company he made well-advertised and successful tours in America till 1839, though Joyce Heth died in 1836, when her age was proved to be not more than seventy. After a period of failure, he purchased Scudder's American Museum, New York, in 1841; to this he added considerably, and it became one of the most popular shows in the United States. He made a special hit by the exhibition, in 1842, of Charles Stratton, the celebrated "General Tom Thumb" (see DWARF). In 1844 Barnum toured with the dwarf in England. A remarkable instance of his enterprise was the engagement of Jenny Lind to sing in America at \$1000 a night for one hundred and fifty nights, all expenses being paid by the *entrepreneur*. The tour began in 1850. Barnum retired from the show business in 1855, but had to settle with his creditors in 1857, and began his old career again as showman and museum proprietor. In 1871 he established the "Greatest Show on Earth," a travelling amalgamation of circus, menagerie and museum of "freaks," &c. This show, incorporated in the name of "Barnum, Bailey & Hutchinson," and later as "Barnum & Bailey's," toured all over the world. In 1907 the business was sold to Ringling Brothers. Barnum wrote several books, such as *The Humbugs of the World* (1865), *Struggles and Triumphs* (1866), and his *Autobiography* (1854, and later editions). He died on the 7th of April 1891.

BAROCCHIO (or BAROZZI), **GIACOMO**, called DA VIGNOLA (1507-1573), Italian architect, was born at Vignola in the Modenes territory on the 1st of October 1507. His early work was conducted at Bologna, Piacenza, Assisi and Perugia, until he was summoned to Rome as papal architect under Pope Julius III. In 1564 he succeeded Michelangelo as the architect of St Peter's, and executed various portions of that fabric, besides a variety of works in Rome. The designs for the Escorial were also supplied by him. He is the author of an excellent work on the *Five Orders of Architecture* (Rome, 1563), and another work on *Practical Perspective* (Rome, 1583). To his extensive acquirements and exquisite taste were superadded an amenity of manners and a noble generosity that won the affection and admiration of all who knew him. He died in Rome on the 7th of July 1573. He was an eminent upholder of the classic style at a period when the style known as *baroque* was corrupting the architecture of Italy. The term *baroque* owes its origin to the Spanish word *barrueco* or *bernucco*, an imperfectly round pearl, and is not derived from the architect Barocchio, whose name so

much resembles it. Yet it is curious that it was much used to describe a debased form of architecture encouraged by the Jesuits whose church in Rome was built by Barocchio.

BAROCCI (or BAROCCIO), **FEDERIGO** (1528-1612), Italian painter, was born at Urbino, where the genius of Raphael inspired him. In his early youth he travelled to Rome, where he painted in fresco and was warmly commended by Michelangelo. He then returned to Urbino, where, with the exception of some short visits to Rome, he continued to reside till his death. He acquired great fame by his paintings of religious subjects, in the style of which he to some extent imitated Correggio. His own followers were very numerous, but according to Lanzi (*Hist. of Painting*) carried their master's peculiarities to excess. Barocci also etched from his own designs a few prints, which are highly finished, and executed with great softness and delicacy.

BARODA, a native state of India, within the Gujarat province of Bombay, but in direct relations with the governor-general. It consists of four isolated divisions, each of which is intercalated in the most intricate fashion with British territory or with other native states. Three of these divisions—Kadi, Baroda and Nausari—are in Gujarat proper; the fourth, Amreli with Okhamandal, is in the peninsula of Kathiawar. The total area covers 8099 sq. m. In 1901 the population was 1,952,692, showing a decrease of 19% in the decade, compared with an increase of 11% in the preceding decade. This decrease was due partly to the famines of 1896-1897 and 1900-1901, partly to the epidemics of cholera and fever which accompanied them, and partly to the plague which attacked the state in as great measure as the surrounding presidency.

The princes of Baroda were one of the chief branches of the Mahratta confederacy, which in the 18th century spread devastation and terror over India. About 1721 one Pilajai gaekwar carved a fertile slice of territory out of Gujarat, and afterwards received the title of "Leader of the Royal Troops" from the peshwa. During the last thirty-two years of the century the house fell a prey to one of those bitter and unappeasable family feuds which are the ruin of great Indian families. In 1800 the inheritance descended to a prince feeble in body and almost idiotic in mind. British troops were sent in defence of the hereditary ruler against all claimants; a treaty was signed in 1802, by which his independence of the peshwa and his dependence on British government were secured. Three years later these and various other engagements were consolidated into a systematic plan for the administration of the Baroda territory, under a prince with a revenue of three-quarters of a million sterling, perfectly independent in all internal matters, but practically kept on his throne by subsidiary British troops. For some time the history of the gaekwars was very much the same as that of most territorial houses in India: an occasional able minister, more rarely an able prince; but, on the other hand, a long dreary list of incompetent heads, vernal advisers and taskmasters oppressive to the people. At last a fierce family feud came to a climax. In 1873 an English committee of inquiry was appointed to investigate various complaints of oppression against the gaekwar, Malhar Rao, who had recently succeeded to the throne after being for a long time kept in prison by his brother, the former gaekwar. No real reform resulted, and in 1874 an attempt at poisoning the British resident led to the gaekwar being formally accused of the crime and tried by a mixed commission. The result of the trial (1875) was a failure to obtain a unanimous verdict on the charge of poisoning; the viceroy, Lord Northbrook, however, decided to depose Malhar Rao on the ground of gross misgovernment, the widow of his brother and predecessor, Khande Rao, being permitted to adopt an heir from among the descendants of the founder of the family. This heir, by name Sayaji Rao, then a boy of twelve years in the humble home of a Deccani cultivator, was educated by an English tutor, the administration being meanwhile placed for eight years under the charge of Sir T. Madhava Rao, formerly diwan of Travancore, one of the ablest and most enlightened of Indian statesmen. The result was a conspicuous success. The gaekwar showed himself a model prince, and his territories

became as well governed and prosperous as a British district. He repeatedly visited Europe in company with his wife. In 1887 the queen-empress conferred upon him at Windsor the insignia of G.C.S.I., and in 1892 upon his wife the Imperial order of the crown of India.

The gross revenue of the state is more than a million sterling. In 1901 the state currency of Babashai rupees was withdrawn, and the British rupee was introduced. The regular military force consists of a field battery, with several regiments of cavalry and battalions of infantry. In addition, there is an irregular force of horse and foot. Compulsory education has been carried on experimentally since 1893 in the Amreli division with apparent success, the compulsory age being 7 to 12 for boys and 7 to 10 for girls. Special measures are also adopted for the education of low castes and aboriginal tribes. There is a female training college under a Christian lady superintendent. The Kala Bhavan, or technical school, has departments for drawing, carpentry, dyeing, weaving and agriculture. There is also a state museum under a European director, and a state library. Portions of the state are crossed by the Bombay & Baroda and the Rajputana railways. In addition, the state has constructed three railways of its own, on three different gauges. Other railways are in contemplation. The state possesses a cotton mill.

The city of Baroda is situated on the river Viswamitri, a station on the Bombay & Baroda railway, 245 m. N. of Bombay by rail. Pop. (1901) 103,790. The whole aspect of the city has been changed by the construction of handsome public buildings, the laying-out of parks and the widening of the streets. An excellent water-supply is provided from the Ajwa lake. The cantonments, garrisoned by a native infantry regiment, are under British jurisdiction, and have a population of 4000. The city contains a college and many schools. The chief hospitals are called after the countess of Dufferin, Sayaji Rao and Jamnabai, the widow of Khande Rao.

See *Baroda Gazetteer*, 1908.

BAROMETER (from Gr. *βάρος*, pressure, and *μέτρον*, measure), an instrument by which the weight or pressure of the atmosphere is measured. The ordinary or mercurial barometer consists of a tube about 36 in. long, hermetically closed at the upper end and containing mercury. In the "cistern barometer" the tube is placed with its open end in a basin of mercury, and the atmospheric pressure is measured by the difference of the heights of the mercury in the tube and the cistern. In the "siphon barometer" the cistern is dispensed with, the tube being bent round upon itself at its lower end; the reading is taken of the difference in the levels of the mercury in the two limbs. The "aneroid" barometer (from the Gr. *α-* privative, and *νόσος*, wet) employs no liquid, but depends upon the changes in volume experienced by an exhausted metallic chamber under varying pressures. "Baroscopes" simply indicate variations in the atmospheric pressure, without supplying quantitative data. "Barographs" are barometers which automatically record any variations in pressure.

Philosophers prior to Galileo had endeavoured to explain the action of a suction pump by postulating a principle that "Nature abhors a vacuum." When Galileo observed that a common suction pump could not raise water to a greater height than about 32 ft. he considered that the "abhorrence" was limited to 32 ft., and commended the matter to the attention of his pupil Evangelista Torricelli. Torricelli perceived a ready explanation of the observed phenomenon if only it could be proved that the atmosphere had weight, and the pressure which it exerted was equal to that of a 32-ft. column of water. He proved this to be the correct explanation by reasoning as follows:—If the atmosphere supports 32 feet of water, then it should also support a column of about 2½ ft. of mercury, for this liquid is about 13½ times heavier than water. This he proved in the following manner. He selected a glass tube about a quarter of an inch in diameter and 4 ft. long, and hermetically sealed one of its ends; he then filled it with mercury and, applying his finger to the open end, inverted it in a basin containing mercury. The mercury instantly sank to nearly 30 in. above the surface

of the mercury in the basin, leaving in the top of the tube an apparent vacuum, which is now called the *Torricellian vacuum*; this experiment is sometimes known as the *Torricellian experiment*. Torricelli's views rapidly gained ground, notwithstanding the objections of certain philosophers. Valuable confirmation was afforded by the variation of the barometric column at different elevations. René Descartes and Blaise Pascal predicted a fall in the height when the barometer was carried to the top of a mountain, since, the pressure of the atmosphere being diminished, it necessarily followed that the column of mercury sustained by the atmosphere would be diminished also. This was experimentally observed by Pascal's brother-in-law, Florin Périer (1605-1672), who measured the height of the mercury column at various altitudes on the Puy de Dôme. Pascal himself tried the experiment at several towers in Paris,—Noire Dame, St Jacques de la Boucherie, &c. The results of his researches were embodied in his treatises *De l'équilibre des liqueurs* and *De la pesanteur de la masse d'air*, which were written before 1651, but were not published till 1663 after his death. Corroboration was also afforded by Marin Mersenne and Christiaan Huygens. It was not long before it was discovered that the height of the column varied at the same place, and that a rise or fall was accompanied by meteorological changes. The instrument thus came to be used as a means of predicting the weather, and it was frequently known as the *weather-glass*. The relation of the barometric pressure to the weather is mentioned by Robert Boyle, who expressed the opinion that it is exceedingly difficult to draw any correct conclusions. Edmund Halley, Leibnitz, Jean André Deluc (1727-1817) and many others investigated this subject, giving rules for predicting the weather and attempting explanations for the phenomena. Since the height of the barometric column varies with the elevation of the station at which it is observed, it follows that observations of the barometer afford a means for measuring altitudes. The early experiments of Pascal were developed by Edmund Halley, Edme Mariotte, F. Cassini, D. Bernoulli, and more especially by Deluc in his *Recherches sur les modifications de l'atmosphère* (1772), which contains a full account of the early history of the barometer and its applications. More highly mathematical investigations have been given by Laplace, and also by Richard Rühlmann (*Barometrischen Höhenmessung*, Leipzig, 1870). The modern aspects of the relation between atmospheric pressure and the weather and altitudes are treated in the article METEOROLOGY.

Many attempts have been made by which the variation in the height of the mercury column could be magnified, and so more exact measurements taken. It is not possible to enumerate in this article the many devices which have been proposed; and the reader is referred to Charles Hutton's *Mathematical and Philosophical Dictionary* (1815), William Ellis's paper on the history of the barometer in the *Quarterly Journal of the Royal Meteorological Society*, vol. xii. (1886), and E. Gerland and F. Trau Müller's *Geschichte der physikalischen Experimentierkunst* (1899). Descartes suggested a method which Huygens put into practice. The barometer tube was expanded into a cylindrical vessel at the top, and into this chamber a fine tube partly filled with water was inserted. A slight motion of the mercury occasioned a larger displacement of the water, and hence the changes in the barometric pressure were more readily detected and estimated. But the instrument failed as all water-barometers do, for the gases dissolved in the water coupled with its high vapour tension destroy its efficacy. The substitution of methyl salicylate for the water has been attended with success. Its low vapour tension (Sir William Ramsay and Sydney Young give no value below 70° C.), its low specific gravity (1.18 at 10° C.), its freedom from viscosity, have contributed to its successful use. In the form patented by C. O. Bartrum it is claimed that readings to .001 of an inch of mercury can be taken without the use of a vernier.

The diagonal barometer, in which the upper part of the tube is inclined to the lower part, was suggested by Bernardo Ramazzini (1633-1714), and also by Sir Samuel Moreland (or Moreland). This form has many defects, and even when the

tube is bent through 45° the readings are only increased in the ratio of 7 to 5. The wheel barometer of Dr R. Hooke, and the steel-yard barometer, endeavour to magnify the oscillation of the mercury column by means of a float resting on the surface of the mercury in the cistern; the motion of the float due to any alteration in the level of the mercury being rendered apparent by a change in the position of the wheel or steel-yard. The pendant barometer of G. Amontons, invented in 1695, consists of a funnel-shaped tube, which is hung vertically with the wide end downwards and closed in at the upper end. The tube contains mercury which adjusts itself in the tube so that the length of the column balances the atmospheric pressure. The instability of this instrument is obvious, for any jar would cause the mercury to leave the tube.

The *Siphon Barometer* (fig. 1) consists of a tube bent in the form of a siphon, and is of the same diameter throughout. A graduated scale passes along the whole length of the tube, and the height of the barometer is ascertained by taking the difference of the readings of the upper and lower limbs respectively. This instrument may also be read by bringing the zero-point of the graduated scale to the level of the surface of the lower limb by means of a screw, and reading off the height at once from the surface of the upper limb. This barometer requires no correction for errors of capillarity or capacity. Since, however, impurities are contracted by the mercury in the lower limb, which is usually in open contact with the air, the satisfactory working of the instrument comes soon to be seriously interfered with.



FIG. 1.
Siphon
Barometer.



FIG. 2.
Cistern
Barometer.

Fig. 2 shows the *Cistern Barometer* in its essential and simplest form. This barometer is subject to two kinds of error, the one arising from capillarity, and the other from changes in the level of the surface of the cistern as the mercury rises and falls in the tube, the latter being technically called the *error of capacity*. If a glass tube of small bore be plunged into a vessel containing mercury, it will be observed that the level of the mercury in the tube is not in the line of that of the mercury in the vessel, but somewhat below it, and that the surface is convex. The capillary depression is inversely proportional to the diameter of the tube. In standard barometers, the tube is about an inch in diameter, and the error due to capillarity is less than .001 of an inch. Since capillarity depresses the height of the column, cistern barometers require an addition to be made to the observed height, in order to give the true pressure, the amount depending, of course, on the diameter of the tube.

The error of capacity arises in this way. The height of the barometer is the perpendicular distance between the surface of the mercury in the cistern and the upper surface of the mercurial column. Now, when the barometer falls from 30 to 29 inches, an inch of mercury must flow out of the tube and pass into the cistern, thus raising the cistern level; and, on the other hand, when the barometer rises, mercury must flow out of the cistern into the tube, thus lowering the level of the mercury in the cistern. Since the scales of barometers are usually engraved on their brass cases, which are fixed (and, consequently, the zero-point from which the scale is graduated is also fixed), it follows that, from the incessant changes in the level of the cistern, the readings would be sometimes too high and sometimes too low, if no provision were made against this source of error.

A simple way of correcting the error of capacity is—to ascertain (1) the neutral point of the instrument, or that height at which the zero of the scale is exactly at the height of the surface of the cistern, and (2) the rate of error as the barometer rises or falls above this point, and then apply a correction proportional to

this rate. The instrument in which the error of capacity is satisfactorily (indeed, entirely) got rid of is *Fortin's Barometer*. Fig. 3 shows how this is effected. The upper part of the cistern is formed of a glass cylinder, through which the level of the mercury may be seen. The bottom is made like a bag, of flexible leather, against which a screw works. At the top of the interior of the cistern is a small piece of ivory, the point of which coincides with the zero of the scale. By means of the screw, which acts on the flexible cistern bottom, the level of the mercury can be raised or depressed so as to bring the ivory point exactly to the surface of the mercury in the cistern. In some barometers the cistern is fixed, and the ivory point is brought to the level of the mercury in the cistern by raising or depressing the scale.



FIG. 3.—Fortin's
Barometer.

In constructing the best barometers three materials are employed, viz.:(—1) brass, for the case, on which the scale is engraved; (2) glass, for the tube containing the mercury; and (3) the mercury itself. It is evident that if the coefficient of expansion of mercury and brass were the same, the height of the mercury as indicated by the brass scale would be the true height of the mercurial column. But this is not the case, the coefficient of expansion for mercury being considerably greater than that for brass. The result is that if a barometer stand at 30 in. when the temperature of the whole instrument, mercury and brass, is 32°, it will no longer stand at 30 in. if the temperature be raised to 69°; in fact, it will then stand at 30·1 in. This increase in the height of the column by the tenth of an inch is not due to any increase of pressure, but altogether to the greater expansion of the mercury at the higher temperature, as compared with the expansion of the brass case with the engraved scale by which the height is measured. In order, therefore, to compare with each other with exactness barometric observations made at different temperatures, it is necessary to reduce them to the heights at which they would stand at some uniform temperature. The temperature to which such observations are reduced is 32° Fahr. or 0° cent.

If English units be used (Fahrenheit degrees and inches), this correction is given by the formula $x = -H \frac{.09T - 2.56}{1000}$; in the centigrade-centimetre system the correction is .0001614 HT (H being the observed height and T the observed temperature). Devices have been invented which determine these corrections mechanically, and hence obviate the necessity of applying the above formula, or of referring to tables in which these corrections for any height of the column and any temperature are given.

The standard temperature of the English yard being 62° and not 32°, it will be found in working out the corrections from the above formula that the temperature of no correction is not 32° but 28·5°. If the scale be engraved on the glass tube, or if the instrument be furnished with a glass scale or with a wooden scale, different corrections are required. These may be worked out from the above formula by substituting for the coefficient of the expansion of brass that of glass, which is assumed to be 0·00000408, or that of wood, which is assumed to be 0. Wood, however, should not be used, its expansion with temperature being unsteady, as well as uncertain.

If the brass scale be attached to a wooden frame and be free to move up and down the frame, as is the case with many siphon barometers, the corrections for brass scales are to be used, since the zero-point of the scale is brought to the level of the lower limb; but if the brass scale be fixed to a wooden frame, the corrections for brass scales are only applicable provided the zero of the scale be fixed at (or nearly at) the zero line of the column, and be free to expand upwards. In siphon barometers, with which an observation is made from two readings on the scale, the

*Fortin's
Barometer.*

*Correct-
ness of the
barometer
reading.*

scale must be free to expand in one direction. Again, if only the upper part of the scale, say from 27 to 31 in., be screwed to a wooden frame, it is evident that not the corrections for brass scales, but those for wooden scales must be used. No account need be taken of the expansion of the glass tube containing the mercury, it being evident that no correction for this expansion is required in the case of any barometer the height of which is measured from the surface of the mercury in the cistern.

In fixing a barometer for observation, it is indispensable that it be hung in a perpendicular position, seeing that it is the perpendicular distance between the surface of the mercury in the cistern and the top of the column which is the true height of the barometer. The surface of the mercury column is convex, and in noting the height of the barometer, it is not the chord of the curve, but its tangent which is taken. This is done by setting the straight lower edge of the vernier, an appendage with which the barometer is furnished, as a tangent to the curve. The vernier is made to slide up and down the scale, and by it the height of the barometer may be read true to 0.002 or even to 0.001 in.

It is essential that the barometer is at the temperature shown by the attached thermometer. No observation can be regarded as good if the thermometer indicates a temperature differing from that of the whole instrument by more than a degree. For every degree of temperature the attached thermometer differs from the barometer, the observation will be faulty to the extent of about 0.003 in., which in discussions of diurnal range, &c., is a serious amount.

Before being used, barometers should be thoroughly examined as to the state of the mercury, the size of cistern (so as to admit of low readings), and their agreement with some known standard instrument at different points of the scale. The pressure of the atmosphere is not expressed by the weight of the mercury sustained in the tube by it, but by the perpendicular height of the column. Thus, when the height of the column is 30 in., it is not said that the atmospheric pressure is 14.7 lb on the square inch, or the weight of the mercury filling a tube at that height whose transverse section equals a square inch, but that it is 30 in., meaning that the pressure will sustain a column of mercury of that height.

It is essential in gasometry to fix upon some standard pressure to which all measurements can be reduced. The height of the standard mercury column commonly used is 76 cms. (29.922 in.) of pure mercury at 0°; this is near the average height of the barometer. Since the actual force exerted by the atmosphere varies with the intensity of gravity, and therefore with the position on the earth's surface, a place must be specified in defining the standard pressure. This may be avoided by expressing the force as the pressure in dynes due to a column of mercury, one square centimetre in section, which is supported by the atmosphere. If H cms. be the height at 0°, and g the value of gravity, the pressure is $13:596 Hg$ dynes (13:596 being the density of mercury). At Greenwich, where $g = 981.17$, the standard pressure at 0° is 1,013,800 dynes. At Paris the pressure is 1,013,600 dynes. The closeness of this unit to a mega-dyne (a million dynes) has led to the suggestion that a mega-dyne per square centimetre should be adopted as the standard pressure, and it has been adopted by some modern writers on account of its convenience of calculation and independence of locality.

The height of the barometer is expressed in English inches in England and America, but the metric system is used in all scientific work excepting in meteorology. In France and most European countries, the height is given in millimetres, a millimetre being the thousandth part of a metre, which equals 39.37079 English inches. Up to 1869 the barometer was given in half-lines in Russia, which, equalling the twentieth of an English inch, were readily reduced to English inches by dividing by 20. The metric barometric scale is now used in Russia. In a few European countries the French or Paris line, equalling 0.088814 in., is sometimes used. The English measure of length being a standard at 62° Fahr., the old French measure at 61.2°, and the metric scale at 32°,

it is necessary, before comparing observations made with the three barometers, to reduce them to the same temperature, so as to neutralize the inequalities arising from the expansion of the scales by heat.

The sympleziometer was invented in 1818 by Adie of Edinburgh. It is a revived form of Hooke's marine barometer. It consists of a glass tube, with a small chamber at the top and an open cistern below. The upper part of the tube is filled with air, and the lower part and cistern with glycerin. When atmospheric pressure is increased, the air is compressed by the rising of the fluid; but when it is diminished the fluid falls, and the contained air expands. To correct for the error arising from the increased pressure of the contained air when its temperature varies, a thermometer and sliding-scale are added, so that the instrument may be adjusted to the temperature at each observation. It is a sensitive instrument, and well suited for rough purposes at sea and for travelling, but not for exact observation. It has long been superseded by the *Aneroid*, which far exceeds it in handiness.

Aneroid Barometer.—Much obscurity surrounds the invention of barometers in which variations in pressure are rendered apparent by the alteration in the volume of an elastic chamber. The credit of the invention is usually given to Lucien Vidie, who patented his instrument in 1845, but similar instruments were in use much earlier. Thus in 1799 Nicolas Jacques Conté

(1755-1805), director of the aerostatical school at Meudon, and a man of many parts—a chemist, mechanician and painter,—devised an instrument in which the lid of the metal chamber was supported by internal springs; this instrument was employed during the Egyptian campaign for measuring the altitudes of the war-balloons. Although Vidie patented his device in 1845, the commercial manufacture of aneroids only followed after E. Bourdon's patent of the metallic manometer in 1849, when Bourdon and Richard placed about 10,000 aneroids on the market. The production was stopped by an action taken by Vidie against Bourdon for infringing the former's patent, and in 1858 Vidie obtained 25,000 francs (£1000) damages.

Fig. 4 represents the internal construction, as seen when the face is removed, but with the hand still attached, of an aneroid which differs only slightly from Vidie's form. a is a flat circular metallic box, having its upper and under surfaces corrugated in concentric circles. This box or chamber being partially exhausted of air, through the short tube b , which is subsequently made air-tight by soldering, constitutes a spring, which is affected by every variation of pressure in the external atmosphere, the corrugations on its surface increasing its elasticity. At the centre of the upper surface of the exhausted chamber there is a solid cylindrical projection x , to the top of which the principal lever cde is attached. This lever rests partly on a spiral spring at d ; it is also supported by two vertical pins, with perfect freedom of motion. The end e of the lever is attached to a second or small lever f , from which a chain g extends to h , where it works on a drum attached to the axis of the hand, connected with a hair spring at h , changing the motion from vertical to horizontal, and regulating the hand, the attachments of which are made to the metallic plate i . The motion originates in the corrugated elastic box a , the surface of which is depressed or elevated as the weight of the atmosphere is increased or diminished, and this motion is communicated through the levers to the axis of

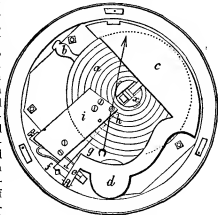

FIG. 4.—Aneroid Barometer.

Barometric readings.

the hand at *h*. The spiral spring on which the lever rests at *d* is intended to compensate for the effects of alterations of temperature. The actual movement at the centre of the exhausted box, whence the indications emanate, is very slight, but by the action of the levers is multiplied 657 times at the point of the hand, so that a movement of the 20th part of an inch in the box carries the point of the hand through three inches on the dial. The effect of this combination is to multiply the smallest degrees of atmospheric pressure, so as to render them sensible on the index. Vidie's instrument has been improved by Vaudet and Hulot. Eugène Bourdon's aneroid depends on the same principle. The aneroid requires, however, to be repeatedly compared with a mercurial barometer, being liable to changes from the elasticity of the metal chamber changing, or from changes in the system of levers which work the pointer. Though aneroids are constructed showing great accuracy in their indications, yet none can lay any claim to the exactness of mercurial barometers. The mechanism is liable to get fouled and otherwise go out of order, so that they may change 0.300 in. in a few weeks, or even indicate pressure so inaccurately and so irregularly that no confidence can be placed in them for even a few days, if the means of comparing them with a mercurial barometer be not at hand.

The mercurial barometer can be made self-registering by concentrating the rays from a source of light by a lens, so that they strike the top of the mercurial column, and having a sheet of sensitized paper attached to a frame and placed behind a screen, with a narrow vertical slit in the line of the rays. The mercury being opaque throws a part of the paper in the shade, while above the mercury the rays from the lamp pass unobstructed to the paper. The paper being carried steadily round on a drum at a given rate per hour, the height of the column of mercury is photographed continuously on the paper. From the photograph the height of the barometer at any instant may be taken. The principle of the aneroid barometer has been applied to the construction of barographs. The lever attached to the collapsible chamber terminates in an ink-fed style which records the pressure of the atmosphere on a moving ribbon. In all continuously registering barometers, however, it is necessary, as a check, to make eye-observations with a mercury standard barometer hanging near the registering barometer from four to eight times daily.

See Marvin, *Barometers and the Measurement of Atmospheric Pressure* (1901); and C. Abbe, *Meteorological Apparatus* (1888). Reference may also be made to B. Stewart and W. W. H. Gee, *Practical Physics* (vol. i. 1901), for the construction of standard barometers, their corrections and method of reading.

BAROMETRIC LIGHT, the luminous glow emitted by mercury in a barometer tube when shaken. It was first observed by Jean Picard, and formed the subject of many experiments at the hands of Francis Hawksbee. The latter showed that the Torricellian vacuum was not essential to the phenomenon, for the same glow was apparent when mercury was shaken with air only partially rarefied. The glow is an effect of the electricity generated by the friction of the mercury and the air in the barometer tube.

BARON, MICHEL (1653-1720), French actor (whose family name originally was Boyron), was born in Paris, the son of a leading actor (d. 1655) and of a talented actress (d. 1662). At the age of twelve he joined the company of children known as the *Petits Comédiens Dauphins*, of which he was the brightest star. Molière was delighted with his talent, and with the king's permission secured him for his own company. In consequence of a misunderstanding with Molière's wife, the actor withdrew from the dramatist's company, but rejoined it in 1670, reappearing as Domitien in Corneille's *Tite et Bérénice*, and in his *Psyche*. He remained in this company until Molière's death. He then became a member of the company at the *Hôtel de Bourgogne*, and from this time until his retirement in 1691 was undisputed master of the French stage, creating many of the leading rôles in Racine's tragedies, besides those in two of his own comedies, *L'Homme à bonnes fortunes* (1686), and *La Coquette* (1687). He also wrote *Les Enlèvements* (1685), *Le Débauché* (1689), and translated and acted two plays of Terence. In 1720 Baron reappeared at the Palais Royal, and his activity on the stage was

renewed in a multitude of parts. He died on the 22nd of December 1720.

His son ÉTIENNE MICHEL BARON (1676-1711) was also a fine actor, and left a son and two daughters who all played at the Comédie Française.

See George Monval, *Un Comédien amateur d'art* (1893); also the Abbé d'Allanial's *Lettres à mylord, XXX. sur Baron et la demoiselle Lecouvreur*, in F. G. J. S. Andrieux's *Collection des mémoires sur l'art dramatique* (1822).

BARON. This word, of uncertain origin, was introduced into England at the Conquest to denote "the man" (*i.e.* one who had done him "homage") of a great lord, and more especially of the king. All who held "in chief" (*i.e.* directly) of the king were alike *barones regis*, bound to perform a stipulated service, and members, in theory at least, of his council. Great nobles, whether earls or not, also spoke of their tenants as "barons," where lesser magnates spoke of their "men" (*homines*). This was especially the case in earldoms of a palatine character, such as Chester, where the earl's barons were a well-recognized body, the Venables family, "barons of Kinderton," continuing in existence down to 1679. In the palatinate of Durham also, the bishop had his barons, among whom the Hiltons of Hilton Castle were usually styled "Barons of Hilton" till extinct in 1746. Other families to whom the title was accorded, independently of peerage dignity and on somewhat uncertain grounds, were "the barons of Greystock," "the barons of Stafford," and the Cornwalls, "barons of Burford." Fantome makes Henry II. speak of "mes barons de Lundres"; John's charter granting permission to elect a mayor speaks of "our barons of our city of London," and a London document even speaks of "the greater barons of the city." The aldermen seem to have been loosely deemed equivalent to barons and were actually assessed to the poll-tax as such under Richard II. In Ireland the palatine character of the great lordships made the title not uncommon (*e.g.* the barons of Galtrim, the barons of Slane, the barons of the Naas).

As all those who held direct of the crown by military service (for those who held "by serjeanty" appear to have been classed apart), from earls downwards, were alike "barons," the great difference in their position and importance must have led, from an early date, to their being roughly divided into "greater" and "lesser" barons, and indeed, under Henry II., the *Dialogus de Scaccario* already distinguishes their holdings as "greater" or "lesser" baronies. Within a century of the Conquest, as we learn from Becket's case (1164), there arose the practice of sending to the greater barons a special summons to the council, while the lesser barons, it is stipulated in Magna Carta (1215), were to be summoned only through the sheriffs. Thus was introduced a definite distinction, which eventually had the effect of restricting to the greater barons the rights and privileges of peerage.

Thus far the baron's position was connected with the tenure of land; in theory the barons were those who held their lands of the king; in practice, they were those who so held a large amount of land. The great change in their status was effected when their presence in that council of the realm which became the House of Lords was determined by the issue of a writ of summons, dependent not on the tenure of land, but only on the king's will. Camden's statement that this change was made by Henry III. after "the Barons' War" was long and widely accepted, but it is now assigned, as by Stubbs, to Edward I., and the earliest writs accepted as creating hereditary baronies are those issued in his reign. It must not, however, be supposed that those who received such summons were as yet distinguished from commoners by any style or title. The only possible prefix at that time was *Dominus* (lord), which was regularly used by simple knights, and writs of summons were still issued to the lowest order of peers as knights (*chevaliers*) only. The style of baron was first introduced by Richard II. in 1387, when he created John de Beauchamp, by patent, Lord de Beauchamp and baron of Kidderminster, to make him "unum parium et baronum regni nostri." But it was not till 1433 that the next "baron" was created, Sir John Cornwall being then made baron of Fanhope. In spite, however, of these innovations, the former

was only summoned to parliament by the style of "John Beauchamp of Kidderminster," and the latter by that of "John Cornwall, knight." Such creations became common under Henry VI., a transition period in peerage styles, but "Baron" could not evict "Sire," "Chevalier" and "Dominus." Patents of creation contained the formula "Lord A. (and) Baron of B.," but the grantee still styled himself "Lord" only, and it is an historically interesting fact that to this day a baron is addressed in correspondence, not by that style, but as "the Lord A.," although all peers under the rank of Duke are spoken of as "lords," while they are addressed in correspondence by their proper styles. To speak of "Baron A." or "Baron B." is an unhistorical and quite recent practice. When a baron, however, is vested in a lady it is now the recognized custom to speak of her as baroness, e.g. Baroness Berkeley.

The solemn investiture of barons created by patent was performed by the king himself, by enrobing the peer in the scarlet "robe of estate" during the reading of the patent, and this form continued till 13 Jac. I., when the lawyers declared that the delivery of the letters patent without ceremony was sufficient. The letters patent express the limits of inheritance of the barony. The usual limit is to the grantee and heirs male of his body, occasionally, in default of male issue, to a collateral male relative (as in the case of Lord Brougham, 1860) or (as in the case of Lord Basset, 1797, and Lord Burton, 1807) to the heirs-male of a daughter, and occasionally (as in the case of Lord Nelson, 1801) to the heirs-male of a sister. Sometimes also (as in the case of the barony of Rayleigh, 1821) the dignity is bestowed upon a lady with remainder to the heirs-male of her body. The coronation robes of a baron are the same as those of an earl, except that he has only two rows of spots on each shoulder; and, in like manner, his parliamentary robes have but two guards of white fur, with rows of gold lace; but in other respects they are the same as those of other peers. King Charles II. granted to the barons a coronet, having six large pearls set at equal distances on the chaplet. A baron's cap is the same as a viscount's. His style is "Right Honourable"; and he is addressed by the king or queen, "Right Trusty and Well-beloved." His children are by courtesy entitled to the prefix "The Honourable."

Barons of the Exchequer were formerly six judges (a chief baron and five puisne barons) to whom the administration of justice was committed in cases between the king and his subjects relative to matters of revenue. Selden, in his *Titles of Honour*, conjectures that they were originally chosen from among the barons of the kingdom, and hence their name; but it would probably be more exact to say that they were officers of a branch of the king's *Curia*, which was theoretically composed of his "barons." The title has become obsolete since 1875, when the court of exchequer was merged in the High Court of Judicature.

Barons of the Cinque Ports (originally Hastings, Dover, Hythe, Romney and Sandwich) were at first the whole body of their freemen, who were so spoken of in royal charters. But the style was afterwards restricted to their mayors, jurats, and (prior to 1831) members of the House of Commons elected by the Cinque Ports, two for each port. Their right to the title is recognized in many old statutes, but in 1606 the use of the term in a message from the Lower House drew forth a protest from the peers, that "they would never acknowledge any man that sitteth in the Lower House to the right or title of a baron of parliament" (*Lords' Journals*). It was the ancient privilege of these "barons" to bear a canopy over the sovereign at his or her coronation and retain it as their perquisite. They petitioned as "barons of the Cinque Ports" to attend the coronation of Edward VII., and a deputation was allowed to do so.

Baron and Feme, in English law, is a phrase used for husband and wife, in relation to each other, who are accounted as one person. Hence, by the old law of evidence, the one party was excluded from giving evidence for or against the other in civil questions, and a relic of this is still preserved in the criminal law.

Baron and Feme, in heraldry, is the term used when the coats-arms of a man and his wife are borne per pale in the same

escutcheon, the man's being always on the dexter side, and the woman's on the sinister. But in this case the woman is supposed not to be an heiress, for then her coat must be borne by the husband on an escutcheon of pretence. (See *HERALDRY*.)

The foreign title of baron is occasionally borne by English subjects, but confers no precedence in the United Kingdom. It may be Russian, e.g. Baron Dimsdale (1762); German, e.g. Baron Stockmar, Baron Halkett (Hanoverian); Austrian, e.g. Baron Rothschild (1822), Baron de Worms; Italian, e.g. Baron Heath; French, e.g. Baron de Teissier; French-Canadian, e.g. Baron de Longueil (1700); Dutch, e.g. Baron Mackay (Lord Reay). (J. H. R.)

The Foreign Title.—On the continent of Europe the title baron, though the same in its origin, has come, owing to a variety of causes, to imply a rank and status very different from its connotation in the United Kingdom, and again varies considerably in different countries. Originally *baro* meant no more than "man," and is so used in the Salic and other "barbarian" laws; e.g. *Si quis mortuodit barum vel feminam, &c.* (*Lex Alem.* tit. 76). In this way, too, it was long preserved in the sense of "husband," as in the Assize of Jerusalem (MSS. cap. 98): *Si Pon appelle aucune chose femme qui aura baron, et il la veut defendre, il la peut defendre de son cors, &c.* Gradually the word seems to have come to mean a "strong or powerful man," and thus generally "a magnate." Finally, in France in the 12th century the general expression *barones* was introduced in a restricted sense, as applied properly to all lords possessing an important fief, subject to the rule of primogeniture and thus not liable to be divided up, and held of one overlord alone. Sometimes it included ecclesiastical lordships of the first rank. In the 13th century the Register of King Philip Augustus places the *barones regis Francie* next to the dukes and counts holding in chief, the title being limited to vassals of the second rank. Towards the end of the century the title had come to mean that its bearer held his principal fief direct from the crown, and was therefore more important than that of count, since many counts were only mediate vassals. Thus the kings in granting a duchy or countship as an appanage to their brothers or sons used the phrase *in comitatum et baroniam*. From this period, however, the title tends to sink in comparative importance. When, in the 14th century, the feudal hierarchy was completed and stereotyped, the barons are ranked not only below counts, but below viscounts, though in power and possessions many barons were superior to many counts. In any case, until the 17th century, the title of baron could only be borne by the holder of a territorial barony; and it was Louis XIV. who first cheapened the title in France by creating numerous barons by royal letters. This entire dissociation of the title from the idea of feudal rights and obligations was completed by Napoleon's decree of March 1, 1808, reviving the ancient titles. By this instrument the title of baron was to be borne *ex officio* by a number of high officials, e.g. ministers, senators, councillors of state, archbishops and bishops. It was given to the 37 mayors who attended the coronation, and could be claimed by any mayor who had served to the emperor's satisfaction for ten years, and by any member of an electoral college who had attended three sessions. The title was made to descend in order of primogeniture to legitimate or adopted sons and to the nephews of bishops, the sole condition being that proof must be presented of an actual income of 15,000 fr., of which one-third should descend with the title. The creation of barons was continued by Louis XVIII., Charles X. and Louis Philippe, and, suspended at the revolution of 1848, was revived again on a generous scale by Napoleon III. The tolerant attitude of the Third Republic towards titles, which it does not officially recognize, has increased the confusion by facilitating the assumption of the title on very slender grounds of right. The result has been that in France the title of Baron, unless borne by the recognized representative of a historic name, not only involves no political status, but confers also but very slight social distinction.

The same is true, *mutatis mutandis*, of most other European countries, and notably of Italy. In Austria and Germany the

case is somewhat different. Though in Latin documents of the middle ages the term *barones* for *liberi domini* was used, it was not until the 17th century that the word *Baron*, perhaps under the influence of the court of Versailles, began to be used as the equivalent of the old German *Freiherr*, or free lord of the Empire. The style *Freiherr* (*liber dominus*) implied originally a dynastic status, and many *Freiherren* held countships without taking the title of count. When the more important of them styled themselves counts, the *Freiherren* sank into an inferior class of nobility. The practice of conferring the title *Freiherr* by imperial letters was begun in the 16th century by Charles V., was assumed on the ground of special imperial concessions by many of the princes of the Empire, and is now exercised by all the German sovereigns. Though the practice of all the children taking the title of their father has tended to make that of Baron comparatively very common, and has dissociated it from all idea of territorial possession, it still implies considerable social status and privilege in countries where a sharp line is drawn between the caste of "nobles" and the common herd, whom no wealth or intellectual eminence can place on the same social level with the poorest *Adeliger*. In Japan the title baron (*Dan*) is the lowest of the five titles of nobility introduced in 1885, on the European model. It was given to the least important class of territorial nobles, but is also bestowed as a title of honour without reference to territorial possession.

See du Cange, *Glossarium*, s. "Baro" (ed. Niort, 1883); John Selden, *Titles of Honor*, p. 353 (ed. 1672); Achille Luchaire, *Manuel des institutions françaises* (Paris, 1892); Maurice Prou, art. "Baron" in *La Grande Encyclopédie*. (W. A. P.)

BARONET. Although the origin of this title has been the subject of learned speculation, it is not known for certain why it was selected as that of "a new Dignity between Barons and Knights" created by James I. The object of its institution was to raise money for the crown, and was also done by the sale of peerage dignities under this sovereign. But the money was professedly devoted to the support of troops in Ulster, that is, each grantee was to be liable for the pay of thirty men, at 8d. a day for three years. This amounted to £1095, which was the sum paid for the honour. When it was instituted, in May 1611, the king, to keep the baronetage select, covenanted that he would not create more than two hundred, and that only those who had £1000 a year in landed estate and whose paternal grandfathers had borne arms should receive the honour. But these qualifications were before long abandoned. As an inducement to apply for it, it was made to confer the prefix of "Sir" and "Lady" (or "Dame"), and was assigned precedence above knights, though below the younger sons of barons. Eight years later (30th of September 1619), the baronetage of Ireland was instituted, the king pledging himself not to create more than a hundred baronets. Meanwhile, questions had arisen as to the exact precedence of the baronets, and James by royal decree (28th of May 1612) had announced that it was his intention to rank them below the younger sons of barons. As this had the effect of stopping applications for the honour, James issued a fresh commission (18th of November 1614) to encourage them, and finally, as "the Kinges wants might be much relieved out of the vanities and ambition of the gentrie" (in Chamberlain's words), he granted, in 1616, the further privilege that the heirs apparent of baronets should be knighted on coming of age.

The baronetage of Nova Scotia was devised in 1624 as a means of promoting the "plantation" of that province, and James announced his intention of creating a hundred baronets, each of whom was to support six colonists for two years (or pay 2000 marks in lieu thereof) and also to pay 1000 marks to Sir William Alexander (afterwards earl of Stirling), to whom the province had been granted by charter in 1621. For this he was to receive a "free barony" of 16,000 acres in Nova Scotia, and to become a baronet of "his Hienes Kingdom of Scotland." James dying at this point, Charles I. carried out the scheme, creating the first Scottish baronet on the 28th of May 1625, covenanting in the creation charter that the baronets "of Scotland or of Nova Scotia" should never exceed a hundred and fifty in number, that

their heirs apparent should be knighted on coming of age, and that no one should receive the honour who had not fulfilled the conditions, viz. paid 3000 marks (£166, 13s. 4d.) towards the plantation of the colony. Four years later (17th of November 1629) the king wrote to "the contractors for baronets," recognizing that they had advanced large sums to Sir William Alexander for the plantation on the security of the payments to be made by future baronets, and empowering them to offer a further inducement to applicants; and on the same day he granted to all Nova Scotia baronets the right to wear about their necks, suspended by an orange tawny ribbon, a badge bearing an azure saltire with a crowned inescutcheon of the arms of Scotland and the motto "Fux mentis honestae gloria." As the required number, however, could not be completed, Charles announced in 1633 that English and Irish gentlemen might receive the honour, and in 1634 they began to do so. Yet even so, he was only able to create a few more than a hundred and twenty in all. In 1638 the creation ceased to carry with it the grant of lands in Nova Scotia, and on the union with England (1707) the Scottish creations ceased, English and Scotsmen alike receiving thenceforth baronetcies of Great Britain.

It is a matter of dispute whether James I. had kept faith with the baronets of England as to limiting their number; but his son soon rejected the restriction freely. Creations became one of his devices for raising money; blank patents were hawked about, and in 1641 Nicholas wrote that baronetcies were to be had for £400 or even for £350; a patent was offered about this time to Mr Wrottesley of Wrottesley for £300. On the other hand, the honour appears to have been bestowed for nothing on some ardent royalists when the great struggle began.

Cromwell created a few baronets, but at the Restoration the honour was bestowed so lavishly that a letter to Sir Richard Leveson (3rd of June 1666) describes it as "too common," and offers to procure it for any one in return for £300 or £400. Sir William Wiseman, however, is said to have given £500.

The history of the baronetage was uneventful till 1783, when in consequence of the wrongful assumption of baronetcies, an old and then increasing evil, a royal warrant was issued (6th of December) directing that no one should be recognized as a baronet in official documents till he had proved his right to the dignity, and also that those created in future must register their arms and pedigree at the Heralds' College. In consequence of the opposition of the baronets themselves, the first of these two regulations was rescinded and the evil remained unabated. Since the union with Ireland (1800) baronets have been created, not as of Great Britain or of Ireland, but as of the United Kingdom.

In 1834 a movement was initiated by Mr Richard Broun (whose father had assumed a Nova Scotia baronetcy some years before), to obtain certain privileges for the order, but on the advice of the Heralds' College, the request was refused. A further petition, for permission to all baronets to wear a badge, as did those of Nova Scotia, met with the same fate in 1836. Meanwhile George IV. had revoked (19th of December 1827), as to all future creations the right of baronets' eldest sons to claim knighthood. Mr Broun claimed it as an heir apparent in 1836, and on finally meeting with refusal, publicly assumed the honour in 1842, a foolish and futile act. In 1854 Sir J. Kingston James was knighted as a baronet's son, and Sir Ludlow Cotter similarly in 1874, on his coming of age; but when Sir Claude de Crespigny's son applied for the honour (17th of May 1895), his application was refused, on the ground that the lord chancellor did not consider the clause in the patent (1805) valid. The reason for this decision appears to be unknown.

Mr Broun's subsequent connexion with a scheme for reviving the territorial claims of the Nova Scotia baronets as part of a colonizing scheme need not be discussed here. A fresh agitation was aroused in 1897 by an order giving the sons of life peers precedence over baronets, some of whom formed themselves, in 1898, into "the Honourable Society of the Baronetage" for the maintenance of its privileges. But a royal warrant was issued on the 15th of August 1898, confirming the precedence complained of as an infringement of their rights. The above body, however,

has continued in existence as the "Standing Council of the Baronetage," and succeeded in obtaining invitations for some representatives of the order to the coronation of King Edward VII. It has been sought to obtain badges or other distinctions for baronets and also to purge the order of wrongful assumptions, an evil to which the baronetage of Nova Scotia is peculiarly exposed, owing to the dignity being descendible to collateral heirs male of the grantee as well as to those of his body. A departmental committee at the home office was appointed in 1906 to consider the question of such assumptions and the best means of stopping them.

All baronets are entitled to display in their coat of arms, either on a canton or on an inescutcheon, the red hand of Ulster, save those of Nova Scotia, who display, instead of it, the saltire of that province. The precedence of baronets of Nova Scotia and of Ireland in relation to those of England was left undetermined by the Acts of Union, and appears to be still a moot point with heralds. The premier baronet of England is Sir Hickman Bacon, whose ancestor was the first to receive the honour in 1611.

See Pixley's *History of the Baronetage*; Playfair's "Baronetage" (in *British Family Antiquity*, vols. vi.-ix.); Foster's *Baronetage*; G. E. Cokayne's *Complete Baronetage*; Nichols, "The Dignity of Baronet" (in *Herald and Genealogist*, vol. iii.) (J. H. R.)

BARONIUS, CAESAR (1538-1607), Italian cardinal and ecclesiastical historian, was born at Sora, and was educated at Veroli and Naples. At Rome he joined the Oratory in 1557 under St Philip Neri (*q.v.*) and succeeded him as superior in 1593. Clement VIII., whose confessor he was, made him cardinal in 1596 and librarian of the Vatican. At subsequent conclaves he was twice nearly elected pope, but on each occasion was opposed by Spain on account of his work *On the Monarchy of Sicily*, in which he supported the papal claims against those of the Spanish government. Baronius is best known by his *Annales Ecclesiastici*, undertaken by the order of St Philip as an answer to the *Magdeburg Centuries*. After nearly thirty years of lecturing on the history of the Church at the Vallicella and being trained by St Philip as a great man for a great work, he began to write, and produced twelve folios (1588-1607). In the *Annales* he treats history in strict chronological order and keeps theology in the background. In spite of many errors, especially in Greek history, in which he had to depend upon secondhand information, the work of Baronius stands as an honest attempt to write history, marked with a sincere love of truth. Sarpi, in urging Casaubon to write against Baronius, warns him never to charge or suspect him of bad faith, for no one who knew him could accuse him of disloyalty to truth. Baronius makes use of the words of St Augustine: "I shall love with a special love the man who most rigidly and severely corrects my errors." He also undertook a new edition to the Roman martyrology (1586), which he purified of many inaccuracies.

His *Annales*, which end in 1198, were continued by Rinaldi (9 vols., 1676-1677); by Laderchi (3 vols., 1728-1737); and by Theiner (3 vols., 1856). The most useful edition is that of Mansi (38 vols., Zucca, 1738-1759), giving Pagi's corrections at the foot of each page. (E. TN.)

BARONY, the domain of a baron (*q.v.*). In Ireland counties are divided into "baronies," which are equivalent to the "hundreds" (*q.v.*) in England, and seem to have been formed out of the territories of the Irish chiefs, as each submitted to English rule (General Report of the Census of England, iv. 187, 1873). In Scotland the term is applied to any large freehold estate even when held by a commoner. Barony also denotes the rank or dignity of a baron, and the feudal tenure "by barony."

BAROQUE, a technical term, chiefly applicable to architecture, furniture and household decoration. Apparently of Spanish origin—a *barruoco* is a large, irregularly-shaped pearl—the word was for a time confined to the craft of the jeweller. It indicates the more extravagant fashions of design that were common in the first half of the 18th century, chiefly in Italy and France, in which everything is fantastic, grotesque, florid or incongruous—irregular shapes, meaningless forms, an utter lack of restraint and simplicity. The word suggests much the same order of ideas as rococo.

BAROSS, GABOR (1848-1892), Hungarian statesman, was born at Trencsén on the 6th of July 1848, and educated at Esztergom. He was for a time one of the professors there under Cardinal Kolos Vaszary. After acquiring considerable local reputation as chief notary of his county, he entered parliament in 1875. He at once attached himself to Kálmán Tisza and remained faithful to his chief even after the Bosnian occupation had alienated so many of the supporters of the prime minister. It was he who drew up the reply to the malcontents on this occasion, for the first time demonstrating his many-sided ability and his genius for sustained hard work. But it was in the field of economics that he principally achieved his fame. In 1883 he was appointed secretary to the ministry of ways and communications. Baross, who had prepared himself for quite another career, and had only become acquainted with the civilized West at the time of the Composition of 1867, mastered, in an incredibly short time, the details of this difficult department. His zeal, conscientiousness and energy were so universally recognized, that on the retirement of Gábor Kemény, in 1886, he was appointed minister of ways and communications. He devoted himself especially to the development of the national railways, and the gigantic network of the Austro-Hungarian railway system and its unification is mainly his work. But his most original creation in this respect was the zone system, which immensely facilitated and cheapened the circulation of all wares and produce, and brought the remotest districts into direct communication with the central point at Budapest. The amalgamation of the ministry of commerce with the ministry of ways in 1889 further enabled Baross to realize his great idea of making the trade of Hungary independent of foreign influences, of increasing the commercial productiveness of the kingdom and of gaining every possible advantage for her export trade by a revision of tolls. This patriotic policy provoked loud protests both from Austria and Germany at the conference of Vienna in 1890, and Baross was obliged somewhat to modify his system. This was by no means the only instance in which his commercial policy was attacked and even hampered by foreign courts. But wherever he was allowed a free hand he introduced epoch-making reforms in all the branches of his department, including posts, telegraphs, &c. A man of such strength of character was not to be turned from his course by any amount of opposition, and he rather enjoyed to be alluded to as "the iron-handed minister." The crowning point of his railway policy was the regulation of the Danube at the hitherto impassable Iron-Gates Rapids by the construction of canals, which opened up the eastern trade to Hungary and was an event of international importance. It was while inspecting his work there in March 1892 that he caught a chill, from which he died on the 8th of May. The day of his burial was a day of national mourning, and rightly so, for Baross had dedicated his whole time and genius to the promotion of his country's prosperity.

See László Petrovics, *Biography of Gabriel Baross* (Hung. Eperies, 1892). (R. N. B.)

BAROTAC NUEVO, a town of the province of Iloilo, Panay, Philippine Islands, near the Jalaur river, above its mouth on the S.E. coast, and about 15 m. N.E. of Iloilo, the capital. Pop. (1903) 9904; in 1903 after the census had been taken the neighbouring town of Dumangas (pop. 12,428) was annexed to Barotac Nuevo. The town lies in a fertile plain and deals in rice, trepang and pina. Here, in what was formerly Dumangas, are a fine church and convent, built of iron, pressed brick and marble. Dumangas was destroyed by fire in June 1900, during a fight with insurgents, but its rebuilding was begun in May 1901.

BAROTSE, BAROTSELAND, a people and country of South Central Africa. The greater part of the country is a British protectorate, forming part of Rhodesia. The Barotse are the paramount tribe in the region of the Upper Zambezi basin, but by popular usage the name is also applied to contiguous subject tribes, Barotse-land being the country over which the Barotse paramount chief exercises authority. The present article treats (1) of the people, (2) of the country, (3) of the establishment of the British protectorate and of subsequent developments.

1. *The Barotse*.—These people, originally known as Aälu, have

occupied the extensive plain through which the Zambezi passes from 14° 35' S. to 16° 25' S. throughout the reigns of twenty-two successive paramount chiefs and therefore approximately since the commencement of the 17th century. Previously, for an indefinite period, they dwelt on the Kabompo river, 200 m. to the N.E. of their present country, and here the descendants of a section of the tribe which did not migrate still remain, under the name Balokwakwa (men of the ambuscade), formerly known as Ailukolui. That the Barotse at a still more remote period emigrated from the far north-east is indicated by vague tradition as well as by a certain similarity in type and language to some tribes living in that direction, though the fact that natives from Mashonaland can understand those at Lialui (the Barotse capital) has led to the assumption by some writers that the Barotse are an offshoot of the Mashona. The variety in type among the Mashona and the homogeneity of the Barotse would rather point to an opposite conclusion.

Early in the 19th century a section of the Basuto tribe known as Makololo trekked from the south of what is now the Orange River Colony and fought their way through Bechuanaaland and the Kalahari to the land of the Barotse, whom they ultimately subdued. Their chief, Sebituane, who as an administrator and general was far in advance of his contemporaries, established the rule of his house for some forty years, until about 1865 an organized rebellion of the Barotse led to the almost complete extinction of this Makololo oligarchy and the reinstatement of the original dynasty. It was the Makololo who gave the Barotse their present name (Rotse, plain—*Barotse*, country of the plain—*Murotse*, man of the plain—*Marotse*, people of the plain, the latter being inaccurately rendered *Barotse*, *Ba* being the equivalent of *Ma* in certain other languages).

The Barotse proper are comparatively few in number, but as is inferred from the fact that for many generations they have held in sway a country two and a half times the size of Great Britain, they are the intellectual and physical superiors of the vast majority of the negro races of Africa. Very black, tall in stature, deep in chest and comparatively speaking refined in feature, a Barotse is readily distinguishable amidst a mixed group of natives. Being numerically small they form an oligarchy in which, with few exceptions, each man holds rank in a chieftainship of which there are three grades. Next to the chiefs rank their descendants who have not themselves acquired chief's rank and hold an intermediate position as freeborn; all others, whether members of the subject-tribes or prisoners of war, being, up to 1906, mere slaves. This class was also graded. Slaves might own slaves who in their turn might own slaves, the highest grade always being directly responsible to some Barotse chief. As a reward of gallantry or ability the paramount chief occasionally conferred chief's rank on individuals not of Barotse birth, and these *ipso facto* assumed the name and privileges of the Barotse. It was a counterpart of the feudal system of Europe in which every grade from king to serf found a place. In 1906 the paramount chief, by proclamation, abolished the state of slavery, an act which, however, left untouched the predominant position of the Barotse and their rights to chieftainship. The paramount chief shares with a queen (*Mokwai*) his authority and prerogatives. The *Mokwai* is not the wife but the eldest sister of the ruling chief. With his death her privileges lapse. Theoretically, these co-rulers are equal, neither may promulgate a national decree without the assent of the other, but each has a capital town, councillors and absolute authority in a province, the two having joint authority over all other provinces. In their code of laws the Barotse show an advance on the standard of probably any other African negro state. By right, an accused chief is tried by his peers, each of whom in rotation from junior to senior gives his verdict, after which the president reports the finding of the court to the paramount chief, who passes sentence. As to their religious beliefs the Barotse imagine the sun to be the embodiment of a great god whose sole care is for the amelioration of man. Him they worship, though more pains are taken to appease evil spirits, in whose existence they also believe, to whom every evil to which man is heir is attributed.

The spirits of ancestors—especially of deceased chiefs—are also objects of worship. Christianity, of a Protestant evangelical type, was first introduced into the country in 1884 by François Coillard and has made some progress among the people, among the converts being Letia, eldest son and heir of Lewanika, the paramount chief.

2. *Barotse-land*.—This term includes, in the sense of the country in which the authority of the paramount Barotse chief is acknowledged, not only the lands of the Barotse proper, but the territory of fifteen contiguous and subject tribes. This vast territory extends approximately from the Kwito river in the west to the Kafue river in the east, and from the Congo-Zambezi watershed in the north to the Linyante or Kwando river and Zambezi in the south, and may be divided into three groups:—

(a) Central provinces directly administered by the paramount chief from the capital Lialui (a town on the Zambezi), by the *Mokwai* from Nalolo, and by two chiefs of the blood from Sesheke;

(b) Outlying provinces over which, in the absence of a central local system of government, Barotse chiefs administer districts under the direction of the paramount chief; and

(c) Tribes over which the local chiefs are permitted to retain their position subject to the payment of annual tribute and to their doing homage in person at Lialui when called upon to do so.

With the publication of the king of Italy's award in 1905 in the Anglo-Portuguese Barotse Boundary dispute (see below), the term *Barotse-land* may be said to have acquired a second meaning. By this award the western and part of the northern section of *Barotse-land* as described above were declared to be outside the dominion of the paramount chief and therefore not in the British sphere of influence, while tribal boundaries were complicated by the introduction of a longitudinal and latitudinal frontier. Though this award altered the political boundaries, ethnologically *Barotse-land* remains much as above described. The area of the country under British protection is about 182,000 sq. m.

Excluding the ridge of high ground running east and west which, culminating at a height of 5000 ft., forms the Congo-Zambezi water-parting, the extreme east (Batoka) and the district in the immediate vicinity of the Victoria Falls (*q.v.*) throughout which, with local variations, a red laterite clay predominates, the main physical features of *Barotse-land* may be described as a series of heavy white sand undulations covered with sub-tropical forest vegetation. These are intersected by alluvium-charged valleys through which streams and rivers flow inwards towards the central basin of the Upper Zambezi. There is evidence that this has at one time been the site of a large lake. These valleys, which towards the close of the wet season become inundated, afford rich cattle pasture, the succulence of which prevents cattle losing condition towards the end of the dry season, as is the case in many parts of Africa. There seems to be little or no indication of mineral wealth in the white sand area, but in the north and east there is not only every prospect of a great agricultural and pastoral future but also of considerable mining development. Though basalt predominates in the neighbourhood of the Victoria Falls and large fields of granite crop up on the Batoka plateau and elsewhere, there is every indication of the existence of useful minerals in these districts. Gold, copper, tin, lead, zinc and iron have been discovered.

Much of the area of *Barotse-land* is within the healthy zone, the healthiest districts being the Batoka and Mashikolumbe plateaus in the east with extreme altitudes of 4400 and 4150 ft. respectively, and the line of the Congo-Zambezi watershed which rises to 5000 ft. in many places. The Zambezi valley from the Victoria Falls (3000 ft.) to the Kabompo confluence (3500 ft.), though involving little or no risk to health to the traveller, cannot be considered suitable for white settlement. Taking into consideration the relative value of altitude to latitude, the plateau-land of *Barotse-land* compares very favourably with existing conditions elsewhere, being several degrees more temperate than would be expected. Approximately the mean

maximum and minimum temperatures stand at 80° and 55° F. respectively, with an extreme range of 100° to 35° and a mean annual temperature of 68° to 70°. The rainfall varies according to district from 22 to 32 in. a year and has shown extraordinary stability. Since 1884, the first year in which a record was taken by François Coillard, Barotseland has known no droughts, though South Africa has suffered periodically in this respect.

The Zambezi, as would be expected, forms a definite boundary line in the distribution of many species of fauna and flora. In these respects, as well as from an ethnological standpoint, Barotseland essentially belongs not to South but to Central Africa. The great river has also served to prevent the spread from South Africa into Barotseland of such disastrous cattle diseases as tick fever and lung sickness.

3. *The Establishment of British Suzerainty.*—By the charter granted to the British South Africa Company in October 1889, the company was allowed to establish its rule in the regions north of the Middle Zambezi not included in the Portuguese dominions, and by a treaty of the 11th of June 1891 between Great Britain and Portugal it was declared that the Barotse kingdom was within the British sphere of influence. The dispute between the contracting powers as to what were the western limits of Barotseland was eventually referred to the arbitration of the king of Italy, who by his award of the 30th of May 1905, fixed the frontier at the Kwando river as far north as 22° E., then that meridian up to the 13° S., which parallel it follows as far east as 24° E., and then that meridian to the Belgian Congo frontier. In the meantime the British South Africa Company had entered into friendly relations with Lewanika (*q.v.*), the paramount chief of the Barotse, and an administrator was appointed on behalf of the company to reside in the country. A native police force under the command of a British officer was raised and magistrates and district commissioners appointed. In the internal affairs of the Barotse the company did not interfere, and the relations between the British and Barotse have been uniformly friendly. The pioneers of Western civilization were not, however, the agents of the Chartered Company, but missionaries. F. S. Arnot, an Englishman, spent two years in the country (1882-1884) and in 1884 a mission, fruitful of good results, was established by the Société des Missions Évangéliques de Paris. Its first agent was François Coillard (1834-1904), who had previously been engaged in mission work in Basutoland and who devoted the rest of his life to the Barotse. Though always an admirer of British institutions and anxious that the country should ultimately fall under British jurisdiction, Coillard in the interests of his mission was in the first instance anxious to delay the advent of white men into the country. It was contrary to his advice that Lewanika petitioned the "Great White Queen" to assume a protectorate over his dominions, but from the moment Great Britain assumed responsibility and the advance of European civilization became inevitable, all the influence acquired by Coillard's exceptional personal magnetism and singleness of purpose was used to prepare the way for the extension of British rule. Only those few pioneers who knew the Barotse under the old conditions can fully realise what civilization and England owe to the co-operation of this high-minded Frenchman.

Under the Chartered Company's rule considerable progress has been made in the development of the resources of the country, especially in opening up the mining districts in the north. The seat of the administration, Kalomo, is on the "Cape to Cairo" railway, about midway between the Zambezi and Kafue rivers. The railway reached the Broken Hill copper mines, 110 m. N. of the Kafue in 1906, and the Belgian Congo frontier in 1910. From Lobito Bay in Portuguese West Africa a railway was being built in 1909 which would connect with the main line near the Congo frontier. This would not only supply Barotseland with a route to the sea alternative to the Beira and Cape Town lines, but while reducing the land route by many hundred miles would also supply a seaport outlet 1700 m. nearer England than Cape Town and thus create a new and more rapid mail route to southern Rhodesia and the Transvaal. The Zambezi also, with Kebrabasa

as its one bar to navigation between Barotseland and the sea, will supply a cheap line of communication. (See RHODESIA.)

See David Livingstone, *Missionary Travels and Researches in South Africa* (London, 1857); Major Serpa Pinto, *How I crossed Africa* (London, 1881); F. Coillard, *On the Threshold of Central Africa* (London, 1897); Major A. St. H. Gibbons, *Exploration and Hunting in Central Africa* (London, 1898); *Africa South to North through Barotseland* (London, 1904); "Journeys in Barotseland," *Geographical Journal*, 1897; "Travels in the Upper Zambezi Basin," *Geographical Journal*, 1901; A. Bertrand, *Aux pays des Barotse, haut Zambèze* (Paris, 1898); Col. Colin Harding, *In Remotest Barotseland* (London, 1905); C. W. Mackintosh, *Coillard of the Zambezi* (London, 1907), with a bibliography; L. Declé, *Three Years in Savage Africa* (London, 1898). Consult also the annual reports of the British South Africa Company, published in London. (A. St. H. G.)

BAROUCHE (Ger. *barsuche*, Span. *barrocho*, Ital. *baroccio*; from Lat. *bi-rotus*, double-wheeled), the name of a sort of carriage, with four wheels and a hood, arranged for two couples to sit inside facing one another.

BARQUISIMETO, a city of western Venezuela, capital of the state of Lara, on the Barquisimeto river, 101 m. by rail S.W. of Tucacas, its port on the Caribbean coast. Pop. (est. 1890) 40,000. It is built in a small, fertile valley of the Merida Cordilleras, 1985 ft. above sea-level, has a temperate, healthy climate with a mean annual temperature of 78° F., and is surrounded by a highly productive country from which are exported coffee, sugar, cacao and rum. It is also an important distributing centre for neighbouring districts. The city is the seat of a bishopric, is regularly laid out and well built, and is well provided with educational and charitable institutions. Barquisimeto was founded in 1522 by Juan de Villegas, who was exploring the neighbourhood for gold, and it was first called Nueva Segovia after his native city. In 1807 its population had risen to 15,000, principally through its commercial importance, but on the 26th of March 1812 it was totally destroyed by an earthquake, and with it 1500 lives, including a part of the revolutionary forces occupying the town. It was soon rebuilt and is one of the few cities of Venezuela which have recovered from the ravages of the war of independence and subsequent disorders.

BARR, a town of Germany, in the imperial province of Alsace-Lorraine, on the Kirneck, 13 m. N. from Schlettstadt by rail. It has an Evangelical and a Roman Catholic church and considerable tanneries. There is an active trade in wine and timber. Pop. (1900) 5243.

BARRA, or **BARRAY** (Scand. *Baraey*, isle of the ocean), an island of the outer Hebrides, Inverness-shire, Scotland. Pop. (1901) 2362. It lies about 5 m. S.W. of South Uist, is 8 m. in length and from 2 to 4 m. in breadth, save at the sandy isthmus 2 m. below Scurral Point, where it is only a few hundred yards broad. The rock formation is gneiss. The highest hill is Heaval (1260 ft.) and there are several small lochs. The chief village is Castlebay, at which the Glasgow steamer calls once a week. This place derives its name from the castle of Kishmul standing on a rock in the bay, which was once the stronghold of the M'Neills of Barra, one of the oldest of Highland clans. There are remains of ancient chapels, Danish duns and Druidical circles on the island. There is communication by ferry with South Uist. The parish comprises a number of smaller islands and islets—among them Frida, Gighay, Hellisay, Flodda to the N.E., and Vatersay, Pabbay, Mingalay (pop. 135) and Berneray to the S.E.—and contains 4000 acres of arable land and 18,000 acres of meadow and hill pasture. The cod, ling and herring fisheries are important, and the coasts abound with shell-fish, especially cockles, for which it has always been famous. On Barra Head, the highest point of Berneray, and also the most southerly point of the outer Hebrides chain, is a light-house 680 ft. above high water.

BARRACKPUR, a town and magisterial subdivision of British India, in the district of Twenty-four Parganas, Bengal. The town is the largest cantonment in Lower Bengal, having accommodation for two batteries of artillery, the wing of a European regiment and two native battalions. Its name is said to be derived from the fact of troops having been stationed here since 1772. It is a station on the Eastern Bengal railway. Job

Charnock, the founder of Calcutta, erected a bungalow and established a small bazaar here in 1680. The cantonment is situated on the left bank of the Hugli; it has also a large bazaar and several large tanks, and also a parade ground. To the south of the cantonment is situated the park, created by the taste and public spirit of Lord Wellesley. Within the park is situated the Government House, a noble building begun by Lord Minto, and enlarged into its present state by the marquis of Hastings. The park is beautifully laid out, and contains a small menagerie. Its most interesting feature is now Lady Canning's tomb. Barrackpur played an important part in the two Sepoy mutinies of 1824 and 1857; but the details of these belong to the general history of British rule in India. North Barrackpur had a population in 1901 of 12,600 and south Barrackpur of 19,307.

Barrackpur subdivision was formed in 1904. It contains an area of 190 sq. m., which, at the census of 1901, had a population of 206,311, a large proportion being workers in the mills on the left bank of the Hugli.

BARRACKS (derived through the French from the Late Lat. *barra*, a bar), the buildings used for the accommodation of military or naval forces, including the quarters for officers, warrant officers, non-commissioned officers and men, with their messes and recreation establishments, regimental offices, shops, stores, stables, vehicle sheds and other accessory buildings for military or domestic purposes. The term is usually applied to permanent structures of brick or stone used for the peace occupation of troops; but many hut barracks of corrugated iron lined with wood have been built, generally in connexion with a training ground for troops, and in these the accommodation given is somewhat less than in permanent barracks, and conditions more nearly approach those of a military encampment.

British System.—The accommodation to be given in British military barracks is scheduled in the *Barrack Synopsis*, which contains "statements of particulars, based upon decisions which have, from time to time, been laid down by authority, as regards the military buildings authorized for various units, and the accommodation and fittings to be provided in connexion therewith." Each item of ordinary accommodation is described in the synopsis, and the areas and cubic contents of rooms therein laid down form the basis of the designs for any new barrack buildings. Supplementary to the synopsis is a series of "Standard Plans," which illustrate how the accommodation may be conveniently arranged; the object of the issue of these plans is to put in convenient form the best points of previous designs, and to avoid the necessity of making an entirely fresh design for each building that is to be erected, by using the standard type modified to suit local conditions. External appearance is considered with regard to the materials to be used, and the position the buildings are to occupy; convenience of plan and sound sanitary construction being the principal objects rather than external effect, designs are usually simple, and depend for architectural effect more on the grouping and balance of the parts than on ornamentation such as would add to expense. The synopsis and standard plans are from time to time revised, and brought up to date as improvements suggest themselves, and increases in scale of accommodation are authorized, after due consideration of the financial effect; so that systematic evolution of barrack design is carried on.

Modern British Barracks.—A description of a modern barrack for a battalion of infantry will give an idea of the standard of accommodation which is now authorized, and to which older barracks are gradually remodelled as funds permit. The unmarried soldiers are quartered in barrack-rooms usually planned to contain twelve men in each; this number forms a convenient division to suit the organization of the company, and is more popular with the men than the larger numbers which were formerly the rule in each barrack-room; there is a greater privacy, whilst the number is not too small to keep up the feeling of barrack-room comradeship which plays an important part in the soldier's training. The rooms give 600 cub. ft. of air per man, and have windows on each side: the beds are spaced between the windows so that only one bed comes in a corner, and

not more than two between any two windows: inlet ventilators are fixed high up in the side walls, and an extract shaft warmed by the chimney flue keeps up a circulation of air through the room: the door is usually at one end of the room and the fireplace at the opposite end: over each man's bed is a locker and shelf where he keeps his kit, and his rifle stands near the head of his bed. Convenient of access from the door to the barrack-room is the ablution-room with basins and foot-bath; also disconnected by a lobby is a water-closet and urinal for night use, others for day use being provided in separate external blocks. Baths are usually grouped in a central bath-house adjacent to the cook-house, and have hot water laid on. For every two or four barrack-rooms, a small single room is provided for the occupation of the sergeant in charge, who is responsible for the safety of a small store, where men may leave their rifle and kit when going on furlough. Adjacent to the barrack blocks and next to the cook-house are arranged the dining-rooms where the men assemble for their meals; no food is now served in the barrack-rooms, and the air in them is thus kept much purer and fresher than under the old

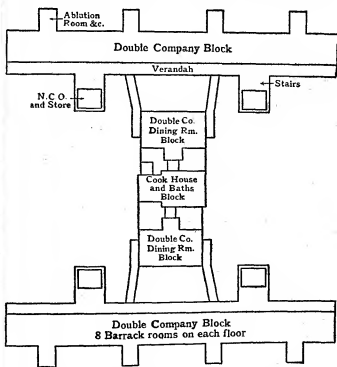

system. The dining-rooms are lofty and well ventilated, and are warmed by hot water; tables and forms are arranged so as to make the most of the space, and room is provided for all the men to dine simultaneously.

Next to the dining-room is the cook-house where the meals for a half battalion are cooked, and served direct to the dining-rooms on each side. Wash-up rooms are arranged off the serving-lobby with plate-racks and shelves for the storage of the crockery after it has been washed. The cooking apparatus is designed for economical use of coal fuel, and, if carefully used, consumes little more than $\frac{1}{2}$ lb of coal per man per day. The cook-house is well lighted and ventilated by a top lantern; tables, dressers, and pastry slab are provided for preparing and serving the meals, and a sink for washing kitchen utensils. Under the kitchen block is a basement containing the boiler for heating the dining-rooms and another for the supply of hot water to baths and sinks, with in some cases also a hot-air furnace for heating drying-rooms, for drying the men's clothing when they come in wet from a route-march or field day. Not far from the barrack blocks is placed the recreation establishment or soldiers' club, where the rank and file may go for relaxation and amusement when off duty; this establishment has, on the ground floor, a large and lofty room with a stage at one end for lectures or entertainments, and at the other

end is a supper bar, extending across the room, where mineral waters and other light refreshments are sold; tables are also arranged for suppers. A grocery shop is provided where the men and their families may purchase goods bought under regimental arrangements at wholesale prices, and sold without more profit than is necessary to keep the institution self-supporting. On the first floor are billiard and games room, reading-room and library, and writing-room. The manager's quarter and kitchen premises complete the establishment. Near the recreation establishment is the canteen, devoted solely to the sale of beer, and not permitted to vie in attractiveness with the recreation establishment. A bar is provided for the soldiers, a separate room for corporals, and a jug department for the supply of the families; this building also has a manager's quarter attached to it, and an office for the checking of accounts.

For the senior non-commissioned officers a sergeants' mess is provided, containing dining-room, reading-room and billiard-room, with kitchen premises and liquor store, which also has a jug department for the sergeants' families. The single non-commissioned officers have all their meals in this mess, and the married members also use it as a club. The warrant officers, and the proportion of non-commissioned officers and men who are on the married establishment, are provided with accommodation at some little distance from the men's barracks. In all recent schemes, on open sites, self-contained cottages have been built, and these are more popular than the older pattern of tenement buildings approached by common staircases or verandahs. The warrant officers are allowed a living-room, kitchen, and scullery, with three bedrooms and a bathroom. The married soldiers have a living-room, scullery, and one, two, or three bedrooms according to the size of their families. A laundry is provided adjacent to the married quarters, equipped with washing-troughs, wringer, drying-closet, and ironing-room; and the women are encouraged to use this in preference to doing washing in their cottages.

Officers' Quarters.—At a little distance from the men's barracks, and usually looking over the parade or cricket ground, is the officers' mess. This building has an entrance-hall with band alcove, where the band plays on guest nights; on one side of the hall is the mess-room (or dining-room), and on the other the ante-room (or reading-room), whilst the billiard-room and kitchen are kept to the back so that lantern lights can be arranged for. A mess office is provided, and all the accessories required for the mess waiters' department, including pantry, plate-closet and cellars, and for the kitchen or mess-man's department, with also a quarter for the mess-man. The officers' quarters are usually arranged in wings extending the frontage of the mess building, and in a storey over the mess itself. Each officer has a large room, part of which is partitioned off for a bedroom, and the field officers are allowed two rooms. The soldier servant, told off to each officer, has a small room allotted for cleaning purposes, and bathrooms, supplied with hot water from the mess kitchen, are centrally situated. A detached house, containing three sitting-rooms, seven bed- and dressing-rooms, bathroom, kitchen, servants' hall, and the usual accessories, is provided for the commanding officer; also a smaller house, having two sitting-rooms, four bedrooms, bath, kitchen, &c., for the quartermaster. Other regimental married officers are not provided for, and have to arrange to house themselves, a lodging allowance being usually granted.

Regimental Accessories.—Apart from the buildings providing accommodation, others are required for administrative and military purposes. These are the guard house and regimental offices, the small-arm ammunition store, the fire-engine house, the drill and gymnastic hall, and the medical inspection block with dispensary, where the sick are seen by a medical officer and either prescribed for or sent into hospital, as may be necessary. Stables are provided for the officers' and transport horses, and a vehicle shed and storehouse for the mobilization equipment. Stores are required for bread, meat, coal, clothing, and for musketry, signalling, and general small stores under the quartermaster's charge—also workshops for armourers, carpenters, plumbers, painters and glaziers, shoemakers, and tailors. Mention of the

five court, recreation ground and parade ground completes the description of a battalion barracks.

Cavalry Barracks.—The accommodation provided for cavalry is very similar to that already described for infantry. The barrack blocks are arranged to suit the organization of the regiment, and are placed so that the men can turn out readily and get to their horses. Detached buildings are provided for cavalry troop stables, one block for the horses of each troop. Formerly stables were often built for convenience with the barrack-rooms over them; but this system has been abandoned on sanitary grounds, to the benefit of both men and horses. Each horse is given 1500 cub. ft. of air space, the horses' heads are turned to the outer walls, and provision is made, by traversed air-ducts below the mangers, for fresh air to be supplied to the horses while lying down. Above the horses' heads are windows which are arranged to open inwards, being hinged at the bottom and fitted with hopper cheeks to avoid direct draught. Ridge ventilation and skylights are given, so that all parts of the stable are well lighted and airy.

Cast-iron mangers and hay-racks are provided, and the horses are separated by bails, with chains to manger brackets and heel posts; saddle brackets are fixed to the heel posts. Each stable has a troop store, where spare saddles and gear are kept; also an expense forage store, in which the day's ration, after issue in bulk from the forage barn, is kept until it is given out in feeds. The stables are paved with blue Staffordshire paving bricks, graded to a collecting channel carrying the drainage well clear of the building, before it is taken into a gully.

The space-between the blocks of stables is paved with cement concrete to form a yard, and horse-troughs, litter-sheds and dung-pits are provided. Officers' stables are built in separate blocks, and usually have only one row of stalls; the stalls are divided by partitions, and separate saddle-rooms are provided. Stalls and loose boxes in infirmary stables give 2000 cub. ft. of air space per horse and are placed at some distance from the troop stables in a separate enclosure. A forge and shoeing shed is provided in a detached block near the troop stables. A forage barn and granary is usually built to hold a fortnight's supply, and a chaff-cutter driven by horse power is fixed close by. Cavalry regiments each have a large covered riding school, and a number of open *manèges*, for exercise and riding instruction.

Artillery, &c.—The accommodation provided for horse and field artillery is arranged to suit their organization in batteries and brigades, and is generally similar to that already described, with the addition of vehicle sheds for guns and ammunition wagons, and special shops for wheelers and saddlers. Accommodation for other units follows the general lines already laid down, but has to be arranged to suit the particular organization and requirements of each unit.

Garrison Accessories.—In every large military station in addition to the regimental buildings which have been described, a number of buildings and works are required for the service of the garrison generally. *Military hospitals* are established at home and abroad for the treatment of sick officers and classified as well as their wives and families. Military hospitals are divided as follows:—First-grade hospitals are large central hospitals serving important districts. These hospitals are complete in themselves and fully equipped for the carrying out of operations of all kinds; they generally contain wards for officers, and may have attached to them separate isolation hospitals for the treatment of infectious cases, and military families' hospitals for women and children. Second-grade hospitals are smaller in size and less fully equipped, but are capable of acting independently and have operation rooms. Third-grade hospitals or reception stations are required for small stations principally, to act as feeders to the large hospitals, and to deal with accident and non-transportable cases. The principles of construction of military hospitals do not differ materially from the best modern civil practice; all are now built on the pavilion system with connecting corridors arranged so as to interfere as little as possible with the free circulation of air between the blocks. The site is carefully selected and enclosed with railings. The administration block

is centrally placed, with ward blocks on each side, and accessory buildings placed where most convenient; the isolation wards are in a retired position and divided off from the hospital enclosure. Ward blocks usually have two storeys, and the ordinary large wards provide 1200 cub. ft. of air space per patient. A due proportion of special cub. and other special wards is arranged in which the space per patient is greater or less, as necessary.

Army schools are built to give slightly more liberal accommodation than is laid down as the minimum by the Board of Education, but the principles of planning are much the same as in civil elementary schools. Schools are usually placed between the married quarters and the barracks, so as to serve both for the instruction of the men, when working for educational certificates, and for the education of the children of the married soldiers. *Garrison churches* are built when arrangements for the troops to attend divine service at neighbouring places of worship cannot well be made. Only two *military prisons* now remain, viz. Dover and Curragh, and these are for soldiers discharged from the service with ignominy. For ordinary sentences *détention barracks* and *branch detention barracks* are attached to the military commands and districts: these are constructed in accordance with the home office regulations; but crime in the army fortunately continues to decrease, and little accommodation has recently been added. Barrack expense stores for the issue of bedding, utensils and other stores for which the troops depend upon the Army Service Corps, are necessary in all barracks; and in large stations a supply depot for the issue of provisions, with abattoir and bakery attached to it, may be necessary. An engineer office with building yard and workshops to deal with the ordinary duties in connexion with the upkeep of War Department property is required at every station, and for large stations such as Aldershot, it may be necessary to undertake special water supply schemes, works for disposal of sewage, and for the supply of electricity or gas for lighting the barracks. The system of roads, pipes and mains within the barracks are in all cases maintained by the Royal Engineers, as well as the buildings themselves. District and brigade offices are necessary for the administration of large units, and quarters for the general officer commanding and the headquarters staff may sometimes be required.

Location of Barracks.—The selection of a healthy site for a barrack building or new military station is a matter of great importance. In the earlier days of barrack construction, barracks were, for political reasons, usually built in large towns, where troops would be at hand for putting down disturbances, and cramped and inconvenient buildings of many storeys, were erected on a small piece of ground often surrounded by the worst slums of the city; such, for example, were the Ship Street barracks in Dublin, and the cavalry barracks at Hulme, Manchester. Worse still were cases where an existing building, such as the Linen Hall in Dublin, was purchased, and converted into barracks with little regard for the convenience of the occupants, and a total disregard for the need of a free circulation of pure air in and about the buildings, which is the first condition of health. In the present day, except in a few cases where strong local influence is allowed to prevail to retain troops in towns, where their presence, and perhaps the money they spend, are appreciated for patriotic or other motives, every opportunity is taken to move troops from the vicinity of crowded towns, and quarter them in barracks or hutments built in the open country. Due regard can then be given to sanitary location, and military training can more effectively be carried out. With improvements in communication by rail, road and telegraph, support to the civil power in case of disturbance can always be afforded in good time, without permanently stationing troops in the actual locality where their assistance may be needed. It has been recognized ever since the Crimean War, that the leading principle of barrack policy must, in the future, be to facilitate in peace time the training of the army for war, and that this can only be done by quartering troops in large bodies, including all branches of the service, in positions where they have space for training,

gun and rifle practice, and manœuvring. The camps at Aldershot, Colchester, Shorncliffe and Curragh were accordingly started between 1856 and 1860, and the same policy has since been continued by the acquisition of Strensall Common, near York, Kilworth domain, near Fermoy, the lease of a portion of Dartmoor and a large area at Glen Imaal in Co. Wicklow, and the purchase of the Stobs estate in Scotland and of a large part of Salisbury Plain.

Barrack Construction.—The history of barrack construction in Great Britain is an interesting study, but can only be touched on briefly. As long as operations in the field were carried on by troops levied especially for the war in hand, no barracks apart from fortifications were required, except those for the royal bodyguard; and even after the standing army exceeded those limits, the necessity for additional barracks was often avoided by having recourse to the device of billeting, i.e. quartering the soldiers on the populations of the towns where they were posted. This, however, was a device burdensome to the people, subversive of discipline, and prejudicial to military efficiency in many ways, while it exposed the scattered soldiers to many temptations to disloyalty. Hence barracks were gradually provided, at first in places where such an arrangement was most necessary owing to the paucity of the population, or where concentration of troops was most important, owing to the disaffection of some of the inhabitants. The earliest barracks of which there is any record as regards England, were those for the foot guards, erected in 1660. Among the earliest of those still existing are the Royal Barracks at Dublin, dating from 1700, and during the 18th century barracks were built in several parts of Ireland; but in England it was at the end of the 18th and beginning of the 19th century that most of the earlier barracks were constructed. So long as barracks were mainly in connexion with fortresses their construction naturally fell to the duty of the King's Engineers, afterwards the Corps of Engineers, working under the master-general of the ordnance. About 1796, however, a special civil department was formed under the commissioners for the affairs of barracks, to deal with barracks apart from fortifications. In 1816 we find a warrant appointing a civilian comptroller of the barrack department to deal with the erection and upkeep of barracks and barrack hospitals not within fortified places. This warrant gives one of the earliest records of the nature of accommodation provided, and a few extracts from it are worth notice. No definite regulations as to cubic or floor space per man are laid down; but in the infantry, twelve men, and in the cavalry, eight men are allotted to one room. "Bedsteads or berths" are allowed, "a single one to each man, or a double one to two men," or "hammocks where necessary." The married soldier's wife is barely recognized, as shown by the following extract:—"The comptroller of the barrack department may, if he sees fit, and when it in no shape interferes with or straitens the accommodation of the men, permit (as an occasional indulgence, and as tending to promote cleanliness, and the convenience of the soldier) four married women per troop or company of sixty men, and six per troop or company of a hundred men, to be resident within the barracks; but no one article shall on this account be furnished by the barrack-masters, upon any consideration whatever. And if the barrack-masters perceive that any mischief, or damage, arises from such indulgence, the commanding officer shall, on their representation, displace such women. Nor shall any dogs be suffered to be kept in the rooms of any barrack or hospital." Another regulation says: "Where kitchens are provided for the soldiers, they shall not be allowed to dress their provisions in any other places." In about 1818 the civil barrack department was abolished on account of abuses which had grown up, and the duke of Wellington as master-general of the ordnance and commander-in-chief transferred to the corps of Royal Engineers the duties of construction and maintenance of barracks. In 1826 a course of practical architecture was started at the school of military engineering at Chatham under Lieutenant-Colonel (afterwards Sir Charles) Pasley, the first commandant of the school, who himself wrote an outline of the course. Wellington interested himself in the

barrack question, and under his orders single iron bedsteads were substituted for the wooden berths, two tiers high, in which two men slept in the same bed, then a certain cubical space per man was allotted, and cook-houses and ablution-rooms were added. Next, sergeants' messes were started, and ball courts allowed for the recreation of the men. It was not, however, till after the Crimean War that public attention was directed by the report dated 1857 of the royal commission on the sanitary state of the army, to the high death-rate, and certain sanitary defects in barracks and hospitals, such as overcrowding, defective ventilation, bad drainage and insufficient means of cooking and cleanliness, to which this excessive mortality was among other causes assigned.

In 1857 a commission appointed for improving the sanitary condition of barracks and hospitals made an exhaustive inspection of the barracks in the United Kingdom, and reported in 1861. This was followed by similar commissions to examine the barracks in the Mediterranean stations and in India. These commissions, besides making valuable recommendations for the improvement of almost every barrack inspected by them, laid down the general sanitary principles applicable to the arrangement and construction of military barracks and hospitals; and in spite of the lapse of time, the reports repay close study by any one interested in sanitary science as applied to the construction and improvement of such buildings. The names of Sidney Herbert (afterwards Lord Herbert of Lea), Captain (afterwards Sir Douglas) Galton, R.E., and John Sutherland, M.D., stand out prominently among those who contributed to the work. The commission was constituted a standing body in 1862, and continues its work to the present day, under the name of the Army Sanitary Committee, which advises the secretary of state for war on all sites for new barracks or hospitals, also upon type plans, especially as to sanitary details, and principles of sanitary construction and fittings. A definite standard of accommodation was laid down, which formed the basis of the first issue of the *Barrack Synopsis* in 1865. A general order dated 1845 had directed that a space of 450 to 500 cub. ft. per man should be provided in all new barracks at home stations; but this had not been applied in existing barracks or buildings appropriated as such, and when detailed examination was made, it was found that some men had actually less than 250 cub. ft., and out of accommodation for nominally 76,813 soldiers, 2003 only had 600 cub. ft. per man, which was the minimum scale now laid down by the royal commission of 1857. To give every soldier his allotted amount of 600 cub. ft., meant a reduction in accommodation of the barracks by nearly one-third the number. Many buildings were condemned as being entirely unsuitable for use as barracks; in other cases improvements were possible by alterations to buildings and opening-up of sites. Ventilation of the rooms was greatly improved, cook-houses, ablution-rooms and sanitary accessories were carefully examined and a proper scale laid down. Separate quarters for the married soldiers did not exist in many barracks, and in some instances married men's beds were found in the men's barrack-rooms without even a screen to separate them; in other cases, married people were accommodated together in a barrack-room, with only a blanket hung on a cord as a screen between the different families. The recommendations of the committee resulted in a single room being allotted to all married soldiers, and this accommodation has gradually improved up to the comfortable cottage now provided.

From the time of this first thorough inquiry into barrack accommodation, steady and systematic progress has been made. Although lack of funds has always hampered rapid progress, and keeps the accommodation actually existing below the standard aimed at, much has been done to improve the soldiers' condition in this respect. Numerous regimental depots and other barracks were built under the Military Forces Localization Act of 1872. The Barracks Act of 1890 replaced the worn-out huts at Aldershot, Colchester, Shorncliffe and Curragh by convenient and sanitary permanent buildings, and further additions and improvements have been made under the Military Works Acts

of 1807, 1899 and 1901. As some evidence of the practical result of the care and money that has been expended on this work, it is interesting to note that while, in 1857, the annual rate of mortality in the army at home per 1000 men was 17.5 (compared with 9.2 for the civil male population of corresponding age), forty years later, in 1897, the rate of mortality in the army was only 3.42 per 1000. No doubt, improved barrack accommodation contributed greatly to this result. Barrack construction work remained in the hands of the Corps of Royal Engineers until 1904, when a civil department was again formed under an architect styled "director of barrack construction," to deal with the construction of barracks at home stations, and the construction and maintenance of military hospitals.

British Colonial.—Barracks at colonial stations are governed by the general scale of accommodation in the *Barrack Synopsis*, modified according to the climate of the station, in the direction of increase in floor area and height of rooms. In the planning of rooms for occupation in tropical or sub-tropical countries provision has to be made for the freest possible circulation of air through the buildings. The walls have to be protected by verandahs from the direct rays of the sun, and the special local domestic arrangements have to be taken into consideration. For example, in hot countries it is usually undesirable to have kitchens directly attached to the dwelling-houses, sanitary arrangements vary according to the methods adopted, and in some cases it is necessary to provide a free circulation of air below the ground floors of all inhabited buildings by raising them off the ground some 4 ft. The aspect of the buildings will usually be arranged so as to catch the prevailing wind, and the mode of construction varies greatly according to the custom and resources of the country.

Indian Barracks.—In India, barracks for the British troops are built by the Royal Engineer officers detailed for military work duties, assisted by military foremen, who pass through the civil engineering colleges, and by a native subordinate staff. The scale of accommodation to be provided is laid down in the Indian army regulations, and is for the private soldier more liberal than is allowed by the home government for any of the colonial stations. The barrack-rooms are lofty and airy, with verandahs all round, and clerestory windows. Roofs are usually of double tiling. The allowance of space is 90 sq. ft. per man in rooms 16 ft. high, with, in addition, a day room adjoining for the use of the men for their meals or as a sitting-room. Recreation establishments are liberally provided for, and other means of recreation, such as bowling and skittle alleys, five courts, plunge baths and cricket grounds, are given. Separate blocks of married quarters are provided, and schools for the children. Hospital accommodation on a higher scale than at home is necessary; but hill sanatoria have in recent years done much to improve the health of the troops by giving change of air, during the hot weather, to a large proportion of the men and families. Piped water supplies have replaced the old wells at many stations, and attention is being directed to improved cooking and sanitary arrangements.

Naval Barracks.—In recent years, large naval barracks have been built, notably at Portsmouth, Chatham and Devonport. These differ from military barracks principally in that they keep up the system of board-ship life to which the men are accustomed. Large barrack-rooms are provided with caulked floors like ships' decks, and have rows of hammocks slung across them; these are stowed in the day-time, when the rooms are used as mess-rooms. Ablution and sanitary arrangements are grouped together on the basement floors. Fine recreation establishments and canteens have been built. The officers' messes have splendid public rooms, but the officers' quarters are not so large as in military barracks, though no doubt spacious to the naval officer, accustomed as he is to a small cabin. Married quarters for the men are not provided except in connexion with coastguard stations.

Other Countries.—A great number of the German and French barracks are erected in the form of a large block of three or four storeys containing all the accommodation and accessories for officers, married and single non-commissioned officers and men, of a complete battalion or regiment in one building. Some of the

modern barracks, however, are arranged more on the pavilion system with separate blocks; but the single block system is well liked on account of its compactness and the facility it gives for supervision; it is also more satisfactory from the architectural point of view. The system of allotment and arrangement of accommodation for these two great armies does not differ much, except in detail, from that adopted by the British army. The floor and cubic space allotted per man is a little less; accommodation for officers is not usually provided, except to a limited extent, unless the barracks are on a country site. The German army, however, now provides every regiment with a fine officers' mess-house furnished at the public expense. Married quarters for some of the non-commissioned officers are provided, but not for privates. American barracks are interesting, as providing for perhaps a higher class of recruit than usual; they are well designed and superior finish internally is given. The barracks are arranged usually on the separate block system, and centre round a post-exchange or soldiers' club, which is a combined recreation establishment, gymnasium and sergeants' mess, with bath-house attached. Canteens for the sale of liquor were abolished in 1901.

See *The Barrack Synopsis* (1905); *The Handbook of Design and Construction of Military Buildings* (1905); *The Army Regulations, India*, vol. xii. (E. N. S.)

BARRANDE, JOACHIM (1799-1883), Austrian geologist and palaeontologist, was born at Sauges, Haute Loire, on the 11th of August 1799, and educated in the École Polytechnique at Paris. Although he had received the training of an engineer, his first appointment was that of tutor to the duc de Bordeaux (afterwards known as the comte de Chambord), grandson of Charles X., and when the king abdicated in 1830, Barrande accompanied the royal exiles to England and Scotland, and afterwards to Prague. Settling in that city in 1831, he became occupied in engineering works, and his attention was then attracted to the fossils from the Lower Palaeozoic rocks of Bohemia. The publication in 1839 of Murchison's *Silurian System* incited Barrande to carry on systematic researches on the equivalent strata in Bohemia. For ten years (1840-1850) he made a detailed study of these rocks, engaging workmen specially to collect fossils, and in this way he obtained upwards of 3500 species of graptolites, brachiopoda, mollusca, crustacea (particularly trilobites) and fishes. The first volume of his great work, *Système silurien du centre de la Bohême* (dealing with trilobites), appeared in 1852; and from that date until 1881, he issued twenty-one quarto volumes of text and plates. Two other volumes were issued after his death in 1887 and 1894. It is estimated that he spent nearly £10,000 on these works. In addition he published a large number of separate papers. In recognition of his important researches the Geological Society of London in 1855 awarded to him the Wollaston medal.

The term Silurian was employed by Barrande, after Murchison, in a more comprehensive sense than was justified by subsequent knowledge. Thus the Silurian rocks of Bohemia were divided into certain stages (A to H)—the two lowermost, A and B without fossils (Azoc), succeeded by the third stage, C, which included the primordial zone, since recognized as part of the Cambrian of Sedgwick. The fourth stage (Étage D), the true lower Silurian, was described by Barrande as including isolated patches of strata with organic remains like those of the Upper Silurian. These assemblages of fossils were designated "Colonies," and regarded as evidence of the early introduction into the area of species from neighbouring districts, that became locally extinct, and reappeared in later stages. The interpretation of Barrande was questioned in 1854 by Edward Forbes, who pointed to the disturbances, overturns and crumplings in the older rocks as affording a more reasonable explanation of the occurrence of strata with newer fossils amid those containing older ones. Other geologists subsequently questioned the doctrine of "Colonies." In 1880 Dr J. E. Marr, from a personal study in the field, brought forward evidence to show that the repetitions of the fossiliferous strata on which the "Colonies" were based were due to faults. The later stages of Barrande, F, G and H, have since been shown by Emanuel Friedrich Heinrich Kayser (b. 1845) to be Devonian.

Despite these modifications in the original groupings of the strata, it is recognized that Barrande "made Bohemia classic ground for the study of the oldest fossiliferous formations." He died at Frohsdorf on the 5th of October 1883.

See "Sketch of the Life of Joachim Barrande," *Geol. Mag.* (1883), p. 529 (with portrait).

BARRANQUILLA, a city and port of Colombia, South America, capital of a province of the same name in the department of Atlantico, on the left bank of the Magdalena river about 7 m. above its mouth and 18½ m. by rail from its seaport, Puerto Colombia. Pop. (est. 1902) 31,000. Owing to a dangerous bar at the mouth of the Magdalena the trade of the extensive territory tributary to that river, which is about 60% of that of the entire country, must pass in great part through Barranquilla and its seaport, making it the principal commercial centre of the republic. Savanilla was used as a seaport until about 1890, when shoals caused by drifting sands compelled a removal to Puerto Colombia, a short distance westward, where a steel pier, 4000 ft. in length, has been constructed to facilitate the handling of freight. The navigation of the Magdalena is carried on by means of light-draught steamboats which ascend to Yeguas, 14 m. below Honda, where goods are transhipped by rail to the latter place, and thence by pack animals to Bogotá, or by smaller boats to points farther up the river. Barranquilla was originally founded in 1629, but attracted no attention as a commercial centre until about the middle of the 19th century, when efforts were initiated to secure the trade passing through Cartagena. The city is built on a low plain, is regularly laid out, and has many fine warehouses, public buildings and residences, but its greater part, however, consists of mud-walled cabins supported by bamboo (*guadua*) framework and thatched with rushes. The water-supply is drawn from the Magdalena, and the city is provided with telephone, electric light and tram services. Owing to periodical inundations, the surrounding country is but little cultivated, and the greater part of the population, which is of the mixed type common to the lowlands of Colombia, is engaged in no settled productive occupation.

BARRAS, PAUL FRANÇOIS NICOLAS, COMTE DE (1755-1829), member of the French Directory of 1795-1799, was descended from a noble family of Provence, and was born at Fox-Amphoux. At the age of sixteen he entered the regiment of Languedoc as "gentleman voyager," but embarked for India in 1776. After an adventurous voyage he reached Pondicherry and shared in the defence of that city, which ended in its capitulation to the British on the 18th of October 1778. The garrison being released, Barras returned to France. After taking part in a second expedition to the East Indies in 1782-1783, he left the army and occupied the following years with the frivolities congenial to his class and to his nature. At the outbreak of the Revolution in 1789, he espoused the democratic cause, and became one of the administrators of the department of the Var. In June 1792 he took his seat in the high national court at Orleans; and later in that year, on the outbreak of war with the kingdom of Sardinia, he became commissioner to the French army of Italy, and entered the Convention (the third of the national assemblies of France) as a deputy for the department of the Var. In January 1793 he voted with the majority for the death of Louis XVI. Much of his time, however, was spent in missions to the districts of the south-east of France; and in this way he made the acquaintance of Bonaparte at the siege of Toulon. As an example of the incorrectness of the *Barras Mémoires* we may note that the writer assigned 30,000 men to the royalist defending force, whereas it was less than 12,000; he also sought to minimize the share taken by Bonaparte in the capture of that city.

In 1794 Barras sided with the men who sought to overthrow the Robespierre faction, and their success in the *coup d'état* of 9 Thermidor (27th of July) brought him almost to the front rank. In the next year, when the Convention was threatened by the malcontent National Guards of Paris, it appointed Barras to command the troops engaged in its defence. His nomination of Bonaparte as one of his subalterns led to the adoption of vigorous measures, which ensured the dispersion of the royalists and

malcontents in the streets near the Tuileries, 13 Vendémiaire (5th of October 1795). Thereupon Barras became one of the five Directors who controlled the executive of the French Republic. Owing to his intimate relations with Joséphine de Beauharnais, he helped to facilitate a marriage between her and Bonaparte; and many have averred, though on defective evidence, that Barras procured the appointment of Bonaparte to the command of the army of Italy early in the year 1796. The achievements of Bonaparte gave to the Directory a stability which it would not otherwise have enjoyed; and when in the summer of 1797 the royalist and constitutional opposition again gathered strength, Bonaparte sent General Augereau (*q.v.*), a headstrong Jacobin, forcibly to repress that movement by what was known as the *coup d'état* of 18 Fructidor (4th September). Barras and the violent Jacobins now carried matters with so high a hand as to render the government of the Directory odious; and Bonaparte had no difficulty in overthrowing it by the *coup d'état* of 18-19 Brumaire (9th-10th of November). Barras saw the need of a change and was to some extent (how far will perhaps never be known) an accomplice in Bonaparte's designs, though he did not suspect the power and ambition of their contriver. He was left on one side by the three Consuls who took the place of the five Directors and found his political career at an end. He had amassed a large fortune and spent his later years in voluptuous ease. Among the men of the Revolution few did more than Barras to degrade that movement. His immorality in both public and private life was notorious and contributed in no small degree to the downfall of the Directory, and with it of the first French Republic. Despite his profession of royalism in and after 1815, he remained more or less suspect to the Bourbons; and it was with some difficulty that the notes for his memoirs were saved from seizure on his death on the 29th of January 1820.

Barras left memoirs in a rough state to be drawn up by his literary executor, M. Rousselin de St. Albin. The amount of alteration which they underwent at his hands is not fully known; but M. George Duruy, who edited them on their publication in 1895, has given fairly satisfactory proofs of their genuineness. For other sources relating to Barras see the *Memoirs of Gohier, Larivière-Lépeaux and de Lescurie*; also Sciout, *Le Directoire* (4 vols., Paris, 1895-1897), A. Sorel, *L'Europe et la Révolution française* (esp. vols. v. and vi., Paris, 1903-1904), and A. Vandal, *L'Atteinte de Bonaparte* (Paris, 1902-1904). (J. H. L. R.)

BARRATRY (O. Fr. *barater*, *barater*, to barter or cheat), in English criminal law, the offence (more usually called *common barratry*) of constantly inciting and stirring up quarrels in disturbance of the peace, either in courts or elsewhere. It is an offence both at common law and by statute, and is punishable by fine and imprisonment. By a statute of 1726, if the person guilty of common barratry belonged to the profession of the law, he was disabled from practising in the future. It is a cumulative offence, and it is necessary to prove at least three commissions of the act. For nearly two centuries there had been no record of an indictment having been preferred for this offence, but in 1889 a case occurred at the Guildford summer assizes, *R. v. Bellgrove* (*The Times*, 8th July 1889). As, however, the defendant was convicted of another offence, the charge was not proceeded upon. (See Pollock and Maitland, *History of English Law*; Russell, *Crimes and Misdemeanours*; Stephen, *Criminal Law*.)

In marine insurance barratry is any kind of fraud committed upon the owner or insurers of a ship by a master with the intention of benefiting himself at their expense. Continental jurists give a wider meaning to barratry, as meaning any wilful act by the master or crew, by whatever motive induced, whereby the owners or charterers are damaged. In bills of lading it is usual to except it from the shipowners' liability (see AFFREIGHTMENT).

In Scotland, barratry is the crime committed by a judge who is induced by bribery to pronounce judgment.

BARRÉ, ISAAC (1726-1802), British soldier and politician, was born at Dublin in 1726, the son of a French refugee. He was educated at Trinity College, Dublin, entered the army, and in 1759 was with Wolfe at the taking of Quebec, on which occasion he was wounded in the cheek. His entry into parliament in 1761 under the auspices of Lord Shelburne, who had selected him "as a bravo to run down Mr Pitt," was characterized by a virulent

attack on Pitt, of whom, however, he became ultimately a devoted adherent. A vigorous opponent of the taxation of America, his mastery of invective was powerfully displayed in his championship of the American cause, and the name "Sons of Liberty," which he had applied to the colonists in one of his speeches, became a common designation of the American organizations directed against the Stamp Act, as well as of later patriotic clubs. His appointment in 1782 to the treasurership of the navy, which carried with it a pension of £3200 a year, at a time when the government was ostensibly advocating economy, caused great discontent; subsequently, however, he received from the younger Pitt the clerkship of the pells in place of the pension, which thus was saved to the public. Becoming blind, he retired from office in 1790 and died on the 20th of July 1802.

BARRE, a city of Washington county, Vermont, U.S.A., in the north central part of the state, about 6 m. S.E. of Montpelier. Pop. (1890) 4146; (1900) 8448, of whom 2837 were foreign-born; (1910, census) 10,734. It is served by the Central Vermont and the Montpelier & Wells River railways, and is connected by electric street railways with Montpelier. Barre is an important seat of the granite industry, and manufactures monuments and tombstones, stone-cutting implements and other machinery. In 1905 the city's factory products were valued at \$3,373,046, of which 86.9% was the value of the monuments and tombstones manufactured. Among its institutions are the Aldrich public library and Goddard Seminary (1870; Universalist). There is a beautiful granite statue of Burns (by J. Massey Rhind), erected in 1899 by the Scotsmen of Barre. The water-works are owned and operated by the municipality. Settled soon after the close of the War of Independence, the township of Barre (pop. in 1910, 4194) was organized in 1793 and named in honour of Isaac Barré (1726-1802), a defender of American rights in the British parliament. The present city, chartered in 1894, was originally a part of the township.

BARREL (a word of uncertain origin common to Romance languages; the Celtic forms, as in the Gaelic *barail*, are derived from the English), a vessel of cylindrical shape, made of staves bound together by hoops, a cask; also a dry and liquid measure of capacity, varying with the commodity which it contains (see WEIGHTS and MEASURES). The term is applied to many cylindrical objects, as to the drum round which the chain is wound in a crane, a capstan or a watch; to the cylinder studded with pins in a barrel-organ or musical-box; to the hollow shaft in which the piston of a pump works; or to the tube of a gun. The "barrel" of a horse is that part of the body lying between the shoulders and the quarters. For the system of vaulting in architecture known as "barrel-vaulting" see VAULT.

BARREL-ORGAN (Eng. "grinder-organ," "street-organ," "hand-organ," "Dutch organ"; Fr. *orgue de Barbarie*, *orgue d'Allemagne*, *orgue mécanique*, *cabinet d'orgue*, *serinette*; Ger. *Drehorgel*, *Leierkasten*; Ital. *organetto a manovella*, *organo tedesco*), a small portable organ mechanically played by turning a handle. The barrel-organ owes its name to the cylinder on which the tunes are pricked out with pins and staples of various lengths, set at definite intervals according to the scheme required by the music. The function of these pins and staples is to raise balanced keys connected by simple mechanism with the valves of the pipes, which are thus mechanically opened, admitting the stream of air from the wind-chest. The handle attached to the shaft sets the cylinder in slow rotation by means of a worm working in a fine-toothed gear on the barrel-head; the same motion works the bellows by means of cranks and connecting rods on the shaft. The wind is thereby forced into a reservoir, whence it passes into the wind-chest, on the sides of which are grouped the pipes. The barrel revolves slowly from back to front, each revolution as a rule playing one complete tune. A notch-pin in the barrel-head, furnished with as many notches as there are tunes, enables the performer to shift the barrel and change the tune. The ordinary street barrel-organ had a compass varying from 24 to 34 notes, forming a diatonic scale with a few accidentals, generally F♯, G♯, C♯. There were usually two stops, one for the open pipes of metal, the other for the closed wooden pipes. Barrel-organs

have been made with as many as three or four cylinders set in a circular revolving frame, but these more elaborate instruments were mainly used in churches¹ and chapels, a purpose for which they were in great demand for playing hymns, chants and voluntaries during the 18th and early 19th centuries. A barrel-organ was built for Fulham church by Wright, and a large instrument with four barrels was constructed by Bishop for Northallerton church in 1820.

The origin of the barrel-organ is now clearly established, and many will doubtless be surprised to find that it must be sought in the Netherlands as early as the middle of the 15th century, and that accurate and detailed diagrams of every part of the mechanism for a large stationary barrel-organ worked by hydraulic power were published in 1615. There are letters patent preserved in the archives of Belgium appointing a certain organ-builder, Jehan van Steenken, *dit* Aren, "Master of organs which play of themselves"; in the original Flemish *Meester van orgelen spelende bij hen selven*.² This organ was not a portable one like English street-organs, but a more imposing instrument, as we learn from other documents giving a detailed account of the moneys paid to Maistre Jehan for conveying the organs

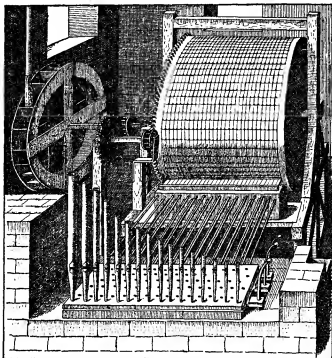

FIG. 1.—Large stationary barrel-organ worked by hydraulic power, from Solomon de Caus, *Les Raisons des forces mouvantes* (Frankfort-on-Main, 1615).

from Bruges to Brussels.³ Steenken was, by virtue of the same letters patent, awarded an annual pension of fifty Rhinish florins in consideration of the services rendered to the duke of Burgundy, and on condition of his submitting to his liege Philip the Good all other instruments he might make in the future. There is nothing singular in the early date of this invention, for the 15th century was distinguished for the extraordinary impulse which the patronage and appreciation of the dukes of Burgundy

¹ This practice had evidently not been adopted in Germany, as the following instance will show. The use of barrel-organs (*Drehorgeln*) in country churches was seriously recommended by an anonymous writer in two German papers at the beginning of the 19th century (*Beobachter an der Spree*, Berlin, 22nd October 1821, and in *Märkische Boten*, Nos. 138 and 139, 1821). The organist Wilke of Leipzig published in reply an article in the *Allgem. musik. Zeitung* (1822, pp. 777 et seq.) in which "he very properly repudiated such a laughable recommendation."

² *Archives générales du royaume de Belgique, Chambre des Comptes*, No. 2, 449 r.^o, cf. 52 r.^o; and Edmund van der Straeten, *La Musique aux Pays-Bas*, vol. vii, pp. 230-232.

³ Van der Straeten, *op. cit.* p. 299.

gave to automatic contrivances of all kinds, carillons, clocks, speaking animals and other curiosities due to Flemish genius.⁴ No contemporary illustration is forthcoming, but in 1615 Solomon de Caus, who avowedly owed his inspiration to Hero and Vitruvius, describes a number of hydraulic machines, amongst which is the barrel-organ,⁵ illustrating his description by means of several large drawings and diagrams very carefully carried out. De Caus' organ, entitled "Machine par laquelle l'on fera sonner un jeu d'orgues par le moyen de l'eau," was built up on a wall a foot thick. In the illustrations the barrel is shown to be divided into bars, and each bar into eight beats for the quavers. The whole drum is pierced with holes at the intersecting points, the pins being movable, so that when the performer grew tired of one tune, he could re-arrange the pins to form another. The four bellows are set in motion by means of ropes strained over pulleys and attached to four cranks on the rotating shaft. Solomon de Caus lays no claim to the invention of this organ, but only to the adaptation of hydraulic power for revolving the drum; on the contrary, in a dissertation on the invention of hydraulic machines and organs, he states that there was evidently some difference between the organs of the ancients and those of his day, since there is no mention in the classics of any musical wheel by means of which tunes could be played in several parts—the ancients, indeed, seem to have used their fingers on the keyboard to sound their organs. The eighteen keys drawn in one diagram bear names, beginning at the left, D, C, B, A, G, F, F#, E, D, C, B, A, G, F, E, D, C, B; De Caus states that only half the keyboard is given for want of space; the compass, therefore, probably was as shown, with a few accidentals. A barrel-organ, also worked by hydraulic power, is somewhat fantastically drawn by Robert Fludd in a work⁶ published two years after that of Solomon de Caus. This diagram is of no value except as a curiosity, for the author betrays a very imperfect knowledge of the mechanical principles involved. The piece of music actually set on de Caus' barrel-organ, six bars of which can be made out,⁷ consists of a madrigal, "Chi fara fed' al ciel," by Alessandro Striggio, written in organ tablature by Peter Philips, organist of the Chapel Royal, Brussels, at the end of the 16th century.⁸ A French barrel-organ⁹ in the collection of the Brussels Conservatoire, bearing the date "5 Mars 1797," has the following compass with flats, beginning at the left:



Other evidences of the origin of the barrel-organ are not wanting. The inventory of the organs and other keyboard instruments belonging to the duke of Modena, drawn up in 1598, contains two entries of an *organo Tedesco*.¹⁰ In England these organs were also known as "Dutch organs," and the name clung to the instrument even in its diminutive form of hand-organ of the itinerant musician. In Jedediah Morse's description of the

⁴ Van der Straeten, *op. cit.* p. 231.

⁵ Solomon de Caus, *Les Raisons des forces mouvantes* (Frankfort, 1615), problems 25, 28, 29, 30.

⁶ *Historia atrisuecosi* (Oppenheim, 1617), t. i., experimentum viii. p. 483.

⁷ *Op. cit.* problem 29 shows the arrangement of the bellows for the wind-supply. In problem 30 is drawn a large section of the barrel, showing six bars of music represented by the pin tablature, which can be actually deciphered by the help of the keyboard included in the drawing. These diagrams are admirably clear and of real technical value. A copy of this work is in the library of the British Museum.

⁸ See also E. van der Straeten, who has translated Philips' setting into modern notation, *op. cit.* t. vi, pp. 506 and 510.

⁹ See V. C. Mahillon, *Catalogue descriptif* (Brussels, 1896), No. 1137, p. 371.

¹⁰ *Tedesco* was applied by Italians to both German and Dutch. Count Valdrighi, *Musurgia I. Seranoda; Pianoforte, Sallerio* (Modena, 1879), pp. 27 and 28; and E. van der Straeten, *op. cit.* vol. vi, p. 122.

manners and customs of the Netherlands,¹ we find the following allusion:—"The diversions of the Dutch differ not much from those of the English, who seem to have borrowed from them the neatness of their drinking booths, skittle and other grounds . . . which form the amusements of the middle ranks, not to mention their hand-organs and other musical inventions." An illustration of the hand-organ of that period is given in Knight's *London*,² being one of a collection of street views published by Dayes in 1789. In a description of Bartholomew Fair, as held at the beginning of the 18th century, is a further reference to the Dutch origin of the barrel-organ:—"A band at the west-end of the town, well known for playing on winter evenings before Spring Garden Coffee House, opposite Wigley's great exhibition room, consisted of a double drum, a Dutch organ, the tambourine, violin, pipes and the Turkish jingle used in the army. This band was generally hired at one of the booths of the fair."³ Mr Thomas Brown relates that one Mr Stephens, a *Poultry* author, proposed to parliament for any one that should presume to keep an organ in a Public House to be fined £20 and made incapable of being an ale-draper for the future.⁴ In 1737 Horace Walpole writes:⁵—"I am now in pursuit of getting the finest piece of music that ever was heard; it is a thing that will play eight tunes. Handel and all the great musicians say that it is beyond anything they can do, and this may be performed by the most ignorant person, and when you are weary of those eight tunes, you may have them changed for any other that you like."⁶ The organ was put in a lottery and fetched £1000.

There was a very small barrel-organ in use during the 18th and 19th centuries, known as the bird-organ (Fr. *serinette, turlutaine, merline*). One of these now in the collection of the Brussels Conservatoire is described by V. C. Mahillon.⁷ The instrument is in the form of a book, on the back of which is the title "Le chant des oiseaux, Tome vi." There are ten pewter stopped pipes giving the scale of G with the addition of Fb and A two octaves higher. The whole instrument measures approximately 8 X 5½ X 2½ in. and plays eight tunes. Mozart wrote an *Andante*⁸ for a small barrel-organ.

For an illustration of the construction of the barrel-organ during the 18th century, consult P. M. D. J. Engramelle, *La Tonotechnie ou l'art de noter les cylindres et tout ce qui est susceptible de notation dans les instruments de concert mécaniques* (Paris, 1775), with engravings (not in the British Museum); and for a clear diagram of the modern instrument the article on "Automatic Appliances connected with Music," by Dr E. J. Hopkins, in *Grove's Dictionary of Music and Musicians*, vol. i. (1904), p. 134. (K. S.)

BARREN ISLAND, a volcanic island in the Bay of Bengal. It has an irregularly circular form of about 2 m. in diameter, composed of an outer rim rising to a height of from 700 to 1000 ft., with a central cone the altitude of which is 1015 ft. This cone rises from a depth of 800 fathoms below the sea. It was active between 1780 and 1832, but has since been dormant.

BARRETS, MAURICE (1862-), French novelist and politician, was born at Charmes (Vosges) on the 22nd of September 1862; he was educated at the lycée of Nancy, and in 1883 went to Paris to continue his legal studies. He was already a contributor to the monthly periodical, *Jeune France*, and he now issued a periodical of his own, *Les Taches d'encre*, which survived for a few months only. After four years of journalism he went to Italy, where he wrote *Sous l'œil des barbares* (1888), the first volume of a *trilogie du moi*, completed by *Un Homme libre* (1889), and *Le Jardin de Bérénice* (1891). He divided the world into *moi* and the barbarians, the latter including all those antipathetic to the writer's individuality. These apologies for

individualism were supplemented by *L'Ennemi des lois* (1892), and an admirable volume of impressions of travel, *Du sang, de la volupté et de la mort* (1893). His early books are written in an elaborate style and are often very obscure. Barrès carried his theory of individualism into politics as an ardent partisan of General Boulanger. He directed a Boulangist paper at Nancy, and was elected deputy in 1889, retaining his seat in the legislature until 1893. His play, *Une Journée parlementaire*, was produced at the Comédie Française in 1894. In 1897 he began his trilogy, *Le Roman de l'énergie nationale*, with the publication of *Les Déracinés*. The series is a plea for local patriotism, and for the preservation of the distinctive qualities of the old French provinces. The first narrates the adventures of seven young Lorrainers, who set out to conquer fortune in Paris. Six of them survive in the second novel of the trilogy, *L'Appel au soldat* (1900), which gives the history of Boulangism; the sequel, *Leurs figures* (1902), deals with the Panama scandals. Later works are:—*Scènes et doctrines du nationalisme* (1902); *Les Amitiés françaises* (1903), in which he urges the inculcation of patriotism by the early study of national history; *Ce que j'ai vu à Rennes* (1904); *Au service de l'Allemagne* (1905), the experiences of an Alsatian conscript in a German regiment; *Le Voyage de Sparte* (1906). M. Barrès was admitted to the French Academy in 1906.

See also R. Doumic, *Les Jeunes* (1896); J. Lionnet, *L'Évolution des idées* (1903); Anatole France, *La Vie littéraire* (4th series, 1892).

BARRETT, LAWRENCE (1838-1891), American actor, was born of Irish parents in Paterson, New Jersey, on the 4th of April 1838. His family name was Brannigan. He made his first stage appearance at Detroit as Murad in *The French Spy* in 1853. In December 1856 he made his first New York appearance at the Chambers Street theatre as Sir Thomas Clifford in *The Hunchback*. In 1858 he was in the stock company at the Boston Museum. He served with distinction in the Civil War as captain in the 28th Massachusetts infantry regiment. From 1867 to 1870, with John M'Callough, he managed the California theatre, San Francisco. Among his many and varied parts may be mentioned Hamlet, Lear, Macbeth, Shylock, Richard III., Wolsey, Benedict, Richelieu, David Garrick, Hernani, Alfred Evelyn, Lanciotto in George Henry Boker's (1823-1890) *Francesca da Rimini*, and James Harebell in *The Man o' Airlie*. He acted Othello to Booth's Iago and Cassius to his Brutus. He acted in London in 1867, 1881, 1883 and 1884, his Richelieu in Bulwer Lytton's drama being considered his best part. He wrote a life of Edwin Forrest in the *American Actors Series* (Boston, 1881), and an admirable sketch of Edwin Booth in *Edwin Booth and his Contemporaries* (Boston, 1886). He died on the 20th of March 1891.

BARRETT, LUCAS (1837-1862), English naturalist and geologist, was born in London on the 14th of November 1837, and educated at University College school and at Ebersdorf. In 1855 he accompanied R. McAndrew on a dredging excursion from the Shetlands to Norway and beyond the Arctic Circle; and subsequently made other cruises to Greenland and to the coast of Spain. These expeditions laid the foundations of an extensive knowledge of the distribution of marine life. In 1855 he was engaged by Sedgwick to assist in the Woodwardian Museum at Cambridge, and during the following three years he aided the professor by delivering lectures. He discovered bones of birds in the Cambridge Greensand, and he also prepared a geological map of Cambridge on the one-inch Ordnance map. In 1859, when twenty-two years of age, he was appointed director of the Geological Survey of Jamaica. He there determined the Cretaceous age of certain rocks which contained Hippurites, the new genus *Barrettia* being named after him by S. P. Woodward; he also obtained many fossils from the Miocene and newer strata. He was drowned at the early age of twenty-five, on the 18th of December 1862, while investigating the sea-bottom off Kingston, Jamaica.

Obituary by S. P. Woodward in *Geologist* (Feb. 1863), p. 60.

BARRETT, WILSON (1846-1904), English actor, manager and playwright, was born in Essex on the 18th of February 1846, the

¹ Jedediah Morse *American Geography*, part ii. p. 334 (Boston, Mass., 1796).

² Knight's *London*, vol. i. p. 144.

³ Hone's *Every Day Book*, i. p. 1248.

⁴ *Collection of all the Dialogues written by Mr Thomas Brown* (London, 1704), p. 297.

⁵ Hone's *Every Day Book*, ii. pp. 1452-1453.

⁶ See *Catalogue descriptif* (Ghent, 1880), Nos. 461 and 462.

⁷ Breitkopf and Härtel's *Critically revised edition of Mozart's Works*, series x. no. 10.

son of a farmer. He made his first appearance on the stage at Halifax in 1864, and then played in the provinces alone and with his wife, Caroline Heath, in *East Lynne*. After managerial experiences at Leeds and elsewhere, in 1879 he took the management of the old Court theatre, where he introduced Madame Modjeska to London, in an adaptation of Schiller's *Maria Stuart*, *Adrienne Lecouvreur*, *La Dame aux camélias* and other plays. It was not till 1881, however, when he took the Princess's theatre, that he became well known to the public in the emotional drama, *The Lights of London*, by G. R. Sims. The play which made him an established favourite was *The Silver King* by Henry Arthur Jones, perhaps the most successful melodrama ever staged, produced in 1882 with himself as Wilfred Denver, his brother George (an excellent comedian) in the cast, and E. S. Willard (b. 1853) as the "Spider,"—this being the part in which Mr Willard, afterwards a well-known actor both in America and England, first came to the front. Barrett played this part for three hundred nights without a break, and repeated his London success in W. G. Will's *Claudian* which followed. In 1884 he appeared in *Hamlet*, but soon returned to melodrama, and though he had occasional seasons in London he acted chiefly in the provinces. In 1886 he made his first visit to America, repeated in later years, and in 1898 he visited Australia. During these years the London stage was coming under new influences, and Wilson Barrett's vogue in melodrama had waned. But in 1895 he struck a new vein of success with his drama of religious emotion, *The Sign of the Cross*, which crowded his theatre with audiences largely composed of people outside the ordinary circle of playgoers. He attempted to repeat the success with other plays of a religious type, but not with equal effect, and several of his later plays were failures. He died on the 22nd of July 1904. Wilson Barrett was a sterling actor of a robust type and striking physique, not remarkable for intellectual finesse, but excelling in melodrama, and very successful as the central figure on his own stage.

BARRHEAD, a police burgh of Renfrewshire, Scotland, situated on the Levern, 7½ m. S.W. of Glasgow by the Glasgow & South-Western railway. Pop. (1901) 9855. Founded in 1773, it has gradually absorbed the villages of Arthurlie, Dovecotall and Grahamston, and become a thriving town. The chief industries include bleaching, calico-printing, cotton-spinning, weaving, iron and brass founding, engineering and the manufacture of sanitary appliances. Neilston (pop. 2668), about 2 m. S.W., has bleachfields and print-works, and 2 m. N. by E. lie Hurler, where are important manufactures of alum and other chemicals, and Nitshill (pop. 1242) with chemical works, quarries and collieries.

BARRICADE, or **BARRICADO** (from the Span. *barricada*, from *barrica*, a cask, casks filled with earth having been early used to form barricades), an improvised fortification of earth, paving-stones, trees or any materials ready to hand, thrown up, especially across a street, to hinder the advance of an enemy; in the old wooden warships a fence or wooden rail, supported by stanchions and strengthened by various materials, extending across the quarter-deck as a protection during action.

BARRIE, JAMES MATTHEW (1860—), British novelist and dramatist, was born at Kirriemuir, a small village in Forfarshire, on the 9th of May 1860. He was educated at the Dumfries academy and Edinburgh University. He has told us in his quasi-autobiographical *Margaret Ogilvy* that he wrote tales in the garret before he went to school, and at Edinburgh wrote the greater part of a three-volume novel, which a publisher presumed was the work of a clever lady and offered to publish for £100. The offer was not accepted, and it was through journalism that he found his way to literature. After a short period of waiting in Edinburgh, he became leader-writer on the *Nottingham Journal* in February 1883. To this paper he contributed also special articles and notes, which provided an opening and training for his personal talent. He soon began to submit articles to London editors, and on the 17th of November 1884 Mr Frederick Greenwood printed in the *St James's Gazette* his article on "An Auld Licht Community." With the encouragement of this able

editor, more Auld Licht "Idylls" followed; and in 1885 Mr Barrie moved to London. He continued to write for the *St James's Gazette* and for *Home Chimes* (edited by Mr F. W. Robinson). He was soon enlisted by Mr Alexander Riach for the *Edinburgh Evening Dispatch*, which in turn led to his writing (over the signature "Gavin Ogilvy") for Dr Robertson Nicoll's *British Weekly*. Later he became a contributor to the *Scots* (afterwards *National Observer*, edited by W. E. Henley, and also to the *Speaker*, upon its foundation in 1890. In 1887 he published his first book, *Better Dead*. It was a mere *jeu d'esprit*, a specimen of his humorous journalism, elaborated from the *St James's Gazette*. This was followed in 1888 by *Auld Licht Idylls*, a collection of the Scots village sketches written for the same paper. They portrayed the life and humours of his native village, idealized as "Thrums," and were the fruits of early observation and of his mother's tales. "She told me everything," Mr Barrie has written, "and so my memories of our little red town were coloured by her memories." Kirriemuir itself was not wholly satisfied with the portrait, but "Thrums" took its place securely on the literary map of the world. In the same year he published *An Edinburgh Eleven*, sketches from the *British Weekly* of eminent Edinburgh students; also his first long story, *When a Man's Single*, a humorous transcription of his experiences as journalist, particularly in the Nottingham office. The book was introduced by what was in fact another Thrums "Idyll," on a higher level than the rest of the book. In 1889 came *A Window in Thrums*. This beautiful book, and the *Idylls*, gave the full measure of Mr Barrie's gifts of humanity, humour and pathos, with abundant evidence of the whimsical turn of his wit, and of his original and vernacular style. In 1891 he made a collection of his lighter papers from the *St James's Gazette* and published them as *My Lady Nicotine*. In 1891 appeared his first long novel, *The Little Minister*, which had been first published serially in *Good Words*. It introduced, not with unmixt success, extraneous elements, including the winsome heroine Babbie, into the familiar life of Thrums, but proved the author's possession of a considerable gift of romance. In 1894 he published *Margaret Ogilvy*, based on the life of his mother and his own relations with her, most tenderly conceived and beautifully written, though too intimate for the taste of many. The book is full of revelations of great interest to admirers of Mr Barrie's genius. The following year came *Sentimental Tommy*, a story tracing curiously the psychological development of the "artistic temperament" in a Scots lad of the people. R. L. Stevenson supposed himself to be portrayed in the hero, but it may be safely assumed that the author derived his material largely from introspection. The story was completed by a sequel, *Tommy and Griedel*, published in 1900. The effect of this story was somewhat marred by the comparative failure of the scenes in society remote from Thrums. In 1902 he published *The Little White Bird*, a pretty fantasy, wherein he gave full play to his whimsical invention, and his tenderness for child life, which is relieved by the genius of sincerity from a suspicion of mawkishness. This book contained the episode of "Peter Pan," which afterwards suggested the play of that name. In the meantime Mr Barrie had been developing his talent as a dramatist. In 1892 Mr Toole had made a great success at his own theatre of Barrie's *Walker, London*, a farce founded on a sketch in *When a Man's Single*. In 1893 Mr Barrie married Miss Ansell (divorced in 1909), who had acted in *Walker, London*. In this year he wrote, with Sir A. Conan Doyle, a play called *Jane Annie*. He found more success, however, in *The Professor's Love-Story* in 1895; and in 1897 the popularity of his dramatized version of *The Little Minister* probably confirmed him in a predilection for drama, evident already in some of his first sketches in the *Nottingham Journal*. In 1900 Mr Bouchier produced *The Wedding Guest*, which was printed as a supplement to the *Fortnightly Review* in December of the same year. After the publication of *The Little White Bird*, Mr Barrie burst upon the town as a popular and prolific playwright. The struggling journalist of the early 'nineties had now become one of the most prosperous literary men of the day. In 1903 no fewer than three plays from his hand held the stage—*Quality Street*, *The Admirable*

Crichton and Little Mary. The year 1904 produced *Peter Pan*, a kind of poetical pantomime, in which the author found scope for some of his most characteristic and permanently delightful gifts. In 1905 *Alice-Sit-by-the-Fire* and in 1908 *What Every Woman Knows* were added to the list. As dramatist Mr Barrie brought, to a sphere rather ridden by convention, a method wholly unconventional and a singularly fresh fancy, seasoned by a shrewd touch of satirical humour; and in *Peter Pan* he proved himself a Hans Andersen of the stage. In literature, the success of "Thrums" produced a crop of imitations, christened in derision by W. E. Henley the "Kailyard School," though the imitations were by no means confined to Scotland. In this school the *Auld Licht Idylls* and *A Window in Thrums* remained unsurpassed and unapproached. The Scots village tale was no novelty in literature—witness John Galt, the *Chronicles of Carlingford* and George MacDonald. Yet Mr Barrie, in spite of a dialect not easy to the Southron, contrived to touch a more intimate and more responsive chord. With the simplest materials he achieved an almost unendurable pathos, which yet is never forced; and the pathos is salted with humour, while about the moving homeliness of his humanity play the gleams of a whimsical wit. Stevenson; in a letter to Mr Henry James, in December 1892, said justly of Barrie that "there was genius in him, but there was a journalist on his elbow." This genius found its most perfect and characteristic expression in the humanity of "Thrums" and the bizarre and tender fantasy of *Peter Pan*.

See also *J. M. Barrie and His Books*, by J. A. Hamerton (Horace Marshall, 1902); and for bibliography up to May 1903, *English Illustrated Magazine*, vol. xxix. (N.S.), p. 208. (W. P. J.)

BARRIE, the capital of Simcoe county, Ontario, Canada, 56 m. N. of Toronto, on Lake Simcoe, an important centre on the Grand Trunk railway. It contains several breweries, carriage factories, boat-building and railway shops, and manufactories of woollens, stoves and leather. It is also a summer resort and the starting-point for the numerous Lake Simcoe steamers. Pop. (1901) 5949.

BARRIÈRE, THÉODORE (1823-1877), French dramatist, was born in Paris in 1823. He belonged to a family of map engravers which had long been connected with the war department, and spent nine years in that service himself. The success of a vaudeville he had performed at the Beaumarchais and which was immediately snapped up for the repertory of the Palais Royal, showed him his real vocation. During the next thirty years he signed, alone or in collaboration, over a hundred plays; among the most successful were: *La Vie de bohème* (1849), adapted from Henri Murger's book with the novelist's help; *Manon Lescaut* (1851); *Les Filles de marbre* (1853); *L'Héritage de Monsieur Plamel* (1858); *Les Faux Bonshommes* (1856) with Ernest Capendu; *Malheureux vaincus* (1865), which was forbidden by the censor; *Le Gascon* (1878). Barrière died in Paris on the 16th of October 1877.

See also *Revue des deux mondes* (March 1859).

BARRIER TREATY, the name given first to the treaty signed on 29th of October 1709 between Great Britain and the states-general of the United Netherlands, by which the latter engaged to guarantee the Protestant succession in England in favour of the house of Hanover; while Great Britain undertook to procure for the Dutch an adequate barrier on the side of the Netherlands, consisting of the towns of Furnes, Nieuport, Ypres, Menin, Lille, Tournai, Condé, Valenciennes, Maubeuge, Charleroi, Namur, Halle, Damme, Dendermond and the citadel of Ghent. The treaty was based on the same principle of securing Holland against French aggression that had inspired that of Ryswick in 1698, by the terms of which the chief frontier fortresses of the Netherlands were to be garrisoned by Dutch troops. A second Barrier Treaty was signed between Great Britain and Holland on 29th of January 1713, by which the strong places designed for the barrier were reduced to Furnes, the fort of Knocke, Ypres, Menin, Tournai, Mons, Charleroi and the citadel of Ghent, and certain fortresses in the neighbourhood of that city and of Bruges; Great Britain undertaking to obtain the right for the Dutch to garrison them from the future sovereign of the Spanish Netherlands. Its

terms were included in the treaty of Rastatt, between the emperor and France, signed on the 7th of March 1714. A third Barrier Treaty was signed in November 1715.

See Jean Dumont, *Corps universel diplomatique*, &c. (1726-1731), vol. viii.

BARRILLI, ANTONIO GIULIO (1836-), Italian novelist, was born at Savona, and was educated for the legal profession, which he abandoned for journalism in Genoa. He was a volunteer in the campaign of 1859 and served with Garibaldi in 1866 and 1867. From 1865 (*Capitan Doderò*) onwards he published a large number of books of fiction, which had wide popularity, his work being commonly compared with that of Victor Cherbuliez. Some of the best of the later ones are *Santa Cecilia* (1866), *Come un Sogno* (1875), and *L'Olmo e l' Edera* (1877). His *Ruggio di Dio* appeared in 1899. Barrilli also wrote two plays and various volumes of criticism, including *Il rinnovamento letterario italiano* (1890). He was elected to the Italian chamber of deputies in 1876; and in 1889 became professor of Italian literature at Genoa.

BARRING-OUT, a custom, formerly common in English schools, of barring the master out of the school premises. A typical example of this practice was at Bromfield school, Cumberland, where William Hutchinson says "it was the custom, time out of mind, for the scholars, at Fasting's Even (the beginning of Lent) to depose and exclude the master from the school for three days." During this period the school doors were barricaded and the boys armed with mock weapons. If the master's attempts to re-enter were successful, extra tasks were inflicted as a penalty, and willingly performed by the boys. On the third day terms of capitulation, usually in Latin verse, were signed, and these always conceded the immediate right to indulge in football and a cockfight. The custom was long retained at Eton and figures in many school stories.

BARRINGTON, DAINES (1727-1800), English lawyer, antiquary and naturalist, was born in 1727, fourth son of the first Viscount Barrington. He was educated for the profession of the law, and after filling various posts, was appointed a Welsh judge in 1757 and afterwards second justice of Chester. Though an indifferent judge, his *Observations on the Statutes, chiefly the more ancient, from Magna Charta to 21st James I., cap. 27, with an appendix, being a proposal for new-modelling the Statutes* (1766), had a high reputation among historians and constitutional antiquaries. In 1773 he published an edition of Orosius, with Alfred's Saxon version, and an English translation with original notes. His *Tracts on the Probability of reaching the North Pole* (1775) were written in consequence of the northern voyage of discovery undertaken by Captain C. J. Phipps, afterwards Lord Mulgrave (1744-1792). Barrington's other writings are chiefly to be found in the publications of the Royal and Antiquarian Societies, of both of which he was long a member, and of the latter vice-president. Many of these were collected by him in a quarto volume entitled *Miscellanies on various Subjects* (1781). He contributed to the *Philosophical Transactions* for 1780 an account of Mozart's visit at eight years of age to London. In his *Miscellanies* on varied subjects he included this with accounts of four other prodigies, namely, Crotch, Charles and Samuel Wesley, and Garrett Wellesley, Lord Mornington. Among the most curious and ingenious of his papers are his *Experiments and Observations on the Singing of Birds*, and his *Essay on the Language of Birds*. He died on the 14th of March 1800 and was buried in the Temple church.

BARRINGTON, GEORGE (b. 1755), an Irishman with a curious history, was born at Maynooth on the 14th of May 1755, the son of a working silversmith named Waldron. In 1771 he robbed his schoolmaster at Dublin and ran away from school, becoming a member of a touring theatrical company under the assumed name of Barrington. At Limerick races he joined the manager of the company in pocket-picking. The manager was detected and sentenced to transportation, and Barrington fled to London, where he assumed clerical dress and continued his pocket-picking. At Covent Garden theatre he robbed the Russian prince Orlov of a snuff-box, said to be worth £30,000. He was

detected and arrested, but as Prince Orlov declined to prosecute, was discharged, though subsequently he was sentenced to three years' hard labour for pocket-picking at Drury Lane theatre. On his release he was again caught at his old practices and sentenced to five years' hard labour, but influence secured his release on the condition that he left England. He accordingly went for a short time to Dublin, and then returned to London, where he was once more detected pocket-picking, and, in 1790, sentenced to seven years' transportation. On the voyage out to Botany Bay a conspiracy was hatched by the convicts on board to seize the ship. Barrington disclosed the plot to the captain, and the latter, on reaching New South Wales, reported him favourably to the authorities, with the result that in 1792 Barrington obtained a warrant of emancipation (the first issued), becoming subsequently superintendent of convicts and later high constable of Paramatta. In 1796 a theatre was opened at Sydney, the principal actors being convicts, and Barrington wrote the prologue to the first production. This prologue has obtained a wide publicity. It begins:—

"From distant climes, o'er wide-spread seas, we come,
Though not with much *édat* or beat of drum;
True patriots we, for, be it understood,
We left our country for our country's good."

Barrington died at a ripe old age at Paramatta, but the exact date is not on record. He was the author of *A Voyage to Botany Bay* (London, 1801); *The History of New South Wales* (London, 1802); *The History of New Holland* (London, 1808).

BARRINGTON, JOHN SHUTE, 1ST VISCOUNT (1678-1734), English lawyer and theologian, was the son of Benjamin Shute, merchant, and was born at Theobalds, in Hertfordshire, in 1678. He received part of his education at the university of Utrecht; and, after returning to England in 1698, studied law in the Inner Temple. In 1701 he published several pamphlets in favour of the civil rights of Protestant dissenters, to which class he belonged. On the recommendation of Lord Somers he was employed to induce the Presbyterians in Scotland to favour the union of the two kingdoms, and in 1708 he was rewarded for this service by being appointed to the office of commissioner of the customs. From this, however, he was removed on the change of administration in 1711; but his fortune had, in the meantime, been improved by the bequest of two considerable estates,—one of them left him by Francis Barrington of Tofts, whose name he assumed by act of parliament, the other by John Wildman of Becket. Barrington now stood at the head of the dissenters. On the accession of George I. he was returned to parliament for Berwick-upon-Tweed; and in 1720 the king raised him to the Irish peerage, with the title of Viscount Barrington of Ardglass. But having unfortunately engaged in the Harburg lottery, one of the bubble speculations of the time, he was expelled from the House of Commons in 1723,—a punishment which was considered much too severe, and was thought to be due to personal malice of Walpole. In 1725 he published his principal work, entitled *Miscellanea Sacra or a New Method of considering so much of the History of the Apostles as is contained in Scripture*, 2 vols. 8vo.,—afterwards reprinted with additions and corrections, in 3 vols. 8vo, 1770, by his son Shute. In the same year he published *An Essay on the Several Dispensations of God to Mankind*. He died on the 14th of December 1734.

BARRINGTON, SAMUEL (1729-1800), British admiral, was the fourth son of the 1st Viscount Barrington. He entered the navy at an early age and in 1747 had worked his way to a post-captaincy. He was in continuous employment during the peace of 1748-1756, and on the outbreak of the Seven Years' War served with Hawke in the Basque roads in command of the "Achilles" (60). In 1759 the "Achilles" captured a powerful French privateer, after two hours' fighting. In the Havre-de-Grace expedition of the same year Barrington's ship carried the flag of Rear-Admiral Rodney, and in 1760 sailed with John Byron to destroy the Louisburg fortifications. At the peace in 1763 Barrington had been almost continuously afloat for twenty-two years. He was next appointed in 1768 to the frigate "Venus" as governor to the duke of Cumberland, who remained with him in all ranks from midshipman to rear-admiral. In 1778 the

duke's flag-captain became rear-admiral and went to the West Indies, while in conjunction with the army he took the island of Santa Lucia from the French, and repulsed the attempt of the Comte d'Estaing to retake it. Superseded after a time by Byron, he remained as that officer's second-in-command and was present at Grenada and St. Kitts (6th and 22nd of July 1779). On his return home, he was offered, but refused, the command of the Channel fleet. His last active service was the relief of Gibraltar in October 1782. As admiral he flew his flag for a short time in 1790, but was not employed in the French revolutionary wars. He died in 1800.

See Ralfe, *Naval Biographies*, i. 120; Charnock, *Biographia Navalis*, vi. 10.

BARRINGTON, SHUTE (1734-1826), youngest son of the 1st Viscount Barrington, was educated at Eton and Oxford, and after holding some minor dignities was made bishop of Llandaff in 1760. In 1782 he was translated to Salisbury and in 1791 to Durham. He was a vigorous Protestant, though willing to grant Roman Catholics "every degree of toleration short of political power and establishment." He published several volumes of sermons and tracts, and wrote the political life of his brother, Viscount Barrington.

BARRINGTON, WILLIAM WILDMAN SHUTE, 2ND VISCOUNT (1717-1793), eldest son of the 1st Viscount Barrington, was born on the 15th of January 1717. Succeeding to the title in 1734, he spent some time in travel, and in March 1740 was returned to parliament as member for Berwick-upon-Tweed. Having taken his seat in the Irish House of Lords in 1745, he was appointed one of the lords commissioners of the admiralty in 1746, and was one of the "managers" of the impeachment of Simon, Lord Lovat. In 1754 he became member of parliament for Plymouth, in 1755 was made a privy councillor and secretary at war, and in 1761 was transferred to the office of chancellor of the exchequer. In 1762 he became treasurer of the navy, and in 1765 returned to his former position of secretary at war. He retained this office until December 1778, and during four months in 1782 was joint postmaster-general. He married in 1740 Mary, daughter of Mr Henry Lovell, but left no children. He died at Becket on the 1st of February 1793, and was buried in Shrivensham church.

See Shute Barrington, *Political Life of William Wildman, Viscount Barrington* (London, 1814).

BARRISTER, in England and Ireland the term applied to the highest class of lawyers who have exclusive audience in all the superior courts, the word being derived from the "bar" (*q.v.*) in the law courts. Every barrister in England must be a member of one of the four ancient societies called Inns of Court, viz. Lincoln's Inn, the Inner and Middle Temples, and Gray's Inn, and in Ireland, of the King's Inns. The existence of the English societies as schools can be traced back to the 13th century, and their rise is attributed to the clause in Magna Carta, by which the Common Pleas were fixed at Westminster instead of following the king's court, and the professors of law were consequently brought together in London. Associations of lawyers acquired houses of their own in which students were educated in the common law, and the degrees of barrister (corresponding to apprentice or bachelor) and sergeant (corresponding to doctor) were conferred. These schools of law are now represented by the Inns of Court (*q.v.*).

Students are admitted as members of the Inns of Court, on paying certain fees and on passing a general (elementary) examination or (alternatively) producing evidence of having passed a public examination at a university; their subsequent call to the bar depends on their keeping twelve terms (of which there are four in each year), and passing certain further examinations (see ENGLISH LAW *ad fin.*). A term is "kept" by dining six times (three for a student whose name is on the books of a university) in hall. This is a relic of the older system in which examinations were not included, the only requisite being a certificate from a barrister that the student had read for twelve months in his chambers. Dining in hall then applied a certain social test, which has now become unmeaning. The profession of barrister is open to almost every one; but no person connected

with the law in any inferior capacity or who is a chartered or professional accountant, can enter an Inn of Court as a student until he has entirely and bona fide ceased to act or practise in such capacity. Some of the Inns also make a restriction that their members shall not be engaged in trade. A form of admission has to be filled up, containing a declaration to this effect, and mentioning *inter alia* the age, nationality, condition in life and occupation of the applicant. Previous to the student's call this declaration must be repeated, and he must further declare that he is not in holy orders, has not held any clerical preferment and has not performed any clerical functions during the year preceding. Subject to the above, practising solicitors of not less than five years' standing may be called to the bar without keeping any terms, upon passing the necessary examinations, and, *per contra*, a barrister of the same standing may, without any period of apprenticeship, become a solicitor upon passing the final examination for solicitors. Irish barristers of three years' standing may be called to the English bar without passing any examination upon keeping three terms, and so also may barristers of those colonies where the professions of barrister and solicitor are still kept distinct. No one can become a barrister till he is twenty-one years old.

The benchers of the different Inns of Court have the right of rejecting any applicant for membership with or without cause assigned; and for sufficient reasons, subject to an appeal to the common-law judges as visitors of the Inns, they may refuse to call a student to the bar, or may expel from their society or from the profession ("dis-bar" or "dis-bench") even barristers or benchers. The benchers appear to take cognizance of any kind of misconduct, whether professional or not, which they may deem unworthy of the rank of barrister. The grade of barrister comprehends the attorney-general and solicitor-general (appointed by and holding office solely at the will of the government of the day), who rank as the heads of the profession, king's counsel and ordinary practitioners, sometimes technically known as "utter barristers."

The peculiar business of barristers is the advocacy of causes in open court, but in England a great deal of other business falls into their hands. They are the chief conveyancers, and the pleadings (*i.e.* the counter statements of parties previous to joining issue) are in all but the simplest cases drafted by them. There was formerly, indeed, a separate class of conveyancers and special pleaders, being persons who kept the necessary number of terms qualifying for a call but who, instead of being called, took out licences, granted for one year only, but renewable, to practise under the bar, but now conveyancing and special pleading form part of the ordinary work of a junior barrister. The higher rank among barristers is that of king's or queen's counsel. They lead in court, and give opinions on cases submitted to them, but they do not accept conveyancing or pleading, nor do they admit pupils to their chambers. Precedence among king's counsel, as well as among outer barristers, is determined by seniority.¹ The old order of serjeants-at-law (*q.v.*) who ranked after king's counsel, is now extinct. Although every barrister has a right to practise in any court in England, each

¹ A king's counsel is appointed by letters patent to be "one of His Majesty's counsel learned in the law." The appointment rests with the lord chancellor, to whom the barrister desiring a silk gown makes application. There is no definite time required to elapse between "call" and application for a seat within the bar, but it is generally understood that a barrister must be of at least ten years' standing before he is appointed a king's counsel. The first king's counsel was Sir Francis Bacon, who was appointed by Queen Elizabeth "queen's counsel extraordinary," and received a payment, by way of "pledge and fee," of £40 a year, payable half-yearly. Succeeding king's counsel received a similar payment, until its abolition in 1831. There was not another appointment of a king's counsel until 1668, when Lord Chancellor Francis North was so honoured. From 1775 king's counsel may be said to have become a regular order. Their number was very small so late as the middle of the 19th century (20 in 1789; 30 in 1810; 28 in 1850), but at the beginning of the 20th century there were over 250. A king's counsel may not, unless by special licence, take a brief against the crown; but such a licence is never refused unless the crown desires his services in the case.

special class of business has its own practitioners, so that the bar may almost be said to be divided into several professions. The most marked distinction is that between barristers practising in chancery and barristers practising in the courts of common law. The fusion of law and equity brought about by the Judicature Acts 1873 and 1875 was expected in course of time to break down this distinction; but to a large extent the separation between these two great branches of the profession remains. There are also subordinate distinctions in each branch. Counsel at common law attach themselves to one or other of the circuits into which England is divided, and may not practise elsewhere unless under special conditions. In chancery the king's counsel for the most part restrict themselves to one or other of the courts of the chancery division. Business before the court of probate, divorce and admiralty, the privy council and parliamentary committees, exhibits, though in a less degree, the same tendency to specialization. In some of the larger provincial towns there are also local bars of considerable strength. The bar of Ireland exhibits in its general arrangements the same features as the bar of England. For the Scottish bar, see under ADVOCATES, FACULTY OF. There is no connexion whatever between the Scottish and English bars. A distinctive dress is worn by barristers when attending the courts, consisting of a stuff gown, exchanged for one of silk (whence the expression "to take silk") when the wearer has attained the rank of king's counsel, both classes also having wigs dating in pattern and material from the 18th century.

Counsel is not answerable for anything spoken by him relative to the cause in hand and suggested in the client's instructions, even though it should reflect on the character of another and prove absolutely groundless, but if he mention an untruth of his own invention, or even upon instructions if it be impertinent to the matter in hand, he is then liable to an action from the party injured. Counsel may also be punished by the summary power of the court or judge as for a contempt, and by the benchers of the inn to which he may belong on cause shown.

The rank of barrister is a necessary qualification for nearly all offices of a judicial character, and a very usual qualification for other important appointments. Not only the judgements in the superior courts of law and equity in England and in her colonies, but nearly all the magistracies of minor rank—recorderships, county court judgements, &c.—are restricted to the bar. The result is a unique feature in the English system of justice, viz. the perfect harmony of opinion and interest between the bar as a profession and all degrees of the judicial bench. Barristers have the rank of esquires, and are privileged from arrest whilst in attendance on the superior courts and on circuit, and also from serving on juries whilst in active practice.

Revising Barristers are counsel of not less than seven years' standing appointed to revise the lists of parliamentary voters.

Barristers cannot maintain an action for their fees, which are regarded as gratuities, nor can they, by the usage of the profession, undertake a case without the intervention of a solicitor, except in criminal cases, where a barrister may be engaged directly, by having a fee given him in open court, nor is it competent for them to enter into any contract for payment by their clients with respect to litigation.

See J. R. V. Marchant, *Barrister-at-law: an Essay on the legal position of Counsel in England* (1905).

BARROIS, CHARLES (1851—), French geologist, was born at Lille on the 21st of April 1851, and educated at the college in that town, where he studied geology under Prof. Jules Gosselet and qualified as D. ès Sc. To this master he dedicated his first comprehensive work, *Recherches sur le terrain crétacé supérieur de l'Angleterre et de l'Irlande*, published in the *Mémoires de la société géologique du Nord* in 1876. In this essay the palaeontological zones in the Chalk and Upper Greensand of Britain were for the first time marked out in detail, and the results of Dr Barrois's original researches have formed the basis of subsequent work, and have in all leading features been confirmed. In 1876 Dr Barrois was appointed a collaborateur to the French Geological Survey, and in 1877 professor of geology in the university

of Lille. In other memoirs, among which may be mentioned those on the Cretaceous rocks of the Ardennes and of the Basin of Oviedo, Spain; on the (Devonian) Calcaire d'Erbray; on the Palaeozoic rocks of Brittany and of northern Spain; and on the granitic and metamorphic rocks of Brittany, Dr Barrois has proved himself an accomplished petrologist as well as palaeontologist and field-geologist. In 1881 he was awarded the Bigsby medal, and in 1901 the Wollaston medal by the Geological Society of London. He was chosen member of the Institute (Academy of Sciences) in 1904.

BARROS, JOÃO DE (1496-1570), called the Portuguese Livy, may be said to have been the first great historian of his country. Educated in the palace of King Manoel, he early conceived the idea of writing history, and, to prove his powers, composed, at the age of twenty, a romance of chivalry, the *Chronicle of the Emperor Clarimundo*, in which he is said to have had the assistance of Prince John, afterwards King John III. The latter, on ascending the throne, gave Barros the captaincy of the fortress of St George of Elmira, whither he proceeded in 1522, and he obtained in 1525 the post of treasurer of the India House, which he held until 1528. The pest of 1530 drove him from Lisbon to his country house near Pombal, and there he finished a moral dialogue, *Rhópica Pneuma*, which met with the applause of the learned Juan Luis Vives. On his return to Lisbon in 1532 the king appointed Barros factor of the India and Mina House—positions of great responsibility and importance at a time when Lisbon was the European emporium for the trade of the East. Barros proved a good administrator, displaying great industry and a disinterestedness rare in that age, with the result that he made but little money where his predecessors had amassed fortunes. At this time, John III., wishing to attract settlers to Brazil, divided it up into captaincies and gave that of Maranhão to Barros, who, associating two partners in the enterprise with himself, prepared an armada of ten vessels, carrying nine hundred men, which set sail in 1530. Owing to the ignorance of the pilots, the whole fleet suffered shipwreck, which entailed serious financial loss on Barros, yet not content with meeting his own obligations, he paid the debts of those who had perished in the expedition. During all these busy years he had continued his studies in his leisure hours, and shortly after the Brazilian disaster he offered to write a history of the Portuguese in India, which the king accepted. He began work forthwith, but, before printing the first part, he again proved his pen by publishing a Portuguese grammar (1540) and some more moral Dialogues. The first of the Decades of his *Asia* appeared in 1552, and its reception was such that the king straightway charged Barros to write a chronicle of King Manoel. His many occupations, however, prevented him from undertaking this book, which was finally composed by Damião de Goes (q.v.). The Second Decade came out in 1553 and the Third in 1563, but the Fourth and final one was not published until 1615, long after the author's death. In January 1568 Barros retired from his remunerative appointment at the India House, receiving the rank of *fidalgão* together with a pension and other pecuniary emoluments from King Sebastian, and died on the 20th of October 1570. A man of lofty character, he preferred leaving his children an example of good morals and learning to bequeathing them a large pecuniary inheritance, and, though he received many royal benefactions, they were volunteered, never asked for. As an historian and a stylist Barros deserves the high fame he has always enjoyed. His Decades contain the early history of the Portuguese in Asia and reveal careful study of Eastern historians and geographers, as well as of the records of his own country. They are distinguished by clearness of exposition and orderly arrangement. His style has all the simplicity and grandeur of the masters of historical writing, and the purity of his diction is incontestable. Though, on the whole, impartial, Barros is the narrator and apologist of the great deeds of his countrymen, and lacks the critical spirit and intellectual acumen of Damião de Goes. Diogo do Couto continued the Decades, adding nine more, and a modern edition of the whole appeared in Lisbon in 14 vols. in 1778-1788. The title of Barros's work is *Da Asia de João de Barros, dos feitos que os Portuguezes fizeram no descobrimento e*

conquista dos mares e terras do Oriente, and the edition is accompanied by a volume containing a life of Barros by the historian Manoel Severim de Faria and a copious index of all the Decades. An Italian version in 2 vols. appeared in Venice in 1561-1562 and a German in 5 vols. in 1821. *Clarimundo* has gone through the following editions: 1522, 1555, 1601, 1748, 1791 and 1843, all published in Lisbon. It influenced Francisco de Moraes (q.v.); cf. Pursler, *Palmerin of England*, Dublin, 1904, pp. 440 et seq.

The minor works of Barros are described by Innocencio da Silva: *Dicionario Bibliographico Portuguez*, vol. iii, pp. 320-323 and vol. x, pp. 187-180, and in Severim de Faria's *Life*, cited above. A compilation of Barros's *Varia* was published by the visconde de Azevedo (Porto, 1869). (E. Pk.)

BARROT, CAMILLE HYACINTHE ODILON (1791-1873), French politician, was born at Villefort (Lozère) on the 10th of September 1791. He belonged to a legal family, his father, an advocate of Toulouse, having been a member of the Convention who had voted against the death of Louis XVI. Odilon Barrot's earliest recollections were of the October insurrection of 1795. He was sent to the military school of Saint-Cyr, but presently removed to the Lycée Napoleon to study law and was called to the Parisian bar in 1811. He was placed in the office of the *conventional* Jean Mailhe, who was advocate before the council of state and the court of cassation and was proscribed at the second restoration. Barrot eventually succeeded him in both positions. His dissatisfaction with the government of the restoration was shown in his conduct of some political trials. For his opposition in 1820 to a law by which any person might be arrested and detained on a warrant signed by three ministers, he was summoned before a court of *assize*, but acquitted. Although intimate with Lafayette and others, he took no actual share in their schemes for the overthrow of the government, but in 1827 he joined the association known as *Aide-toi, le ciel t'aidera*. He presided over the banquet given by the society to the 221 deputies who had signed the address of March 1830 to Charles X., and threatened to reply to force by force. After the ordinances of the 26th of July 1830, he joined the National Guard and took an active part in the revolution. As secretary of the municipal commission, which sat at the *hôtel-de-ville* and formed itself into a provisional government, he was charged to convey to the chamber of deputies a protest embodying the terms which the advanced Liberals wished to impose on the king to be elected. He supported the idea of a constitutional monarchy against the extreme Republicans, and he was appointed one of the three commissioners chosen to escort Charles X. out of France. On his return he was nominated prefect of the department of the Seine. His concessions to the Parisian mob and his extreme gentleness towards those who demanded the prosecution of the ministers of Charles X. led to an unflattering comparison with Jérôme Pétion under similar circumstances. Louis Philippe's government was far from satisfying his desires for reform, and he persistently urged the "broadening of the bases of the monarchy," while he protested his loyalty to the dynasty. He was returned to the chamber of deputies for the department of Eure in 1831. The day after the demonstration of June 1832 on the occasion of the funeral of General Lamarque, he made himself indirectly the mouthpiece of the Democrats in an interview with Louis Philippe, which is given at length in his *Mémoires*. Subsequently, in pleading before the court of cassation on behalf of one of the rioters, he secured the annulling of the judgments given by the council of war. The death of the duke of Orleans in 1842 was a blow to Barrot's party, which sought to substitute the regency of the duchess of Orleans for that of the duke of Nemours in the event of the succession of the count of Paris. In 1846 Barrot made a tour in the Near East, returning in time to take part a second time in the preliminaries of revolution. He organized banquets of the disaffected in the various cities of France, and demanded electoral reform to avoid revolution. He did not foresee the strength of the outbreak for which his eloquence had prepared the way, and clung to the programme of 1830. He tried to support the regency of the duchess in the chamber on the 24th of February, only to find that the time was past for

half-measures. He acquiesced in the republic and gave his adhesion to General Cavaignac. He became the chief of Louis Napoleon's first ministry in the hope of extracting Liberal measures, but was dismissed in 1849 as soon as he had served the president's purpose of avoiding open conflict. After the *coup d'état* of December 1851 he was one of those who sought to accuse Napoleon of high treason. He was imprisoned for a short time and retired from active politics for some ten years. He was drawn once more into affairs by the hopes of reform held out by Émile Ollivier, accepting in 1869 the presidency of an extra-parliamentary committee on decentralization. After the fall of the empire he was nominated by Thiers, whom he had supported under Louis Philippe, president of the council of state. But his powers were now failing, and he had only filled his new office for about a year when he died at Bougival on the 6th of August 1873. He had been sufficiently an optimist to believe in the triumph of the liberal but non-republican institutions dear to him under the restoration, under Louis Philippe and Louis Napoleon successively. He was unable to foresee and unwilling to accept the consequences of his political agitation in 1830 and 1848, and in spite of his talents and acknowledged influence he thus failed to secure the honours won by more uncompromising politicians. He was described by Thureau-Dangin as "le plus solennel des indécis, le plus méditatif des irréflexifs, le plus heureux des ambitieux, le plus austère des courtisans de la foule."

His personal relations with Louis Philippe and Napoleon, with his views on the events in which he was concerned, are described in the four volumes of his *Mémoires*, edited by Duvierger de Hauranne in 1875-1876. See also Thureau-Dangin, *Histoire de la monarchie de juillet*.

BARROW, ISAAC (1630-1677), English mathematician and divine, was the son of Thomas Barrow, a linen-draper in London, belonging to an old Suffolk and Cambridgeshire family. His uncle was Bishop Isaac Barrow of St Asaph (1614-1680). He was at first placed for two or three years at the Charterhouse school. There, however, his conduct gave but little hopes of his ever succeeding as a scholar. But after his removal from this establishment to Felsted school in Essex, where Martin Holbeach was master, his disposition took a happier turn; and having soon made considerable progress in learning, he was in 1643 entered at St Peter's College, and afterwards at Trinity College, Cambridge, where he applied himself to the study of literature and science, especially of natural philosophy. He at first intended to adopt the medical profession, and made some progress in anatomy, botany and chemistry, after which he studied chronology, geometry and astronomy. He then travelled in France and Italy, and in a voyage from Leghorn to Smyrna gave proofs of great personal bravery during an attack made by an Algerine pirate. At Smyrna he met with a kind reception from the English consul, Mr Bretton, upon whose death he afterwards wrote a Latin elegy. From this place he proceeded to Constantinople, where he received similar civilities from Sir Thomas Bendish, the English ambassador, and Sir Jonathan Dawes, with whom he afterwards contracted an intimate friendship. While at Constantinople he read and studied the works of St Chrysostom, whom he preferred to all the other Fathers. He resided in Turkey somewhat more than a year, after which he proceeded to Venice, and thence returned home through Germany and Holland in 1659.

Immediately on his reaching England he received ordination from Bishop Brownrigg, and in 1660 he was appointed to the Greek professorship at Cambridge. When he entered upon this office he intended to have prelected upon the tragedies of Sophocles; but he altered his intention and made choice of Aristotle's rhetoric. His lectures on this subject, having been lent to a friend who never returned them, are irrecoverably lost. In July 1662 he was elected professor of geometry in Gresham College, on the recommendation of Dr John Wilkins, master of Trinity College and afterwards bishop of Chester; and in May 1663 he was chosen a fellow of the Royal Society, at the first election made by the council after obtaining their charter. The same year the executors of Henry Lucas, who, according to the

terms of his will, had founded a mathematical chair at Cambridge, fixed upon Barrow as the first professor; and although his two professorships were not inconsistent with each other, he chose to resign that of Gresham College, which he did on the 20th of May 1664. In 1669 he resigned his mathematical chair to his pupil, Isaac Newton, having now determined to renounce the study of mathematics for that of divinity. Upon quitting his professorship Barrow was only a fellow of Trinity College; but his uncle gave him a small sinecure in Wales, and Dr Seth Ward, bishop of Salisbury, conferred upon him a prebend in that church. In the year 1670 he was created doctor in divinity by mandate; and, upon the promotion of Dr Pearson to the see of Chester, he was appointed to succeed him as master of Trinity College by the king's patent, bearing the date of the 13th of February 1672. In 1675 Dr Barrow was chosen vice-chancellor of the university. He died on the 4th of May 1677, and was interred in Westminster Abbey, where a monument, surmounted by his bust, was soon after erected by the contributions of his friends.

By his English contemporaries Barrow was considered a mathematician second only to Newton. Continental writers do not place him so high, and their judgment is probably the more correct one. He was undoubtedly a clear-sighted and able mathematician, who handled admirably the severe geometrical method, and who in his *Method of Tangents* approximated to the course of reasoning by which Newton was afterwards led to the doctrine of ultimate ratios; but his substantial contributions to the science are of no great importance, and his lectures upon elementary principles do not throw much light on the difficulties surrounding the border-land between mathematics and philosophy. (See INFINITESIMAL CALCULUS.) His *Sermons* have long enjoyed a high reputation; they are weighty pieces of reasoning, elaborate in construction and ponderous in style.

His scientific works are very numerous. The most important are:—*Euclid's Elements*; *Euclid's Data*; *Optical Lectures*, read in the public school of Cambridge; *Thirteen Geometrical Lectures*; *The Works of Archimedes, the Four Books of Apollonius's Conic Sections, and Theodorus's Spherics, explained in a New Method*; *A Lecture*, in which Archimedes' Theorems of the Sphere and Cylinder are investigated and briefly demonstrated; *Mathematical Lectures*, read in the public schools of the university of Cambridge. The above were all written in Latin. His English works have been collected and published in four volumes folio.

See Ward, *Lives of the Gresham Professors*, and Whewell's biography prefixed to the 9th volume of Napier's edition of Barrow's *Sermons*.

BARROW, SIR JOHN (1764-1848), English statesman, was born in the village of Dragley Beck in the parish of Ulverston in Lancashire, on the 10th of June 1764. He started in life as superintending clerk of an iron foundry at Liverpool and afterwards taught mathematics at a school in Greenwich. Through the interest of Sir George Staunton, to whose son he taught mathematics, he was attached on the first British embassy to China as comptroller of the household to Lord Macartney. He soon acquired a good knowledge of the Chinese language, on which he subsequently contributed interesting articles to the *Quarterly Review*; and the account of the embassy published by Sir George Staunton records many of Barrow's valuable contributions to literature and science connected with China.

Although Barrow ceased to be officially connected with Chinese affairs after the return of the embassy in 1794, he always took much interest in them, and on critical occasions was frequently consulted by the British government. In 1797 he accompanied Lord Macartney, as private secretary, in his important and delicate mission to settle the government of the newly acquired colony of the Cape of Good Hope. Barrow was entrusted with the task of reconciling the Boers and Kafirs and of reporting on the country in the interior. On his return from his journey, in the course of which he visited all parts of the colony, he was appointed auditor-general of public accounts. He now decided to settle in South Africa, married Anne Maria Trütter, and in 1800 bought a house in Cape Town. But the surrender of the colony at the peace of Amiens (1802) upset this plan. He returned to England in 1804, was appointed by Lord Melville second secretary to the admiralty, a post which he held for

forty years. He enjoyed the esteem and confidence of all the eleven chief lords who successively presided at the admiralty board during that period, and more especially of King William IV. while lord high admiral, who honoured him with tokens of his personal regard. Barrow was a fellow of the Royal Society, and in 1821 received the degree of LL.D. from Edinburgh University. A baronetcy was conferred on him by Sir Robert Peel in 1835. He retired from public life in 1845 and devoted himself to writing a history of the modern Arctic voyages of discovery (1846), of which he was a great promoter, as well as his autobiography, published in 1847. He died suddenly on the 23rd of November 1848.

Besides the numerous articles in the *Quarterly Review* already mentioned, Barrow published among other works, *Travels in China* (1804); *Travels into the Interior of South Africa* (1806); and lives of Lord Macartney (1807), Lord Anson (1830), Lord Howe (1838). He was also the author of several valuable contributions to the seventh edition of the *Encyclopaedia Britannica*.

See *Memoir* of John Barrow, by G. F. Staunton (1852).

BARROW, a river of south-eastern Ireland. It rises in the Slieve Bloom mountains, and flows at first easterly and then almost due south, until, on joining the Suir, it forms the estuary of the south coast known as Waterford Harbour. Including the 12 m. of the estuary, the length of its valley is rather more than 100 m., without counting the lesser windings of the river. The total area of drainage to Waterford Harbour (including the basin of the Suir) is 3500 sq. m., and covers the whole of the county Kilkenny, with parts of Waterford, Cork and Limerick, Tipperary, Carlow, King's and Queen's counties. The chief towns on the banks of the Barrow are Athy (where it becomes navigable and has a junction with the Grand Canal), Carlow, Bagenalstown and New Ross. The chief affluent is the Nore, which it receives from the north-west a little above New Ross. The scenery on its banks is in parts very beautiful.

BARROW (from A.S. *beorh*, a mount or hillock), a word found occasionally among place-names in England applied to natural eminences, but generally restricted in its modern application to denote an ancient grave-mound. The custom of constructing barrows or mounds of stone or earth over the remains of the dead was a characteristic feature of the sepulchral systems of primitive times. Originating in the common sentiment of humanity, which desires by some visible memorial to honour and perpetuate the memory of the dead, it was practised alike by peoples of high and of low development, and continued through all the stages of culture that preceded the introduction of Christianity. The primary idea of sepulture appears to have been the provision of a habitation for the dead; and thus, in its perfect form, the barrow included a chamber or chambers where the tenant was surrounded with the prized possessions of his previous life. A common feature of the earlier barrows is the enclosing fence, which marked off the site from the surrounding ground. When the barrow was of earth, this was effected by an encircling trench or a low *vallum*. When the barrow was a stone structure, the enclosure was usually a circle of standing stones. Sometimes, instead of a chamber formed above ground, the barrow covered a pit excavated for the interment under the original surface. In later times the mound itself was frequently dispensed with, and the interments made within the enclosure of a trench, a *vallum* or a circle of standing stones. Usually the great barrows occupy conspicuous sites; but in general the external form is no index to the internal construction and gives no definite indication of the nature of the sepulchral usages. Thus, while the long barrow is characteristic of the Stone Age, it is impossible to tell without direct examination whether it may be chambered or unchambered, or whether the burials within it may be those of burnt or of unburnt bodies.

In England the long barrow usually contains a single chamber, entering by a passage underneath the higher and wider end of the mound. In Denmark the chambers are at irregular intervals along the body of the mound, and have no passages leading into them. The long barrows of Great Britain are often from 200 to

400 ft. in length by 60 to 80 ft. wide. Their chambers are rudely but strongly built, with dome-shaped roofs, formed by overlapping the successive courses of the upper part of the side walls. In Scandinavia, on the other hand, such dome-roofed chambers are unknown, and the construction of the chambers as a rule is megalithic, five or six monoliths supporting one or more capstones of enormous size. Such chambers, denuded of the covering mound, or over which no covering mound has been raised, are popularly known in England as "cromlechs" and in France as "dolmens" (see STONE MONUMENTS). The prevailing mode of sepulture in all the different varieties of these structures is by the deposit of the body in a contracted position, accompanied by weapons and implements of stone, occasionally by ornaments of gold, jet or amber. Vessels of clay, more or less ornate in character, which occur with these early interments of unburnt bodies, have been regarded as food-vessels and drinking-cups, differing in character and purpose from the cinerary urns of larger size in which the ashes of the dead were deposited after cremation.

The custom of burning the body commenced in the Stone Age, before the long barrow or the dolmen had passed out of use. While cremation is rare in the long barrows of the south of England, it is the rule in those of Yorkshire and the north of Scotland. In Ireland, where the long barrow form is all but unknown, the round barrow or chambered cairn prevailed from the earliest Pagan period till the introduction of Christianity. The Irish barrows occur in groups in certain localities, some of which seem to have been the royal cemeteries of the tribal confederacies, whereof eight are enumerated in an ancient Irish manuscript, the *Leabhar na h-Uidhri*, compiled c. A.D. 1100. The best-known of these is situated on the banks of the Boyne above Drogheda, and consists of a group of the largest cairns in Ireland. One, at New Grange, is a huge mound of stones and earth, over 300 ft. in diameter and 70 ft. in height. Around its base are the remains of a circle of large standing stones. The chamber, which is 20 ft. high in the centre, is reached by a passage about 70 ft. in length. In the Loughcrew Hills, Co. Meath, there is a group of about thirty stone barrows or cairns, mostly chambered, their bases measuring from 5 or 6 to 60 yds. in diameter. They are unusually interesting from the fact that many of the exposed slabs in the walls of the chambers are ornamented with spirals and other devices, rudely incised. As in the case of the long barrows, the traditional form of the circular, chambered barrow was retained through various changes in the sepulchral customs of the people. It was the natural result of the practice of cremation, however, that it should induce a modification of the barrow structure. The chamber, no longer regarded as a habitation to be tenanted by the deceased, became simply a cist for the reception of the urn which held his ashes. The degradation of the chamber naturally produced a corresponding degradation of the mound which covered it, and the barrows of the Bronze Age, in which cremation was common, are smaller and less imposing than those of the Stone Age, but often surprisingly rich in the relics of the life and of the art workmanship of the time. In addition to the varied and beautiful forms of implements and weapons—frequently ornamented with a high degree of artistic taste—armlets and other personal ornaments in gold, amber, jet and bronze are not uncommon. The barrows of the bronze period, like some of those of the Stone Age, appear to have been used as tribal or family cemeteries. In Denmark as many as seventy deposits of burnt interments have been observed in a single mound, indicating its use as a burying-place throughout a long succession of years.

In the Iron Age there was less uniformity in the burial customs. In some of the barrows in central France, and in the wolds of Yorkshire, the interments include the arms and accoutrements of a charioteer, with his chariot, harness and horses. In Scandinavia a custom, alluded to in the sagas, of burying the viking in his ship, drawn up on land, and raising a barrow over it, is exemplified by the ship-burials discovered in Norway. The ship found in the Gokstad mound was 78 ft. long, and had a mast and sixteen pairs of oars. In a chamber abaft the mast the viking had been laid, with his weapons, and together with him were

buried twelve horses, six dogs and a peacock. An interesting example of the great timber-chambered barrow is that at Jelling in Jutland, known as the barrow of Thyre Danebod, queen of King Gorm the Old, who died about the middle of the 10th century. It is a mound about 200 ft. in diameter, and over 50 ft. in height, containing a chamber 23 ft. long, 8 ft. wide and 5 ft. high, formed of massive slabs of oak. Though it had been entered and plundered in the middle ages, a few relics were found when it was reopened, among which were a silver cup, ornamented with the interlacing work characteristic of the time and some personal ornaments. It is highly illustrative of the tenacity with which the ancient sepulchral usages were retained even after the introduction of Christianity that King Harold, son and successor of Gorm the Old, who is said to have christianized all Denmark and Norway, followed the pagan custom of erecting a chambered tumulus over the remains of his father, on the summit of which was placed a rude pillar-stone, bearing on one side the memorial inscription in runes, and on the other a representation of the Saviour of mankind distinguished by the crossed nimbus surrounding the head. The so-called Kings' Hoves at Upsala in Sweden rival those of Jelling in size and height. In the chamber of one, opened in 1820, there was found an urn full of calcined bones; and along with it were ornaments of gold showing the characteristic workmanship of the 5th and 6th centuries of the Christian era. Along with the calcined human bones were bones of animals, among which those of the horse and the dog were distinguished.

Comparing the results of the researches in European barrows with such notices of barrow-burial as may be gleaned from early writings, we find them mutually illustrative.

The Homeric account of the building of the barrow of Hector (*Il.* xxiv.) brings vividly before us the scene so often suggested by the examination of the tumuli of prehistoric times. During nine days wood was collected and brought, in carts drawn by oxen, to the site of the funeral pyre. Then the pyre was built and the body laid upon it. After burning for twenty-four hours the smouldering embers were extinguished with libations of wine. The white and calcined bones were then picked out of the ashes by the friends and placed in a metallic urn, which was deposited in a hollow grave or cist and covered over with large well-fitting stones. Finally, a barrow of great magnitude was heaped over the remains and the funeral feast was celebrated. The obsequies of Achilles, as described in the *Odyssey*, were also celebrated with details which are strikingly similar to those observed in tumuli both of the Bronze and Iron Ages. The body was brought to the pile in an embroidered robe and jars of unguents and honey were placed beside it. Sheep and oxen were slaughtered at the pile. The incinerated bones were collected from the ashes and placed in a golden urn along with those of Patroclus, Achilles's dearest friend. Over the remains a great and shapely mound was raised on the high headland, so that it might be seen from afar by future generations of men.

Herodotus, describing the funeral customs of the Scythians, states that, on the death of a chief, the body was placed upon a couch in a chamber sunk in the earth and covered with timber, in which were deposited all things needful for the comfort of the deceased in the other world. One of his wives was strangled and laid beside him, his cup-bearer and other attendants, his charioteer and his horses were killed and placed in the tomb, which was then filled up with earth and an enormous mound raised high over all. The barrows which cover the plains of ancient Scythia attest the truth of this description. A Siberian barrow, described by Demidov, contained three contiguous chambers of unhewn stone. In the central chamber lay the skeleton of the ancient chief, with his sword, his spear, his bow and a quiver full of arrows. The skeleton reclined upon a sheet of pure gold, extending the whole length of the body, which had been wrapped in a mantle brodered with gold and studded with precious stones. Over it was extended another sheet of pure gold. In a smaller chamber at the chief's head lay the skeleton of a female, richly attired, extended upon a sheet of pure gold and similarly covered with a sheet of the same metal. A golden chain adorned her neck and her arms were

encircled with bracelets of pure gold. In a third chamber, at the chief's feet, lay the skeleton of his favourite horse with saddle, bridle and stirrups.

So curiously alike in their general features were the sepulchral usages connected with barrow-burial over the whole of Europe, that we find the Anglo-Saxon Saga of Beowulf describing the chambered tumulus with its gigantic masonry "held fast on props, with vaults of stone," and the passage under the mound haunted by a dragon, the guardian of the treasures of heathen gold which it contained. Beowulf's own burial is minutely described in terms which have a strong resemblance to the parallel passages in the *Iliad* and *Odyssey*. There is first the preparation of the pile, which is hung round with helmets, shields and coats of mail. Then the corpse is brought and laid in the midst; the pile is kindled and the roaring flame rises, mingled with weeping, till all is consumed. Then, for ten long days, the warriors labour at the rearing of his mighty mound on the headland, high and broad, to be seen afar by the passers-by on land and sea.

The pyramids of Egypt, the mausolea of the Lydian kings, the circular, chambered sepulchres of Mycenae, and the Etruscan tombs at Caere and Volci, are lineally descended from the chambered barrows of prehistoric times, modified in construction according to the advancement of architectural art at the period of their erection. There is no country in Europe destitute of more or less abundant proofs of the almost universal prevalence of barrow-burial in early times. It can also be traced on both sides of the basin of the Mediterranean, and from Asia Minor across the continent to India, China and Japan.

In the new world as well as in the old, similar customs prevailed from a very remote period. In the great plains of North America the dead were buried in barrows of enormous magnitude, which occasionally present a remarkable similarity to the barrows of Great Britain. In these mounds cremation appears more frequently than inhumation; and both are accompanied by implements, weapons and ornaments of stone and bone. The pottery accompanying the remains is often elaborately ornamented, and the mound builders were evidently possessed of a higher development of taste and skill than is evinced by any of the modern aboriginal races, by whom the mounds and their contents are regarded as utterly mysterious.

It is not to be wondered at that customs so widely spread and so deeply rooted as those connected with barrow-burial should have been difficult to eradicate. In fact, compliance with the Christian practice of inhumation in the cemeteries sanctioned by the church, was only enforced in Europe by capitularies denouncing the punishment of death on those who persisted in burying their dead after the pagan fashion or in the pagan mounds. Yet even in the middle ages kings of Christian countries were buried with their swords and spears, and queens with their spindles and ornaments; the bishop was laid in his grave with his crozier and comb; the priest with his chalice and vestments; and clay vessels filled with charcoal (answering to the urns of heathen times) are found in the churches of France and Denmark.

AUTHORITIES.—Canon W. Greenwell, *British Barrows* (London, 1877); Dr J. Thurnam, "On Ancient British Barrows," in *Archæologia*, vols. 42, 43 (1869); J. R. Mortimer, *Forty Years' Researches in Burial Mounds of East Yorkshire* (London, 1905); T. Anderson, *Scotland in Pagan Times* (Edinburgh, 1886); Dr T. H. Bryce, "Records of Explorations among the Cairns of Arran and Butte," in *Proceedings of the Society of Antiquaries of Scotland*, vols. 36, 37, 38 (1901-1903); W. C. Borlase, *The Dolmens of Ireland* (London, 1897); *Dictionnaire archéologique de la Gaule* (Paris, 1875); A. P. Madsen, *Gravhøi og Grafsund fra Stenalderen i Danmark* (Copenhagen, 1900); S. Müller, *Nordische Altertumskunde aus Dänemark und Schleswig* (Strassburg, 1897); O. Montelius, *The Civilization of Sweden in Heathen Times* (London, 1888) and *Der Orient und Europa* (Stockholm, 1890); E. Cartailhac, *Les Âges préhistoriques de l'Espagne et du Portugal* (Paris, 1886); W. Gowland, "The Dolmens and Burial Mounds in Japan," in *Archæologia*, vol. 55 (1897); C. Thomas, "Report on the Mound Explorations of the Bureau of Ethnology" (*Twelfth Annual Report for 1890-1891*, Washington, 1894). (J. AN.)

BARROWE, HENRY (? 1550-1593), English Puritan and Separatist, was born about 1550, at Shipdam, Norfolk, of a family related by marriage to the lord keeper Bacon, and

probably to Aymer, bishop of London. He matriculated at Clare Hall, Cambridge, in November 1566, and graduated B.A. in 1569-1570. Afterwards he "followed the court" for some time, leading a frivolous if not licentious life. He was a member of Gray's Inn for a few years from 1576, but was never called to the bar. About 1580 or 1581 he was deeply impressed by a sermon, whereupon he retired to the country, and was led by study and meditation to the strictest form of Puritanism. Subsequently, in what manner is not known, he came into intimate relations with John Greenwood, the Separatist leader, whose views (probably due, in part at least, to Browne's influence) he adopted without reserve. Though not strictly resident in London at this time, he was associated with "the brethren of the Separation" there, in whose secret meetings his natural earnestness and eloquence made him conspicuous. Greenwood having been imprisoned in the Clink, Barrow came from the country to visit him, and on the 10th of November 1586 was detained by the gaoler and brought before Archbishop Whitgift. He insisted on the illegality of this arrest, refused either to take the *ex officio* oath or to give bail for future appearance, and was committed to the Gatehouse. After nearly six months' detention and several irregular examinations before the high commissioners, he and Greenwood were formally indicted (May 1587) for recusancy under an act originally directed against Papists. They were ordered to find heavy bail for conformity, and to remain in the Fleet Prison until it was forthcoming. Barrow continued a prisoner for the remainder of his life, nearly six years, sometimes in close confinement, sometimes having "the liberty of the prison." He was subjected to several more examinations, once before the privy council at Whitehall on the 18th of March 1588, as a result of petition to the queen. On these occasions he vigorously maintained the principle of separatism, denouncing the prescribed ritual of the Church as "a false worship," and the bishops as oppressors and persecutors. During his imprisonments he was engaged in written controversy with Robert Browne (down to 1588), who had yielded a partial submission to the established order, and whom he therefore accounted a renegade. He also wrote several vigorous treatises in defence of separatism and congregational independency, the most important being:—*A True Description of the Visible Congregation of the Saints, &c.* (1580); *A Plain Refutation of Mr Gifford's Booke, intituled A Short Treatise Gainst the Donatistes of England* (1590-1591); and *A Brief Discovery of the False Church* (1591). Others were written in conjunction with his fellow-prisoner, Greenwood. These writings were taken charge of by friends and mostly printed in Holland. By 1590 the bishops thought it advisable to try other means of convincing or silencing these indomitable controversialists, and sent several conforming Puritan ministers to confer with them, but without effect. At length it was resolved to proceed on a capital charge of "devising and circulating seditious books," for which, as the law then stood, it was easy to secure a conviction. They were tried and sentenced to death on the 23rd of March 1593. What followed is, happily, unique in the history of English misrule. The day after sentence they were brought out as if for execution and respited. On the 31st of March they were taken to the gallows, and after the ropes had been placed about their necks were again respited. Finally they were hanged early on the morning of the 6th of April. The motive of all this is obscure, but there is some evidence that the lord treasurer Burghley endeavoured to save their lives, and was frustrated by Whitgift and other bishops.

The opinions of Browne and Barrowe had much in common, but were not identical. Both maintained the right and duty of the Church to carry out necessary reforms without awaiting the permission of the civil power; and both advocated congregational independency. But the ideal of Browne was only a means. Barrowe, on the other hand, regarded the whole established church order as polluted by the relics of Roman Catholicism, and insisted on separation as essential to pure worship and discipline (see further CONGREGATIONALISM). Barrowe has been

credited by H. M. Dexter and others with being the author of the "Marprelate Tracts"; but this is improbable.

AUTHORITIES.—H. M. Dexter, *The Congregationalism of the Last Three Hundred Years*; F. J. Powicke, *Henry Barrowe and the Exiled Church*. See also B. Brook, *Lives of the Puritans*; and Cooper, *Athenae Cantabrigienses* (1861), vol. ii.

BARROW-IN-FURNESS, a seaport and municipal county and parliamentary borough of Lancashire, England, 26½ m. N.W. by N. from London, on the Furness railway. Pop. (1891) 51,712; (1901) 57,586. It lies on the seaward side of the hammer-shaped peninsula forming part of the district of Furness, between the estuary of the Duddon and Morecambe Bay, where a narrow channel intervenes between the mainland and the long low island of Walney, on which the erection of a strong fort was undertaken by the War Office in 1904. In 1905 the connexion of Walney with the mainland by a bridge was undertaken. In the channel is Barrow Island (among others) which is connected with the mainland, reclamation having been carried on until only a narrow channel was left, which was utilized as docks. Barrow is of modern and remarkably rapid growth. Its rise was dependent primarily on the existence and working of the veins of pure haematite iron ore in the district of Furness (q.v.). At the outset Barrow merely exported the ore to the furnaces of South Wales and the midlands. At the beginning of the 19th century this export amounted at most to a few thousand tons, and though by the middle of the century it had reached some 50,000 in 1847 the population of Barrow was only 325. In 1846 the first section of the Furness railway was opened, connecting Barrow with the mines near Dalton; in the ensuing years a great increase in trade justified the opening of further communications, and in 1859 the iron works of Messrs Schneider & Hannay were instituted. The Barrow Haematite Steel Company (1866) absorbed this company, and a great output of steel produced by the Bessemer process was begun. Other industries followed. Of these the shipbuilding works have surpassed the steel works in importance, the celebrated firm of Vickers, Sons & Maxim having a yard where they construct numerous vessels of war as well as others. There are also a petroleum storage establishment, a paper-pulp factory, jute works, and engineering and wagon works.

The docks in the strait between Barrow Island and the mainland were constructed in 1867, and named the Devonshire and Buccleuch docks. The Ramsden docks are a subsequent extension. These are 24 ft. in depth. There are also a graving dock 500 ft. long, a depositing dock accommodating vessels of 16 ft. draught, and two electric cranes each able to lift 150 tons. The Furness railway company is the dock authority. Passenger steamers run on weekdays to Belfast.

The town is laid out in rectangular form, and contains several handsome churches, municipal buildings, exchange and other public buildings. An electric tramway service connects the outskirts and the centre. There are statues of Lord Frederick Cavendish (assassinated at Dublin, 1882), in front of the town-hall, and of Sir James Ramsden (d. 1896), managing director of the Furness railway and first mayor of Barrow, to whom, together with the dukes of Devonshire and Buccleuch, the town owed much of its rise in the middle of the 19th century. The cottage inhabited by George Romney the painter from 1742 to 1755 has been preserved from demolition and retained as a memorial. Educational institutions include a school of science and art, a girls' high school and a technical school. Barrow is a suffragan bishopric in the diocese of Carlisle. The parliamentary borough (1885), falling within the North Lonsdale division of the county, returns one member. The town was incorporated in 1867, and became a county borough in 1888. The corporation consists of a mayor, 8 aldermen and 24 councillors. Area, 11,023 acres.

BARRY, SIR CHARLES (1795-1860), English architect, was born in London on the 23rd of May 1795, the son of a stationer. He was articled to a firm of architects, with whom he remained till 1817, when he set out on a three years' tour in Greece and Italy, Egypt and Palestine for the purpose of studying

architecture. On his return to England in 1820 he settled in London. One of the first works by which his abilities as an architect became generally known was the church of St Peter at Brighton, completed in 1826. He built many other churches; but the marked preference for Italian architecture, which he acquired during his travels, showed itself in various important undertakings of his earlier years. In 1831 he completed the Travellers' Club in Pall Mall, a splendid work in the Italian style and the first of its kind built in London. In the same style and on a grander scale he built in 1837 the Reform Club. He was also engaged on numerous private mansions in London, the finest being Bridgewater House (1847). Birmingham possesses one of his best works in King Edward's grammar school, built in the Tudor style between 1833 and 1836. For Manchester he designed the Royal Institution of Fine Arts (1824) and the Athenaeum (1836); and for Halifax the town-hall. He was engaged for some years in reconstructing the Treasury buildings, Whitehall. But his masterpiece, notwithstanding all unfavourable criticism, is the Houses of Parliament at Westminster (1840-1860). Barry was elected A.R.A. in 1840 and R.A. in the following year. His genius and achievements were recognized by the representative artistic bodies of the principal European nations; and his name was enrolled as a member of the academies of art at Rome, Berlin, St Petersburg, Brussels and Stockholm. He was chosen F.R.S. in 1849 and was knighted by Queen Victoria in 1852. He died suddenly at Clapham near London on the 12th of May 1860, and his remains were interred in Westminster Abbey. As a landscape gardener he was no less brilliant than as an architect, and in connexion with the building of the Houses of Parliament he formed schools of modelling, stone and wood carving, cabinet-making, metal-working, glass and decorative painting, and of encaustic tile-making. In 1867 appeared a life of him by his son Bishop Alfred Barry. A claim was thereupon set up on behalf of Pugin, the famous architect, who was dead and who had been Barry's assistant, to a much larger share in the work of designing the Houses of Parliament than was admitted in Dr Barry's narrative. The controversy raged for a time, but without substantiating Pugin's claim.

His second son, ALFRED BARRY (1826-), was educated at King's College, London, and Trinity College, Cambridge, where he was 4th wrangler and gained a first-class in the classical tripos in 1848. He was successively sub-warden of Trinity College, Glenalmond (1849-1854), head-master of Leeds grammar school (1854-1862), principal of Cheltenham College (1862-1868), and principal of King's College, London (1868-1883). He was canon of Worcester from 1871 to 1881, and of Westminster from 1881 to 1884. From 1884 to 1889 he served as bishop of Sydney and primate of Australia, and on his return to England he was assistant bishop in the diocese of Rochester from 1889 to 1891, and rector of St James's, Piccadilly, from 1895 to 1900. He was appointed canon of Windsor in 1891 and assistant bishop in West London in 1897. Besides the life of his father mentioned above, he published numerous theological works.

Another son, EDWARD MIDDLETON BARRY (1830-1880), was also an architect. He acted as assistant to his father during the latter years of Sir Charles's life. On the death of his father, the duty of completing the latter's unfinished work devolved upon him. Amongst other buildings thus completed were the Houses of Parliament at Westminster (see ARCHITECTURE, fig. 91, and Plate X. fig. 118), and Halifax town-hall (*Id.* fig. 90). In 1861 he was elected an associate of the Royal Academy; and in 1869 a full academician. From 1873 till his death he held the Academy's professorship of architecture. Among other buildings designed by him were Covent Garden theatre, Charing Cross and Cannon Street hotels, the Birmingham and Midland Institute, new galleries for the National Gallery and new chambers for the Inner Temple. He died on the 27th of January, 1880.

The youngest son, SIR JOHN WOLFE WOLFE-BARRY (1836-), the eminent engineer, who assumed the additional name of Wolfe in 1898, was educated at Glenalmond, and was articled as engineering pupil to Sir John Hawkshaw, with whom he was associated in the building of the railway bridges across the

Thames at Charing Cross and Cannon Street. In 1867 he began to practise on his own account, and soon gained an extensive connexion with railway companies, both in Great Britain and in other countries. Among the works on which he was engaged were extensions of the Metropolitan District railway, the St Paul's station and bridge of the London, Chatham & Dover railway, the Barry Docks of the Barry railway company near Cardiff, and the Tower and new Kew bridges over the Thames. On the completion of the Tower Bridge in 1894, he was made a C.B., becoming K.C.B. three years later. He served on several royal commissions, including those on Irish Public Works (1886-1890), Highlands and Islands of Scotland (1889-1890), Accidents to Railway Servants (1899-1900), Port of London (1900-1902), and London Traffic (1903-1905). He was elected president of the Institution of Civil Engineers in 1896, and published books on *Railway Appliances* (1874), and, with Sir F. J. Bramwell, on *Railways and Locomotives* (1882).

BARRY, ELIZABETH (1658-1713), English actress, of whose early life the details are meagre. At first she was so unsuccessful on the stage as to be more than once dismissed; but she was coached by her lover the earl of Rochester, who had laid a wager that in a short time he would make a first-rate actress of her, and the results confirmed his judgment. Mrs Barry's performance as Isabella, queen of Hungary, in the earl of Orrery's *Mustapha*, was said to have caused Charles II. and the duke and duchess of York so much delight that the duchess took lessons in English from her, and when she became queen she gave Mrs Barry her coronation robes in which to appear as Elizabeth in Banks's *Earl of Essex*. Mrs Barry is said to have created over 100 parts, and she was particularly successful in the plays of Thomas Otway. Betterton says that her acting gave "success to plays that would disgust the most patient reader." Dryden pronounced her "always excellent." Cibber is authority for the statement that it was on her behalf that benefits, which up to that time were reserved for authors, were first established for actors by command of James II. Mrs Barry had a child by Lord Rochester and a second by Sir George Etherege, both of whom were provided for by their fathers. In 1709 she retired from the stage and died on the 7th of November 1713.

BARRY, JAMES (1741-1806), English painter, was born at Cork on the 11th of October 1741. His father had been a builder, and, at one time of his life, a coasting trader between the two countries of England and Ireland. To this business of trader James was destined, and he actually made when a boy several voyages; but he manifested such an aversion to the life and habits of a sailor as to induce his father to suffer him to pursue his own inclinations, which led strongly towards drawing and study. At the schools in Cork to which he was sent he was regarded as a prodigy. About the age of seventeen he first attempted oil-painting, and between that and the age of twenty-two, when he first went to Dublin, he produced several large pictures, which decorated his father's house, such as "Aeneas escaping with his family from the flames of Troy," "Susanna and the Elders," "Daniel in the Lions' Den," &c. At this period he also produced the painting which first brought him into public notice, and gained him the acquaintance and patronage of Edmund Burke. The picture was founded on an old tradition of the landing of St Patrick on the sea-coast of Cashel, and of the conversion and baptism of the king of that district by the patron saint of Ireland. It was exhibited in London in 1762 or 1763.

By the liberality of Burke and his other friends, Barry in the latter part of 1765 was enabled to go abroad. He went first to Paris, then to Rome, where he remained upwards of three years, from Rome to Florence and Bologna, and thence home through Venice. His letters to the Burkes, giving an account of Raphael, Michelangelo, Titian and Leonardo da Vinci, show remarkable insight. Barry painted two pictures while abroad, an Adam and Eve, and a Philoctetes, neither of them of any merit. Soon after his return to England in 1771 he produced his picture of Venus, which was compared, though with little justice, to the Galatea of Raphael, the Venus of Titian and the Venus de Medici. In 1773 he exhibited his "Jupiter and Juno on Mount Ida." His

"Death of General Wolfe," in which the British and French soldiers are represented in very primitive costumes, was considered as a falling-off from his great style of art. His fondness for Greek costume was assigned by his admirers as the cause of his reluctance to paint portraits. His failure to go on with a portrait of Burke which he had begun caused a misunderstanding with his early patron. The difference between them is said to have been widened by Burke's growing intimacy with Sir Joshua Reynolds, and by Barry's feeling some little jealousy of the fame and fortune of his rival "in a humbler walk of the art." About the same time he painted a pair of classical subjects, Mercury inventing the lyre, and Narcissus looking at himself in the water, the last suggested to him by Burke. He also painted a historical picture of Chiron and Achilles, and another of the story of Stratonicæ, for which last the duke of Richmond gave him a hundred guineas. In 1773 it was proposed to decorate the interior of St Paul's with historical and sacred subjects; but the plan fell to the ground, from not meeting with the concurrence of the bishop of London and the archbishop of Canterbury. Barry was much mortified at the failure, for he had in anticipation fixed upon the subject he intended to paint—the rejection of Christ by the Jews when Pilate proposes his release. In 1773 he published *An Inquiry into the real and imaginary Obstructions to the Acquisition of the Arts in England*, vindicating the capacity of the English for the fine arts and tracing their slow progress hitherto to the Reformation, to political and civil dissensions, and lastly to the general direction of the public mind to mechanics, manufactures and commerce. In 1774 a proposal was made through Valentine Green to Reynolds, West, Cipriani, Barry, and other artists to ornament the great room of the Society for the Encouragement of Arts, Manufactures and Commerce in the Adelphi with historical and allegorical paintings. This proposal was at the time rejected by the artists themselves; but in 1777 Barry made an offer to paint the whole on condition of being allowed the choice of his subjects, and being paid by the society the expenses of canvas, paints and models. His offer was accepted, and he finished the series of pictures at the end of seven years to the entire satisfaction of the members of the society, who granted him two exhibitions, and at different periods voted him 50 guineas, their gold medal and 200 guineas. Of the six paintings making up the series, only one, that of the Olympic Games, shows any artistic power.

Soon after his return from the continent Barry had been chosen a member of the Royal Academy; and in 1782 he was appointed professor of painting in the room of Mr Penny with a salary of £30 a year. Among other things, he insisted on the necessity of purchasing a collection of pictures by the best masters as models for the students, and proposed several of those in the Orleans collection. This recommendation was not relished, and in 1790 Barry was expelled from the academy, soon after the appearance of his *Letter to the Dilettanti Society*, a very amusing but eccentric publication, full of enthusiasm for his art and at the same time of contempt for the living professors of it. After the loss of his salary, a subscription was set on foot by the earl of Buchan to relieve him from his difficulties, and to settle him in a larger house to finish his picture of Pandora. The subscription amounted to £1000, with which an annuity was bought, but on the 6th of February 1806 he was seized with illness and died on the 22nd of the same month. On the 14th of March his remains were interred in St Paul's.

As an artist, Barry was more distinguished for the strength of his conceptions, and for his resolute and persistent determination to apply himself only to great subjects, than for his skill in designing or for beauty in his colouring. His drawing is rarely good, his colouring frequently wretched. He was extremely impulsive and unequal; sometimes morose, sometimes sociable and urbane; jealous of his contemporaries, and yet capable of pronouncing a splendid eulogy on Reynolds.

BARRY, SIR REDMOND (1813–1880), British colonial judge, son of Major-General H. G. Barry, of Ballyclough, Co. Cork, was educated at a military school in Kent, and at Trinity College, Dublin, and was called to the Irish bar in 1838. He emigrated

to Australia, and after a short stay at Sydney went to Melbourne, with which city he was ever afterwards closely identified. After practising his profession for some years, he became commissioner of the court of requests, and after the creation in 1851 of the colony of Victoria, out of the Port Phillip district of New South Wales, was the first solicitor-general with a seat in the legislative and executive councils. Subsequently he held the offices of judge of the Supreme Court, acting chief-justice and administrator of the government. He represented Victoria at the London International Exhibition of 1862 and at the Philadelphia Exhibition of 1876. He was knighted in 1860 and was created K.C.M.G. in 1877. Sir Redmond Barry was the first person in Victoria to take an interest in higher education, and induced the local government to expend large sums of money upon that object. He was the founder of the university of Melbourne (1853), of which he was the first chancellor, was president of the Melbourne public library (1854), national gallery and museum, and was one of the first to foster the volunteer movement in Australia. To his exertions is due the prosperity of the two institutions with which his memory is identified.

BARRY, SPRANGER (1719–1777), British actor, was born in Dublin on the 23rd of November 1719, the son of a silversmith, to whose business he was brought up. His first appearance on the stage was at the Smock Alley theatre on the 5th of February 1744, and his engagement at once increased its prosperity. His first London appearance was made in 1746 as Othello at Drury Lane. Here his talents were speedily recognized, and in *Hamlet* and *Macbeth* he alternated with Garrick, arousing the latter's jealousy by his success as Romeo. This resulted in his leaving Drury Lane for Covent Garden in 1750, accompanied by Mrs Cibber, his Juliet. Both houses now at once put on *Romeo and Juliet* for a series of rival performances, and Barry's impersonation was preferred by the critics to Garrick's. In 1758 Barry built the Crow Street theatre, Dublin, and later a new theatre in Cork, but he was not successful as a manager and returned to London to play at the Haymarket, then under the management of Foote. As his second wife, he married in 1768 the actress Mrs Dancer (1734–1801), and he and Mrs Barry played under Garrick's management. Barry appearing in 1767, after ten years' absence from the stage, in Othello, his greatest part. In 1774 they both moved to Covent Garden, where Barry remained until his death on the 10th of January 1777. He was a singularly handsome man, with the advantage of height which Garrick lacked.

His second wife, ANN STREET BARRY, was born in Bath in 1734, the daughter of an apothecary. Early in life she married an actor of the name of Dancer, and it was as Mrs Dancer that she made her first recorded appearance in 1758 as Cordelia to Spranger Barry's Lear at the Crow Street theatre. During the next nine years she played all the leading tragic parts, but without any great success, and it was not until she came to Drury Lane with Barry that her reputation advanced to the high point at which it afterwards stood. After his death, she remained at Covent Garden and married a man much younger than herself, named Crawford, being first billed as Mrs Crawford in 1778. Her last appearance is said to have been as Lady Randolph in *Douglas* at Covent Garden in 1798. This part, and that of Desdemona, were among her great impersonations; in both she was considered by some critics superior to Mrs Siddons, who expressed her fear of her in one of her letters. She died on the 20th of November 1801 and was buried in Westminster Abbey.

BARRY, an urban district and seaport of Glamorganshire, Wales, on the Bristol Channel, 153 m. by rail from London and 8 m. S.W. from Cardiff. Its station is a terminus on the Barry railway, which starts at Hafod in the Rhondda Valley, where it joins the Taff Vale railway, having also junctions with the same line for Aberdare and Merthyr at Treforest, and for Cardiff and Penarth at Cogan, and with the Great Western main line at Peterstone and St Fagans. A branch from the main line at Tyn-y-caeau connects with the Rhymney railway, the London & North-Western railway, and the Brecon & Merthyr railway. The Vale of Glamorgan railway (which is worked by

the Barry company and has a junction with the Great Western railway at Bridgend) affords a direct route to Barry from the Llynvi, Ogmere and Garw coalfields. The urban district of Barry, with a population in 1901 of 27,030, comprises the ecclesiastical parishes of Barry, Cadoxton, Merthyr-Dovan, and a portion of Sully in which is included Barry Island (194 acres), now, however, joined to the mainland. The total population of this area in 1881 was only about 500, that of Barry village alone being only 85. A small brook named Barri runs here into the sea, whence the place was formerly known in Welsh as Aber-Barri, but the name of both the river and the island is supposed to be derived from Baruch, a Welsh saint of the 7th century, who had a cell on the island. His chapel (which still existed in Leland's time) was a place of pilgrimage in the middle ages. According to Giraldus, his own family derived its name de Barri from the island which they once owned. One of the followers of Fitzhamon settled at Barry about the end of the 11th century, building there a castle of which only a gateway remains. Besides the small old parish churches of Merthyr-Dovan and Cadoxton, and the rebuilt parish church of Barry, there are four modern churches (in one of which Welsh services are held). There are about thirty nonconformist chapels, in nearly a third of which the services are Welsh. There are also a Roman Catholic church, and one for German and Scandinavian seamen. The other public buildings are a county intermediate school for 250 boys and girls, built in 1806, a free library (opened in 1892) with four branch reading-rooms, a seamen's institute, the Barry market, built in 1890 at a cost of £3500 (but now used as a concert-hall), and Romilly hall for public meetings.

Barry owes its seaport to the determination of a number of colliery owners to secure an alternative port to Cardiff, with an independent railway to it from the coalfields. After failing in 1883, they obtained parliamentary powers for this purpose in 1884, and the first sod of the new dock at Barry was cut in November of that year. The docks are 114 acres in extent, and have accommodation for the largest vessels afloat. Dock No. 1, opened on the 18th of July 1889, is 73 acres (with a basin of 7 acres) and occupies the eastern side of the old channel between the island and the mainland, having a well-sheltered deep-sea entrance. There is good anchorage between Barry and Sully islands. Dock No. 2 (34 acres) was opened on the 10th of October 1898. There are 41 acres of timber-ponds and three large graving-docks. For loading the coal there are thirty fixed and seven movable coal-hoists. The total tonnage of the exports in 1906 was 9,757,380 (all of which, except 26,491 tons, was coal), and of the imports 506,103 tons.

BAR-ŞALĪBĪ, JACOB or **DIONYSIUS**,¹ the best-known and most voluminous writer in the Syrian Jacobite church of the 12th century, was, like Bar-Hebraeus, a native of Malatya on the Upper Euphrates. In 1154 he was created bishop of Mar'ash by the patriarch Athanasius VIII.; a year later the diocese of Mabbog was added to his charge. In 1166 Michael I., the successor of Athanasius, transferred him to the metropolitan see of Āmid in Mesopotamia, and there he remained till his death in 1171. A long account of his writings, with copious extracts from some of them, has been given by Assemani (*Bibl. Orient.* ii. pp. 156-211); and W. Wright (*Syriac Literature*, pp. 246-250) has added further particulars as to the MSS. in which they are contained. Probably the most important are his exhaustive commentaries on the text of the Old and New Testaments, in which he has skillfully interwoven and summarized the interpretations of previous writers such as Ephrem, Chrysostom, Cyril, Moses Bar-Kēphā and John of Dārā, whom he mentions together in the preface to his commentary on St Matthew. Among his other main works are a treatise against heretics, containing *inter alia* a polemic against the Jews and the Mahomedans; liturgical treatises, epistles and homilies. His commentaries on the Gospels were to some extent used by Dudley Loftus in the 17th century. But the systematic editing of his

¹ Jacob was his baptismal name; Dionysius he assumed when consecrated to the bishopric.

works was only begun in 1903 with H. Labourt's edition and translation of his *Exposition de la Liturgie* (Paris). His commentaries on the Gospels have been edited and translated by J. Sedlaček and J. B. Chabot (*Fasc. I.*, Paris, 1906), and the Syriac text of the treatise against the Jews has been edited by J. de Zwaan (Leiden, 1906). Bar-Şalībī was undoubtedly an able theologian; his vigour combined with terseness in argument is well seen, for instance, in the introductory sections of his commentary on St Matthew. Of his originality it is hard to judge, as he does not usually indicate in detail the sources of his arguments and interpretations. He does not, however, claim for himself to be more than a compiler, at least in his commentaries. His Syriac style is good, considering the lateness of the period at which he wrote. (N. M.)

BARSI, a town of British India, in the Sholapur district of Bombay, lying within a tract entirely surrounded by the Nizam's dominions. Pop. (1901) 24,242. Barsi is a flourishing centre of trade, exporting to Bombay large quantities of cotton and oil-seeds. It has several factories for ginning and pressing cotton—some on a large scale. It is connected with the main line of the Great Indian Peninsula railway by a light railway.

BAR-SUR-AUBE, a town of north-eastern France, capital of an arrondissement in the department of Aube, 34 m. E. of Troyes on the main line of the Eastern railway between that town and Belfort. Pop. (1906) 4276. Bar-sur-Aube lies at the foot of hills on the right bank of the Aube at its confluence with the Bresse. A circle of boulevards occupies the site of the old ramparts, fragments of which still remain. Of the ecclesiastical buildings, the most noteworthy are St Pierre and St Maclou, both dating mainly from the end of the 12th century. St Pierre has wooden exterior galleries and two fine Gothic porches. The sacristy of St Maclou is conjectured to have formed the chapel of the castle of the counts of Bar, of which the square tower flanking the north side of the church formed the entrance. The town is the seat of a sub-prefect, and the public institutions include a tribunal of first instance and a communal college. Flour-milling, tanning, and the manufacture of brandy, hosiery and agricultural implements are carried on. The wine of the district is much esteemed.

Traces of a Roman settlement have been found on hills to the south of the town. Under the domination of the counts of Champagne, it became the scene of important fairs which did not cease till 1648. In 1814 several actions between the French and the army of the allies took place at Bar-sur-Aube (see NAPOLEONIC WARS).

BAR-SUR-SEINE, a town of eastern France, capital of an arrondissement in the department of Aube, on the left bank of the Seine, 20 m. S.E. of Troyes by the Eastern railway. Pop. (1906) 2812. The town lies at the foot of a wooded hill on which stand the ruins of the castle of the counts of Bar, and is composed chiefly of one long street, bordered in places by houses of the 16th century. Its principal building is the church of St Etienne, of the 16th and 17th centuries, which contains some fine stained glass. Bar-sur-Seine has a sub-prefecture and a tribunal of first instance. Tanning, dyeing, flour-milling, brandy-distilling and the manufacture of glass are among the industries. The Canal de la Haute-Seine begins at this point. The town was devastated in 1359 by the English, when, according to Froissart, no fewer than 900 mansions were burnt. Afterwards it suffered greatly in the religious wars of the 16th century.

BART, JEAN (1651-1702), French naval commander, son of a fisherman, was born in Dunkirk on the 21st of October 1651. He served when young in the Dutch navy, but when war broke out between Louis XIV. and Holland in 1672 he entered the French service. He gained great distinction in the Mediterranean, where he held an irregular sort of commission, not being then able from his low birth to receive a command in the navy. His success was so great, however, that he was made a lieutenant in 1679. He rose rapidly to the rank of captain and then to that of admiral. The peace of Ryswick put a close to his active service. Many anecdotes are narrated of the courage and bluntness of the uncultivated sailor, who became the popular hero

of the French naval service. The town of Dunkirk has honoured his memory by a statue and by naming a public square after him.

See Richer, *Vie de Jean Bart* (1780), and many editions since; Vanderest, *Histoire de Jean Bart*.

BARTAN, more correctly **BARTIN**, a town in the vilayet of Kastamuni, Asiatic Turkey, retaining the name of the ancient village Parthenia and situated near the mouth of the Bartan-su (anc. *Parthenius*), which formed part of the boundary between Bithynia and Paphlagonia. Various aetiological explanations of the name Parthenius were given by the ancients, e.g. that the maiden Artemis hunted on its banks, or that the flow of its waters was gentle and maiden-like. The town, which is the residence of a *kaimakam*, is built on two low limestone hills and its streets are paved with limestone blocks. It is noted for the fine box-wood grown in the vicinity, is a port of call for Black Sea coasting steamers and carries on a considerable trade with Constantinople which might be increased were it not for the obstruction of the harbour by a bar. Pop. 8677, according to Cuinet, *La Turquie d'Asie* (1894).

BARTELS, HANS VON (1856–), German painter, was born in Hamburg, the son of Dr N. F. F. von Bartels, a Russian government official. He studied first under the marine painter R. Hardorf in Hamburg, then under C. Schweitzer in Düsseldorf and C. Oesterley in Hamburg, and finally at the Berlin School of Art. After travelling extensively, especially in Italy, he settled in Munich in 1885 and was appointed professor of painting in 1891. An oil painter of great power, he is one of the leading German water-colour painters, mainly of marines and scenes of fishing life, painted with rude vigour and a great display of technical skill. He excels in storm scenes and in depicting the strong, healthy fishing-folk of the northern coasts. He became an honorary member of leading English, German, Dutch, Belgian and Austrian art societies. Among his principal works are: "Sturmflut" (Berlin Gallery); "Lonely Beach" (Hungarian National Gallery); "Potato Harvest—Rügen" (Prague); "Storm—Bornholm" (German emperor's collection); and "Moonlight on the Zuyder Zee" (New Pinakothek, Munich).

BARTENSTEIN, a town of Germany, in the kingdom of Prussia, on the Alle, 34 m. S. of Königsberg by rail. Pop. (1900) 6805. It has a considerable trade in corn and live stock, and its industries comprise founding and carriage-building, tanneries, breweries and potteries. Bartenstein is celebrated for the treaty concluded here on the 26th of April 1807, between Prussia and Russia.

BARTER (from Fr. *barater*, to truck, to exchange), the exchange of commodities for commodities, in contra-distinction to the exchange of commodities for money. Barter was the simplest form of trading among primitive communities, but its inconveniences led, at an early stage of civilization, to the adoption of metals as mediums of exchange. Barter, however, is still very common in dealings with uncivilized peoples, and traders in many countries find that the most satisfactory method of effecting exchange is to furnish themselves with such commodities as weapons, tools and ornaments, which are more readily taken than money.

For the history of barter and the steps by which a system of currency was gradually evolved, see MONEYS. Consult also W. S. Jevons, *Money and the Mechanism of Exchange*; A. Marshall, *Economics*; W. Ridgway, *Origin of Currency and Weight Standards*.

BARTET (REGNAULT), **JEANNE JULIA** (1854–), French actress, was born in Paris and trained at the Conservatoire. In 1872 she began a successful career at the Vaudeville, and in 1879 was engaged at the Comédie Française, of which she became a *sociétaire* in 1880. For many years she played the chief parts both in tragedy and comedy, her grand style and exquisite finesse making her supreme among the younger actresses on the French stage. She had a season in London in 1908, when her consummate art was displayed in a number of parts.

BARTH, HEINRICH (1821–1865), German explorer, was born at Hamburg on the 16th of February 1821, and educated at Berlin University, where he graduated in 1844. He had already visited Italy and Sicily and had formed a plan to journey through

the Mediterranean countries. After studying Arabic in London he set out on his travels in 1845. From Tangier he made his way overland throughout the length of North Africa, visiting the sites of the ancient cities of Barbary and Cyrenaica. He also travelled through Egypt, ascending the Nile to Wadi Halfa and crossing the desert to Berenice. While in Egypt he was attacked and wounded by robbers. Crossing the Sinai peninsula he traversed Palestine, Syria, Asia Minor, Turkey and Greece, everywhere examining the remains of antiquity; and returned to Berlin in 1847. For a time he was engaged there as *Privat-docent*, and in preparing for publication the narrative of his *Wanderungen durch die Küstenländer des Mittelmeeres*, which appeared in 1849.

At the instance of Bunsen and other scientists, Barth and Adolf Overweg, a Prussian astronomer, were appointed colleagues of James Richardson, an explorer of the Sahara who had been selected by the British government to open up commercial relations with the states of the central and western Sudan. The party left Tripoli early in 1850, but the deaths of Richardson (March 1851) and Overweg (September 1852) left Barth to carry on the mission alone. He returned to Europe in September 1855, after one of the most fruitful expeditions ever undertaken in inner Africa. In addition to journeys across the Sahara, Barth traversed the country from Lake Chad and Bagirmi on the east to Timbuktu on the west and Cameroon on the south, making prolonged sojourns in the ancient sultanates or emirates of Bornu, Kano, Nupe, Sokoto and Gando and at Timbuktu. He studied minutely the topography, history, civilizations and resources of the countries he visited. The story of his travels was published simultaneously in English and German, under the title *Travels and Discoveries in North and Central Africa* (1857–1858, 5 vols.). For accuracy, interest, variety and extent of information Barth's *Travels* have few rivals among works of the kind. It is a book that will always rank as a standard authority on the regions in question, of which a great part, under the name of Nigeria, has since come under British rule. Except a C.B., Barth himself received no recognition of his services from the British government. He returned to Germany, where he prepared a collection of Central African vocabularies (Gotha, 1862–1866). In 1858 he undertook another journey in Asia Minor, and in 1862 visited Turkey in Europe. In the following year he was appointed professor of geography at Berlin University and president of the Geographical Society. He died at Berlin on the 25th of November 1865.

See Schubert's *Heinrich Barth, der Bahnbrecher der deutschen Afrikaforschung* (Berlin, 1897). An edition of the *Travels* in two volumes was published in London in 1890 (Minerva Library of Famous Books).

BARTH, KASPAR VON (1587–1658), German philologist, was born at Küstrin in the province of Brandenburg on the 21st of June 1587. He was an extremely precocious child, and was looked upon as a marvel of learning. After studying at Gotha, Eisenach, Wittenberg and Jena, he travelled extensively, visiting most of the countries of Europe. Too independent to accept any regular post, he lived alternately at Halle and on his property at Sellerhausen near Leipzig. In 1636, his library and MSS. at Sellerhausen having been destroyed by fire, he removed to the Paulinum at Leipzig, where he died on the 17th of September 1658. Barth was a very voluminous writer; his works, which were the fruits of extensive reading and a retentive memory, are unmethodical and uncritical and marred by want of taste and of clearness. He appears to have been excessively vain and of an unamiable disposition. Of his writings the most important are: *Adversaria* (1624), a storehouse of miscellaneous learning, dealing not only with classical but also with medieval and modern writers; and commentaries on Claudian (1612, 1650) and Statius (1664).

BARTH, a town of Germany, in the kingdom of Prussia, on the Barther Bodden, a lake connecting with the Baltic, 15 m. N.W. from Stralsund by rail. Pop. (1900) 7070. It contains a fine Gothic Protestant church (St Mary's) dating from the 13th century and has several educational establishments, notably a

school of seamanship. Its industries comprise iron-founding, ship-building, brewing, and the manufacture of cigars, leather and tinned fish. There is an active export trade in grain.

BARTHÉLEMY, ANATOLE JEAN-BAPTISTE ANTOINE DE (1821-1904), French archaeologist and numismatist, was born at Reims on the 1st of July 1821, and died at Ville d'Avray on the 27th of June 1904. In collaboration with J. Geslin de Bourgogne he published *Études sur la révolution en Bretagne* in 1858, and between 1855 and 1879 an exhaustive work in six volumes on the *Anciens évêchés de Bretagne; histoire et monuments*. In 1880 appeared the *Choix de documents inédits sur l'histoire de la ligue en Bretagne*, by himself alone. But it was, above all, his numismatic work which established his reputation. This included several popular publications, such as the *Nouveau manuel complet de numismatique ancienne* (1851; second edition, revised, 1890), and the *Nouveau manuel complet de numismatique du moyen âge et moderne* (1853; new edition revised by Adrien Planchet), and a large number of monographs and articles in the technical reviews. The following may be specially mentioned: *Numismatique mérovingienne* (1865); *Essai sur la monnaie parisienne* (1874); *Note sur l'origine de la monnaie tournoise* (1896); and in the series of instructions issued by the *Comité des travaux historiques et scientifiques* he edited the number on *La Numismatique de la France* (1891). In 1897 he was elected a member of the Académie des Inscriptions et Belles-lettres.

His younger brother, ÉDOUARD MARIE, comte de Barthélemy, who was born in Angers in 1830, has published a number of documents upon the ancient French nobility and upon the history of Champagne.

BARTHÉLEMY, AUGUSTE MARSEILLE (1796-1867), French satirical poet, was born at Marseilles in 1796. His name can hardly be separated from that of his friend and compatriot, J. P. A. Méry (1798-1866), with whom he carried on so intimate a collaboration that it is not possible to distinguish their personalities in their joint works. After having established some local reputation as a poet, Barthélemy went to Paris, where by one of his first efforts, *Le Sacre de Charles X* (1825) he gained the favour of the court. His energies, however, were soon enlisted in the service of the opposition party. In 1825 appeared a clever political satire, *Les Sidiennes*, followed by *La Villiade ou la prise du château de Rivoli* (1827), *La Corbière* (1827), *La Peyronnède* (1827), the joint productions of Barthélemy and Méry. The success was immediate and pronounced; fifteen editions of the *Villiade* were called for during the year. A rapid succession of political squibs and satires was now poured forth by the authors, among the most remarkable being *Biographie des quarante de l'Académie française* (1826) and *Napoléon en Égypte* (1828), which passed through nearly a dozen editions in a year. In 1829 Barthélemy was imprisoned and fined 1000 francs for the publication of their *Fils de l'homme*, a poem on the duke of Reichstadt, Napoleon's son. The Revolution of 1830 liberated him; and in company with Méry, he celebrated the triumph of the people in one of their most brilliant efforts, *L'Insurrection*. From March 1831 to April 1832 they produced a series of verse satires issued weekly, the *Némésis*, attacking the government and ministers of Louis Philippe. The small pension of which Barthélemy was the recipient was stopped. When the publication ceased there was a strong suspicion that Barthélemy had been paid for his silence. In 1832 he published an anonymous poem, supporting some acts of the government which were peculiarly obnoxious to the Liberal party. This change of front destroyed his influence and his later writings passed unnoticed. For the next few years he enjoyed a handsome pension from the government and refrained from all satirical writing. He again resumed his old style in 1844 but without the former success. From that date he contented himself with merely occasional poems. Barthélemy died on the 23rd of August 1867 at Marseilles. Joseph Méry was an ardent romanticist and wrote a great number of stories now forgotten. He produced several pieces at the Paris theatres, and also collaborated with Gérard de Nerval in adaptations from Shakespeare and in other plays. He received a pension from Napoleon III. and died in Paris on the 16th of June 1866.

The *Œuvres* of Barthélemy and Méry were collected, with a notice by L. Reybaud, in 1831 (4 vols.). See also *Barthélemy et Méry étudiés spécialement dans leurs rapports avec la légende napoléonienne*, by Jules Garsou in vol. lviii. of the *Mémoires* of the Académie Royale . . . de Belgique, which contains full information on both authors.

BARTHÉLEMY, FRANÇOIS, MARQUIS DE (1747 or 1750-1830), French politician, was educated by his uncle the abbé Jean Jacques Barthélemy for a diplomatic career, and after serving as secretary of legation in Sweden, in Switzerland and in England, was appointed minister plenipotentiary in Switzerland, in which capacity he negotiated the treaties of Basel with Prussia and Spain (1795). Elected a member of the Directory in May 1797, through royalist influence, he was arrested at the *coup d'état* of the 18 Fructidor (17th of September 1797) and deported to French Guiana, but escaped and made his way to the United States and then to England. He returned to France after the 18 Brumaire, entered the senate in February 1800 and contributed to the establishment of the consulship for life and the empire. In 1814 he abandoned Napoleon, took part in the drawing up of the constitutional charter and was named peer of France. During the Hundred Days he lived in concealment, and after the second Restoration obtained the title marquis, and in 1819 introduced a motion in the chamber of peers tending to render the electoral law more aristocratic.

His *Papiers* have been published by J. Kaulek, 4 vols. (Paris, 1886-1888). See A. Sorel, *L'Europe et la Révolution française*, iv. (Paris, 1892); L. Sciout, *Le Directoire* (Paris, 1895).

BARTHÉLEMY, JEAN JACQUES (1716-1795) French writer and numismatist, was born on the 20th of January 1716 at Cassis, in Provence. He was educated first at the college of the Oratory in Marseilles, and afterwards at that of the Jesuits in the same city. While studying for the priesthood, which he intended to join, he devoted much attention to oriental languages, and was introduced by his friend M. Cary of Marseilles to the study of classical antiquities, particularly in the department of numismatics. In 1744 he went to Paris with a letter of introduction to M. Gros de Boze, perpetual secretary of the Academy of Inscriptions and Belles-lettres and keeper of the royal collection of medals. He became assistant to de Boze, on whose death (1753) he became keeper of the medals. In 1755 he accompanied the French ambassador, M. de Stainville, afterwards duc de Choiseul, to Italy, where he spent three years in archaeological research. Choiseul had a great regard for Barthélemy, and on his return to France, Barthélemy became an inmate of his house, and received valuable preferments from his patron. In 1789, after the publication of his *Voyage du jeune Anacharsis*, he was elected a member of the French Academy. During the Revolution Barthélemy was arrested as an aristocrat. The Committee of Public Safety, however, were no sooner informed by the duchess of Choiseul of the arrest, than they gave orders for his immediate release, and in 1793 he was nominated librarian of the Bibliothèque Nationale. He refused this post but resumed his old functions as keeper of medals, and enriched the national collection by many valuable accessions. Barthélemy died on the 30th of April 1795.

Barthélemy was the author of a number of learned works on antiquarian subjects, but the great work on which his fame rests is *Voyage du jeune Anacharsis en Grèce, vers le milieu du quatrième siècle avant l'ère chrétienne* (4 vols., 1787). He had begun it in 1757 and had been working on it for thirty years. The hero, a young Scythian descended from the famous philosopher Anacharsis, is supposed to repair to Greece for instruction in his early youth, and after making the tour of her republics, colonies and islands, to return to his native country and write this book in his old age, after the Macedonian hero had overturned the Persian empire. In the manner of modern travellers, he gives an account of the customs, government and antiquities of the country he is supposed to have visited; a copious introduction supplies whatever may be wanting in respect to historical details; whilst various dissertations on the music of the Greeks, on the literature of the Athenians, and on the economy, pursuits, ruling passions, manners and customs of the surrounding states supply ample

information on the subjects of which they treat. Modern scholarship has superseded most of the details in the *Voyage*, but the author himself did not imagine his book to be a register of accurately ascertained facts; he rather intended to afford to his countrymen, in an interesting form, some knowledge of Greek civilization. The *Charities* of W. A. Becker is an attempt in a similar direction, but, though superior in scholarship, it wants the charm of style of the *Anacharsis*.

Barthélemy's correspondence with Paolo Paciaudi, chiefly on antiquarian subjects, was edited with the *Correspondance inédite du comte de Caylus* in 1877 by Ch. Nisard; his letters to the comte de Caylus were published by Antoine Serisy as *Voyage en Italie* (1801); and his letters to Mme du Defand, with whom he was on intimate terms, in the *Correspondance complète de Mme du Defand avec la duchesse de Choiseul, l'abbé Barthélemy et M. Craufurt* (3 vols., 1866), edited by the marquis de Sainte-Aulaire. See also *Mémoires sur la vie de l'abbé Barthélemy, écrits par lui-même* (1824), with a notice by Lalande. His *Œuvres complètes* (4 vols. 1821), contain a notice by Villenave.

BARTHÉLEMY SAINT-HILAIRE, JULES (1805-1895), French philosopher and statesman, was born at Paris on the 10th of August 1805. In his early years he was an active political journalist, and from 1826 to 1830 opposed the reactionary policy of the king in *Le Globe*. At the revolution of 1830 he signed the protestation of the journalists on the 28th of July 1830. After 1830 he contributed to different newspapers—*Le Constitutionnel*, *Le National* and the *Courrier français*—until 1833, when he gave up politics in order to devote himself to the history of ancient philosophy, undertaking a translation of Aristotle, which occupied him the greater part of his life (1837-1892). The reputation which he gained from this work won for him the chair of ancient philosophy at the Collège de France (1838) and a seat at the Academy of Moral and Political Science (1839). After the revolution of 1848 he was elected as a republican deputy; but was obliged to withdraw after the *coup d'état* of Louis Napoleon. In 1855 he went as member of the international commission to Egypt to report on the possibility of the proposed Suez canal, and by the articles which he wrote he contributed largely to making the project popular in France. Elected deputy again in 1869, he joined the opposition to the Empire, and in 1871 bent all his efforts to the election of Thiers as president of the republic, acting afterwards as his secretary. Appointed senator for life in 1875, he took his place among the moderate republicans, and from September 1880 to November 1881 was minister of foreign affairs in the cabinet of Jules Ferry. The most important event of his administration was the annexation of Tunis under the form of a French protectorate, which he actively promoted. He died on the 24th of November 1895. His principal works, besides the translation of Aristotle and a number of studies connected with the same subject, are *Ves Dédas* (1854), *Du Bouddhisme* (1856) and *Mahomet et le Coran* (1865).

BARTHEZ, or BARTHÉS, PAUL JOSEPH (1734-1806), French physician, was born on the 11th of December 1734 at Montpellier. He was educated at Narbonne and Toulouse, and began the study of medicine at Montpellier in 1750, taking his doctor's degree in 1753. In 1756 he obtained the appointment of physician to the military hospital in Normandy attached to the army of observation commanded by Marshal d'Estrées, but a severe attack of hospital fever compelled him to leave this post. In 1757 his services were required in the medical staff of the army of Westphalia, where he had the rank of consulting physician, and on his return to Paris he acted as joint editor of the *Journal des savants* and the *Encyclopédie méthodique*. In 1759 he obtained a medical professorship at Montpellier, and in 1774 he was created joint chancellor of the university. In 1778 he published his most famous work, *Nouveaux éléments de la science de l'homme*, in which he employs the expression "vital principle" as a convenient term for the cause of the phenomena of life, without committing himself to either a spiritualistic or a materialistic view of its nature. Taking the degree of doctor of civil law in 1780, he secured the appointment of counsellor to the Supreme Court of Aids at Montpellier, but he soon took up his residence in Paris, having been nominated consulting physician to the king.

On the outbreak of the French Revolution he lost much of his fortune and retired to Carcassonne, where he devoted himself to the study of theoretical medicine. It was from this retreat that he gave to the world his *Nouvelle mécanique des mouvements de l'homme et des animaux*, which appeared in 1798. In 1802 he published his *Traitement des maladies gouteuses*, and he afterwards occupied himself in preparing for the press a new edition of his *Éléments de la science de l'homme*, of which he just lived to see the publication. His health had been declining for some years before his death, which took place soon after his removal to Paris, on the 15th of October 1806. He bequeathed his books and manuscripts to J. Lordat, who published two volumes of his *Consultations de médecine* in 1810. His *Traité du beau* was also published posthumously in 1807.

BARTHOLINUS, GASPARD [CASPAR BERTHELESEN], (1585-1629), physician, was born in 1585 at Malmö, in Sweden. His precocity was extraordinary; at three years of age he was able to read, and in his thirteenth year he composed Greek and Latin orations and delivered them in public. When he was about eighteen he went to the university of Copenhagen and afterwards studied at Rostock and Wittenberg. He then travelled through Germany, the Netherlands, England, France and Italy, and was received with marked respect at the different universities he visited. In 1613 he was chosen professor of medicine in the university of Copenhagen, and filled that office for eleven years, when, falling into a dangerous illness, he made a vow that if he should recover he would apply himself solely to the study of divinity. He fulfilled his vow by becoming professor of divinity at Copenhagen and canon of Roskilde. He died on the 13th of July 1629 at Sorø in Zealand.

Of his sons, Thomas (1616-1680) was born at Copenhagen, where, after a long course of study in various universities of Europe, he was appointed successively professor of mathematics (1647) and anatomy (1648). During his tenure of the latter chair he distinguished himself by observations on the lymphatics. In 1661 he retired to Hagestaed. In 1670 his house and library were burnt, and in consideration of his loss he was appointed physician to the king, with a handsome salary, and librarian to the university of Copenhagen. He died at Hagestaed in 1680. Another son, Erasmus (1625-1698), born at Roskilde, spent ten years in visiting England, Holland, Germany and Italy, and filled the chairs of mathematics and medicine at Copenhagen. He discovered double refraction in Iceland spar (*Experimenta crystalli islandici didiactastici*, Copenhagen, 1669). He died at Copenhagen in 1698. In the third generation Caspar Thomason (1655-1738), son of Thomas, also taught anatomy at Copenhagen, his name being associated with the description of one of the ducts of the sublingual gland and of the *glandulae Bartholini*, while his younger brother, Thomas (1650-1690), was a student of northern antiquities who published *Antiquitatum Danicarum libri tres* in 1689.

BARTHOLOMEW, SAINT, one of the twelve apostles, regarding whose early life we know nothing, unless in accordance with a widely-spread belief he is to be identified with Nathanael (*q.v.*). If so, Bartholomew is probably a patronymic, the apostle's full name being Nathanael Bartolmai, *i.e.* the son of Tolmai. On the other hand, according to a Syrian tradition, Bartholomew's original name was Jesus, which he dropped owing to its being the name of the Master Himself. In the synoptic gospels Bartholomew is never mentioned except in the lists of the apostles, where his name always appears after Philip's. He is said to have gone, after the ascension of the Lord, on a missionary tour to India (then a very wide geographical designation) where, according to a story in Eusebius (*H.E.* v. 10), he left behind him a copy of St Matthew's gospel. According to the traditional account he was flayed alive and then crucified with his head downwards, at Albanopolis in Armenia, or, according to Nicephorus, at Urbanopolis in Cilicia. In works of art he is generally represented with a large knife, the instrument of his martyrdom, or, as in Michelangelo's "Last Judgment," with his own skin hanging over his arm. The festival of St Bartholomew is celebrated on the 24th of August.

Dr Nestle has drawn attention to the fact that in the Syriac translation of Eusebius' history the name Tolmai, i.e. Bartholomew, takes the place of Matthias, the apostle who was appointed in place of Judas (i. 12, cf. ii. 1. iii. 25 and 29). If this identification can be made out there would, in the list of apostles as finally constituted, be two men who bore the patronymic Bartholomew. See further *Expository Times*, ix. pp. 566 ff. (1898).

BARTHOLOMEW, JOHN (1831-1893), Scottish cartographer, was born at Edinburgh on the 25th of December 1831. His father had a cartographical establishment there and he was educated in the work. He was subsequently assistant to the German geographer August Petermann, until in 1856 he took up the management of his father's firm. For this establishment, now known as the Edinburgh Geographical Institute, Bartholomew built up a reputation unsurpassed in Great Britain for the production of the finest cartographical work. Among his numerous publications mention may be specially made of the series of maps of Great Britain reduced from the Ordnance Survey to scales of $\frac{1}{2}$ in. and $\frac{1}{4}$ in. to 1 m., with relief shown by contours and a systematic scale of colours. The $\frac{1}{2}$ in. series, which was extended (and its principles applied to many other works) by Mr J. G. Bartholomew, who succeeded his father in the business, is the finest of its kind ever produced. John Bartholomew died in London on the 20th of March 1893.

BARTHOLOMEW FAIR, a fair held in West Smithfield, London, on St Bartholomew's Day (24th of August, O.S.) from 1133 to 1855. The charter authorizing its holding was granted by Henry I. to his former minstrel, Rahere, who had taken orders and had founded the priory of St Bartholomew close by. For many centuries the fair lasted a fortnight, but in 1601 it was shortened to four days only. In 1641 it had become so large that it involved no less than four parishes: Christ Church, Great and Little St Bartholomew's and St Sepulchre's. It was customary for the lord mayor of London to open the fair formally on St Bartholomew's Eve, and on his way to stop at Newgate where he received from the governor a cup of sack. In 1753, owing to the change in the calendar, the fair was proclaimed on the 3rd of September. During its earlier history the fair grew to be a vast national market and the chief cloth sale in the kingdom. Down to 1854 it was used for the representative of the Merchant Taylors' Guild to proceed to the cloth fair which formed part of Bartholomew fair, and test the measures used for selling cloth there by the company's silver yard. The fair was finally closed in 1855.

For a full account see Prof. H. Morley, *Memoirs of Bartholomew Fair* (1859).

BARTIZAN (according to the *New English Dictionary*, from *bertisane*, a Scottish corruption of "bratticing" or "brattishing," from O. Fr. *bratesche*, and meaning a battlemented parapet; apparently first used by Sir Walter Scott), a small battlemented turret, corbelled out at the angle of a wall or tower to protect a warder and enable him to see around him. Bartizans generally are furnished with oylets or arrow-slits.

BARTLETT, JOHN (1820-1905), American publisher and compiler, was born in Plymouth, Massachusetts, on the 14th of June 1820. He became a bookseller and publisher in Cambridge, Mass., and from 1865 to 1889, when he retired, was a member of the bookselling and publishing firm of Little, Brown & Co., in Boston. In 1855 he published the first edition of his *Familiar Quotations*, subsequently greatly expanded and long the best-known collection of the sort, and in 1894 (although it had been copyrighted five years before), after many years' labour, he published his *New and Complete Concordance or Verbal Index to Words, Phrases and Passages in the Dramatic Works of Shakespeare; with a Supplementary Concordance to the Poems*—surpassing any of its predecessors in the number and fulness of its citations from the poet's writings. In all of his work he was greatly assisted by his wife, a daughter of Sidney Willard (1780-1856), professor of Hebrew at Harvard from 1807 to 1831. Bartlett died at Cambridge, Mass., on the 3rd of December 1905.

BARTLETT, JOHN RUSSELL (1805-1886), American historical and linguistic student, was born in Providence, Rhode Island, on the 23rd of October 1805. From his first to his eighteenth

year he lived in Kingston, Canada; he was then in turn, from 1824 to 1836, a clerk in a dry goods store, a book-keeper and a bank cashier at Providence, and for more than ten years after 1836 he was a bookseller in New York City, returning to Providence in 1850. In 1850-1853 he was the commissioner on the part of the United States for the survey of the boundary between the United States and Mexico, but owing to the lack of funds did not finish the work. After being superseded by another commissioner upon the accession of President Franklin Pierce, he published *A Personal Narrative of Explorations and Incidents in Texas, New Mexico, California, Sonora and Chihuahua* (2 vols., 1854), which contains much valuable scientific and historical material concerning the south-west. From 1855 to 1872 he was secretary of state of Rhode Island, and while serving in this capacity thoroughly re-arranged and classified the state records, and prepared various bibliographies and compilations, relating chiefly to the history of the state. He is chiefly remembered however, for his *Dictionary of Americanisms* (1848), a pioneer work, which, although later dialect changes have, of course, deprived it of completeness or final authoritativeness, is still of value to students of language and remains the chief contribution to the subject. He died in Providence on the 28th of May 1886.

BARTLETT, PAUL WAYLAND (1865-), American sculptor, was born in New Haven, Connecticut, the son of Truman H. Bartlett, an art critic and sculptor. When fifteen he began to study at Paris under Frémiet, modelling from animals in the Jardin des Plantes. He won a medal at the Paris Salon of 1887. Among his principal works are: "The Bear Tamer," in the Metropolitan Museum of Art, New York; the equestrian statue of Lafayette, in the Place du Carrousel, Paris, presented to the French Republic by the school children of America; the powerful and virile Columbus and Michelangelo, in the Congressional Library, Washington, D.C.; the "Ghost Dancer," in the Pennsylvania Academy, Philadelphia; the "Dying Lion"; the equestrian statue of McClellan in Philadelphia; and a statue of Joseph Warren in Boston, Massachusetts. His bronze patinas of reptiles, insects and fish are also remarkable.

BARTOLI, DANIELO (1608-1685), Italian Jesuit priest, was born at Ferrara and entered the Society of Jesus in 1623. Debarred from the foreign mission field, he attained high distinction as a preacher and as a teacher of rhetoric in Genoa, Florence and Rome. He wrote (in Italian) a book called *The Learned Man* as a counterblast to the widespread reading of romances, and also a history of his order in 6 vols. (Rome, 1650-1673), which is particularly informing with regard to the early work of the society in Asia. He died at Rome.

A collected edition of his works, in 12 vols., was published by Marietti at Turin, 1825-1856; another in 50 vols. at Florence in 1826.

BARTOLINI, LORENZO (1777-1850), Italian sculptor, was born in Vernio in Tuscany. After acquiring great skill and reputation as a modeller in alabaster, he went in 1797 to Paris, where he studied painting under Desmarests, and afterwards sculpture under F. F. Lemot. The bas-relief "Cleobis and Biton," with which he gained the second prize of the Academy in 1803, at once established his fame as a sculptor and gained for him a number of influential patrons. He executed many minor pieces for Denon, besides busts of Mèhul and Cherubini. His great patron, however, was Napoleon, for whom he executed a colossal bust, and who sent him to Carrara to found a school of sculpture. Here he remained till after the fall of Napoleon, and then took up his residence in Florence, where he resided till his death. His works are varied and include an immense number of busts. The best are, perhaps, the group of Charity, the "Hercules and Lichas" and the "Faith in God," which exemplify the highest types of Bartolini's style. Popular opinion in Italy associates his qualities as a sculptor with those of Thorwaldsen and Canova.

BARTOLOMMEI, MARQUIS FERDINANDO (1821-1869), Italian revolutionist and statesman, who played an important part in the political events of Tuscany from 1848 to 1860. From the beginning of the revolutionary movement Bartolommei was always an ardent Liberal, and although belonging to an old and

noble Florentine family his sympathies were with the democratic party rather than with the moderately liberal aristocracy. In 1847-1848 his house was a centre of revolutionary committees, and during the brief constitutional régime he was much to the fore. After the return of the grand duke Leopold II. in 1849 under Austrian protection, Bartolommei was present at a requiem service in the church of Santa Croce for those who fell in the late campaign against Austria; on that occasion disorders occurred and he was relegated to his country estate in consequence (1851). Shortly afterwards he was implicated in the distribution of seditious literature and exiled from Tuscany for a year. He settled at Turin for a time and established relations with Cavour and the Piedmontese liberals. He subsequently visited France and England, and like many Italian patriots became enamoured of British institutions. He returned to Florence in 1853; from that time onward he devoted himself to the task of promoting the ideas of Italian independence and unity among the people, and although carefully watched by the police, he kept a secret printing-press in his palace in Florence. Finding that the nobility still hesitated at the idea of uncompromising hostility to the house of Lorraine, he allied himself more firmly with the popular party, and found an able lieutenant in the baker Giuseppe Dolfi (1818-1869), an honest and whole-hearted enthusiast who had great influence with the common people. As soon as war between Piedmont and Austria appeared imminent, Bartolommei organized the expedition of Tuscan volunteers to join the Piedmontese army, spending large sums out of his own pocket for the purpose, and was also president of the Tuscan branch of the *Società Nazionale* (see under LA FARINA and CAVOUR). He worked desperately hard conspiring for the overthrow of the grand duke, assisted by all the liberal elements, and on the 27th of April 1859, Florence rose as one man, the troops refused to fire on the people, and the grand duke departed, never to return. *Sopristiti! pas un carecau cass!* was the comment of the French minister to Tuscany on this bloodless revolution. A provisional government was formed and Bartolommei elected *gonfaloniere*. He had much opposition to encounter from those who still believed that the retention of the grand duke as a constitutional sovereign and member of an Italian confederation was possible. In the summer elections were held, and on the meeting of parliament Bartolommei's unitarian views prevailed, the assembly voting the resolution that the house of Lorraine had forfeited its rights and that Tuscany must be united to Italy under King Victor Emmanuel. Bartolommei was made senator of the Italian kingdom and received various other honours. His last years were spent in educational and philanthropic work. He died on the 15th of June 1869, leaving a widow and two daughters.

The best biography of Bartolommei is contained in *Il Rivoluzionario Toscano e l'azione popolare*, by his daughter Matilde Gioli (Florence, 1905), but the author attributes perhaps an undue preponderance to her father in the Tuscan revolution, and is not quite fair towards Bettino Ricasoli (q.v.) and other leaders of the aristocratic party. Cf. *Lettere e documenti di B. Ricasoli* (Florence, 1887-1896), and D. Zanichelli's *Lettere politiche di B. Ricasoli, U. Peruzzi, N. Corsini, e C. Ricaldi* (Bologna, 1898).

BARTOLOMMEO DI PAGHOLO, FRA (1475-1517), the Italian historical and portrait painter, — known also as BACCIO (short for Bartolommeo) DELLA PORTA (because he lived near the Porta Romana), was born at Soffignano, near Florence, in 1475, and died at Florence in 1517. He received the first elements of his artistic education from Cosimo Roselli; and after leaving him, devoted himself to the study of the great works of Leonardo da Vinci. Of his early productions, which are distinguished for their grace and beauty, the most important is the fresco of the Last Judgment, in which he was assisted by his friend Mariotto Albertinelli. While he was engaged upon some pieces for the convent of the Dominican friars, he made the acquaintance of Savonarola, who quickly acquired great influence over him, and Bartolommeo was so affected by his cruel death, that he soon after entered the convent, and for some years gave up his art. He had not long resumed it, in obedience to his superior, when Raphael came to Florence and formed a close friendship with

him. Bartolommeo learned from the younger artist the rules of perspective, in which he was so skilled, while Raphael owes to the *frate* the improvement in his colouring and handling of drapery, which was noticeable in the works he produced after their meeting. Some years afterwards he visited Rome, and was struck with admiration and a feeling of his own inferiority when he contemplated the masterpieces of Michelangelo and Raphael. With the latter, however, he remained on the most friendly terms, and when he departed from Rome, left in his hands two unfinished pictures which Raphael completed. Fra Bartolommeo's figures had generally been small and draped. These qualities were alleged against him as defects, and to prove that his style was not the result of want of power, he painted the magnificent figure of St Mark (his masterpiece, at Florence), and the undraped figure of St Sebastian. The latter was so well designed, so naturally and beautifully coloured, and so strongly expressive of suffering and agony, that it was found necessary to remove it from the place where it had been exhibited in the chapel of a convent. The majority of Bartolommeo's compositions are altar-pieces. They are remarkable for skill in the massing of light and shade, richness and delicacy of colouring, and for the admirable style in which the drapery of the figures is handled, Bartolommeo having been the first to introduce and use the lay-figure with joints.

BARTOLOZZI, FRANCESCO (1725-1815), Italian engraver, was born at Florence. He was originally destined to follow the profession of his father, who was a gold- and silver-smith; but he manifested so much skill and taste in designing that he was placed under the superintendence of two Florentine artists, who instructed him in painting. After devoting three years to that art, he went to Venice and studied engraving. He made very rapid progress, and executed some works of considerable importance at Venice. He then removed for a short time to Rome, where he completed a set of engravings representing events from the life of St Nilus, and, after returning to Venice, set out for London in 1764. For nearly forty years he resided in London, and produced an enormous number of engravings, the best being those of Clytie, after Annibale Caracci, and of the Virgin and Child, after Carlo Dolce. A great proportion of them are from the works of Cipriani and Angelica Kauffmann. Bartolozzi also contributed a number of plates to Boydell's *Shakespeare Gallery*. In 1802 he was invited to Lisbon as director of the National Academy. He remained in Portugal till his death. His son Gaetano Stephano (1757-1821), also an engraver, was the father of Madame Vestris.

BARTOLUS (1314-1357), Italian jurist, professor of the civil law at the university of Perugia, and the most famous master of the dialectical school of jurists, was born in 1314, at Sassoferrato, in the duchy of Urbino, and hence is generally styled Bartolus de Saxoferrato. His father was Franciscus Severi, and his mother was of the family of the Alfani. He studied the civil law first of all under Cinus at Perugia, and afterwards under Oldradus and Jacobus de Belvisio at Bologna, where he was promoted to the degree of doctor of civil law in 1334. His great reputation dates from his appointment to a chair of civil law in the university of Perugia, 1343, where he lectured for many years, raising the character of the law school of Perugia to a level with that of Bologna. He died in 1357 at Perugia, where a magnificent monument recorded the interment of his remains in the church of San Francisco, by the simple inscription of "Ossa Bartoli." Bartolus left behind him a great reputation, and many writers have sought to explain the fact by attributing to him the introduction of the dialectical method of teaching law; but this method had been employed by Odofredus, a pupil of Accursius, in the previous century, and the successors of Odofredus had abused it to an extent which has rendered their writings in many instances unprofitable to read, the subject matter being overlaid with dialectical forms. It was the merit of Bartolus, on the other hand, that he employed the dialectical method with advantage as a teacher, and discountenanced the abuse of it; but his great reputation was more probably owing to the circumstance that he revived the exegetical system of teaching law (which had been

neglected since the ascendancy of Accursius) in a spirit which gave it new life, whilst he imparted to his teaching a practical interest, from the judicial experience which he had acquired while acting as assessor to the courts at Todi and at Pisa before he undertook the duties of a professorial chair. His treatises *On Procedure* and *On Evidence* are amongst his most valuable works, whilst his *Commentary on the Code of Justinian* has been in some countries regarded as of equal authority with the code itself.

BARTON, BENJAMIN SMITH (1766-1815), American naturalist, was born at Lancaster, Pennsylvania, in 1766, studied for two years at Edinburgh, and afterwards graduated at Göttingen. He settled at Philadelphia, and soon obtained a considerable practice. In 1789 he was appointed professor of botany and natural history in the College of Philadelphia, now the University of Pennsylvania; he was made professor of *materia medica* in 1795, and on the death of Dr Benjamin Rush in 1813 he obtained the chair of practical medicine. In 1802 he was chosen president of the American Philosophical Society, of which he was a strong supporter. Barton was the author of various works on natural history, botany and *materia medica*, his *Elements of Botany* (1803) being the best known. He died at Philadelphia on the 10th of December 1815.

BARTON, BERNARD (1784-1849), English poet, was born at Carlisle on the 31st of January 1784. His parents were Quakers, and he was commonly known as the Quaker poet. After some experience of business, he became, in 1809, clerk to Messrs Alexander's bank at Woodbridge, Suffolk, and retained this post till his death. His first volume of verse—*Metrical Effusions*—was published in 1812. It brought him into correspondence with Southey, and shortly afterwards, through the medium of a set of complimentary verses, he made the acquaintance of Hogg. From this time onwards to 1828 Barton published various volumes of verse. After 1828 his work appeared but rarely in print, but his *Household Verses* published in 1845 secured him, on the recommendation of Sir Robert Peel, a Civil List pension of £100 a year, £1200 having already been raised for him by some members of the Society of Friends. Barton is chiefly remembered for his friendship with Charles Lamb, which arose, curiously enough, out of a remonstrance addressed by him to the author of *Essays of Elia* on the freedom with which the Quakers had been handled in that volume. When Barton contemplated resigning his bank clerkship and supporting himself entirely by literature, Lamb strongly dissuaded him. "Keep to your bank," he wrote, "and the bank will keep you." Barton died at Woodbridge on 19th February 1849. His daughter Lucy married Edward FitzGerald.

See *Poems and Letters of Bernard Barton*, selected by Lucy Barton, with a biographical notice by Edward FitzGerald (1849).

BARTON, CLARA (1821-), American philanthropist, was born in Oxford, Massachusetts, in 1821. She was educated at the Clinton Liberal Institute (then in Clinton, New York). Ill-health compelled her to give up the profession of teaching, which she had taken up when she was only sixteen years old, and from 1854 to 1857 she was a clerk in the Patent Office at Washington. During the Civil War she distributed large quantities of supplies for the relief of wounded soldiers; and at its close she organized at Washington a bureau of records to aid in the search of missing men for whom inquiries were made. In connexion with this work, which was continued for about four years, she identified and marked the graves of more than twelve thousand soldiers in the National Cemetery at Andersonville, Georgia. In 1866 she went for her health to Switzerland. Upon her arrival at Geneva she was visited by members of the International Committee of the Red Cross, who sought her co-operation in the work of their society. The United States had declined to become a party to the treaty of Geneva on the basis of which the Red Cross Society was founded, but upon the outbreak of the Franco-Prussian War Miss Barton went with members of this society to the seat of hostilities and assisted them in organizing their military hospitals. In 1871 she superintended the distribution of relief to the poor in Strassburg, and in 1872 performed a like service in Paris. For her services she was decorated with the Iron Cross by

the German emperor. In 1873 she returned to the United States, where she at once began her efforts to effect the organization of the United States branch of the Red Cross and to bring her country into the treaty of Geneva, which efforts were successful in 1881-1882. She was the first president of the American Red Cross, holding the position until 1904; and represented the United States at the International conference held at Geneva, 1884; Karlsruhe, 1887; Rome, 1892; Vienna, 1897; and St Petersburg, 1903. She was the author of the American amendment to the constitution of the Red Cross which provides that the society shall distribute relief not only in war but in times of such other calamities as famines, floods, earthquakes, cyclones, and pestilence, and in accordance with this amended constitution, she conducted the society's relief for sufferers from the yellow fever in Florida (1887), the flood at Johnstown, Pennsylvania (1889), the famine in Russia (1891), the hurricane along the coast of South Carolina (1893), the massacre in Armenia (1896), the Spanish-American War in Cuba (1898), the hurricane at Galveston, Texas (1900), and several other calamities. Upon her retirement from the Red Cross she incorporated and became president of "The National First Aid America" for "the first aid to the injured." She wrote *An Official History of the Red Cross* (1882), *The Red Cross in Peace and War* (1898), *A Story of the Red Cross* (1904), and *Story of my Childhood* (1907).

BARTON, ELIZABETH (c. 1506-1534), "the maid of Kent," was, according to her own statement, born in 1506 at Aldington, Kent. She appears to have been a neurotic girl, subject to epilepsy, and an illness in her nineteenth year resulted in hysteria and religious mania. She was at the time a servant in the house of Thomas Cobb, steward of an estate near Aldington owned by William Warham, archbishop of Canterbury. During her convalescence she passed into trances lasting for days at a time, and in this state her ravings were of such "marvellous holiness in rebuke of sin and vice" that the country folk believed her to be inspired. Cobb reported the matter to Richard Masters, the parish priest, who in turn acquainted Archbishop Warham. The girl having recovered, and finding herself the object of local admiration, was cunning enough, as she confessed at her trial, to feign trances, during which she continued her prophecies. Her fame steadily growing, the archbishop in 1526 instructed the prior of Christ Church, Canterbury, to send two of his monks to hold an inquiry into the case. One of these latter, Edward Bocking, obtained her admission as a nun to St Sepulchre's convent, Canterbury. Under Bocking's instruction Barton's prophecies became still more remarkable, and attracted many pilgrims, who believed her to be, as she asserted, in direct communication with the Virgin Mary. Her utterances were cunningly directed towards political matters, and a profound and widespread sensation was caused by her declaration that should Henry persist in his intention of divorcing Catherine he "should no longer be king of this realm . . . and should die a villain's death." Even such men as Fisher, bishop of Rochester, and Sir Thomas More, corresponded with Barton. On his return from France in 1532 Henry passed through Canterbury and is said to have allowed the nun to force herself into his presence, when she made an attempt to terrify him into abandoning his marriage. After its solemnization in May 1533, her utterances becoming still more treasonable, she was examined before Cranmer (who had in March succeeded to the archbishopric on Warham's death) and confessed. On the 25th of September Bocking and another monk, Hadley, were arrested, and in November, Masters and others were implicated. The maid and her fellow prisoners were examined before the Star Chamber, and were by its order publicly exposed at St Paul's Cross, where they each read a confession. In January 1534 by a bill of attainder the maid and her chief accomplices were condemned to death, and were executed at Tyburn on the 20th of April. It has been held that her confession was extracted by force, and therefore valueless, but the evidence of her imposture seems conclusive.

See Froude, *History of England*; Burnet, *History of the Reformation*; Lingard, *History of England*; F. A. Gasquet, *Henry VIII.*

and the English Monasteries (ch. iii. 1899 ed.); T. E. Bridgett, *Life of Blessed John Fisher* (1888); vols. vi. and vii. of *Letters and Papers of Henry VIII.*; James Gairdner, *The English Church in the 16th Century* (1899); Strype, *Memorials*, I. i. 271, and *Cramer*; a detailed account of the case is contained in the published Act of Attainder 25 Henry VIII. c. 12.

BARTON BEDS, in geology, the name given to a series of softish grey and brown clays, with layers of sand, of Upper Eocene age, which are found in the Hampshire Tertiary basin, where they are particularly well exposed in the cliffs of Barton, Horndew, and in the Isle of Wight. Above the highly fossiliferous Barton Clay there is a sandy series with few fossils; these are the Headon Hill or Barton Sands. Either of these names is preferable to the term "Upper Bagshot Beds," which has been applied to these sands. The Barton Beds are absent from the London basin, and the Upper Bagshot Sands of that area are probably at a lower horizon than the Barton Sands. The term "Bartonien" was introduced by Mayer-Eymar in 1857 for the continental equivalents of the series.

Hampshire basin and
Isle of Wight.

Paris basin.

Barton Sands 140-200 ft. }
Barton Clay 162-255 ft. } Bartonien {
Limestone of St Ouen.
Sands of Beauchamp
(sables moyen).

Fusus longaevis, *Volutilithes lactatrix*, *Ostrea gigantea*, *Pectunculus (Glycimeris) deleta* are characteristic fossils; fishes (*Lamna*, *Arius*, &c.) and a crocodile (*Diplocynodon*) are also found in the Barton Clay. The sands are very pure and are used in glass making.

See "Geology of the Isle of Wight," *Mem. Geol. Survey* (2nd ed., 1889); and "The Geology of the Country around Southampton," *Mem. Geol. Survey* (1902). (J. A. H.)

BARTON-UPON-HUMBER, a market town in the N. Lindsey or Brigg parliamentary division of Lincolnshire, England, the terminus of a branch of the Great Central railway, 44 m. N. by E. of Lincoln. Pop. of urban district (1901) 5671. It lies beneath low hills, on flat ground bordering the Humber, but the centre of the town is a mile from the river. The church of St Peter has a remarkable west tower of pre-Conquest workmanship, excepting the early Norman top storey. Against the western face is a low building of the date of the lower tower-stories, measuring 15 ft. by 12, with rude, deeply-splayed windows. The tower itself is arcaded in the two lower storeys, having round arches in the lower and triangular in the upper, and there is a round-headed S. doorway and a triangular-headed N. doorway. The rest of the church is Decorated and Perpendicular. The church of St Mary is fine Early English with Perpendicular clerestory. Industries include brick-making, malting, and rope-making. Barton appears in Domesday, when the ferry over the Humber existed. As a port, moreover, it subsequently rose into some importance, for it was able to supply eight ships and men to the expedition of Edward III. to Brittany.

BARUCH, the name (meaning "Blessed" in Hebrew) of a character in the Old Testament (Jer. xxxvii., xxxviii., xliiii.), associated with the prophet Jeremiah, and described as his secretary and spokesman.

BOOK OF BARUCH. This deuterocanonical book of the Old Testament is placed by the LXX. between *Jeremiah* and *Lamentations*, and in the Vulgate after *Lamentations*. It consists of several parts, which cohere so badly that we are obliged to assume plurality of authorship.

Contents.—The book consists of the following parts:—

i. 1-14. The historical preface with a description of the origin and purpose of the book.

i. 15-ii. 5. A confession of sin used by the Palestinian Remnant. This confession was according to i. 14 sent from Babylon (i. 4, 7) to Jerusalem to be read "on the day of the feast and on the days of the solemn assembly." The confession is restricted to the use of the remnant at home (see next paragraph). In this confession there is a national acknowledgment of sin and a recognition of the Exile as a righteous judgment.

ii. 6-iii. 8. A confession of the captives in Babylon and a prayer for restoration. This confession opens as the former

(in i. 15) with the words found also in Daniel ix. 7, "To the Lord our God belongeth righteousness, &c." The confession is of the Exiles and not of the remnant in Palestine, as Marshall has pointed out. Thus it is the Exiles clearly who are speaking in ii. 13, "We are but a few left among the heathen where thou hast scattered us"; ii. 14, "Give us favour in the sight of them which have led us away captive"; iii. 7, "We will praise thee in our captivity"; iii. 8, "We are yet this day in our captivity where thou hast scattered us." On the other hand the speakers in the confession in i. 15-ii. 5 are clearly the remnant in Jerusalem. i. 15, "To the Lord our God belongeth righteousness, but unto us confusion of face . . . to the men of Judah and the inhabitants of Jerusalem." The Exiles are mentioned by way of contrast to the speakers; ii. 4, 5, "He hath given *them* to be in subjection to all the kingdoms that are round about *us* to be a reproach among all the people round about where the Lord hath scattered *them*. Thus were they cast down . . . because *we* sinned against the Lord our God."

iii. 9-iv. 4. The glorification of wisdom, that is, of the Law. Israel is bidden to walk in the light of it; it is the glory of Israel and is not to be given to another.

iv. 5-v. 9. Consolation of Israel with the promise of deliverance and lasting happiness and blessing to Jerusalem.

Integrity.—From the foregoing description it seems clear that the book is derived from a plurality of authors. Most scholars, such as Fritzsche, Hitzig, Kneucker, Hilgenfeld, Reuss, agree in assuming that i.-iii. 8 and iii. 9-v. 9 are from distinct writers. But some critics have gone farther. Thus Rothstein (Kautzsch, *Apok. und Pseud.* i. 213-215) holds that there is no unity in iii. 9-v. 9, but that it is composed of two independent writings—iii. 9-iv. 4 and iv. 5-v. 9. Marshall (Hastings) *Bible Dictionary*, i. 251-254) gives a still more complex analysis. He finds in it the work of four distinct writers: i. 1-14, i. 15-iii. 8, iii. 9-iv. 4, iv. 5-v. 9. The evidence for a fourfold authorship is strong though not convincing. In any case i.-iii. 8 and iii. 9-v. 9 must be ascribed to different authors.

Original Language.—(1) Some scholars, as Ewald, Kneucker, Davidson, Rothstein and König, believe that the whole book was originally written in Hebrew; (2) Fritzsche, Hilgenfeld, Reuss, Gifford, Schröder, and Toy advocate a Hebrew original of i.-iii. 8 and a Greek original of the rest; (3) Marshall argues that i.-iii. 8 is translated from a Hebrew original, iii. 9-iv. 4 from an Aramaic, and the rest from the Greek; (4) and lastly, Bertholdt, Havernick and Nöldeke regard the Greek as the primitive text. The last view must be put aside as unworkable. For the third no convincing evidence has been adduced, nor does it seem likely that any can be. We have therefore to decide between the two remaining theories. In any case we can hardly err in admitting a Hebrew original of i.-iii. 8. For (1) we have such Hebraisms as $\alpha\delta\ \dots\ \epsilon\pi\ \alpha\lambda\theta\epsilon\omega\ =\ \text{יִשְׂרָאֵל}$ (ii. 26); $\alpha\delta\ \dots\ \epsilon\kappa\epsilon\iota\ =\ \text{וְעַתָּה}$ (ii. 4, 13, 20; iii. 8); $\omega\upsilon\ \dots\ \tau\acute{o}\ \nu\epsilon\mu\alpha\ \alpha\lambda\theta\epsilon\omega\ =\ \text{וְעַתָּה}$ (ii. 7). (2) We have meaningless expressions which are really mistranslations of the Hebrew. It is noteworthy that these mistranslations are for the most part found in Jeremiah—a fact which has rightly drawn scholars to the conclusion that we owe the LXX of Baruch i.-iii. 8, and of Jeremiah to the same translator. Thus in i. 9 we have $\delta\epsilon\sigma\mu\acute{\alpha}\tau\eta\varsigma$, "prisoner," where the text had עֶבֶר and the Greek should have been rendered "locksmit." The same mistranslation is found in Jer. xxiv. 1, xxxvi. (xxx). Next in ii. 4 we have $\alpha\beta\alpha\tau\omega\varsigma$, "wilderness," where the text had וְעַתָּה and the translation should have עֶבֶר . The same misrendering is found several times in Jeremiah. Again ἐργάζεσθαι is used in i. 22, ii. 21, 22, 24 as a translation of עָבַד in the sense of "serving," where δουλέω ought to have been the rendering. So also in Jer. xxiv. (xxvii.) 11, xxxvii. (xxx). 8, &c. Again in $\text{πόλεω}\ \text{Ἰουδα}\ \text{καὶ}\ \text{ἐξώθεν}\ \text{Ἱερουσαλὴμ}\ \text{τοὺς}\ \text{ἐξώθεν}$ is a misrendering of וְעַתָּה as in Jer. xi. 6, xl.

1 Toy (*Jewish Enc.* ii. 556) thinks that the "them" in ii. 4, 5 may be a scribal slip and that we have here not the confession of the Palestinian remnant and that of the Exiles, but simply a juxtaposition of two forms of confession.

(xxxiii) 10, &c., where the translator should have given $\pi\lambda\alpha\rho\epsilon\upsilon\sigma\iota$.¹ For $\beta\omicron\upsilon\beta\eta\sigma\iota\varsigma$ (ii. 29) $\pi\alpha$ we should have $\pi\lambda\theta\omicron\varsigma$. (3) Finally there are passages where by re-translation we discover that the translator either misread his text or had a corrupt text before him. Thus $\mu\alpha\lambda\iota\alpha$ in i. 10 is a corrupt translation of $\pi\alpha$ as elsewhere in a dozen passages of the LXX. In iii. 4 $\tau\epsilon\theta\eta\kappa\omicron\tau\omega\upsilon\omega\upsilon$ = $\tau\epsilon$ —which the translator should have read as $\tau\epsilon$ = $\alpha\theta\omicron\rho\omega\tau\omega\upsilon$.

From the above instances, which could be multiplied, we have no hesitation in postulating a Hebrew original of i.-iii. 8.

As regards iii. 9-v. 9 the case is different. This section is free from such notable Hebraisms as we have just dealt with, and no convincing grounds have been advanced to prove that it is a translation from a Semitic original.

Date.—The dates of the various constituents of the book are quite uncertain. Ewald, followed by Gifford and Marshall, assigns i.-iii. 8 to the period after the conquest of Jerusalem by Ptolemy I. in 320 B.C.; Reuss to some decades later; and Fritzsche, Schrade, Keil and Toy to the time of the Maccabees. Hitzig, Kneucker and Schürer assume that it was written after A.D. 70. Ryle and James (*Pss. of Solomon*, pp. lxxii.-lxxvii.) hold that iv. 31-v. 9 is dependent on the Greek version of Ps. xi., and that, accordingly, Baruch was reduced to its present form after A.D. 70. The most probable of the above dates appears to be that maintained by Fritzsche, that is, if we understand by the Maccabean times the early decades of the 2nd cent. B.C. For during the palmy days of the Maccabean dynasty the Twelve tribes were supposed to be in Palestine. The idea that the Jewish Kingdom embraced once again the entire nation easily arose when the Maccabees extended their dominion northwards over Samaria and Galilee and eastwards beyond the Jordan. This belief displaced the older one that the nine and a half tribes were still in captivity. With the downfall of the Maccabean dynasty, however, the older idea revived in the 1st cent. A.D. To the beginnings of the 2nd cent. A.D. the view of the dead given in ii. 17 would point, where it is said that those whose spirits had been taken from their bodies would not give glory unto the Lord. The statement as to the desolate condition of the Temple in ii. 26 is with Kneucker to be rejected as an interpolation.

Canoncity.—The Book of Baruch was never accepted as canonical by the Palestinian Jews (Baba Batra 14^b), though the *Apostolic Constitutions*, v. 10, state that it was read in public worship on the 10th day of the month Gorpiaeus, but this statement can hardly be correct. It was in general use in the church till its canoncity was rejected by the Protestant churches and accepted by the Roman church at the council of Trent.

Literature. Versions and Editions.—The versions are the two Latin, a Syriac, and an Arabic. The Latin one in the Vulgate belongs to a time prior to Jerome, and is tolerably literal. Another, somewhat later, was first published by Jos. Maria Caro in 1688, and was reprinted by Sabatier, side by side with the ante-Hieronimian one, in his *Bibliorum Sacrorum Latinae Versiones Antiquae*. It is founded upon the preceding one, and is less literal. The Syriac and Arabic versions, printed in the London Polyglot, are literal. The Hexaplar-Syriac version made by Paul, bishop of Tella, in the beginning of the 7th century has been published by Ceriani.

The most convenient editions of the Greek text are Tischendorf's in the second volume of his *Septuaginta*, and Swete's in vol. iii.; Fritzsche's in *Libri Apocryphi Veteris Testamenti Graece* (1871); the best editions of the book are Kneucker's *Das Buch Baruch* (1879); Gifford's in the *Speaker's Apoc.* ii. See also the articles in the *Encyc. Biblica*, *Hastings' Bible Dictionary*; Schürer, *History of Jewish People*.

APOCALYPSE OF BARUCH. The discovery of this long lost apocalypse was due to Ceriani. This apocalypse has survived only in the Syriac version of which Ceriani discovered a 6th century MS. in the Milan library. Of this he published a Latin translation in 1866 (*Monumenta Sacra*, i. ii. 73 98), which Fritzsche reproduced in 1871 (*Libri Apocryphi V. T.*, pp. 654-699), and the text in 1871 (*Mon. Sacra*, V. ii. 113-180), and subsequently

¹ In ii. 25 we have the word $\delta\omicron\sigma\theta\omicron\delta\omicron\upsilon\omega\upsilon$ with the extraordinary meaning of "plague" as in Jer. xxxix. (xxxii.) 36.

in photo-lithographic facsimile in 1883. Chaps. lxxviii.-lxxvii., indeed, of this book have long been known. These constitute Baruch's epistle to the nine and a half tribes in captivity, and have been published in Syriac and Latin in the London and Paris Polyglots, and in Syriac alone from one MS. in Lagarde's *Libri V. T. Apocryphi Syr.* (1861); and by Charles from ten MSS. (*Apocalypse of Baruch*, 1866, pp. 124-167). The entire book was translated into English by the last-named writer (*op. cit.*, pp. 1-167), and into German by Ryssel (*Kautzsch's Apok. und Pseud.*, 1900, ii. pp. 413-446).

The Syriac is translated from the Greek; for Greek words are occasionally transliterated, and passages can be explained only on the hypothesis that the wrong alternative meanings of certain Greek words were followed by the translator. The Greek in turn is derived from the Hebrew, for unintelligible expressions in the Syriac can be explained and the text restored by retranslation into Hebrew. Thus in xxi. 9, "those who sin and those who are justified." The source of the error can be discovered by retranslation. The Syriac in these passages is a stock rendering of $\delta\iota\kappa\alpha\iota\omicron\sigma\theta\omicron\delta\omicron\upsilon\omega\upsilon$, and this in turn of $\pi\alpha$. But $\pi\alpha$ means not only $\delta\iota\kappa\alpha\iota\omicron\sigma\theta\omicron\delta\omicron\upsilon\omega\upsilon$ but also $\delta\iota\kappa\alpha\iota\omicron\sigma$ $\epsilon\iota\pi\alpha\iota$, and this is the very meaning required by the context in the above passages: "those who sin and those who are righteous."² Again xlv. 12 the text reads: "the new world which does not turn to corruption those who depart on its beginning and has no mercy on those who depart to torment." Here "on its beginning" is set over antithetically against "to torment," whereas the context requires "to its blessedness." The words "on its beginning"— $\iota\sigma\theta\iota$, a corruption of $\iota\sigma\theta\iota$ —"to its blessedness." Again in lvi. 6 it is said that the fall of man brought grief, anguish, pain, trouble and boasting into the world. The term "boasting" in this connexion cannot be right. The word = $\kappa\alpha\iota\chi\eta\mu\alpha$ = $\eta\eta\eta\eta$ (?), corrupt for $\eta\eta\eta$, "disease." A further ground for inferring a Hebrew original is to be found in the fact that paronomasiae not infrequently discover themselves in the course of retranslation into Hebrew. One instance will suffice. In xlviii. 35, "Honour will be turned into shame, strength humiliated into contempt . . . and beauty will become a scorn" contains three such: $\kappa\omicron\upsilon\beta\eta\sigma\iota\varsigma$ (see Charles, *Apoc. Bar.* pp. xlv.-xlii.). The necessity of postulating a Hebrew original was first shown by the present writer, and has since been maintained by Wellhausen (*Skizzen u. Vorarbeiten*, vi. 234), by Ryssel (*Apok. und Pseudopig. A. T.*, 1900, ii. 411), and Ginzberg (*Jewish Encyclopaedia*, ii. 555).

Different Elements in the Book and their Dates.—As there are undoubtedly conflicting elements in the book, it is possible to assume either a diversity of authorship or a diversity of sources. The latter view is advocated by Ryssel and Ginzberg, the former by Kabisch, de Faye, R. H. Charles and Beer (*Herzog's Real-enc.*, art. "Pseudepigraphen des Alten Testaments," p. 250). A short summary may here be given of the grounds on which the present writer has postulated a diversity of authorship. If the letter to the tribes in captivity (lxxviii.-lxxxvi.) be disregarded, the book falls into seven sections separated by fasts, save in one case (after xxxv.) where the text is probably defective. These sections, which are of unequal length, are—(1) i.-v. 6; (2) v. 7-viii.; (3) ix.-xii. 4; (4) xii. 5-xx.; (5) xxi.-xxxv.; (6) xxxvi.-xlvi.; (7) xlvii.-lxxvii. These treat of the Messiah and the Messianic kingdom, the woes of Israel in the past and the destruction of Jerusalem in the present, as well as of theological questions relating to original sin, free will, works, the number of the saved, the nature of the resurrection body, &c. The views expressed on several of the above subjects are often conflicting. In one class of passages there is everywhere manifest a vigorous optimism as to Israel's ultimate well-being on earth, and the blessedness of the chosen people in the Messianic kingdom is sketched in glowing and sensuous colours (xxix., xxxix.-xl., lxiii.-lxxiv.). Over against these passages stand others of a hopelessly pessimistic character, wherein, alike as to Israel's

² Ryssel has adopted Charles's restoration of the text in these passages and practically also in xlv. 12, but without acknowledgment.

present and future destiny on earth, there is written nothing save "lamentation, and mourning, and woe." The world is a scene of corruption, its evils are irremediable, its end is nigh, and the advent of the new and spiritual world at hand. The first to draw attention to the composite elements in this book was Kabisch (*Jahrbücher f. protest. Theol.*, 1891, pp. 66-107). This critic regarded xxiv. 3-xxix., xxxvi.-xl. and liii.-lxxiv. as independent sources written before the fall of Jerusalem, A.D. 70, and his groundwork, which consists of the rest of his book, with the exception of a few verses, as composed after that date. All these elements were put together by a Christian contemporary of Papias. Many of these conclusions were arrived at independently by a French scholar, De Faye (*Les Apocalypses juives*, 1892, pp. 25-28, 76-103, 192-204). The present writer (*Apocalypse of Baruch*, 1896, pp. liii.-lxxvii.), after submitting the book to a fresh study, has come to the following conclusions:—The book is of Pharisaic authorship and composed of six independent writings—A¹, A², A³, B¹, B², B³. The first three were composed when Jerusalem was still standing and the Messiah and the Messianic kingdom were expected: A¹, a mutilated apocalypse = xxvii.-xxx. 1; A², the Cedar and Vine Vision = xxxvi.-xl.; A³, the Cloud Vision = liii.-lxxiv. The last three were written after A.D. 70, and probably before 90. Thus B¹ = lxxxv. was written by a Jew in exile, who, despairing of a national restoration, looked only for a spiritual recompense in heaven. The rest of the book is derived from B¹ and B², written in Palestine after A.D. 70. These writings belong to very different types of thought. In B¹ the earthly Jerusalem is to be rebuilt, but not so in B²; in the former the exiles are to be restored, but not in the latter; in the former a Messianic kingdom without a Messiah is expected, but not earthly blessedness of any kind in the latter, &c. B¹ = i.-ix. 1, xxiii. 2-4, xliii.-xliv. 7, xlv.-xlvii., lxxvii.-lxxxii., lxxxiv., lxxxvi.-lxxxvii. B² = ix.-xxv., xxx. 2-xxxv., xli.-xliii., xlv. 8-15, xlviii.-lii., lxxv.-lxxvi., lxxxiii. The final editor of the work wrote in the name of Baruch the son of Neriah.

The above critical analyses were attacked and rejected by Clemen (*Stud. und Krit.*, 1898, 211 sqq.). He fails, however, in many cases to recognize the difficulties at issue, and those which cannot be ignored he sets down to the conflicting apocalyptic traditions, on which the author was obliged to draw for his subject-matter. Though Ryssel (Kautzsch, *Apok. u. Pseud. des A. T.* ii. 409) has followed Clemen, neither has given any real explanation of the disorder of the book as it stands at present. Beer (*op. cit.*) agrees that xxxvi.-xl. and liii.-lxx. are of different authorship from the rest of the book and belong to the earlier date.

Relation to 4 Ezra.—The affinities of this book and 4 Ezra are so numerous (see Charles, *op. cit.* 170-171) that Ewald and Ryle assumed identity of authorship. But their points of divergence are so weighty (see *op. cit.* pp. lix.-lxxi.) that this view cannot be sustained. Three courses still remain open. If we assume that both works are composite, we shall perhaps admit that some of the constituents of 4 Ezra are older than the latest of Baruch, and that other constituents of Baruch are decidedly older than the remaining ones of 4 Ezra. On the other hand, if we assume unity of authorship, it seems impossible to arrive at finality on the chronological relations of these two works. Langen, Hilgenfeld, Wieselner, Stähelin, Renan, Hausrath, Drummond, Dillmann, Roescher, Gunkel, have maintained on various grounds the priority of 4 Ezra; and Schürer, Bissell, Thomson, Deane, Kabisch, De Faye, Wellhausen, and Ryssel the priority of Baruch on grounds no less convincing.

Relation to Rabbinical Literature.—A very close relation subsists between our book and rabbinical literature. Indeed in some instances the parallels are so close that they are almost word for word. The description of the destruction of Jerusalem by angels in vi.-viii. is found also in the Pesikta Rabbati 26 (ed. Friedmann 131a). By means of this passage we are, as Ginzberg has shown, able to correct the corrupt reading "the holy Ephod" (vi. 7). מן הַקֹּדֶשׁ אֵשׁ אֵשׁ "the holy Ark" i.e. אֵשׁ הַקֹּדֶשׁ. What might be taken as poetic fancies in our text are recounted as historical facts in rabbinical literature. Thus the words (x. 18):

"And ye priests, take ye the keys of the sanctuary,
And cast them into the height of heaven,
And give them to the Lord and say:
"Guard Thine own house; for lo we are found unfaithful stewards,"

are given in various accounts of the fall of Jerusalem. (See Ta'amith, 20a; Pesik. R., *loc. cit.*; *Yalqut Shim'on* on Is. xxi.) *Aboth* of Rabbi Nathan vii.). Even the statement that the bodies of Sennacherib's soldiers were burned while their garments and armour remained unconsumed has its parallel in *Sanh.* 94a.

Integrity of the Book.—In lxxvii. 19 it is said that Baruch wrote two epistles, one to the nine and a half tribes and the other to the two and a half at Babylon. The former is found in lxxviii.-lxxxvi.; the latter is lost, but is probably preserved either wholly or in part in the Book of Baruch, iii. 9-iv. 26 (see Charles, *op. cit.*); pp. lxxv.-lxxvii.). On the other hand, it is not necessary to infer from lxxv. that an account of Baruch's assumption was to be looked for in the book.

AUTHORITIES.—The literature is fully cited in Schürer, *Gesch.* iii. 223-232, and R. H. Charles, *Apocalypse of Baruch*, pp. xxx.-xliii. Ginzberg's article in the *Jewish Encyclopaedia*, ii. 551-556, is a fresh and valuable contribution.

REST OF THE WORDS OF BARUCH. This book was undoubtedly written originally by a Jew but was subsequently revised by a Christian, as has been shown by Kohler in the *Jewish Quarterly Review* (1893), pp. 407-409. It passed under a double name in the Abyssinian Church, where it was known both as "the Rest of the Words of Baruch" and "the Rest of the Words of Jeremiah." Its Greek name is the latter—τὰ παραλειπούμενα Ἱερεμίου προφήτου. It has been preserved in Greek, Ethiopic, Armenian and Slavonic. The Greek was first printed at Venice in 1609, next by Ceriani in 1868 in his *Mon. Sacra*, v. 11-18; by Harris, *The Rest of the Words of Baruch*, in 1889; and Blassivie, *Anec. Graeco-Byzantina*, i. 308 sqq. (1893). The book begins like the Syriac Apocalypse of Baruch with an account of the removal of the sacred vessels of the Temple before its capture by the Chaldees. Baruch remains in Jerusalem and Jeremiah accompanies the Exiles to Babylon. After 66 years' exile Jeremiah brings back the Jews to Jerusalem, but refuses to admit such as had brought with them heathen wives. Then follows a vision of Jeremiah which is Christian.

Harris regards the book in its present form as an eirenicon addressed to the Jews by a Christian after the rebellion of Bar Cochba (Barcochebas) and written about 136. Though the original work was dependent on the Apocalypse of Baruch it cannot have been written much before the close of the 1st cent. A.D. Its *terminus ad quem* is at present indeterminate.

(R. H. C.)

BARUGO, a town on the north coast of the province of Leyte, island of Leyte, Philippine Islands, on Carigara Bay. Pop. (1903) 12,360. It exports large quantities of hemp and copra, and imports rice, petroleum, and cotton-goods.

BARWANI, a native state of India, in the Bhopal agency in central India. It lies in the Satpura mountains, south of the Nerbudda. Area, 1178 sq. m.; pop. (1901) 76,136. Many of the inhabitants are Bhils. The chief, whose title is Rana, is a Rajput of the Sisodhya clan, connected with the Udaipur family. Though the family lost most of its possessions during the Mahratta invasion in the 14th century, it never became tributary to any Malwa chief. The forests are under an English official. The town of Barwani is situated near the left bank of the Nerbudda. The population in 1901 was 6277.

BARYATINSKY, ALEXANDER IVANOVICH, PRINCE (1814-1879), Russian soldier and governor of the Caucasus, was privately educated, entered the school of the ensigns of the Guard in his seventeenth year and, on the 8th of November 1833, received his commission of cornet in the Life Guards of the cesarevich Alexander. In 1835 he served with great gallantry in the Caucasus, and on his return to St Petersburg was rewarded with a gold sword "for valour." On the first of January 1836 he was attached to the suite of Alexander, and in 1845 was again ordered off to the Caucasus and again most brilliantly distinguished himself, especially in the attack on Shamy's stronghold, for which he received the order of St George. In 1846 he assisted

Fieldmarshal Paskievich to suppress the Cracow rising. From 1848 to 1856 he took a leading part in all the chief military events in the Caucasus, his most notable exploits being his victory at Mezeninsk in 1850 and his operations against Shamyk at Chechen. His energetic and at the same time systematic tactics inaugurated a new era of mountain warfare. On the 6th of January 1853 he was appointed adjutant-general and, on July 5th of the same year, chief of the staff. In 1854 he took part in the brilliant Kırık Dere campaign. On the 1st of January 1856 he became commander-in-chief of the Caucasian army, and, subsequently, governor of the Caucasus. As an administrator he showed himself fully worthy of his high reputation. Within three years of his appointment, the whole of the eastern Caucasus was subdued and the long elusive Shamyk was taken captive. Baryatinsky also conquered many of the tribes of the western Caucasus dwelling between the rivers Laba and Byelaya. For these fresh services he was created a fieldmarshal. But his health was now entirely broken by his strenuous labours, and on the 6th of December 1862 he was, at his own request, relieved of his post. He spent the last days of his life abroad and died at Geneva, after forty-eight years of active service.

See A. L. Zisserman, *Fieldmarshal Prince A. I. Baryatinsky* (Russ.) (Moscow, 1888-1891).

BARYE, ANTOINE LOUIS (1796-1875), French sculptor, was born in Paris on the 24th of September 1796. Like many of the sculptors of the Renaissance he began life as a goldsmith. After studying under Bosio, the sculptor, and Gros, the painter, he was in 1818 admitted to the *École des Beaux Arts*. But it was not till 1823, when he was working for Fauconnier, the goldsmith, that he discovered his real bent from watching the wild beasts in the *Jardin des Plantes*, making vigorous studies of them in pencil drawings worthy of Delacroix and then modelling them in sculpture on a large or small scale. In 1831 he exhibited his "Tiger devouring a Crocodile," and in 1832 had mastered a style of his own in the "Lion and Snake." Thenceforward Barye, though engaged in a perpetual struggle with want, exhibited year after year these studies of animals—admirable groups which reveal him as inspired by a spirit of true romance and a feeling for the beauty of the antique, as in "Theseus and the Minotaur" (1847), "Lapitha and Centaur" (1848), and numerous minor works now very highly valued. Barye was no less successful in sculpture on a small scale, and excelled in representing animals in their most familiar attitudes. As examples of his larger work we may mention the *Lion of the Column of July*, of which the plaster model was cast in 1830, various lions and tigers in the gardens of the *Tuileries*, and the four groups—*War, Peace, Strength, and Order* (1854). In 1852 he cast his bronze "Jaguar devouring a Hare." The fame he deserved came too late to the sculptor. He was made professor at the museum in 1854, and was elected to the *Academy of Fine Arts* in 1868. He died on the 25th of June 1875. The mass of admirable work left to us by Barye entitles him to be regarded as the greatest artist of animal life of the French school, and as the creator of a new class of art which has attracted such men as Frémiet, Peter, Cain, and Gardet, who are regarded with justice as his worthiest followers.

AUTHORITIES.—Emile Lamé, *Les Sculpteurs d'animaux; M. Barye* (Paris, 1856); Gustave Planche, "M. Barye," *Revue des deux mondes* (July 1851); Théophile Silvestre, *Histoires des artistes vivants* (Paris, 1856); Arsène Alexandre, "A. L. Barye," *Les Artistes célèbres*, ed. E. Muntz (Paris, 1889) (with a bibliog.); Charles DeKay, *Life and Works of A. L. Barye* (1889), published by the Barye Monument Assoc. of New York; Jules Claretie, *Peintres et sculpteurs contemporains* (1882); Roger Ballu, *L'Œuvre de Barye* (1890); Charles Sprague Smith, *Barbizon Days* (1903). (H. Fr.)

BARYTES, a widely distributed mineral composed of barium sulphate (BaSO_4). Its most striking feature and the one from which it derives its name baryte, barite (from the Greek βαρύς, heavy) or heavy spar, is its weight. Its specific gravity of 4.5 is about twice as great as that of salt and of many other colourless, transparent and glassy minerals not unlike barytes in general appearance. The mineral is usually found in a state of considerable chemical purity, though small amounts of strontium and calcium sulphates may isomorphously replace the barium sulphate: ammonium sulphate is also sometimes present, whilst

clay, silica, bituminous matter, &c., may be enclosed as impurities.

Crystals of barytes are orthorhombic and isomorphous with the strontium and lead sulphates (celestite and anglesite); they are usually very perfectly developed and present great variety of form. The simplest are rhomb-shaped tables (fig. 1) bounded by the two faces of the basal pinacoid (c) and the four faces of the prism (m); the angle between the prism-faces (mm) is $78^\circ 23'$, whilst that between c and m is 90° . The mineral has a very perfect cleavage parallel to the faces c and m , and the cleavage surfaces are perfectly smooth and bright. The crystals of prismatic habit represented in figs. 2 and 3 are bounded by the domes d and f and the basal pinacoid c ; fig. 4 is a plan of a still

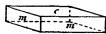

FIG. 1.

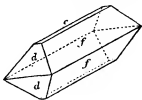

FIG. 2.



FIG. 3.

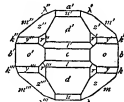

FIG. 4.

more complex crystal. Twinning is represented only by twinning lamellae, which are parallel to the planes m and f and are of secondary origin, having been produced by pressure.

Crystals of barytes may be transparent and colourless, or white and opaque, or of a yellow, brown, bluish or greenish colour. Well developed crystals are extremely common, but the mineral occurs also in a granular, earthy, or stalactitic condition. It is known as cawk in the Derbyshire lead mines. The "crested" or "cock's comb" barytes occurs as rounded aggregations of thin lamellar crystals.

Barytes is of common occurrence in metalliferous veins, especially those which yield ores of lead and silver; some of the largest and most perfect crystals of colourless barytes were obtained from the lead mines near Dufton in Westmorland. It is found also in beds of iron ore, and the hematite mines of the Cleator Moor district in west Cumberland have yielded many extremely fine crystals, specimens of which may be seen in all mineral collections. In the neighbourhood of Nottingham, and other places in the Midlands, barytes forms a cementing material in the Triassic sandstones; amber-coloured crystals of the same mineral are found in the fuller's earth at Nutfield in Surrey; and the septarian nodules in London Clay contain crystals of barytes as well as of calcite. Crystals are found as a rarity in the amygdaloidal cavities of igneous rocks.

Artificially prepared crystals of barytes may be obtained by allowing a solution of a soluble barium salt to diffuse slowly into a solution of a soluble sulphate. Barium chloride is present in some natural waters, and when this is the case the interaction of sulphates results in a deposition of barytes, as has occurred in the pipes and water-boxes of the Newcastle-on-Tyne coal mines.

Commercially, barytes is used in the preparation of barium compounds, as a body for certain kinds of paper and cloth, and as a white pigment ("permanent white"). The finely powdered and washed mineral is too crystalline and consequently of insufficient opacity to be used alone as a paint, and is therefore mixed with "white lead," of which material it is also used as an adulterant.

BARYTOCALCITE, a rare mineral found only at Alston Moor in Cumberland, where it occurs as diverging groups of white transparent crystals lining cavities in the Mountain Limestone.

The crystals belong to the monoclinic system and are usually prismatic or blade-shaped in habit. The hardness is 4, and the sp. gr. 3.65. There are perfect cleavages parallel to the prism faces inclined at an angle of $73^{\circ} 6'$, and a less perfect cleavage

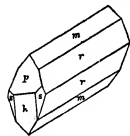

parallel to the basal plane, the angle between which and the prism faces is $77^{\circ} 6'$; the angles between these three cleavages thus approximate to the angles ($74^{\circ} 55'$) between the three cleavages of calcite, and there are other points of superficial resemblance between these two minerals. Chemically, barytocalcite is a double salt of barium and calcium carbonates, $\text{BaCa}(\text{CO}_3)_2$, thus differing

from the orthorhombic bromilite (*q.v.*) which is an isomorphous mixture of the two carbonates.

(L. J. S.)

BARYTONE, or **BARTONE** (Ital. *baritono*, from Gr. *βαρύπρονος*, deep sounding), a musical term for the male voice whose range lies between those of the tenor and of the bass—a high bass rather than a low tenor; also the name of an obsolete stringed instrument like the viola da Gamba, and of the small Bb or C saxhorn.

BASALT, in petrology, one of the oldest rock names, supposed to be derived from an Ethiopian word *basal*, signifying a stone which yields iron; according to Pliny, the first basalts were obtained in Ethiopia. In current usage the term includes a large variety of types of igneous rock belonging to the basic subdivision, dark in colour weathering to brown, and comparatively rich in magnesia and iron. Some basalts are in large measure glassy (tachylites), and many are very fine grained and compact; but it is more usual for them to exhibit porphyritic structure, showing larger crystals of olivine, augite or felspar in a finely crystalline groundmass. Olivine and augite are the commonest porphyritic minerals in basalts, the former green or yellowish (and weathering to green or brown serpentine), the latter pitch-black. Porphyritic plagioclase felspars, however, are also very common, and may be one or two inches in length, though usually not exceeding a quarter of an inch; when fresh they are dark grey with smooth lustrous cleavage surfaces; when decomposed they become turbid, and assume grey or greenish shades. Basaltic lavas are frequently spongy or pumiceous, especially near their surfaces; and, in course of time, the steam cavities become filled with secondary minerals such as calcite, chlorite and zeolites. Another characteristic of this group of rocks is the perfection with which many of them show prismatic or columnar jointing, a structure often called "basaltic jointing."

The minerals of basaltic rocks have a fairly uniform character throughout the whole group. In microscopic section the olivine is pale green or colourless, and is very frequently more or less altered to serpentine. The secondary mineral begins to form upon the surfaces and along the cracks of the olivine, gradually producing a mesh-work in the interstices of which small kernels of olivine remain; and when the process is completed the mesh structure persists in the resulting pseudomorph, giving a clear indication as to its history. The augite is mostly brown, often with a purplish tinge, hardly at all dichroic, but frequently showing zonal or hour-glass structure, and various types of twinning. It weathers to chlorite, uranite, calcite, &c. The plagioclase felspar, if fresh, is transparent and appears simple in ordinary light, but when polarized breaks up into a series of bars of different colours owing to its complex twinned structure. Practically all varieties of this mineral from anorthite to albite are known to occur in basalt, but by far the commonest species are bytownite and labradorite. Weathering destroys the limpid character of the fresh mineral, producing turbid pseudomorphs containing epidote, calcite, white micas, kaolin, &c. When these minerals occur as inclusions their crystalline outlines may be very perfect (though, especially in the olivine, corrosion and partial resorption may give rise to rounded or irregular forms).

In the groundmass, or second generation of crystal, not only are the ingredients smaller, but their crystals are less perfect; yet in many basalts small lath-shaped felspars and minute prisms of

augite, densely crowded together, form the matrix. With these there may be a greater or less amount of brown, isotropic glass. Olivine rarely occurs as an ingredient of the groundmass. In the vitreous basalts sometimes very few crystallized minerals are observable; the greater part of the rock is a dark brown glassy material, almost opaque even in the thinnest sections, and generally charged with black grains of magnetite, skeleton crystals of augite or felspar, spherulites, perlitic cracks, or steam vesicles. In other basaltic rocks no glassy material appears, but the whole mass is thoroughly crystallized; rocks of this nature are generally known to British petrologists as dolerites (*q.v.*). Till recent years it was widely believed by continental geologists that the pre-Tertiary basalts differed so fundamentally from their Tertiary and recent representatives that they were entitled to be regarded as a distinct class. For the older rocks the names *ameisite*, *diabase porphyry*, *diabas-mandelstein*, or *melyphre* were used, and are still favoured by many writers, to indicate varieties and states of more or less altered basalts and dolerites, though no longer held to differ in any essential respects from the better preserved basalts. Still older is the term *trap*, which is derived from a Swedish word meaning "a stair," for in many places superposed sheets of basalt weather with well-marked step-like or terraced features. This designation is still used as a general term for the whole suite of basaltic rocks by many geologists and travellers (e.g. trap-dikes, the "traps" of the Deccan).

In the early years of the 19th century a great controversy convulsed the geological world as to the origin of the older basalts or "float-traps." Werner, the Saxon mineralogist, and his school held them to be of aqueous origin, the chemical precipitates deposited in primeval seas, but Hutton and a number of French geologists maintained that they were really volcanic rocks emitted by craters now extinct (see *GEOLOGY: Historical*).

Of the less common minerals of basalt, a few may be mentioned. Black hornblende, dark brown in thin sections, and often corroded, is not uncommon, especially in intrusive basalts. Hypersthene occurs also, usually replacing olivine. Black mica (biotite) is not infrequently to be seen. Sapphire, garnet and zircon are rare. Minerals of the feldspathoid group occur in a large number of basaltic rocks; nepheline and leucite are the most common, but haityne is occasionally present. If nepheline entirely replaces felspar, the rock is known as nepheline-basalt; if the replacement is only partial the term nepheline-basaltine is used. Similarly there are leucite-basalts and leucite-basaltines. The nepheline is in small six-sided prisms, and usually cannot be detected with the unaided eye. Even with the help of the microscope nepheline basalts are not always easy to determine, as the crystals may be exceedingly small and imperfect, and they readily decompose into analcite and zeolites. In some cases only the presence of an anisotropic substance, with weak double refraction and readily attacked by acids (the so-called "nephelinoid"), can be made out. This substance may be imperfectly crystallized nepheline, or a peculiar glass which is rich in soda. Most nepheline basalts are fine grained, very dark coloured rocks, and belong to the Tertiary period. They are fairly common in some parts of Germany and occur also in Tripoli, Asia Minor, Montana, Cape Verde Islands, &c. Leucite-basalts contain small rounded crystals of leucite in place of plagioclase felspar. Rocks of this group are well known in the Eifel, and other volcanic districts in Germany, also in Bohemia, Italy, Java, Montana, Cebes, &c. The minerals haityne, nosean, sodalite and melilite tend to occur with some frequency in nepheline and leucite-basalts, though rare in ordinary basalts. Melilite, a lime-alumina-silicate, is characteristic of certain very basic rocks, the melilitic-basalts. It is pale yellow or colourless in thin sections, and yields peculiar and characteristic dark blue polarization colours. This rare group of rocks is known to occur in Bohemia, Swabia and South Africa. Perovskite, in small dark brown cubic crystals, is a constant accessory in these rocks. The augite is usually violet coloured, and shows zonal and hour-glass structures. Green augite may occur in the nepheline-basalts, and aegerine (soda-iron-augite) is occasionally found in them.

The distribution of basalts is world-wide; and in some places

they occur in immense masses, and cover great areas. In Washington, Oregon, and Idaho many thousands of square miles are occupied by basaltic-lava flows. In the Sandwich Islands and Iceland they are the prevalent lavas; and the well-known columnar jointed basalts of Skye, Staffa, and Antrim (Giant's Causeway) form a southward extension of the Icelandic volcanic province, with which they are connected by the similar rocks of the Faeroe Islands. In the Deccan in India great basaltic lava fields are known; and Etna and Vesuvius emit basaltic rocks. In older geological periods they were not less common; for example, in the Carboniferous in Scotland. (J. S. F.)

BASCOM, JOHN (1827—), American educationalist and philosophical writer, was born at Genoa, New York, on the 1st of May 1827. He graduated at Williams College in 1849 and at the Andover Theological Seminary in 1855, was professor of rhetoric at Williams College from 1855 to 1874, and was president of the University of Wisconsin and professor of mental and moral philosophy there from 1874 to 1887. In 1887–1891 and in 1901–1903 he was lecturer in sociology, and in 1891–1901 professor of economics in Williams College. He retired in 1903. Among his publications may be mentioned: *Aesthetics* (1862); *Philosophy of Rhetoric* (1865); *Science, Philosophy and Religion* (1871); *Philosophy of English Literature* (1874); *Philosophy of Religions* (1876); *Problems in Philosophy* (1885); *The New Theology* (1891); *Social Theory* (1895); *Evolution and Religion* (1896); *Growth of Nationality in the United States* (1899); and *God and His Goodness* (1901).

BASE. (1) (Fr. *bas*, Late Lat. *basillus*, low; cf. Gr. *βάσις*) an adjective meaning low or deep, and so mean, worthless, or wicked. This sense of the word has sometimes affected the next, which is really distinct. (2) (Gr. *βάσις*, strictly "stepping," and so a foundation or pedestal) a term for a foundation or starting point, used in various senses; in sports, e.g. hockey and baseball; in geometry, the line or face on which a figure or solid stands; in crystallography, e.g. "basal plane"; in surveying, in the "base line," an accurately measured distance between the points from which the survey is conducted; in heraldry, in the phrase "in base," applied to any figure or emblem placed in the lowest part of a shield.

In chemistry the term denotes a substance which combines with an acid to form a salt. In inorganic chemistry such compounds are almost invariably oxides or hydroxides, and water is eliminated during the combination; but in organic chemistry many compounds exist, especially ammonia derivatives, which directly combine with acids. Chemical bases are consequently antithetical to acids; and an acid is neutralized by a base with the production of a salt. They reverse certain colour reactions of acids, e.g. turn red litmus blue; this is termed an "alkaline reaction."

In architecture the "base" is the lowest member of a column or shaft. In Egyptian and Greek architecture it is the raised slab in stone or cement on which the primitive timber column was placed, to keep it dry. Afterwards it was always reproduced in Egypt, even although the column, being in stone, no longer required it; a custom probably retained because, being of a much larger circumference than the lower part of the column, it gave increased stability. In Assyrian architecture, where it served to carry wooden posts or columns, it took the form of a large torus moulding with enrichments. In Persian architecture the base was much higher than in any other style, and was elaborately carved. In primitive Greek work the base consisted of the stone plinth as found in Crete and Tiryns, and of three small steps at Mycenae. In archaic Greek work it has already disappeared in the Doric order, but in the Ionic and Corinthian orders it is more or less richly moulded, the most elaborate examples being those found in the temple of Apollo at Branchidae in Milesia. For the contour of the mouldings see **ORDERS.** The Roman orders all have the favourite design known as the Attic base. Romanesque bases were rude but vigorous copies of the old classic base, and were often decorated with projections or spurs (Fr. *griffes*) at the angles of the square dies, thus connecting them with the square base. In the Early English

style, these spurs followed the conventional design of the period, and about the same time the mouldings were deeply sunk and occasionally cut downwards, so that they would have held water if used externally. Later, the base becomes less bold in treatment, but much more complex in its contours, and in the 15th century is given an unusual height with two stages, the lower one constituting a kind of plinth, which is sometimes known as the ground table, or the base course.

A **BASE COURT** (Fr. *basse cour*, i.e. the lower court), is the first open space within the gates of a castle. It was used for exercising cavalry, and keeping live stock during a siege. (See **ENCEINTE**).

THE **BASE OF A WALL OF GROUND TABLE**, in architecture, is the mouldings round a building just above ground; they mostly consist of similar members to those above described and run round the buttresses. The flat band between the plinth and upper mouldings is frequently panelled and carved with shields, as in Henry VII. Chapel at Westminster.

BASE-BALL (so-called from the bases and ball used), the national summer sport of the United States, popular also throughout Canada and in Japan. Its origin is obscure. According to some authorities it is derived from the old English game of rounders (q.v.), several variations of which were played in America during the colonial period; according to other authorities, its resemblance to rounders is merely a coincidence, and it had its origin in the United States, probably at Cooperstown, New York, in 1839, when, it is said, Abner Doubleday (later a general in the U.S. army) devised a scheme for playing it. About the beginning of the 19th century a game generally known as "One Old Cat" became popular with schoolboys in the North Atlantic states; this game was played by three boys, each fielding and batting in turn, a run being scored by the batsman running to a single base and back without being put out. Two Old Cat, Three Old Cat, and Four Old Cat were modifications of this game, having respectively four, six, and eight players. A development of this game bore the name of town-ball, and the Olympic Town-Ball Club of Philadelphia was organized in 1833. Matches between organized base-ball clubs were first played in the neighbourhood of New York, where the Washington Baseball Club was founded in 1843. The first regular code of rules was drawn up in 1845 by the Knickerbocker Baseball Club and used in its matches with the Gotham, Eagle and Empire clubs of New York, and the Excelsior, Putnam, Atlantic and Eckford clubs of Brooklyn. In 1858 the first National Association was organized, and, while its few simple laws were generally similar to the corresponding rules of the present code, the ball was larger and "livelier," and the pitcher was compelled to deliver it with a full toss, no approach to a throw being allowed. The popularity of the game spread rapidly, resulting in the organization of many famous clubs, such as the Beacon and Lowell of Boston, the Red Stockings of Cincinnati, the Forest City of Cleveland and the Maple Leaf of Guelph, but, owing to the sharp rivalry between the foremost teams, semi-professionalism soon crept in, although in those days a man who played for a financial consideration always had some other means of livelihood, as the income to be derived from playing ball in the summer time was not enough to support him throughout the year. In spite of its popularity, the game acquired certain undesirable adjuncts. The betting and pool selling evils became prominent, and before long the game was in thorough disrepute. It was not only generally believed that the matches were not played on their merits, but it was known that players themselves were not above selling contests. At that time many of the journals of the day foretold the speedy downfall of the sport. A convention of those interested financially and otherwise in the game, was held in 1867 in Philadelphia, and an effort was made to effect a reformation. That the sport even then was by no means insignificant can be seen from the fact that in that convention some 500 organizations were represented. While the work done at the convention did not accomplish all that was expected, it did produce certain reforms, and the sport grew rapidly thereafter both in the eastern and in the middle western part of the United States. In the next five years the

interest in the game became so great that it was decided to send a representation of American base-ball players to England; and two clubs, the Bostons, who were the champions that year, and the Athletics, former champions, crossed the Atlantic and played several exhibition games with each other. While successful in exciting some interest, the trip did not succeed in popularizing base-ball in Great Britain. Fifteen years later two other nines of representative American base-ball players made a general tour of Australia and various other countries, completing their trip by a contest in England. This too, however, had little effect, and later attempts to establish base-ball in England have likewise been unsuccessful. But in America the game continued to prosper. The first entirely professional club was the Cincinnati Red Stockings (1868). Two national associations were formed in 1871, one having jurisdiction over professional clubs and the other over amateurs. In 1876 was formed the National League, of eight clubs under the presidency of Nicholas E. Young, which contained the expert ball-players of the country. There were so many people in the United States who wanted to see professional base-ball that this organization proved too small to furnish the desired number of games, and hence in 1882 the American Association was formed. For a time it seemed that there would be room for both organizations; but there was considerable rivalry, and it was not until an agreement was made between the two organizations that they were able to work together in harmony. They practically controlled professional base-ball for many years, although there were occasional attempts to overthrow their authority, the most notable being the formation in 1890 of a brotherhood of players called the Players' League, organized for the purpose of securing some of the financial benefits accruing to the managers, as well as for the purpose of abolishing black-listing and other supposed abuses. The Players' League proved not sufficiently strong for the task, and fell to pieces. For some years the National League consisted of twelve clubs organized as stock companies, representing cities as far apart as Boston and St. Louis, but in 1900 the number was reduced to eight, namely, Boston, Brooklyn, Chicago, Cincinnati, New York, Pittsburg, Philadelphia and St. Louis. Certain aggressive and dissatisfied elements took advantage of this change to organize a second great professional association under the presidency of B. B. Johnson, the "American League," of eight clubs, six of them in cities where the National League was already represented. Most of the clubs of both leagues flourish financially, as also do the many minor associations which control the clubs of the different sections of the country, among which are the Eastern League, the American Association, Western League, Southern Association, New England League, Pacific League and the different state leagues. Professional base-ball has not been free from certain objectionable elements, of which the unnecessary and rowdyish fault-finding with the umpires has been the most evident, but the authorities of the different leagues have lately succeeded, by strenuous legislation, in abating these. Of authorities on base-ball, Henry Chadwick (d. 1908) is the best known.

Amateur base-ball, in its organized phase, is played mostly by school and university clubs as well as those of athletic associations. The first college league was formed in 1879 and comprised Harvard, Princeton, Amherst, Brown and Dartmouth, Yale joining a year later. The Eastern College League, with Columbia, Harvard, Princeton and Yale, followed in 1887. This was afterwards dissolved and at present the most important universities of the eastern states are members of no league, although such organizations exist in New England and different parts of the west and south. Amateur base-ball has progressed along the same lines as professional, although the college playing rules formerly differed in certain minor points from those of the professional leagues.

The following is a general description of the field and of the manner in which the game is played, but as the game has become highly complicated, situations may arise in playing in which general statements do not strictly hold. Any smooth, level field about 150 yds. long and 100 yds. broad will serve for a

base-ball ground. Upon this field is marked out with white chalk a square, commonly called the diamond, smooth, like a cricket pitch, the sides of which measure 30 yds. each, and the nearest corner of which is distant about 30 yds. from the limit of the field. This corner is marked with a white plate, called the home-base or plate, five-sided in shape, two of the sides being 1 ft. long and that towards the pitcher 17 in. At the other three corners and attached to pegs are white canvas bags 15 in. square filled with some soft material, and called, beginning at the right as one looks towards the field, first-base, second-base and third-base respectively. The lines from home-base to first, and from home to third are indefinitely prolonged and called foul-lines. The game is played by two sides of nine men each, one of these taking its turn at the bat while the other is in the field endeavouring, as provided by certain rules, to put out the side at bat. Each side has nine turns, or innings, at bat, unless the side last at bat does not need its ninth innings in order to win; a tie at the end of the ninth innings makes additional innings necessary. A full game usually takes from 1½ to 2 hrs. to play. Three batsmen are put out in each innings, and the side scoring the greatest number of runs (complete encircling of the bases without being put out) wins. A runner who is not put out but fails to reach home-base does not score a run, but is "left on base."

Implements of the Game.—The ball, which is 9-9½ in. in circumference and weighs 5-5½ oz., is made of yarn wound upon a small core of vulcanized rubber and covered with white leather, which may not be intentionally discoloured. The bat must be round, not over 2½ in. in diameter at the thickest part, nor more than 42 in. in length. It is usually made of ash or some other hard wood, and the handle may be wound with twine. Three-cornered spikes are usually worn on the players' shoes. The catcher and first-baseman (*v. infra*) may wear a glove of any size on one hand; the gloves worn by all other players may not measure more than 14 in. round the palm nor weigh more than 10 oz.

The Players.—The fielding side consists of (a) the pitcher and catcher, called the battery, (b) the first-baseman, second-baseman, third-baseman and short-stop, called infielders, and (c) the left-fielder, centre-fielder and right-fielder, called outfielders.

The pitcher, who delivers the ball to the batsman, is the most important member of the side. In the act of pitching, which is throwing either over or underhand, he must keep one foot in contact with a white plate, called the pitcher's plate, 24 in. long and 6 in. wide, placed 60-5 ft. from the back of the home-base. Before 1875 the pitcher was obliged to deliver the ball with a full toss only, but about that time a disguised underhand throw, which greatly increased the pace, began to be used so generally that it was soon legalized, and the overhand throw followed as a matter of course. As long as the arm was held stiff no curve could be imparted to the flight of the ball in the air, but with the increase of pace came the possibility of doing this by a movement of the wrist as the ball left the hand, the twist thus given causing the ball, by the pressure on the air, to swerve to one side or the other, or downwards, according to the position of the hand and fingers as the ball is let go. The commonest of these swerving deliveries, and the first one invented, is the out-curve, the ball coming straight towards the batsman until almost within reach of his bat, when it suddenly swerves away from him towards the right, if he be right-handed. The other important curves are the in-curve, shooting sharply to the left, and the drop, with their many variations, nearly every pitcher using some favourite curve. Change of pace, disguised as well as possible, is also an important part of pitching strategy, as well as variation of the delivery and the play upon the known weaknesses or idiosyncrasies of the batsman. Good control over the ball is a necessity, as four "balls" called by the umpire,—that is, balls not over the base, or over the base and not between the shoulder and knee of the batsman,—entitle the batsman to become a base-runner and take his first base. If the pitcher disregards the restrictions placed upon him by the rules (e.g. he may not, while in position, make a motion to deliver the ball to the batsman without actually

delivering it, or to first-base, while that base is occupied by a runner, without completing the throw), he is said to have made a balk, which permits a base runner to advance a base. In fielding batted balls the pitcher takes all that come directly to him, especially slow ones which the other fielders cannot reach in time. One of his duties is to "back up" the first-baseman in order to stop balls thrown wide, and to cover first-base in place of the baseman whenever that player has to leave his base to field a ground ball. On occasion he also backs up other positions.

The catcher usually stands about 1 yd. behind the home plate, and he must never be more than 10 ft. behind the home plate when the pitcher delivers the ball to the batsman. He generally catches the ball from the pitcher before it strikes the ground, and, when a man of the opposing side has succeeded in getting to a base, must be on the alert to head this opponent off should he endeavour to steal the next base, *i.e.* run to it while the pitcher is delivering the ball to the batsman. For this reason the catcher must be a quick, strong and accurate thrower. As the catcher alone faces the whole field, he is able to warn the pitcher when to throw to a base in order to catch a runner *napping* off the base, and by secretly signalling to the pitcher (usually by means of signs with his fingers) he directs what kind of a ball is to be pitched, so that he may be in the proper position to receive the ball, be it high or low, to left or right. Some pitchers, however, prefer to reserve their choice of balls and therefore do the signalling themselves. The catcher wears a mask, a breast-pad, and a large glove, without which the position would be a very dangerous one.

As every batsman upon hitting the ball must run for the first-base, the first-baseman must be a sure catch of balls thrown to head runners off, even those thrown too low, high or wide. A tall man is usually chosen for this position. The second-baseman usually stands about 30 ft. to the right of second-base and back of the line between the bases, and attends to balls batted to his side of the diamond. He also backs up any exposed position and must be ready to cover second-base whenever a runner tries to steal down from first-base, or whenever there is a runner on second-base, a duty which he shares with the short-stop, whose position corresponds to that of the second-baseman on the left side of the diamond. Short-stop must be a quick and accurate thrower and a lively fielder, as he is required to back up second-and third-base. Both he and the second-baseman must field ground balls cleanly and are often called upon to catch fly balls also. The requirements of third-baseman are very similar, but he must be an exceptionally good thrower, as he has the longest distance to throw to the first-base; and as he plays nearer to the batsman than do the second-baseman and the short-stop, the balls batted in his direction are apt to be faster and more difficult to field. One of the third-baseman's chief duties is to be ready to run in towards the batsman to field "bunts," *i.e.* balls blocked by allowing them to rebound from a loosely held bat. These commonly roll slowly in the

direction of third-baseman, who, in order to get them to first-base in time to put the runner out, must run in, pick them up, usually with one hand, so as to be in position to throw without the loss of an instant, and "snap" them to the first-baseman, *i.e.* throw them underhand without taking time to raise his body to an erect position. Many of these bunts can be fielded either by the pitcher or, if they drop dead in front of the home-plate, by the catcher. The positions of the three outfielders can be seen on the diagram. Their duties consist of catching all "flies" batted over the heads of the infielders (*i.e.* high batted balls that have not touched the ground), stopping and returning ground balls that pass the infield, and backing up the baseman. The accompanying diagram indicates the territory roughly allotted to the different fielders. "Backing up" is a very prominent feature in fielding. Even the pitcher, for example, should run behind the first-baseman when the ball is thrown to the latter by another, in order to stop a widely thrown or missed ball,

which, if allowed to pass, would enable the runner to gain one or more additional bases. Bases vacated by their basemen while fielding balls must often, also, be promptly covered by another player. The general rule of defence strategy is similar to that in cricket, namely, to have as many men as possible at the probable point of attack. There is usually an infield and an outfield captain for the special purpose of calling the name of the player who is to take a certain fly ball, to prevent collisions.

The batsman stands three-quarters facing the pitcher within a parallelogram ("box") 6 ft. long and 4 ft. wide, the lines of which he may not overstep, on penalty of being declared out. His object is to get to first-base without being put out. This he may do in several ways. (1) He may make a "safe-hit," *i.e.* one that is "fair" but cannot be caught, or fielded in time to put him out. (2) He is entitled to first-base if the

pitcher pitches four bad balls, at none of which he (the batsman) has struck. (3) He may be unavoidably struck by a pitched ball, in which case he is given his base. (4) He may, except in certain specified cases, after a third strike, if the catcher has failed to catch the third one, earn his base if he can reach it before the catcher can throw the ball to the first-baseman, and the first-baseman, with the ball in his possession, touch first-base. (5) He may reach his base by an error of some fielder, which may be either a muffed fly, a failure to stop and field a ground ball, a muffed thrown ball or a bad throw. Only balls batted within the foul-lines (see diagram) are fair. All others are "fouls," and the batsman cannot run on them. All foul-struck balls are called strikes until two strikes have been called by the umpire, after which fouls are not counted.

Bating, as in cricket, is a science by itself, although comparatively more stress is laid on fielding than in cricket. A good batsman can place the ball in any part of the field he chooses by meeting the ball at different angles. He may make a safe hit either by hitting the ball on the ground directly through the infield out of reach of the fielders, or so hard that it cannot be

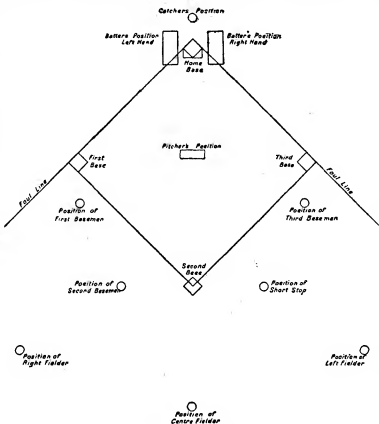

Diagram of Base-ball Field.

stopped. In the last case a failure to stop and field it does not count as an "error" (misplay) for the fielder, even though it came straight at him, the decision as to errors appearing in the score (*v. infra*) depending upon the official scorer of the home club. The batsman may also hit safely by placing the ball over the heads of the infielders, but not far enough to be caught by the outfielders, or over the heads of the outfielders themselves, or he may bunt successfully. A hit by which two bases can be made (without errors by opponents) is a "two-base-hit," one for three bases a "three-base-hit," and one for four bases a "home-run." The batsman may be put out in various ways. For example, he is out (1) if he fails to bat in the order named in the published batting-list; (2) if he fails to take his position within one minute after the umpire has summoned him; (3) if he makes a foul hit which is caught before it strikes the ground (a ball barely ticked by the bat ["foul-tip"] does not count); (4) if he oversteps the batting-lines; (5) if he intentionally obstructs or interferes with the catcher; (6) if he unsuccessfully attempts the third strike and the ball hits his person or is caught by the catcher (under certain conditions he is out whether the ball is so caught or not), or, not being caught, is thrown to first-base and held there by an opposing player before the batsman can get there; (7) if a fair ball be caught before striking the ground; (8) if any fair ball is fielded to first-base before he reaches the base. The batsman becomes a base-runner the moment he starts for first-base. He may, when he first reaches first-base, overrun his base (provided he turns to his right in returning to it) without risk of being put out, but thereafter can be put out by being touched with the ball in the hands of a fielder unless some part of the runner's person is in contact with the base. When a fair or foul ball struck by a batsman on his side is caught on the fly, he must retouch his base, or be put out if the baseman receives the ball before he can do so. A runner on first-base is forced to run to second as soon as a fair ball is batted, or, being on second with another runner on first, he is forced to run to third. This is called being "forced off his base." In such a situation the forced runner can be put out if the ball is thrown to the baseman at the next base before the runner gets there. He does not require to be touched with the ball. The runner on first is entitled, however, to advance to second without risk of being put out if the batsman becomes similarly entitled to first-base (*e.g.* on being unavoidably struck by the ball, or on four balls). Frequently, if the ball is batted to the infield while a runner is on first-base, the fielder tosses it to second-base man, putting out the runner, and the second-base man has still time to throw the ball to first-base ahead of the batsman, thus completing a "double play." Triple plays are sometimes made when there are runners on two or on all of the bases. Base-running is one of the important arts of base-ball play. A good base-runner takes as long a lead off the base as he dares, starts to run the moment the pitcher makes the first movement to deliver the ball, and if necessary throws himself with a slide, either feet or head first, on to the objective base, the reason for the slide being to make it more difficult for the baseman to touch the runner, having to stoop in order to do so, thus losing time. A base-runner is out if he interferes with an opponent while the latter is fielding a ball or if he is hit by a batted ball. An example of modern base-running is offered by the "double steal," carried out, *e.g.*, when there is a runner on first-base and a runner on third-base. The runner on first starts for second leisurely in order to draw a throw to second by the catcher. If the catcher throws, the runner on third runs for the home-plate, the second-base man returning the ball to the catcher in order to put the runner out. The play often results in a score, but the runner is frequently caught if the throws are quick and accurate, or when the catcher deceives the runner by throwing, not to the player at second-base, but to a man stationed for the purpose much nearer the home-plate, this man intercepting the ball and returning it to the catcher if the runner on third is attempting to score, or letting it pass to the player on second-base, if the runner on third does not make the attempt.

Team batting is the co-operation of batsman and base-runner. The commonest example is the "hit and run" play, *e.g.* when a

runner is on first-base. After the runner has ascertained by a false start which infielder, whether second-base man or short-stop, will cover second-base, the batsman signals to the runner that he will hit the next ball. As soon as the pitcher delivers the ball the runner starts for second and the batsman hits the ball to that part of the infield vacated by the fielder who has gone to receive the ball at second from the catcher. If successful this play results in a safe hit, while the runner not infrequently makes, not only second, but third-base as well. Another instance of team batting is when a runner is on third-base and the batsman signals that he will hit the next ball. This enables the runner to get a long start, making his scoring nearly certain if the batsman succeeds in hitting the ball fairly. If the ball is hit without the signal and consequent long start by the runner, the latter is frequently put out at the plate, as the infielder who fields the ball will ignore the batsman and throw the ball to the catcher to head off the runner and prevent a run being scored. In close games the "sacrifice-hit," a part of team batting, is an important element. It consists, when a runner is on base, of a hit by the batsman resulting in his own retirement but the advancement to the next base of the runner. The sacrifice-hit is most frequently a bunt, as this gives the batsman the best chance of reaching first-base safely, besides surely advancing the runner. Another kind of sacrifice-hit is a long fly to the outfield. On such a hit a runner on third-base (as on the other bases) must remain on the base until after the ball is caught, but the distance from the outfield to the home-plate is so great that a fast runner can generally beat the ball and score his run. When men are on bases, coaches are allowed to stand near first and third bases to direct the runners.

One umpire, who has absolute jurisdiction over all points of play, usually officiates in base-ball, but, in important games, two umpires are often employed, one of them standing behind the catcher and calling the good and bad balls pitched, and the other, posted in the infield, giving decisions on plays at the bases.

In cases where the game is tied after nine innings, extra ones are played, the umpire "calling" a game when it becomes too dark to play. In case of rain, play is suspended by the umpire, who calls the game if the rain continues for one half-hour. Should play be permanently interrupted the game counts if five innings have been completed by each side.

Scoring.—The base-ball score shows, in vertical columns, (1) how many times each player has been at bat (bases taken on balls and sacrifice-hits not counted); (2) how many runs he has scored; (3) how many base-hits he has made; (4) how many sacrifice-hits he has made; (5) how many opponents he has put out; (6) how many "assistants," *i.e.* times he has assisted in putting out (*e.g.* stopping a ground ball and throwing it to first-base); (7) the number of errors he has made, wild pitches and "passed balls," *i.e.* not held by the catcher, as well as balks and bases on balls, not being counted as errors but set down under the regular columns, together with the record of stolen bases, extra long hits, double and triple plays, batsmen struck out by each pitcher, the number of men struck by each pitcher with the ball, the time of the game and the name of the umpire.

Careful record is kept of the batting, fielding, pitching and base-running averages of both professional and amateur players. To find the batting record of a player, divide the number of hits made by the number of times at bat. To find a fielding record, divide the number of accepted chances by the total chances, *e.g.* A.B. put 1188 men out, and assisted sixty-four times, while making fifteen errors; his fielding average is therefore 1252 divided by 1267, or 988, 1000 being perfect fielding.

See *Spalding's Base-ball Guide*, in *Spalding's Athletic Library*, published annually; *How to Play Base-ball*, by T. H. Murnane, *Spalding's Athletic Library; The Book of School and College Sports*, by R. H. Barbour (New York, 1904). (E. B.)

BASEDOW, JOHANN BERNHARD (1723-1790), German educational reformer, was born at Hamburg on the 11th of September 1723, the son of a hairdresser. He was educated at the Johanneum in that town, where he came under the influence of the rationalist H. S. Reimarus (1694-1768), author of the

famous *Wolfenbüttler Fragmente*, published by Lessing. In 1744 he went to Leipzig as a student of theology, but gave himself up entirely to the study of philosophy. This at first induced sceptical notions; a more profound examination of the sacred writings, and of all that relates to them, brought him back to the Christian faith, but, in his retirement, he formed his belief after his own ideas, and it was far from orthodox. He returned to Hamburg, and between 1749 and 1753 was private tutor in a nobleman's family in Holstein. Basedow now began to exhibit his really remarkable powers as an educator of the young, and acquired so much distinction that, in 1753, he was chosen professor of moral philosophy and belles-lettres in the academy of Sorø in Denmark. On account of his theological opinions he was in 1761 removed from this post and transferred to Altona, where some of his published works brought him into great disfavour with the orthodox clergy. He was forbidden to give further instruction, but did not lose his salary; and, towards the end of 1767, he abandoned theology to devote himself with the same ardour to education, of which he conceived the project of a general reform in Germany. In 1768 appeared his *Vorstellung an Menschenfreunde für Schulen, nebst dem Plan eines Elementarbuches der menschlichen Erkenntnisse*, which was strongly influenced by Rousseau's *Émile*. He proposed the reform of schools and of the common methods of instruction, and the establishment of an institute for qualifying teachers,—soliciting subscriptions for the printing of his *Elementarwerk*, where his principles were to be explained at length, and illustrated by plates. The subscriptions for this object amounted to 15,000 Talers (£2250), and in 1774 he was able to publish the work in four volumes. It contains a complete system of primary education, intended to develop the intelligence of the pupils and to bring them, so far as possible, into contact with realities, not with mere words. The work was received with great favour, and Basedow obtained means to establish an institute for education at Dessau, and to apply his principles in training disciples, who might spread them over all Germany. The name of *Philanthropin* which he gave to the institution appeared to him the most expressive of his views; and he engaged in the new project with all his accustomed ardour. But he had few scholars, and the success by no means answered his hopes. Nevertheless, so well had his ideas been received that similar institutions sprang up all over the land, and the most prominent writers and thinkers openly advocated the plan. Basedow, unfortunately, was little calculated by nature or habit to succeed in an employment which required the greatest regularity, patience and attention; his temper was intractable, and his management was one long quarrel with his colleagues. He resigned his directorship of the institution in 1778, and it was finally closed in 1793. Basedow died at Magdeburg on the 25th of July 1790.

See H. Rathmann, *Beiträge zur Lebensgeschichte Basedows* (Magdeburg, 1791); J. C. Meyer, *Leben, Charakter und Schriften Basedows* (2 vols., Hamburg, 1791–1792); G. F. B. Hahn, *Basedow und sein Verhältnis zu Rousseau* (Leipzig, 1888); A. Pinloche, *Basedow et le philanthropinisme* (Paris, 1890); C. Gössgen, *Rousseau und Basedow* (1891).

BASE FEE, in law, a freehold estate of inheritance which is limited or qualified by the existence of certain conditions. In modern property law the commonest example of a base fee is an estate created by a tenant in tail, not in possession, who bars the entail without the consent of the protector of the settlement. Though he bars his own issue, he cannot bar any remainder or reversion, and the estate (*i.e.* the *base fee*) thus created is determinable on the failure of his issue in tail. An example of this kind of estate was introduced by George Eliot into the plot of *Felix Holt*. Another example of a base fee is an estate descendible to heirs general, but terminable on an uncertain event; for example, a grant of land to A and his heirs, tenants of the manor of Dale. The estate terminates whenever the prescribed qualification ceases. An early meaning of base fee was an estate held not by free or military service, but by base service, *i.e.* at the will of the lord.

BASEL (Fr. *Bâle*), one of the most northerly of the Swiss cantons, and the only one (save Schaffhausen) that includes any

territory north of the Rhine. It is traversed by the chain of the Jura, and is watered by the Birs and the Ergolz, both tributaries (left) of the Rhine. It is traversed by railways from Basel to Olten (25 m.) and to Laufen (14½ m.), besides local lines from Basel to Flühlen (8 m.) for the frequented pilgrimage resort of Mariastein, and from Liestal to Waldenburg (8½ m.). From 1803 to 1814 the canton was one of the six "Directorial" cantons of the Confederation. Since 1833 it has been divided into two half cantons, with independent constitutions.

One is that of Basel Stadt or Bâle Ville, including, besides the city of Basel, the three rural districts (all to the north of the Rhine) of Riehen, Bettingen and Klein Hünningen (the latter now united to the city). The total area of this half canton is 13.7 sq. m. only, of which 11 sq. m. are classed as "productive," forests occupying 1.5 sq. m., but its total population in 1900 was 112,227 (of whom 3066 inhabited the rural districts), mainly German-speaking, and numbering 73,063 Protestants, 37,101 Romanists (including the Old Catholics), and 1897 Jews. The cantonal constitution dates from 1889. The executive of seven members and the legislature (*Grossrat*) of 130 members, as well as the one member sent to the Federal *Ständerat* and the six sent to the Federal *Nationalrat*, are all elected by a direct popular vote for the term of three years. Since 1875, 1000 citizens can claim a popular vote (*facultative Referendum*) on all bills, or can exercise the right of *initiative* whether as to laws or the revision of the cantonal constitution.

The other half canton is that of Basel Landschaft or Bâle Campagne, which is divided into four administrative districts and comprises seventy-four communes, its capital being Liestal. Its total area is 165 sq. m., of which all but 5 sq. m. is reckoned "productive" (including 559 sq. m. of forests). In 1900 its total population was 68,497, nearly all German-speaking, while there were 52,763 Protestants, 15,564 Romanists, and 130 Jews.

The cantonal constitution dates from 1892. The executive of 5 members and the legislature or *Landrat* (one member per 500 inhabitants or fraction over 400), as well as the single member sent to the Federal *Ständerat* and the three sent to the Federal *Nationalrat*, are all elected by a direct popular vote for three years. The "obligatory Referendum" obtains in the case of all laws, while 1500 citizens have the right of "initiative" whether as to laws or the revision of the cantonal constitution. Silk ribbon weaving, textile industries and the manufacture of tiles are carried on.

(W. A. B. C.)

BASEL (Fr. *Bâle*, but *Bâse* is a wholly erroneous form; Ital. *Basilea*), the capital of the Swiss half canton of Basel Stadt or Bâle Ville. It is now the second most populous (109,161 inhabitants) town (ranking after Zürich) in the Swiss Confederation, while it is reputed to be the richest, the number of resident millionaires (in francs) exceeding that of any other Swiss town. Both facts are largely due to the opening (1882) of the St Gotthard railway, as merchandise collected from every part of north and central Europe is stored in Basel previous to being redistributed by means of that line. Hence the city has an extremely large and flourishing transit trade, despite the rather dingy appearance of its older portions. The city is divided by the Rhine into Gross Basel (south) and Klein Basel (north), the former being by far the larger. There are several bridges over the river, the old wooden bridge having been replaced in 1905 by one built of stone. The central or main railway station is in Gross Basel, while the Baden station is in Klein Basel. The most prominent building in the city is the cathedral or Münster, built of deep red sandstone, on a terrace high above the Rhine. It was consecrated in 1019, but was mainly rebuilt after the disastrous earthquake of 1356 that nearly ruined the city. The public meetings of the great oecumenical council (1431–1449) were held in the choir, while the committees sat in the chapter-house. Erasmus lived in Basel 1521–1529, and on his death there (1536) was buried in the cathedral, attached to which are cloisters, in which various celebrated men are buried, e.g. Oecolampadius (d. 1531), Grynaeus (d. 1541), Buxtorf (d. 1732). The 16th-century Rathaus or town hall has recently been restored. In the museum is a fine collection of works of art by Holbein (who lived in Basel from

1528 to 1531), while the historical museum (in the old Franciscan church) contains many treasures, and among them the fragments of the famous *Dance of Death*, wrongly attributed to Holbein. The university (founded by Pius II. in 1460) is the oldest in Switzerland, and of late years has been extended by the construction of detached buildings for the study of the natural sciences, e.g. the Vesalianum and the Bernoullianum. The university library is very rich, and contains the original MSS. of the acts of the great oecumenical council. There are a number of modern monuments in the city, the most important being that set up to the memory of the Swiss who fell in the battle of St Jakob (1444), won by the French. Basel is the seat of the chief missionary society in Switzerland, the training school for missionaries being at St Chrischona, 6 m. out of the city.

The town was founded in A.D. 374 by the emperor Valentinian, from whose residence there it takes its name. In the 5th century the bishop of Augusta Rauricorum (now called Kaiser Augst), 7½ m. to the east, moved his see thither. Henceforth the history of the city is that of the growing power, spiritual and temporal, of the bishops, whose secular influence was gradually supplanted in the 14th century by the advance of the rival power of the burghers. In 1356 the city was nearly destroyed by a great earthquake. After long swaying between the neighbouring Rhine cities and the Swiss Confederation, it was admitted into the latter in 1501. It later became one of the chief centres of the Reformation movement in Switzerland, so that the bishop retired in 1525 to Porrentruy, where he resided till 1792, finally settling at Soleure in 1828, the bishopric having been wholly reorganized since 1814. As in other Swiss towns the trade guilds got all political power into their hands, especially by the 18th century. They naturally favoured the city at the expense of the rural districts, so that in 1832 the latter proclaimed their independence, and in 1833 were organized into the half canton of Basel Landschaft, the city forming that of Basel Stadt.

See *Basler Biographien* (3 vols., 1900-1905); *Basler Chroniken* (original chronicles), (3 vols., Leipzig, 1872-1890); H. Boos, *Geschichte von Basel*, vol. 1. (to 1501) alone published (1877); A. Reichardt, *Bilder aus d. Geschichte von Basel* (3 vols., 1860-1882); *Zeitschrift z. 4000 Jahre d. Schweiz*, *Bundes anzeiger*, B. und den *Eidgenossen* (1901); T. Geering, *Handel und Industrie d. Stadt Basel* (1885); A. Heusler, *Verfassungsgeschichte d. Stadt Basel im Mittelalter* (1860), and *Rechtsquellen von Basel* (2 vols., 1856-1865); L. A. Stocker, *Basler Stadtbilder* (1890); L. Stouff, *Pouvoir temporel des évêques de Bâle* (2 vols., Paris, 1891); R. Thommen, *Gesch. d. Universität B.*, 1532-1632 (1889); *Urkundenbuch d. Landschaft B.* (pub. from 1881), and ditto for the city (pub. from 1890); W. Vischer, *Gesch. d. Universität B.*, 1460-1520 (1860); R. Wackernagel, *Gesch. d. Stadt Basel* (3 vols., 1906 seq.); K. Weber, *Die Revolution im Kanton Basel, 1830-1833* (1907); G. Gautherot, *La République rauracienne* (1908).

BASEL, CONFESSION OF, one of the many statements of faith produced by the Reformation. It was put out in 1534 and must be distinguished from the First and Second Helvetic Confessions, its author being Oswald Myconius, who based it on a shorter confession promulgated by Oecolampadius, his predecessor in the church at Basel. Though it was an attempt to bring into line with the reforming party both those who still inclined to the old faith and the anabaptist section, its publication provoked a good deal of controversy, especially on its statements concerning the Eucharist, and the people of Strassburg even reproached those of Basel with celebrating a Christless supper. Up to the year 1826 the Confession (sometimes also known as the Confession of Mülhausen from its adoption by that town) was publicly read from the pulpits of Basel on the Wednesday of Passion week in each year. In 1872 a resolution of the great council of the city practically annulled it.

BASEL, COUNCIL OF. A decree of the council of Constance (9th of October 1417) sanctioned by Martin V. had obliged the papacy periodically to summon general councils. At the expiry of the first term fixed by this decree, Martin V. did, in fact, call together at Pavia a council, which it was necessary to transfer almost at once to Siena, owing to an epidemic, and which had to be dissolved owing to circumstances still imperfectly known, just as it was beginning to discuss the subject of reform (1424).

The next council was due to assemble at the expiry of seven years, i.e. in 1431; with his usual punctuality, Martin V. duly convoked it for this date to the town of Basel, and selected to preside over it the cardinal Julian Cesarini, a man of the greatest worth, both intellectually and morally. Martin himself, however, died before the opening of the synod.

From Italy, France and Germany the fathers were slow in appearing at Basel. Cesarini devoted all his energies to the war against the Hussites, until the disaster of Taus forced him hastily to evacuate Bohemia. The progress of heresy, the reported troubles in Germany, the war which had lately broken out between the dukes of Austria and Burgundy, and finally, the small number of fathers who had responded to the summons of Martin V., caused that pontiff's successor, Eugenius IV., to think that the synod of Basel was doomed to certain failure. This opinion, added to the desire which he had of himself presiding over the council, induced him to recall the fathers from Germany, whither his health, impaired of late, probably owing to a cerebral congestion, rendered it all the more difficult for him to go. He commanded the fathers to disperse, and appointed Bologna as their meeting-place in eighteen months' time, his intention being to make the session of the council coincide with some conferences with representatives of the Greek church, which were to be held there with a view to union (18th December 1431).

This order led to an outcry among the fathers of Basel and incurred the deep disapproval of the legate Cesarini. The Hussites, it was said, would think that the Church was afraid to face them; the laity would accuse the clergy of shirking reform; in short, this failure of the councils would produce disastrous effects. In vain did the pope explain his reasons and yield certain points; the fathers would listen to nothing, and, relying on the decrees of the council of Constance, which amid the troubles of the schism had proclaimed the superiority, in certain cases, of the council over the pope, they insisted upon their right of remaining assembled, hastily beat up the laggards, held sessions, promulgated decrees, interfered in the government of the papal courtship of Venaissin, treated with the Hussites, and, as representatives of the universal Church, presumed to impose laws upon the sovereign pontiff himself. Eugenius IV. resolved to resist this supremacy, though he did not dare openly to repudiate a very widespread doctrine considered by many to be the actual foundation of the authority of the popes before the schism. However, he soon realized the impossibility of treating the fathers of Basel as ordinary rebels, and tried a compromise; but as time went on, the fathers became more and more intractable, and between him and them gradually arose an impassable barrier.

Abandoned by a number of his cardinals, condemned by most of the powers, deprived of his dominions by *condottieri* who shamelessly invoked the authority of the council, the pope made concession after concession, and ended on the 15th of December 1433 by a pitiable surrender of all the points at issue in a bull, the terms of which were dictated by the fathers of Basel, that is, by declaring his bull of dissolution null and void, and recognizing that the synod had not ceased to be legitimately assembled. It would be wrong, however, to believe that Eugenius IV. ratified all the decrees coming from Basel, or that he made a definite submission to the supremacy of the council. No express pronouncement on this subject could be wrung from him, and his enforced silence concealed the secret design of safeguarding the principle of sovereignty.

The fathers, who were filled with suspicion, would only allow the legates of the pope to preside over them on condition of their recognizing the superiority of the council; the legates ended by submitting to this humiliating formality, but in their own name only, thus reserving the judgment of the Holy See. Nay more, the difficulties of all kinds against which Eugenius had to contend, the insurrection at Rome, which forced him to escape by the Tiber, lying in the bottom of a boat, left him at first little chance of resisting the enterprises of the council. Emboldened by their success, the fathers approached the subject of reform, their principal object being to curtail the power and resources of the papacy. This is why, besides the disciplinary

measures which regulated the elections, the celebration of divine service, the periodical holding of diocesan synods and provincial councils, are found also decrees aimed at some of the "rights" by which the popes had extended their power, and helped out their finances at the expense of the local churches. Thus annates (*q.v.*) were abolished, the abuse of "reservation" of the patronage of benefices by the pope was much limited, and the right claimed by the pope of "next presentation" to benefices not yet vacant (known as *gratiæ expectatiæ*) was done away with altogether. By other decrees the jurisdiction of the court of Rome was much limited, and rules were even made for the election of popes and the constitution of the Sacred College. The fathers continued to devote themselves to the subjugation of the Hussites; they also intervened, in rivalry with the pope, in the negotiations between France and England which led only to the treaty of Arras, concluded by Charles VII. with the duke of Burgundy; finally, they investigated and judged numbers of private cases, lawsuits between prelates, members of religious orders and holders of benefices, thus themselves falling into one of the serious abuses for which they had most blamed the court of Rome.

The democratic character of the assembly of Basel was the result both of its composition and of its organization; not only was the number of prelates in it always small in comparison with that of the doctors, masters, representatives of chapters, monks or clerks of inferior orders, but the influence of the superior clergy had all the less weight because, instead of being separated into "nations," as at Constance, the fathers divided themselves according to their tastes or aptitudes into four large committees or "deputations" (*deputaciones*), one concerned with questions of faith (*fidæ*), another with negotiations for peace (*pacis*), the third with reform (*reformatoris*), the fourth with what they called "common concerns" (*pro communibus*). Every decision made by three of these "deputations"—and in each of them the lower clergy formed the majority—was ratified for the sake of form in general congregation, and if necessary led to decrees promulgated in session. It was on this account that the council could sometimes be called, not without exaggeration, "an assembly of copyists" or even "a set of grooms and scullions."

Eugenius IV., however much he may have wished to keep on good terms with the fathers of Basel, was neither able nor willing to accept or observe all their decrees. The question of the union with the Greek church, especially, gave rise to a misunderstanding between them which soon led to a rupture. The emperor John Palaeologus, pressed hard by the Turks, showed a great desire to unite himself with the Catholics; he consented to come with the principal representatives of the Greek church to some place in the west where the union could be concluded in the presence of the pope and of the Latin council. Hence arose a double negotiation between him and Eugenius IV. on the one hand and the fathers of Basel on the other. The chief object of the latter was to fix the meeting-place at a place remote from the influence of the pope, and they persisted in suggesting Basel or Avignon or Savoy, which neither Eugenius nor the Greeks would on any account accept. The result was that Palaeologus accepted the offers of the pope, who, by a bull dated the 18th of September 1437, again pronounced the dissolution of the council of Basel, and summoned the fathers to Ferrara, where on the 8th of January 1438 he opened a new synod which he later transferred to Florence. In this latter town took place the momentary union, which was more apparent than real, between the Latin and the Greek church (6th July 1439). During this time the council of Basel, though abandoned by Cesarini and most of its members, persisted none the less, under the presidency of Cardinal Aleman, in affirming its oecumenical character. On the 24th of January 1438 it suspended Eugenius IV., and went on in spite of the intervention of most of the powers to pronounce his deposition (25th June 1439), finally giving rise to a new schism by electing on the 4th of November Amadeus VIII., duke of Savoy, as pope, who took the name of Felix V.

This schism lasted fully ten years, although the antipope found

hardly any adherents outside of his own hereditary states, those of Alphonso of Aragon, of the Swiss confederation and certain universities. Germany remained neutral; Charles VII. of France confined himself to securing to his kingdom by the Pragmatic Sanction of Bourges, which became law on the 13th of July 1438, the benefit of a great number of the reforms decreed at Basel; England and Italy remained faithful to Eugenius IV. Finally, in 1447 Frederick III., king of the Romans, after negotiations with Eugenius, commanded the burgomaster of Basel not to allow the presence of the council any longer in the imperial city. In June 1448 the rump of the council migrated to Lausanne. The antipope, at the instance of France, ended by abdicating (7th April 1449). Eugenius IV. died on the 23rd of February 1447, and the fathers of Lausanne, to save appearances, gave their support to his successor, Nicholas V., who had already been governing the Church for two years. Trustworthy evidence, they said, proved to them that this pontiff accepted the dogma of the superiority of the council as it had been defined at Constance and at Basel. In reality, the struggle which they had carried on in defence of this principle for seventeen years, with a good faith which it is impossible to ignore, ended in a defeat. The papacy, which had been so fundamentally shaken by the great schism of the West, came through this trial victorious. The era of the great councils of the 15th century was closed; the constitution of the Church remained monarchical.

AUTHORITIES.—Mansi, vol. xxix.—xxxi.; Aeneas Sylvius, *De rebus Basiliæ gestis* (Fermo, 1803); Hefele, *Concilien-geschichte*, vol. vii. (Freiburg-im-Breisgau, 1874); O. Richter, *Die Organisation und Geschäftsordnung des Baseler Concils* (Leipzig, 1877); *Monumenta Conciliorum generalium seculi xv.*, *Scriptorum*, vol. i., ii. and iii. (Vienna, 1857—1895); I. Haller, *Concilium Basiliense*, vol. I.—V. (Basel, 1898—1904); G. Perouse, *Le Cardinal Louis Aleman, président élu au concile de Bâle* (Paris, 1904). Much useful material will also be found in J. C. L. Gieseler's *Ecclesiastical History*, vol. iv. p. 312, &c., notes (Eng. trans., Edinburgh, 1853). (N. V.)

BASEMENT, the term applied to the lowest storey of any building placed wholly or partly below the level of the ground. It is incorrectly applied to the case of Somerset House, London, even when, as for instance in the case of Somerset House, building, the ground floor is of plain or rusticated masonry, and the upper storey which it supports is divided up and decorated with columns or pilasters.

BASHAHR, or **BISAHIR**, a Rajput hill state, within the Punjab, amid the Himalayan mountains, with an area of 3820 sq. m. and a population in 1901 of 80,582. In 1898, the raja being of weak intellect and without heir, the administration was undertaken by a British official. In 1906 there were some local troubles owing to the refusal of the people to pay taxes. The revenue is obtained chiefly from land and forests, the latter being leased to the British government.

BASHAN, a region lying E. of the Jordan, and towards its source. Its boundaries are not very well defined, but it may be said in general to have been north of the territory of Gilead. The name first appears in Hebrew history in connexion with the wanderings of the Israelites. According to Numbers xxi. 33, the tribes after the rout of Sihon, king of the Amorites, turned to go by the land of Bashan; and its king, Og, met them at Edrei, and was there defeated and slain. The value of this narrative is a matter of much dispute. The gigantic stature of the king, and the curious details about his "bedstead" (*Deut.* iii. 11) are regarded as suggestive of legend; to say nothing of the lateness of all the documents relating to the wars of Og, and the remoteness of Bashan from the regions of the Israelites' wandering. The story, however, had so firm a hold on Hebrew tradition that it can hardly fail to have some basis in fact; and an invasion by Israel of Bashan before coming to Jordan is by no means an improbability.

The great stature of Og is explained in the passage of Deuteronomy mentioned by the statement that he was of the remnant of the aboriginal *Rephaim*. This was a race distinguished by lofty stature; and in Genesis xiv. 5 we find them established in Ashteroth-Karnaim (probably the same as *Ashteroth*, which, as we shall see, was an important city of Bashan). The territory

was allotted on the partition of the conquered land to the eastern division of the tribe of Manasseh (Numbers xxxiii. 33; Josh. xii. 29). One of the cities of refuge, Golan, was in Bashan (Deut. iv. 43). By Solomon, Bashan, or rather "the region of Argob in Bashan," containing "threescore great cities with walls and brazen bars," was assigned to the administrative district of Ben-Geber, one of his lieutenants (1 Kings iv. 13, compare ver. 19). In the days of Jehu the country was taken from Israel by Hazael, king of Syria (2 Kings x. 33). This is the last historical event related in the Old Testament of Bashan. In the poetical and prophetic books it is referred to in connexion with the products for which it was noted. From a passage in the "Blessing of Moses" (Deut. xxxiii. 22) it seems to have been inhabited by lions. Elsewhere it is referred to in connexion with its cattle (Deut. xxxii. 14; Ezek. xxxix. 18), which seem to have been proverbial for ferocity (Ps. xxii. 12); Amos (iv. 1) calls the wealthy women of Samaria, who oppressed the poor, "kine of Bashan." It is also noted for its mountain (Ps. lxxvii. 15), and especially for oaks, which are coupled with the cedars of Lebanon (Isa. ii. 13; compare xxxiii. 9; Zechariah xi. 2). Oars were made from them (Ezek. xxvii. 6).

The boundaries of Bashan may to some extent be deduced from the indications afforded in the earlier historical books. Og dwelt at Ashteroth, and did battle with the Israelites at Edrei (Deut. i. 4). In Deut. iii. 4, "the region of Argob" with its threescore cities is mentioned; Mt. Hermon is referred to as a northern limit, and Salecah is alluded to in addition to the other cities already mentioned. Josh. xii. 4 and Josh. xiii. 29 confirm this. Josephus (*Ant. iv. 5. 3; Wars, ii. 6. 3*) enumerates four provinces of Bashan, Gaulanitis, Trachonitis, Auranitis and Batanaea. Gaulanitis (which probably derived its name from the city of refuge, Golan, the site of which has not yet been discovered) is represented by the modern Jaulän, a province extending from the Jordan lakes to the Haj Road. Josephus (*Wars, iv. 1. 1*) speaks of it as divided into two sections, Gamalitis and Sogana. Trachonitis (mentioned in Luke iii. 1 as in the territory of Philip the tetrarch) adjoined the territory of Damascus, Auranitis and Batanaea. This corresponds to the *Trachōnes* of Strabo (xvi. 20), and the modern district of the Lejā; inscriptions have been found in the Lejā giving Trachōn as its former name. Auranitis is the Hauran of Ezekiel xlvii. 16, and of the modern Arabs. It is south of the Jaulän and north of Gilead. According to Porter (*Journal Soc. Lit., 1854, p. 303*), the name is locally restricted to the plain south of the Lejā and the narrow strip on the west; although it is loosely applied by strangers to the whole country east of the Jaulän. The fourth province, Batanaea, which still is remembered in the name '*Ard el-Bataniyeh*,' lies east of the Lejā and the Hauran plain, and includes the Jebel ed-Drüz or Hauran mountain.

The identification of Argob, a region of the kingdom of Og, is a matter of much difficulty. It has been equated on philological grounds to the Lejā. But these arguments have been shown to be shaky if not baseless, and the identification is now generally abandoned. The confidence with which the great cities of Og were identified with the extensive remains of ancient sites in the Lejā and Hauran has also been shown to be without justification. All the so-called "giant cities of Bashan" without exception are now known to be Greco-Roman, not earlier than the time of Herod, and, though in themselves of very high architectural and historical interest, have no connexion whatever with the more ancient periods. No tangible traces of Og and his people, or even of their Israelite supplinters, have yet been found.

This fact somewhat weakens the various identifications that have been proposed for the cities of Bashan enumerated by name. Edrei for example is identified with *Ed-Dera'a*. This is perhaps the most satisfactory comparison, for besides the Greco-Roman remains there is an extensive subterranean city of unknown date, which may be of great antiquity, though even this is still *sub judice*. The other identifications that have commanded most acceptance are as follows:—Ashteroth Karnaim, also called Ashteroth and (Josh. xxi. 27) Be-ashterah, has been identified

with *Busrah* (Bostra), where are very important Herodian ruins, but there is no tangible evidence yet adduced that the history of this site is so remote antiquity. From the similarity of the names, it has also been sought at *Tell Ashari* and *Tell 'Ashera*. The true site can be determined, if at all; by excavation only; identifications based on mere outward similarity of names have always been fruitful sources of error. Salecah is perhaps less doubtful; it is a remarkable name, and a ruin similarly styled, *Salikat*, is to be seen in the Hauran. It is inhabited by Druses. Another town in eastern Manasseh, namely Kenath, has been identified by Porter with Kanawat, which may be correct.

In the later history Bashan became remarkable as a refuge for outlaws and robbers, a character it still retains. The great subterranean "city" at Ed-Dera'a has been partially destroyed by the local sub-governor, in order to prevent it becoming a refuge of fugitives from justice or from government requirements (conscription, taxation, &c.). Strabo refers to a great cave in Trachonitis capable of holding 4000 robbers. Arab tradition regards it as the home of Job; and it is famous as being the centre of the Ghassanid dynasty. The Hauran is one of the principal habitations of the sect of the Druses (q.v.).

The physical characteristics of Bashan are noteworthy. Volcanic in origin—the Jebel ed-Drüz is a group of extinct volcanoes—the friable volcanic soil is extraordinarily fertile. It is said to yield wheat eighty-fold and barley a hundred. The oaks for which the country was once famous still distinguish it in places.

BIBLIOGRAPHY.—In addition to books mentioned under PALESTINE see the following:—U. J. Seetzen, *Reisen durch Syrien, Palästina, Phönicien*, &c. (4 vols., 1854); Rev. J. L. Porter, *Five Years in Damascus* (2 vols., 1855); *The Giant Cities of Bashan* (out of date, but some of the descriptions good, 1865); J. G. Wetstein, *Reisebericht über Hauran und die Trachonen* (Berlin, 1866); Sir R. F. Burton and C. F. T. Drake, *Unexplored Syria* (1872); S. Schumacher, *The Jaulän* (1888); *Abila, Pella and Northern Ajlun* (1890); *Across the Jordan* (1886), (Palestine Exploration Fund); Rev. W. Ewing, *A Journey in the Hauran* (with a large collection of inscriptions); *Palestine Exploration Fund Quarterly Statement*, 1895; W. H. Waddington's *Inscriptions of Syria* may also be consulted; Dussaud (René) and Frédéric Macler, *Voyage archéologique au Safa' et dans le Djebel ed-Drüz* (1901). In 1900 an important survey of the Hauran and neighbouring regions was made under American auspices, directed by Dr Enno Littmann; the publication of the great harvest of results was begun in 1906. (R. A. S. M.)

BASHI-BAZOUK, the name given to a species of irregular mounted troops employed by the Turks. They are armed and maintained by the government but do not receive pay. They do not wear uniform or distinctive badges. They fight either mounted or dismounted, chiefly the latter, but are incapable of undertaking serious work, because of their lack of discipline. Their uncertain temper has sometimes made it necessary for the Turkish regular troops to disarm them by force, but they are often useful in the work of reconnaissance and in outpost duty. They are accused, and generally with justice, of robbery and maltreatment of the civil population, resembling in those things, as in their fighting methods and value, the Croats, Pandours and Tolpatches of 18th-century European armies. The term is also used of a mounted force, existing in peace time in various provinces of the Turkish empire, which performs the duties of gendarmery.

BASHKALA, the chief town of a sanjak of the vilayet of Van in Asiatic Turkey. It is a military station, situated at an elevation of 7500 ft. above sea-level in the valley of the Great Zab river. It stands on the east slope of lofty bare mountains, overlooking a wide valley on the farther side of which flows the Zab. On a knoll above is a ruined fortress formerly occupied by a Kurdish Bey. The population numbers some 10,000, principally Kurds, but including 1500 Armenians and 1000 Jews. The place is important as the centre of the Hakkari sanjak, a very difficult mountain district to the south-west containing numerous tribes of Kurds and Nestorian Christians, and also the many Kurdish tribes along the Persian frontier. The houses are well built of sun-dried brick, and the streets are wide and fairly clean. Good smiths' and carpenters' work is

done. The bazaar is small, although a thriving trade is done with the mountain districts. Owing to the great elevation the winter is extremely severe, and the summer of short duration. Wheat, barley, millet and sesame are cultivated on the plain, but fruit and vegetables have mostly to be imported from Persia. Roads lead to Van, Urmia in Persia and Mosul through the Nestorian country. The Kurd and Nestorian tribes in the wilder parts of the Hakkari Mountains are under slight government control, and are permitted to pay tribute and give self-government in a large degree. (F. R. M.)

BASHKIRS, a people inhabiting the Russian governments of Ufa, Orenburg, Perm and Samara, and parts of Vyatka, especially on the slopes and confines of the Ural, and in the neighbouring plains. They speak a Tatar language, but some authorities think that they are ethnically a Finnish tribe transformed by Tatar influence. The name Bashkir or Bash-kürt appears for the first time in the beginning of the 10th century in the writings of Ibn-Foslan, who, describing his travels among the Volga-Bulgarians, mentions the Bashkirs as a warlike and idolatrous race. The name was not used by the people themselves in the 10th century, but is a mere nickname.

Of European writers, the first to mention the Bashkirs are Joannes de Plano Carpini (c. 1200-1260) and William of Rubruquis (1230-1293). These travellers, who fell in with them in the upper parts of the river Ural, call them Pascatir, and assert that they spoke at that time the same language as the Hungarians. Till the arrival of the Mongolians, about the middle of the 13th century, the Bashkirs were a strong and independent people and troublesome to their neighbours, the Bulgarians and Petchenegs. At the time of the downfall of the Kazan kingdom they were in a weak state. In 1556 they voluntarily recognized the supremacy of Russia, and, in consequence, the city of Ufa was founded to defend them from the Kirghiz, and they were subjected to a fur-tax. In 1676 they rebelled under a leader named Seit, and were with difficulty reduced; and again in 1707, under Aldar and Käsöym, on account of ill-treatment by the Russian officials. Their third and last insurrection was in 1735, at the time of the foundation of Orenburg, and it lasted for six years. In 1786 they were freed from taxes; and in 1798 an irregular army was formed from among them. They are now divided into cantons and give little trouble, though some differences have arisen between them and the government about land questions. By mode of life the Bashkirs are divided into settled and nomadic. The former are engaged in agriculture, cattle-rearing and bee-keeping, and live without want. The nomadic portion is subdivided, according to the districts in which they wander, into those of the mountains and those of the steppes. Almost their sole occupation is the rearing of cattle; and they attend to that in a very negligent manner, not collecting a sufficient store of winter fodder for all their herds, but allowing part of them to perish. The Bashkirs are usually very poor, and in winter live partly on a kind of gruel called *yäryu*, and badly prepared cheese named *skürt*. They are hospitable but suspicious, apt to plunder and to the last degree lazy. They have large heads, black hair, eyes narrow and flat, small foreheads, ears always sticking out and a swarthy skin. In general, they are strong and muscular, and able to endure all kinds of labour and privation. They profess Mahomedanism, but know little of its doctrines. Their intellectual development is low.

See J. P. Carpiä, *Liber Tartarorum*, edited under the title *Relations des Mongols ou Tartares*, by d'Arvezac (Paris, 1838); Gulielmus de Rubruquis, *The Journey of William of Rubruck to the Eastern Parts of the World*, translated by W. W. Rockhill (London, 1900); Semenov, *Slovar Ross. Imp.* s.v.; Frähn, "De Bashkiris," in *Mém. de l'Acad. de St-Petersbourg* (1822); Florinsky, in *Wesnik Evropi* (1874); and Katarinskij, *Dictionnaire Bashkir-Russe* (1900).

BASHKIRTSEFF, MARIA CONSTANTINOVA [MARIE] (1860-1884), Russian artist and writer, was born at Gavrontsi in the government of Pultowa in Russia on the 23rd of November 1860. When Marie was seven years old, as her father (marshal of the nobility at Pultowa) and her mother were unable through incompatibility to live together, Madame Bashkirtseff with her

little daughter left Russia to spend the winters at Nice or in Italy, and the summers at German watering-places. Marie acquired an education superior to that given to most girls of her rank. She could read Plato and Virgil in the original, and write four languages with almost equal facility. A gifted musician, she at first hoped to be a singer, and studied seriously in Italy to that end; her voice, however, was not strong enough to stand hard work and failed her. Meanwhile she was also learning to draw. When she lost her voice she devoted herself to painting, and in 1877 settled in Paris, where she worked steadily in Tony Robert-Fleury's studio. In 1880 she exhibited in the salon a portrait of a woman; in 1881 she exhibited the "Atelier Julian"; in 1882 "Jean et Jacques"; in 1884 the "Meeting," and a portrait in pastel of a lady—her cousin—now in the Luxembourg gallery, for which she was awarded a *mention honorable*. Her health, always delicate, could not endure the labour she imposed on herself in addition to the life of fashion in which she became involved as a result of her success as an artist, and she died of consumption on the 31st of October 1884, leaving a small series of works of remarkable promise. From her childhood Marie Bashkirtseff kept an autobiographical journal; but the editors of these brilliant confessions (*Journal de Marie Bashkirtseff*, 1890), aiming apparently at captivating the reader's interest by the girl's precocious gifts and by the names of the various distinguished persons with whom she came in contact, so treated certain portions as to draw down vehement protest. This, to some extent, has brought into question the stamp of truthfulness which constitutes the chief merit of this extraordinarily interesting book. A further instalment of Marie Bashkirtseff literature was published in the shape of letters between her and Guy de Maupassant, with whom she started a correspondence under a feigned name and without revealing her identity.

See Mathilde Blind, *A Study of Marie Bashkirtseff* (T. Fisher Unwin, 1892); *The Journal of Marie Bashkirtseff: an Exposure and a Defence*, by "S." (showing that there is throughout a mistake of four years in the date of the diary); *Black and White*, 6th Feb. and 14th April 1890, pp. 17, 304; *The Journal of Marie Bashkirtseff*, translated, with an introduction, by Mathilde Blind (2 vols., London, 1890); *The Letters of Marie Bashkirtseff* (1 vol.). (B. K.)

BASIL, known as **BASIL THE GREAT** (c. 330-379), bishop of Caesarea, a leading churchman in the 4th century, came of a famous family, which gave a number of distinguished supporters to the Church. His eldest sister, Macrina, was celebrated for her saintly life; his second brother was the famous Gregory of Nyssa; his youngest was Peter, bishop of Sebaste; and his eldest brother was the famous Christian jurist Naucratus. There was in the whole family a tendency to ecstatic emotion and enthusiastic piety, and it is worth noting that Cappadocia had already given to the Church men like Firmilian and Gregory Thaumaturgus. Basil was born about 330 at Caesarea in Cappadocia. While he was still a child, the family removed to Pontus; but he soon returned to Cappadocia to live with his mother's relations, and seems to have been brought up by his grandmother Macrina. Eager to learn, he went to Constantinople and spent four or five years there and at Athens, where he had Gregory (*q.v.*) of Nazianzus for a fellow-student. Both men were deeply influenced by Origen, and compiled the well-known anthology of his writings, known as *Philocalia* (edited by J. A. Robinson, Cambridge, 1893). It was at Athens that he seriously began to think of religion, and resolved to seek out the most famous hermit saints in Syria and Arabia, in order to learn from them how to attain to that enthusiastic piety in

1 The name Basil also belongs to several other distinguished churchmen. (1) Basil, bishop of Ancyra from 336 to 360, a semi-Arian, highly favoured by the emperor Constantine, and a great polemical writer; none of his works are extant. (2) Basil of Seleucia (fl. 448-458), a bishop who shifted sides continually in the Eutychian controversy, and who wrote extensively; his works were published in Paris in 1622. (3) Basil of Ancyra, fl. 787; he opposed image-worship at the second council of Nicaea, but afterwards retracted. (4) Basil of Achrida, archbishop of Thessalonica about 1155; he was a staunch upholder of the claims of the Eastern Church against the widening supremacy of the papacy.

which he delighted, and how to keep his body under by maceration and other ascetic devices. After this we find him at the head of a convent near Arnesi in Pontus, in which his mother Emilia, now a widow, his sister Macrina and several other ladies, gave themselves to a pious life of prayer and charitable works. He was not ordained presbyter until 365, and his ordination was probably the result of the entreaties of his ecclesiastical superiors, who wished to use his talents against the Arians, who were numerous in that part of the country and were favoured by the Arian emperor, Valens, who then reigned in Constantinople. In 370 Eusebius, bishop of Caesarea, died, and Basil was chosen to succeed him. It was then that his great powers were called into action. Caesarea was an important diocese, and its bishop was, *ex officio*, exarch of the great diocese of Pontus. Hot-blooded and somewhat imperious, Basil was also generous and sympathetic. "His zeal for orthodoxy did not blind him to what was good in an opponent; and for the sake of peace and charity he was content to waive the use of orthodox terminology when it could be surrendered without a sacrifice of truth." He died in 379.

The principal theological writings of Basil are his *De Spiritu Sancto*, a lucid and edifying appeal to Scripture and early Christian tradition, and his three books against Eunomius, the chief exponent of Anomoian Arianism. He was a famous preacher, and many of his homilies, including a series of Lenten lectures on the *Hexæmeron*, and an exposition of the psalter, have been preserved. His ascetic tendencies are exhibited in the *Moralia* and *Regulae*, ethical manuals for use in the world and the cloister respectively. His three hundred letters reveal a rich and observant nature, which, despite the troubles of ill-health and ecclesiastical unrest, remained optimistic, tender and even playful. His principal efforts as a reformer were directed towards the improvement of the liturgy, and the reformation of the monastic orders of the East. (See BASILIAN MONKS.)

BIBLIOGRAPHY.—Editions of his works appeared at Basel (1532); Paris, by J. Garnier and P. Maranus (1721-1730), and by L. de Sinner (1839). *Migne's Patrol. ser. graec.* 29-32; *De Spiritu Sancto*, ed. C. F. H. Johnston (Oxford, 1892); *Liturgia*, ed. A. Robertson (London, 1894). See also the patrologies, e.g. that of O. Bardenhewer, and the histories of dogma, e.g. those of A. Harnack and F. Loofs.

BASIL I. (d. 886), known as the "MACEDONIAN", Roman emperor in the East, was born of a family of Armenian (not Slavonic) descent, settled in Macedonia. He spent a part of his boyhood in captivity in Bulgaria, whither his family was carried by the Bulgarian prince Krum in 813. He succeeded in escaping and was ultimately lucky enough to enter the service of Theophilites, a relative of the Caesar Bardas (uncle of Michael III.), as groom. It seems that while serving in this capacity he visited Patrae with his master, and gained the favour of Danielis, a very wealthy lady of that place, who received him into her household, and endowed him with a fortune. He earned the notice of Michael III. by winning a victory in a wrestling match, and soon became the emperor's boon companion and was appointed chamberlain (*parakoimōmenos*). A man of his stamp, advancing unscrupulously on the road of fortune, had no hesitation in divorcing his wife and marrying a mistress of Michael, Eudocia Ingerina, to please his master. It was commonly believed that Leo VI., Basil's successor and reputed son, was really the son of Michael. The next step was to murder the powerful Caesar Bardas, who, as the emperor was devoted to amusement, virtually ruled the empire; this was done with the emperor's consent by Basil's own hand (April 866), and a few weeks later Basil was raised to the imperial dignity. Hitherto few perhaps had divined in the unprincipled adventurer, who shared in the debauches of the imperial drunkard, the talents of a born ruler. On the throne he soon displayed the serious side of his nature and his exceptional capacities for administration. In September 867 he caused his worthless benefactor to be assassinated, and reigned alone. He inaugurated a new age in the history of the empire, associated with the dynasty which he founded,—"the Macedonian dynasty" it is usually called; it would be more instructive to call it "Armenian." It was a period of territorial expansion,

during which the empire was the strongest power in Europe. The great legislative work which Basil undertook and his successor completed, and which may be described as a revival of Justinian law, entitles him to the designation of a second Justinian (the *Basilica*, a collection of laws in sixty books; and the manuals known as the *Prochiron* and *Epanagoge*. For this legislation see *BASILICA* and *ROMAN EMPIRE*, LATER). His financial administration was prudent. His ecclesiastical policy was marked by a wish to keep on good terms with Rome. One of his first acts was to exile the patriarch Photius and restore his rival Ignatius, whose claims were supported by the pope. Yet he had no intention of yielding to Rome's pretensions beyond a certain point. The decision of the Bulgarian tsar Michael to submit the new Bulgarian Church to the jurisdiction of Constantinople was a great blow to Rome, who had hoped to secure it for herself. In 877 Photius became patriarch again, and there was a virtual though not a formal breach with Rome. Thus the independence of the Greek Church may be said to date from the time of Basil. His reign was marked by a troublesome war with the Paulician heretics, an inheritance from his predecessor; the death of their able chief Chrysochir led to the definite subjection of this little state, of which the chief stronghold was Tephrike on the upper Euphrates, and which the Saracens had helped to bid a long defiance to the government of Constantinople. There was the usual frontier warfare with the Saracens in Asia Minor. Cyprus was recovered, but only retained for seven years. Syracuse was lost, but Bari was won back and those parts of Calabria which had been occupied by the Saracens. The last successes opened a new period of Byzantine domination in southern Italy. Above all, New Rome was again mistress of the sea, and especially of the gates of the Adriatic. Basil reigned nineteen years as sole sovereign. His death (20th of August 886) was due to a fever contracted in consequence of a serious accident in hunting. A stag dragged him from his horse by fixing its antlers in his belt. He was saved by an attendant who cut him loose with a knife. His last act was to cause his saviour to be beheaded, suspecting him of the intention to kill and not to rescue. Basil is one of the most remarkable examples of a man, without education and exposed to the most demoralizing influences, manifesting extraordinary talents in the government of a great state, when he had climbed to the throne by acts of unscrupulous bloodshed.

SOURCES.—*Vita Basilii*, by his grandson Constantine VII. (bk. v. of the *Continuation of Theophanes*, ed. Bonn); *Genesius* (ed. Bonn); *Vita Euthymii*, ed. De Boor (Berlin, 1888). Of the Arabic sources Tabari is the most important.

MODERN WORKS.—Finlay, *History of Greece*, vol. ii. (Oxford, 1877); Gibbon, *Decline and Fall*, vols. v. and vi. (ed. Bury, London, 1898); Hergenrother, *Photius, Patriarch von Constantinopel*, vol. ii. (Regensburg, 1867). (J. B. B.)

BASIL II. (c. 958-1025), known as *BULGAROKTONOS* (slayer of Bulgarians), Roman emperor in the East, son of Romanus II. and Theophano, great-great-grandson of Basil I., was born about 958 and crowned on the 22nd of April 960. After their father's death (963) he and his younger brother Constantine were nominal emperors during the actual reigns of Nicephorus Phocas, their stepfather, and John Tzimisces. On the death of the latter (10th of January 976) they assumed the sovereignty without a colleague, but throughout their joint reign Constantine exercised no power and devoted himself chiefly to pleasure. This was in accordance with the Byzantine principle that in the case of two or more co-regnant *basileis* only one governed. Basil was a brave soldier and a superb horseman; he was to approve himself a strong ruler and an able general. He did not at first display the full extent of his energy. The administration remained in the hands of the eunuch Basileios (an illegitimate son of Romanus I.), president of the senate, a wily and gifted man, who hoped that the young emperors would be his puppets. Basil waited and watched without interfering, and devoted himself to learning the details of administrative business and instructing himself in military science. During this time the throne was seriously endangered by the rebellion of an ambitious general who aspired to play the part of Nicephorus Phocas or Tzimisces. This was Bardas

Sclerus, whom the eunuch deposed from his post of general in the East. He belonged to the powerful landed aristocracy of Asia Minor, whose pretensions were a perpetual menace to the throne. He made himself master of the Asiatic provinces and threatened Constantinople. To oppose him, Bardas Phocas, another general who had revolted in the previous reign and been interned in a monastery, was recalled. Defeated in two battles, he was victorious in a third and the revolt was suppressed (979). Phocas remained general in the East till 987, when he rebelled and was proclaimed emperor by his troops. It seems that the minister Basileios was privy to this act, and the cause was dissatisfaction at the energy which was displayed by the emperor, who showed that he was determined to take the administration into his own hands and personally to control the army. Phocas advanced to the Hellespont and besieged Abydos. Basil obtained timely aid, in the shape of Varangian mercenaries, from his brother-in-law Vladimir, the Russian prince of Kiev, and marched to Abydos. The two armies were facing each other, when Basil galloped forward, seeking a personal combat with the usurper who was riding in front of his lines. Phocas, just as he prepared to face him, fell from his horse and was found to be dead. This ended the rebellion.

The fall of Basileios followed; he was punished with exile and the confiscation of his enormous property. Basil made ruthless war upon the system of immense estates which had grown up in Asia Minor and which his predecessor, Romanus I., had endeavoured to check. (For this evil and the legislation which was aimed at it see ROMAN EMPIRE, LATER.) He sought to protect the lower and middle classes.

Basil gained some successes against the Saracens (995); but his most important work in the East was the annexation of the principalities of Armenia. He created in those highlands a strongly fortified frontier, which, if his successors had been capable, should have proved an effective barrier against the invasions of the Seljuk Turks. The greatest achievement of the reign was the subjugation of Bulgaria. After the death of Tzimisces (who had reduced only the eastern part of the Bulgarian kingdom), the power of Bulgaria was restored by the Tsar Samuel, in whom Basil found a worthy foe. The emperor's first efforts against him were unsuccessful (981), and the war was not resumed till 996, Samuel in the meantime extending his rule along the Adriatic coast and imposing his lordship on Servia. Eastern Bulgaria was finally recovered in 1000; but the war continued with varying successes till 1014, when the Bulgarian army suffered an overwhelming defeat. Basil blinded 15,000 prisoners, leaving a one-eyed man to every hundred to lead them to their tsar, who fainted at the sight and died two days later. The last sparks of resistance were extinguished in 1018, and the great Slavonic realm lay in the dust. The power of Byzantium controlled once more the Illyrian peninsula. Basil died in December 1025 in the midst of preparations to send a naval expedition to recover Sicily from the Saracens.

Basil's reign marks the highest point of the power of the Eastern empire since Justinian I. Part of the credit is due to his predecessors Nicephorus and Tzimisces, but the greater part belongs to him. He dedicated himself unsparingly to the laborious duties of ruling, and he had to reckon throughout with the ill-will of a rich and powerful section of his subjects. He was hard and cruel, without any refinement or interest in culture. In a contemporary psalter (preserved in the library of St Mark at Venice) there is a portrait of him, with a grey beard, crowned and robed in imperial costume.

AUTHORITIES.—Leo Diaconus (ed. Bonn, 1828); Psellus, *History* (ed. Sathas, London, 1899); George Cedrenus (*Chronicle*, transcribed from the work of John Scylitzes, vol. ii., ed. Bonn, 1839); Zonaras, bk. xvii. (ed. Bonn, vol. iii., 1897); Cecaumenus, *Strategikon* (ed. Vasilevski and Jernstedt, St Petersburg, 1896); Yahya of Antioch (contemporary Asiatic chronicle), extracts with Russian translation by Rosen (St Petersburg, 1883); Al Me'in (Elmacinus), *Historia Saracenicæ* (ed. with Latin translation by Erpenius, Leiden, 1625); "Laws (*Novelæ*) of Basil" (ed. Zacharia von Lingenthal, in *Die Græco-Romanum*, vol. iii., 1853); Finlay, *Hist. of Greece*; Gibbon, *Decline and Fall*; G. Schlumberger, *L'Épopée byzantine*, part i. and part ii. (Paris, 1896, 1900). (J. B. B.)

BASIL (RUSS. VASILY), the name of four grand-dukes of Moscow and tsars of Muscovy.

BASIL I. DMITREVICH (1371-1425), son of Dmitri (Demetrius) Donskoi, whom he succeeded in 1389, married Sophia, the daughter of Vitovt, grand-duke of Lithuania. In his reign the grand-duchy of Muscovy became practically hereditary, and asserted its supremacy over all the surrounding principalities. Nevertheless Basil received his *yarluik*, or investiture, from the Golden Horde and was compelled to pay tribute to the grand khan, Tokhtamush. He annexed the principality of Suzdal to Muscovy, together with Murom, Kozelsk, Peremyshl, and other places; reduced the grand-duchy of Kostov to a state of vassalage; and acquired territory from the republic of Great Novgorod by treaty. In his reign occurred the invasion of Timur (1395), who ruined the Volgan regions, but did not penetrate so far as Moscow. Indeed Timur's raid was of service to the Russian prince as it all but wiped out the Golden Horde, which for the next twelve years was in a state of anarchy. During the whole of this time no tribute was paid to the khan, though vast sums of money were collected in the Moscow treasury for military purposes. In 1408 the Mirza Edigei ravaged Muscovite territory, but was unable to take Moscow. In 1412, however, Basil found it necessary to pay the long-deferred visit of submission to the Horde. The most important ecclesiastical event of the reign was the elevation of the Bulgarian, Gregory Tsamblak, to the metropolitan see of Kiev (1425) by Vitovt, grand-duke of Lithuania; the immediate political consequence of which was the weakening of the hold of Muscovy on the south-western Russian states. During Basil's reign a terrible visitation of the "Black Death" decimated the population.

See T. Schieman, *Russland bis ins 17. Jahrhundert* (Gotha, 1885-1887).

BASIL II., called **TEMNY** ("the BLIND") (1415-1462), son of the preceding, succeeded his father as grand-duke of Moscow in 1425. He was a man of small ability and unusual timidity, though not without tenacity of purpose. Nevertheless, during his reign Moscow steadily increased in power, as if to show that the personality of the grand-dukes had become quite a subordinate factor in its development. In 1430 Basil was seized by his uncle, George of Halicz, and sent a prisoner to Kostroma; but the nation, dissatisfied with George, released Basil and in 1433 he returned in triumph to Moscow. George, however, took the field against him and Basil fled to Novgorod. On the death of George, Basil was at constant variance with George's children, one of whom, Basil, he had blinded; but in 1445 the grand-duke fell into the hands of blind Basil's brother, Shemyak, and was himself deprived of his sight and banished to Uglich (1445). The clergy and people, however, being devoted to the grand-duke, assisted him not only to recover his throne a second time, but to put Shemyak to flight, and to seize Halicz, his patrimony. During the remainder of Basil II.'s reign he slowly and unobtrusively added district after district to the grand-duchy of Muscovy, so that, in fine, only the republics of Novgorod and Pskov and the principalities of Tver and Vereya remained independent of Moscow. Yet all this time the realm was overrun continually by the Tatars and Lithuanians, and suffered severely from their depredations. Basil's reign saw the foundation of the Solovetsk monastery and the rise of the khanate of the Crimea. In 1448 the north Russian Church became virtually independent of the patriarchal see of Constantinople by adopting the practice of selecting its metropolitan from among native priests and prelates exclusively.

See S. M. Solovet, *History of Russia* (Russ.), (Petersburg, 1895).

BASIL III., **IVANOVICH** (1479-1533), tsar of Muscovy, son of Ivan III. and Sophia Palaeologa, succeeded his father in 1505. A crafty prince, with all the tenacity of his race, Basil succeeded in incorporating with Muscovy the last remnants of the ancient independent principalities, by accusing the princes of Ryazan and Siversk of conspiracy against him, seizing their persons, and annexing their domains (1517-1523). Seven years earlier (24th of January 1510) the last free republic of old Russia, Pskov, was deprived of its charter and assembly-bell, which were sent

to Moscow, and tsarish governors were appointed to rule it. Basil also took advantage of the difficult position of Sigismund of Poland to capture Smolensk, the great eastern fortress of Poland (1512), chiefly through the aid of the rebel Lithuanian, Prince Michael Glinzky, who provided him with artillery and engineers from western Europe. The loss of Smolensk was the first serious injury inflicted by Muscovy on Poland and only the exigencies of Sigismund compelled him to acquiesce in its surrender (1522). Equally successful, on the whole, was Basil against the Tatars. Although in 1510 he was obliged to buy off the khan of the Crimea, Mahommed Girai, under the very walls of Moscow, towards the end of his reign he established the Russian influence on the Volga, and in 1530 placed the pretender Elanyi on the throne of Kazan. Basil was the first grand-duke of Moscow who adopted the title of tsar and the double-headed eagle of the East Roman empire. By his second wife, Helena Glinzka, whom he married in 1526, Basil had a son Ivan, who succeeded him as Ivan IV.

See Sigismund Herberstein, *Rerum Moscoviticarum Commentarii* (Vienna, 1549); P. A. Belyov, *Russian History Previous to the Reforms of Peter the Great* (Russ.), (Petersburg, 1895); E. I. Kashprowsky, *The War of Basil III. with Sigismund I.* (Russ.), (Nyezbin, 1899).

BASIL IV., SHUISKY (d. 1612), tsar of Muscovy, was during the reigns of Theodore I. and Boris Godunov, one of the leading boyars of Muscovy. It was he who, in obedience to the secret orders of Tsar Boris, went to Uglich to inquire into the cause of the death of Demetrius, the infant son of Ivan the Terrible, who had been murdered there by the agents of Boris. Shuisky obsequiously reported that it was a case of suicide; yet, on the death of Boris and the accession of his son Theodore II., the false boyar, in order to gain favour with the first false Demetrius, went back upon his own words and recognized the pretender as the real Demetrius, thus bringing about the assassination of the young Theodore. Shuisky then plotted against the false Demetrius and procured his death (May 1606) also by publicly confessing that the real Demetrius had been indeed slain and that the reigning tsar was an impostor. This was the viler in him as the pseudo-Demetrius had already forgiven him one conspiracy. Shuisky's adherents thereupon proclaimed him tsar (19th of May 1606). He reigned till the 19th of July 1610, but was never generally recognized. Even in Moscow itself he had little or no authority, and was only not deposed by the dominant boyars because they had none to put in his place. Only the popularity of his heroic cousin, Prince Michael Skopin-Shuisky, who led his armies and fought his battles for him, and soldiers from Sweden, whose assistance he purchased by a disgraceful cession of Russian territory, kept him for a time on his unstable throne. In 1610 he was deposed, made a monk, and finally carried off as a trophy by the Polish grand hetman, Stanislaus Zolkiewski. He died at Warsaw in 1612.

See D. I. Ilovaisky, *The Troubled Period of the Muscovite Realm* (Russ.), (Moscow, 1894); S. I. Platonov, *Sketches of the Great Anarchy in the Realm of Moscow* (Petersburg, 1899); D. V. Tsvyeltzev, *Tsar Vasily Shuisky* (Russ.), (Warsaw, 1901-1903); R. Nisbet Bain, *Slavonic Europe*, ch. viii. (Cambridge, 1907). (R. N. B.)

BASILIAN MONKS, those who follow the rule of Basil the Great. The chief importance of the monastic rule and institute of St Basil lies in the fact that to this day his reconstruction of the monastic life is the basis of the monasticism of the Greek and Slavonic Churches, though the monks do not call themselves Basilians. St Basil's claim to the authorship of the Rules and other ascetical writings that go under his name, has been questioned; but the tendency now is to recognize as his at any rate the two sets of Rules. Probably the truest idea of his monastic system may be derived from a correspondence between him and St Gregory Nazianzen at the beginning of his monastic life, the chief portions whereof are translated by Newman in the *Church of the Fathers*, "Basil and Gregory," §§ 4, 5. On leaving Athens Basil visited the monasteries of Egypt and Palestine; in the latter country and in Syria the monastic life tended to become more and more eremitical and to run to great extravagances in the matter of bodily austerities (see MONASTICISM). When (c. 360) Basil formed his monastery in the neighbourhood of

Neocaesarea in Pontus, he deliberately set himself against these tendencies. He declared that the cenobitical life is superior to the eremitical; that fasting and austerities should not interfere with prayer or work; that work should form an integral part of the monastic life, not merely as an occupation, but for its own sake and in order to do good to others; and therefore that monasteries should be near towns. All this was a new departure in monachism. The life St Basil established was strictly cenobitical, with common prayer seven times a day, common work, common meals. It was, in spite of the new ideas, an austere life, of the kind called contemplative, given up to prayer, the reading of the Scriptures and heavy field-work. The so-called Rules (the Longer and the Shorter) are catechisms of the spiritual life rather than a body of regulations for the corporate working of a community, such as is now understood by a monastic rule. Apparently no vows were taken, but obedience, personal poverty, chastity, self-denial, and the other monastic virtues were strongly enforced, and a monk was not free to abandon the monastic life. A novitiate had to be passed, and young boys were to be educated in the monastery, but were not expected to become monks.

St Basil's influence, and the greater suitability of his institute to European ideas, ensured the propagation of Basilian monachism; and Sozomen says that in Cappadocia and the neighbouring provinces there were no hermits but only cenobites. However, the eastern hankering after the eremitical life long survived, and it was only by dint of legislation, both ecclesiastical (council of Chalcedon) and civil (Justinian Code), that the Basilian cenobitic form of monasticism came to prevail throughout the Greek-speaking lands, though the eremitical forms have always maintained themselves.

Greek monachism underwent no development or change for four centuries, except the vicissitudes inevitable in all things human, which in monasticism assume the form of alternations of relaxation and revival. The second half of the 8th century seems to have been a time of very general decadence; but about the year 800 Theodore, destined to be the only other creative name in Greek monachism, became abbot of the monastery of the Studium in Constantinople. He set himself to reform his monastery and restore St Basil's spirit in its primitive vigour. But to effect this, and to give permanence to the reformation, he saw that there was need of a more practical code of laws to regulate the details of the daily life, as a supplement to St Basil's Rules. He therefore drew up constitutions, afterwards codified (see Migne, *Patrol. Graec.* xcix., 1704-1757), which became the norm of the life at the Studium monastery, and gradually spread thence to the monasteries of the rest of the Greek empire. Thus to this day the Rules of Basil and the Constitutions of Theodore the Studite, along with the canons of the Councils, constitute the chief part of Greek and Russian monastic law.

The spirit of Greek monachism, as regenerated by Theodore, may best be gathered from his *Letters, Discourses and Testaments*.¹ Under the abbot were several officials to superintend the various departments; the liturgical services in the church took up a considerable portion of the day, but Theodore seems to have made no attempt to revive the early practice of the Studium in this matter (see ACOEMETI); the rest of the time was divided between reading and work; the latter included the chief handicrafts, for the monks, only ten in number, when Theodore became abbot, increased under his rule to over a thousand. One kind of work practised with great zeal and success by the Studite monks, was the copying of manuscripts, so that to them and to the schools that went forth from them we owe a great number of existing Greek MSS. and the preservation of many works of classical and ecclesiastical antiquity. In addition to this, literary and theological studies were pursued, and the mysticism of pseudo-Dionysius was cultivated. The life, though simple and self-denying and hard, was not of extreme austerity. There was a division of the monks into two classes, similar to the division in vogue in later time in the West into choir-monks and lay-brothers. The life of the choir-monks was predominantly contemplative,

¹ Specimen passages, and also a general picture of the life, will be found in Miss Alice Gardner's *Theodore of Studium*, ch. v.

being taken up with the church services and private prayer and study; the lay-brothers carried on the various trades and external works. There is little or no evidence of works of charity outside the monastery being undertaken by Studite monks. Strict personal poverty was enforced, and all were encouraged to approach confession and communion frequently. Vows had been imposed on monks by the council of Chalcedon (451). The picture of Studite life is the picture of normal Greek and Slavonic monachism to this day.

During the middle ages the centre of Greek monachism shifted from Constantinople to Mount Athos. The first monastery to be founded here was that of St Athanasius (c. 960), and in the course of the next three or four centuries monasteries in great numbers—Greek, Slavonic and one Latin—were established on Mount Athos, some twenty of which still survive.

Basilian monachism spread from Greece to Italy and Russia. Rufinus had translated St Basil's Rules into Latin (c. 400) and they became the rule of life in certain Italian monasteries. They were known to St Benedict, who refers his monks to "the Rule of our holy Father Basil,"—indeed St Benedict owed more of the ground-ideas of his Rule to St Basil than to any other monastic legislator. In the 6th and 7th centuries there appear to have been Greek monasteries in Rome and south Italy and especially in Sicily. But during the course of the 8th, 9th and 10th centuries crowds of fugitives poured into southern Italy from Greece and Sicily, under stress of the Saracenic, Arab and other invasions; and from the middle of the 9th century Basilian monasteries, peopled by Greek-speaking monks, were established in great numbers in Calabria and spread northwards as far as Rome. Some of them existed on into the 18th century, but the only survivor now is the monastery founded by St Nilus (c. 1000) at Grottaferrata in the Alban Hills. Professor Kirsopp Lake has (1903) written four valuable articles (*Journal of Theological Studies*, iv., v.) on "The Greek monasteries of South Italy"; he deals in detail with their scriptoria and the dispersal of their libraries, a matter of much interest, in that some of the chief collections of Greek MSS. in western Europe—as the Bessarion at Venice and a great number at the Vatican—come from the spoils of these Italian Basilian houses.

Of much greater importance was the importation of Basilian monachism into Russia, for it thereby became the norm of monachism for all the Slavonic lands. Greek monks played a considerable part in the evangelizing of the Slavs, and the first Russian monastery was founded at Kiev (c. 1050) by a monk from Mount Athos. The monastic institute had a great development in Russia, and at the present day there are in the Russian empire some 400 monasteries of men and 100 of women, many of which support hospitals, almshouses and schools. In the other Slavonic lands there are a considerable number of monasteries, as also in Greece itself, while in the Turkish dominions there are no fewer than 100 Greek monasteries. The monasteries are of three kinds: *cenobia* proper, wherein full monastic common life, with personal poverty, is observed; others called *idorhythmic*, wherein the monks are allowed the use of their private means and lead a generally mitigated and free kind of monastic life; and the *lauras*, wherein the life is semi-eremitical. Greek and Slavonic monks wear a black habit. The visits of Western scholars in modern times to Greek monasteries in search of MSS.—notably to St Catherine's on Mount Sinai, and to Mount Athos—has directed much attention to contemporary Greek monachism, and the accounts of these expeditions commonly contain descriptions, more or less sympathetic and intelligent, of the present-day life of Greek monks. The first such account was Robert Curzon's in parts iii. (1834) and iv. (1837) of the *Monasteries of the Levant*; the most recent in English is Athelstan Riley's *Athos* (1887). The life is mainly given up to devotional contemplative exercises; the church services are of extreme length; intellectual study is little cultivated; manual labour has almost disappeared; there are many hermits on Athos (*q.v.*).

The ecclesiastical importance of the monks in the various branches of the Orthodox Church lies in this, that as bishops must be celibate, whereas the parochial clergy must be married,

the bishops are all recruited from the monks. But besides this they have been a strong spiritual and religious influence, as is recognized even by those who have scant sympathy with monastic ideals (see Harnack, *What is Christianity?* Lect. xiii., end).

Outside the Orthodox Church are some small congregations of Uniat Basilians. Besides Grottaferrata, there are Catholic Basilian monasteries in Poland, Hungary, Galicia, Rumania; and among the Melchites or Uniat Syrians.

There have been Basilian nuns from the beginning, St Macrina, St Basil's sister, having established a nunnery which was under his direction. The nuns are devoted to a purely contemplative life, and in Russia, where there are about a hundred nunneries, they are not allowed to take final vows until the age of sixty. They are very numerous throughout the East.

AUTHORITIES.—In addition to the authorities for different portions of the subject-matter named in the course of this article, may be mentioned, on St Basil and his Rules, Montalembert, *Monks of the West*, second part of bk. ii., and the chapter on St Basil in James O. Hannay's *Spirit and Origin of Christian Monasticism* (1903). On the history and spirit of Basilian Monachism, Helvot, *Hist. des Ordres Religieux*, i. (1714); Heimbucher, *Orden und Kongregationen* (1907), I., § 11; Abbé Marin, *Les Moines de Constantinople* (1897); Karl Holl, *Enthusiasmus und Bussgebet beim griechischen Monichum* (1898); Otto Zückler, *Ascese und Mönchtum*, pp. 285-309, (1897). For general information see Wetzer und Welte, *Kirchenlexikon* (ed. ii.), art. "Basilianer," and Herzog-Hauck, *Realencyklopädie* (ed. iii.), in articles "Mönchtum," "Orientalische Kirche," and "Athosberg," where copious references will be found. (E. C. B.)

BASILICA, a word of Greek origin (see below), frequently used in Latin literature and inscriptions to denote a large covered building that could accommodate a considerable number of people. Strictly speaking, a basilica was a building of this kind situated near the business centre of a city and arranged for the convenience of merchants, litigants and persons engaged on the public service; but in a derived sense the word might be used for any large structure wherever situated, such as a hall of audience (Vitruv. vi. 5. 2) or a covered promenade (St Jerome, *Ep.* 46) in a private palace; a riding school (*basilica equestris exercitatoria*, *C.I.L.* vii. 965); a market or store for flowers (*basilica floscellaria* [Notitia]), or other kinds of goods (*basilica vestiaria*, *C.I.L.* viii. 20156), or a hall of meeting for a religious body. In this derived sense the word came naturally to be applied to the extensive buildings used for Christian worship in the age of Constantine and his successors.

The question whether this word conveyed to the ancients any special architectural significance is a difficult one, and some writers hold that the name betokened only the *use* of the building, others that it suggested also a certain *form*. Our knowledge of the ancient basilica as a civil structure is derived primarily from Vitruvius, and we learn about it also from existing remains and from incidental notices in classical writers and in inscriptions. If we review all the evidence we are led to the conclusion that there did exist a normal form of the building, though many examples deviated therefrom. This normal form we shall understand if we consider the essential character of the building in the light of what Vitruvius tells us of it.

Vitruvius treats the basilica in close connexion with the forum, to which in his view it is an adjunct. In the earlier classical times, both in Greece and Italy, business of every kind, political, commercial and legal, was transacted in the open forum, and there also were presented shows and pageants. When business increased and the numbers of the population were multiplied, it was found convenient to provide additional accommodation for these purposes. Theatres and amphitheatres took the performances and games. Markets provided for those that bought and sold, while for business of more important kinds accommodation could be secured by laying out new *agorae* or *fora* in the immediate vicinity of the old. At Rome this was done by means of the so-called imperial fora, the latest and most splendid of which was that of Trajan. These fora corresponded to the later Greek or Hellenistic agora, which, as Vitruvius tells us, was of regular form and surrounded by colonnades in two stories, and they had the practical use of relieving the pressure on the

original forum (Cic., *ad Att.* iv. 16). The basilica was a structure intended for the same purposes. It was to all intents and purposes a covered forum, and in its normal form was constituted by an arrangement of colonnades in two stories round a rectangular space, that was not, like the Greek agora, open, but covered with a roof. Vitruvius writes of it as frequented by merchants, who would find in it shelter and quiet for the transaction of their business. Legal tribunals were also set up in it, though it is a mistake to suppose the basilica a mere law court. The magistrates who presided over these tribunals had sometimes platforms, curved or rectangular in plan, provided as part of the permanent fittings of the edifice.

According to Vitruvius (v. 1. 4, cf. also vi. 3. 9) the building is to be in plan a rectangle, not more than three times nor less than twice as long as it is broad. If the site oblige the length to be greater, the surplus is to be cut off to form what he calls *chalcidica*, by which must be meant open vestibules. The interior is divided into a central space and side aisles one-third the width of this. The ground plan of the basilica at Pompeii (fig. 1) illustrates this description, though the superstructure did not correspond to the Vitruvian scheme. The columns between nave and aisles, Vitruvius proceeds, are the same height as the width of the latter, and the aisle is covered with a flat roof forming a terrace (*contignatio*) on which people can walk. Surrounding this on the inner side is a breastwork or parapet (*pluteum*), which would conceal these promenaders from the view of the merchants in the basilica below. On the top of this parapet stood the upper row of columns, three-quarters as high as the lower ones. The spaces between these columns, above the

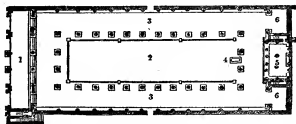

FIG. 1.—Basilica at Pompeii. 1, Portico (Chalcidicum); 2, hall of basilica; 3, aisles; 4, altar; 5, tribunal; 6, offices.

top of the *pluteum*, would be left free for the admission of light to the central space, which was covered by a roof called by Vitruvius (v. 1. 6) *mediana testudo*. Nothing is said about a permanent tribunal or about an apse.

How far existing remains agree with the Vitruvian scheme will be seen as we proceed. We have now to consider the derivation of the word "basilica," the history of the form of building, and its architectural scheme as represented in actual relics.

The word "basilica" is a Latinized form of the Greek adjective βασιλική, "royal," and some feminine substantive, such as *domus*, or *stoa*, which be understood with it. A certain building at Athens, wherein the ἄρχων βασιλεύς transacted business and the court of the Areopagus sometimes assembled, was called βασιλευς στόα, and it is an accredited theory, though it is by no means proved, that we have here the origin of the later basilica. It is difficult to see why this was called "royal" except for some special but accidental reason such as can in this case be divined. There are other instances in which a term that becomes specific has been derived from some one specimen accidentally named. "Labyrinth" is one case in point, and "basilica" may be another. It is true that we do not know what was the shape of the King Archon's portico, but the same name (βασιλευς στόα) was given to the grand structure erected by Herod the Great along the southern edge of the Temple platform at Jerusalem, and this corresponded to the Vitruvian scheme of a columned fabric, with nave and aisles and clerestory lighting.

Whether the Roman basilicas, with which we are chiefly concerned, were derived directly from the Athenian example, or mediately from this through structures of the same kind

erected in the later Greek cities, is hard to say. We should naturally look in that direction for the prototypes of the Roman basilicas, but as a fact we are not informed of any very early basilicas in these cities. The earliest we know of is the existing basilica at Pompeii, that may date back into the 2nd century B.C., whereas basilicas made their appearance at Rome nearly at the beginning of that century. The first was erected by M. Porcius Cato, the censor, in 184 B.C., and was called after his name Basilica Porcia. Cato had recently visited Athens and had been struck by the beauty of the city, so that it is quite possible that the importation was direct.

Rome soon obtained other basilicas, of which the important Basilica Fulvia-Aemilia came next in point of time, till by the age of Augustus there were at least five in the immediate neighbourhood of the forum, the latest and most extensive being the Basilica Julia, which ran parallel to its southern side, and is shown in plan in fig. 2. The great Basilica Ulpia was built

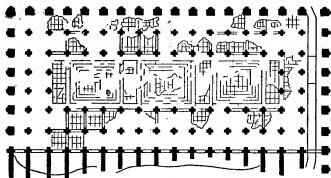

FIG. 2.—Plan of Basilica Julia, Rome. (From Baedeker's *Central Italy*, by permission of Karl Baedeker.)

by Trajan in connexion with his forum about A.D. 112, and a fragment of the Capitoline plan of Rome gives the scheme of it (fig. 3), while an attempted restoration of the interior by Canina is shown in fig. 4. The vaulted basilica of Maxentius or Constantine on the Via Sacra dates from the beginning of the 4th century, and fig. 5 gives the section of it. The number of public basilicas we read of at Rome alone amounts to about a score, while many private basilicas, for business or recreation, must also have existed, that in the palace of Domitian on the Palatine being the best known. In provincial cities in Italy, and indeed all over the empire, basilicas were almost universal, and in the case of Italy we have proof of this as early as the date of the death of Augustus, for Suetonius (*Aug.* 100) tells us that the body of that emperor, when it was brought from Nola in Campania to Rome, rested "in basilica cuiusque oppidi."

As regards existing examples, neither in the peninsula nor the provinces can it be said that these give any adequate idea of



FIG. 3.—Plan of Basilica Ulpia, from Capitoline plan of Rome.

the former abundance and wide distribution of basilicas. Northern Africa contributes one or two examples, and a plan is given of that at Timgad (fig. 6). The Gallic basilicas, which must have been very numerous, are represented only by the noble structure at Trier (Trèves), which is now a single vast hall 180 ft. long, 90 ft. wide and 100 ft. high, commanded at one end by a spacious apse. There is reason to conjecture that this is the basilica erected by Constantine, and some authorities believe that originally it had internal colonnades. In England basilicas remain in part at Silchester (fig. 7), Uriconium (Wroxeter),

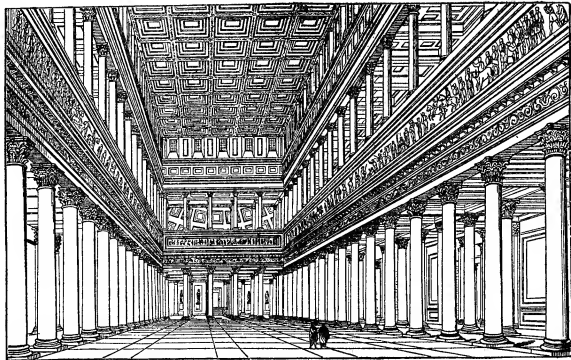

FIG. 4.—Interior view of Trajan's Basilica (*Basilica Ulpia*), as restored by Canina.

Chester (?) and Lincoln, while three others are mentioned in inscriptions (*C.I.L.* vii. 287, 445, 965).

A comparison of the plans of existing basilicas shows considerable variety in form. Some basilicas (Julia, Ulpia, Pompeii) have the central space surrounded by galleries supported on columns or piers, according to the normal scheme, and the newly excavated Basilica Aemilia, north of the Roman forum, agrees with these. In some North African examples, in the palace basilica of Domitian, and at Silchester, there are colonnades down the long sides but not across the ends. Others (Trier [?], Timgad) have no interior divisions. One (Maxentius) is entirely a vaulted structure and in form resembles the great halls of the Roman *Thermae*. At Pompeii, Timgad and Silchester, there are fixed tribunals, while vaulted apses that may



FIG. 5.—Section of the Basilica of Maxentius or Constantine (Temple of Peace).

have contained tribunals occur in the basilica of Maxentius. In the Basilica Julia there was no tribunal at all, though we know that the building was regularly used for the centumviral court (Quint. xii. 5, 6), and the same was the case in the Ulpia, for the semicircular projection at the end shown on the Capitoline plan, was not a vaulted apse and was evidently distinct from the basilica.

In view of the above it might be questioned whether it is safe to speak of a normal form of the basilica, but when we consider the vast number of basilicas that have perished compared to the few that have survived, and the fact that the origins and traditions of the building show it to have been, as Vitruvius describes it, essentially a columned structure, there is ample justification for the view expressed earlier in this article. There can be little doubt that the earlier basilicas, and the majority of basilicas taken as a whole, had a central space with galleries, generally

in two stories, round it, and some arrangement for clerestory lighting. Later basilicas might vary in architectural scheme, while affording the same sort of accommodation as the older ones.

The relation of the civil basilica of the Romans to the Christian church has been extensively discussed, and the reader will find the controversy ably summarized in Kraus's *Geschichte der christlichen Kunst*, bk. 5. There is nothing remarkable in the fact that a large church was called a basilica, for the term was applied, as we have seen, to structures of many kinds, and we even find "basilica" used for the meeting-place of a pagan religious association (*Röm. Mitt.* 1891, p. 109). The similarity in some respects of the early Christian churches to the normal form of the columned basilica is so striking, that we can understand how the theory was once held that Christian churches were the actual civil basilicas turned over from secular to religious uses. There is no evidence for this in the case of public basilicas, and it stands to reason that the demands on these for secular purposes would remain the same whether Christianity were the religion of the empire or not. Moreover, though there are one or two civil basilicas that resemble churches, the latter differ in some most important respects from the form of the basilica that we have recognized as normal. The early Christian basilicas, at any rate in the west, had very seldom, if ever, galleries over the side aisles, and their interior is always dominated by the semidome of an apse that terminates the central nave, whereas, with the doubtful exception of Silchester (*Archaeologia*, liii. 549), there is no instance known of a vaulted apse in a columned civil basilica of the normal kind.

When buildings were first expressly erected for Christian worship, in the 3rd or perhaps already in the 2nd century A.D. (Leclercq, *Manuel*, ch. iii. "Les édifices chrétiens avant la paix de l'église"), they probably took the form of an oblong interior

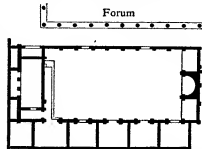

FIG. 6.—Plan of Basilica adjoining the Forum of the Roman city of Timgad, in North Africa.

(From Gsell's *Monuments antiques de l'Algérie*, by permission of A. Fontemoing.)

terminated by an apse. After the time of Constantine, when the numbers of the faithful were enormously increased, side aisles were added, and in this way the structure came to assume an appearance similar to that of the civil basilica. A striking confirmation of this view has recently come to light at S. Saba on the Aventine at Rome, where a small and very early church, without aisles, has been discovered beneath the floor of the present basilica.

There are, on the other hand, instances in which private basilicas in palaces and mansions were handed over to the Christians for sacred uses. We know that to have been the case with the basilicas of S. Croce in Gerusalemme and S. Maria Maggiore at Rome, which originated in the halls of the Sessorian and Liberian palaces respectively, granted by Constantine to the Christians. We may adduce also as evidence of the same practice a passage in bk. x. ch. 71 of the theological romance known as *The Recognitions of Clement*, probably dating from the early half of the 3rd century, in which we are told that Theophilus of Antioch, on his conversion by St Peter, made over "the basilica of his house" for a church. But however this may have been, with, perhaps, the single exception of S. Croce, the existing Christian basilicas were erected from the ground for their sacred purpose. At Rome the columns, friezes and other materials of the desecrated temples and public buildings furnished abundant materials for their construction. The decadence of art is plainly shown by the absence of rudimentary architectural knowledge in these

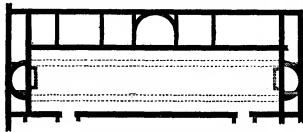

FIG. 7.—Plan of Basilica adjoining the Forum of the Roman city at Silchester, Hants.

(From *Archæologia*, vol. liii.)

reconstructions. Not only are columns of various heights and diameters made to do duty in the same colonnade, but even different orders stand side by side (e.g. Ionic, Corinthian and Composite at S. Maria in Trastevere); while pilasters assume a horizontal position and serve as entablatures, as at S. Lorenzo fuori le Mura. There being no such quarry of ready-worked materials at Ravenna, the noble basilicas of that city are free from these defects, and exhibit greater unity of design and harmony of proportions.

An early Christian basilica may be thus described in its main features:—A porch supported on pillars (as at S. Clemente) gave admission into an open court or *atrium*, surrounded by a colonnaded cloister (S. Clemente, Old St Peter's, S. Ambrogio at Milan, Parenzo). In the centre of the court stood a cistern or fountain (*cantharus, phiale*), for drinking and ablutions. In close contiguity to the atrium, often to the west, was the baptistery, usually octagonal (Parenzo). The church was entered through a long narrow porch (*narthex*), beyond which penitents, or those under ecclesiastical censure, were forbidden to pass. Three or more lofty doorways, according to the number of the aisles, set in marble cases, gave admission to the church. The doors themselves were of rich wood, elaborately carved with scriptural subjects (S. Sabina on the Aventine), or of bronze similarly adorned and often gilt. Magnificent curtains, frequently embroidered with sacred figures or scenes, closed the entrance, keeping out the heat of summer and the cold of winter.

The interior consisted of a long and wide nave, sometimes as much as 80 ft. across, terminating in a semicircular apse, with one or sometimes (St Paul's, Old St Peter's, St John Lateran) two aisles on each side, separated by colonnades of marble pillars supporting horizontal entablatures (Old St Peter's, S. Maria Maggiore, S. Lorenzo) or arches (St Paul's, S. Agnese, S. Clemente, the two basilicas of S. Apollinare at Ravenna). Above the pillars

the clerestory wall rose to a great height, pierced in its upper part by a range of plain round-headed windows. The space between the windows and the colonnade (the later triforium-space) was usually decorated with a series of mosaic pictures in panels. The colonnades sometimes extended quite to the end of the church (the Ravenna basilicas), sometimes ceased some little distance from the end, thus admitting the formation of a transverse aisle or transept (St Paul's, Old St Peter's, St John Lateran). Where this transept occurred it was divided from the nave by a wide arch, the face and soffit of which were richly decorated with mosaics. Over the crown of the arch we often find a bust of Christ or the holy lamb lying upon the altar, and, on either side, the evangelistic symbols, the seven candlesticks and the twenty-four elders. Another arch spanned the semicircular apse, in which the church always terminated. From Carolingian times this was designated the *arch of triumph*, because a cross was suspended from it.

The conch or semi-dome that covered the apse was always covered with mosaic pictures, usually paintings of our Lord, either seated or standing, with St Peter and St Paul, and other apostles and saints, on either hand. The beams of the roof were sometimes concealed by a flat ceiling, richly carved and gilt. The altar, standing in the centre of the chord of the apse on a raised platform reached by flights of steps, was rendered conspicuous by a lofty canopy supported by marble pillars (*ciobrium, baldacchino*), from which depended curtains of the richest materials. Beneath the altar was the *confessio*, a subterranean chapel, containing the body of the patron saint, and relics of other holy persons. This was approached by descending flights of steps from the nave or aisles. The *confessio* in some cases reproduced the original place of interment of the patron saint, either in a catacomb-chapel or in an ordinary grave, and thus formed the sacred nucleus round which the church arose. We have good examples of this arrangement at St Peter's and St Paul's at Rome, and S. Apollinare in Classe, Ravenna. It was copied in the original cathedral of Canterbury. The bishop officiating presbyter advanced from his seat in the centre of the semicircle of the apse to the altar, and celebrated the Eucharist with his face to the congregation below. At the foot of the altar steps a raised platform, occupying the upper portion of the nave, formed a choir for the singers, readers and other inferior clergy. This oblong space was separated from the aisles and from the western portion of the nave by low marble walls or railings (*cancelli*). From these walls projected *ambones* or pulpits with desks, also of marble, ascended by steps.

The exterior of the basilicas was usually of an extreme plainness. The vast brick walls were unrelieved by ornament, save occasionally by arcing as at S. Apollinare in Classe, Ravenna, and had no compensating grace of outline or beauty of proportion. An exception was made for the entrance front, which was sometimes covered with plates of marble mosaics or painted stucco (Old St Peter's, S. Lorenzo). But in spite of any decorations the external

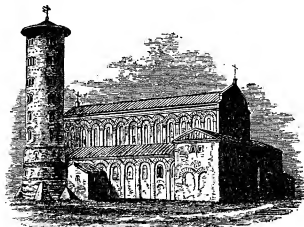

FIG. 8.—S. Apollinare in Classe, Ravenna.

effect of a basilica must always have been heavy and unattractive. S. Apollinare in Classe at Ravenna (fig. 8) affords a typical

example. The campanile is a later addition. Within, apart from the beautiful mosaic decoration, a fine effect was produced by the arch of triumph and the apse, which terminated the nave and dominated the whole vast space of the interior.

To pass from general description to individual churches, the first place must be given, as the earliest and grandest examples of the type, to the world-famous Roman basilicas; those of St Peter, St Paul and St John Lateran, "*omnium urbis et orbis ecclesiarum mater et caput.*" It is true that no one of these exists in its original form, Old St Peter's having been entirely removed in the 16th century to make room for its magnificent successor; and both St Paul's and St John Lateran having been greatly

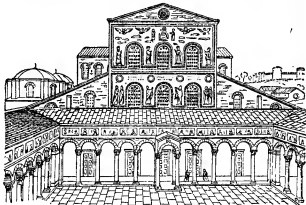

FIG. 9.—Façade of old St Peter's, Rome.

injured by fire, and the last named being so completely modernized as to have lost all interest. Of the two former, however, we possess drawings and plans and minute descriptions, which give an accurate conception of the original buildings. To compare with St Peter's, from the illustrations annexed (figs. 9, 10, 11) it will be seen that the church was entered through a vast colonnaded atrium, 212 ft. by 235 ft., with a fountain in the centre,—the atrium being preceded by a porch mounted by a noble flight of steps. The church was 212 ft. wide by 380 ft. long; the nave, 80 ft. in width, was six steps lower than the side aisles, of which there were two on each side. The four dividing colonnades were each of twenty-two Corinthian columns. Those next the nave supported horizontal entablatures. The inner colonnades bore arches, with a second clerestory. The main clerestory walls were divided into two rows of square panels containing mosaics, and had windows above. The transept projected beyond the body of the church,—a very unusual arrangement. The apse, of remarkably small dimensions, was screened off by a double row of twelve wreathed columns of Parian marble. The pontifical chair was placed in the centre of the chord of the apse, on a platform raised several steps above the presbytery. To the right and left the seats of the cardinals followed the line of the apse. At the

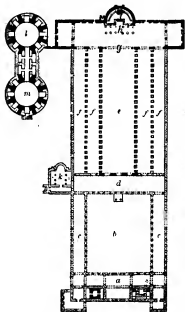

FIG. 10.—Ground-Plan of the original Basilica of St Peter's at Rome.
a, Porch. b, Altar, protected by a double screen.
c, Cloisters. d, Bishop's throne in Narthex. e, centre of the apse.
f, Nave. g, Sacristy.
h, f, Aisles. i, Tomb of Honorius.
j, Bema. m, Church of St Andrew.

centre of the chord stood the high altar beneath a ciborium, resting on four pillars of porphyry. Beneath the altar was the subterranean chapel, the centre of the devotion of so large a

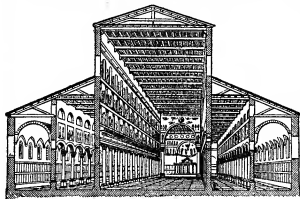

FIG. 11.—Sectional view of the old Basilica of St Peter, before its destruction in the 16th century.

portion of the Christian world, believed to contain the remains of St Peter; a vaulted crypt ran round the foundation wall of the apse in which many of the popes were buried. The roof showed its naked beams and rafters.

The basilica of St Paul without the walls, dedicated 324 A.D., rebuilt 388-423, remained in a sadly neglected state, but substantially unaltered, till the disastrous fire of 1823, which reduced the nave to a calcined ruin. Its plan and dimensions (figs. 12, 13) were almost identical with those of St Peter's.

The only parts of the modernized five-aisled basilica of St John Lateran (of which we have a plan in its original state, Agincourt, pl. lxxiii. No. 22) which retain any interest, are the double-vaulted aisle which runs round the apse, a most unusual arrangement, a most unusual arrangement, and the baptistery. The latter is an octagonal building standing some little distance from the basilica to the south. Its roof is supported by a double range of columns, one above the other, encircling the baptismal basin sunk below the floor.

Of the three-aisled basilicas the best example is the Liberian or S. Maria Maggiore dedicated 365, and reconstructed 432 A.D. Its internal length to the chord of the apse is 250 ft. by 100 ft. in breadth. The Ionic pillars of grey granite, uniform in style, twenty on each side, form a colonnade of great dignity and beauty, unfortunately broken towards the east by intrusive arches opening into chapels. The clerestory, though modern, is excellent in

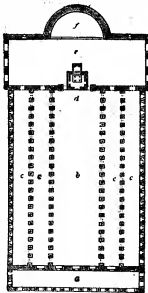

FIG. 12.—Ground-Plan of St Paul's, Rome, before its destruction by fire.

a, Narthex. d, Altar.
b, Nave. e, Bema.
c, c, Side aisles. f, Apse.

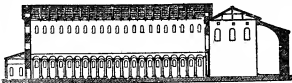

FIG. 13.—Section of the Basilica of St Paul, Rome.

style and arrangement. Corinthian pilasters divide the windows, beneath which are very remarkable mosaic pictures of subjects from Old Testament history, generally supposed to

date from the pontificate of Sixtus III., 432-440. The face of the arch of triumph presents also a series of mosaics illustrative of the infancy of our Lord, of great value in the history of art. The apse is of later date, reconstructed by Paschal I. in 818.

Of the remaining Roman basilicas that of S. Sabina on the Aventine is of special interest as its interior, dating from about A.D. 430, has preserved more of the primitive aspect than any other. Its carved wooden doors of early Christian date are of unique value, and in the spandrels of its inner arcades, upborne by splendid antique Corinthian columns, are some good specimens of *opus sectile* or mosaic of cut marble. The ancient roof is an open one. The basilicas of S. Lorenzo fuori le Mura and S. Agnese deserve particular notice, as exhibiting galleries corresponding to those of the civil basilicas and to the later triforium, carried above the aisles and returned across the entrance end. It is doubtful, however, whether these galleries are part of the original schemes. The architectural history of S. Lorenzo's is curious. When originally constructed in A.D. 432, it consisted of a short nave of six bays, with an internal narthex the whole height of the building. In the 13th century Honorius III. disoriented the church by pulling down the apse and erecting a nave of twelve bays on its site and beyond it, thus converting the original nave into a square-ended choir, the level being much raised, and the magnificent Corinthian columns half buried. As a consequence of the church being thus shifted completely round, the face of the arch of triumph, turned away from the present entrance, but towards the original one, is invested with the usual mosaics (Agincourt, pl. xxviii. Nos. 29, 30, 31). The basilica of S. Agnese, of which we give a section (fig. 14), is a small but

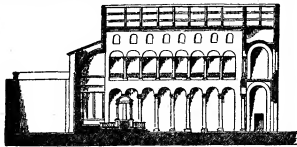

FIG. 14.—Section of Basilica of S. Agnese at Rome.

interesting building, much like what S. Lorenzo must have been before it was altered.

Though inferior in size, and later in date than most of the basilicas already mentioned, that of S. Clemente is not surpassed in interest by any one of them. This is due to its having retained its original ritual arrangements and church-fittings more perfectly than any other. These fittings have been removed from the earlier church, lying below the existing building, which at some unknown date and for some unrecorded reason was abandoned and filled up with earth, while a new building was erected upon it as a foundation. The most probable account is that the earlier church was so completely overwhelmed in the ruin of the city in 1084, when Robert Guiscard burnt all the public buildings from the Lateran to the Capitol, that it was found simpler and more convenient to build a new edifice at a higher level than to repair the old one. The annexed plan (fig. 15) and view (fig. 16) show the peculiarities of the existing building. The church is preceded by an *atrium*, the only perfect example remaining in Rome, in the centre of which is the *cantuarium* or fountain for ablutions. The atrium is entered by a portico made up of earlier fragments very carelessly put together. The *chorus cantorum*, which occupies about one-third of the nave, is enclosed by a low marble screen, about 3 ft. high, a work of the 9th century, preserved from the old church but newly arranged. The white marble slabs are covered with patterns in low relief, and are decorated with ribbons of glass mosaic of the 13th century. These screen-walls stand quite free of the pillars, leaving a passage between. On the ritual north stands the gospel-ambo, of octagonal form, with a double flight of steps westwards and eastwards. To the west of it stands the great

Paschal candlestick, with a spiral shaft, decorated with mosaic. Opposite, to the south, is the epistle-ambo, square in plan, with two marble reading-desks facing east and west, for the reading of the epistle and the gradual respectively. The sanctuary is raised two steps above the choir, from which it is divided by another portion of the same marble screen. The altar stands beneath a lofty *ciborium*, supported by marble columns, with a

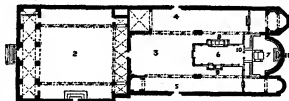

FIG. 15.—Plan of Basilica of S. Clemente in Rome.

- | | | |
|-------------------|---------------------|----------------------|
| 1. Porch. | 5. Aisle for women. | 9. Epistle-ambo. |
| 2. Atrium. | 6. Chorus cantorum. | 10. Confessio. |
| 3. Nave. | 7. Altar. | 11. Bishop's throne. |
| 4. Aisle for men. | 8. Gospel-ambo. | |

canopy on smaller shafts above. It retains the rods and rings for the curtains to run on. Behind the altar, in the centre of the curved line of the apse, is a marble episcopal throne, bearing the monogram of Anastasius who was titular cardinal of this church in 1108. The conch of the apse is inlaid with mosaics of quite the end of the 13th century. The subterranean church, disinterred by the zeal of Father Mullooly, the prior of the adjacent Irish Dominican convent, is supported by columns of very rich marble of various kinds. The aisle walls, as well as those of the narthex, are covered with fresco-paintings of various dates from the 7th to the 11th century, in a marvellous state of preservation. (See *St Clement, Pope and Martyr, and his Basilica in Rome*, by Joseph Mullooly, O.P., Rome, 1873.)

The fullest lists of early Christian basilicas outside Rome are given in Kraus's *Realecyclopädie der christlichen Alterthümer*, Freiburg i. B., 1882, art. "Basilica," and more recently in Leclercq's *Manuel d'archéologie chrétienne*, Paris 1907, vol. i. App. i., "Essai de Classement des Principaux Monuments." Only a few characteristic specimens in different regions can here be noticed. In Italy, apart from Rome, the most remarkable basilican churches are the two dedicated to S. Apollinare at Ravenna. They are of smaller dimensions than those of Rome, but the design and proportions are better. The cathedral of this city, a noble basilica with double aisles, erected by Archbishop Ursus, A.D. 400 (Agincourt, pl. xxiii. No. 21), was unfortunately destroyed on the erection of the present tasteless building. Of the two basilicas of S. Apollinare, the earlier, S. Apollinare Nuovo, originally an Arian church erected by Theodoric, 493-525, measuring 315 ft. in length by 115 ft. in breadth, has a nave 51 ft. wide, separated from the single aisles by colonnades of twenty-two pillars, supporting arches, a small

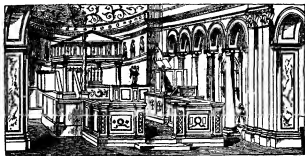

FIG. 16.—Interior of S. Clemente in Rome.

prismatic block bearing a sculptured cross intervening with very happy effect between the capital and the arch. Below the windows a continuous band of saintly figures, male on one side and female on the other, advancing in stately procession towards Our Lord and the Virgin Mother respectively, affords one of the most beautiful examples of mosaic ornamentation to be found

in any church (fig. 17). The design of the somewhat later and smaller church of S. Apollinare in Classe, A.D. 538-549, measuring 216 ft. by 104 ft., is so similar that they must have proceeded from the same architect (Aginocourt, pl. lxxiii. No. 35).

The cathedral on the island of Torcello near Venice, originally built in the 7th century, but largely repaired c. A.D. 1000, deserves special attention from the fact that it preserves, in a more perfect state than can be seen elsewhere, the arrangements of the seats in the apse (fig. 18). The bishop's throne occupies the centre of the arc, approached by a steep flight of steps. Six rows of stone benches for the presbyters, rising one above another like the seats in a theatre, follow the curve on either side—the whole being singularly plain and almost rude. The altar stands on a platform; and the sanctuary is divided from the nave by a screen of six pillars.

FIG. 17.—Arches of S. Apollinare Nuovo, Ravenna.

125 ft. by 75 ft. The narrow aisles are only 7 ft. in width.

Another very remarkable basilica, less known than it deserves to be, is that of Parenzo in Istria, c. A.D. 542. Few basilicas have sustained so little alteration. From the annexed ground-plan (fig. 19) it will be seen that it retains its atrium and a baptistery, square without, octagonal within, to the west of it. Nine pillars divide each aisle from the nave, some of them borrowed from earlier buildings. The capitals are Byzantine. The choir occupies the three easternmost bays. The apse, as at Torcello, retains the bishop's throne and the bench for the presbyters apparently unaltered. The mosaics are singularly gorgeous, and the apse walls, as at Torcello, are inlaid with rich marble and mother-of-pearl. The dimensions are small—121 ft. by 32 ft. (See *Kunstdenkmale des österreichischen Kaiserreichs*, by Dr G. Heider and others.)

In the Eastern church, though the erection of St Sophia at Constantinople introduced a new type which almost entirely superseded the old one, the basilican form, or as it was then termed *dromical*, from its shape being that of a race-course (*dromos*), was originally as much the rule as in the West. The earliest church of which we have any clear account, that of

and had an atrium in front. That erected by Constantine at Jerusalem, on the side of the Holy Sepulchre, 333, followed the same plan (Euseb., *Vit. Const.* iii. c. 20), as did the original churches of St Sophia and of the Apostles at Constantinople. Both these buildings have entirely passed away, but we have an excellent example of an oriental basilica of the same date still standing in the church of the Nativity at Bethlehem, rebuilt

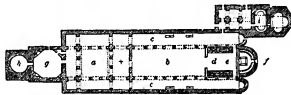

FIG. 19.—Ground-Plan of Cathedral of Parenzo, Istria.

a, Cloistered atrium. d, Chorus cantorum. h, Belfry.
 +, Narthex. e, Altar.
 b, Nave. f, Bishop's throne.
 c, c, Aisles. g, Baptistery.

by Justinian in the 6th century (fig. 20). Here we find an oblong atrium, a vestibule or narthex, double aisles with Corinthian columns, and a transept, each end of which terminates in an apse, in addition to that in the usual position. Beneath the centre of the transept is the subterranean church of the Nativity (Vogüé, *Les Églises de la Terre Sainte*, p. 46).

Constantinople preserved till recently a basilican church of the 5th century, that of St John Studios, 463, now a ruin. It had a nave and side aisles divided by columns supporting a horizontal entablature, with another order supporting arches forming a gallery above. There was the usual apsidal termination. The chief difference between the Eastern and Roman basilicas is in the galleries. This feature is very rare in the West, and only occurs in some few examples, the antiquity of which is questioned at Rome but never at Ravenna. It is, on the other hand, a characteristic feature of Eastern churches, the galleries being intended for women, for whom privacy was more studied than in the West (Salzenberg, *Altkrist. Baudenkmale von Constantinople*).

Other basilican churches in the East which deserve notice are those of the monastery of St Catherine on Mt. Sinai built by Justinian, that of Dana between Antioch and Bir of the same date, St Philip at Athens, Bosra in Arabia, Xanthus in Lycia, and the very noble church of St Demetrius at Thessalonica. Views and descriptions of most of these may be found in Texier and Pullan's *Byzantine Architecture*, Couchaud's *Choix d'églises byzantines*, and the works of the count de Vogüé. In the Roman province of North Africa there are abundant remains of early Christian churches, and S. Gsell, *Les Monuments antiques de l'Algérie*, has noticed more than 130 examples. Basilicas of strictly early Christian date are not now to be met with in France, Spain or Germany, but the interesting though very plain "Basse Œuvre" at Beauvais may date from Carolingian times, while Germany can show at Michelstadt in the Odenwald an unaltered basilica of the time of Charles the Great. The fine-columned basilica of St Mauritius, near Hildesheim, dates from the 11th century, and the basilican form has been revived in the noble modern basilica at Munich.

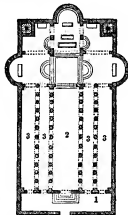

FIG. 20.—Plan of church of the Nativity, Bethlehem. Christian survivals than France or Germany. In the course of the ex-3, 3, aisles.

England can show more early of the Roman city of Silchester, there was brought to light in 1892 the remains of a small early Christian basilica dating from the 4th century of which fig. 21 gives the plan (*Archæologia*, vol. liii.). It will be

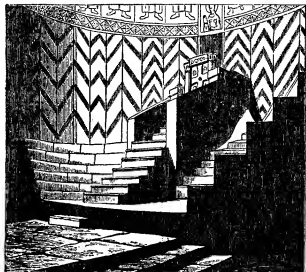

FIG. 18.—Apsé of Basilica, Torcello, with Bishop's throne and seats for the clergy.

(From a drawing by Lady Pulgrave.)

Paulinus at Tyre, A.D. 313-322, described by Eusebius (*Hist. Eccl.* x. 4 § 37), was evidently basilican, with galleries over the aisles,

noted that the apse is flanked by two chambers, of the nature of sacristies, cut off from the rest of the church, and known in ecclesiastical terminology as *prothesis* and *diakonicon*. These features, rare in Italy, are almost universal in the churches of North Africa and Syria. Another existing English basilica of early date is that of Brixworth in Northamptonshire, probably erected by Saxulphus, abbot of Peterborough, c. A.D. 680.

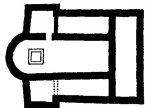

FIG. 21.—Plan of early Christian Basilica of about the 4th century at Silchester, Hants.

(From *Archæologia*, liii.)

It consisted of a nave divided from its aisles by quadrangular piers supporting arches turned in Roman brick, with clerestory windows above, and a short chancel terminating in an apse, outside which, as at St Peter's at Rome, ran a circumscripting crypt entered by steps from the chancel. At the west end was a square porch, the walls of which were carried up later in the form of a tower.

The first church built in England under Roman influence was the original Saxon cathedral of Canterbury. From the annexed ground-plan (fig. 22), as conjecturally restored from Eadmer's description, we see that it was an aisled basilica, with an apse at either end, containing altars standing on raised platforms approached by steps. Beneath the eastern platform was a crypt, or *confessio*, containing relics, "fabricated in the likeness of the confessional of St Peter at Rome" (Eadmer). The western apse, dedicated to the Blessed Virgin, contained the bishop's throne. From this and other indications Willis thinks that this

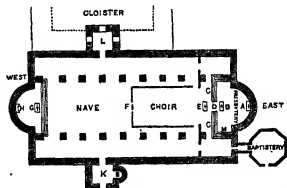

FIG. 22.—Ground-Plan of the original Cathedral at Canterbury, as restored by Willis.

- | | |
|-----------------------|-----------------------------------|
| A. High altar. | G. Our Lady's altar. |
| B. Altar of our Lord. | H. Bishop's throne. |
| C. C. Steps to crypt. | K. South porch with altar. |
| D. Crypt. | L. North porch containing school. |
| E. Chorus cantorum. | M. Archbishop Odo's tomb. |

was the original altar end, the eastern apse being a subsequent addition of Archbishop Odo, c. 950, the church having been thus turned from west to east, as at the already-described basilica of S. Lorenzo at Rome. The choir, as at S. Clemente's, occupied the eastern part of the nave, and like it was probably enclosed by breast-high partitions. There were attached porches to the north and south of the nave. The main entrance of the church was through that to the south. At this *sankture*, according to Eadmer, "all disputes from the whole kingdom, which could not legally be referred to the king's court, or to the hundreds and counties, received judgment." The northern porch contained a school for the younger clergy.

AUTHORITIES.—Vitruvius, *De Architectura*, v. 1, vi. 3, 9; Huelsen, *The Roman Forum* (1906); Mau, *Pompeii: its Life and Art*; C. Lange, *Haus und Halle*; Canina, *Edificii di Roma Antica*; Ciampini, *Vetera Monumenta*; Seroux d'Agincourt, *L'Histoire de l'art par les monumens*; Bunsen and Plattner, *Beschreibung der Stadt Rom*; Gutesenon and Knapp, *Basiliken des christlichen Roms*; Zosteremann, *Die antiken u. die christlichen Basiliken*; Hübsch, *Die altchristlichen Kirchen*; Messmer, *Über den Ursprung, &c., der Basilica*; Letarouilly, *Edifices de Rome moderne*; Von Quast, *Altchristliche Bau-*

werke von Ravenna; Texier and Pullan, *Byzantine Architecture*; Vogüé, *Eglises de la Terre Sainte*; Syrie Centrale, *Architecture*, &c.; Couchaud, *Choix d'églises byzantines*; Dehio and von Bezold, *Die kirchliche Baukunst des Abendlandes*; Holtzinger, *Die altchristliche Architektur in systematischer Darstellung*; Kraus, *Geschichte der christlichen Kunst*; Leclercq, *Manuel d'archéologie chrétienne* (Paris, 1907). (E. V.; G. B. B.)

BASILICA, a code of law, drawn up in the Greek language, with a view to putting an end to the uncertainty which prevailed throughout the East Roman empire in the 6th century as to the authorized sources of law. This uncertainty had been brought about by the conflicting opinions of the jurists of the 6th century as to the proper interpretation to be given to the legislation of the emperor Justinian, from which had resulted a system of teaching which had deprived that legislation of all authority, and the imperial judges at last were at a loss to know by what rules of law they were to regulate their decisions. An endeavour had been made by the emperor Leo the Isaurian to remedy this evil, but his attempted reform of the law had been rather calculated to increase its uncertainty; and it was reserved for Basil the Macedonian to show himself worthy of the throne, which he had usurped, by purifying the administration of justice and once more reducing the law into an intelligible code. There has been considerable controversy as to the part which the emperor Basil took in framing the new code. There is, however, no doubt that he abrogated in a formal manner the ancient laws, which had fallen into desuetude, and the more probable opinion would seem to be, that he caused a revision to be made of the ancient laws which were to continue in force, and divided them into forty books, and that this code of laws was subsequently enlarged and distributed into sixty books by his son Leo the Philosopher. A further revision of this code is stated to have been made by Constantine Porphyrogenitus, the son and successor of Leo, but this statement rests only on the authority of Theodoros Balsamon, a very learned canonist of the 12th century, who, in his preface to the *Nomocanon* of Patriarch Photius, cites passages from the Basilica which differ from the text of the code as revised by the emperor Leo. The weight of authority, however, is against any further revision of the code having been made after the formal revision which it underwent in the reign of the emperor Leo, who appointed a commission of jurists under the presidency of Sympathius, the captain of the body-guard, to revise the work of his father, to which he makes allusion in the first of his *Novellæ*. This latter conclusion is the more probable from the circumstance, that the text of the code, as revised by the emperor Leo, agrees with the citations from the Basilica which occur in the works of Michael Psellus and Michael Attaliates, both of them high dignitaries of the court of Constantine, who lived a century before Balsamon, and who are silent as to any second revision of the code having taken place in the reign of Constantine Porphyrogenitus, as well as with other citations from the Basilica, which are found in the writings of Mathæus Blastares and of Constantine Harmenopolus, both of whom wrote shortly after Balsamon, and the latter of whom was far too learned a jurist and too accurate a lawyer to cite any but the official text of the code.

Authors are not agreed as to the origin of the term Basilica, by which the code of the emperor Leo is now distinguished. The code itself appears to have been originally entitled *The Revision of the Ancient Laws* (*ἡ ἀνακθάρσις τῶν παλαιῶν νόμων*); next there came into use the title *ἡ ἐξηροντάβηλας*, derived from the division of the work into sixty books; and finally, before the conclusion of the 10th century, the code came to be designated *ὁ βασιλικός*, or *τὰ βασιλικά*, being elliptical forms of *ὁ βασιλικὸς νόμος* and *τὰ βασιλικά νόμματα*, namely the Imperial Law or the Imperial Constitutions. This explanation of the term "Basilica" is more probable than the derivation of it from the name of the father of the emperor Leo, inasmuch as the Byzantine jurists of the 11th and 12th centuries ignored altogether the part which the emperor Basil had taken in initiating the legal reforms, which were completed by his son; besides the name of the father of the emperor Leo was written *βασιλεὺς*, from which substantive, according to the genius of

the ancient Greek language, the adjective βασιλικός could not well be derived.

No perfect MS. has been preserved of the text of the *Basilica*, and the existence of any portion of the code seems to have been ignored by the jurists of western Europe, until the important bearing of it upon the study of the Roman law was brought to their attention by Viglius Zuichemus, in his preface to his edition of the Greek *Paraphrase of Theophilus*, published in 1533. A century, however, elapsed before an edition of the sixty books of the *Basilica*, as far as the MSS. then known to exist supplied materials, was published in seven volumes, by Charles Annibal Fabrot, under the patronage of Louis XIII. of France, who assigned an annual stipend of two thousand livres to the editor during its publication, and placed at his disposal the royal printing-press. This edition, although it was a great undertaking and a work of considerable merit, was a very imperfect representation of the original code. A newly-restored and far more complete text of the sixty books of the *Basilica* was published at Leipzig in six volumes (1833-1870), edited by K. W. E. Heimbach and G. E. Heimbach. It may seem strange that so important a body of law as the *Basilica* should not have come down to us in its integrity, but a letter has been preserved, which was addressed by Mark the patriarch of Alexandria to Theodorus Balsamon, from which it appears that copies of the *Basilica* were in the 12th century very scarce, as the patriarch was unable to procure a copy of the work. The great bulk of the code was an obstacle to the multiplication of copies of it, whilst the necessity for them was in a great degree superseded by the publication from time to time of synopses and encheiridia of its contents, composed by the most eminent jurists, of which a very full account will be found in the *Histoire au droit byzantin*, by the advocate Mortreuil, published in Paris in 1846.

BASILICATA, a territorial division of Italy, now known as the province of Potenza, which formed a part of the ancient Lucania (*q.v.*). It is bounded N. by the province of Foggia, N. E. by those of Bari and Lecce, E. by the Gulf of Taranto (for a distance of 24 m.), S. by the province of Cosenza, and W. by the Mediterranean (for a distance of 10 m. only), and by the provinces of Salerno and Avellino. It has an area of 3845 sq. m. The province is as a whole mountainous, the highest point being the Monte Pollino (7325 ft.) on the boundary of the province of Cosenza, while the Monte Vulture, at the N.W. extremity, is an extinct volcano (4305 ft.). It is traversed by five rivers, the Bradano, Basento, Cavone or Salandrella, Agri and Sinni. The longest, the Bradano, is 104 m. in length; all run S.E. or E. into the Gulf of Taranto. The province is traversed from W. to E. by the railway from Naples to Taranto and Brindisi, which passes through Potenza and reaches at Metaponto the line along the E. coast from Taranto to Reggio di Calabria. A branch line runs N. from Potenza via Melì to Rocchetta S. Antonio, a junction for Foggia, Gioia del Colle and Avellino (the second of these lines runs through the province of Potenza as far as Palazzo S. Gervasio), while a branch S. from the Naples and Taranto line at Sicignano terminates at Lagonegro, on the W. edge of the province. Communications are rendered difficult by the mountainous character of the interior. The mountains are still to some extent clothed with forests; in places the soil is fertile, especially along the Gulf of Taranto, though here malaria is the cause of inefficient cultivation. Olive-oil is the most important product. The total population of the province was 490,705 in 1901. The chief towns were Potenza (pop. 1901, 16,186), Avigliana (18,313), Matera (17,237), Melì (14,649), Rionero in Vulture (11,809), Lauria (10,099).

BASILIDES, one of the most conspicuous exponents of Gnosticism, was living at Alexandria probably as early as the first decades of the 2nd century. It is true that Eusebius, in his *Chronicle*, dates his first appearance from A.D. 133, but according to Eusebius, *Hist. Eccl.* iv. 7 §§ 6-8, Agrippa Castor, who lived under Hadrian (117-138), already wrote a polemic against him, so that his activity may perhaps be set back to a date earlier than 138. Basilides wrote an exegetical work in twenty-four books on "his" gospel, but which this was is not known. In addition to this there are certain writings by his son Isidorus Περὶ προσφωτῶν ψυχῆς; Ἐξηγητικά on the prophet Parchor (Παρχοῦ); Ἰθυσά. The surviving fragments of these works are collected and commented on in Hilgenfeld's *Ketzer-geschichte*, 207-218. The most important fragment published by Hilgenfeld (p. 207), part of the 13th book of the *Exegetica*, in

the *Acta Archelai et Manetis* c. 55, only became known in its complete form later, and was published by L. Traube in the *Sitzungsbericht der Münchener Akad.*, phil. histor. Kl. (1903), pp. 533-549. Irenaeus (*Adv. Haer.* i. 24 §§ 3-7) gives a sketch of Basilides' school of thought, perhaps derived from Justin's *Synagma*. Closely related to this is the account in the *Synagma* of Hippolytus, which is preserved in Epiphanius, *Haer.* 24, Philaster, *Haer.* 32, and Pseudo-Tertullian, *Haer.* 4. These are completed and confirmed by a number of scattered notices in the *Stromateis* of Clemens Alexandrinus. An essentially different account, with a pronounced monistic tendency, is presented by the so-called *Philosophumena* of Hippolytus (vii. 20-27; x. 14). Whether this last account, or that given by Irenaeus and in the *Synagma* of Hippolytus, represents the original system of Basilides, has been the subject of a long controversy. (See Hilgenfeld p. 205, note 337.) The most recent opinion tends to decide against the *Philosophumena*; for, in its composition, Hippolytus appears to have used as his principal source the compendium of a Gnostic author who has introduced into most of the systems treated by him, in addition to the employment of older sources, his own opinions or those of his sect. The *Philosophumena*, therefore, cannot be taken into account in describing the teaching of Basilides (see also H. Stachelin, "Die gnostischen Quellen Hippolyts" in *Texte und Untersuchungen*, vi. 3; and the article GNOSTICISM). A comparison of the surviving fragments of Basilides, moreover, with the outline of his system in Irenaeus-Hippolytus (*Synagma*) shows that the account given by the Fathers of the Church is also in the highest degree untrustworthy. The principal and most characteristic points are not noticed by them. If we assume, as we must needs do, that the opinions which Basilides promulgates as the teaching of the "barbari" (*Acta Archelai* c. 55) were in fact his own, the fragments prove him to have been a decided dualist, and his teaching an interesting further development of oriental (Iranian) dualism. Entirely consistent with this is the information given by the *Acta Archelai* that Basilides, before he came to Alexandria, had appeared publicly among the Persians (*ἦντι προαδicator apud Persas*); and the allusion to his having appealed to prophets with oriental names, Barkabbas and Barkoph (Agrippa in Eusebius *Hist. Eccl.* iv. 7 § 7). So too his son Isidorus explained the prophecies of a certain Parchor (=Barkoph) and appealed to the prophecies of Cham¹ (Clemens Alexandrinus, *Stromat.* vi. 6 § 53). Thus Basilides assumed the existence of two principles, not derivable from each other: Light and Darkness. These had existed for a long time side by side, without knowing anything of each other, but when they perceived each other, the Light had only looked and then turned away; but the Darkness, seized with desire for the Light, had made itself master, not indeed of the Light itself, but only of its reflection (*species, color*). Thus they had been in a position to form this world: *unde nec perfectum bonum est in hoc mundo, et quod est, valde est exiguum*. This speculation is clearly a development of that which the Iranian cosmology has to tell about the battles between Ahura-Mazda and Angro-Mainyu (Ormuzd and Ahriman). The Iranian optimism has been replaced here by a strong pessimism. This material world is no longer, as in Zoroastrianism, essentially a creation of the good God, but the powers of evil have created it with the aid of some stolen portions of light. This is practically the transference of Iranian dualism to the more Greek antithesis of soul and body, spirit and matter (cf. Irenaeus i. 24 § 5: *animae autem eorum solam esse saluam, corpus enim natura corruptibile existit*). The fundamental dualism of Basilides is confirmed also by one or two other passages. In the parable of the rich man and Lazarus, Basilides saw the proof of *naturam sine radice et sine loco rebus superententem* (*Acta Archelai*). According to Clemens, *Strom.* iv. 12 § 83, &c., Basilides taught that even those who have not sinned in act, even Jesus himself, possess a sinful nature. It is possibly also in connexion with the dualism of his fundamental

¹ = Nimrod = Zoroaster, cf. Pseudo-Clement, *Homil.* ix. 3. *Recogn.* iv. 27.

views that he taught the transmigration of souls (Origen in *Ep. ad Rom.* lib. v.; *Opp. de la Rue* iv. 549; cf. Clemens, *Excerpta ex Theodoto*, § 28). Isidorus set up celibacy, though in a modified form, as the ideal of the perfect (Clemens, *Strom.* iii. 1 § 1, &c.). Clemens accuses Basilides of a deification of the Devil (βασιλειαν διὰ βολον), and regards as his two dogmas that of the Devil and that of the transmigration of souls (*Strom.* iv. 12 § 85; cf. v. 11 § 75). It is remarkable too that Isidorus held the existence of two souls in man, a good and a bad (Clemens, *Strom.* ii. 20 113); with which may be compared the teaching of Mani about the two souls, which it is impossible to follow F. Ch. Baur in excluding,¹ and also the teaching of the *Pistis Sophia* (translated by C. Schmidt, p. 182, &c.). According to Clemens (*Strom.* ii. 20 § 112), the followers of Basilides spoke of πνεύματά τινά προσηρημένα τῇ λογικῇ ψυχῇ κατὰ τινά παραχον καὶ στήγχιον ἀρχικόν: that is to say, here also is assumed an original confusion and intermingling. Epiphanius too tells us that the teaching of Basilides had its beginning in the question as to the origin of evil (*Haer.* xxiv. 6).

Now, of this sharply-defined dualism there is scarcely a trace in the system described by the Fathers of the Church. It is therefore only with caution that we can use them to supplement our knowledge of the true Basilides. The doctrine described by them that from the supreme God (the *innatus pater*) had emanated 365 heavens with their spirits, answers originally to the astronomical conception of the heavens with their 365 daily aspects (*Irenaeus* i. 24. 7; *Trecentorum autem sexaginta quinque caelorum locales positiones distribuitur similiter ut mathematici*). When, therefore, the supreme God is called by the name Ἀβραξας or Ἀβραξας, which contains the numerical value 365, it is worthy of remark that the name of the Persian god Mithras (Μετράσ) also was known in antiquity to contain this numerical value (*Jerome* in *Amos* 3; *Opp. Vallarsi* VI. i. 257). Speculations about the Perso-Hellenistic Mithras appear to have been transferred to the Gnostic Abraxas. Further, if the *Pater innatus* was surrounded by a series of (from five to seven) *Hypostases* (according to *Irenaeus* i. 24. 3; Νους, Λόγος, Φρόνησις, Σοφία, Διναμῆς; according to Clemens, *Strom.* iv. 25 § 164, Δυακοσίση and Εἰρήνη may perhaps be added), we are reminded of the *Ameshas-spentas* which surround Ahura-Mazda. Finally, in the system of Basilides, the (seven ?) powers from whom this world originates are accepted as the lowest emanations of the supreme God. This conception which is repeated in nearly every Gnostic system, of (seven) world-creating angels, is a specifically oriental speculation. The seven powers which create and rule the world are without doubt the seven planetary deities of the later Babylonian religion. If, in the Gnostic systems, these become daemonic or semi-daemonic forces, this points to the fact that a stronger monotheistic religion (the Iranian) had gained the upper hand over the Babylonian, and had degraded its gods to daemons. The syncretism of the Babylonian and the Persian religion was also the nursing-ground of Gnosticism. When, then, Basilides identified the highest angel of the seven, the creator of the worlds, with the God of the Jews, this is a development of the idea which did not occur until late, possibly first in the specifically Christian circles of the Gnostics. We may note in this connexion that the system of Basilides ascribes the many battles and quarrels in the world to the privileged position given to his people by the God of the Jews.²

It is at this point that the idea of salvation is introduced into the system. The confusion in the world has meanwhile risen to such a pitch that the supreme God sends his *Nous*, who is also called Christ, into the world (*Irenaeus* i. 24. 4). According to Clemens, the Saviour is termed πνεῦμα διακοινοῦμενον (*Strom.* ii. 8 § 36) or διάκομος (*Excerpta ex Theodoto*, § 16). It is im-

possible certainly to determine how Basilides conceived the relation of this Saviour to Jesus of Nazareth. Basilides himself (*Strom.* iv. 12 § 83) knows of an earthly Jesus and denies the principle of his sinlessness (see above). According to the account given by Irenaeus, the Saviour is said to have appeared only as a phantasm; according to the *Excerpta ex Theodoto*, 17, the Diakonos descended upon Jesus at His baptism in the form of a dove, for which reason the followers of Basilides celebrated the day of the baptism of Jesus, the day of the ἐπιφάνεια as a high festival (Clemens, *Strom.* i. 21 § 18). The various attempts at combination probably point to the fact that the purely mythical figure of a god-saviour (Heros) was connected first by Basilides with Jesus of Nazareth. As to what the conception of Basilides was of the completion of the process of redemption, the available sources tell us next to nothing. According to an allusion in Clemens, *Strom.* ii. 8 § 36, with the mission of the Saviour begins the great separation of the sexes, the fulfilment and the restoration of all things. This agrees with the beginning of the speculation of Basilides. Salvation consists in this, that that which was combined for evil is once more separated.

Among the later followers of Basilides, actual magic played a determining part. They hand down the names of the rulers of the several heavens as a weighty secret. This was a result of the belief, that whoever knew the names of these rulers would after death pass through all the heavens to the supreme God. In accordance with this, Christ also, in the opinion of these followers of Basilides, was in the possession of a mystic name (Caulcau = 𐤒𐤍 𐤒𐤍 Jes. xviii. 10) by the power of which he had descended through all the heavens to earth, and had then again ascended to the Father. Redemption, accordingly, could be conceived as simply the revelation of mystic names. In this connexion the name Abraxas and the Abraxas gems must be remembered. Whether Basilides himself had already given this magic tendency to Gnosticism cannot be decided.

Basilides, then, represents that form of Gnosticism which is closest to Persian dualism in its final form. His doctrine is most closely related to that of Saturnil (Saturninus). From most of the other Gnostic sects, with the exception perhaps of the Jewish-Christian Gnosticism, he is distinguished by the fact that with him the figure of the fallen female god (Sophia Achamoth), and, in general, the idea of a fall within the godhead is entirely wanting. So far as we can see, on the other hand, Basilides appears actually to represent a further development of Iranian dualism, which later produced the religious system of Mani.

Accounts of the teaching of Basilides are to be found in all the more complete works on Gnosticism (see bibliography to the article Gnosticism). The original sources are best reproduced in Hlilgenfeld, *Ketzerschichte des Urchristentums* (1884), pp. 109-230. See also Krüger, article "Basilides," in Herzog-Hauck, *Realencyclopädie*, ed. 3. (W. Ho.)

BASILISK (the βασιλικός of the Greeks, and *Tsepha* (cockatrice) of the Hebrews), a name given by the ancients to a horrid monster of their own imagination, to which they attributed the most malignant powers and an equally fiendish appearance. The term is now applied, owing to a certain fanciful resemblance, to a genus of lizards belonging to the family *Iguanidae*, the species of which are characterized by the presence, in the males, of an erectile crest on the head, and a still higher, likewise erectile crest—beset with scales—on the back, and another on the long tail. *Basiliscus americanus* reaches the length of one yard; its colour is green and brown, with dark crossbars, while the crest is reddish. This beautiful, strictly herbivorous creature is rather common amidst the luxuriant vegetation on the banks of rivers and streams of the Atlantic hot lands of Mexico and Guatemala. The lizards lie upon the branches of trees overhanging the water, into which they plunge at the slightest alarm. Then they propel themselves by rapid strokes of the hind limbs, beating the water in a semi-erect position and letting the long rudder-like tail drag behind. They are universally known as *pasa-rios*, i.e. ferrymen.

BASIM, a town of India, in the Akola district, Berar, 52 m. S.S.E. from Akola station of the Great Indian Peninsula railway. Pop. (1901) 13,823. Until 1905 it was the headquarters of the district of Basim, which had an area of 2949 sq. m.; but in that

¹ The materials are in Baur, *Das manichäische Religionssystem* (1831), p. 162, &c.

² Whether the myth of the creation of the first man by the angels, which recurs in many Gnostic systems, found a place also in the system of Basilides, cannot be determined with any certainty. Philastrius, however, says: *hominem autem ab angelis factum asserit*, while according to Epiphanius xxiv. 2, men are created by the God of the Jews.

year the district was abolished, its component *taluks* being divided between the districts of Akola and Yeotmal. Its western portion, the Basin *taluk*, consists of a fertile tableland, about 1000 ft. above sea-level, sloping down westward and southward to the rich valley of the Penganga; its eastern portion, the *taluks* of Mangrul and Pasud, mainly of a succession of low hills covered with poor grass. In the Pasud *taluk*, however, there are wide stretches of woodland, while some of the peaks rise to a height of 2000 ft., the scenery (especially during the rains) being very beautiful. The climate of the locality is better than that of the other districts of Berar; the hot wind which blows during the day in the summer months being succeeded at night by a cool breeze. The principal crops are millet, wheat, other food grains, pulse, oilseeds and cotton; there is some manufacture of cotton-cloth and blankets, and there are ginning factories in the town. In 1901 the population was 353,410, showing a decrease of 11% in the decade, due to the famine of 1890-1900, which was severely felt in the district.

BASIN, THOMAS (1412-1491), bishop of Lisieux and historian, was born probably at Caudebec in Normandy, but owing to the devastation caused by the Hundred Years' War, his childhood was mainly spent in moving from one place to another. In 1424 he went to the university of Paris, where he became a master of arts in 1429, and afterwards studied law at Louvain and Pavia. He attended the council of Ferrara, and was soon made canon of the church at Rouen, professor of canon law in the new university of Caen and vicar-general for the bishop of Bayeux. In 1447 he became bishop of Lisieux. He was much involved in the wars between the English and French and was employed by Charles VII. of France, and by his successor Louis XI., at whose request Basin drew up a memorandum setting forth the misery of the people and suggesting measures for alleviating their condition. In 1464 the bishop joined the league of the Public Weal, and fell into disfavour with the king, who seized the temporalities of his see. After exile in various places Basin proceeded to Rome and renounced his bishopric. At this time (1474) Pope Sixtus IV. bestowed upon him the title of archbishop of Caesarea. Occupied with his writings Basin then passed some years at Trier, and afterwards transferred his residence to Utrecht, where he died on the 3rd of December 1491. He was buried in the church of St John, Utrecht.

Basin's principal work is his *Historiae de rebus a Carolo VII. et Ludovico XI. Francorum regibus eorumque in tempore in Gallia gestis*. This is of considerable historical value, but is marred to some extent by the author's dislike for Louis XI. At one time it was regarded as the work of a priest of Liège, named Amelgard, but it is now practically certain that Basin was the writer. He also wrote a suggestion for reform in the administration of justice entitled *Libellus de optimo ordine forenses lites audiendi et deferendi*; an *Apologia*, written to answer the charges brought against him by Louis XI.; a *Breviloquium*, or allegorical account of his own misfortunes; a *Peregrinatio*; a defence of Joan of Arc entitled *Opinio et consilium super processu et condemnatione Johanne, dicte Puellae, and other miscellaneous writings*. He wrote in French, *Advis de Monseigneur de Lysieux au roi* (Paris, 1677).

See the edition of the *Historiae*, by J. E. J. Quicherat (Paris, 1855-1859); also G. du Fu. de Beaucour, *Charles VII et Louis XI d'après Thomas Basin* (Paris, 1858).

BASIN, or BASON (the older form *basin* is found in many of the Romanic languages, from the Late Lat. *baccinus* or *bacchinus*, probably derived from *bacca*, a bowl), a round vessel for holding liquids. Hence the term has various technical uses, as of a dock constructed with flood-gates in a tidal-river, or of a widening in a canal for unloading barges; also, in physical geography, of the drainage area of a river and its tributaries.

In geology, "basin" is equivalent to a broad shallow syncline, i.e. it is a structure proper to the bed rock of the district covered by the term; it must not be confused with the physiographic river basin, although it occasionally happens that the two coincide to some extent. Some of the better known geological basins in England are, the *London basin*, a shallow trough or

syncline of Tertiary, Cretaceous and Jurassic rocks; the *Hampshire basin*, of similar formations; and the numerous *coal basins*, e.g. the S. Wales coalfield, the Forest of Dean, N. Staffordshire coalfield, &c. The *Paris basin* is made of strata similar to those in the London and Hampshire basins. Strictly speaking, a structural basin is formed of rock beds which exhibit a *centro-dinal* dip; an elongated narrow syncline or trough is not a basin. "Rock-basins" are comparatively small, steep-sided depressions that have been scooped out of the solid rock in mountainous regions, mainly through the agency of glaciers (see CIRQUE). Lakes sometimes occupy basins that have been caused by the removal in solution of some of the more soluble constituents (rock salt, &c.) in the underlying strata; occasionally lake basins have been formed directly by crustal movements.

BASINET (a diminutive of "basin"), a form of helmet or headpiece. The original small basinet was a light open cap, with a peaked crown. This was used alternately to, and even in conjunction with, the large heavy heaume. But in the latter half of the 13th century the basinet was developed into a complete war head-dress and replaced the heaume. In this form it was larger and heavier, had a vizor (though not always a pivoted vizor like that of the later armet), and was connected with the gorget by a "camail" or mail hood, the head and neck thus being entirely covered. It is always to be recognized by its peaked crown. The word is spelt in various forms, "bassinnet," "bascinet," "bacinet," or "basnet." The form "bassinnet" is used for the hooded wicker cradle or perambulator for babies.

BASINGSTOKE, a market-town and municipal borough of Hampshire, England, 48 m. W.S.W. from London by the London & South-Western railway; served also by a branch of the Great Western railway. Pop. (1901) 9793. The church of St Michael and All Angels is a fine specimen of a late Perpendicular building (principally of the time of Henry VIII.). The chapel of the Holy Ghost is a picturesque ruin, standing in an ancient cemetery, built for the use of the local gild of the Holy Ghost which was founded in 1525, but flourished for less than a century. Close to the neighbouring village of Old Basing are remains of Basing House, remarkable as the scene of the stubborn opposition of John, fifth marquis of Winchester, to Cromwell, by whom it was taken after a protracted siege in 1645. A castle occupied its site from Norman times. Numerous prehistoric relics have been discovered in the district, and a large circular encampment is seen at Winklebury Hill. Basingstoke has considerable agricultural trade, and brewing, and the manufacture of agricultural implements, and of clothing, are carried on. The Basingstoke canal, which connects the town with the river Wey and so with the Thames, was opened about 1794, but lost its trade owing to railway competition. It was offered for sale by auction unsuccessfully in 1904, but was bought in 1905. The municipal borough is under a mayor, four aldermen and twelve councillors. Area, 4195 acres.

Basingstoke is a town of great antiquity, and excavations have brought to light undoubted traces of Roman occupation. The first recorded historical event relating to the town is a victory won here by Æthelred and Alfred over the Danes in 871. According to the Domesday survey it had always been a royal manor, and comprised three mills and a market. A charter from Henry III. in 1256 granted to the men of Basingstoke the manor and hundred of that name and certain other privileges, which were confirmed by Edward III., Henry V. and Henry VI. As compensation for loss sustained by a serious fire, Richard II. in 1392 granted to the men of Basingstoke the rights of a corporation and a common seal. A charter from James I. dated 1622 instituted two bailiffs, fourteen capital burgesses, four justices of the peace, a high steward and under steward, two serjeants-at-law and a court of record. Charles I. in 1641 changed the corporation to a mayor, seven aldermen and seven burgesses. Basingstoke returned two members to parliament in 1295, 1302 and 1306, but no writs are extant after this date. In 1202-1203 the market day was changed from Sunday to Monday, but in 1214 was transferred to Wednesday, and has not since been

changed. Henry VI. granted a fair at Whitsun to be held near the chapel of the Holy Ghost. The charter from James I. confirmed another fair at the feast of St Michael the Archangel, and that of Charles I. granted two fairs on Basingstoke Down at Easter and on the 10th and 11th of September. The wool trade flourished in Basingstoke at an early date, but later appears to have declined, and in 1631 the clothiers of Basingstoke were complaining of the loss of trade and consequent distress.

See *Victoria County History—Hants*: F. G. Baigent and J. E. Millard, *History of Basingstoke* (Basingstoke, 1889).

BASIN-STAND, a piece of furniture consisting of a small stand, usually supported on three legs, and most commonly made of mahogany or rosewood, for holding a wash-hand basin. The smaller varieties were used for rose-water ablutions, or for the operation of hair-powdering. The larger ones, which possessed sockets for soap-dishes, were the predecessors of the ample modern wash-hand stand. Both varieties, often of very elegant form, were in extensive use throughout a large part of the 18th century.

BASKERVILLE, JOHN (1706-1775), English printer, was born at Wolverley in Worcestershire on the 28th of January 1706. About 1726 he became a writing master at Birmingham, and he seems to have had a great talent for calligraphy and for cutting inscriptions in stone. While at Birmingham he made some important improvements in the process of japanning, and gained a considerable fortune. About the year 1750 he began to make experiments in type-founding, producing types much superior in distinctness and elegance to any that had hitherto been employed. He set up a printing-house, and in 1757 published his first work, a *Virgil* in royal quarto, followed, in 1758, by his famous edition of Milton. In that year he was appointed printer to the university of Cambridge, and undertook editions of the Bible and the Book of Common Prayer. The *Horace*, published in 1762, is distinguished even among the productions of the Baskerville press for its correctness and for the beauty of the paper and type. A second *Horace* appeared in 1770 in quarto, and its success encouraged Baskerville to publish a series of quarto editions of Latin authors, which included Catullus, Tibullus, Propertius, Lucretius, Terence, Sallust and Florus. This list of books issued by Baskerville from his press lends some irony to the allegation that he was a person of no education. These books are admirable specimens of typography; and Baskerville is deservedly ranked among the foremost of those who have advanced the art of printing. His contemporaries asserted that his books owed more to the quality of the paper and ink than to the type itself, but the difficulty in obtaining specimens from the Baskerville press shows the estimation in which they are now held. His wife, Sarah Baskerville, carried on the business for some time after his death, which took place on the 8th of January 1775.

BASKET, a vessel made of twigs, cane or rushes, as well as of a variety of other materials, interwoven together, and used for holding, protecting or carrying any commodity. The process of interweaving twigs, rushes or leaves, is practised among the rudest nations of the world; and as it is one of the most universal of arts, so also does it rank among the most ancient industries, being probably the origin of all the textile arts of the world. Decorative designs in old ceramic ware are derived from the marks left by the basket mould used before the invention of the potter's wheel, and in the willow pattern on old china, and the basket capitals or mouldings of Byzantine architecture, the influence of the basketmaker's art is clearly traceable. Essentially a primitive craft, its relative importance is in inverse ratio to the industrial development of a people.

The word "basket" has been generally identified with the Latin *bascuda*, as in Martial (xvi. 99):—

"Barbara de pictis veni bascuada Britannis:
Sed me iam mavult dicere Roma suam."

But its etymology is unknown, and the *New English Dictionary* states that there is no evidence to connect basket with *bascuda*, which denotes rather a tub, tray or brazen vessel.

Among many uncivilized tribes, baskets of a superior order are made and applied to various useful purposes. The North American Indians prepare strong water-tight *Wallapa* baskets from the roots of a species of *abies*, and these they frequently adorn with very pretty patterns made from the dyed quills of their native porcupine, *Erethizon dorsatum*. Wealthy Americans have formed collections of the beautiful ware treasured as heirlooms in Indian families, and large prices have been paid for baskets made by the few squaws who have inherited the traditions and practice of the art, as much as £300 having been given for one specimen. It has been computed that baskets to the value of £1,000,000 were recently drawn from California and Arizona within two years. The Indians of South America weave baskets equally useful from the fronds of the Carnahuba and other palms. The Kaffirs and Hottentots of South Africa are similarly skilful in using the Ilala reed and the roots of plants; while the Abyssinians and the tribes of Central Africa display great adroitness in the art of basket-weaving.

Basket-making, however, has by no means been confined to the fabrication of those simple and useful utensils from which its name is derived. Of old, the shields of soldiers were fashioned of wicker-work, either plain or covered with hides. Xenophon, in his story of the Thirty Tyrants at Athens, relates that the exiled Greeks who had seized on the Peiraeeus made themselves shields of whitened osiers; and similar weapons of defence are still constructed by modern savages. The huts of the earliest settlers in Rome and in western Europe generally were made of osier work plastered with clay. Some interesting remains of British dwellings of this nature found near Lewes in 1877 were described by Major-General H. L. F. Pitt-Rivers in *Archæologia*, vol. xvi. pp. 456-458. Boats of the same material, covered with the skins of animals, attracted the notice of the Romans in Britain; they seem to have been of the ordinary boat-shape. The basketwork boats mentioned by Herodotus as being used on the Tigris and Euphrates were round and covered with bitumen. Boats of this shape are still used on these rivers, and boats of analogous construction are employed in crossing the rivers of India, in which the current is not rapid. Nor have methods of making much changed. The strokes employed in the construction of basket-work found in Etruscan tombs and now exhibited in the Museo Etrusco at Florence, and in similar articles discovered in Egyptian tombs, are the same as those used by the English basket-maker to-day. General Pitt-Rivers, on comparing the remains excavated near Lewes with a modern hamper in his possession, found the method to be identical.

Since about the middle of the 19th century the character of basket-work in England has been greatly modified. The old English cradle, reticule, and other small domestic wares, have been driven out of the market by cheap goods made on the continent of Europe, and the coarse brown osier packing and hampers have been largely superseded by rough casks and cases made from cheap imported timber. This loss has, however, been more than counterbalanced by the production of work of a higher class, such as finely made chairs, tables, lounges and other articles of furniture; luncheon and tea-baskets and similar requisites of travel. In addition to the foregoing the chief categories of English manufacture are: vegetable and fruit baskets, transit and travelling hampers, laundry and linen baskets, partition baskets for wine, and protective wicker cases for fragile ware such as glass carboys, stone and other bottles. Wicker shields or cases made from cane pith, for the protection of shells, have been introduced by the English military authorities. Some evidence of the above-mentioned developments is afforded by a comparison of the wages lists of the London Union of Journeymen Basketmakers issued in 1865 and in 1866. The former consists of 87 printed pages; the latter of 144 pages, and these more closely set.

No machinery is used in basket-making. A considerable training and natural aptitude go to form the expert workman, for the ultimate perfection of shape and beauty of texture depend upon the more or less perfect conception of form in the

craftsman's mind and on his power to impress it on a recalcitrant material. In England at least, he rarely uses a mould; every stroke made has a permanent effect on the symmetry of the whole work and no subsequent pressure will alter it. Wages in London vary from 25s. to 50s. per week according to aptitude. The Basketmakers' Company is one of the oldest craft guilds of the city of London and still exists.

Employment is given by the London Association for the Welfare of the Blind to a number of partially or wholly blind workpeople, who are engaged in the making of some of the coarser kinds of baskets; but the work, which bears obvious traces of its origin, is not commercially remunerative, and the association depends for partial support on the contributions of the charitable, and on supplementary sales of fine or fancy work produced under ordinary conditions and largely imported. Similar associations exist in some English provincial towns, in Edinburgh, in Dublin and Belfast, and in certain European cities.

The materials which are actually employed in the construction of basket-work are numerous and varied, but it is from certain species of willow that the largest supply of basket-making materials is produced. Willows for basket-work are extensively grown on the continent of Europe, whence large quantities are exported to Great Britain and the United States; but no rods surpass those of English growth for their tough and leathery texture, and the finest of basket-making willows are now cultivated in England—in Leicestershire, Nottinghamshire and the valleys of the Thames and the Trent. In the early part of the 19th century, considerable attention was given in Britain to the cultivation of willows suitable for basket-making, and the industry was first stimulated by premiums offered by the Society of Arts. Mr William Scaling of Basford, Notts, was a most successful grower and published some admirable pamphlets on the cultivation of willows. The most extensive English willow plantation or salicetum (Lat. *salix*, willow) of the present day is that planted by Mr W. P. Ellmore at Thurmaston near Leicester, and consists of about 100 acres of the finest qualities. Mr Ellmore, a practical basket-maker, successfully introduced some valuable continental varieties (see OSIER).

Willows are roughly classed by the basket-maker into "osier" and "fine." The former consists of varieties of the true osier, *Salix viminalis*; the latter of varieties of *Salix triandra*, *S. purpurea* and some other species and hybrids of tougher texture. For the coarsest work, dried unpeeled osiers, known as "brown stuff," are used; for finer work, "white (peeled) stuff" and "buff" (willows stained a tawny hue by boiling them previous to peeling). Brown stuff is sorted, before it reaches the workman, into lengths varying from 3½ ft. to 8 or 10 ft., the smallest being known in London and the home counties as "luke," the largest as "great," and the intermediate sizes as "long small," "threepenny" and "middleboro." White and buff rods are more carefully sorted, the smallest, about 2 ft. or less, being known as "small tack," and rising sizes as "tack," "short small," "small," "long small," "threepenny," "middleboro" and "great." Rods of two to three years' growth, known as "sticks," are used to form the rigid framework of the bottoms and lids of square work. In every case, except the last, the stuff is soaked in tanks to render it pliable before use—brown from three to seven days, white and buff from half-an-hour to half a day. The rods are used whole for ordinary work, but for baskets of slight and finer texture each is divided into "skins" of different degrees of size. "Skins" are osiers cleft into three or four parts, by means of an implement called a "cleaver," which is a wedge-shaped tool of boxwood inserted at the point or top end of the rod and run down through its entire length. They are next drawn through an implement resembling the common spokeshave, keeping the grain of the split next the iron or stock of the shave, while the pith is presented to the steel edge of the instrument, and in order to bring the split into a shape still more regular, it is passed through another implement called an upright, consisting of a flat piece of steel, each end of which is fashioned into a cutting edge, like that of an ordinary

chisel and adjusted to the required width by means of a thumb-screw.

The tools required by a basket-maker are few and simple. They consist, besides the foregoing, of a shop-knife for cutting out material; a picking knife for cutting off the protruding butts and tops of the rods after the work is completed; two or three bodkins of varying sizes; a flat piece of iron somewhat narrowly triangular in shape for driving the work closely together; a stout pair of shears and a "dog" or "commander" for straightening sticks. The employer supplies a screw block or vice for gripping the bottom and cover sticks of square work, and a lapboard on which the workman fixes the upsetted bottom while sliding up the basket. This is the full kit. A common round or oval basket may, however, be made with no other tools than a shop-knife and a bodkin. On the continent of Europe shapes or blocks are in use on which the fabric is in some cases woven.

The technicalities of basket-making may be easily followed by a glance at the illustration here reproduced by the courtesy of the Society of Arts.¹ It will be seen that the "bye-stakes" are merely inserted in the "upsett," whereas the stakes are driven in at each side of the "bottom-sticks" and pricked up to form the rigid framework of the side. When the "bottom-stick" and "stake" are formed of one and the same continuous rod, it is termed a "league." If the bottom is made on a hoop the butts of the stakes are "slipped," i.e. cut away with a long cut of the shop-knife, and turned tightly round the hoop; they are then said to be "scalomed" on. The chief strokes used in constructing an ordinary basket are:—the "slew"—two or more rods woven together;

the "rand," rods woven in singly; the "fitch," two rods tightly worked alternately one under the other, employed for skeleton work such as cages and waste-paper baskets; the "pair," two rods worked alternately one over the other, used for filling up bottoms and covers of round and oval baskets; and the "wale," three or more rods worked alternately, forming a string or binding course. Various forms of plaiting, roping and tracking are used for bordering off or finishing.

An ordinary oval basket is made by preparing the requisite number of bottom sticks, preserving their length greater than the required width of the bottom. They are ranged in pairs on the floor parallel to each other at small intervals, in the direction of the longer diameter of the basket, thus forming what may be called the "woof," for basket-work is literally a web. These parallel rods are then crossed at right angles by two pairs of the largest osiers, on the butt ends of which the workman places his feet; and they are confined in their places by being each woven alternately over and under the parallel pieces first laid down and their own butts which form the end bottom sticks. The whole now forms what is technically called the "slath," which is the foundation of the basket. Next other rods are taken and

¹ See the report of a paper by T. Okey, published in the *Journal of the Society of Arts*, January 11th, 1907.

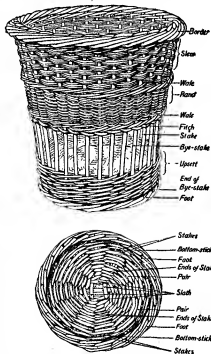

woven under and over the sticks all round the bottom until it be of sufficient size, and the woof be occupied by them. Thus the bottom or foundation on which the superstructure is to be raised is finished. This latter part is accomplished by sharpening the large ends of as many long and stout osiers as may be necessary to form the stakes or skeleton. These are forced between the bottom sticks from the edge towards the centre, and are turned up or "upset" in the direction of the sides; then other rods are woven in and out between each of them, until the basket is raised to the intended height, or, more correctly speaking, the depth it is to receive. The edge or border is finished by turning down the ends of the stakes, now standing up, behind and in front of each other, whereby the whole is firmly and compactly united, and it is technically known as the "belly." A lid is constructed on the same plan as that of the bottom, and tied on with hinges formed of twisted rods; simple handles may be made by inserting similar rods by the sides of two opposite stakes and looping them under the border to form rope-like handles of three strands. This is the most simple kind of basket, from which others differ only in being made with finer materials and in being more nicely executed; but in these there is considerable scope for taste and fancy, and articles are produced of extreme neatness and ingenuity in construction.

In addition to willows many other materials are employed in the fabrication of wicker-work. Among the more important of these is the stem of *Calamus viminalis* or other allied species—the cane or rattan of commerce—which is used whole or made into skains. Since 1880 the central pith of this material, known as "cane-pulp" or "cane-pith," has been largely used in Great Britain and on the continent of Europe in the manufacture of furniture and other finer classes of work. About the same period plaited rush and straw, often coloured, came into use together with enamelled skains of cane. It must be admitted, however, that basket-work in these developments has encroached somewhat on the domain of cabinet-making; for wood and nails are now much used in constructing basket-work chairs, tables and other furniture.

With splits of various species of bamboo the Japanese and Chinese manufacture baskets of unequalled beauty and finish. The bamboo wicker-work with which the Japanese sometimes encase their delicate egg-shell porcelain is a marvellous example of manipulation, and they and the Chinese excel in the application of bamboo wicker-work to furniture. In India "Cajan" baskets are extensively made from the fronds of the Palmyra palm, *Borassus flabelliformis*, and this manufacture has been established in the Black Forest of Germany, where it is now an important and characteristic staple. Among the other materials may be enumerated the odorous roots of the khus-khus grass, *Anatherum muricatum*, and the leaves of various species of screw pine, used in India and the East generally. The fronds of the palm of the Seychelles, *Lodoicea sechellarum*, are used for very delicate basket-work in those islands. Strips of the New Zealand flax plant, *Phormium tenax*, are made into baskets in New Zealand. Esparto fibre is used in Spain and Algeria for rude fruit baskets. Various species of *Moranta* yield basket materials in the West Indies and South America; and the *Tivite*, a species of *Calathea*, a member of the order *Zingiberaceae*, is also employed similarly in Trinidad. Baskets are also frequently made from straw, from various sedges (*Cyperus*), and from shavings and splints of many kinds of wood.

The chief centres of English basket manufacture outside London are Thurmaston near Leicester, Basford near Nottingham, and Grantham. Large but decreasing quantities of light basket-work are made for the English market in Verdun, in the department of the Aisne, and in other parts of France; and great quantities of fancy and other work are produced in Belgium, in the Netherlands and in Germany, notably at Lichtenfels in Bavaria, at Sonnefeld in Saxony and in the Black Forest.

The import and export values of baskets and basket-ware, and of willows and rods for basket-making, have been enumerated in the Board of Trade returns for the United Kingdom since 1900, in which

year basket-ware from foreign countries was imported to the value of £239,402. In 1901 the imports increased to £264,183; then they declined to £227,070 in 1905. The main sources of supply are shown in this comparison of 1900 and 1905:—

	1900.	1905.	
Belgium	£72,031	£77,766	+£5,735
Holland	58,214	54,407	- 3,807
France	55,870	27,910	-27,960
Germany	33,155	22,892	-10,263
Japan	8,149	25,536	+17,387
Portugal	5,066	3,971	-1,095

The increase from Japan (for 1904 the value was £52,377) and the decrease from France are remarkable.

The import values of foreign willows increased from £52,219 in 1900 to £62,286 in 1905, the most important exporting countries being:—

	1900.	1905.	
Germany	£22,594	£34,752	+£12,158
Belgium	18,800	11,864	- 6,936
Holland	9,771	12,750	+ 2,979

Small British re-exports of willows (£1808 in 1900 and £371 in 1905) and of baskets (£3785 in 1900 and £6633 in 1905) to foreign parts and British possessions are tabulated. No particulars of exports of British produce and manufacture are specified in the returns. (T. O.)

BASKET-BALL, a game adapted to the open air, but usually played upon the floor of a gymnasium and in the cold season. It was the invention, in 1801, of James Naismith, an instructor in the gymnasium of the Young Men's Christian Association training-school at Springfield, Massachusetts. A demand had arisen for a game for the gymnasium class, which would break the monotony and take the place, during the winter months, of football and baseball, and which was not too rough to be played indoors. The idea of the game was first published in the *Triangle*, the school paper. It soon became one of the most popular indoor games of America, for girls as well as for men, and spread to England and elsewhere.

Basket-ball is played on a marked-off space 60 ft. by 40 ft. in extent, though in the open air the dimensions may be greater. In the middle of each short side and 10 ft. above the floor or ground, is placed a basket consisting of a net suspended from a metal ring 18 in. in diameter, backed, at a distance of 6 in., by a back-board 6 ft. long and 4 ft. high. The object of the game is to propel an inflated, leather-covered ball, 30 in. in circumference, into the opponents' basket, which is the goal, by striking it with the open hands. The side wins that scores most goals during two periods of play divided by an interval of rest. Although there is practically no limit to the number of players on each side, all indoor matches are played by teams of five, in positions opposing one another as in lacrosse, centre, right and left forwards and right and left guards (or backs). A referee has the general supervision of the game and decides when goals have been properly scored, and an umpire watches for infringements of the rules, which constitute *fouls*. There are also a scorer and timekeeper.

The game is started with the two opposing centres standing within a 4-foot ring in the middle of the floor. The referee puts the ball in play by tossing it into the air over the heads of the centres, who jump into the air for its possession or endeavour to bat it towards the opposing goal. From this moment the ball is in play until it falls into a basket, or passes the boundary-lines, or a foul is made. After a goal has been scored, the ball is again put in play by the referee in the centre. Should it be thrown across the boundary, a player of the opposing side, standing on the line at the point where the ball went over, puts it in play by passing or throwing it to one of his own side in any direction, there being no off-side rule—another point of similarity to lacrosse. His opponents, of course, try to prevent the pass or intercept the throw, thus securing the ball themselves. When a foul has been called, a player of the opposing side is allowed a "free throw" for his opponents' basket from a mark 15 ft. distant from it and without interference. A goal scored from a

free throw counts one point; one scored while the ball is in play counts two. Hacking, striking, holding and kicking are foul, but a player may interfere with an opponent who has the ball so long as he uses one arm only and does not hold. A player must throw the ball from where he gets it, no running with it being allowed excepting when continuously bounding it on the floor. Basket-ball is an extremely fast game and admits of a high degree of combination or team-play. The principal qualifications of a good player are quickness of movement and of judgment, coolness, endurance, accuracy and self-control. Good dodging, throwing, passing and team-play are the important requisites of the game, which is looked upon as excellent winter training for outdoor games. Basket-ball, with somewhat modified rules, is extremely popular with young women.

See *Spalding's Basket-Ball Guide*; and George T. Hepburn, *How to Play Basket-Ball*; and *Spalding's Basket-Ball Guide for Women*.

BASNAGE, JACQUES (1653-1723), French Protestant divine, was the eldest son of the eminent lawyer Henri Basnage, sieur de Franquenay (1615-1695), and was born at Rouen in Normandy in 1653. He studied classical languages at Saumur and afterwards theology at Geneva. He was pastor at Rouen (his native place) from 1676 till 1685, when, on the revocation of the edict of Nantes, he obtained leave of the king to retire to Holland. He settled at Rotterdam as a minister pensionary till 1691, when he was chosen pastor of the Walloon church. In 1709 the grand pensionary A. Heinsius (1641-1720) secured his election as one of the pastors of the Walloon church at the Hague, intending to employ him mainly in civil affairs. Accordingly he was engaged in a secret negotiation with Marshal d'Uxelles, plenipotentiary of France at the congress of Utrecht—a service which he executed with so much success that he was entrusted with several important commissions, all of which he discharged with great ability. In 1716 Dubois, who was at the Hague at the instance of the regent Orleans, for the purpose of negotiating the Triple Alliance between France, Great Britain and Holland, sought the advice of Basnage, who, in spite of the fact that he had failed to receive permission to return to France on a short visit the year before, did his best to further the negotiations. The French government also turned to him for help in view of the threatened rising in the Cevennes. Basnage had welcomed the revival of the Protestant church due to the zeal of Antoine Court; but he assured the regent that no danger of active resistance was to be feared from it, and, true to the principles of Calvin, he denounced the rebellion of the Camisards (*q.v.*) in his *Instructions pastorales aux Réformés de France sur l'obéissance due aux souverains* (Paris, 1720), which was printed by order of the court and scattered broadcast in the south of France. Basnage died on the 22nd of September 1723.

Basnage was a good preacher and a prolific writer. His works include several dogmatic and polemical treatises, but the most important are the historical. Of these may be mentioned *Histoire de la religion des églises réformées* (Rotterdam, 1690), the *Histoire de l'église depuis Jésus-Christ jusqu'à présent* (*ib.* 1699)—both of them written from the point of view of Protestant polemics—and, of greater scientific value, the *Histoire des Juifs* (Rotterdam, 1706, Eng. trans. 1708) and the *Antiquités judaïques ou remarques critiques sur la république des Hébreux* (1713). He also wrote short explanatory introductions and notes to a collection of copper-plate engravings, much valued by connoisseurs, called *Histoires du Vieux et du Nouveau Testament, représentées par des figures gravées en taille-douce par R. de Hooge* (Amsterdam, 1704).

BASOCHE, or BASOCHE, with the analogous forms **BASOQUE, BASOQUE** and **BAZOGUES**; from the Lat. *basilica*, in the sense of law courts, a French gild of clerks, from among whom legal representatives (*procureurs*) were recruited. This gild was very ancient, even older than the gild of the *procureurs*, with which it was often at variance. It dated, no doubt, from the time when the profession of *procureur* (procurator, advocate or legal representative) was still free in the sense that persons rendering that service to others when so permitted by the law were not yet public and ministerial officers. For this purpose there was

established near each important juridical centre a group of clerks, that is to say, of men skilled in law (or reputed to be so), who at first would probably fill indifferently the rôles of representative or advocate. Such was the origin of the Basoche of the parlement of Paris; which naturally formed itself into a gild, like other professions and trades in the middle ages. But this organization eventually became disintegrated, dividing up into more specialized bodies: that of the advocates, whose history then begins; and that of legal representatives, whose profession was regularized in 1344, and speedily became a saleable charge. The remnant of the original clerks constituted the new Basoche, which thenceforward consisted only of those who worked as clerks for the procureurs, the richer ones among them aspiring themselves to attain the position of procureur. They all, however, retained some traces of their original conditions. "They are admitted," writes an 18th-century author, "to plead before M. le lieutenant civil sur les référés¹ and before M. le juge auditeur; so that the procureurs of these days are but the former clerks of the Basoche, admitted to officiate in important cases in preference to other clerks and to their exclusion." From its ancient past the Basoche had also preserved certain picturesque forms and names. It was called the "kingdom of the Basoche," and for a long time its chief, elected each year in general assembly, bore the title of "king." This he had to give up towards the end of the 16th century, by order, it is said, of Henry III., and was thenceforth called the "chancellor." The Basoche had besides its *maîtres des requêtes*, a grand court-crier, a referendary, an advocate-general, a *procureur-général*, a chaplain, &c. In early days, and until the first half of the 16th century, it was organized in companies in a military manner and held periodical reviews or parades (*montres*), sometimes taking up arms in the king's service in time of war. Of this there survived later only an annual *cavalcade*, when the members of the Basoche went to the royal forest of Bondy to cut the maypole, which they afterwards set up in the court-yard of the Palais. We hear also of satirical and literary entertainments given by clerks of the Palais de Justice, and of the moralities played by them in public, which form an important element in the history of the national theatre; but at the end of the 16th century these performances were restricted to the great hall of the Palais.

To the last the Basoche retained two principal prerogatives. (1) In order to be recognized as a qualified procurer it was necessary to have gone through one's "stage" in the Basoche, to have been entered by name for ten years on its register. It was not sufficient to have been merely clerk to a procureur during the period and to have been registered at his office. This rule was the occasion of frequent conflicts during the 17th and 18th centuries between the members of the Basoche and the procureurs, and on the whole, despite certain decisions favouring the latter, the parlement maintained the rights of the Basoche. Opinion was favourable to it because the *certificats de complaisance* issued by the procureurs were dreaded. These *certificats* held good, moreover, in places where there was no Basoche. (2) The Basoche had judiciary powers recognized by the law. It had disciplinary jurisdiction over its members and decided personal actions in civil law brought by one clerk against another or by an outsider against a clerk. The judgment, at any rate if delivered by a *maître des requêtes*, was authoritative, and could only be contested by a civil petition before the ancient council of the Basoche. The Châtelet of Paris had its special basoche, which claimed to be older even than that of the Palais de Justice, and there was contention between them as to certain rights. The clerks of the procureurs at the *cour des comptes* of Paris had their own Basoche of great antiquity, called the "empire de Galilée." The Basoche of the Palais de Justice had in its ancient days the right to create provostships in localities within the jurisdiction of the parlement of Paris, and thus there sprang up a certain number of local basoches. Others were independent in origin; among such being the "regency" of Rouen and the Basoche of the parlement of Toulouse.

¹ A procedure for obtaining a provisional judgment on urgent cases.

See also *Répertoire de Jurisprudence des Guyot; Recueil des Statuts du royaume de la basque* (Paris, 1654); L. A. Fabre, *Études historiques sur les clercs de la basque* (Paris, 1856). (J. P. E.)

BASQUE PROVINCES (*Provincias Vascongadas*), a division of north-eastern Spain, comprising the three provinces of Álava, Biscay or Vizcaya and Guipúzcoa. Pop. (1900) 603,596; area 2739 sq. m., the third in density in Spain. The territory occupied by the Basque Provinces forms a triangle bounded on the west and south by the provinces of Santander, Burgos and Logroño, on the east by Navarre, on the north by France and the Bay of Biscay. The French Pays Basque forms part of the arrondissements of Bayonne and Mauléon. For an account of the people, their origin, customs and language, see **BASQUES**. Of the Provinces, Guipúzcoa is the only one which is wholly Basque, Álava is the least so. Its capital, Vitoria, is said to have been founded by the Gothic king Leovigild (581). Older than these divisions, the date of which is uncertain, the ancient limits of the dioceses of Pamplona, Bayonne and Calahorra, probably corresponded more nearly to the boundaries of the ancient tribes, the Autrigones, the Caristi, the Varduli and the Vascones, with their still differing dialects, than do these civil provinces.

Leaving aside the legendary and uncertain portion of their history, we find the Provinces in some districts dependent allies of Navarre, in others of Castile. In Biscay the counts of Haro were lords of Biscay from 1093 to 1350. There was a short union with Castile under Pedro the Cruel, but the definitive union did not take place till 1370. In Álava the ruling power was the confederation of Arriaga (so called after its meeting place), which united the province to the crown of Castile in 1332. Guipúzcoa, which had been dependent sometimes on Navarre, sometimes on Castile, was definitively united to Castile in 1200. From the year 1425 the provinces were desolated by party wars among the lesser nobles (*parientes mayores*) but these came to an end in 1460-1498, when Henry IV. and Ferdinand—the Catholic strengthened the power of the towns and forbade the erection of any fortified house in the country. Though the three Basque Provinces were thus united to the crown of Spain, they still remained a land apart (*tierra apartada*). Their juntas acted to some extent in common; and although no written federal pact is known to have existed, they employed, as the symbol of their unity, a seal with the word *Iruracabal*, "The Three One," engraved upon it. They preserved their own laws, customs, *fueros* (see **BASQUES**), which the Spanish kings swore to observe and maintain. Unless countersigned by the juntas the decrees of Cortes and Spanish legislation or royal orders had no force in the Provinces. In the junta of 1481 Guipúzcoa alone proposed a treaty of friendship, peace and free trade for ten years with England, and this was signed in Westminster, on the 6th of March 1482 (see Rymer, *Foedera*). The Basques still made their own treaties with England and France and are mentioned apart from Spain in the treaty of Utrecht (1713). They still preserved in their municipal institutions the old style of *republicas* derived from the *civitates* and *respublicae* of ancient Rome. This kind of independence and autonomy lasted unchallenged until the death of Ferdinand VII. in 1833, when, in default of male heirs, his brother Don Carlos claimed the throne, confirmed the Basque *fueros*, and raised the standard of revolt against his niece, Isabel II. A seven years' war followed, in which an English legion under Sir George de Lacy Evans and a naval force under Lord John Hay took part. It was ended by the Convenio de Vergara (August 31st, 1839) in which the concession and modification of the *fueros* was demanded. The troubled period which followed the expulsion of Isabel II. in 1868 gave opportunity for a second Carlist war from 1872 to 1876. This ended, unlike the former one, in the utter defeat of the Carlist forces, and left the Provinces at the mercy of the government, without terms or agreement. In general government and legislation the Provinces were then assimilated to the rest of the nation. After 1876, the Provincial parliaments (*diputaciones*) were elected like the other provincial councils of Spain, deprived of many privileges and subjected to the ordinary interference of the civil governors. But their representatives,

assisted by the senators and deputies of the Basque Provinces in the Cortes, negotiated successive pacts, each lasting several years, securing for the three Provinces their municipal and provincial self-government, and the assessment, distribution and collection of their principal taxes and octroi duties, on the understanding that an agreed sum should be paid annually to the state, subject to an increase whenever the national taxation of other provinces was augmented. In December 1906, after long discussion, the contribution of the Basque Provinces to the state, according to the law of the 21st of July 1876, was fixed for the next twenty years; for the first ten years at 8,500,000 pesetas, for the next ten an additional 500,000 pesetas, from 31st December 1916 to 31st December 1926, the province of Guipúzcoa paying in addition 700,000 pesetas to the treasury. These pacts have hitherto been scrupulously observed, and as the local authorities levy the contribution after their own local customs, landed property and the industrial and commercial classes are less heavily taxed in these territories than in the rest of Spain. Enough is raised, however, besides the amount handed over to the government, to enable the schools, roads, harbours and public works of every kind to be maintained at a standard which compares very favourably with other parts of Spain. When the three provinces sent in their first contingent of conscripts in 1877, it was found that all but about sixty knew how to read and write, and succeeding contingents have kept up this high standard.

In agriculture the Basque Provinces and the Pays Basque were great cider countries, but during the 19th century this was gradually replaced by wine-growing. The chief industries of the Basque Provinces are the sea fisheries and iron mining. Some of the mines round Bilbao have been worked from prehistoric times. In 1905 the Basque Provinces produced 5,302,344 tons of iron, over five millions of which came from Biscay, out of a total of 9,395,314 tons for the whole of Spain. More than the half of this total 5,845,895 tons, was exported to England. The swords of Mondragon in Guipúzcoa were renowned before those of Toledo. Eibar in the same province has long been a small-arms factory. There in the 19th century Señor Zuloaga successfully revived the artistic inlaying of gold and silver in steel and iron.

BIBLIOGRAPHY.—Of older works, though often uncritical, R. P. Henao's *Averiguaciones de las Antigüedades de Cantabria* (Salamanca, 1688), is still valuable (new edition, 1894). For all that relates to the manners and customs of the people, *Geografía de Guipúzcoa*, by R. P. M. de Larramendi, S. J., is indispensable. Written about 1750, it was first printed in Barcelona in 1882 (later edition, San Sebastian, 1896). There are excellent chapters on the Basque Provinces in the *Introducción a la Historia Natural, y a la Geografía Física de España*, by D. Guillermo Bowles (Madrid, 1775). *El Guipuzcoano instruido* (San Sebastian, 1780), in the form of a dictionary, gives full details of the life, the rights, duties and obligations of a Basque citizen of that date. The *Diccionario Geográfico-Histórico de España*, tome i., ii. *El Reino de Navarra Señorío de Vizcaya y Provincias de Álava y Guipúzcoa* (Madrid, 1802), is full of local information, but with a strong bias in favour of the central government. The best works on the various editions of the *fueros* are *Historia de la Legislación... civil de España*, by A. Marichalar, Marqués de Montesa, and Cayetano Manrique; *Fueros de Navarra Vizcaya, Guipúzcoa y Álava* (Madrid, 2nd ed., 1868); and *la Noticia de las cosas memorables de Guipúzcoa*, by D. Pablo de Goroalbe (Tolosa, 1899-1901), the last volume of which by C. de Echeagaray, gives the legislative acts down to May 1900. *Las Provincias Vascongadas a Fines de la Edad Media*, by D. Carmelo de Echeagaray (San Sebastian, 1895), is excellent. There is a *Historia de Vizcaya*, by Dr. E. de Labayru, and a *Compendio de la historia de Euzkadi Herria* (Bilbao, 1903). D. Carmelo de Echeagaray, Cronista de las Provincias Vascongadas, with his colleagues D. Serapio Mugica, F. Sorluace, and other historians, has examined, catalogued and indexed the municipal archives of all the towns, without which no true history can be written. Several discoveries of important missing documents and MSS. were thus made. The development of the Basque mining industry is fully described in *Las Minas de hierro de la provincia de Vizcaya, progresos realizados en esta region desde 1870 hasta 1899* (Bilbao, 1900). (W. We.)

BASQUES, a people inhabiting the three Basque Provinces—Biscay, Álava and Guipúzcoa—and Navarre in Spain, and the arrondissement of Bayonne and Mauléon in France. The number of those who can be considered in any sense pure Basques is

probably about 600,000 in Europe, with perhaps 100,000 emigrants in the Americas, chiefly in the region of La Plata in South America. The word Basques is historically derived from *Vascones*, which, written *Wascones*, has also given the name *Gascons* to a very different race. The Basques call themselves *Eskualdunak*, i.e. "those who possess the *Eskuara*," and their country *Eskual-Herria*.

Language.—The original and proper name of the language is *Eskura* (*cuskara*, *uskara*), a word the exact meaning of which has not yet been ascertained, but which probably corresponds with the idea "clearly speaking." The language is highly interesting and stands as yet absolutely isolated from the other tongues of Europe, though from the purely grammatical point of view it recalls the Magyar and Finnic languages. It is an agglutinative, incorporating and polysynthetic system of speech; in the general series of organized linguistic families it would take an intermediate place between the American on the one side and the Ugro-Altai or Ugrian on the other.

Basque has no graphic system of its own and uses the Roman character, either Spanish or French; a few particular sounds are indicated in modern writings by dotted or accented letters. The alphabet would vary according to the dialects. Prince L. L. Bonaparte counts, on the whole, thirteen simple vowels, thirty-eight simple consonants. Nasal vowels are found in some dialects as well as "wet" consonants—*ty*, *dy*, *ny*, &c. The doubling of consonants is not allowed and in actual current speech most of the soft consonants are dropped. The letter *r* cannot begin a word, so that *rationem* is written in Basque *arrazoin*.

Declension is replaced by a highly developed postpositional system; first, the definite article itself *a* (plural *ak*) is a postposition—*zaldi*, "horse," *zaldia* "the horse," *zaldiak*, "the horses." The declensional suffixes or postpositions, which, just like our prepositions, may be added to one another, are postponed to the article when the noun is definite. The principal suffixes are *k*, the mark of the plural, and of the singular nominative agent; *n*, "of" and "in"; *i*, "to"; *z*, "by"; *ik*, "that"; *ko*, "from"; "of" (Lat. *ad*); *tik*, "from" (Lat. *ex*); *soa*, *kotsat*, *taoko*, "for"; *kin*, *guz*, "with"; *gaitik*, "for the sake of"; *gana*, "towards"; *ra*, *rat*, "to," "into," "at," &c. Of these suffixes some are joined to the definite, others to the indefinite noun, or even to both.

The personal pronouns, which to a superficial observer appear closely related to those of the Semitic or Hamitic languages, are *ni*, "I"; *hi*, "thou"; *gu*, "we"; *zu*, "you" in modern times, *zu* has become a polite form of "thou," and a true plural "you" (i.e. more than one) has been formed by suffixing the pluralizing sign *k*—*zuek*. The pronouns of the third person are mere demonstratives. There are three: *hura* or *kura*, "that"; *hau* or *kau*, "this"; *ori* or *kori*, "this" or "that." Other unexplained forms are found in the verbal inflexions, e.g. *d*, *it*, and *i*, "I" or "me"; *d-akus-i*, "it see I"; *d-arrai-i*, "it follows me." The demonstratives are used as articles: *guz-en-or*, "this younger one"; *andre-ori*, "this lady at some distance." The reflective "self" is expressed by *buru*, "head." The relative does not exist, and in its place is used as a kind of verbal participle with the ending *n*: *doa*, "he goes"; *doana*, "he who is going"; in the modern Basque, however, by imitation of French or Spanish, the interrogative *zein*, *zein*, is used as a relative. Other interrogatives are *nor*, "who"; *zer*, "what"; *zembait*, "how much," &c. *Bat*, "one"; *batzu*, "several"; *bakotch*, "each"; *norbait*, "some one"; *hanitz* or *hainitsu*, "much"; *ekar*, "both"; are the most common indefinite pronouns. The numeral system is vicesimal; e.g. 34 is *hogoi ta hamalaur*, "twenty and fourteen." The numbers from one to ten are: 1, *bat*; 2, *bi*; 3, *hiru*; 4, *lau*; 5, *borts* or *bost*; 6, *sei*; 7, *zazpi*; 8, *zortzi*; 9, *bederatsi*; 10, *hamar*; 20, *hogoi* or *hogei*; 40, *berrogoi* (i.e. twice twenty); 100, *ehun*. There is no genuine word for a thousand.

The genders in Basque grammar are distinguished only in the verbal forms, in which the sex of the person addressed is indicated by a special suffix; so that *estakit* means, "I do not know it"; but to a woman one says also: *estakinat*, "I do not

know it, oh woman!" To a man one says: *estakiat* (for *estakikat*), "I do not know it, oh man!" moreover, certain dialectic varieties have a respectful form: *estakiatu*, "I do not know it, you respectable one," from which also a childish form is derived, *estakichut*, "I do not know it, oh child!"

The Basque conjugation appears most complicated, since it incorporates not only the subject pronouns, but, at the same time, the indirect and direct complement. Each transitive form may thus offer twenty-four variations—"he gives it," "he gives it to you," "he gives them to us," &c., &c. Primarily there were two tenses only, an imperfect and a present, which were distinguished in the transitive verb by the place of the personal subject element: *dakigu*, "we are knowing it" (*gu*, i.e. we), and *ginaki*, "we were knowing it"; in the intransitive by a nasalization of the radical: *nia*, "I am"; *ninta*, "I was." In modern times a conjectural future has been derived by adding the suffix *ke*, *dakiket*. "I will, shall or probably can know it." No proper moods, however, but subjunctive or conjunctive forms are formed by adding a final *n*, as *dakusut*, "I am looking at it"; *dakusadan*, "if I see it." No voices appear to have been used in the same radical, so that there are separate transitive and intransitive verbs.

In its present state Basque only employs its regular conjugation exceptionally; but it has developed, probably under the influence of neo-Latin, a most extensive conjugation by combining a few auxiliary verbs and what may be called participles, in fact declined nouns: *ikusten dut*, "I have it in seeing," "I see it"; *ikusko dut*, "I have it to be seen," "I will see it," &c. The principal auxiliaries are: *izan*, "to be"; and *ukan*, "to have"; but *edin*, "to can"; *eza*, "to be able"; *egin*, "to make"; *joan*, "to go"; *eroan*, "to draw," "to move," are also much used in this manner.

The syntax is simple, the phrases are short and generally the order of words is: subject, complement, verb. The determining element follows the determined: *gizon handia*, "man great the"—the great man; the genitive, however, precedes the nominative—*gizonaren etchea*, "the man's house." Composition is common and it has caused several juxtaposed words to be combined and contracted, so that they are partially fused with one another—a process called *polysyntheticism*; *odei*, "cloud," and *ots*, "noise," form *odots*, "thunder"; *belar*, "forehead," and *oin*, "foot," give *belas*, "knee," front of the foot. The vocabulary is poor; general and synthetic words are often wanting; but particular terms abound. There is no proper term for "sister," but *arriba*, a man's sister, is distinguished from *ahispia*, a woman's sister. We find no original words for abstract ideas, and God is simply "the Lord of the high."

The vocabulary, however, varies extremely from place to place and the dialectic varieties are very numerous. They have been summed up by Prince L. L. Bonaparte as eight; these may be reduced to three principal groups: the eastern, comprising the Souletine and the two lower Navarrese; the central formed by the two upper Navarrese, the Guipúzcoan and the Labourdine; and the western, formed by the Biscayan, spoken too in Álava. These names are drawn from the territorial subdivisions, although the dialects do not exactly correspond with them.

Ethnology and Anthropology.—The earliest notices of the geography of Spain, from the 5th century B.C., represent Spain as occupied by a congeries of tribes distinguished mainly as Iberi, Celtiberi and Celts. These had no cohesion together, and unless temporarily united against some foreign foe, were at war with one another and were in constant movement; the ruder tribes being driven northwards by the advancing tide of Mediterranean civilization. The tribes in the south in Baetica had, according to Trogus and Strabo, written laws, poems of ancient date and a literature. Of this nothing has reached us. We have only some inscriptions, legends on coins, marks on pottery and on megalithic monuments, in alphabets slightly differing, and belonging to six geographical districts. These still await an interpreter; but they show that a like general language was once spoken through the whole of Spain, and for a short distance on

the northern slope of the Pyrenees. The character of the letters is clearly of Levant origin, but the particular alphabets, to which each may be referred, and their connexion, if any, with the Basque, are still undetermined. It was early remarked by the classical scholars among the Basques after the Renaissance that certain names in the ancient toponymy of Spain, though transcribed by Greek and Latin writers, *i.e.* by foreigners, ignorant of the language, yet bear a strong resemblance to actual place-names in Basque (*e.g.* *Iliberis*, *Iriberry*); and in a few cases (*Mondicucia*, *Mendigorri*; *Iluo*, *Oloron*) the site itself shows the reason of the name. *Andrés de Poza* (1587), *Larramendi* (1760), *Juan B. Erro* (1806) and others had noted some of these facts, but it was *W. von Humboldt* (1821) who first aroused the attention of Europe to them. This greater extension of a people speaking a language akin to the Basque throughout Spain, and perhaps in Sicily and Sardinia, has been accepted by the majority of students, though some competent Basque scholars deny it; and the certain connexion of the Basques, either with the Iberians or Celtiberians, whether in race or language, cannot be said to be conclusively proved as long as the so-called Celtiberian inscriptions remain uninterpreted. (See also *IBERIANS*.)

After so many centuries of close contact and interpenetration with other peoples, we can hardly expect to find a pure physical type among the present Basques. All that we can expect is to be able to differentiate them from their neighbours. The earliest notice we have of the Basques, by *Einhard* (778), speaks of their wonderful agility. The next, the pilgrim of the *Codex Calixtinus* (12th century), says the Basques are fairer in face (*facie candidiores*) than the Navarrese.

Anthropologists no longer rely solely on craniology, and the measurement of the skull, to distinguish race. The researches of *Aranzadi* (1889 and 1905) and of *Collignon* (1899) show them as less fair than northern Europeans, but fairer than any of the southern races; not so tall as the Scandinavians, Teutons or British, but taller than their neighbours of southern races. There is no tendency to prognathism, as in some of the Celts. The profile is often very fine; the carriage is remarkably upright. Neither markedly brachycephalous nor dolichocephalous, the skull has yet certain peculiarities. In the conjunction of the whole physical qualities, says *Collignon*, there is a Basque type, differing from all those he has studied in Europe and northern Africa. There are differences of type among themselves, yet, when they emigrate to South America, French and Spanish Basques are known simply as Basques, distinct from all other races.

On the origin of the Basques, the chief theories are:—(1) that they are descended from the tribes whom the Greeks and Latins called Iberi; (2) that they belong to some of the fairer Berber tribes ("Eurafrican," *Hervé*) and through the ancient Libyans, from a people depicted on the Egyptian monuments; (3) the Atlantic theory, that they belong to a lost Atlantic continent, whose inhabitants were represented by the Guanches of the Canary Islands, and by a fair race on the western coast of Africa; (4) that they are an indigenous race, who have never had any greater extension than their present quarters.

The remains of prehistoric races hitherto discovered in Spain throw little light on the subject, but some skulls found in south-eastern Spain in the age of metal resemble the Basque skulls of *Zarautz*.

The megalithic remains, the dolmens, menhirs, cromlechs and stone circles are said to resemble more closely those of northern Africa than the larger remains of Brittany and of the British Isles. Aristotle tells us that the Iberi fixed obelisks round the tomb of each warrior in number equal to the enemies he had slain (*Polit.* vii. c. 2. 6), but proof is wanting that these Iberi were Basques.

Iberian inscriptions have been found on the so-called *toros de guisando*, rude stone bulls or boars, on other monuments of northern Spain and in ancient sepulchres; some of these figures, *e.g.* at the *Cerro de los Santos* in Murcia, recall the physical type of the modern Basques, but they are associated with others of very varied types.

Of the religion of the Basques anterior to Christianity, little

is certainly known. The few notices we have point to a worship of the elements, the sun, the moon and the morning star, and to a belief in the immortality of the unburnt and unburied body. The custom of the *cowade*, attributed by *Strabo* to the Cantabri, is unknown among the modern Basques. As elsewhere, the Romans assimilated Basque local deities to their own pantheon, thus we find *Deo Baicorrixo* (*Baigorri*) and *Herauscortseke* in Latin inscriptions. But the name which the Basques themselves give to the Deity is *Jaincoa*, *Jaungoikoa*, which may mean lord or master, Lord of the high; but in the dialect of *Roncail*, *Goikoa* means "the moon," and *Jaungoikooka* would mean "Lord of the moon." The term *Jain*, lord or master, *Elichego Jauna*, the lord or master of the house, is applied to every householder.

There is no aid to be got from folk-tales; none can be considered exclusively Basque and the literature is altogether too modern. The first book printed in Basque, the *Linguae Vasconum Primitiæ*, the poems of *Bernard d'Echepare*, is dated 1545. The work which is considered the standard of the language is the Protestant translation of the New Testament made by *Jean de Lizarra*, under the auspices of *Jeanne d'Albret*, and printed at *La Rochelle* in 1571. The *pastorales* are open-air dramas, like the moralities and mysteries of the middle ages. They are derived from French materials; but a dancing-chorus, invariably introduced, and other parts of the *mise-en-scène*, point to possibly earlier traditions. No MS. hitherto discovered is earlier than the 18th century. The greater part of the other literature is religious and translated. It is only recently that a real literature has been attempted in Basque with any success.

In spite of this modernity in literature there are other matters which show how strong the conservatism of the Basques really is. Thus, in dealing with the language, the only true measure of the antiquity of the race, we find that all cutting instruments are of stone; that the week has only three days. There are also other survivals now fast disappearing. Instead of the plough, the Basques used the *laya*, a two-pronged short-handled steel digging fork, admirably adapted to small properties, where labour is abundant. They alone of the peoples of western Europe have preserved specimens of almost every class of dance known to primitive races. These are (1) animal (or possibly totem) dances, in which men personate animals, the bear, the fox, the horse, &c.; (2) dances to represent agriculture and the vintage performed with wine-skins; (3) the simple arts, such as weaving, where the dancers, each holding a long coloured ribbon, dance round a pole on which is gradually formed a pattern like a Scotch tartan; (4) war-dances, as the sword-dance and others; (5) religious dances in procession before the Host and before the altar; (6) ceremonial dances in which both sexes take part at the beginning and end of a festival, and to welcome distinguished people. How large a part these played in the life of the people, and the value attached to them, may be seen in the vehement defence of the religious dances by *Father Larramendi*, S.J., in his *Corografía de Guipúzcoa*, and by the large sums paid for the privilege of dancing the first *Saut Basque* on the stage at the close of a *Pastorale*.

The old Basque house is the product of a land where stone and timber were almost equally abundant. The front-work is of wood with carved beams; the balconies and huge over-hanging roof recall the Swiss chalet, but the side and back walls are of stone often heavily buttressed. The cattle occupy the ground-floor, and the first storey is reached often by an outside staircase. The carved tombstones with their ornaments resemble those of Celtic countries, and are found also at *Bologna* in Italy.

In customs, in institutions, in administration, in civil and political life there is no one thing that we can say is peculiarly and exclusively Basque; but their whole system taken together marks them off from other people and especially from their neighbours.

Character.—The most marked features in the Basque character are an intense self-respect, a pride of race and an obstinate conservatism. Much has been written in ridicule of the claim of all Basques to be noble, but it was a fact both in the laws of

Spain, in the *fueros* and in practice. Every Basque freeholder (*vecino*) could prove himself noble and thus eligible to any office. They are not a town race; a Basque village consists of a few houses; the population lives in scattered habitations. They do not fear solitude, and this makes them excellent emigrants and missionaries. They are splendid seamen, and were early renowned as whale fishermen in the Bay of Biscay. They were the first to establish the cod-fishery off the coast of Newfoundland. They took their full part in the colonization of America. Basque names abound in the older colonial families, and Basque newspapers have been published in Buenos-Aires and in Los Angeles, California. As soldiers they are splendid marchers; they retain the tenacity and power of endurance which the Romans remarked in the Iberians and Celtiberians. They are better in defence than in attack. The failure to take Bilbao was the turning-point in both Carlist wars. In civil institutions and in the tenures of property the legal position of women was very high. The eldest born, whether boy or girl, inherited the ancestral property, and this not only among the higher classes but among the peasantry also. In the *fueros* an insult done to a woman, or in the presence of a woman, is punished more severely than a similar offence among men. This did not prevent women from working as hard as, or even harder than, the men. All authors speak of the robust appearance of the women-rowers on the Bidassoa, and of those who loaded and unloaded the ships in Bilbao.

Institutions.—In their municipal institutions they kept the old Roman term *respublica* for the *civitas* and the territory belonging to it. All municipal officers were elective in some form or other, and there is hardly any mode of election, from universal suffrage to nomination by a single person chosen by lot, that the Basques have not tried. The municipalities sent deputies to the juntas or parliaments of each province. These assemblies took place originally in the open air, as in other parts of the Pyrenees, under trees, the most celebrated of which is the oak of Guernica in Biscay, or under copes, as the Bilzaar in the French Pays Basque. The cortes of Navarre met at Pamplona. Delegates from the juntas met annually to consider the common interests of the three provinces. Besides the separate municipalities and the juntas, there were often associations and assemblies of three or five towns, or of three or four valleys, to preserve the special privilege or for the special needs of each. Hence was formed a habit of self-government, the practice of legislative, judicial and administrative functions, which resulted gradually in a code of written or unwritten laws embodied in the *fueros* or *fors* of each province, and the *cartas-pueblas* of the towns. In form these *fueros* or charters are often grants from the lord or sovereign; in reality they are only a confirmation or codification of unwritten customary laws in practice among the people, the origin of which is lost in antiquity. The kings of Castile, of Spain and of Navarre were obliged at their accession, either in person, or by deputy, to swear to observe these *fueros*; and this oath was really kept. While the cortes were trampled upon and absolutism reigned both in Spain and in France, the Basque *fueros* were respected; in Spain to the middle of the 19th century and in France down to the Revolution. The *fueros* thus observed made the Basque provinces a land apart (*una tierra apartada*), a self-governing republic (*una verdadera autonomia*), under an absolute monarchy, to which, however, they were always loyal. And this independence was acknowledged, not only in local, but also in international and European treaties, as in art. 15 of the treaty of Utrecht 1713. So the act of the 3rd of June 1876, which assimilated the Basque Provinces to the rest of Spain, acknowledged the true self-government which they had enjoyed for centuries.

The circumstances and methods which enabled the Basques to preserve this independence were, first, the isolation caused by their peculiar language; next, the mountainous and easily-defended nature of the country, its comparative poverty and the possession of a sea-board. Then there were the rights and the safeguards which the *fueros* themselves gave against encroachments. The rights were:—freedom of election to all offices and to the juntas; exemption from all forced military service except for

the defence of the country and under their own officers; and payment beforehand exacted for all service beyond their own frontiers (this did not of course exclude voluntary service of individuals in the Spanish or French armies). Then there was free trade with foreign nations, and especially between the Basques of both nations. The customs' frontier of Spain really began on the Ebro. Then no decree or sentence of the royal authorities could have effect in the provinces except countersigned by the junta. Otherwise the resisting and even the killing of a royal officer was no murder. But chiefest of all the safeguards was the provision that no tax or contribution should be levied or paid to the crown till all petitions had been heard and wrongs redressed; that such a vote should be the last act of the junta or cortes, and the money should be paid not as a demand of right or a tax, but as a free gift and above all a voluntary one. It was paid in a lump sum, and the repartition and levying were left entirely in the hands of the junta and the municipalities.

As a further precaution against the inroads of absolutism, no lawyer was allowed to be a deputy to the junta and all clergy were likewise excluded. The Basques considered that men of these professions would be always on the side of tyranny. One lawyer (*letrado*) was present at the juntas for consultation on the points of law, but he was not allowed to vote. So strictly was this observed that after the battle of Vitoria in 1813, when it was difficult to get together a quorum for the reorganization of the country, the *letrado*, though one of the most active and influential members in consultation, was not allowed to vote.

The relations between Church and State among the Basques have been very remarkable. They are a highly religious people, eminently conservative in their religious practices. In religion alone, through Ignatius de Loyola of Guipúzcoa and Francis Xavier of Navarre, they have left their mark upon Europe. They have kept the earliest form of Christian marriage and of the primitive order of deaconesses, forgotten elsewhere in the West. The feast of Corpus Christi instituted by Pope Urban IV. (1262) still appears in Basque almanacs as *Phesta-berria*, the New Feast. The earliest notice that we have of them speaks of their liberality to the clergy; yet with all this religious conservatism they have never allowed themselves to be priest-ridden. They constantly resisted the attempts of the crown to force upon them the authority of the Spanish bishops. When Ferdinand the Catholic came to Biscay in 1477 to swear to the *fueros*, he was compelled to send back the bishop of Pamplona whom he had brought with him. No strange priest could enter the town when the junta was sitting, and in some places if a deputy was seen speaking to a priest before a session he lost his vote for that day. The bishops had no share in ecclesiastical patronage in Guipúzcoa; all was in the hands of the king, of the nobles or of the municipalities, or else the priests were chosen by competitive examination or elected by the people. They would not allow the priest to interfere with the games or dances, and when the drama was forbidden in all Spain in 1757 by the authority of the Spanish bishops, the cortes of Navarre compelled the king to withdraw the order.

For a stranger coming from lands of larger farms and apparently higher cultivation, the agriculture of the Basques seems poor, but the old scattered homesteads show a sense of security that has been lacking in many parts of Spain; and the Basques have shown great adaptability in suiting their agriculture to new conditions, helped by the presence of the courts at San Sebastian and Biarritz. When the old self-sufficient village industries declined, in consequence of the invention of machinery and manufacture elsewhere, the Basques entered at once upon emigration to the agricultural parts of the Americas, and the result has been that the Basque Provinces and the Pays Basque probably have never been more prosperous than they are now, and perhaps a new Eskuall-herria and a new Eskuara are being built up in the distant lands to which they are such valued immigrants.

BIBLIOGRAPHY.—For so restricted a literature the *Essai d'une bibliographie de la langue basque*, by Julien Vinson (Paris, 1891), with a volume of additions and corrections, 1893, is practically exhaustive, and is a mine of information on the principal works. See also for the language, A. Oihenart, *Notitia utriusque Vasconiae* (Paris, 1638 and 1656), 4to., ch. xiv.; Fl. Lecluse, *Manuel de la*

langue basque (Toulouse, 1826); C. Ribary, *Essai sur la langue basque* (1866), translated from the Hungarian by Julien Vinson (Paris, 1877); W. J. Van Eys, *Grammaire comparée des dialectes basques* (Paris, London, Amsterdam, 1879); Prince L. B. Nonaparte, *Le Verbe basque en tableaux* (London, 1864-1869); J. Vinson, articles in *Revue de linguistique* (Paris, 1867-1906); L'Abbé Ithurry, *Grammaire basque* (Bayonne, 1895-1906); Dr H. Schuchhardt, *Die Entstehung der Basqueformen des Baskischen* (Wien, 1893); W. J. Van Eys, *Dictionnaire basque-français* (Paris, 1873); R. M. de Azkue, *Diccionario vascongado español-francés* (Tours, 1906); *Monumenta Linguae Ibericae*, edidit Aemilius Hubner, fol. (Berlin, 1893) (texts and introduction good; analysis and interpretation faulty). Other works of interest on various subjects are:—Wentworth Webster, *Basque Legends* (London, 1877 and 1879); Puyol y Camps, "La Epigraphia Numismatica Iberica," in *tomus xvi. of Boletín de la Real Academia de la Historia* (Madrid, 1890), (for geographical distribution of the alphabets); T. de Aranzadi, *El Pueblo Euzkelana. Estudio de Antropología* (San Sebastian, 1889); and the same author's *Existe una raza Euzkara? Sus caracteres antropologicos* (1905); *La Tradition au pays basque* (Paris, 1899), (a collection of papers by local authorities); Julien Vinson, *Les Basques et le pays basque* (Paris, 1882), a sufficient survey for the general reader; the same author's *Le Folk-Lore du pays basque* (Paris, 1883), treats of the Pastorales and embraces the whole Folk-Lore; *Le Codex de Saint-Jacques de Compostelle*, lib. iv. (Paris, 1882), by R. P. F. Fita and J. Vinson, gives the first Basque vocabulary; *Les Coutumes générales, locales et obscures au pays de Labourd de Labourd* (Bordeaux, 1700); G. Olphe-Galliard, *Le Paysan basque à travers les âges* (Paris, 1905); Pierre Yturbe, *Le Pays de Labourd avant 1789* (Bayonne, 1905), (for the time of the English domination); Henry O'Shea, *La Tombe basque* (Pau, 1889), (valuable for the comparison of Basque and Celtic sepulchral ornament). See also the bibliography to BASQUE PROVINCES. (W. WE. J. J. V.)

BASRA (written also BUSRA, BASSORA and BUSSORA), the name of a vilayet of Asiatic Turkey, and of its capital. The vilayet has an area of 16,470 sq. m., formed in 1884 by detaching the southern districts of the Bagdad vilayet. It includes the great marshy districts of the lower Euphrates and Tigris, and of their joint stream, the Shatt el-Arab, and a sanjak on the western shore of the Persian Gulf. A settled population is found only along the river banks. Except the capital, Basra, there are no towns of importance. Korna, at the junction of the two great rivers; Amara on the Tigris; Shatra on the Shatt el-Hai canal, connecting the Tigris and Euphrates; Nasrîeh, at the junction of that canal with the Euphrates and Suk esh-Sheikh, on the lower reaches of the Euphrates, are the principal settlements, with a population varying from 3000 to 10,000 or somewhat less. Along the Shatt el-Arab and the lower reaches of the Tigris and Euphrates there are vast plantations of date-palms, which produce the finest dates known. Here and there are found extensive rice-fields; liquorice, wheat, barley and roses are also cultivated in places. But in general the ancient canals on which the fertility of the country depends have been allowed to go to ruin. The whole land is subject to inundations which render settled agriculture impracticable, and the population consists chiefly of nomadic and semi-nomadic tribes whose wealth consists in herds of buffaloes, horses, sheep and goats. The principal exports are wool, dates, cereals, gum, liquorice-root and horses. The climate is humid and unhealthy. The population is estimated at about 200,000 almost exclusively Moslems, of whom three-quarters are Shi'ites. There are about 4000 Jews and perhaps 6000 Christians, among whom are reckoned the remains of the curious sect of Sabaeans or Mandaeans, whose headquarters are in the neighbourhood of Suk esh-Sheikh.

The capital of the vilayet, also called Basra, is situated in 47° 34' E. long. and 32° N. lat., near the western bank of the Shatt el-Arab, about 55 m. from the Persian Gulf. The town proper lies on the canal el-'Assar about 1½ to 2 m. W. of the Shatt el-Arab. There are no public buildings of importance. The houses are meanly built, partly of sun-dried and partly of burnt bricks, with flat roofs surrounded by parapets. The bazaars are miserably structures, covered with mats laid on rafters of date trees. The streets are irregular, narrow and unpaved. The greater part of the area of the town is occupied by gardens and plantations of palm-trees, intersected by a number of little canals, raised twice daily with the ebb and flow of the tide, which rises here about 9 ft. These canals are navigated by small

boats, called *bellem* (plur. *ablam*), resembling dug-outs in form, but light and graceful. At high-tide, accordingly, the town presents a very attractive appearance, but at low-tide, when the mud banks are exposed, it seems dirty and repulsive, and the noxious exhalations are extremely trying. The whole region is subject to inundations. The town itself is unhealthy and strangers especially are apt to be attacked by fever. Basra is the port of Bagdad, with which it has steam communication by an English line of river steamers weekly and also by a Turkish line. The Shatt el-Arab is deep and broad, easily navigable for ocean steamers, and there is weekly communication by passenger steamer with India, while two or more freight lines, which also take passengers, connect Basra directly with the Mediterranean, and with European and British ports. It is the great date port of the world, and the dates of Basra are regarded as the finest in the market. Besides dates the principal articles of export are wool, horses, liquorice, gum and attar of roses. The annual value of the exports is approximately £1,000,000 and of the imports a little more. The foreign trade is almost exclusively in the hands of the English, but of late the Germans have begun to enter the market, and the Hamburg-American line of steamers has established direct communication. Since 1898 there has been a British consul at Basra (before that time he was a representative of the Indian government). France and Russia also maintain consular establishments at Basra. The settled population of Basra is probably under 50,000, but how much it is impossible to estimate. It is a heterogeneous mixture of all the nations and religions of the East—Turks, Arabs, Persians, Indians, Armenians, Chaldaeans and Jews. Of the latter there are about 1900, engaged in trade and commerce. Fewest in number are the Turks, comprising only the officials. Most numerous are the Arabs, chiefly Shi'ites. The wealthiest and most influential personage in the capital and the vilayet is the *nakhî*, or marshal of the nobility (*i.e.* descendants of the family of the prophet, who are entitled to wear the green turban). Basra is a station of the Arabian mission of the Dutch Reformed Church of America.

History.—The original city of Basra was founded by the caliph Omar in A.D. 636 about 8 m. S.W. of its present site, on the edge of the stony and pebbly Arabian plateau, on an ancient canal now dry. The modern town of Zobeir, a sort of health suburb, occupied by the villas of well-to-do inhabitants of Basra, lies near the ruin mounds which mark the situation of the ancient city. In the days of its prosperity it rivalled Kufa and Wasit in wealth and size, and its fame is in the tales of the *Arabian Nights*. With the decay of the power of the Abbasid caliphate its importance declined. The canals were neglected, communication with the Persian Gulf was cut off and finally the place was abandoned altogether. The present city was conquered by the Turks in 1668, and since that period has been the scene of many revolutions. It was taken in 1777 after a siege of eight months by the Persians under Sadik Khan. In about a year it fell again into the hands of the Turks, who were again deprived of it by the sheikh of the Montefik (Montafiq) Arabs. The town was in the October following recovered by Suleiman Pasha, who encountered the sheikh on the banks of the Euphrates and put him to flight; it has since remained in the hands of the Turks. (J. P. PE.)

BASS, the name of a family of English brewers. The founder of the firm, William Bass (b. 1720), was originally a carrier, one of his chief clients being Benjamin Printon, a Burton-on-Trent brewer. By 1777 Bass had saved a little money, and seeing the growing demand for Burton beer he started as a brewer himself. The principal market for Burton beer at that time was in St Petersburg, whither the beer could be sent by water direct from Burton via the Trent and Hull, and William Bass managed to secure a tolerable share of the large Russian orders. But in 1822 the Russian government placed a prohibitory duty on Burton ales, and the Burton brewers were forced into cultivating the home market. William Bass opened up a connexion with London, and established a fairly profitable home trade. A misunderstanding between the East India Company and the London brewers who were the proprietors of Hodgson's India

Pale Ale, at that time the standard drink of Englishmen in the East, resulted in Bass being asked to supply a beer which would withstand the Indian climate and be generally suitable to the Indian market. After a series of experiments he produced what is still known as Bass's pale ale. This new and lighter beer at once became popular all over India, and Bass's firm became the largest in Burton. After William Bass's death the business was carried on by his son, M. T. Bass, and then by his grandson, Michael Thomas Bass (1799-1884). In 1827 a vessel laden with Bass's beer was wrecked in the Irish Channel. A large proportion of the cargo was however salvaged and sold at Liverpool, where it met with great approval in the local market, and through this chance circumstance the firm opened up a regular trade in the north-west of England and Ireland. "Bass" was, however, little drunk in London till 1851, when it was supplied on draught at the Exhibition of that year, since which time its reputation has been world-wide. In 1880 the business was turned into a limited liability company. Michael Thomas Bass, besides actively conducting and extending the firm's operations, was a man of great public spirit and philanthropy, and the towns of Burton and Derby are largely indebted to his munificence. He took a keen interest in all questions affecting the welfare of the working classes, and was largely instrumental in securing the abolition of imprisonment for debt. On his death, prior to which he had taken into partnership Messrs Ratcliff and Gretton, two of the leading officials of the brewery, converting the business into a limited company known as Messrs Bass, Ratcliff & Gretton, Ltd., the control of the firm passed to his sons, Michael Arthur Bass and Hamar Bass (d. 1898). Michael Arthur Bass (1837-1909), after twenty-one years in parliament as member first for Stafford, then for two divisions of Staffordshire, was in 1886 raised to the peerage as Baron Burton; by a special patent of 1897 the peerage descended to his daughter, Nellie, the wife of Mr J. E. Baillie of Dochfour, the baronetcy descending to his nephew W. A. Hamar Bass (b. 1879).

BASS (the same word as "base," and so pronounced, but influenced in spelling by the Ital. *basso*), deep, low; especially in music, the lower part in the harmony of a composition, the lowest male voice, or the lowest-pitched of a class of instruments, as the bass-clarinet.

Bass or bast (a word of doubtful origin, pronounced *bās*) is the fibrous bark of the lime tree, used in gardening for tying up plants, or to make mats, soft plaited baskets, &c. Basswood is the American lime-tree, *Tilia Americana*; white basswood is *T. heterophylla*.

The name bass is also given to a fish closely resembling the perch. **BASSA**, a province of the British protectorate of Northern Nigeria, occupying the angle made by the meeting of the Benue river with the Niger. It has an area of 7000 sq. m., with a population estimated at about one and a half millions. It is bounded N. by the Benue, W. by the Niger, S. by the frontier of Southern Nigeria, and E. by the province of Muri. The province is heavily forested, and is estimated to be one of the richest of the protectorate in natural products. It has never been penetrated by Moslem influence, and is inhabited in the greater part by warlike and unruly pagans. Early in the 16th century the Igbara (Okpoto or Ibo) were one of the most powerful pagan peoples of Nigeria and had their capital at Iddah. At a later period the Bassas conquered the western portion of the state and the Munshis the eastern, while the Okpoto still held the south and a wedge-shaped district partially dividing the Munshis and Bassas. The Bassas are a very remarkable pagan race who permeate the entire protectorate of Northern Nigeria, and are to be found in small colonies in almost every province. They are clever agriculturists, naturally peaceful and industrious. The Munshis, though also good agriculturists, are a warlike and most unruly race, as are also the Okpoto.

The districts which now comprise the province of Bassa came nominally under British control in 1900, but up to the year 1903 administrative authority was confined to the western half with Dekina (in 7° 3' E., 7° 41' N.) for its capital. In December of 1903 a disturbance resulting in the murder of the British resident

led to the despatch of a military expedition, and as a result of the operations the frontiers of the districts under control were extended to the borders of the Munshi country in about 8° E. The western portion of the province, occupied by friendly and peaceful tribes upon the Niger, has been organized for administration on the same system as the rest of the protectorate. Courts of justice are operative and taxes are peacefully collected. The Okpoto, however, remain turbulent, as do their neighbours the Munshis. Spirits, of which the importation is forbidden in Northern Nigeria, are freely smuggled over the border from Southern Nigeria. Arms and powder are also imported. The slave-trade is still alive in this district, and an overland route for slaves is believed to have been established through eastern Bassa to the Benue. In consequence of the natural wealth of the province, there are trading establishments of the Niger Company and of Messrs Holt on the Niger and Benue, and colonies of native traders have penetrated the country from the north. Roman Catholic and Protestant missions are established at Dekina and Gbebe.

BASSANO, JACOPO DA PONTE (1510-1592), Venetian painter, was born at Bassano. He was educated by his father, who was himself an artist, and then completed his studies at Venice. On the death of his father he returned to Bassano and settled there. His subjects were generally peasants and villagers, cattle and landscapes, with some portraits and historical designs. His figures are well designed, and his animals and landscapes have an agreeable air of simple nature. His compositions, though they have not much eloquence or grandeur, have abundance of force and truth; the local colours are well observed, the flesh-tints are fresh and brilliant, and his chiaroscuro and perspective are unexceptionable. He is said to have finished a great number of pictures; but his genuine works are somewhat rare and valuable—many of those which are called originals being copies either by the sons of Bassano or by others. Bassano's style varied considerably during his lifetime. He naturally was at first a copier of his father, but his productions in this style are not of great value. He was then strongly attracted by the lightness and beautiful colouring of Titian, and finally adopted the style which is recognized as his own. Although he painted few great pictures, and preferred humble subjects, yet his altarpiece of the Nativity at Bassano is estimated highly by the best judges, and in Lanzi's opinion is the finest work of its class.

BASSANO, a city of Venetia, Italy, in the province of Vicenza, 24 m. N.E. of Vicenza and 30 m. N. of Padua by rail, at the foot of the Venetian Alps. Pop. (1901) town, 7553; commune, 15,097. It is well situated upon the Brenta, which is here spanned by a covered wooden bridge, and commands fine views. The castle, erected by the Ezzelini in the 13th century, lies in the upper portion of the town, above the river; a tower, erected by a member of the same family, is a conspicuous feature. The museum and cathedral and some of the other churches contain pictures by the da Ponte family (16th and early 17th century), surnamed Bassano from their birth-place; Jacopo is the most eminent of them. The museum also contains drawings and letters of the sculptor Antonio Canova. The church of S. Francesco, begun in the 12th century in the Lombard Romanesque style, was continued in the 13th in the Gothic style. Some of the houses have traces of paintings on their façades. In the 11th century Eccelin, a German, obtained fiefs in this district from Conrad II. and founded the family of the Ezzelini, who were prominent in the history of North Italy in the 13th and 14th centuries. Bassano apparently came into existence about A.D. 1000. Its possession was disputed between Padua and Vicenza; it passed for a moment under the power of Gian Galeazzo Visconti of Milan, who fortified it. At the beginning of the 15th century it went over to Venice; its industries flourished under Venetian government, especially its printing-press and manufacture of majolica, the latter of which still continues. On the 8th of September 1796 an action was fought here between the French and the Austrians, in which the French were victorious. (T. As.)

BASSARAB of BASSARABA, the name of a dynasty in Rumania, which ruled Walachia from the dawn of its history until 1658.

The origin of the name and family has not yet been explained. It undoubtedly stands in close connexion with the name of the province of Bessarabia, which oriental chroniclers gave in olden times to the whole of Walachia. The heraldic sign, three heads of negroes in the Bessarab shield, seems to be of late western origin and to rest on a popular etymology connecting the second half of the word with Arabs, who were taken to signify Moors (blacks). The other heraldic signs, the crescent and the star, have evidently been added on the same supposition of an oriental origin of the family. The Servian chroniclers connect its origin with their own nationality, basing this view upon the identification of Sarab with *Sorb* or *Serbia*. All this is mere conjecture. It is, however, a fact that the first appearance of the Bessarabs as rulers (*knyaz, ban* or *voivod*) is in the western part of Rumania (originally called Little Walachia), and also in the southern parts of Transylvania—the old dukedoms of Fogarash and Almash, which are situated on the right bank of the Olt (Aluta) and extend south to Severin and Craiova. Whatever the origin of the Bessarabs may be, the foundation of the Walachian principality is undoubtedly connected with a member of that family, who, according to tradition, came from Transylvania and settled first in Câmpulung and Tirgovishteia. It is equally certain that almost every one of the long line of princes and voivods bore a Slavonic surname, perhaps due to the influence of the Slavonic Church, to which the Rumanians belonged. Starting from the 13th century the Bessarabs soon split into two rival factions, known in history as the descendants of the two brothers Dan and Dragul. The form Drakul—devil—by which this line is known in history is no doubt a nickname given by the rival line. It has fastened on the family on account of the cruelties perpetrated by Vlad Drakul (1433-1446) and Vlad Tsepesh (1456-1476), who figure in popular legend as representatives of the most fiendish cruelty. The feud between the rival dynasties lasted from the beginning of the 15th century to the beginning of the 17th.

The most prominent members of the family were Mircea (1386-1418), who accepted Turkish suzerainty; Neagoe, the founder of the famous cathedral at Curtea de Argesch (*q.v.*); Michael, surnamed the Brave (1592-1601); and Petru Cercel, famous for his profound learning, who spoke twelve languages and carried on friendly correspondence with the greater scholars and poets of Italy. He was drowned by the Turks in Constantinople in 1590 through the intrigues of Mihnea, who succeeded him on the throne of Walachia. The British Museum possesses the oldest MSS. of the Rumanian Gospels, once owned by this Petru Cercel, and containing his autograph signature. The text was published by Dr M. Gaster at the expense of the Rumanian government. Mateiu Bessarab (1633-1654) established the first printing-press in Rumania, and under his influence the first code of laws was compiled and published in Bucharest in 1654. The Bessarab dynasty became extinct with Constantine Sherban in 1658. See RUMANIA: *Language and Literature*. (M. G.)

BASS CLARINET (Fr. *clarinette basse*; Ger. *Bass-Klarinette*; Ital. *clarinetto basso* or *clarone*), practically the A, B \flat or C clarinet speaking an octave lower; what therefore has been said concerning the fingering, transposition, acoustic properties and general history of the clarinet (*q.v.*) also applies to the bass clarinet. Owing to its greater length the form of the bass clarinet differs from that of the clarinets in that the bell joint is bent up in front of the instrument, terminating in a large glocken-shaped bell, and that the mouthpiece is attached by means of a strong ligature and screws to a serpent-shaped crook of brass or silver. The compass of the modern orchestral bass clarinet is in the main the same as that of the higher clarinets in C, B \flat and A, but an octave lower, and therefore for the bass clarinet in C is ; for the bass clarinet in B \flat the real sounds

are one tone, and for the bass clarinet in A $1\frac{1}{2}$ tone lower, although the notation is the same for all three.

Sometimes the treble clef is used in notation for the bass clarinet. It must then be understood that the instrument in C speaks an

octave lower, the bass clarinet in B \flat a major ninth and the bass clarinet in A a minor tenth lower. The tenor clef is also frequently used in orchestral works.

The quality of tone is less reedy in the bass clarinet than in the higher instruments. It resembles the bourdon stop on the organ, and in the lowest register, more especially, the tone is somewhat hollow and wanting in power although mellower than that of the bassoon. In the lowest octave the instrument speaks slowly and is chiefly used for sustained bass or melody notes; rapid passages are impossible.

The modern orchestral model may be fitted with almost every kind of key-mechanism, including the Boehm, and the degree of perfection and ingenuity attained has removed the all but insuperable difficulties which stood in the way of the original inventors who, not understanding key-work, made many futile attempts to bridge the necessarily great distance between the finger-holes by making the bore serpentine, boring the holes obliquely, &c.

The low pitch of the bass clarinet (8 ft. tone) contrasted with the moderate length of the instrument—whose bore measures only some 42 to 43 inches from mouthpiece to bell, whereas that of the bassoon, an instrument of the same pitch, is twice that length—is a puzzle to many. An explanation of the fact is to be found in the peculiar acoustic properties of the cylindrical tube played by means of a reed mouthpiece characterizing the clarinet family, which acts as a closed pipe speaking an octave lower than an open pipe of the same length, and overblowing a twelfth instead of an octave. This is more fully explained in the articles CLARINET and AULOS.

The construction of the bass clarinet demands the greatest care. The bore should theoretically be strictly cylindrical throughout its length from mouthpiece to bell joint; the slightest deviation from mathematical accuracy, such as an undue widening of the bell from the point where it joins the body to the mouth of the bell, would tend to muffle the lower notes of the instrument and to destroy correct intonation.

The origin of the bass clarinet must be sought in Germany, where Heinrich Grenser of Dresden, one of the most famous instrument-makers of his day, made the first bass clarinet in 1793. The basset horn (*q.v.*) or tenor clarinet, which had reached the height of its popularity, no doubt suggested to Grenser, who was more especially renowned for his excellent fagottos, the possibility of providing for the clarinet a bass of its own. One of these earliest attempts in the form of a fagotto, stamped "A. Grenser, Dresden," with nine square-flapped brass keys working on knobs, is in the Grossherzogliches Museum at Darmstadt and was lent to the Royal Military Exhibition, London 1890.¹ Two other early specimens,² belonging originally to Adolphe Sax and to M. de Coussemaeker, are now respectively preserved in the museums of the Brussels Conservatoire and of the Berlin Hochschule (Snoeck Collection). The tubes are of great thickness and the holes are bored obliquely through the walls. Both instruments are in A.

Attempts were made in Italy to overcome the mechanical difficulties by making the bore of the bass clarinet serpentine. A specimen by Nicolas Papalini of Pavia³ in the museum of the Brussels Conservatoire has the serpentine bore pierced through two slabs of pear-wood; the two halves, each forming a vertical section of the instrument, are fitted together with wooden pins. The outside length is only 2 ft. $3\frac{1}{2}$ in. and there are nineteen finger-holes.

Joseph Uhlmann of Vienna⁴ constructed a bass clarinet, also termed "bass basset horn," with twenty-three keys and a compass from B \flat through four complete octaves with all chromatic

¹ See Captain C. R. Day, *Descriptive Catalogue* (London, 1891), No. 266, p. 125.

² See Victor Mahillon, *Catalogue descriptif*, vol. ii. (1896), pp. 224-226, No. 940.

³ See Captain C. R. Day, *op. cit.* p. 123, pl. v. B. and p. 123, No. 952.

⁴ See Dr Schafhäutl's report on the Munich exhibition, *Bericht der Beurtheilungscommission für Musikinstrumente* (Munich, 1855), p. 153.

semities. These instruments resemble the saxophones (*q.v.*), having the bell joint bent up in front and the crook almost at right angles backwards, but the bore of the saxophone is conical.

Georg Streitwolf (1779-1837), an ingenious musical instrument-maker of Göttingen, produced in 1828 a bass clarinet with a compass extending from $A\flat$ to F , nineteen keys and a fingering the same as that of the clarinet with but few exceptions. In form it resembled the fagotto and had a crook terminating in a beak mouthpiece. The Streitwolf bass clarinet was adopted in 1834 by the Prussian infantry as bass to the wood-wind.¹ Streitwolf's first bass clarinets were in C , but later he constructed instruments in $B\flat$ as well. Like the basset horn, Streitwolf's instruments had the four chromatic open keys extending the compass downwards to $B\flat$. The tone was of very fine quality. One of these instruments is in the possession of Herr C. Kruspe of Erfurt,² and another is preserved in the Berlin collection at the Hochschule.

It was, however, the successive improvements of Adolphe Sax (Paris, 1814-1894), working probably from Grenser's and later from Streitwolf's models, which produced the modern bass clarinet, and following up the work of Halary and Buffet in the same field, he secured its introduction into the orchestra at the opera. The bass clarinet in C made its first appearance in opera in 1836 in Meyerbeer's *Huguenots*, Act V., where in a fine passage the lower register of the instrument is displayed to advantage, and later in *Dinorah* (*Le pardon de Ploermel*). Two years later (1838) at the theatre of Modena a bass clarinet by P. Maino of Milan, differing in construction from the Sax model, was independently introduced into the orchestra.³ Wagner employed the bass clarinet in $B\flat$ and C in *Tristan und Isolde*,⁴ where at the end of Act II. it is used with great effect to characterize the reproachful utterance of King Mark, thus:



BASSEIN, a district and town in the Irrawaddy division of Lower Burma, in the delta of the Irrawaddy. The district has been reduced to 4127 sq. m., from 8954 sq. m. in 1871, having given up a large tract to the district of Myaungmya formed in 1896.

A mountain range called the Anauk-pet Taungmyin stretches through the district from N. to S. along the coast. The principal river of the district is the Irrawaddy, which debouches on the sea at its eastern extremity through a delta intersected with salt water creeks, among which the Pyamalaw, Pynzalü, Kyuntön, and Ngawun Shagëgyi or Bassein river rank as important arms of the sea. Irrawaddy and Inyëgyi are the only two lakes in the district. The delta of the Irrawaddy forms, wherever cultivable, a vast sheet of rice, with cotton, sesamum, and tobacco as subsidiary crops. In 1901 the population was 391,427.

BASSEIN, the chief town and port, is the capital of the district and division, and is situated on the eastern bank of the Bassein river, one of the main arteries by which the waters of the Irrawaddy discharge themselves into the sea. It forms an important seat of the rice trade with several steam rice mills, and has great capabilities both from a mercantile and a military point of view, as it commands the great outlet of the Irrawaddy. It fell before the British arms, in May 1852, during the second Burmese war. In 1901 it had a population of 31,864. The vessels of the Irrawaddy Flotilla Company ply between Rangoon and Bassein, &c., by inland waters, and a railway opened in 1903 runs north-eastward through the centre of the district, to Henzada and Letpadan.

BASSELIN, OLIVIER (c. 1400-c. 1450), French poet, was born in the Val-de-Vire in Normandy about the end of the 14th century. He was by occupation a fuller, and tradition still points out the site of his mill. His drinking songs became famous under the name of Vaux-de-Vire, corrupted in modern times into "vaudeville." From various traditions it may be gathered that Basselin was

killed in the English wars about the middle of the century, possibly at the battle of Formigny (1450). At the beginning of the 17th century a collection of songs was published by a Norman lawyer, Jean Le Houx, purporting to be the work of Olivier Basselin. There seems to be very little doubt that Le Houx was himself the author of the songs attributed to Basselin, as well as of those he acknowledged as his own.

It has been suggested that Basselin's name may be safely connected with some songs preserved in the *Bibliothèque Nationale* at Paris, and published at Caen in 1866 by M. Armand Gasté. The question is discussed in M. V. Patard's *La Vérité dans la question Olivier Basselin et Jean le Houx à propos du Vau-de-Vire* (1897). A. Gasté's edition (1875) of the *Vaux-de-Vire* was translated (1885) by J. P. Muirhead.

BASSES-ALPES, a department of south-eastern France, formed in 1790 out of the northern portion of Provence. It is bounded N. by the department of the Hautes Alpes, E. by Italy and the department of the Alpes Maritimes, S. by that of the Var, and W. by those of Vaucluse and Drôme. Its area is about 2698 sq. m., while its greatest length is 89½ m. and its greatest breadth 56 m. Pop. (1906) 113,126. The river Durance passes through the western part of this department, receiving (left), as affluents, the Ubaye, the Bléone and the Assé (the entire course of each of these rivers is included within the department) as well as the Verdon, the upper course of which is within the department, while the lower course forms its southern limit. It is a poor and hilly district, the highest summits (the loftiest is the Aiguille de Chambeyron, 11,155 ft.) rising round the head waters of the Ubaye. The department is divided into five arrondissements (Digne, Barcelonnette, Castellane, Forcalquier, and Sisteron), 30 cantons and 250 communes. It forms the bishopric of Digne, formerly in the ecclesiastical province of Embrun, but since 1802 in that of Aix-en-Provence. Its chief towns are Digne, Barcelonnette, Castellane, Forcalquier, and Sisteron. It is poorly supplied with railways (total length 109½ m.), the main line from Grenoble to Avignon running through it from Sisteron to Manosque, and sending off two short branch lines to Digne (14 m.) and to Forcalquier (9 m.). It is a poor department from the material point of view, being very mountainous and containing many mountain pastures. But these pastures have been much damaged by the Provençal shepherds to whom they are let out, while the forests have been very much thinned (though extensive reafforestments are now being carried out) so that the soil is very dry and made drier by exposure to the southern sun. From near the head of the Ubaye valley the pass of the Col de l'Argentière (6545 ft.) leads over from Barcelonnette to Cuneo, in Italy: it was perhaps traversed by Hannibal, and certainly in 1515 by Francis I.

See C. J. J. M. Féraud, *Histoire, géographie et statistique du Département des Basses-Alpes* (Digne, 1861). (W. A. B. C.)

BASSES-PYRÉNÉES, a department of south-western France, at the angle of the Bay of Biscay, formed in 1790, two-thirds of it from Béarn and the rest from three districts of Gascony—Basse-Navarre, Soule and Labourd. The latter constitute the Basque region of France (see BASQUES) and cover the west of the department. Basses-Pyrénées is bounded N. by Landes and Gers, E. by Hautes-Pyrénées (which has two enclaves forming five communes within this department), S. by Spain, and W. by the Atlantic Ocean. Pop. (1906) 426,817. Area, 2977 sq. m. The whole of the south of the department is occupied by the western and lower summits of the Pyrenees. The remainder consists of a region of heaths and plateaus to the north-east of the Gave de Pau, and of hills divided by numberless fertile valleys to the west of that river. The height of the mountains of the southern frontier increases gradually from west to east. The peak of the Rhune, to the south of St Jean de Luz, rises only to 2950 ft.; and on the border of the Basque country the mean height of the summits is not much greater. The peak of Orhy alone, in the south of the valley of Mauléon, reaches 6618 ft. But beyond that of Anie (8215 ft.), on the meridian of Orthez, which marks the boundary of Béarn, much loftier elevations appear.—Mourroux (9760 ft.), on the border of Hautes-Pyrénées, and the southern peak of Ossau (9465 ft.). The frontier between France and Spain, for the most part,

¹ See *Allgemeine musikalische Zeitung* (Leipzig, 1834), Bd. xxxvi, March, p. 103.

² See Wilhelm Altenburg, *Die Klarinette* (Heilbronn, 1904-1905), p. 33.

³ See W. Altenburg, *op. cit.* p. 34.

⁴ Orchestral score, p. 284.

follows the crest-line of the main range. Forts guard the upper valleys of the Nive and the Aspe, along which run important passes into Spain. The general direction of the rivers of the department is towards the north-west. The streams almost all meet in the Adour through the Gave de Pau, the Bidouze, and the Nive. In the north-east the two Luys flow directly to the Adour, which they join in Landes. In the south-west the Nivelle and the Bidassoa flow directly into the sea. The lower course of the Adour forms the boundary between Basses-Pyrénées and Landes; it enters the sea a short distance below Bayonne over a shifting bar, which has often altered the position of its mouth. The Gave de Pau, a larger stream than the Adour, passes Pau and Orthez, but its current is so swift that it is only navigable for a few miles above its junction with the Adour. On the left it receives the Gave d'Oloron, formed by the Gave d'Ossau, descending from the Pic du Midi, and the Gave d'Aspe, which rises in Spain. An important affluent of the Gave d'Oloron, the Saison or Gave de Mauléon, descends from the Pic d'Orhy. From the Pic des Escaliers, which rises above the forest of Iraty, the Bidouze descends northwards; while the forest, though situated on the southern slope of the chain, forms a part of French territory. The Nive, a beautiful river of the Basque country, takes its rise in Spain; after flowing past St Jean-Pied-de-Port, formerly capital of French Navarre and fortified by Vauban to guard the pass of Roncevaux, it joins the Adour at Bayonne. The Nivelle also belongs only partly to France and ends its course at St Jean-de-Luz. The Bidassoa, which is only important as forming part of the frontier, contains the Ile des Faisans, where the treaty of the Pyrenees was concluded (1659), and debouches between Hendaye (France) and Fuenterrabia (Spain).



The climate of the department is mild and it has an abundant rainfall, partly due to the west wind which drives the clouds from the gulf of Gascony. The spring is rainy; the best seasons are summer and autumn, the heat of summer being moderated by the sea. The winters are mild. The air of Pau agrees with invalids and delicate constitutions, and St Jean-de-Luz and Biarritz are much frequented by winter visitors.

Despite extensive tracts of uncultivated land, the department is mainly agricultural. Maize and wheat are the chief cereals; potatoes, flax and vegetables are also produced. Pasture is abundant, and horses, cattle, sheep and pigs are largely reared. The vine is grown on the lower slopes sheltered from the north wind, the wines of Jurançon, near Pau, being the most renowned. Of the fruits grown, chestnuts, cider-apples, and pears are most important. About one-thirteenth of the department consists of woods, a very small proportion of which belong to the government, the rest to the communes and private individuals.

The department furnishes salt, building-stone, and other quarry products. There are mineral springs at Eaux-Bonnes, Eaux-Chaudes, Cambo-les-Bains (resorted to by the Basques on St John's Eve), St Christau, and Salies. At Le Boucau, 3 m. from Bayonne, there are large metallurgical works, the *Forges de l'Adour*, and chemical works. The manufactures of the department include woollen caps and sashes, cord slippers, chocolate, and paper, and there are also tanneries, saw- and flour-mills. "Bayonne hams" and other table delicacies are prepared at Orthez. There is a considerable fishing population at Bayonne and St Jean-de-Luz. Bayonne is the principal port. Exports consist chiefly of timber, mine-props, minerals, wine, salt and resinous products. Coal, minerals, phosphates, grain and wool are leading imports. The interior commerce of the department is, however, of greater importance to its inhabitants; it takes the form of exchange of products between the regions of mountain and plain. The railway lines of Basses-Pyrénées, the chief of which is that from Bayonne to Toulouse via Orthez and Pau, belong to the Southern Company. The Adour, the Nive and the Bidouze are navigable on their lower courses. The department has five arrondissements—Pau, Bayonne, Oloron, Orthez and Mauléon, divided into 41 cantons and 559 communes. It constitutes the diocese of Bayonne, comes within the educational circumscription (*académie*) of Bordeaux and belongs to the

district of the XVIII. army corps. Pau, the capital and seat of a court of appeal, Bayonne, Oloron, Biarritz, Orthez, Eaux-Bonnes, and St Jean-de-Luz are the principal towns. The following places are also of interest:—Lescar, which has a church of the 12th and 16th century, once a cathedral; Montaner, with a stronghold built in 1380 by Gaston Phoebus, count of Foix and viscount of Béarn; and Sauverterre, a town finely situated on the Gave d'Oloron, with an old bridge, remains of a feudal castle, and a church in the Romanesque and Gothic styles.

BASSET, or **BASSETTE**, a French game of cards played by five persons with a pack of fifty-two cards. Once very popular, it is now practically obsolete. It is said to be of Venetian origin and to have been introduced into France by Justiniani, the ambassador of Venice in the second half of the 17th century. It resembles lansquenet (*q.v.*) in a general way, in that it is played between a banker and several punters, the players winning or losing according as cards turned up match those already exposed or not.

BASSET HORN (Fr. *Cor de Basset*, or *Cor de Bassette*; Ger. *Basselhorn*, *Basshorn*; Ital. *Corno di Bassetto*), a wood-wind instrument, not a "horn," member of the clarinet family, of which it is the tenor. The basset horn consists of a nearly cylindrical tube of wood (generally cocus or box-wood), having a cylindrical bore and terminating in a metal bell wider than that of the clarinet. For convenience in reaching the keys and holes, the modern instrument is usually bent or curved either near the mouthpiece or at the bell, which is turned upwards. The older models were bent in the middle at an obtuse angle, and had at the bottom of the lower joint, near the bell, a wooden block, inside which the bore was reflexed, and bent down upon itself.¹ The basset horn has the same fingering as the clarinet, and corresponds to the tenor of that instrument, being pitched a fifth below the clarinet in C. The alto clarinet in Eb is often substituted for the basset horn, especially in military bands, but the instruments differ in three particulars:—(1) The basset horn has a metal bell instead of the pear-shaped contracted bell of the alto clarinet. (2) The bore of the basset horn is wider than that of the alto clarinet in Eb, or of the tenor clarinet in F. (3) The tube of the basset horn is longer than that of the clarinet, and contains four additional long keys, worked by the thumb of the right hand, which in the clarinet is only used to steady the instrument. These keys give the basset horn an extended compass of two tones downwards to F  whereas the Eb clarinet only extends to G  and the F clarinet to A  (actual sounds). This brings the compass of the basset horn to a range of four octaves from

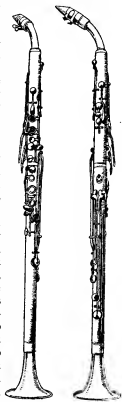
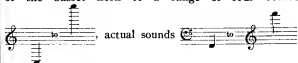

FIG. 1.
(From photographs lent by
M. Victor Mahillon.)



¹ An instrument of this type, stamped "H. Grenser, S. Wiesner, Dresden," is in the collection of the Rev. F. W. Galpin, of Hatfield, Broad Oak.

Like the clarinet, the basset horn is a transposing instrument, its music being written a fifth higher than the actual sounds. The treble clef is used in notation for all but the lowest register. The technical capabilities of the basset horn are the same as for the clarinet, except that the extra low notes from A to F (actual sounds) can only be intoned slowly and *staccato*; the notes of the upper register being better represented in the clarinet are seldom used in orchestral music.

The tone of the basset horn is extremely reedy and rich, especially in the medium and low registers; the tone colour is similar to that of the clarinet without its brilliancy; it is mellow and sensuous, but slightly sombre, and therefore well adapted for music of an elegiac funeral character.

The basset horn flourished mainly in Germany, where at the end of the 18th century it was the favourite solo instrument of many celebrated instrumentalists, such as Czerny, David, Lotz, Springer, &c. Among the great masters, Mozart seems to have been foremost in his appreciation of this beautiful instrument. In his *Requiem*, the reed family is represented by two basset horns having independent parts, and two bassoons. Mozart has also used the instrument with great effect in his opera *La Clemenza di Tito*, where he has written a fine obbligato for it in the aria "Non più di Fiori"; in *Zauberflöte*; and in chamber music, viz. short adagio for two basset horns and bassoon, and another for two clarinets and three basset horns (Series 10 of Breitkopf & Härtel's complete edition). Beethoven employed it in his *Prometheus* overture. Mendelssohn used it in military music, and in two concerted pieces for clarinet and basset horn with pianoforte accompaniment, in F and D min., opp. 113 and 114, dedicated to Heinrich and Carl Bärmann.

The archetypes of the basset horn are the same as those of the clarinet (*q.v.*). The basset horn was the outcome of the desire, prevailing during the 16th and 17th centuries, to obtain complete families of instruments to play in concert. The invention of the basset horn in 1770 is attributed to a clarinet maker of Passau, named Horn, whose name was given to the instrument; by a misnomer, the basset horn became known in Italy as *cornò di bassetto*, and in France as *cor de basset*. In 1782, Theodore Lotz of Pressburg made some modifications in the instrument, which was further improved by two instrumentalists of Vienna, Anton and Johann Stadler, and finally in 1812 by Iwan Mueller, a famous clarinetist, who invented the alto clarinet in E \flat from the basset horn, by giving the latter a construction and fingering analogous to those of the clarinet in B \flat , which he took as his model, instead of the clarinet in C.

See J. G. H. Backofen, *Anweisung zur Klarinette, nebst einer kurzen Abhandlung über das Basset-Horn*, with illustration, p. 37 (Leipzig, Breitkopf & Härtel, 1803); Iwan Mueller, *Anweisung zu der neuen Klarinette und der Clarinette-also, nebst einigen Bemerkungen für Instrumentenmacher* (Leipzig, Friedrich Hofmeister, 1826, with illustrations; Gottfried Weber, "Über Clarinette und Bassethorn," *Capella*, Band xi, pp. 35-37 (Mainz, 1834); Wilhelm Altenburg, *Die Clarinette, ihre Entstehung und Entwicklung bis zur Jetztzeit in akustischer, technischer u. musikalischer Beziehung* (Heilbrunn, 1904), pp. 16-32; good heliogravures of early basset horns in *Descriptive Catalogue of the Musical Instruments at the Royal Military Exhibition, London, 1890*, compiled by Capt. C. R. Day (1891), pl. v. (K. S.)

BASSI, LAURA MARIA CATERINA (1711-1778), an Italian lady eminently distinguished for her learning, was born at Bologna in 1711. On account of her extraordinary attainments she received a doctor's degree, and was appointed professor in the philosophical college, where she delivered public lectures on experimental philosophy till the time of her death. She was elected member of many literary societies and carried on an extensive correspondence with the most eminent European men of letters. She was well acquainted with classical literature, as well as with that of France and Italy. In 1738 she married Giuseppe Verrati, a physician, and left several children. She died in 1778.

¹ *Cantor Lectures on Musical Instruments, their Construction and Capabilities*, by A. J. Hipkins, p. 15; Henri Lavoix, *Histoire de l'instrumentation depuis le seizième siècle jusqu'à nos jours* (Paris, 1878), on p. 123 the date is given as 1777.

BASSI, UGO (1800-1849), Italian patriot, was born at Cento, and received his early education at Bologna. An unhappy love affair induced him to become a novice in the Barnabite order when eighteen years old. He repaired to Rome, where he led a life of study and devotion, and entered on his ministry in 1833. It was as a preacher that he became famous, his sermons attracting large crowds owing to their eloquence and genuine enthusiasm. He lived chiefly at Bologna, but travelled all over Italy preaching and tending the poor, so poor himself as to be sometimes almost starving. On the outbreak of the revolutionary movements in 1848, when Pope Pius IX. still appeared to be a Liberal and an Italian patriot, Bassi, filled with national enthusiasm, joined General Durando's papal force to protect the frontiers as army chaplain. His eloquence drew fresh recruits to the ranks, and he exercised great influence over the soldiers and people. When the pope discarded all connexion with the national movement, it was only Bassi who could restrain the Bolognese in their indignation. At Treviso, where he had followed Guidotti's volunteers against the Austrians, he received three wounds, delighted to shed his blood for Italy (12th of May, 1848). He was taken to Venice, and on his recovery he marched unarmed at the head of the volunteers in the fight at Mestre. After the pope's flight from Rome and the proclamation of the Roman republic, Bassi took part with Garibaldi's forces against the French troops sent to re-establish the temporal power. He exposed his life many times while tending the wounded under fire, and when Garibaldi was forced to leave Rome with his volunteers the faithful monk followed him in his wanderings to San Marino. When the legion broke up Garibaldi escaped, but Bassi and a fellow-Garibaldian, Count Livraghi, after endless hardships, were captured near Comacchio. On being brought before the papal governor, Bassi said: "I am guilty of no crime save that of being an Italian like yourself. I have risked my life for Italy, and your duty is to do good to those who have suffered for her." The governor would have freed the prisoners; but he did not dare, and gave them over to an Austrian officer. They were escorted to Bologna, falsely charged before a court martial with having been found with arms in their hands (Bassi had never borne arms at all), and shot on the 8th of August, 1849. Bassi is one of the most beautiful figures of the Italian revolution, a gentle unselfish soul, who, although unusually gifted and accomplished, had an almost childlike nature. His execution excited a feeling of horror all over Italy.

Countess Martiniengo gives a charming sketch of his life in her *Italian Characters* (2nd ed., London, 1901); see also Zironi, *Vita del Padre Ugo Bassi* (Bologna, 1879); F. Venosta, "Ugo Bassi, Martire di Bologna," in the *Pantheon dei Martiri Italiani* (Milan, 1863). (L. V.)

BASSIANUS, JOANNES, Italian jurist of the 12th century. Little is known of his origin, but he is said by Corolus de Tocco to have been a native of Cremona. He was a professor in the law school of Bologna, the pupil of Bulgarus (*q.v.*), and the master of Azo (*q.v.*). The most important of his writings which have been preserved in his *Summary on the Authentica*, which Savigny regarded as one of the most precious works of the school of the Gloss-writers. Joannes, as he is generally termed, was remarkable for his talent in inventing ingenious forms for explaining his ideas with greater precision, and perhaps his most celebrated work is his "Law-Tree," which he entitled *Arbor Arborum*, and which has been the subject of numerous commentaries. The work presents a tree, upon the branches of which the various kinds of actions are arranged after the manner of fruit. The civil actions, or *actiones stricti juris*, being forty-eight in number, are arranged on one side, whilst the equitable or *praetorian* actions, in number one hundred and twenty-one, are arranged on the other side. A further scientific division of actions was made by him under twelve heads, and by an ingenious system of notation the student was enabled to class at once each of the civil or praetorian actions, as the case might be, under its proper head in the scientific division. By the side of the tree a few glosses were added by Joannes to explain and justify his classification. His *Lectures on the Pandects* and the *Code*, which were collected by his pupil Nicolaus Furiosus, have unfortunately perished.

BASSOMPIERRE, FRANÇOIS DE (1579-1646), French courtier, son of Christophe de Bassompierre (1547-1596), was born at the castle of Harrouel in Lorraine. He was descended from an old family which had for generations served the dukes of Burgundy and Lorraine, and after being educated with his brothers in Bavaria and Italy, was introduced to the court of Henry IV. in 1598. He became a great favourite of the king and shared to the full in the dissipations of court life. In 1600 he took part in the brief campaign in Savoy, and in 1603 fought in Hungary for the emperor against the Turks. In 1614 he assisted Marie de' Medici in her struggle against the nobles, but upon her failure in 1617 remained loyal to the King Louis XIII. and assisted the royalists when they routed Marie's supporters at Ponts-de-Cé in 1620. His services during the Huguenot rising of 1621-22 won for him the dignity of marshal of France. He was with the army of the king during the siege of La Rochelle in 1628, and in 1629 distinguished himself in the campaign against the rebels of Languedoc. In 1615 Bassompierre had purchased from Henri, duc de Rohan (1579-1638), the coveted position of colonel-general of the Swiss and Grisons; on this account he was sent to raise troops in Switzerland when Louis XIII. marched against Savoy in 1629, and after a short campaign in Italy his military career ended. As a diplomatist his career was a failure. In 1621 he went to Madrid as envoy extraordinary to arrange the dispute concerning the seizure of the Valteline forts by Spain, and signed the fruitless treaty of Madrid. In 1625 he was sent into Switzerland on an equally futile mission, and in 1626 to London to secure the retention of the Catholic ecclesiastics and attendants of Henrietta Maria, wife of Charles I. The personal influence of Henry IV. had deterred Bassompierre from a marriage with Charlotte de Montmorency, daughter of the constable Montmorency, afterwards *princesse de Condé*, and between 1614 and 1630 he was secretly married to Louise Marguerite, widow of François, prince de Conti, and through her became implicated in the plot to overthrow Richelieu on the "Day of Dupes" 1630. His share was only a slight one, but his wife was an intimate friend of Marie de' Medici, and her hostility to the cardinal aroused his suspicions. By Richelieu's orders, Bassompierre was arrested at Senlis on the 25th of February 1631, and put into the Bastille, where he remained until Richelieu's death in 1643. On his release his offices were restored to him, and he passed most of his time at the castle of Tillières in Normandy, until his death on the 12th of October 1646. He left a son, François de la Tour, by the *princesse de Conti*, and an illegitimate son, Louis de Bassompierre, afterwards bishop of Saintes. His *Mémoires*, which are an important source for the history of his time, were first published at Cologne in 1665. He also left an incomplete account of his embassies to Spain, Switzerland and England (Cologne, 1668) and a number of discourses upon various subjects.

The best edition of the *Mémoires* is that issued by the Société de l'Histoire de France (Paris, 1877); see also G. Tallemant des Reaux, *Historiettes de la princesse de Conti, et du maréchal de Bassompierre* (Paris, 1854-1860).

BASSOON (Fr. *basson*; Ger. *Fagott*; Ital. *fagotto*), a woodwind instrument with double reed mouthpiece, a member of the oboe (*g.u.*) family, of which it is the bass. The German and Italian names of the instrument were bestowed from a fancied resemblance to a bundle of sticks, the bassoon being the first instrument of the kind to be doubled back upon itself; its direct ancestor, the bass pommer, 6 ft. in length, was quite straight. The English and French names refer to the pitch of the instrument as the bass of the wood-wind.

The bassoon is composed of five pieces, which, when fitted together, form a wooden tube about 8 ft. long (93 in.) with a conical bore tapering from a diameter of 1½ in., at the bell, to ¾ in. at the reed. The tube is doubled back upon itself, the shorter joint extending to about two-thirds of the length of the longer, whereby the height of the instrument is reduced to about 4 ft. The holes are brought into a convenient position for the fingers by the device of boring them obliquely through the thickness of the wood. The five pieces are:—(1) the bell; (2) the long joint, forming the upper part of the instrument when

played, although its notes are the lowest in pitch; (3) the wing overlapping the long joint and having a projecting flap through which are bored three holes; (4) the butt or lower end of the instrument (when played) containing the double bore necessitated by the abrupt bend of the tube upon itself. Both bores are pierced in one block of wood, the prolongation of the double tube being usually stopped by a flat oval pad of cork in the older models, whereas the modern instruments have instead a U-shaped tube; (5) the crook, a narrow curved metal tube about 12 in. long, to which is attached the double reed forming the mouthpiece.

The performer holds the instrument in a diagonal position; the lower part of the tube (the butt joint) played by the right hand resting against his right thigh, and the little bell, turned upwards, pointing over his left shoulder; a strap round the neck affords additional support. The notes are produced by means of seven holes and 16, 17, or 19 keys. The mechanism and fingering are very intricate. Theoretically the whole construction of the bassoon is imperfect and arbitrary, important acoustic principles being disregarded, but these mechanical defects only enhance its value as an artistic musical instrument. The player is obliged to rely very much on his ear in order to obtain a correct intonation, and next to the strings no instrument gives greater scope to the artist.

The bassoon has an eight foot tone, the compass extending from

B♭ bass  to A♭ treble

 or in modern

instruments by means of additional mechanism to C or even

F . These extra

high notes are from their extreme sweetness called *vox humana*.

The pitch of the bassoon apparently lies two octaves below that of the oboe, since the lowest note of both is B, but in reality the interval is only a twelfth, as may be ascertained by comparing their fundamental scales. On the bassoon the fundamental scale is that of F major, obtained by opening and closing the holes; the notes downwards from F to

B♭  are extra notes obtained by means of

interlocking keys on the long joint, worked by the left thumb; they have no counterpart on the oboe and do not belong to the fundamental scale of the bassoon. The fundamental scale of the oboe is that of C, although the compass has been extended a

tone to B♭ . Therefore the difference in pitch between the bassoon and the oboe is a twelfth. In the first

At Wagner's instigation, the wind-instrument-maker, W. Heckel of Biebrich-am-Rhein, made bassoons with an extra key, extending the compass downwards to A.

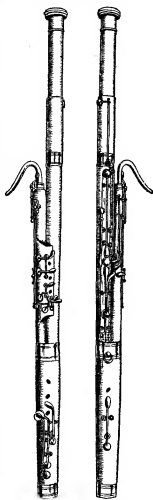

Front view. Back view.
FIG. 1.—Bassoon with 17 keys.
Savary Model.
(Rudall, Carte & Co.)

register of the bassoon, seven semitones



are

obtained, as stated above, by means of keys in the long joint and bell; the next eight notes (holes and keys) each produce two sounds—the fundamental tone, and, by increased pressure of the breath, its harmonic octave. The remaining notes are obtained by cross fingering and by overblowing the notes of the

fundamental scale a twelfth as far as A♭ which

forms the *g.u.* compass. From A to E♭ the *vox humana* notes are produced by the help of small harmonic holes opened by means of keys at the top of the wind joint; exceptional players obtain, without additional keys, two or more higher harmonic notes, which, however, are only used by *virtuosi*. This then forms the intricate scheme of fingering for the bassoon, and in order to appreciate the efforts of such instrument makers as Carl Almenröder in Germany, Triebert and Jancourt in France, Sax in Belgium, Cornelius Ward and Morton in England, to introduce improvements based upon acoustic principles, it is necessary to understand what these general principles are, and why they have been disregarded in the bassoon. In all tubes the note given by the vibrating air column is influenced directly by the length of the tube, but very little, if at all, by the diameter of the bore. The pitch, however, is greatly affected by the diameter of the opening, whether lateral or at the bell, through which the vibrating column of air is again brought into communication with the outer air. The tube only sounds the normal note in proportion to its length, when the diameter of the lateral opening is equal to the internal diameter of the tube at the opening. As in most of our early wood-wind instruments the holes would in that case have been too large to be stopped by the fingers, and key-mechanism was still primitive, instrument-makers resorted to the expedient of substituting a hole of smaller diameter nearer the mouthpiece for one of greater diameter in the position the hole should theoretically occupy. This important principle was well understood by the Romans, and perhaps even by the ancient Greeks, as is proved by existing specimens of the *aulos* (*q.v.*) and by certain passages from the classics.¹

Another curious acoustic phenomenon bears upon the construction of wind instruments, and especially upon the bassoon. When the diameter of the lateral opening or bell is smaller than that of the bore, the portion of the tube below the hole, which should theoretically be as though non-existent, asserts itself, lowering the pitch of the note produced at the hole and damping the tone; this is peculiarly noticeable in the A of the bassoon

whose hole is much too high and too small in diameter.²

To cite an example of the scope of Carl Almenröder's improvements in the bassoon, he readjusted the position of the A hole, stopped by the third finger of the right hand, boring lower down the tube, not one large hole, but two of medium diameter, covered by an open key to be closed by the same finger from the accustomed position; one of these A holes communicates with the narrower bore in the butt joint, and the other with the wider bore. The effect is a perfectly clear, full and accurate tone. Almenröder's other alterations were made on the same principle, and produced an instrument more perfect mechanically and theoretically than Savary's, but lacking some of the characteristics of the bassoon. In Germany Almenröder's improvements³ have been generally adopted and his model with 16 keys is followed by most makers, and notably by Heckel of Biebrich.⁴

¹ Macrobius in *Sonn. Scip.* lib. ii. cap. 4. 5.

² Gottfried Weber, "Verbesserungen des Fagotts," in *Cäcilia* (Mainz, 1825), vol. ii. p. 123.

³ See *Traité sur le perfectionnement du basson, avec 2 tableaux, par Charles Almenröder* (Mayence, Schott), and also the above mentioned article by Gottfried Weber in *Cäcilia*, whose explanations are clearer than those of the inventor.

⁴ For a description of the modern instrument see Victor Charles Mahillon, *Catalogue descriptif et analytique du musée instrumental du Conservatoire Royal de Musique* (Bruxelles, 1896), vol. ii. pp. 275-276, No. 999.

The unwieldy bass pommers of the 15th and 16th centuries led to many attempts to produce a more practical bass for the orchestra by doubling back the long tube of the instrument. Thus transformed, the pommer became a fagotto. The invention of the bassoon or fagotto is ascribed to Afranio, a canon of Ferrara, in a work by his nephew, Theseus Ambrosius Albonesius, entitled *Introducio in Chaldaicam Linguam . . . et descriptio ac Simulacrum Phagoti Afranii* (Pavia, 1539). The illustration of the instrument, showing front and back views (p. 179), taken in conjunction with the detailed description (pp. 33-38), at once disposes of the suggestion that the phagotus of Afranio and the fagotto or bassoon were in any way related; the author himself is greatly puzzled as to the etymology of the word. The phagotus in fact, resembles nothing so much as the musical curiosity known as *flûte-à-bec à colonne*,⁵ but double and played by bellows, assigned by G. Chouquet to the 16th century. This flute consisted of a column, with base and capital, both stopped, the vent and the whistle being concealed within perforated brass boxes, in the upper and lower parts of the column. Afranio's phagotus consisted of two similar twin columns with base and capital containing finger-holes and keys; between the columns in front was a shorter column for ornament, and at the back of it another still shorter whose capital could be lifted, and a sort of bellows or bag-pipe inserted by means of which the instrument was sounded. The first instrument was made, we are told, by Ravilius of Ferrara, from Afranio's design.⁶ Mersenne,⁷ who does not seem to have any difficulty in understanding the construction of Afranio's phagotus, does not consider him the inventor of the fagotto or bassoon, but of another kind of fagotto which he classes with the Neapolitan *sourdeline*, a complicated kind of musette⁸ (see BAG-PIPE). Afranio's instrument consists, he states, of two *bassons* as it were interconnected by tubes and blown by bellows. As in the *sourdeline*, these only speak when the springs (keys) are open. He disposes of Theseus Albonesius's fanciful etymology of the name by showing it to be nothing but the French word *fagot*, and that it was applied because the instrument consists of two or more "flutes," bound or *fagottes* together. There is no evidence that the phagotus contained a reed, which would account for Mersenne calling the pipes flutes. Mersenne's statements thus seem to uphold the theory that Afranio's phagotus was only a double *flûte à colonne* with bellows. Evidence is at hand that in 1555 a contrabass wind instrument was well known as fagotto. In the catalogue of the musical instruments belonging to the Flemish band of Marie de Hongrie in Spain, we find the following: "Ala dichá pñçesa y al dicho matoto dos ynstrumentos de musica contrabaxos, que llaman fagotes, metidos en dos caos redondas como pareçe por el dicho entrego."⁹

Sigmund Schnitzler¹⁰ of Nuremberg (d. 1578), a maker of wind instruments who attained considerable notoriety, has been

⁵ As far as is known only three of these curious instruments are in existence—two in the museum of the Conservatoire (Paris), and one in Brussels; all three bear a trefoil as maker's mark; the smallest, in F, is reproduced in the *Catalogue of the Musical Instruments exhibited at the Royal Military Exhibition, London, 1890*, by Capt. C. R. Day (London, 1891), pl. iv. F. It is also described (without illustration) in Mahillon's *Catalogue*, p. 201, No. 189. The two flutes in Paris, measuring 73 cm. and 94 cm., are described by Gustave Chouquet, *Le Musée du Conservatoire National de Musique—Catalogue descriptif et raisonné* (Paris, 1884), Nos. 409 and 410, p. 106.

⁶ An Italian translation of the description is given by Count L. F. Valdrighi in *Musurgiana*, No. 4 (Milano, 1881). "Il Phagotus di Afranio," p. 40 et seq. (without illustration). An illustration of the phagotus is given by W. J. von Wasielewski in *Gesch. d. Instrumentalmusik im XVI. Jahrh.* (Berlin, 1878), pl. v. and vi., text p. 74.

⁷ See *L'Harmonie universelle* (Paris, 1636), part. i. p. 305.

⁸ *Ibid.*, illustrated and described, bk. v. p. 293.

⁹ See Edm. van der Straeten, *Hist. de la musique aux Pays-Bas*, vol. vii. pp. 433, 436, 448.

¹⁰ J. J. Quantz, Frederick the Great's flute-master, gives France the credit of transforming the bombard (pommer) into the bassoon, and the schalmey into oboe, see *Versuch einer Anweisung die Flöte traversière zu spielen* (Berlin, 1752), p. 24 and again p. 241, § 6.

named as the probable author of the transformation of pommer into bassoon.

We learn from an historical work of the 18th century, that he was renowned "almost everywhere" as a maker of *fagotte* of extraordinary size, of skilful workmanship and pure intonation, speaking easily. Schnitzer's instruments were so highly appreciated not only all over Germany, but also in France and Italy, that he was kept continually at work producing *fagotte* for lovers of music.¹

An earlier chronicler of the artistic celebrities and craftsmen of Nuremberg, Johann Neudorfer, writing in 1549,² names Sigmund Schnitzer merely as *Pfeifenmacher und Stadtpfeifer*. Had he been also noted as an inventor of a new form of instrument, the fellow-citizen and contemporary chronicler would not have failed to note the fact. If Schnitzer had been the first to reduce the great length of the bass pommer by doubling the tube back upon itself, he would hardly have been handed down to posterity as the clever craftsman *who made fagottes of extraordinary size*; Doppelmaier, who chronicles in these eulogistic terms, wrote nearly two centuries after the supposed invention of the fagotto, the value of which was realized later by retro-spection.

An explanation may perhaps be found in Eisel's statement about the *Deutscher Basson*, which he distinguishes from the *Basson* (our bassoon). "The *Deutsche Bassons*, Fagotte or Bombardi, as our German ancestors termed them, before music was clothed in Italian and French style, are no longer in use" (Eisel wrote in 1738) "and therefore it is unnecessary to waste paper on them."³ This refers, of course, to the *bombard* or bass pommer, the extraordinarily long instruments which Schnitzer made so successfully. From this it would seem that our bassoon was not of German origin. In the meanwhile we get a clue to the early history of the pommer in transition, but we find it under a different name in no way connected with *fagotto*. In order to shorten the unwieldy proportions of the tenor pommer in C, and to increase its portability, it was constructed out of a block of wood of rather more than double the diameter of the pommer, in which two bores were cut, communicating at the bottom of the instrument which was flat. The bell and the crook containing the double reed mouthpiece were side by side at the top. This instrument, which had six holes in front and one at the back as well as two keys, was known as the *dulcian*, *dolcian*, *douçaine*, and also in France as *courtaud* and in England as the *curtail*, *curtal*, *curtoll*, &c., being mentioned in 1582—"The common bletting musick of ye Drone, Hobius (Hautboy) and Curtoll." The next step in the evolution produced the double curtail, a converted bass pommer an octave below the single curtail and therefore identical in pitch as in construction with the early fagotto in C. The instrument is shown in fig. 2, the reproduction of a drawing in the MS. of *The Academy of Armoury* by Randle Holme,⁴ written some time before 1688. At the side of the drawing is the following description: "A double curtaille.⁵

¹ J. G. Doppelmaier, *Historische Nachricht von den Nürnbergischen Mathematikern und Künstlern* (Nürnberg, 1790), p. 203.

² See "Nachrichten von Künstlern und Werkleuten Nürnberg aus dem Jahre 1549," in R. Eitelberger von Edelberg's *Quellen-schriften für Kunstgeschichte und Kunsttechnik des Mittelalters* (Vienna, 1875), vols. viii-x.

³ See J. J. Eisel, *Musicus autodidactus oder der sich selbst informierende Musikus* (Erfurt, 1738), pp. 104 and 100, and also J. Mattheson, *Das neu-eröffnete Orchester* (Hamburg, 1713), "Basson," from whom Eisel borrowed.

⁴ See the *New English Dictionary*, and Bateman upon Bartholinus, 423, f. margin.

⁵ British Museum, Harl. MS. 2034, fol. 207b, a reference communicated by Augustus Hughes-Hughes with his valuable appendix to part iii. (Instrumental Music and Works on Music) of a *Catalogue of MS. Music in the British Museum* (London, 1908-1909). The Appendix contains a list of typical musical instruments represented in illuminated MSS., or described in other MSS. in the British Museum, with brief description and full references.

⁶ Compare Randle Holme's *double curtail* with the *dolcian* in C, pl. vi. H. of Capt. C. R. Day's catalogue, and with a *dolcian* or single curtail by J. C. Denner in Paul de Wit's *Katalog des Musikhistorischen Museums von Pest de Wit* (Leipzig, 1903), p. 127, No. 380, and illust. p. 121 (Collection now transferred to Cologne). Consult also

This is double the bigness of the single, mentioned ch. xvi. n. 6" (the MS. begins at ch. xvii. of bk. 3) "and is played 8 notes deeper. It is as it were 2 pipes fixed in on(e) thick bass pipe, one much longer than the other, from the top of the lower comes a crooked pipe of brass in which is fixed a reed, through it the wind passeth to make the instrument make a sound. It hath 6 holes on the outside and one on that side next the man or back part and 2 brass keys, the highest called double *La sol re*, and the other double *B mi*."

We may therefore conclude that the satirical name *fagotto*, presumably bestowed in Italy, since the French equivalent *bagotte* was never used for the *basson*, was not necessarily applied to the new form of pommer at the outset, but in any case before 1555; that the very term *Phagoto d'Afranio*, by which the instrument was known during its short fabulous existence, with its pretended Greek etymology, presupposes the pre-existence in Italy of another *fagotto* with which Afranio was acquainted, perhaps imperfectly. Afranio's was the age of ingenious mechanical devices applied to musical instruments, many of which, like Afranio's, being mere freaks, did not survive the inventor. A document selected from the valuable archives published by Edm. van der Straeten⁷ suggests a satisfactory clue: In 1426 Louis Willay, a musical instrument maker of Bruges, sold to Philippe le Bon a triple set of wood-wind instruments, i.e. "4 bombardes, 4 douçaines and 4 flutes," to be sent as a gift to Nicolas III., marquis of Ferrara. The new instrument, the douçaine, we may imagine, by its unusual appearance provoked the satirical wit of some courtier, and was henceforth known as *fagotto*. Just a century later Ravilius of Ferrara made Afranio's first phagotus from the inventor's design.

The bassoon has been a favourite with all the great masters, excepting Handel. Beethoven uses the bassoon largely in his symphonies, writing everywhere for it independent parts of great beauty and originality. Bach, in his mass in B min., has parts for two bassoons. Mozart wrote a concerto in B \flat for bassoon, with orchestra (Kochel, No. 191). Weber has also written a concerto for bassoon in F (op. 75), scored for full orchestra.

See also Etienne Ozi, *Nowelle Methode du Bassoon* (Paris, 1788 and 1800); J. B. J. Willent-Bordogny, *Gran Methodo completo per il Fagotto* (Milan, 1844), with illustrations of early bassoons (English edition, London, J. R. Lafleur & Son); Joseph Fröhlich, *Vollständige Musikschule für alle beyhm Orchester gebräuchliche wichtigere Instrumente* (many practical illustrations) (Cologne, Bonn, 1811); article "Bassoon," by W. H. Stone and D. J. Blakley in *Grove's Dictionary of Music and Musicians* (2nd ed.); article "Fagott" in Mendel's *Musikalisches Conversations-Lexikon*; for the history of the instrument, and of its prototypes, see OBE and BOMBARD.

(K. S.)

BASSO-RELIEVO (Ital. for "low relief"), the term applied to sculpture in which the design projects but slightly from the plane of the background. The relief may not project at all from the original surface of the material, as in the sunken reliefs of the Egyptians, and may be nearly flat, as in the Panathenaic procession of the Parthenon. In the early 19th century the term *basso-relievo*, or "low relief," came to be employed loosely for all forms of relief, the term *mezzo-relievo* having already dropped out of general use owing to the difficulty of accurate application.

BASS ROCK, THE, a small island in the Firth of Forth, about 2 m. from Canty Bay, Haddingtonshire, Scotland. It is circular in shape, measuring a mile in circumference, and is 350 ft. high. Mersenne, *op. cit.*, and Michael Praetorius, *Synagoga Musicum* (Wolffenbüttel, 1618), both of whom describe and figure these forms of early bassoons.

⁷ *Op. cit.* vol. vii. p. 38.

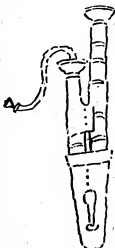

FIG. 2.—Old English double curtail (before 1688).

(From Harl. MS. 2034 in Brit. Mus.)

On three sides the cliffs are precipitous, but they shelve towards the S.W., where landing is effected. The Bass Rock is an intrusive mass of phonolitic trachyte or orthophyre. No nepheline has been detected in the rock, but analcite is present in small quantity together with abundant orthoclase and green sod-augite. It bears a close resemblance to the eruptive masses of North Berwick Law and Traprain Law, but is non-porphyrific. It is regarded by Sir A. Geikie as a plug filling an old volcanic vent, from which lava emanated during the Calciferous Sandstone period. It used to be grazed by sheep, of which the mutton was thought to be unusually good, but its principal denizens are sea-birds, chiefly solan geese, which haunt the rock in vast numbers. A lighthouse with a six-flash lantern of 39,000 candle power was opened in 1902. For a considerable distance E. and W. there runs through the rock a tunnel, about 15 ft. high, accessible at low water. St Baldred, whose name has been given to several of the cliffs on the shore of the mainland, occupied a hermitage on the Bass, where he died in 756. In the 14th century the island became the property of the Lauders, called afterwards Lauders of the Bass, from whom it was purchased in 1671 by government, and a castle with dungeons was erected on it, in which many Covenanters were imprisoned. Among them were Alexander Peden (1626-1686), for four years, and John Blackadder (1615-1686), who died there after five years' detention. At the Revolution four young Jacobites captured the Rock, and having been reinforced by a few others, held it for King James from June 1691 to April 1694, only surrendering when threatened by starvation. Thus the island was the last place in Great Britain to submit to William III. Dismantled of its fortifications in 1701, the Bass passed into the ownership of Sir Hew Dalrymple, to whose family it belongs. It is let on annual rental for the feathers, eggs, oil and young of the sea-birds and for the fees of visitors, who reach it usually from Canty Bay and North Berwick.

BASSUS, AUFIDIUS, a Roman historian, who lived in the reign of Tiberius. His work, which probably began with the civil wars or the death of Caesar, was continued by the elder Pliny, who, as he himself tells us, carried it down at least as far as the end of Nero's reign. The *Bellum Germanicum* of Bassus, which is commended, may have been either a separate work or a section of his general history. The elder Seneca speaks highly of him as an historian, but the fragments preserved in that writer's *Suasoriae* (vi. 23) relating to the death of Cicero, are characterized by an affected style.

Pliny, *Nat. Hist.*, præfatio, 20; Tacitus, *Dialogus de Oratoribus*, 23; Quintilian, *Instit.* x. 1. 103.

BASSUS, CAESIUS, a Roman lyric poet, who lived in the reign of Nero. He was the intimate friend of Persius, who dedicated his sixth satire to him, and whose works he edited (Schol. on Persius, vi. 1). He is said to have lost his life in the eruption of Vesuvius (79). He had a great reputation as a poet; Quintilian (*Instit.* x. 1. 96) goes so far as to say that, with the exception of Horace, he was the only lyric poet worth reading. He is also identified with the author of a treatise *De Metris*, of which considerable fragments, probably of an abbreviated edition, are extant (ed. Keil, 1885). The work was probably originally in verse, and afterwards recast or epitomized in prose form to be used as an instruction book. A well known and scanty account of some of the metres of Horace (in Keil, *Grammatici Latini*, vi. 305), bearing the title *Ars Caesii Bassi de Metris* is not by him, but chiefly borrowed by its unknown author from the treatise mentioned above.

BASSUS, CASSIANUS, called SCHOLASTICUS (lawyer), one of the *geoponici* or writers on agricultural subjects. He lived at the end of the 6th or the beginning of the 7th century A.D. He compiled from earlier writers a collection of agricultural literature (*Geoponica*) which was afterwards revised by an unknown editor and published about the year 950, in the reign of Constantine Porphyrogenitus, to whom the work itself has been ascribed. It contains a full list of the authorities drawn upon, and the subjects treated include agriculture, birds, bees, horses, cattle, sheep, dogs, fishes and the like.

COMPLETE EDITIONS.—Needham (1704), Niclas (1781), Beckh (1895); see also Gemoll in *Berliner Studien*, i. (1884); Oeder in *Rheinisches Museum*, xlv. (1890), xlviii. (1893), and De Raynal in *Annuaire de l'Assoc. pour l'Encouragement des Études Grecques*, viii. (1874).

BASSUS, SALIENS, Roman epic poet, a contemporary of Valerius Flaccus, in the reign of Vespasian. Quintilian credits him with a vigorous and poetical genius (*Instit.* x. 1. 90) and Julius Secundus, one of the speakers in Tacitus *Dialogus de Oratoribus* (5; see also 9) styles him a perfect poet and most illustrious bard. He was apparently overtaken by poverty, but was generously treated by Vespasian, who made him a present of 500,000 sesterces. Nothing from his works has been preserved; the *Laus Pisonis*, which has been attributed to him, is probably by Titus Calpurnius Siculus (J. Held, *De Saliis Basso*, 1834).

BASSVILLE, or **BASSEVILLE, NICOLAS JEAN HUGON DE** (d. 1793), French journalist and diplomatist, was born at Abbeville on the 7th of February 1753. He was trained for the priesthood, taught theology in a provincial seminary and then went to Paris. Here in 1784 he published *Éléments de mythologie* and some poems, which brought him into notice. On the recommendation of the prince of Condé he became tutor to two young Americans travelling in Europe. With them he visited Berlin, made the acquaintance there of Mirabeau, and became a member of the Berlin Academy Royal. At the outbreak of the Revolution he turned to journalism, becoming editor of the *Mercurie international*. Then, through the Girondist minister Lebrun-Toudu, he entered the diplomatic service, went in May, 1792, as secretary of legation to Naples and was shortly afterwards sent, without official status, to Rome. Here his conduct was anything but diplomatic. He at once announced himself as the protector of the extreme Jacobins in Rome, demanded the expulsion of the French *émigrés* who had taken refuge there, including the "demoiselles Capet," and ordered the *fleur-de-llys* on the escutcheon of the French embassy to be replaced by a picture of Liberty painted by a French art student. He talked at large of the "purple geese of the Capitol" and met the remonstrances of Cardinal Zelada, the papal secretary of state, with insults. This enraged the Roman populace; a riot broke out on the 13th of January 1793, and Bassville, who was driving with his family to the Corso, was dragged from his carriage and so roughly handled that he died. The affair was magnified in the Convention into a deliberate murder of the "representative of the Republic" by the pope's orders. In 1797 by an article of the treaty of Tolentino the papal government agreed to pay compensation to Bassville's family. Among his writings we may also mention *Mémoires historiques, critiques et politiques sur la Révolution de France* (Paris 1790; English trans. London, 1790).

See F. Masson, *Les Diplomates de la Révolution* (Paris, 1882); Silvagni, *La Corte e la Società romana nei secoli XVIII. e XIX.* (Florence, 1881).

BASTAR, a feudatory state of British India, in the Chhattisgarh division of the Central Provinces; area, 13,062 sq. m. In 1901 the population was 306,501, showing a decrease of 1% compared with an apparent increase of 58% in the preceding decade. Estimated revenue £2,200; tribute £1100. The eastern part of Bastar is a flat elevated plateau, from 1800 to 2000 ft. above the level of the sea, the centre and N.W. portions are very mountainous, and the southern parts consist of hills and plains. On the plateau there are but few hills; the streams run slowly and the country is a mixture of plain and undulating ground covered by dense *sal* forests. Principal mountains of the district: (1) a lofty range which separates it from the Sironcha district; (2) a range of equal height called the Bela Dila lying in the centre of the district; (3) a range running N. and S. near Narayanpur; (4) Tangri Dongri range, running E. and W.; (5) Tulsi Dongri, bordering on the Sabari river and the Jaipur state. There is also a small range running from the river Indravati to the Godavari. The Indravati, the Sabari and the Tal or Talper, are the chief rivers of the district; all of them affluents of the Godavari. The soil throughout the greater portion of Bastar consists of light clay, with an admixture of sand, suited

for raising rice and wet crops. In the jungles the Marias, who are among the aboriginal tribes of Gond origin, raise kosra (*Panicum italicum*) and other inferior grains. Aboriginal races generally follow the migratory system of tillage, clearing the jungle on selected patches, and after taking crops for two or three years abandoning them for new ground. They do not use the plough; nor do they possess buffaloes, bullocks or cows; their only agricultural implement is a long-handled iron hoe. They are a timid, quiet, docile race, and although addicted to drinking not quarrelsome. They inhabit the densest jungles and are very shy, avoiding contact with strangers, and flying to the hills on the least alarm; but they bear a good character for honesty and truthfulness. They are very scantily dressed, wear a variety of trinkets, with a knife, hatchet, spear, bow and arrows, the only weapons they use. Their hair is generally shaved, excepting a topknot; and when not shaved it gets into a matted, tangled mass, gathered into a knot behind or on the crown. The Marias and the Jhurias are supposed to be a subdivision of the true Gond family. All the aboriginal tribes of Bastar worship the deities of the Hindu pantheon along with their own national goddess Danteswari.

Bastar is divided into two portions—that held by the Raja or chief himself, and that possessed by feudatory chiefs under him. The climate is unhealthy—fever, smallpox, dysentery and rheumatism being the prevailing diseases. Jagdalpur, Bijapur, Madder and Bhupalpatnam are the only places of any note in the dependency, the first (on the Indravati river) being the residence of the raja and the chief people of the state. The principal products are rice, oil-seeds, lac, tussur silk, horns, hides, wax and a little iron. Teak timber is floated down the rivers to the Madras coast. A good road has brought Jagdalpur into connexion with the railway at Raipur.

BASTARD (O. Fr. *bastard*, mod. *bâtard* = *fils de bast*, "pack-saddle child," from *bast*, saddle), a person born out of legal wedlock. Amongst the Romans, bastards were classified as *nothi*, children born in concubinage, and *spurii*, those not so born. Both classes had a right of succession to their mother, and the *nothi* were entitled to support from their father, but had no rights of inheritance from him. Both, however, had in other respects most of the rights of citizenship. The Germanic law was based upon an entirely different principle. It recognized as legitimate only those whose parents were of the same social rank. All others were regarded as bastards, and took the status of the parent of inferior rank. The aim of all the Germanic codes was to preserve purity of race, not to improve morals, for incestuous unions are not censured. The influence of the Germanic law lasted throughout the early feudal period, and bastards were debarred rights of inheritance. In the 13th century the influence of Roman law tended again to modify this severity. An exception was probably made in the case of those whose fathers were of royal blood, in which case it even seems that no stigma was attached to the accident of their birth, nor did they suffer from the usual disabilities as to inheritance which attended those of illegitimate birth (Gregory of Tours, v. 25). Among the Franks we find Theodoric I., a natural son of Clovis, sharing the kingdom with the legitimate sons; Zwentibold, natural son of Arnulf, was created king of Lorraine by his father in 895; and even William the Conqueror actually assumed the appellation of bastard.

In English law a bastard still retains certain disabilities. His rights are only such as he can acquire; for civilly he can inherit nothing, being looked upon as the son of nobody, and sometimes called *filius nullius*, sometimes *filius populi*. This, however, does not hold as to moral purposes, e.g. he cannot marry his mother or bastard sister. Yet he may gain a surname by reputation though he has none by inheritance, and may even be made legitimate and capable of inheriting by the transcendent power of an act of parliament.

For poor-law purposes, all legitimate children take the settlement of their father, but a bastard takes the settlement of its mother. The mother of an illegitimate child is entitled to its custody in preference to the father, and consequently the responsibility of its support falls primarily on her. But the

English law has always recognized the principle that to a certain extent the father must share in that responsibility. This, however, was imposed not with the idea of furnishing the woman with a civil remedy, nor to have a penal effect against the man, but solely to prevent the cost of maintenance of the bastard child from falling upon the parish. Indeed, the legislation upon the subject, which dates back to 1576, was until 1845 an intimate part of the poor law. The act of 1576, the basis of English bastardy law, empowered justices to take order for the punishment of the mother and reputed father of every bastard child left to the care of the parish, and to charge the mother and reputed father with the payment of a weekly sum or other needful sustenance. Other acts were passed in 1600 and 1733, enabling the mother of any child chargeable or likely to become chargeable to the parish to secure the apprehension, and even the imprisonment, of the father until he should indemnify the parish, provisions which were made somewhat more stringent by acts passed in 1809 and 1810. In 1832 a commission was appointed to inquire into the operation of the poor laws, and the commissioners in their report gave great attention to the subject of bastardy. They reviewed the various acts from 1576 downwards and gave examples of their operation. The conclusion to which the commissioners came was that the laws "which respect bastardy appear to be pre-eminently unwise," and that they gave rise to many abuses. For example, the weekly payment recovered by the parish was usually transferred to the mother; even in many cases guaranteed. The commissioners recommended that the mother alone should be responsible for the maintenance of the child. "This," they said, "is now the position of a widow, and there can be no reason for giving to vice privileges which we deny to misfortune." Acting on the recommendation of the commissioners the Poor Law Amendment Act of 1834 endeavoured to discourage the principle of making the putative father contribute by introducing a somewhat cumbersome method of procedure. The trend of public opinion proved against the discouragement of affiliation, and an act of 1839 transferred jurisdiction in affiliation cases from quarter-sessions to petty-sessions. A commission of inquiry on the working of the bastardy acts in 1844 recommended "that affiliation should be facilitated," and, accordingly, by the Bastardy Act of 1845 effect was given to this recommendation by giving the mother an independent civil remedy against the putative father and dissociating the parish altogether from the proceedings. Subsequently, legislation gave the parish the right of attaching, and in some cases suing for, money due from the putative father for the maintenance of the child. The existing law is set out under AFFILIATION.

The incapacities attaching to a bastard consist principally in this, that he cannot be heir to any one; for being *nullius filius*, he is therefore of kin to nobody, and has no ancestor from whom an inheritable blood can be derived. Therefore, if there be no other claimant upon an inheritance than such illegitimate child, it escheats to the lord. And as bastards cannot be heirs themselves, so neither can they have any heirs but those of their own bodies; for as all collateral kindred consists in being derived from the same common ancestor, and as a bastard has no legal ancestor, he can have no collateral kindred, and consequently no legal heirs, except such as claim by a lineal descent from himself. And hence, if a bastard purchase land, and die seised thereof without issue and intestate, the land escheats to the lord of the fee. Originally a bastard was deemed incapable of holy orders, and disqualified by the fact of his birth from holding any dignity in the church; but this doctrine is now obsolete, and in all other respects there is no distinction between a bastard and another man. By the law of Scotland a bastard is not only excluded from his father's succession, because the law knows no father who is not marked out by marriage; and from all heritable succession, whether by the father or mother, because he cannot be pronounced lawful heir by the inquest in terms of the brief; but also from the movable succession of his mother, because he is not her lawful child, and legitimacy is implied in all succession deferred by the law. But a bastard, although he cannot succeed

jure sanguinis, may succeed by destination, where he is specially called to the succession by entail or testament. In Scotland, as in England, a bastard can have no legal heirs except those of his own body; and hence, failing his lawful issue, the king succeeds to him as last heir. Formerly bastards in Scotland without issue of their own could not make a will, but this disability was removed by a statute of 1835. If bastards or other persons without kindred die intestate without wife or child, their effects go to the king as *ultimus haeres*; but a grant is usually made of them by letters patent, and the grantee becomes entitled to the administration.

According to the common law, which is the law of England, a bastard cannot be divested of his state of illegitimacy, unless by the supreme power of an act of parliament. But in those countries which have followed the Roman or civil law, a bastard's status may be provisional, and he can be made legitimate by the subsequent marriage of his parents. (See LEGITIMACY AND LEGITIMATION; and, for statistics, ILLEGITIMACY.)

AUTHORITIES.—Bacquet, *Traité de la bâtardise* (1608); Du Cange, *Gloss. Lat.*, infra "Bastardus"; L. G. Koenigswater, *Histoire de l'organisation de la famille en France* (1851), and *Essai sur les enfants hors mariage* (1842); E. D. Glasson, *Histoire des droits et des institutions de l'Angleterre* (6 vols., 1882–1883), *Histoire du droit et des institutions de la France* (1887); Pollock and Maitland, *History of English Law* (1898); Stephen's *Commentaries*; Nicholls and Mackay, *History of the English Poor Law* (3 vols., 1898).

BASTARNAE, the easternmost people of the Germanic race, the first to come into contact with the ancient world and the Slavs. Originally settled in Galicia and the Bukovina, they appeared on the lower Danube about 200 B.C., and were used by Philip V. of Macedon against his Thracian neighbours. Defeated by these the Bastarnae returned north, leaving some of their number (hence called Peucini) settled on Peuce, an island in the Danube. Their main body occupied the country between the eastern Carpathians and the Danube. As allies of Perseus and of Mithradates the Great, and lastly on their own account, they had hostile relations with the Romans who in the time of Augustus defeated them, and made a peace, which was disturbed by a series of incursions. In these the Bastarnae after a time gave place to the Goths, with whom they seem to have amalgamated, and we last hear of them as transferred by the emperor Probus to the right bank of the Danube. Polybius and the authors who copy him regard the Bastarnae as Galatae; Strabo, having learned of the Romans to distinguish Celts and Germans, first allows a German element; Tacitus expressly declares their German origin but says that the race was degraded by intermarriage with Sarmatians. The descriptions of their bodily appearance, tribal divisions, manner of life and methods of warfare are such as are applied to either race. No doubt they were an outpost of the Germans, and so had absorbed into themselves strong Celtic, Celtic and Sarmatian elements. (E. H. M.)

BASTI, a town and district of British India, in the Gorakhpur division of the United Provinces. The town, a collection of villages, is on the river Kuana, 40 m. from Gorakhpur by railway. The population in 1901 was 14,761. It has no municipality. The district has an area of 2792 sq. m. It stretches out in one vast marshy plain, draining towards the south-east, and traversed by the Rapti, Kuana, Banganga, Masdih, Jamwar, Ami and Katneihia rivers. The tract lying between these streams consists of a rich alluvial deposit, more or less subject to inundations, but producing good crops of rice, wheat and barley. In 1901 the population was 1,846,133, showing an increase of 3% in the decade. A railway from Gorakhpur to Gonda runs through the district, and the river Gogra is navigable. A large transit trade is conducted with Nepal. The export trade of the district itself is chiefly in rice, sugar and other agricultural produce.

BASTIA, a town and seaport on the eastern coast of the island of Corsica, 98 m. N.N.E. of Ajaccio by rail. Pop. (1906) 24,509. Bastia, the chief commercial town in Corsica, consists of the densely-populated quarter of the old port with its labyrinth of steep and narrow streets, and of a more modern quarter to the north, which has grown up round the new port. La Traverse, a fine boulevard, intersects the town from north to south. Rising

from the sea-shore like an amphitheatre, Bastia presents an imposing appearance, which is enhanced by the loftiness of its houses; it has, however, little of architectural interest to offer. Its churches, of which the largest is San Giovanni Battista, are florid in decoration, as are the law-court, the theatre and the hôtel-de-ville. The citadel, which dominates the old port, has a keep of the 14th century. As capital of an arrondissement, Bastia is the seat of a tribunal of first instance and a sub-prefect, while it is also the seat of the military governor of Corsica, of a court of appeal for the whole island, of a court of assizes, and of a tribunal and a chamber of commerce, and has a lycée, a branch of the Bank of France, and a library with between 30,000 and 40,000 volumes. The town has active commerce, especially with Italy. The new port has 1100 ft. of quays, served by a railway, and with a depth alongside of 25 ft. The total number of vessels entered in 1907 was 721 with a tonnage of 337,551, of which 203,950 were French. The chief exports are chestnut extract for tanning, cedrates, citrons, oranges, early vegetables, fish, copper ore and antimony ore. Imports include coal, grain, flour and wine. Industry consists chiefly in fishing (sardines, &c., and coral), the manufacture of tobacco, oil-distilling, tanning, and the preparation of preserved citrons and of macaroni and similar provisions.

Bastia dates from the building of the Genoese fortress or "bastille" by Lionello Lomellino in 1383. Under the Genoese it was long the principal stronghold in the north of the island, and the residence of the governor; and in 1553 it was the first town attacked by the French. On the division of the island in 1797 into the two departments of Golo and Liamone, Bastia remained the capital of the former; but when the two were again united Ajaccio obtained the superiority. The city was taken by the English in 1745 and again in 1794.

BASTIAN, ADOLF (1826–), German ethnologist, was born at Bremen on the 26th of June 1826. He was educated as a physician, but from his early years devoted himself to travel. Proceeding to Australia in 1851 as surgeon on a vessel, he had visited almost every part of the world before his return in 1859. In 1861 he made an expedition to the Far East which lasted five years. Upon his return he commenced the publication of his great work on *The Peoples of Eastern Asia*, an immense storehouse of facts owing little to arrangement or style. He settled in Berlin, where he was made professor of ethnology at the university and keeper of the ethnological museum. He succeeded R. Virchow as president of the Berlin Anthropological Society, and to him was largely due the formation in 1878 of the German Africa Society of Berlin, which did much to encourage German colonization in Africa. Later he undertook further scientific travels in Africa, South America and India. The results of these explorations were made public in a long series of separate publications comprising several on Buddhism, and on the psychological problems presented by native superstitions. Bastian also edited the *Zeitschrift für Ethnologie* from 1869, in conjunction with Virchow and Robert von Hartmann. On his seventieth birthday, 1896 (during which year he started on an expedition to Malaysia), he was presented with a volume of essays composed by the most distinguished ethnologists in celebration of the event and dedicated to him. Among his more important works may be mentioned:—*Der Mensch in der Geschichte* (Leipzig, 1860); *Die Völker des östlichen Asien* (Jena, 1866–1871); *Ethnologische Forschungen* (Leipzig, 1871–1873); *Die Kulturländer des alten Amerika* (Berlin, 1878); *Der Buddhismus in seiner Psychologie* (Berlin, 1881); *Indonesien* (Leipzig, 1884); *Der Fetisch an der Küste Guineas* (Berlin, 1885); *Die mikronesischen Kolonien* (1890–1900); *Die wechselnden Phasen im geschichtlichen Sehkreis und ihre Rückwirkung auf die Völkerkunde* (1900).

BASTIAT, FRÉDÉRIC (1801–1850), French economist, was the son of a merchant of Bayonne, and was born in that town on the 29th of June 1801. Educated at the colleges of Saint-Sever and of Sorèze, he entered in 1818 the counting-house of his uncle at Bayonne. The practical routine of mercantile life being distasteful to him, in 1825 he retired to a property at Mugron, of which he became the owner on the death of his grandfather.

Here Bastiat occupied himself with farming, his leisure being devoted to study and meditation. He welcomed with enthusiasm the Revolution of 1830. In 1831 he became a *juge de paix* of his canton, and in 1832 a member of the *conseil général* of the Landes. In 1834 he published his first pamphlet, and between 1841 and 1844 three others, all on questions of taxation affecting local interests. During this period an accidental circumstance led him to become a subscriber to an English newspaper, the *Globe and Traveller*, through which he was made acquainted with the nature and progress of the crusade of the Anti-Corn-Law League against protection. After studying the movement for two years, he resolved to inaugurate a similar movement in France. To prepare the way, he contributed in 1844 to the *Journal des Économistes* an article "Sur l'influence des tarifs anglais et français," which attracted great attention, and was followed by others, including the first series of his brilliant *Sophismes Économiques*.

In 1845 Bastiat came to Paris in order to superintend the publication of his *Cobden et la Ligue, ou l'agitation anglaise pour la liberté des échanges*, and was very cordially received by the economists of the capital. From Paris he went to London and Manchester, and made the personal acquaintance of Cobden, Bright and other leaders of the league. When he returned to France he found that his writings had been exerting a powerful influence; and in 1846 he assisted in organizing at Bordeaux the first French Free-Trade Association (*Association pour la Liberté des Échanges*). The rapid spread of the movement soon required him to abandon Mugron for Paris.

During the eighteen months which followed this change his labours were prodigious. He acted as secretary of the central committee of the association, organized and corresponded with branch societies, waited on ministers, procured subscriptions, edited a weekly paper, the *Libre-Échange*, contributed to the *Journal des Économistes* and to three other periodicals, addressed meetings in Paris and the provinces, and delivered a course of lectures on the principles of political economy to students of the schools of law and of medicine. The cause to which he thus devoted himself at the expense of his health and life appeared for a time as if it would be successful; but the forces in its favour were much weaker and those opposed to it were much stronger in France than in England, and this became more apparent as the struggle proceeded, until it was brought to an abrupt end by the Revolution of February 1848. This event made the socialistic and communistic principles, which had been gathering and spreading during the previous thirty years, temporarily supreme. (See NATIONAL WORKSHOPS.) In this grave crisis Bastiat nobly performed his duty. Although exhausted by the far too heavy labours in which he had been engaged, although robbed of his voice by the malady which was preying upon him, so that he could do but little to defend the truth from the tribune of the Constituent Assembly, he could still suggest wise counsels in the committee of finance of which he was vice-president, and he could still use his pen with a vigour and dexterity which made him capable of combating single-handed many opponents.

He wrote in rapid succession a series of brilliant and effective pamphlets and essays, showing how socialism was connected with protection, and exposing the delusions on which it rested. Thus within the space of two years there appeared *Propriété et Loi, Justice et Fraternelle, Propriété et Spoliation, L'État, Baccalauréat et Socialisme, Protectionisme et Communisme, Capital et Rente, Mauduit Argent, Spoliation et Loi, Gratuité du Crédi, et Ce qu'on voit et ce qu'on ne voit pas*. While thus occupied he was meditating the composition of a great constructive work, meant to renovate economical science by basing it on the principle that "interests, left to themselves, tend to harmonious combinations, and to the progressive preponderance of the general good." The first volume of this work *Les Harmonies économiques* was published in the beginning of 1850. In the autumn of that year, when working on the second volume, the increase of his malady compelled him to go to Italy. After lingering at Pisa and Florence he reached Rome, but only to die there on the 24th of December 1850 in the fiftieth year of his age.

The life-work of Bastiat, in order to be fairly appreciated, requires to be considered in three aspects. (1) He was the advocate of free-trade, the opponent of protection. The general principles of free-trade had, of course, been clearly stated and solidly established before he was born, but he did more than merely restate them. He showed, as no one before him had done, how they were practically applicable to French agriculture, trade and commerce; and in the *Sophismes Économiques* we have the completest and most effective, the wisest and the wittiest exposure of protectionism in its principles, reasonings and consequences which exists in any language. (2) He was the opponent of socialism. In this respect also he had no equal among the economists of France. He alone fought socialism hand to hand, body to body, as it were, not caricaturing it, not denouncing it, not criticizing under its name some merely abstract theory, but taking it as actually presented by its most popular representatives, considering patiently their proposals and arguments, and proving conclusively that they proceeded on false principles, reasoned badly and sought to realize generous aims by foolish and harmful means. Nowhere will reason find a richer armoury of weapons available against socialism than in the pamphlets published by Bastiat between 1848 and 1850. (3) He attempted to expound in an original and independent manner political economy as a science. In combating, first, the Protectionists, and, afterwards, the Socialists, there gradually rose on his mind a conception which seemed to him to shed a flood of light over the whole of economical doctrine, and, indeed, over the whole theory of society, viz. the harmony of the essential tendencies of human nature. The radical error, he became always more convinced, both of protectionism and socialism, was the assumption that human interests, if left to themselves would inevitably prove antagonistic and anti-social, capital robbing labour, manufactures ruining agriculture, the foreigner injuring the native, the consumer the producer, &c.; and the chief weakness of the various schools of political economy, he believed, he had discovered in their imperfect apprehension of the truth that human interests, when left to themselves, when not arbitrarily and forcibly interfered with, tend to harmonious combination, to the general good.

His *Œuvres complètes* are in 7 vols. The first contains at interesting *Memoir* by M. Paillottet.

BASTIDE, JULES (1800-1879). French publicist, was born at Paris on the 22nd of November 1800. He studied law for a time, and afterwards engaged in business as a timber merchant. In 1821 he became a member of the French Carbonari, and took a prominent part in the Revolution of 1830. After the "July Days" he received an artillery command in the national guard. For his share in the *émeute* in Paris (5th of June 1832) on the occasion of the funeral of General Maximilien Lamarque, Bastide was sentenced to death but escaped to London. On his return to Paris in 1834 he was acquitted, and occupied himself with journalism, contributing to the *National*, a republican journal of which he became editor in 1836. In 1847 he founded the *Revue nationale* with the collaboration of P. J. Buchez (q.v.), with whose ideas he had become infected. After the Revolution of February 1848 Bastide's intimate knowledge of foreign affairs gained for him a secretarial post in the provisional government, and, after the creation of the executive commission, he was made minister of foreign affairs. At the close of 1848 he threw up his portfolio, and, after the *coup d'état* of December 1851, retired into private life. He died on the 2nd of March 1879. His writings comprise *De l'éducation publique en France* (1847); *Histoire de l'assemblée législative* (1847); *La République française et l'Italie en 1848* (1858); *Histoire des guerres religieuses en France* (1859).

BASTIDE (Provençal *bastido*, building), a word applied to the fortified towns founded in south-western France in the middle ages, and corresponding to the *villes neuves* of northern France. They were established by the abbays, the nobles and the crown, frequently by two of these authorities in co-operation, and were intended to serve as defensive posts and centres of population for sparsely-inhabited districts. In addition, they formed a source of revenue and power for their founders, who on their part conceded liberal charters to the new towns. They were their

built on a rectangular plan, with a large central square and straight thoroughfares running at right angles or parallel to one another, this uniformity of construction being well exemplified in the existing *bastide* of Monpazier (Dordogne) founded by the English in 1284. Mont-de-Marsan, the oldest of the *bastides*, was founded in 1141, and the movement for founding them lasted during the 12th, 13th and 14th centuries, attaining its height between 1250 and 1350.

See E. Ménauld, *Les Villes Nouvelles, leur origine et leur influence dans le mouvement communal* (Paris, 1869); Curie-Seimbrus, *Essai sur les villes fondées dans le sud-ouest de la France sous le nom de bastides* (Toulouse, 1880).

BASTIEN-LEPAGE, JULES (1848-1884), French painter, was born in the village of Damvillers, Meuse, France, on the 1st of November 1848 and spent his childhood there. He first studied at Verdun, and prompted by a love of art went in 1867 to Paris, where he was admitted to the Ecole des Beaux-arts, working under Cabanel. After exhibiting in the Salons of 1870 and 1872 works which attracted no attention, in 1874 he made his mark with his "Song of Spring," a study of rural life, representing a peasant girl sitting on a knoll looking down on a village. His "Portrait of my Grandfather," exhibited in the same year, was not less remarkable for its artless simplicity and received a third-class medal. This success was confirmed in 1875 by the "First Communion," a picture of a little girl minutely worked up as to colour, and a "Portrait of M. Hayem." In 1875 he took the second Prix de Rome with his "Angels appearing to the Shepherds," exhibited again in 1878. His next endeavour to win the Grand Prix de Rome in 1876 with "Priam at the Feet of Achilles" was again unsuccessful (it is in the Lille gallery), and the painter determined to return to country life. To the Salon of 1877 he sent a full-length "Portrait of Lady L." and "My Parents"; and in 1878 a "Portrait of M. Theuriot" and "The Hayfield." The last picture, now in the Luxembourg, is regarded as a typical work from its stamp of realistic truth. Thenceforth Bastien-Lepage was recognized in France as the leader of a school, and his "Portrait of Mme Sarah Bernhardt" (1879), painted in a light key, won him the cross of the Legion of Honour. In 1880 he exhibited a small portrait of M. Andrieux and "Joan of Arc listening to the Voices"; and in the same year, at the Royal Academy, the little portrait of the "Prince of Wales." In 1881 he painted "The Beggar" and the "Portrait of Albert Wolf"; in 1882 "Le Père Jacques"; in 1883 "Love in a Village," in which we find some trace of Courbet's influence. His last dated work is "The Forge" (1884). The artist, long ailing, had tried in vain to re-establish his health in Algiers. He died in Paris on the 10th of December 1884, when planning a new series of rural subjects. Among his more important works may also be mentioned the portrait of "Mme J. Drouet" (1883); "Gambetta on his death-bed," and some landscapes; "The Vintage" (1880), and "The Thames at London" (1882). "The Little Chimney-Sweep" was never finished. An exhibition of his collected works was opened in March and April 1885.

See A. Theuriot, *Bastien-Lepage* (1885—English edition, 1892); L. de Fourcaud, *Bastien-Lepage* (1885). (H. F. A.)

BASTILLE (from Fr. *bastir*, now *bâtir*, to build), originally any fortified building forming part of a system of defence or attack; the name was especially applied to several of the principal points in the ancient fortifications of Paris. In the reign of King John, or even earlier, the gate of Saint Antoine was flanked by two towers; and about 1309 Hugues Aubriot, at the command of Charles V., changed it into a regular bastille or fort by the addition of six others of massive structure, the whole united by thick walls and surrounded by a ditch 25 ft. wide. Various extensions and alterations were afterwards effected; but the building remained substantially what it was made by the vigorous provost, a strong and gloomy structure, with eight stern towers. As the ancient fortifications of the city were superseded, the use of the word *bastille* as a general designation gradually died out, and it became restricted to the castle of Saint Antoine, the political importance of which made it practically, long before it was actually, the only bastille of Paris. The building had originally a military purpose, and it appears

as a fortress on several occasions in French history. When Charles VII. retook Paris from the English in 1436, his opponents in the city took refuge in the Bastille, which they were prepared to defend with vigour, but the want of provisions obliged them to capitulate. In 1588 the duke of Guise took possession of the Bastille, gave the command of it to Bussy-Leclerc, and soon afterwards shut up the whole parlement within its walls, for having refused their adherence to the League. When Henry IV. became master of Paris he committed the command of the Bastille to Sully, and there he deposited his treasures, which at the time of his death amounted to the sum of 15,870,000 livres. On the 11th of January 1649 the Bastille was invested by the forces of the Fronde, and after a short cannonade capitulated on the 13th of that month. The garrison consisted of only twenty-two men. The Frondeurs concluded a peace with the court on the 11th of March; but it was stipulated by treaty that they should retain possession of the Bastille, which in fact was not restored to the king till the 21st of October 1651.

At a very early period, however, the Bastille was employed for the custody of state prisoners, and it was ultimately much more of a prison than a fortress. According to the usual account, which one is tempted to ascribe to the popular love of poetical justice, the first who was incarcerated within its walls was the builder himself, Hugues Aubriot. Be this as it may, the duke of Nemours spent thirteen years there in one of those iron cages which Louis XI. called his *fillettes*; and Jacques d'Armagnac, Poyet and Chabot were successively prisoners. It was not till the reign of Louis XIII. that it became recognized as a regular place of confinement; but from that time till its destruction it was frequently filled to embarrassment with men and women of every age and condition. Prisoners were detained without trial on *lettres de cachet* for different reasons, to avoid a scandal, either public or private, or to satisfy personal animosities. But the most frequent and most notorious use of the Bastille was to imprison those writers who attacked the government or persons in power. It was this which made it so hated as an emblem of despotism, and caused its capture and demolition in the Revolution.

Of the treatment of prisoners in the Bastille very various accounts have been given even by those who speak from personal experience, for the simple reason that it varied greatly in different cases. The prisoners were divided into two main classes, those who were detained on grounds of precaution or by way of admonitory correction, and those who lay under presumption or proof of guilt. The former were subject to no investigation or judgment, and the length of their imprisonment depended on the will of the king; the latter were brought to trial in the ordinary courts or before special tribunals, such as that of the Arsenal—though even in their case the interval between their arrest and their trial was determined solely by the royal decree, and it was quite possible for a man to grow old in the prison without having the opportunity of having his fate decided. Until guilt was established, the prisoner was registered in the king's name, and—except in the case of state-prisoners of importance, who were kept with greater strictness and often in absolute isolation—he enjoyed a certain degree of comfort and freedom. Visitors were admitted under restrictions; games were allowed; and, for a long time at least, exercise was permitted in open parts of the interior. Food was both abundant and good, at least for the better class of prisoners; and instances were not unknown of people living below their allowance and, by arrangement with the governor, saving the surplus. When the criminality of the prisoner was established, his name was transferred to the register of the "commission," and he became exposed to numerous hardships and even barbarities, which however belonged not so much to the special organization of the Bastille as to the general system of criminal justice then in force.

Among the more distinguished personages who were confined in this fortress during the reigns of Louis XIV., XV., and XVI., were the famous *Man of the Iron Mask* (see IRON MASK), Fouquet, the marshal Richelieu, Le Maître de Sacy, De Renneville, Voltaire, Latude, Le Prévôt de Beaumont, Labourdonnais,

Lally, Cardinal de Rohan, Linguet and La Chalotais. While no detestation is too great for that system of "royal pantheism" which led to the unjust and often protracted imprisonment of even men of great ability and stainless character, it is unnecessary to give implicit credence to all the tales of horror which found currency during the excitement of the Revolution, and which historical evidence, as well as *a priori* considerations, tends to strip of their more dreadful features, and even in many cases to refute altogether. Much light of an unexpected kind has in modern times been shed on the history of the Bastille from the pages of its own records. These documents had been flung out into the courts of the building by the revolutionary captors, and after suffering grievous diminution and damage were finally stored up and forgotten in the vaults of the library of the (so-called) Arsenal. Here they were discovered in 1840 by François Ravaisson, who devoted himself to their arrangement, elucidation and publication.

At the breaking out of the Revolution the Bastille was attacked by the Parisians; and, after a vigorous resistance, it was taken and razed to the ground on the 14th of July 1789. At the time of its capture only seven prisoners were found in it. A very striking account of the siege will be found in Carlyle's *French Revolution*, vol. i. The site of the building is now marked by a lofty column of bronze, dedicated to the memory of the patriots of July 1789 and 1830. It is crowned by a gilded figure of the genius of liberty.

See the *Memoirs* of Linguet (1783), and Latude (ed. by Thierry, tome iii. 18mo, 1791-1793); also François Ravaisson, *Les Archives de la Bastille* (16 vols. 8vo, 1866-1886); Delort, *Histoire de la détention des philosophes à la Bastille* (3 vols. 1829); F. Bourneon, *La Bastille* (1863); Fr. Funck-Brentano, *Les Lettres de cachet à Paris, étude suivie d'une liste des prisonniers de la Bastille* (1904); G. Lecocq, *La Prise de la Bastille* (1881).

BASTINADO (Span. *baston*, Fr. *bâton*, a stick, cudgel), the European name for a form of punishment common in the east, especially in Turkey, Persia and China. It consists in blows with a light stick or lath of bamboo upon the soles of the feet or on the buttocks. The terror of the punishment lies not in the severity of the blows, which are on the contrary scarcely more than tapping, but in its long continuation. A skilful bastinadoist can kill his victim after hours of torture.

BASTION (through the Fr. from late Lat. *bastire*, to build), a work forming part of a line of fortifications. The general trace of a bastion is similar to an irregular pentagon formed by a triangle and a narrow rectangle, the base of the triangle coinciding with the long side of the rectangle. The two sides of the triangle form the "faces" of the bastion, which join at the "salient" angle, the short sides of the rectangle form the "flanks." Bastions were arranged so that the fire from the flanks of each protected not only the front of the curtain but also the faces of the adjacent bastions. A "tower bastion" is a casemated tower built in bastion form; a "demi-bastion" is a work formed by half a bastion (bisected through the salient angle) and by a parapet along the line of bisecting; a "flat bastion" is a bastion built on a curtain and having a very obtuse salient angle.

BASTWICK, JOHN (1593-1654), English physician and religious zealot, was born at Writtle, in Essex, in 1593, and after a brief education at Cambridge, wandered on the continent and graduated in medicine at Padua. On his return he settled in Colchester. His celebrity rests on his strong opposition to the Roman Catholic ceremonial. About 1633 he printed in Holland two Latin treatises, entitled *Elenchus Religionis Pæpisticæ*, and *Flagellum Pontificis et Episcoporum Latianum*; and as Laud and other English prelates thought themselves aimed at, he was fined £1000 in the court of high commission, excommunicated and prohibited from practising physic, while his books were ordered to be burnt and the author himself consigned to prison. Instead of recanting, however, he wrote *Apologeticus ad Præsules Anglicanos*, and another book called *The Litany*, in which he exclaimed vehemently against the proceedings of the court, and charged the bishops with being the enemies of God and "the tail of the beast." William Prynne and Henry Burton coming under the lash of the star-chamber court at the same time, they were all

censured as turbulent and seditious persons; and condemned to pay a fine of £5000 each, to be set in the pillory, to lose their ears, and to undergo imprisonment for life in remote parts of the kingdom, Bastwick being sent to Scilly. The parliament in 1640 reversed these proceedings, and ordered Bastwick a reparation of £5000 out of the estates of the commissioners and lords who had sentenced him. He joined the parliamentary army, but in later years showed bitter opposition to the Independents. He died in the latter part of 1654.

BASUTOLAND (officially "The Territory of Basutoland"), an inland state and British crown colony of S.E. Africa, situated between 28° 35' and 30° 30' S. and 27° and 29° 25' E. It has an area of 10,293 sq. m., being somewhat smaller than Belgium, and is bounded S., S.E., and N.E. by the Drakensberg, N. and N.W. by the Caledon river, S.W. by a range of low hills extending from the Caledon above Wepener to the Orange river, and south of the Orange by the Telle or Tees river to its source in the Drakensberg. Its greatest length S.W. to N.E. is 145 m.; its greatest breadth N. to S. 120 m. On every side it is surrounded by British colonies, north by the Orange River Colony, south-west and south by Cape Colony, and east by Natal.

Basutoland, or Lesuto (Lesotho) as the natives call it, forms the south-eastern edge of the interior tableland of South Africa, and has a rugged and broken surface with a mean elevation of 6000 ft. The Drakensberg (*q.v.*) forming the buttress of the plateau seaward, attain their highest elevation on the Basuto-Natal border. The frontier line follows the crest of the mountains, three peaks some 10,000 or more ft. high—Giant's Castle, Champagne Castle or Cathkin Peak and Mont aux Sources—towering high above the general level. Mount Hamilton, which lies north of the waterparting, is over 9000 ft. high. From Mont aux Sources, table-shaped, and called by the Basutos *Polong* (Antelope), a second range of mountains, the Maluti, runs S.W. through the entire length of Basutoland. The crest of the Maluti is in few places lower than 7000 ft. whilst Machacha, the culminating point, is about 10,500 ft. From the tableland north of the Maluti several isolated hills rise, the most noted being the almost inaccessible Thaba Bosigo—the rallying place of the Basuto in many of their wars. Shut off from the adjacent Indian Ocean by its mountain barrier, the drainage of the country is westward to the distant Atlantic. As its name implies, the chief rivers rise in Mont aux Sources. From the inner sides of that mountain descend the Caledon and the Senku, whilst from its seaward face the Tugela flows through Natal to the Indian Ocean. The Caledon runs north of the Maluti, the Senku south of that range. From the slopes of the Maluti descend many streams, the largest being the Komet Spruit, which joins the Senku and other torrents from the Drakensberg to form the upper Orange (*q.v.*). The Caledon also, sweeping southward, unites with the Orange beyond the frontiers of Basutoland. Ordinarily shallow, the rivers after heavy rain fill with great rapidity, sweeping away everything in their path. In the richer soil they cut deep channels; the denudation thus caused threatens to diminish seriously the area of arable and pasture land. The river beds contain dangerous quicksands.

The aspect of the country is everywhere grand, and often beautiful, fully justifying the title, "The Switzerland of South Africa," often applied to it. Viewed from a distance the mountains appear as dark perpendicular barriers, quite impenetrable; but narrow paths lead round the precipitous face of the hills, and when the inner side is gained a wonderful panorama opens out. In every direction can be seen luxuriant valleys through which rivers thread their silvery way, wild chasms, magnificent waterfalls—that of Maletsunyane has an unbroken leap of over 600 ft.—and, above all, hill crest after hill crest in seeming endless succession. In winter the effect is heightened by the snow which caps all the higher peaks.

Geology.—Basutoland is entirely occupied by the upper division (Stromberg series) of the Karroo formation. The highest strata (Volcanic group) form the rugged elevated spurs of the Drakensberg mountains which extend along the eastern territorial boundary. It has been suggested that these spurs represent

the sites of vents or fissures of eruption. The upper part of the Maluti range consists of flows of melaphyres and diabases belonging to the volcanic beds. Among these lavas is the "pipe" amygdaloid of which many blocks have been transported great distances down the Vaal river. The amygdaloids are three or four inches long and about three-eighths of an inch in diameter. Heulandite, with thomsonite, stilbite, scolecite, calcite and chalcodyne, occur as infilling minerals.

Climate.—The climate is excellent, invigorating alike for Europeans and natives. The mean annual temperature is about 60° F. The four seasons are distinctly marked, a rarity in South Africa, where the transition from summer to winter is generally very rapid. The heat of summer (December–March, which is the rainy season) is tempered by cool breezes; winter (May–September, inclusive) is dry, cold and bracing, and frost prevails for prolonged periods. The average annual rainfall is about 30 in. The general health conditions are good. Malaria is almost unknown and chest complaints are rare. Epidemics of smallpox and typhoid occur; and leprosy, imported from the Orange River and Cape Colonias, has taken firm hold on the Basuto, of whom about .91 per 1000 are sufferers from this disease.

Flora and Fauna.—A few kloofs are wooded, but of forest land there is none. Along the upper courses of the rivers are willows and wild olive trees; round the chief settlements the eucalyptus and the pine have been planted. Heaths, generally somewhat rare in South Africa outside the Cape peninsula, are abundant in Basutoland. The Alpine flora is very beautiful. There are few wild animals; but the eland, hartebeest and smaller antelopes are found, as well as the leopard and the jackal. Mountain hares, partridges and quails afford good sport; baboons and great hawks live in the mountains. The few fish include the barbel. Swarms of locusts occasionally visit the country; the locusts are eaten by the Basuto.

Population and Towns.—Considering the extensive area of uninhabitable mountain land it contains, the Territory supports a large population. The inhabitants increased from 128,206 in 1875 to 348,848 in 1904. The females outnumber the males by about 20,000, which is, however, about the number of adult males away from the country at any given period. The majority live in the district between the Maluti mountains and the Caledon river. The great bulk of the people are Basuto, but there are some thousands of Barolong and other Kaffirs. The Basuto proper are a branch of the Bechuana family of Bantu-Negroids. The white inhabitants in 1904 numbered 895, and there were 222 coloured persons other than natives. The seat of government is Maseru, on the left bank of the Caledon, with a population of about 1000 including some 100 Europeans. Mafeteng, in the N.W. near the Cape frontier, is a thriving agricultural centre, as is Butha Buthe in the N.E. Morija, some 16 m. S.E. of Maseru, is the oldest mission station in the Territory, having been founded by the Paris Society about 1833. Three miles from Morija is Matsieng, the kraal of the paramount chief Lerothodi (who died in August 1905). There are numerous mission stations throughout Basutoland, to several of which Biblical names have been given, such as Shiloh, Hermon, Cana, Bethesda, Berea.

Agriculture and Trade.—Basutoland is one of the greatest grain-growing countries of South Africa. The richest tract of land is that between the Maluti mountains and the Caledon river. In summer the country appears as one waving field of wheat, millet and mealies; whilst on the mountain slopes and on their flat tops are large flocks of sheep, cattle and goats, and troops of ponies. The Basuto ponies, said to be descended from Shetland ponies which, imported to the Cape in 1840, strayed into the mountains, are short-legged, strong-bodied, sure-footed, and noted for their hardness. Improvements in the breed have been effected by the introduction of Arab stallions. Nearly every Basuto is an agriculturist; there are no manufactories, and the minerals, in accordance with the desire of the people, are not worked. The land is wholly in the possession of the natives, who hold it on the communal system. Whites and Indians are allowed to establish trading stations on obtaining special permits from the government, and the Indians absorb

much of the retail trade. The chief exports are wheat, mealies, Kaffir corn, wool, mohair, horses and cattle. The great bulk of the imports are textiles. The value of the trade depends on regular rains, so that in seasons of drought the exports seriously diminish. The average annual value of trade for the five years ending the 30th of June 1905 was:—Exports £215,668, imports £203,026. Trade is almost entirely with Orange River Colony and Cape Colony. The Territory is a member of the South African Customs Union. Some 60,000 Basuto (annual average) find employment outside the Territory, more than half of whom seek farm and domestic service. A small proportion go to the Johannesburg gold mines, and others obtain employment on the railways.

Communication over the greater part of the Territory is by road; none of the rivers is navigable. A state-owned railway, 16½ m. long, starting from Maseru crosses the Caledon river and joins the line connecting Bloemfontein and Ladysmith. This railway follows, N.E. of Maseru, the right bank of the Caledon, and affords a ready means of transport for the cereals raised on the left or Basuto side of the river. Highroads, maintained by the government, traverse every part of the country, and bridges have been built across the Caledon. The usual mode of conveyance is by ox-wagon or light cart. Several passes through the Drakensberg into Griqualand East and Natal exist, but are little used. There is a complete postal and telegraphic service and a telephone line connects all government stations.

Government and Finance.—Basutoland is a crown colony, of which the high commissioner for South Africa is governor. In him resides the legislative power, exercised by proclamation. The Territory is administered, under the direction of the governor, by a resident commissioner, who is also the chief judicial officer. He is aided by a government secretary and by assistant commissioners. Under the British officials the country is governed by hereditary native chiefs, over whom is a paramount chief. The chiefs have jurisdiction in cases affecting natives, but there is a right of appeal to the courts of the commissioners, who try all cases in which any of the parties are European. A national council (*piiso*), representative of all the native tribes, meets annually for the free discussion of public affairs. For administrative purposes the Territory is divided into the seven districts of Maseru, Leribe, Mohales Hoek, Berea, Mafeteng, Quthing and Qacha's Nek, each of which is subdivided into wards presided over by Basuto chiefs.

Revenue is obtained from a hut tax of £1 per hut; the sale of licences to trade; customs and post office receipts. Seven-eighths of the revenue comes from the hut tax and customs. The average annual revenue for the five years 1901–1905 was £96,880; the average annual expenditure £69,559. Basutoland has no public debt.

Education and Social Condition.—Education is given in schools founded by missionary societies, of which the chief is the Société des Missions Évangéliques de Paris. A large proportion of the people can read and write Sesuto (as the Basuto language is called) and English, and speak Dutch, whilst a considerable number also receive higher education. Many Basuto at the public examinations take higher honours than competitors of European descent. There are over 200 schools, with an average attendance exceeding 10,000. Nine-tenths of the scholars are in the schools of the French Protestant Mission, which are conducted by English, or English-speaking, missionaries. A government grant is made towards the cost of upkeep. A government industrial school (opened in 1906) is maintained at Maseru, and the Paris Society has an industrial school at Leloaleng. The social condition of the people is higher than that of the majority of South African natives. Many Basuto profess Christianity and have adopted European clothing. Serious crime is rare among them and "deliberate murder is almost unknown."¹ They are, like mountaineers generally, of a sturdy, independent spirit, and are given to the free expression of their views, generally stated with good sense and moderation. These views found a new medium of publicity in 1904 when an independent native

¹ Report by resident-commissioner H. C. Stoley, for 1902–1903.

newspaper was started, called *Naledi ea Lesotha* (Star of Basutoland). The publication of this paper was followed in 1906 by the adoption of a uniform system of Sesuto orthography. A book on national customs, the first work in the vernacular by a South African native, was published in 1893. The brandy-drinking habit, which, when the imperial government assumed control of the administration in 1884, threatened the existence of the nation, has been very largely checked. A strong beer, brewed from Kafir corn, is a favourite drink.

History.—Until the beginning of the 19th century Basutoland appears to have been uninhabited save by wandering Bushmen, whose rude rock pictures are to be found in several parts of the Drakensberg. About 1800 the country was occupied by various tribes of Bechuana, such as Batau, Basuto, Baputi, who then possessed the greater part of what is now Orange River Colony. They appear to have recognized the paramount authority of a family descended from a chief named Monaheng. By the wars of the Zulu chiefs Chaka, Matiwana and Mosilikatze, these tribes were largely broken up and their power destroyed. One tribe, living in the Maluti mountains, was reduced to cannibalism.

From their chief Machacha mountain takes its name. At this period a young man named Moshesh (born about 1790), who was of the family of Monaheng and already noted as hunter and warrior, gathered round him the remnants of several broken clans, out of which he welded the existing Basuto nation. He established himself in 1824 on the rock-fortress of Thaba Bosigo, where, in 1831, he successfully defended himself against Mosilikatze; and thereafter became second only to that chief among the natives north of the Orange River. In 1833 Moshesh invited the missionaries of the Société des Missions Évangéliques de Paris to settle in his country, and from that day until his death proved their firm friend. A few years later, in 1836–1837, large parties of emigrant Boers settled north of the Orange, and before long disputes arose between them and Moshesh, who claimed a great part of the land on which the white farmers had settled. The Basuto acquired an unenviable notoriety as a race of bold cattle lifters and raiders, and the emigrant Boers found them extremely troublesome neighbours. At the same time, if the Basuto were eager for cattle, the Boers were eager for land; and their encroachments on the territories of the Basuto led to a proclamation in 1842 from Sir George Napier, the then governor of Cape Colony, forbidding further encroachments on Basutoland. In 1843 a treaty was signed with Moshesh on the lines of that already arranged with Waterboer, the Griqua chief (see GRIQUALAND), creating Basutoland a native state under British protection.

To the quarrels between Basuto and Boers were added interminable disputes between the Basuto and other Bechuana tribes, which continued unabated after the proclamation of British sovereignty over the Orange river regions by Sir Harry Smith in 1848. In 1849, however, Moshesh was unwillingly induced by Sir Harry to surrender his claims to part of the territory recognized as his by the Napier treaty. The British continued to intervene in the inter-tribal disputes, and in 1851 Major H. D. Warden led against the Basuto a commando composed of British soldiers, farmers and a native contingent. This commando was defeated at Viervoet, near Thaba Nchu, by the Basuto, who thereafter raided and plundered the natives opposed to them and the farmers who had helped the British. Attempts were made to come to terms with Moshesh and the justice of many of his complaints was admitted. The efforts at accommodation failed, and in 1852 General Sir George Cathcart, who had succeeded Sir Harry Smith as governor of Cape Colony, decided to take strong measures with the tribe, and proceeded with three small divisions of troops against Moshesh. The expedition was by no means a success, but Moshesh, with that peculiar statecraft for which he was famous, saw that he could not hope permanently to hold out against the British troops, and followed up his successful skirmishes with General Cathcart by writing him a letter, in which he said: "As the object for which you have come is to have a compensation for Boers, I beg you will be satisfied with what you have taken. You have shown your power, you have chastised;

I will try all I can to keep my people in order in the future." General Cathcart accepted the offer of Moshesh and peace was proclaimed, the Basuto power being unbroken. Fourteen months later (February 1854) Great Britain renounced sovereignty over the farmers settled beyond the Orange, and Moshesh found himself face to face with the newly constituted Free State. Boundary disputes at once arose but were settled (1858) by the mediation of Sir George Grey, governor of Cape Colony. In 1865 a fresh feud occurred between the Orange Free State Boers and the Basuto. The latter applied to Sir Philip Wodehouse at the Cape for protection, but he declined to interfere. The Boers proved more successful than they had been in the past, and occupied several of the Basuto strongholds. They also annexed a certain fertile portion of Basuto territory, and finally terminated the strife by a treaty at Thaba Bosigo, by which Moshesh gave up the tract of territory taken by the Boers and professed himself a subject of the Free State. Seeing that the struggle against the Boers was hopeless, no fewer than 2000 Basuto warriors having been killed, Moshesh again appealed for protection to the British authorities, saying: "Let me and my people rest and live under the large folds of the flag of England before I am no more." In response to this request, the British authorities decided to take over Basutoland, and a proclamation of annexation was issued on the 12th of March 1868. At the same time the Boer commandos were requested to leave the country. The Free State strongly resented the British annexation of Basutoland, but after much negotiation the treaty of Aliwal North was concluded (1869) between the Free State and the high commissioner. This treaty defined the boundary between the Free State and Basutoland, whereby the fertile strip of country west of the Caledon river, known as the Conquered Territory, was finally transferred to the Free State, and the remainder of Basutoland was recognized as a portion of the British dominions.

Moshesh, who for nearly fifty years had led his people so skillfully and well, died in 1870. He was one of the rare instances among the Kaffirs of a leader endowed with intellectual gifts which placed him on a level with Europeans, and his life-work has left a permanent mark on South African history. In diplomacy he proved fully the equal of all—white or black—with whom he had to deal, while he ruled with a rare combination of vigour and moderation over the nation which he had created.

In 1871 Basutoland was annexed to Cape Colony, the area at that time being given as 10,300 sq. m. The turbulent Basuto warriors did not remain quiet for any length of time, and in 1879 Moinosi, a chief residing in the southern portion of Basutoland, openly repudiated colonial rule. An expedition was despatched from Cape Colony and severe fighting followed. Moinosi's stronghold was captured and the chief himself was killed. Immediately after the war, strife occurred among the Basuto themselves over the question of the partition of Moinosi's territory, which had been decided on as one of the results of the war. In 1880 the Cape government felt sufficiently strong to extend to Basutoland the Cape Peace Preservation Act of 1878. This act provided for the disarmament of natives, and had already been put in force successfully among some of the Kafir tribes on the Cape eastern frontier. Its execution in Basutoland, however, proved an extremely difficult task, and was never entirely accomplished. Desultory warfare was carried on between the colonial troops and the Basuto until 1881, when the intervention of the high commissioner, Sir Hercules Robinson (afterward Lord Rosmead), was asked for. Peace in Basutoland was not announced until the end of 1882. In the following year a form of self-government was established, but was once more followed by internal strife among the petty chieftains.

The subjection of Basutoland to the control of the Cape government had by this time proved unsatisfactory, both to the Basuto and to Cape Colony. The Cape government therefore offered no opposition to the appeal made by the Basuto themselves to the imperial government to take them over, and, moreover, Cape Colony undertook to pay towards the cost of administration an

Moshesh forms the Basuto nation.

Annexation to Great Britain.

The "sun" war.

annual contribution of £18,000. Consequently, in 1884, Basutoland ceased to be a portion of the Cape Colony and became a British crown colony. Native laws and customs were interfered with as little as possible and the authority of the chiefs—all members of the Moshesh family—was maintained. Moshesh had been succeeded as paramount chief by his son, Letsie, and he in turn was succeeded in 1891 by Lerothodi (c. 1837-1905). These chieftains acted in concert with the British representative in the country, to whom was given the title of resident commissioner. The first commissioner was Sir Marshall Clarke, to whose tact and ability the country owed much. The period of warfare over, the Basuto turned their attention more and more to agricultural pursuits and also showed themselves very receptive of missionary influence. Trade increased, and in 1891 Basutoland was admitted to the customs union, which already existed between Orange Free State, Cape Colony and British Bechuanaland. When Lord (then Sir Alfred) Milner visited Basutoland in 1898, on his way to Bloemfontein, he was received by 15,000 mounted Basuto. The chiefs also attended a large meeting at Maseru, and gave expression to their gratitude for the beneficent character of Queen Victoria's rule and protection. On the outbreak of the Boer War in 1899, these same chiefs, at a great meeting held in the presence of the resident commissioner, gave a further protestation of their loyalty to Her Majesty. They remained passive throughout the war and the neutrality of the country was respected by both armies. One chief alone sought to take advantage of the situation by disloyal action, and his offence was met by a year's imprisonment. The conversion of Basutoland into a crown colony contributed alike to the prosperity of the Basuto, the security of the property of neighbouring colonists and a peaceful condition among the natives of South Africa generally. In pursuance of the policy of encouraging the self-governing powers of the Basuto, a national council was instituted and held its first sitting in July 1903. In August 1905 the paramount chief Lerothodi died. In early life he had distinguished himself in the wars with the Boers, and in 1880 he took an active part in the revolt against the Cape government. Since 1884 he had been a loyal supporter of the imperial authorities, being unwavering in his adherence in critical times. Fearless and masterful he also possessed high diplomatic gifts, and though on occasion arbitrary and passionate he was neither revengeful nor cruel. On the 10th of September following Lerothodi's death, the national council, with the concurrence of the imperial government, elected his son Letsie as paramount chief. The completion in October 1905 of a railway putting Maseru in connexion with the South African railway system proved a great boon to the community. During the rebellion of the natives in Natal and Zululand in 1906 the Basuto remained perfectly quiet.

A CROWN COLONY.

AUTHORITIES.—*The Basutos* (2 vols., London, 1909), a standard history, and "Basutoland and the Basutos" in *Jnl. Ryl. Col. Inst.* 1901, both by Sir G. Lagden, resident-commissioner, 1893-1901; E. Jacotet, "Mœurs, coutumes et superstitions des Basutos," in *Bull. Soc. néo-chalonnaise Géog.*, vol. ix, pp. 107-131, 1897; G. M. Theal, *Basutoland Records* (Cape Town, 1883); E. Casalis, *Les Bassutos* (Paris, 1859), a description of exploration, manners and customs, the result of twenty-three years' residence in the country; Minnie Martin, *Basutoland: its Legends and Customs* (London, 1903); Mrs F. A. Barkly, *Among Boers and Basutos* (new ed., London, 1897), a record, chiefly, of the Gun War of 1880-1882; C. W. Mackintosh, *Coiland of the Zambesi* (London, 1907). For geology consult E. Coillard, "Geognostisch-petrographische Skizzen aus Süd-Afrika," *Neues Jahrb. f. Min., 1874*, and *N. Jahrb. Geol., Bd. v.*, 1887; D. Draper, "Notes on the Geology of South-eastern Africa," *Quart. Journ. Geol. Soc.*, vol. L, 1894; Hatch-Corsforthine, *The Geology of South Africa* (London, 1905). For current information see the annual report on Basutoland (Colonial Office, London). Many books dealing with South Africa generally have chapters relating to Basutoland, e.g. A. P. Hillier, *South African Studies* (London, 1900); James Bryce, *Impressions of South Africa* (3rd ed., London, 1899). Consult also Theal's *History of South Africa* (1908-9 ed.).

(F. R. C.; A. P. H.)

BAT,¹ a name for any member of the zoological order Chiroptera (*q.v.*). Bats are insectivorous animals modified for flight, ¹ M. E. bakke, the change to "bat" having apparently been influenced by Lat. *batta*, *blatta*, moth. The word is thus distinct from the other common term "bat," the implement for striking, which is probably connected with Fr. *battre*, though a Celtic or simply onomatopoeic origin has been suggested.

with slight powers of progression on the ground; the patagium, or "flying-membrane" of some squirrels and of *Galeopithecus* (*q.v.*) probably indicates the way in which the modification was effected. They are distributed throughout the world, but are most abundant in the tropics and the warmer parts of the temperate zones; within these limits the largest forms occur. There is great variation in size; the Malay "flying-fox" (*Pteropus edulis*) measures about a foot in the head and body, and has a wing-spread of 5 ft.; while in the smaller forms the head and body may be only about 2 in., and the wing-spread no more than a foot. The coloration is generally sombre, but to this there are exceptions; the fruit-bats are brownish yellow or russet on the under surface; two South American species are white; Blainville's chin-leaved bat is bright orange; and the Indian painted bat (*Cerivoula picta*) with its deep orange dress, spotted with black on the wing-membranes, has reminded observers of a large butterfly. In habits bats are social, nocturnal and crepuscular; the insect-eating species feed on the wing, in winter in the temperate regions they migrate to a warmer climate, or hibernate, as do the British bats. The sense-organs are highly developed; the wing-membranes are exceedingly sensitive; the nose-leaf is also an organ of perception, and the external ear is specially modified to receive sound-waves. Most bats are insect-eaters, but the tropical "flying foxes" or fox-bats of the Old World live on fruit; some are blood-suckers, and two feed on small fish. Twelve species are British, among which are the pipistrelle (*Pipistrellus pygmaeus*, or *P. pipistrellus*), the long-eared bat (*Plecotus auritus*), the noctule (*Pipistrellus* [*Pterygistes*] *noctulus*) the greater and lesser horseshoe bats (*Rhinolophus ferrum-equinum* and *R. hipposiderus*), &c. (See FLYING-FOX and VAMPIRE.)

BATAK, a town of the province of Ilocos Norte, Luzon, Philippine Islands, 10 m. S. of Laoag, the capital. Pop. (1903) 19,524; subsequently, in October 1903, the town of Banna (pop. 4015) was annexed. Cacao, tobacco, cotton, rice and indigo are grown in the neighbouring country, and the town has a considerable trade in these and other commodities; it also manufactures sugar, fans and woven fabrics. Batak was founded in 1887. It is the birthplace and home of Archbishop Gregorio Aglipay (b. 1860), the founder of an important sect of Filipino Independent Catholics.

BATALA, a town of British India, in the Gurdaspur district of the Punjab, with a station on a branch of the North-Western railway, 24 m. from Amritsar. Pop. (1901) 27,365. It is an important centre of trade, with manufactures of cotton and silk goods, shawls, brass-ware, soap and leather. There are two mission schools.

BATALHA (*i.e.* battle), a town of Portugal, in the district of Leiria, formerly included in the province of Estremadura; 8 m. S. of Leiria. Pop. (1900) 358. Batalha, which occupies the site of the medieval Canoeira, is chiefly interesting for its great Dominican monastery of Santa Maria da Victoria ("St Mary of the Victory"), also known as Batalha. Both town and monastery owe their names to the battle fought on the plain between Canoeira and Aljubarrota, 9 m. S.W., in which John I. of Portugal defeated John I. of Castile in 1385 and secured the independence of his kingdom. The monastery is built of golden-brown limestone, resembling marble, and richly sculptured. In size and beauty it exceeds all the other buildings of Portugal in which Gothic and Moorish architecture are combined. Its ground-plan may be roughly described as a parallelogram, measuring about 500 ft. from north to south, and 445 from east to west; with the circular annex of the royal mausoleum on the east, and the Founder's chapel at the south-western corner. In the centre is the royal cloister, which is flanked by the refectory, now a museum, on the west; and by the chapter-house, on the east. Two smaller cloisters, named respectively after Alphonso V. and John III., form the northern division of the parallelogram; its southern division is the Gothic church. The Founder's chapel contains the tomb of John I. (d. 1433) and Philippa of Lancaster (d. 1416), his queen, with the tomb of Prince Henry the Navigator (d. 1460). Like the royal mausoleum, where

several later monarchs are buried, it is remarkable for the intricacy and exquisite finish of its carved stonework. The monastery was probably founded in 1388. Plans and masons were procured from England by Queen Philippa, and the work was entrusted to A. Domingues, a native architect, and Huet or Houquet, an Irishman. Only the royal cloister, church and Founder's chapel were included in the original design; and all three show signs of English influence. Various additions were made up to 1551, beginning with the royal mausoleum and ending with the cloister of John III. Considerable damage was inflicted by the earthquake of 1755; and in 1810 the monastery was sacked by the French. It was secularized in 1834 and declared a national monument in 1840. Thereafter it was gradually restored.

BATANGAS, a town, port of entry, and the capital of the province of Batangas, Luzon, Philippine Islands, near the Batangas river, about 1 m. from its mouth on the E. coast of the Gulf of Batangas, and about 65 m. S. by E. of Manila. Pop. (1903) 33,131. The United States government has established a military post here, and the town has numerous fine public buildings and private residences. It is the most important port of a province noted for the fertility of its soil and the industry of its inhabitants. Its exports, which are large, include rice, coffee of excellent quality, cacao, sugar, Indian corn, horses and cattle. The horses of Batangas are unusually strong and active. Cotton is produced, and is woven into fabrics by the women. The language is Tagalog.

BATARNAY, IMBERT DE (? 1438-1523), French statesman, was born of an old but obscure family in Dauphiné, about the year 1438. In consequence of a chance circumstance he entered into relations with the dauphin Louis, at that time (1455) in arms against the king his father; he attached himself to the prince, and followed him on his retreat into Burgundy. From the beginning of his reign Louis XI. loaded Batarnay with favours: he married him to a rich heiress, Georgette de Montchenu, lady of Le Bouchage; besides making him captain of Mont Saint Michel and giving him valuable estates, with, later, the titles of counsellor and chamberlain to the king. In 1469 Batarnay was sent to keep watch upon the duke of Guienne's intrigues, which began to appear dangerous. As lieutenant-general in Roussillon in 1475 he protected the countryside against the wrath of the king, who wished to repress with cruel severity a rebellion of the inhabitants. He was present at the interview between Louis XI. and Edward IV. of England at Picquigny, and was afterwards employed on negotiations with the duke of Burgundy. In accordance with the recommendations of his father, Charles VIII. kept the lord of Le Bouchage in his confidential service. During the differences that arose in 1485 between the regent, Anne of Beaujeu, and the dukes of Orleans, Brittany and Alençon, Imbert de Batarnay kept the inhabitants of Orleans faithful to the king. He proved his skill in the negotiations concerning the marquise of Saluzzo and the town of Genoa. During the Naples expedition he was in charge of the dauphin, Charles Orland, who died in 1495. He treated with Maximilian of Austria to prevent him from entering Picardy during the war with Naples, and then proceeded to Castile to claim promised support. Under Louis XII. he took part in the expedition against the Genoese republic in 1507. Francis I. employed him to negotiate the proposed marriage of Charles of Austria with Renée of France, daughter of Louis XII., and appointed him governor to the dauphin Francis in 1518. He died on the 12th of May 1523.

See also B. de Mandrot's *Ymbert de Batarnay* (Paris, 1886).

(M.P.)*

BATAVIA, a residency of the island of Java, Dutch East Indies, bounded E., S. and W. by the residencies of Krawana, Preanger and Bantam, and N. by the Java Sea. It also comprises a number of small islands in the Java Sea, including the Thousand Islands group, with a total area of 24 sq. m. The population in 1898 was 1,313,383, including 12,434 Europeans, 82,510 Chinese, 3426 Arabs and other Asiatic foreigners. The natives belong to a Sundanese group, but in the north contain

a large admixture of Malays. The northern half of the province is flat, and even marshy along the coast, and consists of a broad band of alluvium formed by the series of parallel rivers descending from the south. The southern half on the other hand is covered by a mountain range whose chief peaks are situated along the southern border, namely Halimun mountain, the volcanoes Salak, Pangerango and Gede, and the Megamendung. The soil is fertile, and whereas rice is mainly grown on the lowlands the highlands are especially suitable for the cultivation of coffee, tea, tobacco, cinchona and vanilla. Extensive coconut plantations are also found in the plains, and market-gardening is practised in the neighbourhood of the towns. Sugar was formerly cultivated. The government of the residency of Batavia differs from that of the other residencies in having no native regencies, the lands being privately owned. The divisions of the residency are Batavia, town and surroundings, Tangerang, Meester Cornelis and Buitenzorg, the first being directly governed by a resident and the remainder by assistant residents. As early as the second half of the 17th century the Dutch East India Company began the practice of selling portions of the land to private persons, and of granting other portions as the reward of good services. A large strip of hill-country, almost corresponding to the present southern or Buitenzorg division of the residency, was appropriated by the governor-general in 1745 and attached to that office. In 1808, however, Marshal Daendels disposed of this property to various purchasers, including the Dutch government, and thus the whole of the residency gradually passed into private hands. Hence the administration of the residency is largely confined to police duties. The principal towns are Batavia (*q.v.*), which is the capital of the residency, as well as the seat of government of the whole Dutch East Indies, Meester Cornelis, Tangerang, Bekasi and Buitenzorg (*q.v.*). Tangerang and Bekasi are important centres of trade. The Buitenzorg hill-country is much visited on account of its beauty, and cool and healthy climate. Gadok is a health resort 6 m. south-east of Buitenzorg.

BATAVIA, a city and seaport on the north coast of the island of Java, and the capital of all the Dutch settlements in the East. The population in 1880 was 96,957; in 1898, 115,567; including 9423 Europeans, 26,433 Chinese, 2828 Arabs and 132 other Asiatic foreigners. It is situated on both sides of the river Jacatra or Jilivong, in a swampy plain at the head of a capacious bay. The streets are for the most part straight and regular, and many of them have a breadth of from 100 to 200 ft. In several cases there is a canal in the centre lined with stone, and protected by low parapets or banks, while almost every street and square is fringed with trees. The old town has greatly changed from its condition in the 18th century. It was then surrounded by strong fortifications, and contained a number of important buildings, such as the town-house (built in 1652 and restored in 1706), the exchange, the infirmary and orphan asylum, and the European churches. But the ramparts were long ago demolished; only natives, Malays, Arabs and Chinese live here, and the great European houses have either fallen into decay or been converted into magazines and warehouses. The European inhabitants live principally in the new town, which was gradually formed by the integration of Weltevreden (*Well-content*), Molenvliet (*Mil-l-stream*), Rijswijk (*Rice-town*), Noordwijk (*North-loan*), Koningsplein (*King's square*), and other suburban villages or stations. The situation of this modern part is higher and healthier. The imitation of Dutch arrangements has been avoided, and the natural advantages of the situation and climate have been turned to account. The houses, generally of a single storey or two at most, are frequently separated from each other by rows of trees. Batavia contains numerous buildings connected with the civil and military organization of the government. The governor-general's palace and the government buildings are the most important of these; in the district of Weltevreden are also the barracks, and the artillery school, as well as the military and civil hospital, and not far off is the Frederik-Hendrik citadel built in 1837. Farther inland, at Meester Cornelis, are barracks and a school for under-officers. The

Koningsplein is a large open square surrounded by mansions of the wealthier classes. Noordwijk is principally inhabited by lesser merchants and subordinate officials. There is an orphan asylum in the district of Parapatna. Batavia has various educational and scientific institutions of note. In 1851 the government founded a medical school for Javanese, and in 1860 the "Gymnasium William III." in which a comprehensive education is bestowed. A society of arts and sciences (which possesses an excellent museum) was established in 1778, a royal physical society in 1850, and a society for the promotion of industry and agriculture in 1853. In addition to the *Transactions* of these societies—many of which contain valuable contributions to their respective departments in their relation to the East Indies—a considerable number of publications are issued in Batavia. Among miscellaneous buildings of importance may be mentioned the public hall known as the *Harmonie*, the theatre, club-house and several fine hotels.

The population of Batavia is varied, the Dutch residents being a comparatively small class, and greatly intermixed with Portuguese and Malays. Here are found members of the different Indian nations, originally slaves; Arabs, who are principally engaged in navigation, but also trade in gold and precious stones; Javanese, who are cultivators; and Malays, chiefly boatmen and sailors, and adherents of Mahomedanism. The Chinese are both numerous and industrious. They were long greatly oppressed by the Dutch government, and in 1740 they were massacred to the number of 12,000.

Batavia Bay is rendered secure by a number of islands at its mouth, but grows very shallow towards the shore. The construction of the new harbour at Tanjung Priok, to the east of the old one, was therefore of the first importance. The works, begun in 1877 and completed in 1886, connect the town with Tanjung ("cape") Priok by a canal, and include an outer port formed by two breakwaters, 6072 ft. long, with a width at entrance of 408 ft. and a depth of 27 ft. throughout. The inner port has 3282 ft. of quayage; its length is 3600 ft., breadth 573 ft. and depth 24 ft. There is also a coal dock, and the port has railway and roadway connexion with Batavia. The river Jilivong is navigable 2 m. inland for vessels of 30 or 40 tons, but the entrance is narrow, and requires continual attention to keep it open.

The exports from Batavia to the other islands of the archipelago, and to the ports in the Malay Peninsula, are rice, sago, coffee, sugar, salt, oil, tobacco, teak timber and planks, Java cloths, brass wares, &c., and European, Indian and Chinese goods. The produce of the Eastern Islands is also collected at its ports for re-exportation to India, China and Europe—namely, gold-dust, diamonds, camphor, benzoin and other drugs; edible bird-nests, trepang, rattans, beeswax, tortoise-shell, and dyeing woods from Borneo and Sumatra; tin from Banka; spices from the Moluccas; fine cloths from Celebes and Bali; and pepper from Sumatra. From Bengal are imported opium, drugs and cloths; from China, teas, raw silk, silk piece-goods, coarse China wares, paper, and innumerable smaller articles for the Chinese settlers. The tonnage of vessels clearing from Batavia to countries beyond the archipelago had increased from 879,000 tons in 1887 to nearly 1,500,000 tons by the end of the century. The old and new towns are connected by steam tramways. The Batavia-Buitenzorg railway passes the new town, thus connecting it with the main railway which crosses the island from west to east.

Almost the only manufactures of any importance are the distillation of arrack, which is principally carried on by Chinese, the burning of lime and bricks, and the making of pottery. The principal establishment for monetary transactions is the Java Bank, established in 1828 with a capital of £500,000.

Batavia owes its origin to the Dutch governor-general Pieter Both, who in 1610 established a factory at Jacatra (which had been built on the ruins of the old Javanese town of Sunda Calappa), and to his successor, Jan Pieters Coen, who in 1619 founded in its stead the present city, which soon acquired a flourishing trade and increased in importance. In 1699 Batavia

was visited by a terrible earthquake, and the streams were choked by the mud from the volcano of Gunong Salak; they overflowed the surrounding country and made it a swamp, by which the climate was so affected that the city became notorious for its unhealthiness, and was in great danger of being altogether abandoned. In the twenty-two years from 1730 to 1752, 1,100,000 deaths are said to have been recorded. General Daendels, who was governor from 1808 to 1811, caused the ramparts of the town to be demolished, and began to form the nucleus of a new city at Weltevreden. By 1816 nearly all the Europeans had left the old town. In 1811 a British armament was sent against the Dutch settlements in Java, which had been incorporated by France, and to this force Batavia surrendered on the 8th of August. It was restored, however, to the Dutch by the treaty of 1814.

BATAVIA, a village and the county-seat of Genesee county, New York, U.S.A., about 36 m. N.E. of Buffalo, on the Tonawanda Creek. Pop. (1890) 7221; (1900) 9180, of whom 1527 were foreign-born; (1910), 11,613. Batavia is served by the New York Central & Hudson River, the Erie, and the Lehigh Valley railways. It is the seat of the New York State School for the Blind, and of St Joseph's Academy (Roman Catholic), and has a historical museum, housed in the Old Holland Land Office (1804), containing a large collection of relics of the early days of New York, and a memorial library erected in 1889 in memory of a son by Mary E. Richmond, the widow of Dean Richmond; the building contained in 1908 more than 14,000 volumes. The public schools are excellent; in them in 1898 Superintendent John Kennedy (b. 1846) introduced the method of individual instruction now known as the "Batavia scheme," under which in rooms of more than fifty pupils there is, besides the class teacher, an "individual" teacher who helps backward children in their studies. Among Batavia's manufactures are harvesters, ploughs, threshers and other agricultural implements, firearms, rubber tires, shoes, shell goods, paper-boxes and inside woodwork. In 1905 the city's factory products were valued at \$3,589,406, an increase of 39.5% over their value in 1900. Batavia was laid out in 1801 by Joseph Ellicott (1760-1826), the engineer who had been engaged in surveying the land known as the "Holland Purchase," of which Batavia was a part. The village was incorporated in 1823. Here lived William Morgan, whose supposed murder (1826) by members of the Masonic order led to the organization of the Anti-Masonic party. Batavia was the home during his last years of Dean Richmond (1804-1866), a capitalist, a successful shipper and wholesaler of farm produce, vice-president (1853-1864) and president (1864-1866) of the New York Central railway, and a prominent leader of the Democratic party in New York state.

See O. Turner, *History of the Holland Purchase* (Buffalo, 1850).

BATEMAN, HEZEKIAH LINTHICUM (1812-1875), American actor and manager, was born in Baltimore, Maryland, on the 6th of December 1812. He was intended for an engineer, but in 1832 became an actor, playing with Ellen Tree (afterwards Mrs Charles Kean) in juvenile leads. In 1855 he was manager of the St Louis theatre for a few years and in 1859 moved to New York. In 1866 he was manager for his daughter Kate, and in 1871 returned to London, where he took the Lyceum theatre. Here he engaged Henry Irving, presenting him first in *The Bells*, with great success. He died on the 22nd of March 1875.

His wife, SIDNEY FRANCES (1823-1881), daughter of Joseph Cowell, an English actor who had settled in America, was also an actress and the author of several popular plays, in one of which, *Self* (1857), she and her husband made a great success. After her husband's death Mrs Bateman continued to manage the Lyceum till 1875. She later took the Sadler's Wells theatre, which she managed until her death on the 13th of January 1881. She was the first to bring to England an entire American company with an American play, Joaquin Miller's *The Danites*.

Mr and Mrs Bateman had eight children, three of the four daughters being educated for the stage. The two oldest, Kate Josephine (b. 1842), and Ellen (b. 1845), known as the "Bateman children," began their theatrical career at an early age. In 1862

Kate played in New York as Juliet and Lady Macbeth, and in 1863 had a great success in London as Leah in Augustin Daly's adaptation of Mosenthal's *Deborah*. In 1866 she married George Crowe, but returned to the stage in 1868, playing later as Lady Macbeth with Henry Irving, and in 1875 in the title-part of Tennyson's *Queen Mary*. When her mother opened the Sadler's Wells theatre in 1870 Miss Bateman appeared as Helen Macgregor in *Rob Roy*, and in 1881 as Margaret Field in Henry Arthur Jones' *His Wife*. Her daughter, Sidney Crowe (b. 1871), also became an actress. Virginia Bateman (b. 1854), a younger sister of Kate, born in Cincinnati, Ohio, went on the stage as a child, and first appeared in London in the title-part of her mother's play, *Fanchette*, in 1871. She created a number of important parts during several seasons at the Lyceum and elsewhere. She married Edward Compton the actor. Another sister was Isabel (b. 1854), well known on the London stage.

BATEMENT LIGHTS, in architecture the lights in the upper part of a perpendicular window, abated, or only half the width of those below.

BATES, HARRY (1850–1899), British sculptor, was born at Stevenage, Herts, on the 26th of April 1850. He began his career as a carver's assistant, and before beginning the regular study of plastic art he passed through a long apprenticeship in architectural decoration. In 1879 he came to London and entered the Lambeth School of Art, studying under Jules Dalou and Rodin, and winning a silver medal in the national competition at South Kensington. In 1881 he was admitted to the Royal Academy schools, where in 1883 he won the gold medal and the travelling scholarship of £200 with his relief of "Socrates teaching the People in the Agora," which showed grace of line and harmony of composition. He then went to Paris and studied under Rodin. A head and three small bronze panels (the "Odyssey,") executed by Bates in Paris, were exhibited at the Royal Academy, and selected for purchase by the Chantry trustees; but the selection had to be cancelled because they had not been modelled in England. His "Aeneas" (1885), "Homer" (1886), three "Psyche" panels and "Rhodope" (1887) all showed marked advance in form and dignity; and in 1892, after the exhibition of his vigorously designed "Hounds in Leash." Bates was elected A.R.A. This and his "Pandora," in marble and ivory, which was bought in the same year for the Chantry Bequest, are now in the Tate Gallery. The portrait-busts of Harry Bates are good pieces of realism—strong, yet delicate in technique, and excellent in character. His statues have a picturesqueness in which the refinement of the sculptor is always felt. Among the chief of these are the fanciful "Maharaja of Mysore," somewhat overlaid with ornament, and the colossal equestrian statue of Lord Roberts (1896) upon its important pedestal, girdled with a frieze of figures, now set up in Calcutta, and a statue of Queen Victoria for Dundee. But perhaps his masterpiece, showing the sculptor's delicate fancy and skill in composition, was an allegorical presentment of "Love and Life"—a winged male figure in bronze, with a female figure in ivory being crowned by the male. Bates died in London on the 30th of January 1899, his premature death robbing English plastic art of its most promising representative at the time. (See SCULPTURE.)

BATES, HENRY WALTER (1825–1892), English naturalist and explorer, was born at Leicester on the 8th of February 1825. His father, a manufacturing hosier, intended him for business, and for a time the son yielded to his wishes, escaping as often as he could into the neighbouring country to gratify his love of botany and entomology. In 1844 he met a congenial spirit in Alfred Russel Wallace, and the result was discussion and execution of a plan to explore some then little-known region of the globe. The banks of the Amazons was the district chosen, and in April 1848 the two friends sailed in a trader for Pará. They had little or no money, but hoped to meet their expenses by the sale of duplicate specimens. After two years Bates and Wallace agreed to collect independently, Wallace taking the Rio Negro and the upper waters of the Orinoco, while Bates continued his route up the great river for 1400 m. He remained in the country eleven years, during which time he collected no fewer than 8000 species

of insects new to science. His long residence in the tropics, with the privations which it entailed, undermined his health. Nor had the exile from home the compensation of freeing him from financial cares, which hung heavy on him till he had the good fortune to be appointed in 1864 assistant-secretary of the Royal Geographical Society, a post which, to the inestimable gain of the society, and the advantage of a succession of explorers, to whom he was alike Nestor and Mentor, he retained till his death on the 16th of February 1892. Bates is best known as the author of one of the most delightful books of travel in the English language, *The Naturalist on the Amazons* (1863), the writing of which, as the correspondence between the two has shown, was due to Charles Darwin's persistent urgency. "Bates," wrote Darwin to Sir Charles Lyell, "is second only to Humboldt in describing a tropical forest." But his most memorable contribution to biological science, and more especially to that branch of it which deals with the agencies of modification of organisms, was his paper on the "Insect Fauna of the Amazon Valley," read before the Linnaean Society in 1861. He therein, as Darwin testified, clearly stated and solved the problem of "mimicry," or the superficial resemblances between totally different species and the likeness between an animal and its surroundings, whereby it evades its foes or conceals itself from its prey. Bates's other contributions to the literature of science and travel were sparse and fugitive, but he edited for several years a periodical of *Illustrated Travels*. A man of varied tastes, he devoted the larger part of his leisure to entomology, notably to the classification of coleoptera. Of these he left an extensive and unique collection, which, fortunately for science, was purchased intact by René Oberthur of Rennes.

BATES, JOHN. A famous case in English constitutional history, tried before the court of exchequer in November 1666, arose out of the refusal of a merchant of the Levant Company, John Bates, to pay an extra duty of 5s. per cwt. on imported currants levied by the sole authority of the crown in addition to the 2s. 6d. granted by the Statute of Tonnage and Poundage, on the ground that such an imposition was illegal without the sanction of parliament. The unanimous decision of the four barons of the exchequer in favour of the crown threatened to establish a precedent which, in view of the rapidly increasing foreign trade, would have made the king independent of parliament. The judgments of Chief Baron Fleming and Baron Clark are preserved. The first declares that "the king's power is double, ordinary and absolute, and they have several laws and ends. That of the ordinary is for the profit of particular subjects, for the execution of civil justice . . . in the ordinary courts, and by the civilians is nominated *ius privatum*, and with us common law; and these laws *cannot* be changed without parliament. . . . The absolute power of the king is not that which is converted or executed to private uses to the benefit of particular persons, but is only that which is applied to the general benefit of the people and is *salus populi*; and this power is not guided by the rules which direct only at the common law, and is most properly named policy or government; and as the constitution of this body varieth with the time, so varieth this absolute law, according to the wisdom of the king, for the common good; and these being general rules, and true as they are, all things done within these rules are lawful. The matter in question is material matter of state, and ought to be ruled by the rules of policy, and if it be so, the king hath done well to execute his extraordinary power. All customs (*i.e.* duties levied at the ports), be they old or new, are no other but the effects and issues of trades and commerce with foreign nations; but all commerce and affairs with foreigners, all wars and peace, all acceptance and admitting for foreign current coin, all parties and treaties whatsoever are made by the absolute power of the king; and he who hath power of causes hath power also of effects." Baron Clark, in his judgment, concurred, declaring that the seaports were the king's ports, and that, since foreign merchants were admitted to them only by leave of the crown, the crown possessed also the right of fixing the conditions under which they should be admitted, including the imposition of a money payment. Incidentally, Baron Clark, in reply to the argument that

the king's right to levy impositions was limited by the statute of 1370-1371, advanced a principle still more dangerous to constitutional liberty. "The statute of the 45 Edward III. cap. 4," he said, "which hath been so much urged, that no new imposition shall be imposed upon wool-fells, wool or leather, but only the custom and subsidy granted to the king—this extends only to the king himself and shall not bind his successors, for it is a principal part of the crown of England, which the king cannot diminish."

See *State Trials* (ed. 1779), xi. pp. 30-32; excerpts in G. W. Prothero, *Statutes and Constitutional Documents* (Clarendon Press, 1894); G. B. Adams and H. Morse Stephens, *Select Documents of Eng. Const. Hist.* (New York, 1901); cf. T. P. Taswell-Langmead, *Eng. Const. Hist.* (London, 1905), p. 393. (W. A. P.)

BATES, JOSHUA (1788-1864), American financier, was born in Weymouth, Massachusetts, on the 10th of October 1788, of an old Massachusetts family prominent in colonial affairs. After several winters' schooling in his native town, he entered the counting-house of William Gray & Son in Boston. In 1809 he began business on his own account, but failed during the War of 1812 and again became associated with the Grays, then the largest shipowners in America, by whom a few years later he was sent to London in charge of their European business. There he came into relations with the Barings, and in 1826 formed a partnership with John, a son of Sir Thomas Baring. Two years later both partners were admitted to the firm of Baring Brothers & Company, of which Bates eventually became senior partner, occupying in consequence an influential position in the British financial world. In 1853-1854 he acted with rare impartiality and justice as umpire of the international commission appointed to settle claims growing out of the War of 1812. In 1852-1855 he contributed \$100,000 in books and in cash for a public library in Boston, the money to be invested and the annual income to be applied to the purchase of books. Upon his death the "upper hall," or main reference-room (opened in 1861) in the building erected in 1858 by the order of the library trustees, was named Bates Hall; and upon the opening of the new building in 1895 this name was transferred to its principal reading-room, one of the finest library halls in the world. During the Civil War Bates's sympathies were strongly with the Union, and besides aiding the United States government fiscal agents in various ways, he used his influence to prevent the raising of loans for the Confederacy. He died in London on the 24th of September 1864.

See *Memorial of Joshua Bates* (Boston, 1865).

BATES, WILLIAM (1625-1699), English nonconformist divine, was born in London in November 1625. He was admitted to Emmanuel College, Cambridge, and removed thence to King's College in 1644. Of Presbyterian belief, he held the rich living of St Dunstan's-in-the-West, London. He was one of the commissioners at the conference in the Savoy, for reviewing the public liturgy, and was concerned in drawing up the exceptions to the Book of Common Prayer. Notwithstanding this he was appointed chaplain to Charles II., and was offered the deanery of Lichfield and Coventry, but he came out in 1662 as one of the 200 ejected ministers. Bates was of an amiable character, and enjoyed the friendship of the lord-keeper Bridgeman, the lord-chancellor Finch, the earl of Nottingham and Archbishop Tillotson. With other moderate churchmen he made several efforts towards a comprehensive settlement, but the bishops were uncompromising. He addressed William and Mary on their accession in behalf of the dissenters. After some years of pastoral service at Hackney he died there on the 14th of July 1699. Bates published *Select Lives of Illustrious and Pious Persons* in Latin; and after his death all his works, except this, were printed in 1 vol. fol.; again in 1723; and in 4 vols. 8vo in 1815. They treat of practical theology and include *Considerations on the Existence of God and the Immortality of the Soul* (1676), *Four Last Things* (1691), *Spiritual Perfection* (1699).

BATESON (BATSON or BETSON), **THOMAS**, an English writer of madrigals in the early 17th century. He is said to have been organist of Chester cathedral in 1599, and is believed to have been the first musical graduate of Trinity College, Dublin. He

is known to have written church music, but his fame rests on his madrigals, which give him an important place among Elizabethan composers. He published a set of madrigals in 1604 and a second set in 1618, and both collections have been reprinted in recent years. He died in 1630.

BATH, THOMAS THYNNNE, 1ST MARQUESS OF (1734-1796), English politician, was the elder son of Thomas Thynne, 2nd Viscount Weymouth (1710-1751), and the great-grandnephew of Thomas Thynne (c. 1640-1714), the friend of Bishop Ken who was created Baron Thynne and Viscount Weymouth in 1682. His mother was Louisa (d. 1736), daughter of John Carteret, 1st Earl Granville, and a descendant of the family of Granville who held the earldom of Bath from 1661 to 1711. The Thynnes are descended from Sir John Thynne, the builder of Longleat, the splendid seat of the family in Wiltshire. Sir John owed his wealth and position to the favour of his master, the protector Somerset; he was comptroller of the household of the princess Elizabeth, and was a person of some importance after the princess became queen. He died in April 1580. Another famous member of this family was Thomas Thynne (1648-1682), called on account of his wealth "Tom of Ten Thousand." He is celebrated by Dryden as Issachar in *Absalom and Achitophel*, and was murdered in London by some Swedes in February 1682.

Born on the 13th of September 1734, Thomas Thynne succeeded his father as 3rd Viscount Weymouth in January 1751, and was lord-lieutenant of Ireland for a short time during 1765, although he never visited that country. Having, however, become prominent in English politics he was appointed secretary of state for the northern department in January 1768; he acted with great promptitude during the unrest caused by John Wilkes and the Middlesex election of 1768. He was then attacked and libelled by Wilkes, who was consequently expelled from the House of Commons. Before the close of 1768 he was transferred from the northern to the southern department, but he resigned in December 1770 in the midst of the dispute with Spain over the possession of the Falkland Islands. In November 1775 Weymouth returned to his former office of secretary for the southern department, undertaking in addition the duties attached to the northern department for a few months in 1779, but he resigned both positions in the autumn of this year. In 1789 he was created marquess of Bath, and he died on the 19th of November 1796. Weymouth was a man of considerable ability especially as a speaker, but according to more modern standards his habits were very coarse, resembling those of his friend and frequent companion, Charles James Fox. Horace Walpole refers frequently to his idleness and his drunkenness, and in early life at least "his great fortune he had damaged by such profuse play, that his house was often full of bailiffs." He married Elizabeth (d. 1825), daughter of William Bentinck, 2nd duke of Portland, by whom he had three sons and ten daughters. His eldest son Thomas (1765-1837) succeeded to his titles, while the two younger ones, George (1770-1838) and John (1772-1849), succeeded in turn to the barony of Cartaret of Hawke, which came to them from their uncle, Henry Frederick Thynne (1735-1826). Weymouth's great-grandson, John Alexander, 4th marquess of Bath (1831-1896), the author of *Observations on Bulgarian affairs* (1880), was succeeded as 5th marquess by his son Thomas Henry (b. 1862).

See B. Botfield, *Stemmata Botvilliana* (1858).

BATH, WILLIAM PULTENEY, 1ST EARL OF (1684-1764), generally known by the surname of PULTENEY, English politician, descended from an ancient family of Leicestershire, was the 509th of William Pulteney by his first wife, Mary Floyd, and was born in April 1684. The boy was sent to Westminster school, and from it proceeded to Christ Church, Oxford, matriculating the 31st of October 1700. At these institutions he acquired his deep classical knowledge. On leaving Oxford he made the usual tour on the continent. In 1705 he was brought into parliament by Henry Guy (secretary of the treasury, 1679-1688, and June 1691 to February 1695) for the Yorkshire borough of Hedon, and at his death on the 23rd of February 1710 inherited an estate of

£500 a year and £40,000 in cash. This seat was held by him without a break until 1734. Throughout the reign of Queen Anne William Pulteney played a prominent part in the struggles of the Whigs, and on the prosecution of Sacheverell he exerted himself with great zeal against that violent divine. When the victorious Tories sent his friend Robert Walpole to the Tower in 1712, Pulteney championed his cause in the House of Commons and with the leading Whigs visited him in his prison-chamber. He held the post of secretary of war from 1714 to 1717 in the first ministry of George I., and when the committee of secrecy on the Utrecht treaty was formed in April 1715 the list included the name of William Pulteney. Two years later (6th of July 1716, he became one of the privy council. When Townshend was dismissed, in April 1717, from his post of lord-lieutenant of Ireland, and Walpole resigned his places, they were followed in their retirement by Pulteney. The crash of the South Sea Company restored Walpole to the highest position, but all that he offered to Pulteney was a peerage. The offer was rejected, but in May 1723 Pulteney stooped to accept the lucrative but insignificant post of cofferer of the household. In this obscure position he was content for some time to await the future; but when he found himself neglected he opposed the proposition of Walpole to discharge the debts of the civil list, and in April 1725 was dismissed from his sinecure. From the day of his dismissal to that of his ultimate triumph Pulteney remained in opposition, and, although Sir Robert Walpole attempted in 1730 to conciliate him by the offer of Townshend's place and of a peerage, all his overtures were spurned. Pulteney's resentment was not confined to his speeches in parliament. With Bolingbroke he set on foot in December 1726 the well-known periodical called the *Craftsman*, and in its pages the minister was incessantly denounced for many years. Lord Hervey published an attack on the *Craftsman*, and Pulteney, either openly or behind the person of Amhurst, its editor, replied to the attack. Whether the question at issue was the civil list, the excise, the income of the prince of Wales, or the state of domestic affairs Pulteney was ready with a pamphlet, and the minister or one of his friends came out with a reply. For his "Proper reply to a late scurrilous libel" (*Craftsman*, 1731), an answer to "Sedition and defamation displayed," he was challenged to a duel by Lord Hervey; for another, "An answer to one part of an infamous libel entitled remarks on the *Craftsman's* indication of his two honourable patrons," he was in July 1731 struck off the roll of privy councillors and dismissed from the commission of the peace in several counties. In print Pulteney was inferior to Bolingbroke alone among the antagonists of Walpole, but in parliament, from which St John was excluded, he excelled all his comrades. When the sinking fund was appropriated in 1733 his voice was the foremost in denunciation; when the excise scheme in the same year was stirring popular feeling to its lowest depths the passion of the multitude broke out in his oratory. Through Walpole's prudent withdrawal of the latter measure the fall of his ministry was averted. Bolingbroke withdrew to France on the suggestion, it is said, of Pulteney, and the opposition was weakened by the dissensions of the leaders.

From the general election of 1734 until his elevation to the peerage Pulteney sat for Middlesex. For some years after this election the minister's assailants made little progress in their attack, but in 1738 the troubles with Spain supplied them with the opportunity which they desired. Walpole long argued for peace, but he was feebly supported in his own cabinet, and the frenzy of the people for war knew no bounds. In an evil moment for his own reputation he consented to remain in office and to gratify popular passion with a war against Spain. His downfall was not long deferred. War was declared in 1739; a new parliament was summoned in the summer of 1741, and over the divisions on the election petitions the ministry of Walpole fell to pieces. The task of forming the new administration was after some delay entrusted to Pulteney, who weakly offered the post of first lord of the treasury to that harmless politician the earl of Wilmington, and contented himself with a seat in the cabinet and a peerage, thinking that by this action he would preserve

his reputation for consistency in disdaining office and yet retain his supremacy in the ministry. At this act popular feeling broke out into open indignation, and from the moment of his elevation to the Upper House Pulteney's influence dwindled to nothing. Horace Walpole asserts that when Pulteney wished to recall his desire for a peerage it was forced upon him through the ex-minister's advice by the king, and another chronicler of the times records that when victor and vanquished met in the House of Lords, the one as Lord Orford, the other as the earl of Bath, the remark was made by the exulting Orford: "Here we are, my lord, the two most insignificant fellows in England." On the 14th of July 1742 Pulteney was created Baron Pulteney of Hedon, Co. York, Viscount Pulteney of Wrington, Co. Somerset, and earl of Bath. On the 20th of February he had been restored to his rank in the privy council. At Wilmington's death in 1743 he made application to the king for the post of first lord of the treasury, only to find that it had been conferred on Henry Pelham. For two days, 10th-12th February 1746, he was at the head of a ministry, but in "48 hours, three quarters, seven minutes, and eleven seconds" it collapsed. An occasional pamphlet and an infrequent speech were afterwards the sole fruits of Lord Bath's talents. His praises whilst in retirement have been sung by two bishops, Zachary Pearce and Thomas Newton. He died on the 7th of July 1764, and was buried on the 17th of July in his own vault in Islip chapel, Westminster Abbey. He married on the 27th of December 1714 Anna Maria, daughter and co-heiress of John Gumley of Isleworth, commissary-general to the army who was often satirized by the wits of the day (*Notes and Queries*, 3rd S. ii. 402-403, iii. 400). She died on the 14th of September 1758, and their only son William died unmarried at Madrid on the 12th of February 1763. Pulteney's vast fortune came in 1767 to William Johnstone of Dumfries (third son of Sir James Johnstone), who had married Frances, daughter and co-heiress of his cousin, Daniel Pulteney, a bitter antagonist of Walpole in parliament, and had taken the name of Pulteney.

Pulteney's eloquence was keen and incisive, sparkling with vivacity and with allusions drawn from the literature of his own country and of Rome. Of business he was never fond, and the loss in 1734 of his trusted friend John Merrill, who had supplied the qualities which he lacked, was feelingly lamented by him in a letter to Swift. His chief weakness was a passion for money. Lord Bath has left no trace of the possession of practical statesmanship.

BIBLIOGRAPHY.—Wm. Cox's *Memoirs of Sir Robert Walpole* (1816), and of Henry Pelham (1829); John Morley's *Walpole* (1886); Walter Sichel's *Bolingbroke* (1901-1902); A. Ballantyne's *Carteret* (1887); *Eng. Hist. Rev.* iv. 749-753, and the general political memoirs of the time. (W. P. C.)

BATH, a city, municipal, county and parliamentary borough, and health resort of Somersetshire, England, on the Great Western, Midland, and Somerset & Dorset railways, 10½ m. W. by S. of London. Pop. (1901) 49,839. Its terraces and crescents, built mostly of grey freestone, cover the slopes and heights of the abrupt hills which rise like an amphitheatre above the winding valley of the river Avon. The climate is pleasant, and the city, standing amidst fine scenery, itself possesses a number of beautiful walks and gardens. Jointly with Wells, it is an episcopal see of the Church of England. The abbey church of St Peter and St Paul occupies the site of earlier Saxon and Norman churches, founded in connexion with a 7th-century convent, which was transferred for a time to a body of secular canons, and from about 970 until the Dissolution, to Benedictine monks. The present cruciform building dates from the 15th century, being a singularly pure and ornate example of late Perpendicular work. From the number of its windows, it has been called "The Lantern of the West," and especially noteworthy is the great west window, with seven lights, and flanking turrets on which are carved figures of the angels ascending and descending on Jacob's Ladder. Within are the tombs of James Quin, the actor, with an epitaph by Garrick; Richard Nash; Thomas Malthus the economist; William Broome the poet, and many others. Some of the monuments are the work of Bacon,

Flaxman and Chantrey. Slight traces of the previous Norman building remain. There are many other churches and chapels in Bath, the oldest being that of St Thomas of Canterbury, and one of the most interesting St Swithin's, which contains the tombs of Christopher Anstey and Madame d'Arbly. Among educational institutions may be mentioned the free grammar school, founded by Edward VI., the Wesleyan College, originally established at Bristol by John Wesley, and the Roman Catholic College. The hospital of St John was founded in the 12th century. The public buildings include a guild hall, assembly rooms, Jubilee hall, art gallery and library, museum, literary and scientific institute, and theatres. In the populous suburb of Twerton (pop. 11,098), there are lias quarries, and bricks and woollen cloths are manufactured. The parliamentary borough returns two members. The city is governed by a mayor, 14 aldermen and 42 councillors. Area, 3382 acres.

The mineral springs supply several distinct establishments. The temperature varies in the different springs from 117° to 120° F., and the specific gravity of the hot baths is 1.002. The principal substances in solution are calcium and sodium sulphates, and sodium and magnesium chlorides. Traces of radium have been revealed, and the gases contain argon and helium. The waters are very beneficial in cases of rheumatism, gout, neuralgia, sciatica, diseases of the liver, and cutaneous and scrofulous affections. The highest archaeological interest, moreover, attaches to the baths in view of the magnificent Roman remains testifying to the early recognition of the value of the waters. It may here be noted that two distinct legends ascribe the foundation of Bath to a British king Bladud. According to Geoffrey of Monmouth this monarch gave its healing power to the water by his spells. According to a later version, he was banished as a leper, and made the discovery leading to his cure, and to the origin of Bath, whilst wandering as a swineherd in 863 B.C. This, at least, is the date inscribed on a statue of Bladud placed in the Pump Room in 1699. There is, however, no real evidence of a British settlement. By the Romans Bath was named *Aquae Sulis*, the name indicating the dedication to a British goddess Sul or Sulis, whom the Romans considered the counterpart of Minerva. There were a temple of the goddess and a few houses for priests, officials and visitors, besides the large baths, and the place was apparently walled; but it did not contain a large resident population. Many relics have been disinterred, such as altars, inscriptions, fragments of stone carvings and figures, Samian ware, and others. The chief buildings were apparently grouped near the later abbey churchyard, and included, besides two temples, a magnificent bath, discovered when the duke of Kingston pulled down the old priory in 1755 to form the Kingston Baths. Successive excavations have rendered accessible a remarkable series of remains, including several baths, a *sudarium*, and conduits. The main bath still receives its water (now for the purpose of cooling) through the original conduit. The fragmentary colonnade surrounding this magnificent relic still supports the street and buildings beneath which it lies, the Roman foundations having been left untouched. The remains of the bath and of the temple are among the most striking Roman antiquities in western Europe.

Bath (variously known as Achemann, Hat Bathun, Bathonea, Batha) was a place of note in Saxon times, King Edgar being crowned there in 973. It was a royal borough governed by a reeve, with a burg mote in 907. Richard I. granted the first charter in 1189, which allowed the same privileges as Winchester to the members of the merchant gild. This was confirmed by Henry III. in 1236, 1247 and 1256, by charters giving the burgesses of Bath the right to elect coroners, with freedom from arrest for the debts of others, and from the interference of sheriffs or kings' bailiffs. Charters were granted by succeeding kings in 1312, 1322, 1341, 1382, 1399, 1414, 1432, 1447, 1466 and 1545. The existence of a corporation being assumed in the earliest royal charter, and a common seal having been used since 1249, there was no formal incorporation of Bath until the charter of 1500, 1794 and 1835. Parliamentary representation began in 1207. Various fairs were granted to Bath, to be held on the 29th of August, the 9th of

August, the 30th of June to the 8th of July (called Cherry Fair), the 1st of February to the 6th of February, in 1275, 1305, 1325 and 1545 respectively. Fairs are now held on the 4th of February and on the Monday after the 9th of December. These fairs were flourishing centres of the cloth trade in the middle ages, but this industry has long departed. Bath "beaver," however, was known throughout England, and Chaucer makes his "Wife of Bath" excel the cloth-weavers "of Ypres and of Gaunt." The golden age of Bath began in the 18th century, and is linked with the work of the two architects Wood (both named John), of Ralph Allen, their patron, and of Richard Nash, master of the ceremonies. Previously the baths had been ill-kept, the lodging poor, the streets beset by footpads. All this was changed by the architectural scheme, including Queen Square, the Royal Crescent and the North and South Parades, which was chiefly designed by the elder Wood, and chiefly executed by his son. Instead of the booth which did duty as a gaming club and chocolate house, Nash provided the assembly rooms which figure largely in the pages of Fielding, Smollett, Burney, Dickens and their contemporaries. Anstey published his *New Bath Guide* to ridicule the laws of taste which "Beau" Nash dictated; but two royal visits, in 1734 and 1738, established Bath as a centre of English fashion. The weekly markets granted on Wednesday and Saturday in 1305 are still held.

See R. Warner, *History and Antiquities of Bath* (1801); C. E. Davis, *Ancient Landmarks of Bath; The Mineral Baths of Bath* (1883); *Excavations of Roman Baths* (1895), and *The Saxon Cross* (1898); Sir G. Jackson, *Archives of Bath* (2 vols., 1873); R. E. M. Peach, *Rambles about Bath* (1875), *Bath Old and New* (1888), *Collections of Books belonging to the City* (1893), &c.; H. Scarth, *Aquae Sulis, or Notices of Roman Bath* (1864); A. Barbeau, *Life and Letters at Bath in the 18th Century* (from the French *Une Ville d'eaux anglaise au XVIIIe siècle*) (London, 1904); A. H. King, *Charter of Bath Corporation*.

BATH, a city, port of entry, and the county-seat of Sagadahoc county, Maine, U.S.A., on the W. bank of the Kennebec river, 12 m. from its mouth and 36 m. N.E. of Portland. Pop. (1890) 8723; (1900) 10,477, of whom 1759 were foreign-born; (1910, census) 9356. It is served by the Maine Central railway, by steamboat lines to Boston, and by inter-urban electric railway. The city covers an area of about 9 sq. m., and extends along the W. bank of the river for about 5 m.; the business district is only a few feet above sea-level, but most of the residences are on higher ground. The streets are well shaded, chiefly with elms. At Bath are the state military and naval orphan asylum, two homes for

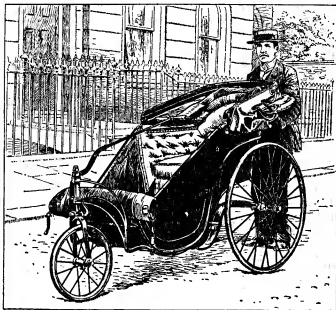

the aged, and a soldiers' monument. Bath has a good harbour and its principal industry is the building of ships, both of wood and of iron and steel; several vessels of the United States navy

have been built here. In 1905 three-fourths of the city's wage-earners were employed in this industry. Bath also manufactures lumber, iron and brass goods, and has a considerable trade in ice, coal, lumber and iron and steel. First settled about 1660, Bath was a part of Georgetown until 1781, when it was incorporated as a separate town; in 1789 it was made a port of entry, and in 1847 was chartered as a city.

BATH-CHAIR, a vehicle with a folding hood, which can be used open or closed, and a glass front, mounted on three or four wheels and drawn or pushed by hand. If required to be drawn by a donkey or small pony it is then mounted on four wheels, with the usual turning arrangement. James Heath, of Bath, who flourished rather before the middle of the 18th century, was the inventor.

BATHGATE, a municipal and police burgh of Linlithgowshire, Scotland, 19 m. W. by S. of Edinburgh by the North British railway. Pop. (1901) 7549. The district is rich in limestone, coal, ironstone, shale and fireclay, all of which are worked. Silver also was once mined. The manufactures include paraffin, paper, glass, chemicals, flour and whisky, and freestone is quarried. The burgh is a considerable centre for agricultural produce. Bathgate became a burgh of barony in 1824 and a police burgh in 1865. Although it was not until the development of its mineral wealth that it attained to commercial importance, it is a place of some antiquity, and formed the dowry of Marjory, Robert Bruce's daughter, who married Walter, the hereditary steward of Scotland, in 1315.

BATHOLITE (from Gr. βάθος, deep, and λίθος, a stone), in geology, a term given to certain intrusive rock masses. Especially in districts which are composed principally of rocks belonging to the older geological systems extensive areas of granite frequently occur. By their relations to the strata around them, it is clear that these granites have been forced into their present positions in a liquid state, and under great pressure. The bedding planes of stratified rocks are wedged apart and tongues of granite have been injected into them, while cracks have been opened up and filled with intrusions in the shape of igneous veins. Great masses of the strata which the granite has invaded are often floated off, and are found lying in the heart of the granite much altered by the heat to which they have been exposed, and traversed by the igneous rock in ramifying threads. Such granite intrusions are generally known as bosses from their rounded surfaces, and the frequency with which they form flattish dome-shaped hills, rising above the older rocks surrounding them. At one time many geologists held that in certain situations the granite had arisen from the complete fusion and transformation of the stratified rocks over a limited area of intense metamorphism. The chemical no less than the structural relations of the two sets of rocks, however, preclude the acceptance of this hypothesis. Obviously the granite is an intruder which has welled up from below, and has cooled gradually, and solidified in its present situation.

Regarding the mechanism of this process there are two theories which hold the field, each having a large number of supporters. One school considers that they are mostly "batholiths" or conical masses rising from great depths and eating up the strata which lie above and around them. The frequency of inclusions of the surrounding rocks, their rounded shapes indicating that they have been partly dissolved by the igneous magma, the intense alteration which they have undergone pointing to a state approaching actual fusion, the extensive changes induced in the rocks which adjoin the granite, the abundance of veins, and the unusual modifications of the granite which occur where it comes in contact with the adjacent strata, are adduced as evidence that there has been absorption and digestion of the country rock by the intrusive mass. These views are in favour especially in France; and instances are cited in which as the margins of the granite are approached diorites and other rocks make their appearance, which are ascribed to the effect which admixture with dissolved sedimentary material has had on the composition of the granite magma; at the same time the schists have been permeated

with felspar from the igneous rocks, and are said to have been felspathized.

The opponents of this theory hold these granitic masses to be "laccolites" (Gr. λακκος, a cistern), or great cake-shaped injections of molten rock, which have been pressed from below into planes of weakness in the upper portions of the earth's crust, taking the lines of least resistance, and owing their shape to the varying flexibility of the strata they penetrated. The modifications of the granite are ascribed to magmatic segregation (chemical and physical processes which occasioned diffusion of certain components towards the cooling surfaces). Absorption of country rock is held to be unimportant in amount, and insufficient to account for the great spaces in the schists which are occupied by the granite. Those who support this theory leave the question of the ultimate source of the granite unanswered, but consider that it is of deep-seated origin, and the bosses which now appear at the surface are only comparatively superficial manifestations.

The bulk of the evidence is in favour of the laccolitic theory; in fact it has been clearly demonstrated in many important cases. Still it is equally clear that many granites are not merely passive injections, but have assimilated much foreign rock. Possibly much depends on the chemical composition of the respective masses, and on the depths and temperatures at which the intrusion took place. Increase of pressure and of temperature, which we know to take place at great depths, would stimulate resorption of sedimentary material, and by retarding cooling would allow time for dissolved foreign substances to diffuse widely through the magma. (J. S. F.)

BATHONIAN SERIES, in geology. The typical Bathonian is the Great Oolite series of England, and the name was derived from the "Bath Oolite," so extensively mined and quarried in the vicinity of that city, where the principal strata were first studied by W. Smith. The term was first used by J. d'Omalius d'Halloy in 1843 (*Precis Geol.*) as a synonym for "Dogger"; but it was limited in 1849 by A. d'Orbigny (*Pal. Franc. Jur. i. p. 607*). In 1864 Mayer-Eymar (*Tabl. Synchro.*) used the word "Bathien" = Bajocian + Bathonian (sen. str.). According to English practice, the Bathonian includes the following formations in descending order: Cornbrash, Forest Marble with Bradford Clay, Great or Bath Oolite, Stonesfield Slate and Fullers' Earth. (The Fullers' Earth is sometimes regarded as constituting a separate stage, the "Fullonian.") The "Bathonien" of some French geologists differs from the English Bathonian in that it includes at the base the zone of the ammonite *Parkinsonia Parkinsoni*, which in England is placed at the summit of the Inferior Oolite. The Bathonian is the equivalent of the upper part of the "Dogger" (Middle Jurassic) of Germany, or to the base of the Upper Brown Jura (substage "E" of Quenstedt).

Rocks of Bathonian age are well developed in Europe: in the N.W. and S.W. oolite limestones are characteristically associated with coral-bearing, crinoidal and other varieties, and with certain beds of clay. In the N. and N.E., Russia, &c., clays, sandstones and ferruginous oolites prevail, some of the last being exploited for iron. They occur also in the extreme north of America and in the Arctic regions, Greenland, Franz Josef Land, &c.; in Africa, Algeria, German East Africa, Madagascar and near the Cape (Enon Beds); in India, Rajputana and Gulf of Cutch, and in South America.

The well-known Caen stone of Normandy and "Hauptrogenstein" of Swabia, as well as the "Eisenkalk" of N.W. Germany, and "Klaus-Schichten" of the Austrian Alps, are of Bathonian age.

For a general account, see A. de Lapparent, *Traité de géologie* (5th ed., 1906), vol. ii.; see also the article JUKASSIC. (J. A. H.)

BATHORY, SIGISMUND (ZSIGMOND), (1572-1613), prince of Transylvania, was the son of Christopher, prince of Transylvania, and Elizabeth Bocskay, and nephew of the great Stephen Báthory. He was elected prince in his father's lifetime, but being quite young at his father's death (1581), the government was entrusted to a regency. In 1588 he attained his majority, and

following the advice of his favourite councillor Alfonso Carillo, departed from the traditional policy of Transylvania in its best days (when friendly relations with the Porte were maintained as a matter of course, in order to counterpoise the ever hostile influence of the house of Habsburg), and joined the league of Christian princes against the Turk. The obvious danger of such a course caused no small anxiety in the principality, and the diet of Torda even went so far as to demand a fresh coronation oath from Sigismund, and, on his refusal to render it, threatened him with deposition. Ultimately Báthory got the better of his opponents, and executed all whom he got into his hands (1595). Nevertheless, if anybody could have successfully carried out an anti-Turkish policy, it was certainly Báthory. He had inherited the military genius of his uncle, and his victories astonished contemporary Europe. In 1595 he subdued Wallachia and annihilated the army of Sinan Pasha at Gurgevo (October 28th). The turning-point of his career was his separation from his wife, the archduchess Christina of Austria, in 1599, an event followed by his own abdication the same year, in order that he might take orders. It was on this occasion that he offered the throne of Transylvania to the emperor Rudolph II., in exchange for the duchy of Oppeln. In 1600, however, at the head of an army of Poles and Cossacks, he attempted to recover his throne, but was routed by Michael, voivode of Moldavia, at Suceava. In February 1601 the diet of Klausenburg reinstated him, but again he was driven out by Michael, never to return. He died at Prague in 1613. Báthory's indisputable genius must have been warped by a strain of madness. His incalculableness, his savage cruelty (like most of the princes of his house he was a fanatical Catholic and persecutor) and his perpetual restlessness point plainly enough to a disordered mind.

See Ignaz Acsády, *History of the Hungarian State* (Hung.), vol. ii., (Budapest, 1904).

BATHOS (Gr. *βάθος*), properly depth, the bottom or lowest part of anything. The current usage for an anticlimax, a descent "from the sublime to the ridiculous," from the elevated to the commonplace in literature or speech, is due to Pope's satire on *Bathos* (*Miscellanies*, 1727-1728), "the art of sinking in poetry." The title was a travesty of Longinus's essay, *On the Sublime*, *Περὶ ὑψηλοῦ*.

BATHS. In the ordinary acceptation of the word a bath is the immersion of the body in a medium different from the ordinary one of atmospheric air, which medium is usually common water in some form. In another sense it includes the different media that may be used, and the various arrangements by which they are applied.

Ancient Baths.—Bathing, as serving both for cleanliness and for pleasure, has been almost instinctively practised by nearly every people. The most ancient records mention bathing in the rivers Nile and Ganges. From an early period the Jews bathed in running water, used both hot and cold baths, and employed oils and ointments. So also did the Greeks; their earliest and commonest form of bathing was swimming in rivers, and bathing in them was practised by both sexes. Warm baths were, according to Homer, used after fatigue or private. The Athenians appear for a long time to have had only private baths, but afterwards they had public ones: the latter seem to have originated among the Lacedaemonians, who invented the hot-air bath, at least the form of it called after them the *laconicum*. Although the baths of the Greeks were not so luxurious as those of some other nations, yet effeminate people were accused among them of using warm baths in excess; and the bath servants appear to have been rogues and thieves, as in later and larger establishments. The Persians must have had handsomely equipped baths, for Alexander the Great admired the luxury of the bath of Darius.

But the baths of the Greeks, and probably of all Eastern nations, were on a small scale as compared with those which eventually sprang up among the Romans. In early times the Romans used after exercise to throw themselves into the Tiber. Next, when ample supplies of water were brought into the city, large *piscinae*, or cold swimming baths, were constructed, the

earliest of which appear to have been the *piscina publica* (312 B.C.), near the Circus Maximus, supplied by the Appian aqueduct, the *lavacrum* of Agrippina, and a bath at the end of the Clivus Capitolinus. Next, small public as well as private baths were built; and with the empire more luxurious forms of bathing were introduced, and warm became far more popular than cold baths.

Public baths (*balneae*) were first built in Rome after Clodius brought in the supply of water from Praeneste. After that date baths began to be common both in Rome and in other Italian cities; and private baths, which gradually came into use, were attached to the villas of the wealthy citizens. Maecenas was one of the first who built public baths at his own expense. After his time each emperor, as he wished to ingratiate himself with the people, lavished the revenues of the state in the construction of enormous buildings, which not only contained suites of bathing apartments, but included gymnasia, and sometimes even theatres and libraries. Such enormous establishments went by the name of *thermae*. The principal *thermae* were those of Agrippa 21 B.C., of Nero 65 A.D., of Titus 81, of Domitian 95, of Commodus 185, of Caracalla 217, and still later those of Diocletian 302, and of Constantine. The technical skill displayed by the Romans in rendering their walls and the sides of reservoirs impervious to moisture, in conveying and heating water, and in constructing flues for the conveyance of hot air through the walls, was of the highest order.

The Roman baths contained swimming baths, warm baths, baths of hot air, and vapour baths. The chief rooms (which in the largest baths appear to have been mostly distinct, whereas in smaller baths one chamber was made to do duty for more than a single purpose) were the following:—(1) the *apodyterium* or *spoliatorium*, where the bathers undressed; (2) the *alipterium* or *unctuarium*, where oils and ointments were kept (although the bathers often brought their own pomades), and where the *alipse* anointed the bathers; (3) the *frigidarium*, or cool room, *cella frigida*, in which usually was the cold bath, the *piscina* or *baptisterium*; (4) the *tepidarium*, a room moderately heated, in which the bathers rested for a time, but which was not meant for bathing; (5) the *calidarium* or heating room, over the *hypocaustum* or furnace; this in its commonest arrangement had at one end a warm bath, the *alveus* or *calida lavatio*; at the other end in a sort of alcove was (6) the *sudatorium* or *laconicum*, which usually had a *labrum* or large vessel containing water, with which bathers sprinkled themselves to help in rubbing off the perspiration. In the largest baths the *laconicum* was probably a separate chamber, a circular domical room with recesses in the sides, and a large opening in the top; but there is no well-preserved specimen, unless that at Pisa may be so regarded. In the drawing of baths from the *thermae* of Titus (fig. 1), the *laconicum* is represented as a small cupola rising in a corner of the *calidarium*. It is known that the temperature of the *laconicum* was regulated by drawing up or down a metallic plate or *clypeus*. Some think that this *clypeus* was directly over the flames of the *hypocaustum*, and that when it was withdrawn, the flames must have sprung into the *laconicum*. Others, and apparently they have Vitruvius on their side, think that the *clypeus* was drawn up or down only from the aperture in the roof, and that it regulated the temperature simply by giving more or less free exit to the hot air. If the *laconicum* was only one end of the *calidarium*, it is difficult to see how that end of the room was kept so much hotter than the rest of it; on the other hand, to have had flames actually issuing from the *laconicum* must have caused smoke and soot, and have been very unpleasant. The most usual order in which the rooms were employed seems to have been the following, but there does not appear to have been any absolute uniformity of practice then, any more than in modern Egyptian and Turkish baths. Celsus recommends the bather first to sweat a little in the *tepidarium* with his clothes on, to be anointed there, and then to pass into the *calidarium*; after he has sweated freely there he is not to descend into the *solum* or cold bath, but to have plenty of water poured over him from his head,—first warm, then tepid, and then

cold water—the water being poured longer over his head than on the rest of the body; next to be scraped with the strigil, and lastly to be rubbed and anointed.

The warmest of the heated rooms, *i.e.* the calidarium and laconicum, were heated directly from the hypocaustum, over which they were built or suspended (*suspensura*); while from the hypocaustum tubes of brass, or lead, or pottery carried the hot air or vapour to the walls of the other rooms. The walls were usually hollow, so that the hot air could readily circulate.

The water was heated ingeniously. Close to the furnace, about 4 in. off, was placed the *calidarium*, the copper (*athenum*) for boiling water, near which, with the same interval between them, was the copper for warm water, the *tepidarium*, and at the distance of 2 ft. from this was the receptacle for cold water, or the *frigidarium*, often a plastered reservoir. A constant communication was kept up between these vessels, so that as fast as hot water was drawn off from the calidarium a supply was obtained from the tepidarium, which, being already heated, but slightly reduced the temperature of the hotter boiler. The tepidarium, again, was supplied from the frigidarium, and that from an aqueduct. In this way the heat which was not taken up by the first boiler passed on to the second, and instead of being wasted, helped to heat the second—a principle which has only lately been introduced into modern furnaces. In the case of the large *thermae* the water of an aqueduct was brought to the *castellum* or top of the building and was allowed to descend into chambers over the hypocaustum, where it was heated and transmitted in pipes to the central buildings. Remains of this arrangement are to be seen in the baths of Caracalla. The general plan of such buildings may be more clearly understood by the accompanying illustrations. In the well-known drawing (fig. 1) found in the baths of Titus, the name of each part of the building is inscribed on it. The small dome inscribed laconicum directly over the furnace, and having

ments of the women's baths were similar, but on a smaller scale. The calidarium (5) had the labrum (7) at one end, and the alveus (6) was in one side of the room. The general arrangements of a

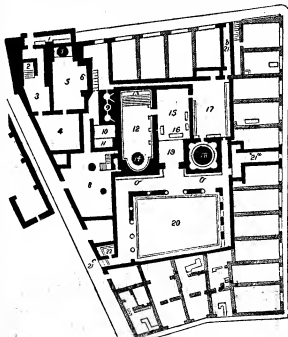

FIG. 2.—Ground plan of the baths of Pompeii.

calidarium are well illustrated by the accompanying section (fig. 3) of a bath discovered at Tusculum. The disposition of the parts is the same as at Pompeii. We here have the calidarium supported on the pillars of the fornax, the *suspensura*. The alveus (3) is at one end, and the labrum (4) at the other. (1) and (2) are the vessels for water over the fornax; and the passages in the roof and walls for the escape of heated air will be observed.

A clear idea of the relative position of the different rooms, and some slight indication of their ornamentation, will be obtained from fig. 4. The flues under the calidarium and the labrum (1) may be observed, as also the opening in the roof above. (2), (3) and (4) mark the vessels for water which are placed between the men's baths on the left and the women's on the right.

The arrangements of the *thermae* were mainly those of the *balneae* on a larger scale. Some idea of their size may be gathered

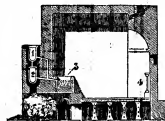

FIG. 3.—Section of bath discovered at Tusculum, showing the calidarium (hot room).



FIG. 1.—Roman baths.

the clypeus over it, will be observed in the corner of the chamber named *concamerata sudatio*. The vessels for water are inscribed, according to their temperature, with the same names as some of the chambers, *frigidarium*, *tepidarium* and *calidarium*.

The baths of Pompeii (as shown in fig. 2) were a double set, and were surrounded with *tabernae* or shops, which are marked by a lighter shade. There were streets on four sides; and the reservoir supplying water was across the street in the building on the left hand of the cut. There were three public entrances—21a, 21b, 21c—to the men's baths and one to the women's. The furnaces (9) heated water, which was conveyed on one side to the larger baths of the men, on the other to the women's. Entering from the street at 21c there was a *latrina* on the left hand (22). From this entrance it was usual to proceed to a court (20) surrounded by pillars, where servants were in attendance. There is some doubt as to the purpose to which the room (19) was devoted. Leaving the hall a passage conducted to the *apodyterium* or dressing-room (17), at one end of it is the *frigidarium*, *baptisterium* or cold plunge bath (18). Entering out of the *apodyterium* is the *tepidarium* or warming-room (15), which most probably was also used as the *alipiterium* or anointing-room. From it bathers passed into the hot room or *calidarium* (12), which had at one end the *alveus* or *calida lavatio* (13), at the other end the *labrum* (14). This end of the *calidarium* served as the *laconicum*. The arrange-

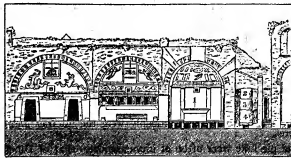

FRIGIDARIUM TEPIDARIUM CALIDARIUM

FIG. 4.—Section of baths of Pompeii.

from such facts as these, that in the baths of Diocletian one room has been transmuted into a church of most imposing proportions,

and that the outside walls of the baths of Caracalla extend about a quarter of a mile on each of the four sides. A visit to the remains of the baths of Titus, of Diocletian, or of Caracalla impresses the mind strongly with a sense of the vast scale on which they were erected, and Ammianus's designation of them as provinces appears scarcely exaggerated. It is said that the baths of Caracalla contained 1600, and those of Diocletian 2700 marble seats for the use of the bathers. In the largest of the *thermae* there was a stadium for the games of the young men, with raised seats for the spectators. There were open colonnades and seats for philosophers and literary men to sit and discourse or read their productions aloud or for others to discuss the latest news. Near the porticoes, in the interior open space, rows of trees were planted. There was a *sphaeristerium* or place for playing ball, which was often over the *apodyterium*; but it must be confessed that the purposes of many portions of these large edifices have not been made out in as satisfactory a way as those of smaller baths. A more definite idea of the *thermae* can be best got by an examination of the accompanying plan of the baths of Caracalla (fig. 5). A good deal of the plan is conjectural, the restorations being marked by lighter shading.

At the bottom of the plan is shown a long colonnade, which faces the street, behind which was a series of chambers, supposed to have

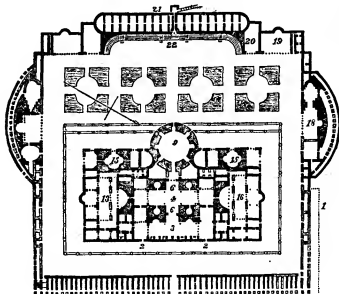

FIG. 5.—Ground plan of the baths of Caracalla.

been separate bathing-rooms. Entering by the opening in its centre, the visitor passes what was probably an inner colonnade round the main building. Passing in by either of the gates (2, 2), he reaches the large chamber (3), which has been variously called the *natio* or large swimming-bath, or the *tepidarium*. The great central room (4) in all probability was the *calidarium*, with two *labra* (6, 6) on opposite sides, and with four alvei, one in each corner, represented by small circular dots. (9) has been regarded by some as the *laconicum*, although it appears very large for that purpose. The rooms (15, 15) have been variously described as *baptisteria* and as *laconica*. Most authors are agreed in thinking that the large rooms (13) and (16) were the *sphaeristeria* or places for playing ball.

Returning to the outside, (1) and (18) and the corresponding places on the other side are supposed to have been the *exedrae* for philosophers, and places corresponding to the Greek *xysti*. (20) and (19) have been considered to be servants' rooms. (22) was the stadium, with raised seats for the spectators. The space between this and the large central hall (9) was planted with trees, and at (21) the aqueduct brought water into the castellum or reservoir, which was on an upper story. There were upper storeys in most portions of the building, and in these probably were the libraries and small theatres.

The *piscinae* were often of immense size—that of Diocletian being 200 ft. long—and were adorned with beautiful marbles. The halls were crowded with magnificent columns and were ornamented with the finest pieces of statuary. The walls, it has been said, were covered with exquisite mosaics that imitated the art of the painter in their elegance of design and variety of colour.

The Egyptian syenite was encrusted with the precious green marbles of Numidia. The rooms contained the works of Phidias and Praxiteles. A perpetual stream of water was poured into capacious basins through the wide mouths of lions of bright and polished silver, water issued from silver, and was received on silver. "To such a pitch of luxury have we reached," says Seneca, "that we are dissatisfied if we do not tread on gems in our baths."

The richer Romans used every variety of oils and pomades (*smegmata*); they scarcely had true soaps. The poorer class had to be content with the flour of lentils, an article used at this day for the same purpose by Orientals. The most important bath utensil was the *strigillus*, a curved instrument made of metal, with which the skin was scraped and all sordes removed.

The bath servants assisted in anointing, in using the *strigillus* and in various other menial offices. The poorer classes had to use their *strigils* themselves. The various processes of the *alpitae* seem to have been carried on very systematically.

The hot baths appear to have been open from 1 P.M. till dark. It was only one of the later emperors that had them lighted up at night. When the hot baths were ready (for, doubtless, the plunge baths were available at an earlier hour), a bell or *aes* was rung for the information of the people. Among the Greeks and Romans the eighth hour, or 1 o'clock, before their dinner, was the commonest hour for bathing. The bath was supposed to promote appetite, and some voluptuaries had one or more baths after dinner, to enable them to begin eating again; but such excesses, as Juvenal tells us, occasionally proved fatal. Some of the most effeminate of the emperors are said to have bathed seven or eight times in the course of the day. In early times there was delicacy of feeling about the sexes bathing together—even a father could not bathe with his sons; but latterly, under most of the emperors, men and women often used the same baths. There frequently were separate baths for the women, as we see at Pompeii or at Badenweiler; but although respectable matrons would not go to public baths, promiscuous bathing was common during the Empire.

The public baths and *thermae* were under the more immediate superintendence of the aediles. The charge made at a public bath was only a quadrans or quarter of an as, about half a farthing. Yet cheap though this was, the emperors used to ingratiate themselves with the populace, by making the baths at times gratuitous.

Wherever the Romans settled, they built public baths; and wherever they found hot springs or natural stufae, they made use of them, thus saving the expense of heating, as at the *myrieta* of Baiae or the *Aquae Sulis* of Bath. In the cities there appear to have been private baths for hire, as well as the public baths; and every rich citizen had a set of baths attached to his villa, the fullest account of which is given in the *Letters* of Pliny, or in Asonius's *Account of a Villa on the Moselle*, or in Statius's *De Balneo Etrusco*. Although the Romans never wholly gave up cold bathing, and that practice was revived under Augustus by Antonius Musa, and again under Nero by Charmis (at which later time bathing in the open sea became common), yet they chiefly practised warm bathing (*calida lavatio*). This is the most luxurious kind of bathing, and when indulged in to excess is enervating. The women were particularly fond of these baths, and were accused, at all events in some provincial cities, of drunkenness in them.

The unbounded license of the public baths, and their connexion

¹ The figure represents four *strigils*, in which the hollow for collecting the oil or perspiration from the body may be observed. There is also a small *ampulla* or vessel containing oil, meant to keep the *strigils* smooth, and a small flat *patera* or drinking vessel, out of which it was customary to drink after the bathing was finished.

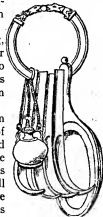

FIG. 6.—Ring on which are suspended some of the articles of use in the Alpitae.

with modes of amusement that were condemned, led to their being to a considerable extent proscribed by the early Christians. The early Fathers wrote that bathing might be practised for the sake of cleanliness or of health, but not of pleasure; and Gregory the Great saw no objection to baths being used on Sunday. About the 5th century many of the large *thermae* in Rome fell into decay. The cutting off of the aqueducts by the Huns, and the gradual decrease of the population, contributed to this. Still it is doubtful whether bathing was ever disused to the extent that is usually represented. It was certainly kept up in the East in full vigour at Alexandria and at Brusa. Hot bathing, and especially hot air and vapour baths, were adopted by the Mahomedans; and the Arabs brought them with them into Spain. The Turks, at a later time, carried them high up the Danube, and the Mahomedans spread or, it may be more correct to say, revived their use in Persia and in Hindustan. The Crusaders also contributed to the spread of baths in Europe, and hot vapour baths were especially recommended for the leprosy so prevalent in those days. After the commencement of the 13th century there were few large cities in Europe without hot vapour baths. We have full accounts of their regulations—how the Jews were only allowed to visit them once a week, and how there were separate baths for lepers. In England they were called *hothouses*. Erasmus, at the date of the Reformation, spoke of them as common in France, Germany and Belgium; he gives a lively account of the mixture of all classes of people to be found in them, and would imply that they were a common adjunct to inns. They seem after a time to have become less common, though Montaigne mentions them as being still in Rome in his day. In England the next revival of baths was at the close of the 17th century, under the Eastern name of *Hummums* or the Italian name of *Bagnios*. These were avowedly on the principle of the Turkish baths described below. But there were several considerable epochs in the history of baths, one in the commencement of the 18th century, when Floyer and others recalled attention to cold bathing, of which the virtues had long been overlooked. In the middle of the century also, Russell and others revived sea-bathing in England, and were followed by others on the continent, until the value of sea-bathing became fully appreciated. Later in the same century the experiments of James Currie on the action of complete or of partial baths on the system in disease attracted attention; and though forgotten for a while, they bore abundant fruit in more recent times.

Modern Baths.—It is uncertain how far the Turkish and Egyptian and even the Russian baths are to be regarded merely as successors of the Roman baths, because the principle of vapour baths has been known to many nations in a very early period of civilization. Thus the Mexicans and Indians were found using small vapour baths. The ancient inhabitants of Ireland and of Scotland had some notion of their use, and the large vapour baths of Japan, now so extensively employed, are probably of independent origin.

The following accounts of Turkish and Russian baths illustrate the practices of the ancient Roman and also of modern Turkish baths. In Lane's *On the Modern Egyptians* we read: "The building consists of several apartments, all of which are paved with marble, chiefly white. The inner apartments are covered with domes, which have a number of small glazed apertures for the admission of light. The bather, on entering, if he has a watch or purse, gives them in charge to the keeper of the bath. The servant of the bath takes off his shoes and supplies him with a pair of wooden clogs. The first apartment has generally three or four *leewans* (raised parts of the floor used as couches) cased with marble, and a fountain of cold water, which rises from an octagonal basement in the centre. One of the leewans, which is meant for the higher classes, is furnished with cushions or mats. In warm weather bathers usually undress in this room; in winter they undress in an inner room, called the *beytawal* or first chamber, between which and the last apartment there is a passage often with two or three latrines off it. This is the first of the heated chambers. It generally has two

raised seats. The bather receives a napkin in which to put his clothes and another to put round his waist—this reaches to the knees; a third, if he requires it, is brought him to wind round his head, leaving the top of it bare; a fourth to put over his chest; and a fifth to cover his back. When the bather has undressed, the attendant opens to him the door of the inner and principal apartment. This in general has four leewans, which gives it the form of a cross, and in the centre a fountain of hot water rises from a small shallow basin. The centre room, with the adjoining ones, forms almost a square. The *beytawal* already mentioned is one of them. Two small chambers which adjoin each other, one containing a tank of hot water, the other containing a trough, over which are two taps, one of hot and one of cold water, occupy the two other angles; while the fourth angle of the square is occupied by the chamber which contains the fire, over which is the boiler. The bather having entered this apartment soon perspires profusely from the humid heat which is produced by the hot water of tanks and fountains, and by the steam of the boiler. The bather sits on one of the marble seats, or lies on the leewan or near one of the tanks, and the operator then commences his work. The operator first cracks aloud every joint in the body. He makes the vertebrae of the back and even of the neck crack. The limbs are twisted with apparent violence, but so skillfully, that no harm is ever done. The operator next kneads the patient's flesh. After this he rubs the soles of the feet with a kind of rasp of baked clay. There are two kinds of rasps, one porous and rough, one of fine smooth clay. Those used by ladies are usually encased in thin embossed silver. The next operation is rubbing the bather's flesh with a small coarse woollen bag, after which the bather dips himself in one of the tanks. He is next taken to one of the chambers in the corner, and the operator lathers the bather with fibres of the palm tree, soap and water. The soap is then washed off with water, when the bather having finished washing, and enveloped himself in dry towels, returns to the *beytawal* and reclines. Here he generally remains an hour to an hour and a half, sipping coffee and smoking, while an attendant rubs the soles of the feet and kneads the body and limbs. The bather then dresses and goes out."

The following description of a Russian bath is from Kohl's *Russia* (1842): "The passage from the door is divided into two behind the check-taker's post, one for the male, one for the female guests. We first enter an open space, in which a set of men are sitting in a state of nudity on benches, those who have already bathed dressing, while those who are going to undergo the process take off their clothes. Round this space or apartment are the doors leading to the vapour-rooms. The bather is ushered into them, and finds himself in a room full of vapour, which is surrounded by a wooden platform rising in steps to near the roof of the room. The bather is made to lie down on one of the lower benches, and gradually to ascend to the higher and hotter ones. The first sensation on entering the room amounts almost to a feeling of suffocation. After you have been subjected for some time to a temperature which may rise to 145° the transpiration reaches its full activity, and the sensation is very pleasant. The bath attendants come and flog you with birchen twigs, cover you with the lather of soap, afterwards rub it off, and then hold you over a jet of ice-cold water. The shock is great, but is followed by a pleasant feeling of great comfort and of alleviation of any rheumatic pains you may have had. In regular establishments you go after this and lie down on a bed for a time before issuing forth. But the Russians often dress in the open air, and instead of using the jet of cold water, go and roll themselves at once in the snow."

Turkish baths have, with various modifications, become popular in Europe. The Russian baths were introduced into German towns about 1825. They had a certain limited amount of popularity, but did not take firm root. Another class practically owes its origin to Dr Barter and David Urquhart. It professed to be founded on the Turkish bath, but in reality it was much more of a hot air bath, *i.e.* more devoid of vapour than either Roman or Turkish baths ever were, for it is doubtful

whether in any case the air of the laconicum was free from vapour. These baths, with their various modifications, have become extremely popular in Great Britain, in Germany and in northern Europe, but have, curiously enough, never been used extensively in France, notwithstanding the familiarity of the French with Turkish baths in Algiers.

In England hot air baths are now employed very extensively. They are often associated with Turkish and electric baths.

Bathing among the ancients was practised in various forms. It was sometimes a simple bath in cold or in tepid water; but at least, in the case of the higher orders, it usually included a hot air or vapour bath, and was followed by affusion of cold or warm water, and generally by a plunge into the piscina. In like manner the order varies in which the different processes are gone through in Turkish baths in modern Europe. Thus in the baths in Vienna, the process begins by immersion in a large basin of warm water. Sudation is repeatedly interrupted by cold douches at the will of the bathers, and after the bath they are satisfied with a short stay in the cooling-room, where they have only a simple sheet rolled round them. In Copenhagen and in Stockholm the Oriental baths have been considerably modified by their association with hydropathic practices.

This leads us to notice the introduction of the curiously misnamed system known as hydropathy (*q.v.*). Although cold baths were in vogue for a time in Rome, warm baths were always more popular. Floyer, as we have seen, did something to revive their use in England; but it was nearly a century and a half afterwards that a Silesian peasant, Priessnitz, introduced, with wonderful success, a variety of operations with cold water, the most important of which was the packing the patient in a wet sheet, a process which after a time is followed by profuse sudation. Large establishments for carrying out this mode of bathing and its modifications were erected in many places on the continent and in Great Britain, and enjoyed at one time a large share of popularity. The name "hydropathy" is still retained for these establishments, though hydropathy so-called is no longer practised within them to any extent.

But the greatest and most important development of ordinary baths in modern times was in England, though it has extended gradually to some parts of the continent. The English had long used affusion and swimming-baths freely in India. Cold and hot baths and shower baths have been introduced into private houses to an extent never known before; and, since 1842, public swimming-baths, besides separate baths, have been supplied to the public at very moderate rates, in some cases associated with wash-houses for the poorer classes. Their number has increased rapidly in London and in the principal continental cities. Floating-baths in rivers, always known in some German towns, have become common wherever there are flowing streams. The better supply of most European cities with water has aided in this movement. Ample enclosed swimming-baths have been erected at many seaside places. When required, the water, if not heated in a boiler, is raised to a sufficient temperature by the aid of hot water pipes or of steam. Separate baths used to be of wood, painted; they are now most frequently of metal, painted or lined with porcelain enamel. The swimming-baths are lined with cement, tiles or marble and porcelain slabs; and a good deal of ornamentation and painting of the walls and ceiling of the apartments, in imitation of the ancients, has been attempted.

We have thus traced in outline the history of baths through successive ages. The medium of the baths spoken of thus far has been water, vapour or dry hot air. But baths of more complex nature, and of the greatest variety, have been in use from the earliest ages. The best known media are the various mineral waters and sea-water. Of baths of mineral substances, those of sand are the oldest and best known; the practice of *arenation* or of burying the body in the sand of the seashore, or in heated sand near some hot spring, is very ancient, as also that of applying heated sand to various parts of the body. Baths of *peat* earth are of comparatively recent origin. The peat earth is carefully prepared and pulverized, and then worked

up with water into a pasty consistence, of which the temperature can be regulated before the patient immerses himself in it.

There are various terms that may be termed *chemical*, in which chlorine or hydrochloric acid is added to the water of the bath, or where fumes of sulphur are made to rise and envelop the body.

Of *vegetable* baths the number is very large. Lees of wine, in a state of fermentation, have been employed. An immense variety of aromatic herbs have been used to impregnate water with. At one time fuci or sea-weed were added to baths, under the idea of conveying into the system the iodine which they contain; but by far the most popular of all vegetable baths are those made with an extract got by distilling certain varieties of pine leaves.

The strangeness of the baths of *animal* substances, that have been at various times in use, is such that their employment seems scarcely credible. That baths of milk or of whey might be not unpopular is not surprising, but baths of blood, in some cases even of human blood, have been used; and baths of horse dung were for many ages in high favour, and were even succeeded for a short time by baths of guano.

Electrical baths are now largely used, a current being passed through the water; and electrical *massage*, by the d'Arsonval or other system, is colloquially termed a "bath."

Baths also of *compressed air*, in which the patient is subjected to the pressure of two or three atmospheres, were formerly employed in some places.

A *sun bath* (*insolatio* or *heliosis*), exposing the body to the sun, the head being covered, was a favourite practice among the Greeks and Romans.

Some special devices require a few words of explanation.

Douches were used by the ancients, and have always been an important mode of applying water to a circumscribed portion of the body. They are, in fact, sprouts of water, varying in size and temperature, applied by a hose-pipe with more or less force for a longer or shorter time against particular parts. A *douche* exercises a certain amount of friction, and a continued impulse on the spot to which it is applied, which stimulate the skin and the parts beneath it, quickening the capillary circulation. The effects of the *douche* are so powerful that it cannot be applied for more than a few minutes continuously. The alternation of hot and cold douches, which for some unknown reason has got the name of *Écossaise*, is a very potent type of bath from the strong action and reaction which it produces. The *shower* bath may be regarded as a union of an immense number of fine douches projected on the head and shoulders. It produces a strong effect on the nervous system. An ingenious contrivance for giving circular *spray* baths, by which water is propelled laterally in fine streams against every portion of the surface of the body, is now common.

To all these modes of acting on the cutaneous surface and circulation must be added dry rubbing, as practised by the patient with the flesh glove, but much more thoroughly by the bath attendants, if properly instructed (see also *MASSAGE*).

Action of Baths on the Human System.—The primary operation of baths is the action of heat and cold on the cutaneous surfaces through the medium of water.

The first purpose of baths is simply that of absterion and cleanliness, to remove any foreign impurity from the surface, and to prevent the pores from being clogged by their own secretions or by desquamations of cuticle. It need scarcely be said that such objects are greatly promoted by the action of the alkali of soaps and by friction; that the use of warm water, owing to its immediate stimulation of the skin, promotes the separation of *sordes*, and that the vapour of water is still more efficient than water itself.

It has been supposed that water acts on the system by being absorbed through the skin, but, under ordinary circumstances, no water is absorbed, or, if any, so minute a quantity as not to be worth considering. No dissolved substances, under the ordinary circumstances of a bath, are actually absorbed into the system; although when a portion of skin has been entirely cleared of its sebaceous secretion, it is possible that a strong solution of salts

may be partially absorbed. In the case of medicated baths we therefore only look (in addition to the action of heat and cold, or more properly to the abstraction or communication and retention of heat) to any stimulant action on the skin that the ingredients of the bath may possess.

The powerful influence of water on the capillaries of the skin, and the mode and extent of that operation, depend primarily on the temperature of the fluid. The human system bears changes of temperature of the air much better than changes of the temperature of water. While the temperature of the air at 75° may be too warm for the feelings of many people, a continued bath at that temperature is felt to be cold and depressing. Again, a bath of 98° to 102° acts far more excitingly than air of the same temperature, both because, being a better conductor, water brings more heat to the body and because it suppresses the perspiration which is greatly augmented by air of that temperature. Further, a temperature a few degrees below blood heat is that of indifferent baths, which can be borne longest without natural disturbance of the system.

Cold baths act by refrigeration, and their effects vary according to the degree of temperature. The effects of a cold bath, the temperature not being below 50°, are these:—there is a diminution of the temperature of the skin and of the subjacent tissues; there is a certain feeling of shock diffused over the whole surface, and if the cold is intense it induces a slight feeling of numbness in the skin. It becomes pale and its capillaries contract. The further action of a cold bath reaches the central nervous system, the heart and the lungs, as manifested by the tremor of the limbs it produces, along with a certain degree of oppression of the chest and a gasping for air, while the pulse becomes small and sinks. After a time reaction takes place, and brings redness to the skin and an increase of temperature.

The colder the water is, and the more powerful and depressing its effects, the quicker and more active is the reaction. Very cold baths, anything below 50°, cannot be borne long. Lowering of the temperature of the skin may be borne down to 0°, but a further reduction may prove fatal. The diminution of temperature is much more rapid when the water is in motion, or when the bather moves about; because, if the water is still, the layer of it in immediate contact with the body is warmed to a certain degree.

A great deal depends on the form of the cold bath; thus one may have—(1) Its depressing operation,—with a loss of heat, retardation of the circulation, and feeling of weariness, when the same water remains in contact with the skin, and there is continuous withdrawal of heat without fresh stimulation. This occurs with full or sitz baths, with partial or complete wrapping up the body in a wet sheet which remains unchanged, and with frictions practised without removing the wet sheets. (2) Its exciting operation,—with quickening of the action of the heart and lungs, and feeling of glow and of nervous excitement and of increased muscular power. These sensations are produced when the layer of water next the body and heated by it is removed, and fresh cold water causes fresh stimulus. These effects are produced by full baths with the water in motion used only for a short time, by frictions when the wet sheet is removed from the body, by douches, shower baths, bathing in rivers, &c. The depressing operation comes on much earlier in very cold water than in warmer; and in the same way the exciting operation comes on faster with the colder than with the warmer water. The short duration of the bath makes both its depressing and its exciting action less; its longer duration increases them; and if the baths be continued too long, the protracted abstraction of animal heat may prove very depressing.

Tepid baths, 85° to 95°.—The effects of a bath of this temperature are confined to the peripheral extremities of the nerves, and are so slight that they do not reach the central system. There is no reaction, and the body temperature remains unchanged. Baths of this kind can be borne for hours with impunity.

Warm baths from 96° to 104°.—In these the action of the heat on the peripheral surface is propagated to the central system, and causes reaction, which manifests itself in moderately increased

flow of the blood to the surface, and in an increased frequency of pulse.

With a *hot bath* from 102° up to 110° the central nervous and circulating systems are more affected. The frequency of the pulse increases rapidly, the respiration becomes quickened, and is interrupted by deep inspirations. The skin is congested, and there is profuse perspiration.

Very hot baths.—Everything above 110° feels very hot; anything above 120° almost scalding. Baths of from 110° to 126° have caused a rise of 2° to 4½° in the temperature of the blood. Such a bath can be borne for only a few minutes. It causes great rapidity of the pulse, extreme lowering of the blood-pressure, excessive congestion of the skin, and violent perspiration.

In the use of hot baths a certain amount of vapour reaches the parts of the body not covered by the water, and is also inhaled.

Vapour baths produce profuse perspiration and act in cleansing the skin, as powerful hot water baths do. Vapour, owing to its smaller specific heat, does not act so fast as water on the body. A vapour bath can be borne for a much longer time when the vapour is not inhaled. Vapour baths can be borne hotter than water baths, but cannot be continued too long, as vapour, being a bad conductor, prevents radiation of heat from the body. A higher heat than 122° is not borne comfortably. The vapour bath though falling considerably short of the temperature of the hot air bath, raises the temperature much more.

Hot air baths differ from vapour baths in not impeding the respiration as the latter do, by depositing moisture in the bronchial tubes. The lungs, instead of having to heat the inspired air, are subjected to a temperature above their own. Hot air baths, say of 135°, produce more profuse perspiration than vapour baths. If very hot, they raise the temperature of the body by several degrees. Vapour baths, hot air baths, and hot water baths agree in producing violent perspiration. As perspiration eliminates water and effete matter from the system, it is obvious that its regulation must have an important effect on the economy.

In comparing the general effects of cold and hot baths, it may be said that while the former tend to check perspiration, the latter favour it.

The warm bath causes swelling and congestion of the capillaries of the surface in the first instance; when the stimulus of heat is withdrawn their contraction ensues. A cold bath, again, first causes a contraction of the capillaries of the surface, which is followed by their expansion when reaction sets in. A warm bath elevates the temperature of the body, both by bringing a supply of heat to it and by preventing the radiation of heat from it. It can be borne longer than a cold bath. It draws blood to the surface, while a cold bath favours internal congestions.

But baths often produce injurious effects when used injudiciously. Long continued warm baths are soporific, and have, owing to this action, often caused death by drowning. The effects of very hot baths are swimming in the head, vomiting, fainting, congestion of the brain, and, in some instances, apoplexy.

The symptoms seem to point to paralysis of the action of the heart. It is therefore very evident how cautious those should be, in the use of hot baths, who have weak hearts or any obstruction to the circulation. Fat men, and those in whom the heart or blood-vessels are unsound, should avoid them. Protracted indulgence in warm baths is relaxing, and has been esteemed a sign of effeminacy in all ages. Sleepiness, though it will not follow the first immersion in a cold bath, is one of the effects of protracted cold baths; depression of the temperature of the surface becomes dangerous. The risk in cold baths is congestion of the internal organs, as often indicated by the lips getting blue. Extremely cold baths are always dangerous.

For the medical use of baths see BALNEOTHERAPEUTICS.

Public Baths.—It was not till 1846 that it was deemed advisable in England, for the "health, comfort, and welfare" of the inhabitants of towns and populous districts, to encourage the establishment therein of baths by the local authority acting through commissioners. A series of statutes, known collectively as "The Baths and Wash-houses Acts 1846 to 1866," followed. By the Public Health Act 1875, the urban authority was declared

to be the authority having power to adopt and proceed under the previous acts, and in 1878 provision was for the first time expressly made for the establishment of swimming baths, which might be used during the winter as gymnasias, and by an amending act of 1899, for music or dancing, provided a licence is obtained. By the Local Government Act 1894, it was provided that the parish meeting should be the authority having exclusive power of adopting the Baths and Wash-houses Acts in rural districts, which should, if adopted, be carried into effect by the parish council. Up to 1865 it seems as if only twenty-five boroughs had cared to provide bathing accommodation for their inhabitants. There is no complete information as to the number of authorities who have adopted the acts since 1865, but a return of reproductive undertakings presented to the House of Commons in 1899 shows that 110 local authorities outside the metropolis applied for power to raise loans to provide baths, of whom 48 applied before 1875 and 62 after 1875. In the year 1907 the loans sanctioned for the purpose amounted to £53,026. The revenues of parish councils are so limited that it has not been possible for them to take much advantage of the acts. In the metropolis, by the Local Government Act of 1894, the power of working the act was given to vestries, and by the act of 1899 this power was transferred to the borough councils. There are 35 parishes in London in which the acts have been adopted, all of which except 11 have taken action since 1875. These establishments, according to the return made in 1908, provided 3502 private baths and 104 swimming baths. The maximum charge for a second-class cold bath is 1d., for a hot bath 2d. In 1904-1905 the number of bathers was 6,342,158, of whom 3,064,998 were bathers in private baths and 3,277,160 bathers in swimming baths. In 1896-1897 the gross total had been only 2,000,000. In cases where the proportion between the sexes has been worked out, it is found that only 18% of the users of private baths, and 10% of the users of swimming baths, are females. In 1898 the School Board was authorized to pay the fees for children using the baths if instruction in swimming were provided, and in 1907-1908 the privilege was used by 1,556,542 children. The cost of this public provision in London—water being supplied by measure—is over £80,000 a year. No account can be given of the numbers using the ponds and lakes in the parks and open spaces, but it is computed that on a hot Sunday 25,000 people bathe in Victoria Park, London, some of the bathers starting as early as four o'clock in the morning. These returns show how great is the increase of the habit of bathing, but they also show how even now the habit is limited to a comparatively small part of the population. People require to be tempted to the use of water, at any rate at the beginning. There are still authorities in London responsible for 800,000 persons who have provided no baths, and those who have made provision have not always done so in a sufficiently liberal and tempting way. The comparison between English great towns and those of the continent is not in favour of the former.

For the literature of baths in earlier periods we may refer to the *Architecture* of Vitruvius, and to Lucian's *Hippias*; see art. "Bäder" in Pauly-Wissowa, *Realencyclopädie* (1896), by A. Mau; "Balneum" in Daremberg and Saglio, *Dict. des antiquités*; J. Marquardt, *Das Privatleben der Römer* (1886), pp. 269-297; Becker's *Gallus*, and the article "Balneae" by Rich, in Dr Smith's *Dictionary of Greek and Roman Antiquities* (rev. ed. 1890); also the bibliography to *HYDROPATHY*.

BATHURST, EARLS. ALLEN BATHURST, 1st Earl Bathurst (1684-1775), was the eldest son of Sir Benjamin Bathurst (d. 1704), by his wife, Frances (d. 1727), daughter of Sir Allen Apsley of Apsley, Sussex, and belonged to a family which is said to have settled in Sussex before the Norman Conquest. He was educated at Trinity College, Oxford, and became member of parliament for Cirencester in May 1705, retaining his seat until December 1711, when he was created Baron Bathurst of Battlesden, Bedfordshire. As a zealous Tory he defended Atterbury, bishop of Rochester, and in the House of Lords was an opponent of Sir Robert Walpole. After Walpole left office in 1742 he was made a privy councillor, and in August 1772 was created Earl

Bathurst, having previously received a pension of £2000 a year chargeable upon the Irish revenues. He died on the 16th of September 1775, and was buried in Cirencester church. In July 1704 Bathurst married his cousin, Catherine (d. 1768), daughter of Sir Peter Apsley, by whom he had four sons and five daughters. The elder associated with the poets and scholars of the time. Pope, Swift, Prior, Sterne, and Congreve were among his friends. He is described in Sterne's *Letters to Eliza*; was the subject of a graceful reference on the part of Burke speaking in the House of Commons; and the letters which passed between him and Pope are published in Pope's *Works*, vol. viii. (London, 1872).

HENRY, 2nd Earl Bathurst (1714-1794), was the eldest surviving son of the 1st earl. Educated at Balliol College, Oxford, he was called to the bar, and became a K.C. in 1745. In April 1735 he had been elected member of parliament for Cirencester, and was rewarded for his opposition to the government by being made solicitor-general and then attorney-general to Frederick, prince of Wales. Resigning his seat in parliament in April 1754 he was made a judge of the court of common pleas in the following month, and became lord high chancellor in January 1771, when he was raised to the peerage as Baron Apsley. Having become Earl Bathurst by his father's death in September 1775, he resigned his office somewhat unwillingly in July 1778 to enable Thurlow to join the cabinet of Lord North. In November 1779 he was appointed lord president of the council, and left office with North in March 1782. He died at Oakley Grove near Cirencester on the 6th of August 1794. Bathurst was twice married, and left two sons and four daughters. He was a weak lord chancellor, but appears to have been just and fair in his distribution of patronage.

HENRY, 3rd Earl Bathurst (1762-1834), the elder son of the second earl, was born on the 22nd of May 1762. In April 1789 he married Georgiana (d. 1841), daughter of Lord George Henry Lennox, and was member of parliament for Cirencester from 1783 until he succeeded to the earldom in August 1794. Owing mainly to his friendship with William Pitt, he was a lord of the admiralty from 1783 to 1789; a lord of the treasury from 1789 to 1791; and commissioner of the board of control from 1793 to 1802. Returning to office with Pitt in May 1804 he became master of the mint, and was president of the Board of Trade and master of the mint during the ministries of the duke of Portland and Spencer Perceval, only vacating these posts in June 1812 to become secretary for war and the colonies under the earl of Liverpool. For two months during the year 1809 he was in charge of the foreign office. He was secretary for war and the colonies until Liverpool resigned in April 1827; and deserves some credit for improving the conduct of the Peninsular War, while it was his duty to defend the government concerning its treatment of Napoleon Bonaparte. Bathurst's official position caused his name to be mentioned frequently during the agitation for the abolition of slavery, and with regard to this traffic he seems to have been animated by a humane spirit. He was lord president of the council in the government of the duke of Wellington from 1828 to 1830, and favoured the removal of the disabilities of Roman Catholics, but was a sturdy opponent of the reform bill of 1832. The earl, who had four sons and two daughters, died on the 27th of July 1834. Bathurst was made a knight of the Garter in 1817, and held several lucrative sinecures.

His eldest son, HENRY GEORGE, 4th Earl Bathurst (1790-1866), was member of parliament for Cirencester from 1812 to 1834. He died unmarried on the 25th of May 1866, and was succeeded in the title by his brother, WILLIAM LENNOX, 5th Earl Bathurst (1791-1878), member of parliament for Weobley from 1812 to 1816, and clerk of the privy council from 1827 to 1860, who died unmarried on the 24th of February 1878.

ALLEN ALEXANDER, 6th Earl Bathurst (1832-1892), was the son of Thomas Seymour Bathurst, and grandson of the 3rd earl. He was member of parliament for Cirencester from 1857 until he became Earl Bathurst in February 1878, and died on the 2nd of August 1892, when his eldest son, SEYMOUR HENRY (b. 1864), became 7th Earl Bathurst.

BATHURST, a city of Bathurst county, New South Wales, Australia, 144 m. by rail W.N.W. of Sydney on the Great Western railway. Pop. (1901) 9223. It is situated on the south bank of the Macquarie river, at an elevation of 2153 ft., in a fertile undulating plain on the west side of the Blue Mountains. Bathurst has broad streets, crossing one another at right angles, with a handsome park in the centre of the town, while many of the public buildings, specially the town hall, government buildings, and Anglican and Roman Catholic cathedrals, are noteworthy. Bathurst is the centre of the chief wheat-growing district of New South Wales, while gold, copper and silver are extensively mined in its vicinity. There are railway works, coach factories, tanneries, breweries, flour-mills and manufactures of boots and shoes and other commodities. The town was founded in 1815 by Governor Macquarie, taking its name from the 3rd Earl Bathurst, then secretary of state for the colonies, and it has been a municipality since 1862.

BATHVILLITE, a naturally occurring organic substance. It is an amorphous, opaque, and very friable material of fawn-brown colour, filling cavities in the torbanite or Boghead coal of Bathville, Scotland. It has a specific gravity of 1.01, and is insoluble in benzene.

BATHYBIUS (*Bathys*, deep, and *bios*, life), a slimy substance at one time supposed to exist in great masses in the depths of the ocean and to consist of undifferentiated protoplasm. Regarding it as an organism which represented the simplest form of life, Huxley about 1868 named it *Bathybium Haeckelii*. But investigations carried out in connexion with the "Challenger" expedition indicated that it was an artificial product, composed of a flocculent precipitate of gypsum thrown down from seawater by alcohol, and the hypothesis of its organic character was abandoned by most biologists, Huxley included.

BATHYCLES, an Ionian sculptor of Magnesia, was commissioned by the Spartans to make a marble throne for the statue of Apollo at Amyclae, about 550 B.C. Pausanias (iii, 18) gives us a detailed description of this monument, which is of the greatest value to us, showing the character of Ionic art at the time. It was adorned with scenes from mythology in relief and supporting figures in the round.

For a reconstruction, see Furtwängler, *Meisterwerke der griech. Plastik*, p. 706.

BATLEY, a municipal borough in the West Riding of Yorkshire, England, within the parliamentary borough of Dewsbury, 8 m. S.S.W. of Leeds, on the Great Northern, London & North Western, and Lancashire & Yorkshire railways. Pop. (1900) 30,321. Area 2030 acres. The church of All Saints is mainly perpendicular, and contains some fine woodwork, mostly of the 17th century, and some good memorial tombs. The market square contains an excellent group of modern buildings, including the town hall, public library, post office and others. The town is a centre of the heavy woollen trade, and has extensive manufactures of army cloths, pilot cloths, druggets, flushings, &c. The working up of old material as "shoddy" is largely carried on. There are also iron foundries, manufactures of machinery, and stone quarries. The town lies on the south-west Yorkshire coalfield, and there are a number of collieries in the district. The borough is governed by a mayor, six aldermen, and eighteen councillors.

BATON (Fr. *bâton*, *baston*, from Late Lat. *basto*, a stick or staff), the truncheon carried by a field marshal as a sign of authority, by a police constable, &c.; in music, the stick with which the conductor of an orchestra beats time; in heraldry, the fourth part of a bend, frequently broken off short at the ends so as to be shaped like a rod; in English coats of arms, only as a mark of illegitimacy, the "baton sinister."

BATONI, POMPEO GIROLAMO (1708-1787), Italian painter, was born at Lucca. He was regarded in Italy as a great painter in the 18th century, and unquestionably did much to rescue the art from the intense mannerism into which it had fallen during the preceding century. His paintings, however, are not of the highest order of merit, though they are generally graceful, well designed, and harmoniously coloured. His best production is

thought to be his group of "Peace and War." Batoni painted an unusual number of pictures, and was also celebrated for his portraits.

BATON ROUGE, the capital of Louisiana, U.S.A., and of East Baton Rouge parish, on the E. bank of the Mississippi river, about 70 m. N.W. of New Orleans. Pop. (1890) 10,478; (1900) 11,269, of whom 6560 were of negro descent; (1910 census) 14,807. It is served by the Yazoo & Mississippi Valley railway and by the Louisiana Railway & Navigation Company; and the Texas & Pacific enters Port Allen, just across the river. The city lies on the river bluff, secure against the highest floods. Old houses in the Spanish style give quaintness to its appearance. The state capitol was built in 1880-1882, replacing another burned in 1862. At Baton Rouge is the State University and Agricultural and Mechanical College (1860), of which the Audubon Sugar School, "for the highest scientific training in the growing of sugar cane and in the technology of sugar manufacture," is an important and distinctive feature. The university grew out of the Louisiana State Seminary of Learning and Military Academy, founded in 1855 near Alexandria and opened in 1860 under the charge of W. T. Sherman. In 1860 the institution was removed to Baton Rouge, and in 1877 it was united with the Agricultural and Mechanical College, established in 1873 and in 1874 opened at New Orleans. The campus of the university is the former barracks of the Baton Rouge garrison, occupied by the college since 1886 and transferred to it by the Federal government in 1902. The enrolment of the university in 1907-1908 was 636. Other important institutions at Baton Rouge are a State Agricultural Experiment Station, asylums and schools for the deaf and dumb, for the blind, and for orphans, and the state penitentiary. The surrounding bluff and alluvial country is very rich. Sugar and cotton plantations and subtropical fruit orchards occupy the front-lands on the river. The manufactures include lumber and cotton seed products, and sugar. The value of the city's factory products increased from \$717,368 in 1900 to \$1,383,061 in 1905 or 92.8%. The city is governed under a charter granted by the legislature in 1868. This charter is peculiar in that it gives to the city council the power to elect various administrative boards—of police, finance, &c.—from which the legislative council of most cities is separated.

Baton Rouge was one of the earliest French settlements in the state. As a part of West Florida, it passed into the hands of the British in 1763, and in 1779 was captured by Bernardo Galvez, the Spanish governor of Louisiana. The town was incorporated in 1817. In 1849 it was made the state capital, remaining so until 1862, when Shreveport became the Confederate state capital. In 1864 the Unionists made New Orleans the seat of government. The Secession Ordinance of Louisiana was passed on the 26th of January 1861 by a convention that met at Baton Rouge. On the 2nd of May 1862 the city was captured by the forces of the United States under Col. Benjamin H. Grierson (b. 1826), who had led raiders thither from Tennessee; on the 12th of May it was formally occupied by troops from New Orleans, and was successfully defended by Brig.-Gen. Thomas Williams (1815-1862) against an attack by Confederate forces under General John C. Breckinridge on the 5th of August 1862; Gen. Williams, however, was killed during the attack. Baton Rouge was soon abandoned for a month, was then reoccupied, and was held throughout the rest of the war. It became the state capital again in 1882, in accordance with the state constitution of 1879. For several years after 1840 Zachary Taylor made his home on a plantation near Baton Rouge.

BATRACHIA. The arguments adduced by T. H. Huxley, in his article on this subject in the ninth edition of the *Encyclopædia Britannica*, for applying the name *Amphibia* to those lung-breathing, pentadactyle vertebrates which had been first severed from the Linnaean *Amphibia* by Alexandre Brongniart, under the name of *Batrachia*, have not met with universal acceptance. Although much used in text-books and anatomical works in Great Britain and in Germany, the former name has been discarded in favour of the latter by the principal authors

on systematic herpetology, such as W. Peters, A. Günther and E. D. Cope, and their lead is followed in the present article. Bearing in mind that Linnaeus, in his use of the name Amphibia, was not alluding to the gill-breathing and air-breathing periods through which most frogs and newts pass in the course of their existence, but only wished to convey the fact that many of the constituents of the group resort to both land and water (e.g. crocodiles), it seems hard to admit that the term may be thus diverted from its original signification, especially when such a change results in discarding the name expressly proposed by Brongniart to denote the association which has ever since been universally adopted either as an order, a sub-class or a class. Many authors who have devoted special attention to questions of nomenclature therefore think *Reptilia* and *Batrachia* the correct names of the two great classes into which the Linnaean *Amphibia* have been divided, and consider that the latter term should be reserved for the use of those who, like that great authority, the late Professor Peters, down to the time of his death in 1883, would persist in regarding reptiles and batrachians as mere sub-classes (1). However extraordinary it may appear, especially to those who bring the living forms only into focus, that opposition should still be made to Huxley's primary division of the vertebrates other than mammals into *Sauropsida* (birds and reptiles) and *Ichthyopsida* (batrachians and fishes), it is certain that recent discoveries in palaeontology have reduced the gap between batrachians and reptiles to such a minimum as to cause the greatest embarrassment in the attempt to draw a satisfactory line of separation between the two; on the other hand the hiatus between fishes and batrachians remains as wide as it was at the time Huxley's article *Amphibia* (*Encyclopaedia Britannica*, 9th ed.) was written.

The chief character which distinguishes the Batrachians from the reptiles, leaving aside the metamorphoses, lies in the arrangement of the bones of the palate, where a large parasphenoid extends forwards as far or nearly as far as the vomers and widely separates the pterygoids. The bones which bear the two occipital condyles have given rise to much discussion, and the definition given by Huxley in the previous edition—"two occipital condyles, the basi-occipital region of the skull either very incompletely or not at all ossified"—requires revision. Some authors have held that the bone on which the occipital condyles have been found most developed in some labyrinthodonts (2) represents a large basi-occipital bearing two knobs for the articulation with the first vertebra, whilst the skull of the batrachians of the present day has lost the basi-occipital, and the condyles are furnished by the exoccipitals. On the other hand, some reptiles have the occipital condyle divided into two and produced either by the basi-occipital or by the exoccipitals. But the recent find of a well preserved skull of a labyrinthodont (*Capitosaurus stantonensis*) from the Trias of Staffordshire has enabled A. S. Woodward (3) to show that, in that form at any rate, the condyles are really exoccipital, although they are separated by a narrow basi-occipital. It is therefore very probable that the authors quoted in (2) were mistaken in their identification of the elements at the base of the foramen magnum. The fact remains, however, that some if not all of the stegocephalous batrachians have an ossified basi-occipital.

As a result of his researches on the anomodont reptiles and the Stegocephalia (4), as the extinct order that includes the well known labyrinthodonts is now called, we have had the proposal by H. G. Seeley (5) to place the latter with the reptiles instead of with the batrachians, and H. Gadow, in his most recent classification (6), places some of them among the reptiles, others being left with the batrachians; whilst H. Credner, basing his views on the discovery by him of various annectant forms between the Stegocephalia and the Rynchocephalian reptiles, has proposed a class, *Eotetrapoda*, to include these forms, ancestors of the batrachians proper on the one hand, of the reptiles proper on the other. Yet, that the Stegocephalia, notwithstanding their great affinity to the reptiles, ought to be included in the batrachians as commonly understood, seems sufficiently obvious from the mere fact of their passing through

a branchiate condition, i.e. undergoing metamorphosis (7). The outcome of our present knowledge points to the Stegocephalia, probably themselves derived from the Crossopterygian fishes (8), having yielded on the one hand the true batrachians (retrogressive series), with which they are to a certain extent connected through the *Caudata* and the *Apoda*, on the other hand the reptiles (progressive series), through the Rynchocephalians and the Anomodonts, the latter being believed, on very suggestive evidence, to lead to the mammals (9).

The division of the class Amphibia or Batrachia into four orders, as carried out by Huxley, is maintained, with, however, a change of names: *Stegocephalia*, for the assemblage of minor groups that cluster round the *Labyrinthodonta* of R. Owen, which name is restricted to the forms for which it was originally intended; *Peromela*, *Urodela*, *Anura*, are changed to *Apoda*, *Caudata*, *Ecaudata*, for the reason that (unless obviously misleading, which is not the case in the present instance) the first proposed name should supersede all others for higher groups as well as for genera and species, and the latter set have the benefit of the law of priority. In the first subdivision of the batrachians into two families by C. Duméril in 1806 (*Zool. Anal.* pp. 90-94) these are termed "Anoures" and "Urodeles" in French, *Ecaudati* and *Caudati* in Latin. When Duméril's pupil, M. Oepel, in 1811 (*Ordn. Rept. p. 72*), added the Caecilians, he named the three groups *Apoda*, *Jugal*, *Ecaudata* and *Caudata*. The Latin form being the only one entitled to recognition

in zoological nomenclature, it follows that the last-mentioned names should be adopted for the three orders into which recent batrachians are divided.

I. STEGOCEPHALIA (10).—Tailed, lacertiform or serpentiform batrachians, with the temporal region of the skull roofed over by postorbital, squamosal, and supratemporal plates similar to the same bones in Crossopterygian fishes, and likewise with paired dermal bones (occipitals and post-temporals) behind the parietals and supratemporals. A parietal foramen; scales or bony scutes frequently present, especially on the ventral region, which is further protected by three large bony plates—interclavicle and clavicles, the latter in addition to cleithra.

Extinct, ranging from the Upper Devonian to the Trias. Our knowledge of Devonian forms is still extremely meagre, the only certain proof of the existence of pentadactyl vertebrates at that period resting on the footprints discovered in Pennsylvania and described by Ö. C. Marsh (11) as *Tinopus antiquus*. Sundry remains from Belgium, as to the identification of which doubts are still entertained, have been regarded by M. Lohest (12) as evidence of these batrachians in the Devonian. Over 200 species are now distinguished from the Carboniferous of Europe and North America, the Permian of Spitsbergen, Europe, North America and South Africa, and the Trias of Europe, America, South Africa, India and Australia. The forms of batrachians with which we are acquainted show the vertebral column to have been evolved in the course of time from a notochordal condition with segmented centra similar to that of early bony ganoid fishes (e.g. *Caturus*, *Eurycormus*), to biconcave centra, and finally to the socket-and-ball condition that prevails at the present day. However, owing to the evolution of the vertebral column in various directions, and to the inconstant state of things in certain annectant groups, it is not possible, it seems, to apply the vertebral characters to taxonomy with that rigidity which E. D. Cope and some other recent authors have attempted to enforce.

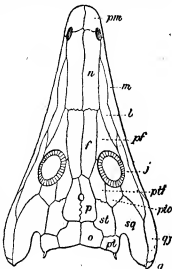

FIG. 1.—Upper view of *Archeogyrinus Decheni*. (Outlines after Credner.)

pm, Praemaxilla. st, Supratemporal.
n, Nasal. p, Parietal.
m, Maxilla. sq, Squamosal.
l, Lachrymal. pt, Postorbital.
p, Praefrontal. g, Quadrato-jugal.
st, Frontal. o, Occipital.
sq, Jugal. p, Postfrontal. pt, Post-temporal.
p, Parietal. g, Quadrate.

This is particularly evident in the case of the Stegocephalians; and recent batrachians, tailed and tailless, show the mode of articulation of the vertebrae, whether amphicoelous, opisthocelous or procoelous, to be of but secondary systematic importance in dealing with these lowly vertebrates. The following division of the Stegocephalians into five sub-orders is therefore open to serious criticism; but it seems on the whole the most natural to adopt in the light of our present knowledge.

A. Rhachitomi, (figs. 1, 2), in which the spinal cord rests on the notochord, which persists uninterrupted and is surrounded by three bony elements in addition to the neural arch: a so-called pleurocentrum on each side, which appears to represent the centrum proper of reptiles and mammals, and an intercentrum or hypocentrum below, which may extend to the neural arch, and probably answers to the hypapophysis, as it is produced into chevrons in the caudal region. Mostly large forms, of Carboniferous and Permian age, with a more or less complete infolding of the walls of the teeth. Families: ARCHEOSAURIDAE, ERYPIDAE, TRIMERORHACHIDAE, DISSORHOPIIDAE. The last is remarkable for an extraordinary endo- and exo-skeletal carapace, *Dissorhophus* being described by Cope (13) as a "batrachian armadillo."

B. Embolomeri, with the centra and intercentra equally developed disks, of which there are thus two to each neural arch; these disks perforated in the middle for the passage of the notochord. This type may be directly derived from the preceding, with which it appears to be connected by the genus *Diplospondylus*. Fam.: CRICOTIDAE, Permian.

C. Labyrinthodontia, with simple biconcave vertebral disks, very slightly pierced by a remnant of the notochord and supporting the loosely articulated neural arch. This condition is derived from

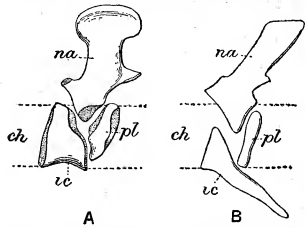

FIG. 2.—A, Dorsal vertebrae. B, Caudal vertebra of *Archegosaurus*. na, Neural arch; ch, chorda; pl, pleurocentrum; ic, intercentrum.

(Outline after Jaekel.)

that of the *Rhachitomi*, as shown by the structure of the vertebral column in young specimens. Mostly large forms from the Trias (a few Permian), with true labyrinthine dentition. Families: LABYRINTHODONTIDAE, ANTHRACOSAURIDAE, DENDROPHETIDAE, NYRANIIDAE.

D. Microsauria, nearest the reptiles, with persistent notochord completely surrounded by constricted cylinders on which the neural arch rests. Teeth hollow, with simple or only slightly folded walls. Mostly of small size and abundant in the Carboniferous and Lower Permian. Families: UROCORYLIDAE, LIMNERPETIDAE, HYLOMOMIDAE (fig. 3), MICROBRACHIDAE, DOLICHOSOMATIDAE; the latter serpentiform, apodal.

E. Branchiosa, nearest to the true batrachians; with persistent non-constricted notochord, surrounded by barrel-shaped, bony cylinders formed by the neural arch above and a pair of intercentra below, both these elements taking an equal share in the formation of a transverse process on each side for the support of the rib. This plan of structure, apparently evolved out of the rhachitomous type by suppression of the pleurocentra and the downward extension of the neural arch, leads to that characteristic of frogs in which, as development shows, the vertebra is formed wholly or for the greater part by the neural arch (14). Small forms from the Upper Carboniferous and Permian formations. A single family: BRANCHIOSAURIDAE.

II. APODA (15).—No limbs. Tail vestigial or absent. Frontal bones distinct from parietals; palatines fused with maxillaries. Male with an intromittent copulatory organ. Degraded, worm-like batrachians of still obscure affinities, inhabiting tropical Africa, south-eastern Asia and tropical America. Thirty-three species are known. No fossils have yet been discovered. It has been attempted of late to do away with this order altogether and to make the Caecilians merely a family of the Urodeles. This view has originated

out of the very remarkable superficial resemblance between the *Ichthyophis*-larva and the *Amphiuma*. Cope (16) regarded the Apoda as the extremes of a line of degeneration from the Salamanders, with *Amphiuma* as one of the annectant forms. In the opinion of P. and F. Sarasin (17), whose great work on the development of *Ichthyophis*

is one of the most important recent contributions to our knowledge of the batrachians, *Amphiuma* is a sort of neonetic Caecilian, a larval form made sexually mature while retaining the branchial respiration. If the absence of limbs and the reduction of the tail were the only characteristic of the group, there would be, of course, no objection to unite the Caecilians with the Urodeles; but, to say nothing of the scales, present in many genera of Apodals and absent in all Caudates, which have been shown by H. Credner to be identical in structure with those of Stegocephalians, the Caecilian skull presents features which are not shared by any of the tailed batrachians. G. M. Winslow (18), who has made a study of the chondrocranium of *Ichthyophis*, concludes that its condition could not have been derived from a Urodele form, but points to some more primitive ancestor. That this ancestor was nearly related to, if not one of, the Stegocephalians, future discovery will in all probability show.

III. CAUDATA (19).—Tailed batrachians, with the frontals distinct from the parietals and the palatines from the maxillary. Some of the forms breathe by gills throughout their existence, and were formerly regarded as establishing a passage from the fishes to the air-breathing batrachians. They are now considered as arrested larvae descended from the latter. One of the most startling discoveries of the decade 1890-1900 was the fact that a number of forms are devoid of both gills and lungs, and breathe merely by the skin and the buccal respiratory membrane (20). Three blind cave-forms are known: one terrestrial—*Typhlotriton*, from North America, and two perennibranchiate—*Proteus* in Europe and *Typhlomolge* in North America.

This order contains about 150 species, referred to five families: HYLAOBATRACHIDAE, SALAMANDRIDAE, AMPHIUMIDAE, PROTEIDAE, SIRENIDAE.

Fossil remains are few in the Upper Eocene and Miocene of Europe and the Upper Cretaceous of North America. The oldest Urodele known is *Hylaeobatrachus* Dollo (21) from the Lower Wealden of Belgium. At present this order is confined to the northern hemisphere, with the exception of *Proteus* from the Andes of Ecuador and Peru, and a *Plethodon* from Argentina.

IV. ECAUDATA (22).—Frogs and toads. Four limbs and no tail. Radius confluent with ulna, and tibia with fibula; tarsus (astragalus and calcaneum) elongate, forming an additional segment in the hind limb. Caudal vertebrae fused into a urostyle or coccyx. Frontal bones confluent with parietals.

This order embraces about 1300 species, of which some 49 are fossil, divided into two sub-orders and sixteen families:—

A. Aglossa.—Eustachian tubes united into a single ostium pharyngeum; no tongue. DACTYLETRIDAE, PEPIDAE.

B. Phanoglossa.—Eustachian tubes separated; tongue present. DISCOGLOSSIDAE, PELOBATIDAE, HEMIPHRYNIDAE, AMPHI-GNATHODONTIDAE, HYLIDAE, BUFONIDAE, DENDROPHRYNIDAE, CYSTIGNATHIDAE, DYSCOPIDAE, GENYOPHYRIDAE, ENGYSTOMATIDAE, CERATOBATRACHIDAE, RANIDAE, DENDROBATIDAE.

The Phanoglossa are divided into two groups; *Arctifera* and *Firmisternia*, representing two stages of evolution. The family characters are mainly derived from the dilatation or non-dilatation of the sacral diapophyses, and the presence of teeth in one or both jaws, or their absence. In the *Aglossa* genera are noteworthy for the presence of short ribs to the somites of the vertebrae, and in some other points also they approach the tailed batrachians; they may be safely regarded as, on the whole, the most generalized of known Ecaudata. Distinct ribs are present at an early age in the *Aglossa*, as discovered by W. G. Ridewood (23). The recent addition of a third genus of *Aglossa*, *Hymenochirus* (24) from tropical Africa, combining characters of *Pipa* and *Xenopus*, has removed every doubt as to the real affinity which connects these genera. *Hymenochirus* is further remarkable for the presence of only six distinct pieces in the vertebral

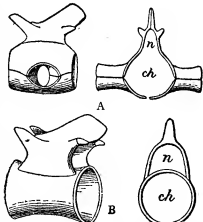

FIG. 3.—A, Dorsal vertebra of *Hylonomus* (side view and front view). B, Dorsal vertebra of *Branchiosaurus* (side view and front view). n, Neural canal; ch, chorda. (After Credner.)

column, which is thus the most abbreviated among all the vertebrae.

Frogs and toads occur wherever insect food is procurable, and their distribution is a world-wide one, with the exception of many islands. Thus New Caledonia, which has a rich and quite special lizard-fauna, has no batrachians of its own, although the Australian *Hyla aurea* has been introduced with success. New Zealand possesses only one species (*Liopelta hochstetteri*), which appears to be rare and restricted to the North Island. The forest regions of southern Asia, Africa and South America are particularly rich in species.

According to our present knowledge, the Ecaudata can be traced about as far back in time as the Caudata. An unmistakable batrachian of this order, referred by its describer to *Palaeobatrachus*, a determination which is only provisional, has been discovered in the Kimmeridgian of the Sierra del Montsec, Catalonia (25), in a therefore somewhat older formation than the Wealden Caudata *Hylaobatrachus*.

Apart from a few unsatisfactory remains from the Eocene of Wyoming, fossil tailless batrachians are otherwise only known from the Oligocene, Miocene and Pliocene of Europe and India. These forms differ very little from those that live at the present day in the same part of the world, and some of the genera (*Discoglossus*, *Bufo*, *Oxyglossus*, *Rana*) are even identical. *Palaeobatrachus* (26), of which a number of species represented by skeletons of the perfect form and of the tadpole have been described from Miocene beds in Germany, Bohemia and France, seems to be referable to the *Pelobatidae*; this genus has been considered as possibly one of the *Aglossa*, but the absence of ribs in the larvae speaks against such an association.

Numerous additions have been made to our knowledge of the development and nursing habits, which are extremely varied, some forms dispensing with or hurrying through the metamorphoses and hopping out of the egg in the perfect condition (27).

Skeleton.—In the earliest forms of this order, the Stegocephalia, we meet with considerable variety in the constitution of the vertebrae, and these modifications have been used for their classification. All agree, however, in having each vertebra formed of at least two pieces, the suture between which persists throughout life. In this they differ from the three orders which have living representatives. Even the inferior arches or chevrons of the tail of salamanders are continuously ossified with the centra. As a matter of fact, these vertebrae have no centra proper, that part which should correspond with the centrum being formed, as a study of the development has shown (H. Gadow, 14), by the meeting and subsequent complete co-ossification of the two chief dorsal and ventral pairs of elements (tail-vertebrae of Caudata), or entirely by the pair of dorsal elements. In the Ecaudata, the vertebrae of the trunk are formed on two different plans. In some the notochord remains for a long time exposed along the ventral surface, and, owing to the absence of cartilaginous formation around it, disappears without ever becoming invested otherwise than by a thin elastic membrane; it can be easily stripped off below the vertebrae in larval specimens on the point of metamorphosing. This has been termed the *epichordal* type. In others, which represent the *perichordal* type, the greater share of the formation of the whole vertebra falls to the (paired) dorsal cartilage, but there is in addition a narrow ventral or hypochordal cartilage which fuses with the dorsal or becomes connected with it by calcified tissue; the notochord is thus completely surrounded by a thick sheath in tadpoles with imperfectly developed limbs. This mode of formation of both the arch and the greater part or whole of the so-called centrum from the same cartilage explains why there is never a neuro-central suture in these batrachians.

During segmentation of the dorsal cartilages mentioned above, which send out the transverse processes of diapophyses, there appears between each two centra an intervertebral cartilage, out of which the articulating condyle of the centrum is formed, and becomes attached

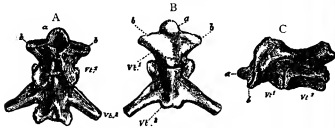

FIG. 4.—The first two vertebrae of *Necturus*. *V1*, Atlas; *V2*, second vertebra; *a*, intercondylar process of the atlas; *b*, the articular surfaces for the occipital condyles. The ribs of the second vertebra are not represented. A, Dorsal; B, ventral; C, lateral view.

either to the vertebra anterior (procœlous type) or posterior (opisthocœlous type) to it, if not remaining as an independent, intervertebral, ossified sphere, as we sometimes find in specimens of *Pelobatidae*.

In the Caudata and Apoda, cartilage often persists between the vertebrae; this cartilage may become imperfectly separated into a cup-and-ball portion, the cup belonging to the posterior end of the vertebra. In such cases the distinction between amphicoelous and opisthocœlous vertebrae rests merely on a question of ossi-

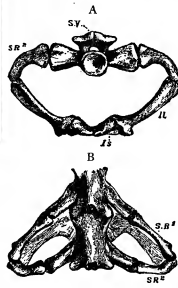

FIG. 5.—*Necturus*. Posterior (A) and ventral (B) views of the sacral vertebrae (S.V.); S.R., S.R., sacral ribs; Il., ilium; Is., ischium.

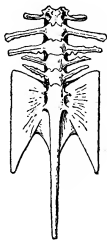

FIG. 6.—Vertebral column of *Hymenochirus* (ventral view).

fication, and has occasionally given rise to misunderstandings in the use of these terms.

Amphicoelous (bi-concave) vertebrae are found in the Apoda and in some of the Caudata; opisthocœlous (convex-concave) vertebrae in the higher Caudata and in the lower Ecaudata; whilst the great majority of the Ecaudata have procœlous (concavo-convex) vertebrae.

All living batrachians, and some of the Stegocephalia, have transverse processes on the vertebrae that succeed the atlas (fig. 4), some of which, in the Caudata, are divided into a dorsal and a ventral portion. Ribs are present in the lower Ecaudata (*Discoglossidae* and larval *Aglossa*), but they are never connected with a sternum. It is in fact doubtful whether the so-called sternum of batrachians, in most cases a mere plate of cartilage, has been correctly identified as such. When limbs are present, one vertebra, rarely two (fig. 5) or three, are distinguished as sacral, giving attachment to the ilia. In the Ecaudata, the form of the transverse processes of the sacral vertebra varies very considerably, and has afforded important characters to the systematist. In accordance with the saltatorial habits of the members of this order, the vertebrae, which number from 40 to 60 in the Caudata, to upwards of 200 in the Apoda, have become reduced to 10 as the normal number, viz., eight praecaudal, one sacral and an elongate coccyx or urostyle, formed by coalescence of at least two vertebrae. In some genera this coccyx is fused with the ninth vertebra, and contributes to the

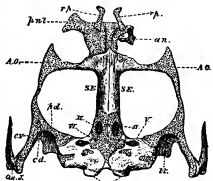

FIG. 7.—Chondrocranium of *Rana esculenta*—ventral aspect.

- r.p.*, The rhinal process.
- p.n.*, The prenasal process.
- an.*, The altrinal processes, shown by the removal of part of the floor of the left nasal chamber.
- A.O.*, The antorbital process.
- pd.*, The pedicle of the suspensorium continued into *ce.*, the ventral crus of the suspensorium.
- cd.*, Its dorsal crus.
- th.*, The tegmen tympani.
- st.*, The sphen-ethmoid.
- EO.*, The exoccipitals.
- Qu.J.*, The quadrate jugal.
- II. V. VI.* Foramina by which the optic, trigeminal and portio dura, and abducens nerves leave the skull.

eight praecaudal, one sacral and an elongate coccyx or urostyle, formed by coalescence of at least two vertebrae. In some genera this coccyx is fused with the ninth vertebra, and contributes to the

sacrum, whilst in a few others the number of segments is still further reduced by the co-ossification of one or two vertebrae preceding that corresponding to the normal sacral and by the fusion of the two first vertebrae, the extreme of reduction being found in

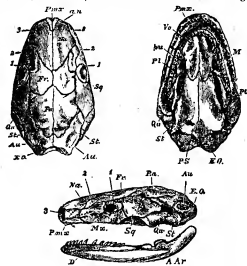

FIG. 8.—The skull of *Ichthyophis glutinosus*. A, Dorsal; B, ventral; C, lateral view. The letters have the same signification as below.

the genus *Hymenochirus*, the vertebral column of which is figured here (fig. 6.)

As stated above in the definition of the order, the Stegocephalia have retained most of the cranial bones which are to be found in the Crossopterygian fishes, and it is worthy of note that the bones termed post-temporals may give attachment to a further bone so prolonged backwards as to suggest the probability of the skull being connected with the shoulder-girdle, as in most teleostome fishes. This supposition is supported by a specimen from the Lower Permian of Aurtun, determined as *Actinodon frossardi*, acquired in 1902 by the British Museum, which shows a bone, similar to the so-called "epiotic cornu" of the microsaurians, *Ceraterpeton* and *Scimosaurus*, to have the relations of the supra-cleithrum of fishes, thus confirming a suggestion made by C. W. Andrews (28). As in fishes also, the sensory canal system must have been highly developed on the skulls of many labyrinthodonts, and the impressions left by these canals have been utilized by morphologists for homologizing the various elements of the cranial roof with those of Crossopterygians. The pineal foramen, in the parietal bones, is as constantly present as it is absent in the other orders. Although not strictly forming part of the skull, allusion should be made here to the ring of sclerotic plates which has been found in many of the Stegocephalia, and which is only found elsewhere in a few Crossopterygian fishes as well as in many reptiles and birds.

In the orders which are still represented at the present day, the bones of the skull are reduced in number and the "primordial skull," or chondrocranium (fig. 7), remains to a greater or less extent unossified, even in the adult. Huxley's figures of the skull of a caecilian (*Ichthyophis glutinosus*), fig. 8, of a perennibranchiate urodele (*Necturus maculosus* = *Menobanchus lateralis*), fig. 9, and of a frog (*Rana sacculenta*), fig. 10, are here given for comparison.

The skull, in the *A. glutinosus*, is remarkably solid and compact, and it possesses a postorbital or postfrontal bone (marked 1 in the figure) which does not exist in any of the other living batrachians. The squamosal bone is large and either in contact with the frontals and parietals or separated from them by a vacuity; the orbit is sometimes roofed over by bone. The presence, in some genera, of a second row of mandibular teeth seems to indicate the former existence of a splenial element, such as exists in *Siren* among the Caudata and apparently in the labyrinthodonts.

In the Caudata, the frontals remain likewise distinct from the parietals, whilst in the Eucaudata the two elements are fused into one, and in a few forms (Aglossa, some *Pelobatidae*) the paired condition of these bones has disappeared in the adult. Prefrontal bones are present in the *Salamandridae* and *Amphiumidae*, but absent (or fused with the nasals) in the other Caudata and in the Eucaudata. In most of the former the palatines fuse with the vomers, whilst they remain distinct, unless entirely lost, in the latter. The vomer is single, or absent, in the Aglossa. In the lower jaw of most of the Eucaudata the symphyseal cartilages ossify separately from the dentary bones, forming the so-called mento-meckelian bones; but these symphyseal bones, so distinct in the frog, are less so in the *Hyliidae* and *Engonidae*, almost indistinguishable in the *Pelobatidae* and *Discoplossidae*, whilst in the Aglossa they do not exist any more than in the other orders of batrachians.

No batrachian is known to possess an ossified azygous supra-occipital.

Although there are four branchial arches in all the larval forms of the three orders, and throughout life in the *Sirenidae*, the perenni-

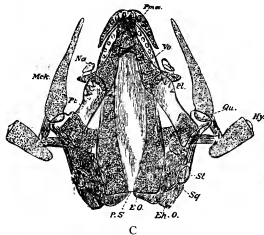
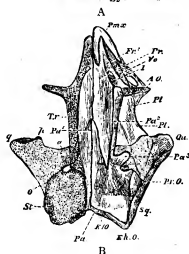
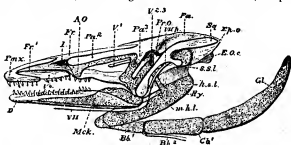

FIG. 9.—Lateral, dorsal and ventral views of the cranium of *Necturus maculosus*. In the dorsal view, the bones are removed from the left half of the skull; in the ventral view, the parasphenoid, palato-pterygoid, and vomers are given in outline. The letters have, for the most part, the same signification as before.

- VII.p, Posterior division of the seventh nerve.
- VII. Chorda tympani.
- V¹, V², V³, First, second and third divisions of the trigeminal.
- s.s.l., Stapedio-suspensorial ligament.
- h.s.l., Hyo-suspensorial ligament.
- m.h.l., Mandibulo-hyoid ligament.
- a, Ascending process of the suspensorium.
- p, Pterygo-palatine process.
- q, Quadrate process.
- o, Otic process.
- Na, Posterior nares.
- Meck, Meckel's cartilage.
- Gl, Guttis.
- B^D, B^B, Basilbranchials.

branchiate *Proteidae* have only three (see fig. 11). In the adult *Apoda* these arches and the hyoid fuse into three transverse, curved or angular bones (see fig. 13), the two posterior disconnected from the hyoid. In the Eucaudata, as shown by E. Gaupp (29) and by W. G. Ridewood (30), the whole hyobranchial apparatus forms a cartilaginous continuum, and during metamorphosis the branchialia disappear without a trace. The hyoid of the adult frog (fig. 12)

consists of a plate of cartilage with two slender cornua, three processes on each side, and two long bony rods behind, termed the thyro-hyals, which embrace the larynx.

In the Aglossa, which are remarkable for the large size and complexity of the larynx, the thyro-hyal bones are incorporated into the laryngeal apparatus, whilst the recently discovered *Hymenochirus* is further remarkable for the large size and ossification of the hyoidean cornua (ceratohyals), a feature which, though not uncommon among the salamanders, is unique among the Ecaudata (31).

The pectoral girdle of the Stegocephalia is, of course, only known from the ossified elements, the identification of which has given rise to some diversity of opinion. But C. Gegenbaur's (32) interpretation may be regarded as final. As has been shown that, in the Crossopterygian and Chondrosteian ganoid fishes, there are two clavicular elements on each side; the lower corresponds to the clavicle of reptiles and higher vertebrates, whilst the upper corresponds to the clavicle of teleostean fishes, and has been named by him "cleithrum." As stated above, there is strong evidence in favour of the view that some forms at least possessed in addition a "supracleithrum," corresponding to the supra-clavicle of bony fishes. The element often termed "coracoid" in these fossils should be the scapula. The clavicles rest on a large discoidal, rhomboidal, or T-shaped median bone, which clearly corresponds to the interclavicle of reptiles.

The pectoral girdle of the living types of batrachians is distinguishable into a scapular, a coracoidal, and a praecoracoidal region. In most of the Caudata the scapular region alone ossifies, but in the Ecaudata the coracoid is bony and a clavicle is frequently developed over the praecoracoid cartilage. In batrachians the pectoral arch falls into two distinct types—the *arctiferous*, in which the widely separated from each other distally and connected by an arched cartilage (the epicoracoid), the right usually overlapping the left; and the *firmi-*

sternal, in which both praecoracoid and coracoid nearly abut on the median line, and are only narrowly separated by the more or less fused epicoracoids. The former type is exemplified by the toads and the lower Ecaudata, whilst the latter is characteristic of the true frogs (*Ranidae*), although when quite young these batrachians present a condition similar to that which persists throughout life in their lower relatives. A cartilage in the median line in front of the praecoracoids, sometimes supported by a bony style, is the so-called *omosternum*; a large one behind the coracoids, also sometimes provided with a bony style, has been called the sternum. But these names will probably have to be changed when the homologies of these parts are better understood.

The pelvic arch of some of the Stegocephalia contained a well ossified pubic element, whilst in all other batrachians only the ilium, or the ilium and the ischium are ossified. In the Ecaudata the ilium is greatly elongated and the pubis and ischium are flattened, discoidal, and closely applied to their fellows by their inner surfaces; the pelvic girdle looks like a pair of tongs.

The long bones of the limbs consist of an axis of cartilage; the extremities of the cartilages frequently undergo calcification and are thus converted into epiphyses. In the Ecaudata the radius and ulna coalesce into one bone. The carpus, which remains cartilaginous in many of the Stegocephalia and Caudata, contains six to eight elements when the manus is fully developed, whilst the number is reduced in those forms which have only two or three digits. Except in some of the Stegocephalia, there are only four functional digits in the manus, but the Ecaudata have a more or less distinct rudiment of pollex; in the Caudata it seems to be the outer digit which has been suppressed, and its atavistic reappearance of a fifth digit takes place on the outer side of the manus, as it does on the toes in those forms in which the toes are reduced to four. The usual number of phalanges is 2, 2, 3, 2 in the Stegocephalia and Caudata, 2, 2, 3, 3 in the Ecaudata. In the foot the digits usually number five, and the phalanges 2, 2, 3, 3, 2 in the Caudata, 2, 2, 3, 4, 3 in the Stegocephalia and Ecaudata. There are occasionally intercalary ossifications between the two distal phalanges (33). There are usually nine tarsal elements in the Caudata; this number is reduced in the Ecaudata, in which the two bones of the proximal row (sometimes coalesced) are much elongated and form an additional segment to the greatly lengthened hind-limb, a sort of *crus secundarium*. In the Ecaudata also, the tibia and fibula coalesce into one bone, and two or three small bones on the inner side of the tarsus form what has been regarded as a rudimentary digit or "prehallux."

Integument.—In all recent batrachians, the skin is naked, or if small scales are present, as in many of the Apoda, they are concealed in the skin. The extinct Stegocephalia, on the other hand, were mostly protected, on the ventral surface at least, by an armour of overlapping round, oval, or rhomboidal scales, often very similar to those of Crossopterygian or ganoid fishes, and likewise disposed in transverse oblique lines converging forwards on the middle line of the belly. Sometimes these scales assumed the importance of scutes and formed a carapace, as in the "batrachian armadillo" discovered by E. D. Cope. A few frogs have the skin of the back studded with stellate bony deposits (*Phyllomedusa*, *Notolema*), whilst two genera are remarkable for possessing a bony dorsal shield, free from the vertebrae (*Ceratophrys* or *ankylosed* to them (*Brachycephalus*). None of the Stegocephalia appears to have been provided with scales, but some living batrachians (*Onychodactylus*, *Xenopus*, *Hymenochirus*) have the tips of some or all of the digits protected by a claw-like horny sheath.

The integument of tailed and tailless batrachians is remarkable for the great abundance of follicular glands, of which there may be two kinds, each having a special secretion, which is always more or less acrid and irritating, and affords a means of defence against the attacks of many carnivorous animals. A great deal has been

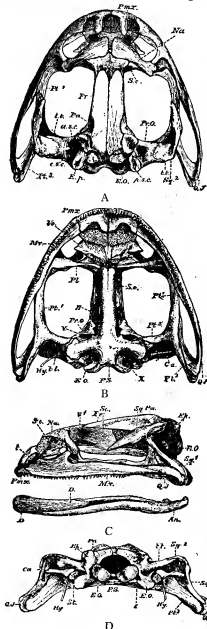

FIG. 10.—Dorsal, ventral, lateral and posterior views of the skull of *Rana esculenta*. The letters have the same signification throughout.

Pmx, Premaxilla. Hy, Hyoidean cornu
Mx, Maxilla. P.S, Parasphenoid.
Vo, Vomer. An, Angulare.
Na, Nasal. Dn, Dentale.
S.e, Sphen-ethmoid. V, Foramen of exit
Fr, Frontal. Tr, Of the trigeminal.
Pa, Parietal. V, Of the optic.
E.O, Exoccipital. H, Of the optic.
Ep, Epitotic process. X, Of the pneumogastric and glosso-pharyngeal nerves.
Pr.O, Pro-otic.
t.t, Tegmentum tympani.
Sq, Squamosal.
Q.J, Quadrato-jugal. V, Foramen by which the orbito-nasal or first division of the fifth passes to the nasal cavity.
Pp, Pterygoid, anterior process.
Pp, Internal process.
Pp, Posterior or external process.
Ca, Columella auris.
St, Stapes.

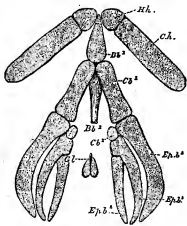

FIG. 11.—Hyooid and branchial apparatus of *Necturus maculosus*.

Hh, Hypo-hyal. Ep.b.¹, Ep.b.², Ep.b.³, Ch, Cerato-hyal. Bb.¹, Bb.², Bb.³, First, second and third epibranchials. Bb.², Ossified second Gl, Glottis. Bb.³, basibranchial.

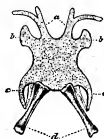

FIG. 12.—Ventral view of the hyoid of *Rana esculenta*. a, Anterior; b, lateral; c, posterior processes; d, thyrohyals.

published on the poisonous secretion of batrachians (34), which is utilized by the Indians of South America for poisoning their arrows. Some of the poison-secreting glands attain a greater complication of structure and are remarkable for their large size, such as the so-called "parotoid" glands on the back of the head in toads and salamanders.

In all larval forms, in the Caudata, and in a few of the Ecaudata (*Xenopus*, for instance), the epidermis becomes modified in relation with the termination of sensory nerves, and gives rise to organs of the same nature as those of the lateral line of fishes. In addition to diffuse pigment (mostly in the epidermis), the skin contains granular pigment stored up in cells, the chromatophores, restricted to the cutis, which are highly mobile and send out branches which, by contraction and expansion, may rapidly alter the coloration, most batrachians being in this respect quite comparable to the famous chameleons. Besides white (granule) cells, the pigment includes black, brown, yellow and red. The green and blue so frequent in frogs and newts, are merely subjective colours, due to interference. On the mechanism of the change of colour, cf. W. Biedermann (35).

One of the interesting recent discoveries is that of the "hairy" frog (*Trichobatrachus*), in which the sides of the body and limbs are covered with long villosities, the function of which is still unknown (36).

The nuptial horny asperities with which the males of many batrachians are provided, for the purpose of clinging to the females, will be noticed below, under the heading *Fairing and Oviposition*.

Dentition.—In the Microsauria and Branchiosauria among the Stegocephalia, as in the other orders, the hollow, conical or slightly curved teeth exhibit simple or only slightly folded walls. But in the Labyrinthodonta, grooves are more or less marked along the teeth and give rise to folds of the wall which, extending inwards and ramifying, produce the complicated structure, exhibited by transverse sections, whence these batrachians derive their name. A somewhat similar complexity of structure is known in some holopterychian (dendrodont) Crossospermian fishes. In the remarkable salamander *Autodax*, the teeth in the jaws are compressed, sharp-edged, lancet shaped. The teeth are not implanted in sockets, but become ankylized with the bones that bear them, and are replaced by others developed at their bases. Teeth are present in the jaws of all known Stegocephalia and Apoda and of nearly all Caudata, *Siren* excepted, unless presenting plates of horn upon the gingival surfaces of the premaxilla and of the dentary elements of the mandible. But they are nearly always absent in the lower jaw of the Ecaudata (exceptions in *Hemiphractus*, *Amphispnathodon*, *Amphodus*, *Ceratobatrachus*, the male of *Dimorphognathus*), many of which (toads, for instance) are entirely edentulous.

There is great variety in the distribution of the teeth on the palate. They may occur simultaneously on the vomers, the palatines and the pterygoids and the parasphenoid in some of the Stegocephalia (*Dawsonia*, *Sirenia*, *Acanthostoma*), on the vomers, palatines and parasphenoid in many salamanders (*Plethodontinae* and *Desmognathinae*), on the vomers, pterygoids and parasphenoid (some *Pelobates*), on the vomers and parasphenoid (*Triprion*, *Amphodus*), whilst in the majority of other batrachians they are confined to the vomers and palatines or to the vomers alone (37).

As regards the alimentary organs, it will suffice to state, in this very brief sketch, that, as the bifurcation being carnivorous in their perfect condition, the intestine is never very long and its convolutions are few and simple. But the larvae of the Ecaudata are mainly herbivorous and the digestive tract is accordingly extremely elongate and coiled up like the spring of a watch. The gullet is short, except in the Apoda. The tongue is rudimentary in the perennibranchiate Caudata, well developed, and often protrusile, in the *Salamandridae* and most of the Ecaudata, totally absent in the Aglossa.

The organs of circulation cannot be dealt with here; the most important addition made to our knowledge in recent years being found in the contributions of F. Hochstetter (38) and of G. B. Howes (39), dealing with the azygous (posterior) cardinal veins in salamanders and some of the Ecaudata. The heart is situated quite forward, in the gular or pectoral region, even in those tailed batrachians which have a serpentiform body, whilst in the Apoda (fig. 13) it is moved back to a distance which is comparable to that it occupies in most of the snakes.

The Respiratory Organs.—The larynx, which is rudimentary in most of the Caudata and in the Apoda, is highly developed in the Ecaudata, and becomes the instrument of the powerful voice with which many of the frogs and toads are provided. The lungs are long simple tubes in some of the perennibranchiate Caudata; they generally shorten or become cellular in the salamanders, and attain their highest development in the Ecaudata, especially in such forms as the burrowing *Pelobates*. Although the lungs are present in such forms as preserve the gills throughout life, it is highly remarkable that quite a number of amphibian salamanders, belonging mostly to the subfamilies *Desmognathinae* and *Plethodontinae*, are devoid of lungs and breathe entirely by the skin and by the bucco-pharyngeal mucose membrane (20). Some of the *Salamandridae* show the intermediate condition which has led to the suppression of the tracheas and lungs. In the Apoda, as in many serpentine reptiles, one of the lungs, either the right or the left, is much less developed than the other, often very short.

Urina-ventral Organs.—The genital glands, ovaries and testes, are attached to the dorsal wall of the body-cavity, in the immediate vicinity of the kidneys, with which the male glands are intimately connected. The oviducts are long, usually more or less convoluted tubes which open posteriorly into the cloaca, while their anterior aperture is situated far forward, sometimes close to the root of the lung; their walls secrete a gelatinous substance which invests the ova as they descend. In most male batrachians the testes are drained by transverse canals which open into a longitudinal duct, which also receives the canals of the kidneys, so that this common duct conveys both sperm and urine. In some of the discoglossid frogs, however, the seminal duct is quite independent of the kidney, which has its own canal, or true ureter. Many of the Ecaudata have remnants of oviducts, or Müllerian ducts, most developed in *Bufo*, which genus is also remarkable as possessing a problematic organ, Bidder's organ, situated between the testis and the adipose or fat-bodies that surmount it. This has been regarded by some anatomists as a rudimentary ovary. Female salamanders are provided with a *receptaculum seminis*. Copulatory organs are absent, except in the Apoda, in which a portion of the cloaca can be everted and acts as a penis. The urinary bladder is always large.

The spermatozoa have received a great share of attention, on the part not only of anatomists and physiologists, but even of systematic workers (40). This is due to the great amount of difference in structure and size between these elements in the various genera, and also to the fact that otherwise closely allied species may differ very considerably in this respect. The failure to obtain hybrids between certain species of *Rana* has been attributed principally to these differences. The spermatozoa of *Discoglossus* are remarkable for their great size, measuring three millimetres in length.

Fairing and Oviposition.—Batrachians may be divided into four categories under this head:—(1) no amplexation; (2) amplexation without internal fecundation; (3) amplexation with internal fecundation; (4) copulation proper. The first category embraces many aquatic newts, the second nearly all the Ecaudata, the third the rest of the Caudata, and the fourth the Apoda.

In the typical newts (*Molge*) of Europe, the males are adorned during the breeding season with bright colours and crests or other ornamental dermal appendages, and, resorting to the water, they engage in a lengthy courtship accompanied by lively evolutions around the females, near which they deposit their spermatozoa in bundles on a gelatinous mass, the spermatophore, probably secreted by the cloacal gland. This arrangement facilitates the internal fecundation of the female without copulation, the female absorbs the spermatozoa by squeezing them out with the spermatophore between the cloacal lips. Other newts, and many salamanders, whether terrestrial or aquatic, pair, the male embracing the female about the fore limbs or in the pelvic region, and the males of such forms are invariably devoid of ornamental secondary sexual characters; but in spite of this amplexation the same mode of fecundation by means of a spermatophore is resorted to, although it may happen that the contents of the spermatophore are absorbed direct from the cloaca of the male. The spermatozoa thus reach the eggs in the oviducts, where they may develop entirely, some of the salamanders being viviparous.

In all the tailless batrachians (with the exception of a single known viviparous toad), the male clings to the female round the waist, at the arm-pits or round the waist and awaits, often for hours or days, the deposition of the ova, which are immediately fecundated by several seminal emissions.

The fourth category is represented by the Apoda or Caecilians in which, as we have stated above, the male is provided with an intromittent organ. Some of these batrachians are viviparous.

In those species in which the embrace is of long duration the limbs

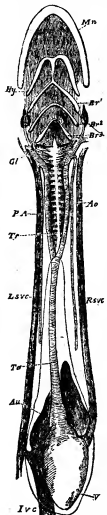

FIG. 13.—Ventral view of the head and trunk of *Ichthyophis glutinosus*.

Mn, Mandible.

Hy, Hyoid.

Br, Branchial arches.

Gl, Gill.

Tr, Trachea.

Iv, Inferior vena cava.

V, Ventricle.

Au, Auricles.

Rse, Right and left superior caeae.

Ta, Truncus arteriosus.

Ao, Left aortic arch.

P.A., Right pulmonary artery.

The pericardium (lightly shaded) extends as far as the bifurcation of the

syngangium.

of the male, usually the fore limbs (pleurodele newt, *Ecaudata*), rarely the hind limbs (a few American and European newts), according to the mode of amplexation, acquire a greater development, and are often armed with temporary horny excrescences which drop off after the pairing season. These apertures usually form brush-like patches on the inner side of one or more of the digits, but may extend over the inner surface of the limbs and on the breast and chin; the use of them on these parts is sufficiently obvious, but they are sometimes also present, without apparent function, on various parts of the foot, as in *Discoglossus*, *Ambystoma*, and *Pelodytes*. In some species of the South American frogs of the genus *Leptodactylus* the breast and hands are armed with very large spines, which inflict deep wounds on the female held in embrace.

In most of the *Caudata*, the eggs are deposited singly in the axils of water plants or on leaves which the female folds over the egg with her hind limbs. The eggs are also deposited singly in some of the lower *Ecaudata*. In many of the *Ecaudata*, and in a few of the *Caudata* and *Apoda*, the eggs are laid in strings or bands which are twined round aquatic plants or carried by the parent; whilst in other *Ecaudata* they form large masses which either float on the surface of the water or sink to the bottom.

A few batrachians retain the ova within the oviducts until the young have undergone part or the whole of the metamorphosis. Viviparous parturition is known among the *Caudata* (*Salamanatra*, *Speleperus fuscus*), and the *Apoda* (*Dermophis thomensis*, *Typhlonectes compressicauda*); also in a little toad (*Pseudophryne vivipara*) recently discovered in German East Africa (41).

Development and Metamorphosis.—In a great number of batrachians, including most of the European species, the egg is small and the food-yolk is in insufficient quantity to form an external appendage of the embryo. But in a few European and North American species, and in a great many inhabitants of the tropics, the egg is large and a considerable portion of it persists for a long time as a yolk-sac. Although the segmentation is always complete, it is very irregular in these types, some of which make a distinct approach to the meroblastic egg.

With the exception of a number of forms in which the whole development takes place within the egg or in the body of the mother, batrachians undergo metamorphoses, the young passing through a free-swimming, gill-breathing period of considerable duration, during which their appearance, structure, and often their régime, are essentially different from those of the mature form. Even the fossil *Stegocephalia* underwent metamorphosis, as we know from various larval remains first described as *Branchiosaurus*. They are less marked or more gradual in the *Apoda* and *Caudata* than in *Ecaudata*, in which the stage known as tadpole is very unlike the frog or toad into which it rather suddenly passes (see TADPOLE). In the *Caudata*, external gills (three on each side) persist until the close of the metamorphosis, whilst in the *Apoda* and *Ecaudata* they exist only during the earlier periods, being afterwards replaced by internal gills.

Many cases are known in which the young batrachian enters the world in the perfect condition, as in the black salamander of the Alps (*Salamanatra atra*), the cave salamander (*Speleperus fuscus*), the caecilian *Typhlonectes*, and a number of frogs, such as *Pipa*, *Rhinoderma*, *Hylodes*, some *Nototrema*, *Rana opisthodon*, &c. A fairly complete bibliographical index to these cases and the most remarkable instances of parental care in tailless batrachians will be found in the interesting articles by Lilian V. Sampson (42), and by G. Brantley and W. Schoenichen (43). It will suffice to indicate here in a synoptic form, as was done by the present writer many years ago, when our knowledge of these wonders of batrachian life was far less advanced than it is now, the principal modes of protection which are resorted to:—

1. Protection by means of nests or nurseries.
 - A. In enclosures in the water.—*Hyalafaba*.
 - B. In nests in holes near the water.—*Rhacophorus*, *Leptodactylus*.
 - C. In nests overhanging the water.—*Rhacophorus*, *Chironomantis*, *Phyllomedusa*.
 - D. On trees or in moss away from the water.—*Rana opisthodon*, *Hylodes*, *Hylella platycephala*.
 - E. In a gelatinous bag in the water.—*Phrynomachus*, *Salamanatra*.
2. Direct nursing by the parents.
 - A. Tadpoles transported from one place to another.—*Dendrobates*, *Phyllobates*, *Sooglossus*.
 - B. Eggs protected by the parents who coil themselves round or "sit" on them.—*Mantophrane*, *Desmognathus*, *Autodax*, *Plethodon*, *Cryptobranchus*, *Amphibium*, *Icthyophis*, *Hypogeophis*, *Siphonops*.
 - C. Eggs guarded by the parents.
 - (a) Round the legs by the male.—*Alytes*.
 - (b) On the back, by the female.
 - (1) Exposed.—*Hyla goldi*, *H. evansii*, *Cerato-hyla*.
 - (2) In cell-like pouches.—*Pipa*.
 - (3) In a common pouch.—*Nototrema*, *Amphimethodon*.

(c) On the belly.

(1) Exposed, by the female.—*Rhacophorus reticulatus*.

(2) In a pouch (the produced vocal sac), by the male.—*Rhinoderma*.

(d) In the mouth, by the female.—*Hylambates brevirostris*.

Geographical Distribution.—If a division of the world according to its batrachian faunae were to be attempted, it would differ very considerably from that which would answer for the principal groups of reptiles, the *Lizards*, &c. Especially, we should have four great realms:—(1) Europe and Northern and Temperate Asia, Africa north of the Sahara (palaearctic region) and North and Central America (nearctic region); (2) Africa and South-Eastern Asia (Ethiopian and Indian region); (3) South America (neotropical region); and (4) Australia (Australian region). The first would be characterized by the *Caudata*, which are almost confined to it (although a few species penetrate into the Indian and neotropical regions), the *Discoglossidae*, mostly European-Asiatic, but one genus in California, and the numerous *Pelobatidae*; the second by the presence of *Apoda*, the prevalence of firmisternal *Ecaudata* and the absence of *Hyalidae*; the third by the presence of *Apoda*, the prevalence of arcticiferous *Ecaudata*, and the scarcity of *Ranidae*, the fourth by the prevalence of arcticiferous *Ecaudata* and the absence of *Ranidae*, as well as by the absence of either *Caudata* or *Apoda*. Madagascar might almost stand as a fifth division of the world, characterized by the total absence of *Caudata*, *Apoda*, and arcticiferous *Ecaudata*. But the close relation of its very rich frog-fauna to that of the Ethiopian and Indian regions speaks against attaching too great importance to these negative features. It may be noted here that no two parts of the world differ so considerably in their *Ecaudata* as do Madagascar and Australia, the former having only Firmisternia, the latter only Arctifera. Although there is much similarity between the *Apoda* of Africa and of South America, one genus being even common to both parts of the world, the frogs are extremely different, apart from the numerous representatives of the widely distributed genus *Bufo*. It may be said that, on the whole, the distribution of the batrachians agrees to some extent with that of fresh-water fishes, except for the much less marked affinity between South America and Africa, although even among the former we have the striking example of the distribution of the very natural group of the aglossal batrachians, represented by *Pipa* in South America and by *Xenopus* and *Hymenochirus* in Africa.

BIBLIOGRAPHY.—(1) On the use of the names *Batrachia* and *Amphibia*, cf. E. D. Cope, *Geol. Mag.* (3) ii, 1885, p. 595; G. Baur, *Science* (2), vi, 1897, pp. 170, 372; B. G. Wilder, *l.c.* p. 275; T. Gill, *l.c.* p. 446; O. P. Hay, *l.c.* p. 773; T. Gill, *Science* (2), xx, 1890, p. 730; Schneider, *op. cit.* xii, p. 924; (2) E. Fraas, "Die Labyrinthodonten der schwäbischen Trias," *Palaeontolog.* xxxvii, 1889, p. 1. (3) *Proc. Zool. Soc.* 1904, ii, p. 170. (4) E. D. Cope, "Synopsis of the Extinct Batrachia of North America," *Proc. Ac. Philad.*, 1868, p. 208. (5) "Researches on the Structure, Organization and Classification of the Fossil Reptilia, vii," *Phil. Trans.* clxxxiii, (B), 1892, p. 311. (6) *Cambridge Natural History*, viii, 1001. (7) "Die Urvierfüssler (Etetrapoda) des sächsischen Rothliegenden," *Allgem. verständl. naturh. Abh.*, Berlin, 1891, No. 15; "Die Entwicklungsgeschichte von Branchiosaurus amblystomus," *Zeitschr. deutsch. Geol. Ges.*, 1886, p. 576. (8) C. Emery, "Über die Beziehungen des Chiropterygium zum Ichthyopterygium," *Zool. Anz.* x, 1887, p. 185; E. D. Cope, "On the Phylogeny of the Vertebrata," *Proc. Amer. Philos. Soc.* xxx, 1892, p. 280; H. B. Pollard, "On the Anatomical and Phylogenetic Position of *Platyterus*," *Zool. Jahrb. Anat. v.*, 1892, p. 414; G. Baur, "The Stegocephalia: a Phylogenetic Study," *Anal. Anz.* xi, 1896, p. 657; L. Dollo, "Sur la phylogénie des dipneustes," *Mém. soc. belge géol. ix.*, 1895, p. 79; T. Gill, "On the Derivation of the Pectoral Member in Terrestrial Vertebrates," *Rep. Brit. Ass.*, 1897, p. 697. (9) E. D. Cope, "The Origin of the Mammalia," *Proc. Amer. Philos. Soc.* xxii, 1884, p. 43; cf. Discussion on Origin of Mammals, *Proc. Intern. Congr. Zool.*, Cambridge, 1898; also H. Gadow, "The Origin of the Mammalia," *Z. f. Morphol. v.*, 1902, p. 345; and R. Broom, *Rep. Brit. Ass.*, 1905, p. 437. (10) A. Fritsch, *Fauna der Gosau und der Kalksteine der Umformation Böhmen*, vols. i and ii (Prague, 1879-1885, 4to); H. Credner, "Die Stegocephalen aus dem Rothliegenden des Plauenischen Grundes bei Dresden," *Zeitschr. deutsch. Geol. Ges.*, 1881-1894; J. W. Dawson, "On the Results of Recent Explorations of Erect Trees containing Animal Remains in the Coal Formation of Nova Scotia," *Phil. Trans.* clxxxii, 1882, p. 621; H. B. Geinitz and J. V. Deichmüller, "Die Saurier der unteren Dyas von Sachsen," *Palaeontol.* xxix, 1882, p. 1; A. Gaudry, *Les Enchaînements du monde animal dans les temps géologiques, fossiles primaires* (Paris, 1883, 8vo), p. 251; E. D. Cope, "The Batrachia of the Permian Period of North America," *Amer. Nat.* xviii, 1884, p. 26; E. Fraas, "Die Labyrinthodonten der schwäbischen Trias," *Palaeontol.* xvi, 1889, p. 1; L. v. Ammon, "Die batrachischen Amphibien der Rheinpfalz (Munich, 1889-1891, 4to); R. Lydekker, *Catalogue of the Fossil Reptilia and Amphibia in the British Museum*, part iv. (London, 1890, 8vo); E. Fraas, *Die schwäbischen Trias-Saurier nach dem Material der k. Naturalien-Sammlung in Stuttgart zusammengestellt* (Stuttgart, 1896, 4to); O. Jaekel, "Die Organization

von *Archegosaurus*." *Zeitschr. deutsch. geol. Ges.* xviii., 1896, p. 505; F. Broili, "Ein Beitrag zur Kenntnis von *Eryops megalcephalus*," *Palaeontogr.* xvi., 1899, p. 61. (11) "Amphibian Footprints from the Devonian," *Amer. Journ. Sci.* ii., 1896, p. 374. (12) "Découverte du plus ancien amphibien connu . . . dans le lamien supérieur de Modave," *Bull. soc. belge géol.* xv., 1888, p. cvii. (13) "A Batrachian Armadillo," *Amer. Nat.* xviii., 1895, p. 998. (14) C. Gegenbaur, *Untersuchungen zur vergleichenden Anatomie der Wirbelstübe bei Amphibien und Reptilien* (Leipzig, 1862, 4to); H. Gadow, "On the Evolution of the Vertebral Column of Amphibia and Amniota," *Phil. Trans.* clxxxvii. (B), 1896, p. 1. (15) R. Wiedersheim, *Die Anatomie der Gymnophionen* (Jena, 1879, 4to); W. Peters, "Über die Einteilung der Caecilien," *Mon. Berl. Ac.* 1879, p. 924; G. A. Boulenger, *Catalogue of Batrachia* *Gradientia s. Cavadata and Batrachia Apoda in the Collection of the British Museum* (London, 1882, 8vo), p. 1. "A Synopsis of the Genera and Species of Apodal Batrachians," *P.Z.S.*, 1895, p. 401. (16) "On the Structure and Affinities of the Amphimidae," *Proc. Amer. Philos. Soc.* xliii., 1886, p. 442. (17) *Ergänzung naturwissenschaftlicher Forschungen auf Ceylon*, ii. (Wiesbaden, 1887-1890, 4to). (18) "The Chondrocranium of the Ichthyopsida," *Stud. Biol. Lab. Tufts Coll.* No. 5, 1898, p. 147. (19) G. A. Boulenger, *Catalogue, &c.*, 1882. (20) H. H. Wilder, "Lunglose Salamandriden," *Anat. Anz.* ix., 1894, p. 216; L. Cameron, "Kicerche anatomofisiologiche intorno al Salamandridi normale e anormale," *Atti Acc. Gio. Lincei*, 1894, p. 705, and xxxi., 1896, p. 512; H. H. Wilder, "Lungless Salamanders," *Anat. Anz.* xii., 1896, p. 182; E. Loebnig, "Notes on Tailed Batrachians without Lungs," *Zool. Anz.* xix., 1896, p. 33. (21) "Note sur le batracien de Bernisart," *Bull. mus. belg.* iii., 1884, p. 85. (22) G. A. Boulenger, *Catalogue of Batrachia* *Salientia s. Ecaudata in the Collection of the British Museum* (London, 1882, 8vo). (23) "On the Development of the Vertebral Column in *Pipa* and *Xenopus*," *Anat. Anz.* xiii., 1898, p. 359. (24) G. A. Boulenger, "On *Hymenochirus*, a New Type of Aglossal Batrachians," *Ann. and Mag. N.H.* (7), iv., 1899, p. 122. (25) L. M. Vidal, *Mem. Ac. Barcelona* (3), iv., 1902, No. 18, pl. iv. (26) W. Wolterstorff, "Über fossile Frösche, insbesondere Palaeobatrachius," *Jahrb. Nat. Ver. Magdeb.*, 1885 and 1886. (27) W. Peters, "Über die Entwicklung cines Batrachiers, *Hylodes martinicensis*, ohne Metamorphose," *Mon. Berl. Ac.* 1876, p. 709; A. Kappler, "Die Tierwelt in holländischen Guiana," *Das Ausland*, 1885, p. 358; G. A. Boulenger, "Reptiles and Batrachians of the Solomon Islands," *Trans. Zool. Soc.* xii., 1889, p. 51; H. v. Ihering, "On the Oviposition of the genus *Phyllomedusa*," *Mag. N.H.* (5), xvi., 1896, p. 461; H. H. Smith, "On Oviposition and Nursing in the Batrachian genus *Dendrobates*," *Amer. Nat.* xxi., 1887, p. 307; G. B. Howes, "Notes on the Gular Brood-pouch of *Rhinoderma darwini*," *P.Z.S.*, 1888, p. 231; W. J. Holland, "Arboreal Tadpoles," *Amer. Nat.* xliii., 1889, p. 383; E. A. Goeldi, "Contribution to the Knowledge of the Breeding Habits of some Tree-frogs of the Serra dos Orgaos, Rio de Janeiro, Brazil," *P.Z.S.*, 1895, p. 89; G. A. Boulenger, "On the Nursing Habits of two South American Frogs," *P.Z.S.*, 1895, p. 209; A. Brauer, "Ein neuer Fall von Brutpflege bei Fröschen," *Zool. Jahrb. Syst.* xi., 1898, p. 9. Ikeda, "Notes on the Breeding Habits and Development of *Rhacophorus sclegelii*," *Annot. Zool. Japon.* i., 1898, p. 113; G. Brandes, "Larven zweier Nototrema-Arten," *Verh. deutsch. zool. Ges.*, 1899, p. 288; L. v. Mähely, "Beiträge zur Kenntnis der Eryngostomatiden von Neu-Guinea," *Termes. Fuzetek. Budapest*, xxiv., 1901, p. 216; G. A. Boulenger, "*Ceratolysis bubalus* carrying eggs on its back," *P.Z.S.*, 1903, ii. p. 115. Idem, "Description of a new Tree-frog of the genus *Phyllomedusa* from British Guiana, carrying eggs on the back," *op. cit.* 1904, ii. p. 106; H. S. Ferguson, "Travancore Batrachians," *J. Bombay N.H. Soc.* xv., 1904, p. 499. (28) *Geol. Mag.* iv., ii., 1895, p. 83. (29) "Das Hyobranchial-Skelet der Anura," *Morph. Arb.* iii., 1894, p. 399. (30) "On the Structure and Development of the Hyobranchial Skeleton of the Parsley Frog," *P.Z.S.*, 1897, p. 577. (31) W. G. Ridewood, "On the Hyobranchial Skeleton and Larynx of *Hymenochirus*," *J. Linn. Soc.* xxxviii., 1899, p. 454. (32) *Morphol. Jahrb.* xiii., 1887, p. 119. (33) G. B. Howes and A. M. Davies, *P.Z.S.*, 1888, p. 495. (34) G. A. Boulenger, "The Poisonous Secretion of Batrachians," *Nat. Science*, i., 1892, p. 185; F. Gidon, *Venias multiples et toxicité humorale chez les batraciens* (Paris, 1897, 8vo). (35) *Arch. Ges. Physiol.* li., 1892, p. 455. (36) G. A. Boulenger, *P.Z.S.*, 1900, p. 433, and 1901, ii. p. 709; H. Gadow, *Anat. Anz.* xviii., 1900, p. 588. (37) G. A. Boulenger, "On the Presence of Pterygoid Teeth in a Tailless Batrachian, with remarks on the Localization of Teeth on the Palate," *P.Z.S.*, 1890, p. 664. (38) *Morphol. Jahrb.* xiii., 1887, p. 119. (39) *P.Z.S.*, 1888, p. 122. (40) G. A. Boulenger, *Tailed Batrachians of Europe* (1897), p. 75. (41) G. Tornier, "Pseudophryne vivipara, ein lebendig gebärender Frosch," *Sitzb. Ak. Ber.* xxxix., 1905, p. 855. (42) "Unusual Modes of Breeding and Development among Anura," *Amer. Nat.* xxxiv., 1900, p. 405. (43) "Brutpflege der schwanzlosen Batrachier," *Abh. Nat. Ges.* Halle, xlii., 1901, p. 395. (G. A. B.)

BATRACHOMYOMACHIA (Gr. *batrapaxos*, "frog," *mûs*, "mouse," and *μάχη*, "battle"), the "Battle of Frogs and Mice," a comic epig or parody on the *Iliad*, definitely attributed to Homer by the Romans, but according to Plutarch (*De*

Herodoti Malignitate, 43) the work of Figes of Halicarnassus, the brother (or son) of Artemisia, queen of Caria and ally of Xerxes. Some modern scholars, however, assign it to an anonymous poet of the time of Alexander the Great.

Edition by A. Ludwich (1896).

BATTA, an Anglo-Indian military term, probably derived from the Canarese *bhatta* (rice in the husk), meaning a special allowance made to officers, soldiers, or other public servants in the field.

BATTAGLIA, a town of Venetia, Italy, in the province of Padua, 11 m. S.S.W. by rail from Padua. Pop. (1901) 4456. It lies at the edge of the volcanic Euganean Hills, and is noted for its warm saline springs and natural vapour grotto. A fine palace was erected in the Palladian style in the 17th century by Marchese Benedetto Selvatico-Estense, then owner of the springs.

BATTAKHIN, African "Arabs" of Semitic stock. They occupy the banks of the Blue Nile near Khartum, and it was against them that General Gordon fought most of his battles near the town. Their sheikh, El Obeid, routed Gordon's troops on the 4th of September 1884, a defeat which led to the close investment of Khartum. In the 18th century James Bruce described them as "a thieving, pilfering lot."

BATTALION, a unit of military organization consisting of four or more companies of infantry. The term is used in nearly every army, and is derived through Fr. from It. *battaglione*, Med. Lat. *batalia* (see **BATTLE**). "Battalion" in the 16th and 17th centuries implied a unit of infantry forming part of the line of battle, but at first meant an unusually large *batalia* or a single large body of men formed of several *batalias*. In the British regular service the infantry battalion is commanded by a lieutenant-colonel, who is assisted by an adjutant, and consists at war strength of about 1000 bayonets in eight companies. Engineers, train, certain kinds of artillery, and more rarely cavalry are also organized in battalions in some countries.

BATTAMBANG, or **BATTAMBONG** (locally *Phratobong*), the chief town of the north-western division of Cambodia, formerly capital of Monton Kmer, i.e. "The Cambodian Division," one of the eastern provinces of Siam, now included in the French protectorate of Cambodia. It is situated in 103° 6' E., 13° 6' N., in the midst of a fertile plain and on the river Sang Ke, which flows eastwards and falls into the Tonle or Talé Sap, the great lake of Cambodia. The town is a collection of bamboo houses of no importance, but there is a walled encinte of some historical interest. Trade is small and is carried on by Chinese settlers, chiefly overlard with Bangkok, but to a small extent also by water with Saigon. The population is about 5000, two-thirds Cambodian and the remainder Chinese and Siamese. The language is Cambodian.

Battambang was taken by the Siamese when they overran the kingdom of Cambodia towards the end of the 18th century, and was recognized by the French as belonging to Siam when the frontier of Cambodia was adjusted by treaty in 1867-1872. In another treaty in 1893, Siam bound herself to maintain no armed forces there other than police, but this arrangement was annulled by the treaty of 1904, by which Battambang was definitely admitted to lie within the French sphere of influence. Under a further treaty in March 1907 (see **SIAM**), the district of Battambang was finally ceded to the French.

BATTANNI, or **BHTANNI**, a small tribe on the Waziri border of the North-West Frontier Province of India. The Battannis hold the hills on the borders of Tank and Bannu in the Dera Ismail Khan district, from the Gabar mountain on the north to the Gomal valley on the south. They are only 3000 fighting men strong, and are generally regarded as the jackals of the Waziris. Their chief importance arises from the fact that no raids can be carried into British districts by the Mahsud Waziris without passing through Battanni territory. A small British expedition against the Battannis was led by Lt.-Col. Ryd in 1880. Under the excitement caused by the preaching of a fanatical mullah the Mahsud Waziris had attacked the town of Gomal. The Battannis failed to supply information as to their

movements, and gave them a passage through their lands. The British troops accordingly stormed the Hinis Tangi defile in face of opposition, and burned the village of Jandola.

BATTAS (Dutch *Battaks*), the inhabitants of the formerly independent Batta country, in the central highlands of Sumatra, now for the most part subjugated to the Dutch government. The still independent area extends from 98°–99° 35' E., and 2°–3° 25' S. North-east of Toba Lake dwell the Timor Battas, and west of it the Pakpak, but on its north (in the mountains which border on the east coast residency) the Karo Battas form a special group, which, by its dialects and ethnological character, appears to be allied to the Gajus and Allas occupying the interior of Achin. The origin of the Battas is doubtful. It is not known whether they were settled in Sumatra before the Hindu period. Their language contains words of Sanskrit origin and others referable to Javanese, Malay and Tagal influence. Their domain has been doubtless much curtailed, and their absorption into the Achin and Malay population seems to have been long going on. The Battas are undoubtedly of Malayan stock, and by most authorities are affiliated to that Indonesian pre-Malayan race which peopled the Indian Archipelago, expelling the aboriginal negritos, and in turn themselves submitting to the civilized Malays. In many points the Battas are physically quite different from the Malay type. The average height of the men is 5 ft. 4 in.; of the women 4 ft. 8 in. In general build they are rather thickest, with broad shoulders and fairly muscular limbs. The colour of the skin ranges from dark brown to a yellowish tint, the darkness apparently quite independent of climatic influences or distinction of race. The skull is rather oval than round. In marked contrast to the Malay type are the large, black, long-shaped eyes, beneath heavy, black or dark brown eyebrows. The cheek-bones are somewhat prominent, but less so than among the Malays. The Battas are dirty in their dress and dwellings and eat any kind of food, though they live chiefly on rice. They are remarkable as a people who in many ways are cultured and possess a written language of their own, and yet are cannibals. The more civilized of them around Lake Toba are good agriculturists and stock-breeders, and understand iron-smelting. They weave and dye cotton, make jewellery and kriszes which are often of exquisite workmanship, bake pottery, and build picturesque chalet-like houses of two storeys. They have an organized government, hereditary chiefs, popular assemblies, and a written civil and penal code. There is even an antiquated postal system, the letter-boxes being the hollow tree trunks at cross-roads. Yet in spite of this comparative culture the Battas have been notorious for the most revolting forms of cannibalism. (See *Memoirs of the Life, &c., of Sir T. S. Raffles*, 1830.)

The Battas are the only lettered people of the Indian Archipelago who are not Mahomedans. Their religion is mainly confined to a belief in evil spirits; but they recognize three gods, a Creator, a Preserver and a Destroyer, a trinity suggestive of Hindu influence.

Up to the publication of Dr H. N. van der Tuuk's essay, *Oer schrift en uitspraak der Tobasche taal* (1855), our knowledge of the Batta language was confined to lists of words more or less complete, chiefly to be found in W. Marsden's *Miscellaneous Works*, in F. W. Junghuhn's *Battalander*, and in the *Tijdschrift van het Bataviaasch Genootschap*, vol. iii. (1855). By his exhaustive works (*Bataksch Leesboek*, 4 vols., 1861–1862; *Bataksch-nederduitsch Woordenboek*, 1861; *Tobasche Spraakkunst*, 1864–1867) van der Tuuk made the Batta language the most accessible of the various tongues spoken in Sumatra. According to him, it is nearest akin to the old Javanese and Tagal, but A. Schreiber (*Die Battas in ihrem Verhältnis zu den Malaien von Sumatra*, 1874) endeavoured to prove its closer affinity with the Malay proper. Like most languages spoken by less civilized tribes, Batta is poor in general terms, but abounds in terms for special objects. The number of dialects is three, viz. the Toba, the Mandailing and the Dairi dialects; the first and second have again two subdivisions each. The Battas further possess six peculiar or recondite modes of speech, such as the *hala undung*, or language of the wakes, and the *hala poda* or the soothsayer's

language. A fair acquaintance with reading and writing is very general among them. Their alphabet is said, with the Rejang and Lampong alphabets, to be of Indian origin. The language is written on bark or bamboo staves from bottom to top, the lines being arranged from left to right. The literature consists chiefly in books on witchcraft, in stories, riddles, incantations, &c., and is mostly in prose, occasionally varied by verse.¹

See also "Reisen nach dem Toba See," *Petermanns Mitteil.* (1883); Modigliani, *Fra i Batacchi indipendenti* (Rome, 1892); Neumann, "Het Pance-en Bilastroengebied," *Tydschr. Aard. Gen.*, 1885–1887; Van Dijk in the same periodical (1890–1895); Wing Easton in the *Jaarboek voor het Mynezien*, 1894; Niemann in the *Encyclopaedia van Nederlandsch-Indië*, under the heading *Battaks*, with very detailed bibliography; Baron J. v. Brenner, *Besuch bei den Kannibalen Sumatras* (Wurzburg, 1893); H. Breitenstein, *21 Jahre in Indien, Java, Sumatra* (Leipzig, 1899–1900); G. P. Rouffaer, *Die Battak-Kunst in niederländisch-Indien und ihre Geschichte* (Haarlem, 1899).

BATTEL, or **BATTELS** (of uncertain origin, possibly connected with "battle," a northern English word meaning to feed, or "batten"), a word used at Oxford University for the food ordered by members of the college as distinct from the usual "commons"; and hence college accounts for board and provisions supplied from kitchen and buttery, and, generally, the whole of a man's college accounts. "Batteler," now a resident in a college, was originally a rank of students between commoners and servants who, as the name implies, were not supplied with "commons," but only such provisions as they ordered for themselves.

BATTEN, **SIR WILLIAM** (*floruit* 1626–1667), British sailor, son of Andrew Batten, master in the royal navy, first appears as taking out letters of marque in 1626, and in 1638 he obtained the post of surveyor to the navy, probably by purchase. In March 1642 he was appointed second-in-command under the earl of Warwick, the parliamentary admiral who took the fleet out of the king's hands. It was Vice-Admiral Batten's squadron which bombarded Scarborough when Henrietta Maria landed there. He was accused (it appears unjustly) by the Royalists of directing his fire particularly on the house occupied by the queen, and up to the end of the First Civil War showed himself a steady partisan of the parliament. To the end of the First Civil War, Batten continued to patrol the English seas, and his action in 1647 in bringing into Portsmouth a number of Swedish ships of war and merchantmen, which had refused the customary salute to the flag, was approved by parliament. When the Second Civil War began he was distrusted by the Independents and removed from his command, though he confessed his continued willingness to serve the state. When part of the fleet revolted against the parliament, and joined the prince of Wales in Holland, May 1648, Batten went with them. He was knighted by the prince, but being suspected by the Royalists, was put ashore mutinously in Holland and returned to England. He lived in retirement during the Commonwealth period. At the Restoration Sir William Batten became once more surveyor of the navy. In this office he was in constant intercourse with Pepys, whose diary frequently mentions him; but the insinuations of Pepys against him must not be taken too seriously, as there is no evidence to show that Batten in making a profit from his office fell below the standards of the time. In 1661 he became M.P. for Rochester, and in 1663 he was made master of the Trinity House. He died in 1667.

There is no separate life of Batten, but many notices of him will be found in Penn's *Life of Sir W. Penn*, and in Pepys's *Diary*.

BATTEN. (1) A term (a form of "baton") used in joinery (*q.v.*) for a board not more than 4 to 7 in. broad or 3 in. thick, used for various purposes, such as for strengthening or holding together laths and other wood-work; and specially, on board ship, a strip of wood nailed to a mast to prevent rubbing, or fixing down a tarpaulin over a hatchway, in rough weather, to keep out water. (2) A verb (the root is found in words of several Teutonic languages meaning profit or improvement, and also in the English "better"

¹ Mr. C. A. van Ophuizen has published (*in Bijdr. tot Land- en Taal-en Volken-Kunde*, 1886) an interesting collection of Battak poetry. He describes a curious leaf language used by Battak lovers, in which the name of some leaf or plant is substituted for the word with which it has greatest phonetic similarity.

and "boot") meaning to improve in condition, especially in the case of animals by feeding; so, to feed gluttonously; the word is used figuratively of prospering at the expense of another.

BATTENBERG, the name of a family of German counts which died out about 1314, whose seat was the castle of Kellerburg, near Battenberg, a small place now in the Prussian province of Hesse-Nassau. The title was revived in 1851, when Alexander (1823-1888), a youngson of Louis II., grand-duke of Hesse, contracted a morganatic marriage with a Polish lady, Countess Julia Theresa von Hauke (1825-1895), who was then created countess of Battenberg. Raised to the rank of a princess in 1858, the countess and her children were allowed to style themselves princes and princesses of Battenberg, with the addition of *Durchlaucht* or *Serene Highness*. The eldest son of this union, Louis Alexander (b. 1854), married in 1884 Victoria, daughter of Louis IV., grand-duke of Hesse, and became an admiral in the British navy. The second son, Alexander Joseph (*q.v.*), was prince of Bulgaria from 1879 to 1886. The third son, Henry Maurice, was born in 1858, and married on the 23rd of July 1885 Beatrice, youngest daughter of Victoria, queen of England. He died at sea on the 20th of January 1896 when returning from active service with the British troops during the Ashanti War, and left three sons and a daughter, Victoria Eugénie, who was married in 1906 to Alphonso XIII., king of Spain. The fourth son, Francis Joseph, born in 1861, married in 1897 Anna, daughter of Nicholas I., prince of Montenegro, and is the author of *Die volkswirtschaftliche Entwicklung Bulgariens von 1879 bis zur Gegenwart* (Leipzig, 1891). The only daughter of the prince of Battenberg, Marie Caroline, born in 1852, was married in 1871 to Gustavus Ernest, prince and count of Erbach-Schönberg.

BATTER, an architectural term of unknown origin, used of the face of a wall which is slightly inclined to the perpendicular. It is most commonly employed in retaining walls, the lower courses of which are laid at right angles to the batter, so as to resist the thrust of the earth inside. For aesthetic reasons it is often adopted in the lowest or basement porticos of a great building. From a historical point of view it is the most ancient system employed, as throughout Egypt and Chaldaea all the temples built in unburnt brick were perforce obliged to be thicker at the bottom, and this gave rise to the batter or raking side which was afterwards in Egypt copied in stone. For defensive purposes the walls of the lower portions of a fortress were built with a batter as in the case of the tower of David and some of the walls built by Herod at Jerusalem. The Crusaders also largely adopted the principle, which was followed in some of the castles of the middle ages throughout Europe.

BATTERING RAM (Lat. *aries*, ram), a military engine used before the invention of cannon, for beating down the walls of besieged fortresses. It consisted of a long heavy beam of timber, armed at the extremity with iron fashioned something like the head of a ram. In its simplest form the beam was carried in the hands of the soldiers, who assailed the walls with it by main force. The improved ram was composed of a longer beam, in some cases extending to 120 ft., shod with iron at one end, and suspended, either by the middle or from two points, from another beam laid across two posts. This is the kind described by Josephus as having been used at the siege of Jerusalem (*B.J.* iii. 7. 19). The ram was shielded from the missiles of the besieged by a penthouse (*vinea*) or other overhead protection. It was often mounted on wheels, which greatly facilitated its operations. A hundred soldiers at a time, and sometimes even a greater number, were employed to work it, and the parties were relieved in constant succession. No wall could resist the continued application of the ram, and the greatest efforts were always made to destroy it by various means, such as dropping heavy stones on the head of the ram and on the roof of the penthouse; another method being to seize the ram head with grapnels and then haul it up to a vertical position by suitable windlasses on the wall of the fortress. Sometimes the besieged ran countermines under the ram penthouse; this if successful would cause the whole engine to fall into the excavation. In mediæval warfare the low penthouse, called *cat*, was generally employed with some form of ram.

BATTERSEA, a south-western metropolitan borough of London, England, bounded N. by the Thames, N.E. by Lambeth, and S.E., S., and W. by Wandsworth. Pop. (1901) 168,907. The principal thoroughfares are Wandsworth Road and Battersea Park and York Roads from east to west, connected north and south with the Victoria or Chelsea, Albert and Battersea bridges over the Thames. The two first of these three are handsome suspension bridges; the third, an iron structure, replaced a wooden bridge of many arches which was closed in 1881, after standing a little over a century. Battersea is a district mainly consisting of artisans' houses, and there are several large factories by the river. The parish church of St Mary, Church Road (1776), preserves from an earlier building stained glass and monuments, including one to Henry St John, Viscount Bolingbroke (d. 1751), and his second wife, who had a mansion close by. Of this a portion remains on the riverside, containing a room associated with Pope, who is said to have worked here upon the "Essay on Man." Wandsworth Common and Clapham Common (220 acres) lie partly within the borough, but the principal public recreation ground is Battersea Park, bordering the Thames between Albert and Victoria Bridges, beautifully laid out, containing a lake and subtropical garden, and having an area of nearly 200 acres. It was constructed with difficulty by embanking the river and raising the level of the formerly marshy ground, and was opened in 1858. Among institutions are the Battersea Polytechnic, the Royal Masonic Institution for girls, founded in 1788, and Church of England and Wesleyan Training Colleges. Battersea is in the parliamentary borough of Battersea and Clapham, including the whole of the Battersea division and part of the Clapham division. The borough council consists of a mayor, 9 aldermen and 54 councillors. Area, 2,160.3 acres.

An early form of the name is *Patricsey* or Peter's Island; the manor at the time of the Domesday survey, and until the suppression of the monasteries, belonging to the abbey of St Peter, Westminster. It next passed to the crown, and subsequently to the family of St John and to the earls Spencer. York Road recalls the existence of a palace of the archbishops of York, occasionally occupied by them between the reigns of Edward IV. and Mary. Battersea Fields, bordering the river, were formerly a favourite resort, so that the park also perpetuates a memory. The art of enamelling was introduced, c. 1750, at works in Battersea, examples from which are highly valued.

BATTERY (Fr. *batterie*, from *battre*, to beat), the action of beating, especially in law the unlawful wounding of another (see ASSAULT). The term is applied to the apparatus used in battering, hence its use in military organization for the unit of mobile artillery of all kinds. This consists of from four to eight guns with their *personnel*, wagons and train. In the British service the term is applied to field, horse, field-howitzer, heavy and mountain artillery units. "Battery" is also used to imply a mass of guns in action, especially in connexion with the military history of the 18th and early 19th centuries. In siegcraft, a battery is simply an emplacement for guns, howitzers or mortars, constructed for the purposes of the siege, and protected as a rule by a parapet. In fortification the term is applied similarly to permanent or semi-permanent emplacements for the artillery of the defence. In all these senses the presence of artillery is implied in the use of the word (see ARTILLERY, and FORTIFICATION and SIEG-CRAFT). The word is also used for the "pitcher" and "catcher" in baseball; for a collection of utensils, primarily of hammered copper or brass, especially in the French term *batterie de cuisine*; and for the instruments of percussion in an orchestra.

Electric Battery.—This term was applied by the old electricians to a collection of Leyden jars, but is now used of a device for generating electricity by chemical action, or more exactly, of a number of such devices joined up together. There are two main classes of electric battery. In *primary* batteries, composed of a number of galvanic or voltaic "cells," "couples" or "elements," on the completion of the interactions between the substances on which the production of electricity depends, the activity of the cells comes to an end, and can only be restored with the aid of

a fresh supply of those substances; in *secondary* batteries, also called storage batteries or accumulators (*q.v.*), the substances after the exhaustion of the cells can be brought back to a condition in which they will again yield an electric current, by means of an electric current passed through them in the reverse direction. The first primary battery was constructed about 1799 by Alessandro Volta. In one form, the "voltaic pile," he placed a series of pairs of copper and zinc disks one above the other, separating each pair from the one above it by a piece of cloth moistened with a solution of common salt. In another form, the "couronne de tasses," he took a number of vessels or cells containing brine or dilute acid, and placed in each a zinc plate and a copper plate; these plates were not allowed to touch each other within the vessels, but each zinc plate was connected to the copper plate of the adjoining vessel. In both these arrangements an electric current passes through a wire which is connected to the terminal plates at the two ends of the series. The direction of this current is from copper to zinc; within each cell itself it is from zinc to copper. The plate to which the current flows within the cell is the *negative plate*, and that from which it flows the *positive plate*; but the point on the negative plate at which the current enters the external wire is the *positive pole*, and the point on the positive plate at which it leaves the external circuit the *negative pole*. During the time that the external connexion is maintained between the two poles and the current passes in the wire, the zinc or positive plates are gradually dissolved, and hydrogen gas is liberated at the surface of the copper or negative plates; but when the external connexion is broken this action ceases. If the materials used in the cells were perfectly pure, probably the cessation would be complete. In practice, however, only impure commercial zinc is available, and with this corrosion continues to some extent, even though the external circuit is not closed, thus entailing waste of material. This "local action" is explained as due to the fact that the impurities in the zinc plate form miniature voltaic couples with the zinc itself, thus causing its corrosion by voltaic action; and an early improvement in the voltaic cell was the discovery, applied by W. Sturgeon in 1830, that the evil was greatly reduced if the surface of the zinc plates was amalgamated, by being rubbed with mercury under dilute sulphuric acid. Another disadvantage of the simple cell composed of copper and zinc in dilute acid is that the current it yields rapidly falls off. The hydrogen formed by the operation of the cell does not all escape, but some adheres as a film to the negative plate, and the result is the establishment of a counter or reverse electromotive force which opposes the main current flowing from the zinc plate and diminishes its force. This phenomenon is known as "polarization," and various remedies have been tried for the evils it introduces in the practical use of primary batteries. Alfred Smee in 1839 modified the simple copper-zinc couple excited by dilute sulphuric acid by substituting for the copper thin leaves of platinum or platinumized silver, whereby the elimination of the hydrogen is facilitated; and attempts have also been made to keep the plates free from the gas by mechanical agitation. The plan usually adopted, however, is either to prevent the formation of the film, or to introduce into the cell some "depolarizer" which will destroy it as it is formed by oxidizing the hydrogen to water (see also *ELECTROLYSIS*).

The former method is exemplified in the cell invented by J. F. Daniell in 1836. Here the zinc stands in dilute sulphuric acid (or in a solution of zinc sulphate), and the copper in a saturated solution of copper sulphate, the two liquids being separated by a porous partition. The hydrogen formed by the action of the cell replaces copper in the copper sulphate, and the displaced copper, instead of the hydrogen, being deposited on the copper plate polarization is avoided. The electromotive force is about one volt. This cell has been constructed in a variety of forms to suit different purposes: In a portable form, designed by Lord Kelvin in 1858, the copper plate, soldered to a gutta-percha covered wire, is placed at the bottom of a glass vessel and covered with crystals of copper sulphate; over these wet sawdust is sprinkled, and then more sawdust, moistened with

solution of zinc sulphate, upon which is placed the zinc plate. The Minotto cell is similar, except that sand is substituted for sawdust. In these batteries the sawdust or sand takes the place of the porous diaphragm. In another class of batteries the diaphragm is dispensed with altogether, and the action of gravity alone is relied upon to retard the interdiffusion of the liquids. The cell of J. H. Meidinger, invented in 1859, may be taken as a type of this class. The zinc is formed into a ring which fits the upper part of a glass beaker filled with zinc sulphate solution. At the bottom of the beaker is placed a smaller beaker, in which stands a ring of copper with an insulated connecting wire. The mouth of the beaker is closed by a lid with a hole in the centre, through which passes the long tapering neck of a glass balloon filled with crystals of copper sulphate; the narrow end of this neck dips into the smaller beaker, the copper sulphate slowly runs out, and being specifically heavier than the zinc sulphate it collects at the bottom about the copper ring. In Lord Kelvin's tray-cell a large wooden tray is lined with lead, and is covered at the bottom with copper by electrotyping. The zinc plate is enveloped in a piece of parchment paper bent into a tray shape, the whole resting on little pieces of wood placed on the bottom of the leaden tray. Copper sulphate is fed in at the edge of the tray and zinc sulphate is poured upon the parchment. A battery is formed by arranging the trays in a stack one above the other.

Various combinations have been devised in which the hydrogen is got rid of more or less completely by oxidation. Sir W. R. Grove in 1839 employed nitric acid as the oxidizing agent, his cell consisting of a zinc positive plate in dilute sulphuric acid, separated by a porous diaphragm of unglazed earthenware from a platinum negative immersed in concentrated nitric acid. Its electromotive force is nearly two volts, but it has the objection of giving off disagreeable nitrous fumes. R. W. von Bunsen modified Grove's cell by replacing the platinum with the much cheaper material, gas carbon. Chromic acid is much used as a depolarizer, and cells in which it is employed are about as powerful as, and more convenient than, either of the preceding. In its two-fluid form the chromic acid cell consists of a porous pot containing amalgamated zinc in dilute sulphuric acid, and a carbon plate surrounded with sulphuric acid and a solution of potassium or sodium bichromate or of chromic acid. But it is commonly used in a one-fluid form, the porous pot being dispensed with, and both zinc and carbon immersed in the chromic acid solution. Since the zinc is dissolved even when the circuit is not closed, arrangements are frequently provided by which either the zinc plate alone or both plates can be lifted out of the solution when the cell is not in use. In preparing the solution the sodium salt is preferable to the potassium, and chromic acid to either. In the cell devised by Georges Leclanché in 1868 a solid depolarizer is employed, in the shape of manganese dioxide packed with fragments of carbon into a porous pot round a carbon plate. A zinc rod constitutes the positive plate, and the exciting fluid is a solution of sal-ammoniac. Sometimes no porous pot is employed, and the manganese dioxide and granulated carbon are agglomerated into a solid black round the carbon plate. The electromotive force is about one and a half volt. The cell is widely used for such purposes as ringing electric bells, where current is required intermittently, and for such service it will remain effective for months or years, only needing water to be added to the outer jar occasionally to replace loss by evaporation. On a closed circuit the current rapidly falls off, because the manganese dioxide is unable to oxidize all the hydrogen formed, but the cell quickly recovers after polarization. The so-called "dry cells," which came into considerable use towards the end of the 19th century, are essentially Leclanché cells in which the solution is present, not as a liquid, but as a paste formed with some absorbent material or gelatinized. Black oxide of copper is another solid depolarizer, employed in the Lalande cell. In the Edison-Lalande form the copper oxide is suspended in a light copper frame. The exciting solution consists of one part of caustic soda dissolved in three parts by weight of water, and to prevent it from being acted on by the

carbonic acid of the air it is covered with a layer of petroleum oil. Sodium zincate, which is soluble, is formed by the action of the cell, and the hydrogen produced is oxidized by oxygen from the copper oxide. The electromotive force may be about one volt initially, but in practice only about three-quarters of a volt can be relied on.

Primary cells form a convenient means of obtaining electricity for laboratory experiments, and for such light services as working telegraphs, bells, &c.; but as a source of the heavy currents required for electric lighting and traction they are far too expensive in operation, apart from other considerations, to compete with dynamo-electric machinery driven by steam or water power. Certain forms, known as "standard cells," are also used in electrical measurements as standards of electromotive force (see POTENTIOMETER).

See W. R. Cooper, *Primary Batteries* (London, 1901); Park Benjamin, *The Voltaic Cell* (New York, 1893); W. E. Ayrton, *Practical Electricity* (London, 1896).

BATTEUX, CHARLES (1713-1780), French philosopher and writer on æsthetics, was born near Vouziers (Ardennes), and studied theology at Reims. In 1739 he came to Paris, and after teaching in the colleges of Lisieux and Navarre, was appointed to the chair of Greek and Roman philosophy in the Collège de France. In 1746 he published his treatise *Les Beaux-Arts réduits à un même principe*, an attempt to find a unity among the various theories of beauty and taste, and his views were widely accepted. The reputation thus gained, confirmed by his translation of Horace (1750), led to his becoming a member of the Académie des Inscriptions (1754) and of the French Academy (1761). His *Cours de belles lettres* (1765) was afterwards included with some minor writings in the large treatise, *Principes de la littérature* (1774). The rules for composition there laid down are, perhaps, somewhat pedantic. His philosophical writings were *La Morale d'Épicure tirée de ses propres écrits* (1758), and the *Histoire des causes premières* (1769). In consequence of the freedom with which in this work he attacked the abuse of authority in philosophy, he lost his professorial chair. His last and most extensive work was a *Cours d'études à l'usage des élèves de l'école militaire* (43 vols.). In the *Beaux-Arts*, Batteux developed a theory which is derived from Locke through Voltaire's sceptical sensualism. He held that Art consists in the faithful imitation of the beautiful in nature. Applying this principle to the art of poetry, and analysing, line by line and even word by word, the works of great poets, he deduced the law that the beauty of poetry consists in the accuracy, beauty and harmony of individual expression. This narrow and pedantic theory had at least the merit of insisting on propriety of expression. His *Histoire des causes premières* was among the first attempts at a history of philosophy, and in his work on Epicurus, following on Gassendi, he defended Epicureanism against the general attacks made against it.

See DACIER et DUPUY, "Éloges," in *Mémoires de l'Académie des Inscriptions*.

BATHYÁNY, LOUIS (LAJOS), COUNT (1806-1849), Hungarian statesman, was born at Pressburg in 1806. He supplied the defects of an indifferent education while serving in garrison in Italy as a lieutenant of hussars, and thenceforward adopted all the new ideas, economical and political. According to Széchenyi, he learnt much from a German tutor of the radical school, but it was not till after his marriage with the noble-minded and highly-gifted countess Antonia Zichy that he began working earnestly for the national cause. When Széchenyi drew nearer to the court in 1839-1840, Bathyány became the leader of the opposition in the Upper House, where his social rank and resolute character won for him great influence. Despite his "sardanapalian inclinations," he associated himself unreservedly with the extremists, and spent large sums for the development of trade and industry. In 1847 he fiercely opposed the government, procured the election of Kossuth as the representative of Pest, took part in the Great Deputation of the 15th of March, and on the 31st of March 1848 became the first constitutional prime-minister of Hungary. His position became extremely difficult when Jellachich and the Croats took up arms. Convinced that the rigid maintenance of the constitution

was the sole panacea, he did his utmost, in his frequent journeys to Innsbruck, to persuade the court to condemn Jellachich and establish a strong national government at Pest. Unfortunately, however, he was persuaded to consent to the despatch of Magyar troops to quell the Italian rising, before the Croat difficulty had been adjusted, and thenceforth, despite his perfect loyalty, and his admirable services as Honvéd minister in organizing the national forces, his authority in Hungary declined before the rising star of Kossuth. When Jellachich invaded Hungary, Bathyány resigned with the intention of forming a new ministry excluding Kossuth, but this had now become impossible. Then Bathyány attempted to mediate between the two extreme parties, and subsequently raised a regiment from among his peasantry and led them against the Croats. On the 11th of October he was incapacitated for active service by a fall from his horse which broke his arm. On his recovery he returned to Pest, laboured hard to bring about peace, and was a member of the deputation from the Hungarian diet to Prince Windschgrätz, whom the Austrian commander refused to receive. A few days later (8th of January 1849) he was arrested at Pest. As a magnate he was only indictable by the grand justiciary, as a minister he was responsible to the diet alone. At Laibach, whither he was taken, he asked that Deák might be his advocate, but this being refused he wrote his own defence. Sentence of hanging was finally pronounced upon him at Olmütz for violating the Pragmatic Sanction, overthrowing the constitution, and aiding and abetting the rebellion. To escape this fate he stabbed himself with a small concealed dagger, and bled to death in the night of the 5th of October 1849.

See BERTALAN SZEMERE, *Bathyányi, Kossuth, Görgei* (Ger.) (Hamburg, 1853). (R. N. B.)

BATTICALOA, the provincial capital of the eastern province of Ceylon, on the E. coast, 60 m. S.S.E. of Trincomalee, situated on an island in lat. 7° 44' N. and long. 81° 52' E. It is of importance for its haven and the adjacent salt lagoons. The population of the town in 1901 was 9069; of the district (287 sq. m.) 145,161. The old Dutch fort dates from 1682. Batticaloa is the seat of a government agent and district judge; criminal sessions of the supreme court are also held. Rice and coconuts are the two staples of the district, and steamers trading round the island call regularly at the port. The lagoon is famous for its "singing fish," supposed to be shell-fish which give forth musical notes. The district has a remnant of Veddahs or wild men of the wood. The average annual rainfall is 55½ in.; the average temperature 80.4° F.

BATTISHILL, JONATHAN (1738-1801), one of the best 18th century English composers of church music. Until 1764 he wrote chiefly for the theatre (incidental songs, pantomime music, and an opera in collaboration with Michael Arne, the son of Thomas Arne), but his later compositions are chiefly glees, part-songs and church music. In 1763 he had married a singer at Covent Garden theatre where he was harpsichordist. She retired from her profession when she married; and her death in 1777 so crushed him that he composed no more.

BATTLE, a market-town in the Rye parliamentary division of Sussex, England, 54½ m. S.E. by S. from London by the South Eastern & Chatham railway. Pop. of urban district (1901) 2096. It is pleasantly situated in an undulating well-wooded district, 7 m. from the sea at Hastings. Its name is derived from the conflict in 1066, which insured to William the Norman the crown of England (see also **BATTLE ABBEY ROLL**). Before the battle, in which King Harold fell, William vowed to build an abbey on the spot if he should prove victorious, and in 1004 the consecration took place with great pomp. The gate-house, forming a picturesque termination to the main street of the town, is Decorated; and there also remain parts of the foundations of the Norman church, of the Perpendicular cloisters, and of the Early English refectory. A mansion occupies part of the site, and incorporates some of the ancient building. The church of St. Mary is of various dates, the earliest portions being transitional Norman.

See *Chronicles of Battle Abbey*, 1066-1176. translated, &c., by M. A. Lower (London, 1851).

BATTLE, a general engagement between the armed forces, naval or military, of enemies. The word is derived from the Fr. *bataille*, and this, like the Ital. *battaglia*, and Span. *batalla*, comes from the popular Lat. *battalia* for *battualia*. Cassiodorus Senator (480-?575) says: *Battualia quae vulgo Batalia dicuntur . . . exercitationes militum vel gladiatorum significant* (see Du Cange, *Glossarium*, s.v. *Batalia*). The verb *battiere*, cognate with "beat," is a rare word, found in Pliny, used of beating in a mortar or of beat before cooking. Suetonius (*Caligula*, 54. 32) uses it of fencing, *battuebat puginatoris armis*, i.e. not with blunted weapons or foils. *Battalia* or *batavia* was used for the array of troops for battle, and hence was applied to the body of troops so arranged, or to a division of an army, whence the use of the word "battalion" (*q.v.*).

A "pitched battle," loosely used as meaning almost a decisive engagement, is strictly, as the words imply, one that is fought on ground previously selected ("pitched" meaning arranged in a fixed order) and in accordance with the intentions of the commanders of both sides; the French equivalent is *bataille arrangée*, opposed to *bataille manœuvrée*, which is prearranged but may come off on any ground. With "battle," in its usual meaning of a general engagement of hostile forces, are contrasted "skirmish," a fight between small bodies ("skirmishing" technically means fighting by troops in extended or irregular order), and "action," a more or less similar engagement between large bodies of troops. (See also TACTICS and STRATEGY.)

BATTLE ABBEY ROLL. This is popularly supposed to have been a list of William the Conqueror's companions preserved at Battle Abbey, on the site of his great victory over Harold. It is known to us only from 16th century versions of it published by Leland, Holinshed and Duchesne, all more or less imperfect and corrupt. Holinshed's is much the fullest, but of its 629 names several are duplicates. The versions of Leland and Duchesne, though much shorter, each contain many names found in neither of the other lists. It was so obvious that several of the names had no right to figure on the roll, that Camden, as did Dugdale after him, held them to have been interpolated at various times by the monks, "not without their own advantage." Modern writers have gone further, Sir Egerton Brydges denouncing the roll as "a disgusting forgery," and E. A. Freeman dismissing it as "a transparent fiction." An attempt to vindicate the roll was made by the last duchess of Cleveland, whose *Battle Abbey Roll* (3 vols., 1889) is the best guide to its contents.

It is probable that the character of the roll has been quite misunderstood. It is not a list of individuals, but only of family surnames, and it seems to have been intended to show which families had "come over with the Conqueror," and to have been compiled about the 14th century. The compiler appears to have been influenced by the French sound of names, and to have included many families of later settlement, such as that of Grandson, which did not come to England from Savoy till two centuries after the Conquest. The roll itself appears to be unheard-of before and after the 16th century, but other lists were current at least as early as the 15th century, as the duchess of Cleveland has shown. In 1866 a list of the Conqueror's followers, compiled from Domesday and other authentic records, was set up in Dives church by M. Leopold Delisle, and is printed in the duchess' work. Its contents are naturally sufficient to show that the Battle Roll is worthless.

See Leland, *Collectanea*; Holinshed, *Chronicles of England*; Duchesne, *Historia Norm. Scriptores*; Brydges, *Censura Literaria*; Thierry, *Conquête de l'Angleterre*, vol. ii. (1829); Burke, *The Roll of Battle Abbey* (annotated, 1848); Planché, *The Conqueror and His Companions* (1874); duchess of Cleveland, *The Battle Abbey Roll* (1889); Round, "The Companions of the Conqueror" (*Monthly Review*, 1901, iii. pp. 91-111). (J. H. R.)

BATTLE CREEK, a city of Calhoun county, Michigan, U.S.A., at the confluence of the Kalamazoo river with Battle Creek, about 48 m. S. of Grand Rapids. Pop. (1890) 13,197; (1900) 18,563,

¹ This is the same word as "scrimmage," and is derived from the Anglo-French *eskrimir*, modern *escrimer*, properly to fight behind cover, now to fence. The origin of this is the Old High German *scirman*, to fight behind a shield, *scirm*, Modern German *Schirm*.

of whom 1844 were foreign-born; (1910, census) 25,267. It is served by the Michigan Central and the Grand Trunk railways, and by interurban electric lines. Here are the hospital and laboratories of the American Medical Missionary College (of Chicago) and the Battle Creek Sanitarium, established in 1866, which was a pioneer in dietetic reform, and did much to make Battle Creek important in the manufacture of health foods, and in the publication of diet-reform literature. Among the principal buildings, besides the hospital and the sanitarium, are several fine churches, the central high school, the Post tavern and the Post theatre. The city is a trading centre for the rich agricultural and fruit-growing district by which it is surrounded, has good water-power, and is an important manufacturing centre, its chief manufactured products being cereal health foods, for which it has a wide reputation, and the manufacture of which grew out of the dietetic experiments made in the laboratories of the sanitarium; and threshing machines and other agricultural implements, paper cartons and boxes, flour, boilers, engines and pumps. Extensive locomotive and car shops of the Grand Trunk railway are here. In 1904 the total factory product of Battle Creek was valued at \$12,208,244, an increase of 95% over that for 1900; and of the total in 1904 \$5,101,055 was the value of food preparations, which was 8.5% of the value of food preparations manufactured in the United States, Battle Creek thus ranking first among American cities in this industry. The water-works are owned and operated by the municipality, the water being obtained from Lake Gogouac, a summer pleasure resort about 2 m. from the city. Battle Creek, said to have been named from hostilities here between some surveyors and Indians, was settled in 1831, incorporated as a village in 1850, and chartered as a city in 1859, the charter of that year being revised in 1900.

BATTLEDORE AND SHUTTLECOCK, a game played by two persons with small rackets, called battledores, made of parchment or rows of gut stretched across wooden frames, and shuttlecocks, made of a base of some light material, like cork, with trimmed feathers fixed round the top. The object of the players is to bat the shuttlecock from one to the other as many times as possible without allowing it to fall to the ground. There are Greek drawings extant representing a game almost identical with battledore and shuttlecock, and it has been popular in China, Japan, India and Siam for at least 2000 years. In Europe it has been played by children for centuries. A further development is Badminton.

BATTLEMENT (probably from a lost Fr. form *bastillement*, cf. mod. Fr. *bastille*, from Med. Lat. *bastilia*, towers, which is derived from Ital. *bastire*, to build, cf. Fr. *bâtir*; the English word was, however, early connected with "battle"), a term given to a parapet of a wall, in which portions have been cut out at intervals to allow the discharge of arrows or other missiles; these cut-out portions are known as "crenels"; the solid widths between the "crenels" are called "merlons." The earliest example in the palace at Medinet-Abu at Thebes in Egypt is of the inverted form, and is said to have been derived from Syrian fortresses. Through Assyria they formed the termination of all the walls surrounding the towns, as shown on bas reliefs from Nimrud and elsewhere. Traces of them have been found at Mycenae, and they are suggested on Greek vases. In the battlements of Pompeii, additional protection was given by small internal buttresses or spur walls against which the defender might place himself so as to be protected completely on one side. In the battlements of the middle ages the crenel was about one-third of the width of the merlon, and the latter was in addition pierced with a small slit. The same is also found in Italian battlements, where the merlon is of much greater height and is capped in a peculiar fashion. The battlements of the Mahomedans had a more decorative and varied character, and were retained from the 13th century onwards not so much for defensive purposes as for a crowning feature to their walls. They may be regarded therefore in the same light as the cresting found in the Spanish renaissance. The same retention of the battlement as a purely decorative feature is found throughout the Decorated and

Perpendicular periods, and not only occurs on parapets but on the transoms of windows and on the tie-beams of roofs and on screens. A further decorative treatment was given in the elaborate panelling of the merlons and that portion of the parapet walls rising above the cornice, by the introduction of quatrefoils and other conventional forms filled with foliage and shields.

BATTLE (from Fr. *battre*, to beat), the beating of game from cover under the sportsmen's fire; by analogy the word is used to describe any slaughter of defenceless crowds.

BATTUS, the legendary founder of the Greek colony of Cyrene in Libya (about 630 B.C.). The Greeks who accompanied him were, like himself, natives of Thera, and descended partly from the race of the Minyae. Various accounts are given both of the founding of Cyrene and of the origin of the founder's name. According to the Cyrenaean (Herod. iv. 150-156), Battus, having an impediment in his speech, consulted the oracle at Delphi, and was told to found a colony in Libya; according to the Theraeans, Battus was entrusted with this mission by their aged king Grinus. In another version, there was civil war in Thera; Battus, leader of one party, was banished, and, on applying to the oracle, was recommended to take out a colony to "the continent" (Schol. Pindar, *Pyth.* iv. 10). In any case the foundation is attributed to the direct instructions of Apollo. The name was connected by some with *βαρραπίτε*, ("stammer"), but Herodotus (iv. 155) says that it was the Libyan word for "king," that Battus was not called by the name until after his arrival at Libya, and that the oracle addressed him as "Battus" by anticipation. This, however, would imply on the part of the oracle a knowledge of Libya, which was not shared by the rest of Greece (Herod. *l.c.*), and it is noteworthy that the name occurs in Arcadian and Messenian legends. Herodotus does not know his real name, but Pindar (*Pyth.* v. 116), no doubt rightly, calls the founder of the colony Aristoteles, while Justin (xiii. 7) gives his name as Aristaeus who was worshipped at Cyrene. Four kings named Battus, alternating with four named Arceilaus, ruled in Cyrene (*q.v.*) till the fall of the dynasty about 450 B.C.

See R. W. Macan's *Herodotus IV.-VI.* (1895), vol. i. pp. 104 seq. and notes.

BATU, or **ROCK ISLANDS** (Dutch *Batoe*), a group of three greater and forty-eight lesser islands in the Dutch East Indies, W. of Sumatra, between 0° 10' N. to 0° 45' S. and 97° 50'-98° 35' E., belonging to the Aeyrangi district of the lowlands of Padang (Sumatra). They are separated by the strait of Sibirut from the Mentawai group. The three chief islands, from N. to S., are Pini or Mintao, Masa, and Bala. The total land area of the group is 445 sq. m. The islands are generally low, and covered with forest, in which the cocoanut palm is conspicuous. There is trade in coconuts, oil, and other forest produce. The natives, about 3000 in number, are of Malayan or pre-Malayan stock, akin to those of the island of Nias to the north-west. Only about twenty of the smaller islands are inhabited.

BATUM, a seaport of Russian Transcaucasia, in the government of and 90 m. by rail S.W. of the city of Kutais, on the S.E. shore of the Black Sea, in 41° 30' N. and 41° 38' E. Pop. (1875) 2000; (1900) 28,512, very mixed. The bay is being filled up by the sand carried into it by several small rivers. The town is protected by strong forts, and the anchorage has been greatly improved by artificial works. Batum possesses a cathedral, finished in 1903, and the Alexander Park, with sub-tropical vegetation. The climate is very warm, lemon and orange trees, magnolias and palms growing in the open air; but it is at the same time extremely wet and changeable. The annual rainfall (90 in.) is higher than anywhere in Caucasia, but it is very unequally distributed (23 in. in August and September, sometimes 16 in. in a couple of days), and the place is still most unhealthy. The town is connected by rail with the main Transcaucasia railway to Tiflis, and is the chief port for the export of naphtha and paraffin oil, carried either in great part through pipes laid down from Baku, but partly also in tank railway-cars; other exports are wheat, manganese, wool, silk-worm-cocoons,

liquorice, maize and timber (total value of exports nearly 5½ millions sterling annually). The imports, chiefly tin plates and machinery, amount to less than half that total. Known as Bathys in antiquity, as Vati in the middle ages, and as Bathumi since the beginning of the 17th century, Batum belonged to the Turks, who strongly fortified it, down to 1878, when it was transferred to Russia. In the winter of 1905-1906 Batum was in the hands of the revolutionists, and a "reign of terror" lasted for several weeks.

BATWA, a tribe of African pygmies living in the mountainous country around Wissmann Falls in the Kasai district of the Belgian Congo. They were discovered in 1880 by Paul Pogge and Hermann von Wissmann, and have been identified with Sir H. M. Stanley's Vouatouas. They are typical of the negro family south of the Congo. They are well made, with limbs perfectly proportioned, and are seldom more than 4 ft. high. Their complexion is a yellow-brown, much lighter than their Bantu-Negroid neighbours. They have short woolly hair and no beard. They are feared rather than despised by the Baluba and Kabuba tribes, among whom they live. They are nomads, cultivating nothing, and keeping no animals but a small type of hunting-dog. Their weapon is a tiny bow, the arrows for which are usually poisoned. They build themselves temporary huts of a bee-hive shape. As hunters they are famous, bounding through the jungle growth "like grasshoppers" and fearlessly attacking elephants and buffalo with their tiny weapons. Their only occupation apart from hunting is the preparation of palm-wine which they barter for grain with the Baluba. They are monogamous and display much family affection. See further *PYGMY*; *AKKA*; *WOCHUA*; *BAMBUET*.

See A. de Quatrefages, *The Pygmies* (Eng. ed., 1895); Sir H. H. Johnston, *Uganda Protectorate* (1902); Hermann von Wissmann, *My Second Journey through Equatorial Africa* (London, 1891).

BATYPHONE (Ger. and Fr. *Batyphon*), a contrabass clarinet which was the outcome of F. W. Wieprecht's endeavour to obtain a contrabass for the reed instruments. The batyphone was made to a scale twice the size of the clarinet in C, the divisions of the chromatic scale being arranged according to acoustic principles. For convenience in stopping holes too far apart to be covered by the fingers, crank or swivel keys were used. The instrument was constructed of maple-wood, had a clarinet mouthpiece of suitable size connected by means of a cylindrical brass crook with the upper part of the tube, and a brass bell. The pitch was two octaves below the clarinet in C, the compass being the same, and thus corresponding to the modern bass tuba. The tone was pleasant and full, but not powerful enough for the contrabass register in a military band. The batyphone had besides one serious disadvantage: it could be played with facility only in its nearly related keys, G and F major. The batyphone was invented and patented in 1830 by F. W. Wieprecht, director general of all the Prussian military bands, and E. Skorra, the court instrument manufacturer of Berlin. In practice the instrument was found to be of little use, and was superseded by the bass tuba. A similar attempt was made in 1843 by Adolphe Sax, and met with a similar fate.

A batyphone bearing the name of its inventors formed part of the Snoeck collection which was acquired for Berlin's collection of ancient musical instruments at the Technische Hochschule für Musik. The description of the batyphone given above is mainly derived from a MS. treatise on instrumentation by Wieprecht, in 1900 in the possession of Herr Otto Lessmann (Berlin), and reproduced by Capt. C. R. Day, in *Descriptive Catalogue of the Musical Instruments of the Royal Military Exhibition, London, 1890* (London, 1891), p. 124. (K. S.)

BAUAN (or **BAUN**), a town of the province of Batangas, Luzon, Philippine Islands, at the head of Batangas Bay, about 54 m. S. of Manila. Pop. (1903) 39,094. A railway to connect the town with Manila was under construction in 1908. Bauan has a fine church and is known as a market for "sinamay" or hemp cloth, the hemp and cotton being imported and dyed and woven by the women in their homes. Palm-fibre mats and hats, fans, bamboo baskets and cotton fish-nets are woven here. There is

excellent fishing in the bay. Hogs and horses are raised for the Manila market. The surrounding country is fertile and grows cacao, indigo, oranges, sugar-cane, corn and rice. The language is Tagalog.

BAUBLE (probably a blend of two different words, an old French *baubel*, a child's plaything, and an old English *babyll*, something swinging to and fro), a word applied to a stick with a weight attached, used in weighing, to a child's toy, and especially to the mock symbol of office carried by a court jester, a baton terminating in a figure of Folly with cap and bells, and sometimes having a bladder fastened to the other end; hence a term for any triviality or childish folly.

BAUCHI, a province in the highlands of the British protectorate of Northern Nigeria. It lies approximately between $11^{\circ} 15'$ and $9^{\circ} 15'$ N. and $11^{\circ} 15'$ and $8^{\circ} 30'$ E. Bauchi is bounded N. by the provinces of Kano, Katagum and Bornu; E. by Bornu, S. by Yola and Muri, and W. by the provinces of Zaria and Nassarawa. The province has an area of about 21,000 sq. m. The altitude rises from 1000 ft. above the sea in its north-eastern corner to 4000 ft. and 6000 ft. in the south-west. The province is traversed diagonally from N.E. to S.W. by a belt of mountain ranges alternating with fertile plateaus. Towards the south the country is very rugged and a series of extinct volcanic craters occur.

Amongst the more important plateaus are the Assab or Kibyen country, having a general level of upwards of 4000 ft., and the Sura country, also reaching to elevations of from 3000 to 5000 ft. Both these extensive plateaus are situated in the south-west portion of the province. Their soil is fertile, they possess an abundance of pure water, the air is keen and bracing, and the climate is described as resembling in many respects that of the Transvaal. They form the principal watershed not only of the province of Bauchi, but of the protectorate of Northern Nigeria. The Gongola, flowing east and south to the Benue, rises in the Sura district, and from the Kibyen plateau streams low north to Lake Chad, west to the Kaduna, and south to the Benue. The soil is generally fertile between the hills, and in the volcanic districts the slopes are cultivated half-way up the extinct craters. The climate in the western parts is temperate and healthy. In the winter months of November and December the thermometer frequently falls to freezing-point, and in the hottest months the maximum on the Kibyen plateau has been found to be rarely over 85° .

The population of Bauchi is estimated at about 1,000,000 and is of a very various description. The upper classes are Fula, and there are some Hausa and Kanuri (Bornuese), but the bulk of the people are pagan tribes in a very low state of civilization. Sixty-four tribes sufficiently differentiated from each other to speak different languages have been reported upon. Hausa is the *lingua franca* of the whole. The pagan population has been classified for practical purposes as Hill pagans and Plains pagans, Mounted pagans and Foot pagans. The Foot pagans of the plains were brought under the Fula yoke in the beginning of the 19th century and have never cast it off. The Hill pagans were partly conquered, but many remained independent or have since succeeded in asserting their freedom. The Mounted pagans are confined to the healthy plateaus of the south-west corner of the province. They are independent and there is considerable variety in the characteristics of the different tribes. The better types are hardy, orderly and agriculturally industrious. They are intelligent and have shown themselves peaceful and friendly to Europeans. Others are, on the contrary, disposed to be turbulent and warlike. Amongst the different tribes many are cannibals. They all go practically naked. They are essentially horsemen, and have a cruel habit of gashing the backs of their ponies that they may get a good seat in the blood. They are armed with bows and arrows, but depend almost entirely in battle on the charges of their mounted sparmen.

The native name "Bauchi," which is of great antiquity, signifies the "Land of Slaves," and from the earliest times the uplands which now form the principal portion of the province have been the hunting ground of the slave-raider, while the hill

fastnesses have offered defensible refuge to the population. So entirely was slavery a habit of the people, that as late as 1905, after the slave-trade had been abolished for three years, it was found that, in consequence of a famine which rendered food difficult to obtain, a whole tribe (the Tangali) were selling themselves as slaves to their neighbours. Children are readily sold by their parents at a price varying from the equivalent of one shilling to one and sixpence.

The province of Bauchi was conquered by the Fula at the beginning of the 19th century, and furnished them with a valuable slave preserve. But the more civilized portion had already, under enlightened native rulers, attained to a certain degree of prosperity and order. Mahomedanism was partly adopted by the upper classes in the 18th century, if not earlier, and the son of a Mahomedan native ruler, educated at Sokoto, accepted the flag of Dan Fodio and conquered the country for the Fula. The name of this remarkable soldier and leader was Yakoba (Jacob). His father's name was Daouad (David), and his grandfather was Abdullah, all names which indicate Arab or Mahomedan influence. The town of Bauchi and capital of the province was founded by Yakoba in the year 1809, and the emirate remained under Fula rule until the year 1902. In that year, in consequence of determined slave-raiding and the defiant misrule of the emir, a British expedition was sent against the capital, which submitted without fighting. The emir was deposed, and the country was brought under British control. A new emir was appointed, but he died within a few months. The slave-trade was immediately abolished, and the slave-market which was held at Bauchi, as in all Fula centres, was closed. The Kano-Sokoto campaign in 1903 rendered necessary a temporary withdrawal of the British resident from Bauchi, and comparatively little progress was made until the following year. In 1904 the province was organized for administration on the same system as the rest of Northern Nigeria, and the reigning emir took the oath of allegiance to the British crown. The province has been subdivided into thirteen administrative districts, which again have been grouped into their principal divisions, with their respective British headquarters at Bauchi, Kanan and Bukuru. The Fula portion of this province, held like the other Hausa states under a feudal system of large landowners or fief-holders, has been organized and assessed for taxation on the system accepted by the emirs throughout the protectorate, and the populations are working harmoniously under British rule. Roads and telegraphs are in process of construction, and the province is being gradually opened to trade. Valuable indications of tin have been found to the north of the Kibyen plateau, and have attracted the attention of the Niger Company.

Bauchi is a province of special importance from the European point of view because, with free communication from the Benue assured, it is probable that on the Kibyen and Sura plateaus, which are the healthiest known in the protectorate, a sanatorium and station for a large civil population might be established under conditions in which Europeans could live free from the evil effects of a West African climate.

The emirate of Gombe, which is included in the first division of the Bauchi province, is a Fula emirate independent of the emirs of Bauchi. It forms a rich and important district, and its chiefs held themselves in a somewhat sullen attitude of hostility to the British. It was at Burmi in this district that the last stand was made by the religious following of the defeated sultan of Sokoto, and here the sultan was finally overthrown and killed in July 1903. Gombe has now frankly accepted British rule.

(F. L. L.)

BAUDELAIRE, CHARLES PIERRE (1821-1867), French poet, was born in Paris on the 9th of April 1821. His father, who was a civil servant in good position and an amateur artist, died in 1827, and in the following year his mother married a lieutenant-colonel named Aupick, who was afterwards ambassador of France at various courts. Baudelaire was educated at Lyons and at the Collège Louis-le-Grand in Paris. On taking his degree in 1839 he determined to enter on a literary career, and during the next two years pursued a very irregular way of life, which led his

guardians, in 1841, to send him on a voyage to India. When he returned to Paris, after less than a year's absence, he was of age; but in a year or two his extravagance threatened to exhaust his small patrimony, and his family obtained a decree to place his property in trust. His salons of 1845 and 1846 attracted immediate attention by the boldness with which he propounded many views then novel, but since generally accepted. He took part with the revolutionaries in 1848, and for some years interested himself in republican politics but his permanent convictions were aristocratic and Catholic. Baudelaire was a slow and fastidious worker, and it was not until 1857 that he produced his first and famous volume of poems, *Fleurs du mal*. Some of these had already appeared in the *Revue des deux mondes* when they were published by Baudelaire's friend Auguste Poulet Malassis, who had inherited a printing business at Alençon. The consummate art displayed in these verses was appreciated by a limited public, but general attention was caught by the perverse selection of morbid subjects, and the book became a by-word for unwholesomeness among conventional critics. Victor Hugo, writing to the poet, said, "Vous dotez le ciel de l'art d'un rayon macabre, vous créez un frisson nouveau." Baudelaire, the publisher, and the printer were successfully prosecuted for offending against public morals. The obnoxious pieces were suppressed, but printed later as *Les Épaves* (Brussels, 1866). Another edition of the *Fleurs du mal*, without these poems, but with considerable additions, appeared in 1861.

Baudelaire had learnt English in his childhood, and had found some of his favourite reading in the English "Satanic" romances, such as Lewis's *Monk*. In 1846-1847 he became acquainted with the works of Edgar Allan Poe, in which he discovered romances and poems which he, said, long existed in his own brain, but had never taken shape. From this time till 1865 he was largely occupied with his version of Poe's works, producing masterpieces of the art of translation in *Histoires extraordinaires* (1852), *Nouvelles Histoires extraordinaires* (1857), *Adventures d'Arthur Gordon Pym, Eureka, and Histoires grotesques et sérieuses* (1865). Two essays on Poe are to be found in his *Œuvres complètes* (vols. v. and vi.). Meanwhile his financial difficulties grew upon him. He was involved in the failure of Poulet Malassis in 1861, and in 1864 he left Paris for Belgium, partly in the vain hope of disposing of his copyrights. He had for many years a liaison with a coloured woman, whom he helped to the end of his life in spite of her gross conduct. He had recourse to opium, and in Brussels he began to drink to excess. Paralysis followed, and the last two years of his life were spent in *maisons de santé* in Brussels and in Paris, where he died on the 31st of August 1867.

His other works include:—*Petits Poèmes en prose*; a series of art criticisms published in the *Pays, Exposition universelle*; studies on Gustave Flaubert (in *L'Artiste*, 18th of October 1857); on Théophile Gautier (*Revue contemporaine*, September 1858); valuable notices contributed to Eugène Crépet's *Poètes français; Les Paradis artificiels opium et haschisch* (1860); *Richard Wagner et Tannhäuser à Paris* (1861); *Un Dernier Chapitre de l'histoire des œuvres de Balzac* (1880), originally an article entitled "Comment on paye ses dettes quand on du génie," in which his criticism is turned against his friends H. de Balzac, Théophile Gautier, and Gérard de Nerval.

BIBLIOGRAPHY.—An edition of his *Lettres* (1841-1866) was issued by the Soc. du Mercure de France in 1906. His *Œuvres complètes* were edited (1868-1870) by his friend Charles Asselineau, with a preface by Théophile Gautier. Asselineau also undertook a vindication of his character from the attacks made upon it in his *Charles Baudelaire, sa vie, son œuvre* (1869). He left some material of more private interest in a MS. entitled *Baudelaire*. See *Charles Baudelaire, son œuvre, correspondance, bibliographie* (1872), by Charles Cousin and Spœlberch de Lovenjoul; *Charles Baudelaire, œuvres posthumes et correspondances inédites* (1887), containing a journal entitled *Mon cœur mis à nu*, and a biographical study by Eugène Crépet; also *Le Tombeau de Charles Baudelaire* (1896), a collection of pieces unpublished or prohibited during the author's lifetime, edited by S. Mallarmé and others, with a study of the text of the *Fleurs du mal* by Prince A. Ourousof; Féli Gautier, *Charles Baudelaire* (Brussels, 1904), with facsimiles of drawings by Baudelaire himself; A. de la Fitzelière and G. Decaux, *Charles Baudelaire* (1868) in the series of

Essais de bibliographie contemporaine; essays by Paul Bourget, *Essais de psychologie contemporaine* (1883), and Maurice Spronck, *Les Artistes littéraires* (1889). Among English translations from Baudelaire are *Poems in Prose*, by A. Symons (1905), and a selection for the *Canterbury Poets* (1904), by F. P. Sturm.

BAUDIER, MICHEL (c. 1580-1645), French historian, was born in Languedoc. During the reign of Louis XIII. he was historiographer to the court of France. He contributed to French history by writing *Histoire de la guerre de Flandre 1559-1600* (Paris, 1615); *Histoire de l'administration du cardinal d'Amboise, grand ministre d'état en France* (Paris, 1634), a defence of the cardinal; and *Histoire de l'administration de l'abbé Suger* (Paris, 1645). Taking an especial interest in the Turks he wrote *Inventaire général de l'histoire des Turcs* (Paris, 1610); *Histoire générale de la religion des Turcs avec la vie de leur prophète Mahomet* (Paris, 1626); and *Histoire générale du sérail et de la cour du grand Turc* (Paris, 1626; English trans. by E. Grimeston, London, 1635). Having heard the narrative of a Jesuit who had returned from China, Baudier wrote *Histoire de la cour du roi de Chine* (Paris, 1626; English trans. in vol. viii. of the *Collection of Voyages and Travels* of A. and J. Churchill, London, 1707-1747). He also wrote *Vie du cardinal Ximénès* (Paris, 1635), which was again published with a notice of the author by E. Baudier (Paris, 1851), and a curious romance entitled *Histoire de l'incomparable administration de Romieu, grand ministre d'état de Raymond Brénger, comte de Provence* (Paris, 1635).

See J. Lelong, *Bibliothèque historique de la France* (Paris, 1768-1778); L. Moréri, *Le Grand Dictionnaire historique* (Amsterdam, 1740).

BAUDRILLART, HENRI JOSEPH LÉON (1821-1892), French economist, was born in Paris on the 28th of November 1821. His father, Jacques Joseph (1774-1832), was a distinguished writer on forestry, and was for many years in the service of the French government, eventually becoming the head of that branch of the department of agriculture which had charge of the state forests. Henri was educated at the Collège Bourbon, where he had a distinguished career, and in 1852 he was appointed assistant lecturer in political economy to M. Chevalier at the Collège de France. In 1866, on the creation of a new chair of economic history, Baudrillard was appointed to fill it. His first work was an *Éloge de Turgot* (1846), which at once won him notice among the economists. In 1853 he published an erudite work on *Jean Bodin et son temps*; then in 1857 a *Manuel d'économie politique*; in 1860, *Des rapports de la morale et de l'économie politique*; in 1865, *La Liberté du travail*; and from 1878 to 1880, *L'Histoire du luxe . . . depuis l'antiquité jusqu'à nos jours*, in four volumes. At the instance of the Académie des Sciences Morales et Politiques he investigated the condition of the farming classes of France, and published the results in four volumes (1885, et seq.). From 1855 to 1864 he directed the *Journal des économistes*, and contributed many articles to the *Journal des débats* and to the *Revue des deux mondes*. His writings are distinguished by their style, as well as by their profound erudition. In 1863 he was elected member of the Académie des Sciences Morales et Politiques; in 1870 he was appointed inspector-general of public libraries, and in 1881 he succeeded J. Garnier as professor of political economy at the École des Ponts et Chaussées. Baudrillard was made an officer of the Legion of Honour in 1880. He died in Paris on the 24th of January 1892.

BAUDRY, OF BALDERICH, OF BOURGUEIL (1046 or 1047-1130), archbishop of Dol, historian and poet, was born at Meung-sur-Loire, where he passed his early days. Educated at Meung and at Angers, he entered the Benedictine abbey of Bourgueil, and in 1079 became abbot of this place, but his time was devoted to literary pursuits rather than to his official duties. Having failed to secure the bishopric of Orleans in 1097, he became archbishop of Dol in 1107, and went to Rome for his pallium in 1108. The bishopric of Dol had been raised to the rank of an archbishopric during the 10th century by Nomenoé, king of Brittany, but this step had been objected to by the archbishops of Tours. Consequently the position of the see was somewhat ambiguous, and Baudry is referred to both as archbishop and as

bishop of Dol. He appears to have striven earnestly to do something for the education of the ignorant inhabitants of Brittany but his efforts were not very successful, and he soon abandoned the task. In 1116 he attended the Lateran council, and in 1119 the council of Reims, after which he paid a visit of two years' duration to England. Returning to France he neglected the affairs of his diocese, and passed his time mainly at St Samson-sur-Risle in Normandy. He died on the 5th or 7th of January 1130.

Baudry wrote a number of Latin poems of very indifferent quality. The most important of these, from the historical point of view, have been published in the *Historiae Francorum Scriptores*, tome iv., edited by A. Duchesne (Paris 1639-1649). Baudry's prose works are more important. The best known of these is his *Historia Hierosolymitanae*, a history of the first crusade from 1095 to 1099. This is a history in four books, the material for which was mainly drawn from the anonymous *Gesta Francorum*, but some valuable information has been added by Baudry. It was very popular during the middle ages, and was used by Oedericus Vitalis for his *Historia ecclesiastica*; by William, archbishop of Tyre, for his *Belli sacri historia*; and by Vincent of Beauvais for his *Speculum historiarum*. The best edition is that by C. Thurot, which appears in the *Recueil des historiens des croisades*, tome iv. (Paris, 1841-1887). Other works probably by Baudry are *Epistola ad Fiscannenses monachos*, a description of the monastery of Fécamp; *Vita Roberti de Arbrissello*; *Vita S. Hugonis archiepiscopi Rothomagensis*; *Translatio capituli Gemeticum et miracula S. Valentini martyris*; *Relatio de scuto et gladio*, a history of the arms of St. Michael; and *Vita S. Samsonis Dolensis episcopi*. Other writings which on very doubtful authority have been attributed to Baudry are *Acta S. Valeriani martyris Treverorhii*; *De visitatione infirmorum*; *Vita S. Maglorii Dolensis episcopi* et *Vita S. Maclovii, Alectensis episcopi*; *De revelatione abbatum Fiscannensium*; and *Confirmatio bonorum monasterii S. Florentii*. Many of these are published by J. P. Migne in the *Plorentia Latina*, tomes 160, 162 and 166 (Paris 1844).

See *Histoire littéraire de la France*, tome xi. (Paris, 1865-1866); H. von Sybel, *Geschichte des ersten Kreuzzuges* (Leipzig, 1881); A. Thurot, "Études critiques sur les historiens de la première croisade"; Baudry de Bourgueil" in the *Revue historique* (Paris, 1876).

BAUDRY, PAUL JACQUES AIMÉ (1828-1886), French painter, was born at La Roche-sur-Yonne (Vendée). He studied under Drolling, a sound but second-rate artist, and carried off the Prix de Rome in 1850 by his picture of "Zenobia found on the banks of the Araxes." His talent from the first revealed itself as strictly academical, full of elegance and grace, but somewhat lacking originality. In the course of his residence in Italy Baudry derived strong inspiration from Italian art with the mannerism of Coreggio, as was very evident in the two works he exhibited in the Salon of 1857, which were purchased for the Luxembourg: "The Martyrdom of a Vestal Virgin" and "The Child." His "Leda," "St John the Baptist," and a "Portrait of Beulé," exhibited at the same time, took a first prize that year. Throughout this early period Baudry commonly selected mythological or fanciful subjects, one of the most noteworthy being "The Pearl and the Wave." Once only did he attempt an historical picture, "Charlotte Corday after the murder of Marat" (1861); and returned by preference to the former class of subjects or to painting portraits of illustrious men of his day—Guizot, Charles Garnier, Edmond About. The works that crowned Baudry's reputation were his mural decorations, which show much imagination and a high artistic gift for colour, as may be seen in the frescoes in the Paris Cour de Cassation, at the château of Chantilly, and some private residences—the hôtel Fould and hôtel Paiva—but, above all, in the decorations of the foyer of the Paris opera-house. These, more than thirty paintings in all, and among them compositions figurative of dancing and music, occupied the painter for ten years. Baudry died in Paris in 1886. He was a member of the Institut de France, succeeding Jean Victor Schnetz. Two of

his colleagues, Dubois and Marius Jean Mercié, co-operating with his brother, Baudry the architect, erected a monument to him in Paris (1890). The statue of Baudry at La Roche-sur-Yonne (1897) is by Gérôme.

See H. Delaborde, *Notice sur la vie et les ouvrages de Baudry* (1886); Ch. Ephrussi, *Baudry, sa vie et son œuvre* (1887). (H. Fr.)

BAUER, BRUNO (1809-1882), German theologian and historian, was born on the 6th of September 1809, the son of a painter in a porcelain factory, at Eisenberg in Saxe-Altenburg. He studied at Berlin, where he attached himself to the "Right" of the Hegelian school under P. Marheineke. In 1834 he began to teach in Berlin as a licentiate of theology, and in 1839 was transferred to Bonn. In 1838 he published his *Kritische Darstellung der Religion des Alten Testaments* (2 vols.), which shows that at that date he was still faithful to the Hegelian Right. Soon afterwards his opinions underwent a change, and in two works, one on the Fourth Gospel, *Kritik der evangelischen Geschichte des Johannes* (1840), and the other on the Synoptics, *Kritik der evangelischen Geschichte der Synoptiker* (1841), as well as in his *Herr Hengstenberg, kritische Briefe über den Gegensatz des Gesetzes und des Evangeliums*, he announced his complete rejection of his earlier orthodoxy. In 1842 the government revoked his license and he retired for the rest of his life to Rixdorf, near Berlin. Henceforward he took a deep interest in modern history and politics, as well as in theology, and published *Geschichte der Politik, Kultur und Aufklärung des 18ten Jahrhunderts* (4 vols. 1843-1845), *Geschichte der französischen Revolution* (3 vols. 1847), and *Disraelis romanischer und Bismarcks socialistischer Imperialismus* (1882). Other critical works are: a criticism of the gospels and a history of their origin, *Kritik der Evangelien und Geschichte ihres Ursprungs* (1850-1852), a book on the Acts of the Apostles, *Apostelgeschichte* (1850), and a criticism of the Pauline epistles, *Kritik der paulinischen Briefe* (1850-1852). He died at Rixdorf on the 13th of April 1882. His criticism of the New Testament was of a highly destructive type. David Strauss in his *Life of Jesus* had accounted for the Gospel narratives as half-conscious products of the mythic instinct in the early Christian communities. Bauer ridiculed Strauss's notion that a community could produce a connected narrative. His own contention, embodying a theory of C. G. Wilke (*Der Urevangelist*, 1838), was that the original narrative was the Gospel of Mark; that this was composed in the reign of Hadrian; and that after this the other narratives were modelled by other writers. He, however, "regarded Mark not only as the first narrator, but even as the creator of the gospel history, thus making the latter a fiction and Christianity the invention of a single original evangelist" (Pfleiderer). On the same principle the four principal Pauline epistles were regarded as forgeries of the 2nd century. He argued further for the preponderance of the Graeco-Roman element, as opposed to the Jewish, in the Christian writings. The writer of Mark's gospel was "an Italian, at home both in Rome and Alexandria"; that of Matthew's gospel "a Roman, nourished by the spirit of Seneca"; the Pauline epistles were written in the West in antagonism to the Paul of the Acts, and so on. Christianity is essentially "Stoicism triumphant in a Jewish garb." This line of criticism has found few supporters, mostly in the Netherlands. It certainly had its value in emphasizing the importance of studying the influence of environment in the formation of the Christian Scriptures. Bauer was a man of restless, impetuous activity and independent, if ill-balanced, judgment, one who, as he himself perceived, was more in place as a free-lance of criticism than as an official teacher. He came in the end to be regarded kindly even by opponents, and he was not afraid of taking a line displeasing to his liberal friends on the Jewish question (*Die Judenfrage*, 1843).

His attitude towards the Jews is dealt with in the article in the *Jewish Encyclopedia*. See generally Herzog-Hauck, *Realencyklopädie*; and cf. Otto Pfeiderer, *Development of Theology*, p. 226; Carl Schwarz, *Zur Geschichte der neuesten Theologie*, pp. 122 ff.; and F. Lichtenberger, *History of German Theology in the 19th Century* (1889), pp. 374-378.

BAUERNFELD, EDUARD VON (1802-1890), Austrian dramatist, was born at Vienna on the 13th of January 1802. Having

studied jurisprudence at the university of Vienna, he entered the government service in a legal capacity, and after holding various minor offices was transferred in 1843 to a responsible post on the Lottery Commission. He had already embarked upon politics, and severely criticized the government in a pamphlet, *Pia Desideria eines österreichischen Schriftstellers* (1842); and in 1845 he made a journey to England, after which his political opinions became more pronounced. After the Revolution, in 1848, he quitted the government service in order to devote himself entirely to letters. He lived in Vienna until his death on the 9th of August 1890, and was ennobled for his work. As a writer of comedies and farces, Bauernfeld takes high rank among the German playwrights of the century; his plots are clever, the situations witty and natural and the diction elegant. His earliest essays, the comedies *Leichtsinn aus Liebe* (1831); *Das Liebes-Protokoll* (1831) and *Die ewige Liebe* (1834); *Bürgerlich und Romantisch*, (1835) enjoyed great popularity. Later he turned his attention to so-called *Salonstücke* (drawing-room pieces), notably *Aus der Gesellschaft* (1866); *Moderne Jugend* (1869), and *Der Landfrieden* (1869), in which he portrays in fresh, bright and happy sallies the social conditions of the capital in which he lived.

A complete edition of Bauernfeld's works, *Gesammelte Schriften*, appeared in 12 vols. (Vienna, 1871-1873); *Dramatische Nachlass*, ed. by F. von Saar (1893); selected works, ed. by E. Horner (4 vols., 1905). See A. Stern, *Bauernfeld, Ein Dichterporträt* (1890), R. von Gottschall, "E. von Bauernfeld" (in *Unsere Zeit*, 1896), and E. Horner, *Bauernfeld* (1900).

BAUFFREMONT, a French family which derives its name from a village in the Vosges, spelt nowadays Beaufremont. In consequence of an alliance with the house of Vergy the Bauffremonts established themselves in Burgundy and Franche-Comté. In 1448 Pierre de Bauffremont, lord of Charny, married Marie, a legitimized daughter of Philip the Good, duke of Burgundy. Nicolas de Bauffremont, his son Claude, and his grandson Henri, all played important parts in the states-general of 1576, 1588 and 1614, and their speeches have been published. Alexandre Emmanuel Louis de Bauffremont (1773-1833), a prince of the Holy Roman Empire, was created a peer of France in 1817, and duke in 1818. After having served in the army of the princes he returned to France under the Empire, and had been made a count by Napoleon. (M. P.)*

BAUHIN, GASPARD (1560-1624), Swiss botanist and anatomist, was the son of a French physician, Jean Bauhin (1511-1582), who had to leave his native country on becoming a convert to Protestantism. He was born at Basel on the 17th of January 1560, and devoting himself to medicine, he pursued his studies at Padua, Montpellier, and some of the celebrated schools in Germany. Returning to Basel in 1580, he was admitted to the degree of doctor, and gave private lectures in botany and anatomy. In 1582 he was appointed to the Greek professorship in that university, and in 1588 to the chair of anatomy and botany. He was afterwards made city physician, professor of the practice of medicine, rector of the university, and dean of his faculty. He died at Basel on the 5th of December 1624. He published several works relative to botany, of which the most valuable was his *Pinax Theatri Botanicæ, seu Index in Theophrasti, Dioscoridis, Plinii, et botanicorum qui a seculo scripserunt opera* (1596). Another great work which he planned was a *Theatrum Botanicum*, meant to be comprised in twelve parts folio, of which he finished three; only one, however, was published (1658). He also gave a copious catalogue of the plants growing in the environs of Basel, and edited the works of P. A. Mattioli (1500-1577) with considerable additions. He likewise wrote on anatomy, his principal work on this subject being *Theatrum Anatomicum infinitis locis auctum* (1592).

His son, JEAN GASPARD BAUHIN (1606-1685), was professor of botany at Basel for thirty years. His elder brother, JEAN BAUHIN (1541-1613), after studying botany at Tübingen under Leonard Fuchs (1501-1566), and travelling with Conrad Gesner, began to practise medicine at Basel, where he was elected professor of rhetoric in 1766. Four years later he was invited to become physician to the duke of Württemberg at Montbéliard, where he remained till his death in 1613. He devoted himself

chiefly to botany. His great work, *Historia plantarum nova et absolutissima*, a compilation of all that was then known about botany, was not complete at his death, but was published at Yverdon in 1650-1651, the *Prodromus* having appeared at the same place in 1619. He also wrote a book *De aquis medicatis* (1605).

BAULK, or **BALK** (a word common to Teutonic languages, meaning a ridge, partition, or beam), the ridge left unploughed between furrows or ploughed fields; also the uncultivated strip of land used as a boundary in the "open-field" system of agriculture. From the meaning of something left untouched comes that of a hindrance or check, so of a horse stopping short of an obstacle, of the "balk-line" in billiards, or of the deceptive motion of the pitcher in baseball. From the other original meaning, i.e. "beam," comes the use of the word for the cross or tie-beam of a roof, or for a large log of timber sawn to a one or one and a half foot square section (see JOINTERY).

BAUMBACH, RUDOLF (1840-1905), German poet, was born at Kranichfeld on the Ilm in Thuringia, on the 28th of September 1840, the son of a local medical practitioner, and received his early schooling at the gymnasium of Meiningen, to which place his father had removed. After studying natural science in various universities, he engaged in private tuition, both independently and in families, in the Austrian towns of Graz, Brünn, Görz and Trieste respectively. In Trieste he caught the popular taste with an Alpine legend, *Zlatorog* (1877), and songs of a journeyman apprentice, *Lieder eines fahrenden Gesellen* (1878), both of which have run into many editions. Their success decided him to embark upon a literary career. In 1885 he returned to Meiningen, where he received the title of *Hofrat*, and was appointed ducal librarian. His death occurred on the 14th of September 1905.

Baumbach was a poet of the breezy, vagabond school, and wrote, in imitation of his greater compatriot, Victor Scheffel, many excellent drinking songs, among which *Die Lindewirtin* has endeared him to the German student world. But his real strength lay in narrative verse, especially when he had the opportunity of describing the scenery and life of his native Thuringia. Special mention may be made of *Frau Holde* (1881), *Spielmannslieder* (1882), *Von der Landstrasse* (1882), *Thüringer Lieder* (1891), and his prose, *Sommermärchen* (1881).

BAUMÉ, ANTOINE (1728-1804), French chemist, was born at Senlis on the 26th of February 1728. He was apprenticed to the chemist Claude Joseph Geoffroy, and in 1752 was admitted a member of the *École de Pharmacie*, where in the same year he was appointed professor of chemistry. The money he made in a business he carried on in Paris for dealing in chemical products enabled him to retire in 1780 in order to devote himself to applied chemistry, but, ruined in the Revolution, he was obliged to return to a commercial career. He devised many improvements in technical processes, e.g. for bleaching silk, dyeing, gilding, purifying saltpetre, &c., but he is best known as the inventor of the hydrometer associated with his name (often in this connexion improperly spelt Baumé). Of the numerous books and papers he wrote the most important is his *Éléments de pharmacie théorique et pratique* (9 editions, 1762-1818). He became a member of the Academy of Sciences in 1772, and an associate of the Institute in 1796. He died in Paris on the 15th of October 1804.

BAUMGARTEN, ALEXANDER GOTTLIEB (1714-1762), German philosopher, born at Berlin. He studied at Halle, and became professor of philosophy at Halle and at Frankfurt on the Oder, where he died in 1762. He was a disciple of Leibnitz and Wolff, and was particularly distinguished as having been the first to establish the *Theory of the Beautiful* as an independent science. Baumgarten did good service in severing aesthetics (*q.v.*) from the other philosophic disciplines, and in marking out a definite object for his researches. The very name (*Aesthetics*), which Baumgarten was the first to use, indicates the element and partial nature of his analysis, pointing as it does to an imperfect so variable as *feeling* or *sensation* as the ultimate ground of judgment in questions pertaining to beauty. It is important

to notice that Baumgarten's first work preceded those of Burke, Diderot, and P. André, and that Kant had a great admiration for him. The principal works of Baumgarten are the following: *Disputationes de nonnullis ad poema pertinentibus* (1735); *Aesthetica; Metaphysica* (1739); 7th ed. 1799; *Ethica philosophica* (1751, 2nd ed. 1763); *Initia philosophiae practicae primae* (1760). After his death, his pupils published a *Philosophia Generalis* (1770) and a *Jus Naturae* (1765), which he had left in manuscript.

See Mc'er, *Baumgarten's Leben* (1763); Abbt, *Baumgarten's Leben und Charakter* (1768); H. G. Meyer, *Leibnitz und Baumgarten* (1874); J. Schmidt, *Leibnitz und Baumgarten* (Halle, 1875); and article AESTHETICS.

His brother, SIEGMUND JACOB BAUMGARTEN (1706-1757), was professor of theology at Halle, and applied the methods of Wolff to theology. His chief pupil, Johann Salomo Semler (q.v.), is sometimes called the father of German rationalism. Baumgarten, though he did not renounce the Pietistic doctrine, began the process which Semler completed. His works include *Evangelische Glaubenslehre* (1759); *Auszug der Kirchengeschichte* (1743-1762); *Primae lineae brevioris antiquitatum Christianarum* (1747); *Geschichte der Religionsparteien* (1760); *Nachricht von merkwürdigen Büchern* (1752-1757); *Nachrichten von einer halischen Bibliothek* (1748-1751).

See life by Semler (Halle, 1758).

BAUMGARTEN, MICHAEL (1812-1889), German Protestant theologian, was born at Haseldorf in Schleswig-Holstein on the 25th of March 1812. He studied at Kiel University (1832), and became professor ordinarius of theology at Rostock (1850). A liberal scholar, he became widely known in 1854 through a work, *Die Nachtgesichte Scharjas. Eine Prophetenstimme aus der Gegenwart*, in which, starting from texts in the Old Testament and assuming the tone of a prophet, he discussed topics of every kind. At a pastoral conference in 1856 he boldly defended evangelical freedom as regards the legal sanctity of Sunday. This, with other attempts to liberalize religion, brought him into conflict with the ecclesiastical authorities of Mecklenburg, and in 1858 he was deprived of his professorship. He then travelled throughout Germany, demanding justice, telling the story of his life (*Christliche Selbstgespräche*, 1861), and lecturing on the life of Jesus (*Die Geschichte Jesu. Für das Verständniss der Gegenwart*, 1859). In 1865 he helped to found the *Deutsche Protestantenverein*, but withdrew from it in 1877. On several occasions (1874, 1877 and 1878) he sat in the Reichstag as a member of the progressive party. He died on the 21st of July 1889. Other works: *Apostelgeschichte oder Entwicklungsgang der Kirche von Jerusalem bis Rom* (2 vols. 2nd ed., 1859), and *Doktor Martin Luther, ein Volksbuch* (1883).

H. H. Studt published his autobiography in 1891 (2 vols.); see also C. Schwartz, *Neueste Theologie* (1869); Lichtenberger, *Hist. Germ. Theol.*, 1889; Calwer-Zeller, *Kirchen-Lexikon*.

BAUMGARTEN-CRUSIUS, LUDWIG FRIEDRICH OTTO (1788-1842), German Protestant divine, was born at Merseburg. In 1805 he entered the university of Leipzig and studied theology and philology. After acting as *Privatdozent* at Leipzig, he was, in 1812, appointed professor extraordinarius of theology at Jena, where he remained to the end of his life, rising gradually to the head of the theological faculty. He died on the 31st of May 1842. With the exception of Church history, he lectured on all branches of so-called theoretical theology, especially on New Testament exegesis, biblical theology, dogmatic ethics, and the history of dogma, and his comprehensive knowledge, accurate scholarship and wide sympathies gave peculiar value to his lectures and treatises, especially those on the development of church doctrine. His published works are many, the most important being:—*Lehrbuch der christlichen Sittenlehre* (1826); *Grundsätze der biblischen Theologie* (1828); *Lehrbuch der Dogmengeschichte* (1832); *Compendium der Dogmengeschichte* (1840). The last, perhaps his best work, was left unfinished, but was completed from his notes in 1846 by Karl Hase.

BAUR, FERDINAND CHRISTIAN (1792-1860), leader of the Tübingen school of theology, was born at Schmidlen, near Canstatt, on the 21st of June 1792. After receiving an early

training in the theological seminary at Blaubeuren, he went in 1809 to the university of Tübingen. Here he studied for a time under Ernst Bengel, grandson of the eminent New Testament critic, Johann Albrecht Bengel, and at this early stage in his career he seems to have been under the influence of the old Tübingen school. But at the same time the philosophers Immanuel Fichte and Friedrich Schelling were creating a wide and deep impression. In 1817 Baur returned to the theological seminary at Blaubeuren as professor. This move marked a turning-point in his life, for he was now able to set to work upon those investigations on which his reputation rests. He had already, in 1817, written a review of G. Kaiser's *Biblische Theologie für Bengel's Archiv für Theologie* (ii. 656); its tone was moderate and conservative. When, a few years after his appointment at Blaubeuren, he published his first important work, *Symbolik und Mythologie oder die Naturreligion des Altertums* (1824-1825), it became evident that he had made a deeper study of philosophy, and had come under the influence of Schelling and more particularly of Friedrich Schleiermacher. The learning of the work was fully recognized, and in 1826 the author was called to Tübingen as professor of theology. It is with Tübingen that his greatest literary achievements are associated. His earlier publications here treated of mythology and the history of dogma. *Das manichäische Religionssystem* appeared in 1831, *Apollonius von Tyana* in 1832, *Die christliche Gnosis* in 1835, and *Über das Christliche im Platonismus oder Sokrates und Christus* in 1837. As Otto Pfeleiderer (*Development of Theology*, p. 285) observes, "the choice not less than the treatment of these subjects is indicative of the large breadth of view and the insight of the historian into the comparative history of religion." Meantime Baur had exchanged one master in philosophy for another, Schleiermacher for Hegel. In doing so, he had adopted completely the Hegelian philosophy of history. "Without philosophy," he has said, "history is always for me dead and dumb." The change of view is illustrated clearly in the essay, published in the *Tübingen Zeitschrift* for 1831, on the Christ-party in the Corinthian Church, *Die Christuspartei in der korinthischen Gemeinde, der Gegensatz des paulinischen und petrinischen in der ältesten Kirche, der Apostel Petrus in Rom*, the trend of which is suggested by the title. Baur contends that St Paul was opposed in Corinth by a Jewish-Christian party which wished to set up its own form of Christian religion instead of his universal Christianity. He finds traces of a keen conflict of parties in the post-apostolic age. The theory is further developed in a later work (1835, the year in which David Strauss' *Leben Jesu* was published), *Über die sogenannten Pastoralbriefe*. In this Baur attempts to prove that the false teachers mentioned in the Epistles to Timothy and Titus are the Gnostics, particularly the Marcionites, of the second century, and consequently that the Epistles were produced in the middle of this century in opposition to Gnosticism. He next proceeded to investigate the Pauline Epistles and the Acts of the Apostles in the same manner, publishing his results in 1845 under the title *Paulus, der Apostel Jesu Christi, sein Leben und Wirken, seine Briefe und seine Lehre*. In this he contends that only the Epistles to the Galatians, Corinthians and Romans are genuinely Pauline, and that the Paul of Acts is a different person from the Paul of these genuine Epistles, the author being a Paulinist who, with an eye to the different parties in the Church, is at pains to represent Peter as far as possible as a Paulinist and Paul as far as possible as a Petrinist. Thus it becomes clear that Baur is prepared to apply his theory to the whole of the New Testament; in the words of H. S. Nash, "he carried a sweeping hypothesis into the examination of the New Testament." Those writings alone he considers genuine in which the conflict between Jewish-Christians and Gentile-Christians is clearly marked. In his *Christliche Untersuchungen über die kanonischen Evangelien, ihr Verhältnis zu einander, ihren Charakter und Ursprung* (1847) he turns his attention to the Gospels, and here again finds that the authors were conscious of the conflict of parties; the Gospels reveal a mediating or conciliatory tendency (*Tendenz*) on the part of the writers or redactors. The Gospels, in fact, are adaptations

or redactions of an older Gospel, such as the Gospel of the Hebrews, of Peter, of the Egyptians, or of the Ebionites. The Petrine Matthew bears the closest relationship to this original Gospel (*Urvangelium*); the Pauline Luke is later and arose independently; Mark represents a still later development; the account in John is idealistic: it "does not possess historical truth, and cannot and does not really lay claim to it." Baur's whole theory indeed starts with the supposition that Christianity was gradually developed out of Judaism. Before it could become a universal religion, it had to struggle with Jewish limitations and to overcome them. The early Christians were Jewish-Christians, to whom Jesus was the Messiah. Paul, on the other hand, represented a breach with Judaism, the Temple, and the Law. Thus there was some antagonism between the Jewish apostles, Peter, James and John and the Gentile apostle Paul, and this struggle continued down to the middle of the 2nd century. In short, the conflict between Petrinism and Paulinism is, as Carl Schwarz puts it, the key to the literature of the 1st and 2nd century.

But Baur was a theologian and historian as well as a Biblical critic. As early as 1834 he published a strictly theological work, *Gegensatz des Katholicismus und Protestantismus nach den Prinzipien und Hauptdogmen der beiden Lehrbegriffe*, a strong defence of Protestantism on the lines of Schleiermacher's *Glaubenslehre*, and a vigorous reply to J. Möhler's *Symbolik* (1833). This was followed by his larger histories of dogma, *Die christliche Lehre von der Versöhnung in ihrer geschichtlichen Entwicklung bis auf die neueste Zeit* (1838), *Die christliche Lehre von der Dreieinigkeit und Menschwerdung Gottes in ihrer geschichtlichen Entwicklung* (3 vols., 1841-1843), and the *Lehrbuch der christlichen Dogmengeschichte* (1847). The value of these works is impaired somewhat by Baur's habit of making the history of dogma conform to the formulae of Hegel's philosophy, a procedure "which only served to obscure the truth and profundity of his conception of history as a true development of the human mind" (Pfleiderer). Baur, however, soon came to attach more importance to personality, and to distinguish more carefully between religion and philosophy. The change is marked in his *Epochen der kirchlichen Geschichtsschreibung* (1852), *Das Christenthum und die christliche Kirche der drei ersten Jahrhunderte* (1853), and *Die christliche Kirche von Anfang des vierten bis zum Ende des sechsten Jahrhunderts* (1859), works preparatory to his *Kirchengeschichte*, in which the change of view is specially pronounced. The *Kirchengeschichte* was published in five volumes during the years 1853-1863, partly by Baur himself, partly by his son, Ferdinand Baur, and his son-in-law, Eduard Zeller, from notes and lectures which the author left behind him. Pfeleiderer describes this work, especially the first volume, as "a classic for all time." "Taken as a whole, it is the first thorough and satisfactory attempt to explain the rise of Christianity and the Church on strictly historical lines, i.e. as a natural development of the religious spirit of our race under the combined operation of various human causes" (*Development of Theology*, p. 288). Baur's lectures on the history of dogma, *Ausführlichere Vorlesungen über die christliche Dogmengeschichte*, were published later by his son (1865-1868).

Baur's views were revolutionary and often extreme; but, whatever may be thought of them, it is admitted that as a critic he rendered a great service to theological science. "One thing is certain: New Testament study, since his time, has had a different colour" (H. S. Nash). He has had a number of disciples or followers, who have in many cases modified his positions.

A full account of F. C. Baur's labours, and a complete list of his writings will be found in the article in Herzog-Hauck, *Realencyclopädie*, in which his work is divided into three periods: (1) "Philosophy of Religion," (2) "Biblical criticism," (3) "Church History." See also H. S. Nash, *The History of the Higher Criticism of the New Testament* (New York, 1901); Otto Pfeleiderer, *The Development of Theology in Germany since Kant* (trans., 1890); Carl Schwarz, *Zur Geschichte der neuesten Theologie* (Leipzig, 1899); R. W. Mackay, *The Tübingen School and its Antecedents* (1861); A. S. Farrar, *A Critical History of Free Thought in reference to the Christian Religion* (Bampton Lectures, 1862); and cf. the article on "The Tübingen Historical School," in *Bibliotheca Sacra*, vol. xix, No. 73, 1862.

(M. A. C.)

BAUTAIN, LOUIS EUGÈNE MARIE (1796-1867), French philosopher and theologian, was born at Paris. At the *École Normale* he came under the influence of Cousin. In 1816 he adopted the profession of higher teaching, and was soon after called to the chair of philosophy in the university of Strassburg. He held this position for many years, and gave a parallel course of lectures as professor of the literary faculty in the same city. The reaction against speculative philosophy, which carried away De Maistre and Lamennais, influenced him also. In 1828 he took orders, and resigned his chair at the university. For several years he remained at Strassburg, lecturing at the Faculty and at the college of Jully, but in 1849 he set out for Paris as vicar of the diocese. At Paris he obtained considerable reputation as an orator, and in 1853 was made professor of moral theology at the theological faculty. This post he held till his death. Like the Scholastics, he distinguished reason and faith, and held that revelation supplies facts, otherwise unattainable, which philosophy is able to group by scientific methods. Theology and philosophy thus form one comprehensive science. Yet Bautain was no rationalist; like Pascal and Newman he exalted faith above reason. He pointed out, following chiefly the Kantian criticism, that reason can never yield knowledge of things in themselves. But there exists in addition to reason another faculty which may be called intelligence, through which we are put in connexion with spiritual and invisible truth. This intelligence does not of itself yield a body of truth; it merely contains the germs of the higher ideas, and these are made productive by being brought into contact with revealed facts. This fundamental conception Bautain worked out in the departments of psychology and morals. The details of this theory are highly imaginative. He says, for instance, that there is a spirit of the world and a spirit of nature; the latter gives birth to a physical and psychical spirit, and the physical spirit to the animal and vegetable spirits. His theories may well be compared with the arbitrary mysticism of van Helmont and the Gnostics. The most important of his works are:—*Philosophie du Christianisme* (1835); *Psychologie expérimentale* (1830), new edition entitled *Esprit humain et ses facultés* (1850); *Philosophie morale* (1840); *Religion et liberté* (1843); *La Morale de l'évangile comparée aux divers systèmes de morale* (Strassburg, 1827; Paris, 1855); *De l'éducation publique en France au XIX^e siècle* (Paris, 1876).

BAUTZEN (Wendish *Budissin*, "town"), a town of Germany, in the kingdom of Saxony and the capital of Saxon Upper Lusatia. Pop. (1890) 21,515; (1905) 29,412. It occupies an eminence on the right bank of the Spree, 680 ft. above the level of the sea, 32 m. E.N.E. from Dresden, on the Dresden-Görlitz-Breslau main line of railway, and at the junction of lines from Schandau and Königswartha. The town is surrounded by walls, and outside these again by ramparts, now in great measure turned into promenades, and has extensive suburbs partly lying on the left bank of the river. Among its churches the most remarkable is the cathedral of St. Peter, dating from the 15th century, with a tower 300 ft. in height. It is used by both Protestants and Roman Catholics, an iron screen separating the parts assigned to each. There are five other churches, a handsome town hall, an orphan-asylum, several hospitals, a mechanics' institute, a famous grammar school (gymnasium), a normal and several other schools, and two public libraries. The general trade and manufactures are considerable, including woollen (stockings and cloths), linen and cotton goods, leather, paper, salt-petre, and dyeing. It has also iron foundries, potteries, distilleries, breweries, cigar factories, &c.

Bautzen was already in existence when Henry I., the Fowler, conquered Lusatia in 928. It became a town and fortress under Otto I., his successor, and speedily attained considerable wealth and importance, for a good share of which it was indebted to the pilgrimages which were made to the "arm of St Peter," preserved in one of the churches. It suffered greatly during the Hussite war, and still more during the Thirty Years' War, in the course of which it was besieged and captured by the elector of Brandenburg, John George (1620), fell into the hands of Wallenstein (1633), and,

in the following year was burned by its commander before being surrendered to the elector of Saxony. At the peace of Prague in 1635 it passed with Lusatia to Saxony as a war indemnity.

The town gives its name to a great battle in which, on the 20th and 21st of May 1813, Napoleon I. defeated an allied army of

Battle of Bautzen, 1813.

Russians and Prussians (see NAPOLEONIC CAMPAIGNS). The position chosen by the allies as that in which to receive the attack of Napoleon ran S.W. to N.E. from Bautzen on the left to the village of Gleina on the right.

Bautzen itself was held as an advanced post of the left wing (the Russians), the main body of which lay 2 m. to the rear (E.) near Jenkwitz. On the heights of Burk, 2½ m. N.E. of Bautzen, was Kleist's Prussian corps, with York's in support. On Kleist's right at Pliskowitz (3 m. N.E. of Burk) lay Blücher's corps, and on Blücher's right, formed at an angle to him, and refused towards Gleina (7 m. N.E. by E. of Bautzen), were the Russians of Barclay de Tolly. The country on which the battle was fought abounded in strong defensive positions, some of which were famous as battlegrounds of the Seven Years' War. The whole line was covered by the river Spree, which served as an immediate defence for the left and centre, and an obstacle to any force moving to attack the right; moreover the interval between the river and the position on this side was covered with a network of ponds and watercourses. Napoleon's right and centre approached (on a broad front owing to the want of cavalry) from Dresden by Bischofswerda and Kamenz; the left under Ney, which was separated by nearly 40 m. from the left of the main body at Luckau, was ordered to march via Hoyerswerda, Weissig and Klitz to strike the allies' right. At noon on the 20th, Napoleon, after a prolonged reconnaissance, advanced the main army against

Bautzen and Burk, leaving the enemy's right to be dealt with by Ney on the morrow. He equally neglected the extreme left of the allies in the mountains, judging it impossible to move his artillery and cavalry in the broken ground there. Oudinot's (XII.) corps, the extreme right wing, was to work round by the hilly country to Jenkwitz in rear of Bautzen, Macdonald's (XI.) corps was to assault Bautzen, and Marmont, with the VI. corps, to cross the Spree and attack the Prussians posted about Burk. These three corps were directed by Soult. Farther to the left, Bertrand's (IV.) corps was held back to connect with Ney, who had then reached Weissig with the head of his column. The Guard and other general reserves were in rear of Macdonald and Marmont.

Bautzen was taken without difficulty; Oudinot and Marmont easily passed the Spree on either side, and were formed up on the other bank of the river by about 4 P.M. A heavy and indecisive combat took place in the evening between Oudinot and the Russian left, directed by the tsar in person, in which Oudinot's men made a little progress towards Jenkwitz. Marmont's battle was more serious. The Prussians were not experienced troops, but were full of ardour and hatred of the French. Kleist made a most stubborn resistance on the Burk ridge, and Bertrand's corps was called up by Napoleon to join in the battle; but part of Blücher's corps fiercely engaged Bertrand, and Burk was not taken till 7 P.M. The French attack was much impeded by the ground and by want of room to deploy between the river and the enemy. But Napoleon's object in thus forcing the fighting in the centre was achieved. The allies, feeling the weight of the French attack, gradually drew upon the reserves of their left and right to sustain the shock. At nightfall Bautzen and Burk were in possession of the French, and the allied line now stretched from Jenkwitz northward to Pliskowitz, Blücher and Barclay maintaining their original positions at Pliskowitz and Gleina. The night of the 20th-21st was spent by both armies on the battlefield. Napoleon cared little that the French centre was almost fought out; it had fulfilled its mission, and on the 21st the decisive point was to be Barclay's position. Soon after daybreak fighting was renewed along the whole line; but Napoleon lay down to sleep until the time appointed for Ney's attack. To a heavy counter-stroke against Oudinot, which completely drove that marshal from the ground won on the 20th, the emperor paid no more heed than to order Macdonald to support the XII. corps. For in this second position of the allies, which was far more formidable than

the original line, the decisive result could be brought about only by Ney. That commander had his own (III) corps, the corps of Victor and of Lauriston and the Saxons under Reynier, a total force of 60,000 men. Lauriston, at the head of the column, had been sharply engaged on the 19th, but had spent the 20th in calculated inaction. Early on the 21st the flank attack opened; Ney and Lauriston moving direct upon Gleina, while Reynier and Victor operated by a wide turning movement against Barclay's right rear. The advance was carried out with precision; the Russians were quickly dislodged, and Ney was now closing upon the rear of Blücher's corps at the village of Preititz. Napoleon at once ordered Soult's four corps to renew their attacks in order to prevent the allies from reinforcing their right. But at the critical moment Ney halted; his orders were to be in Preititz at 11 A.M. and he reached that place an hour earlier. The respite of an hour enabled the allies to organize a fierce counter-attack; Ney was checked until the flanking columns of Victor and Reynier could come upon the scene. At 1 P.M., when Ney resumed his advance, it was too late to cut off the retreat of the allies. Napoleon now made his final stroke. The Imperial Guard and all other troops in the centre, 80,000 strong and covered by a great mass of artillery, moved forward to the attack; and shortly the allied centre, depleted of its reserves, which had been sent to oppose Ney, was broken through and driven off the field. Blücher, now almost surrounded, called back the troops opposing Ney to make head against Soult, and Ney's four corps then carried all before them. Preparations had been made by the allies, ever since Ney's appearance, to break off the engagement, and now the tsar ordered a general retreat eastwards, himself with the utmost skill and bravery directing the rearguard. Thus the allies drew off unharmed, leaving no trophies in the hands of Napoleon, whose success, tactically unquestionable, was, for a variety of reasons, and above all owing to the want of cavalry, a *coup manqué* strategically. The troops engaged were, on the French side 163,000 men, that of the allies about 100,000; and the losses respectively about 20,000 and 13,500 killed and wounded.

BAUXITE, a substance which has been considered to be a mineral species, having the composition $Al_2O_3(OH)_2$ (corresponding with alumina 73.9, water 26.1%), and thus to be distinct from the crystallized aluminium hydroxides, diaspore ($AlO(OH)$) and gibbsite (=hydrargillite, $Al(OH)_3$). It was first described by P. Berthier in 1821 as "alumine hydratée de Beaux," and was named bauxite by P. A. Dufrenoy in 1847 and bauxite by E. H. Sainte-Claire Deville in 1861; this name being derived from the original locality, the village of Les Baux (or Beaux), near Arles, dep. Bouches-du-Rhône in the south of France, where the material has been for many years extensively mined as an ore of aluminium. It is never found in a crystallized state, but always as earthy, clay-like or concretionary masses, often with a psilolitic structure. In colour it varies from white through yellow and brown to red, depending on the amount and the degree of hydration of the iron present. The specific gravity also varies with the amount of iron; that of the variety known as *wocheinite* (from near Lake Wochein, near Radmannsdorf, in northern Carinthia) is given as 2.55. The numerous chemical analyses, which have mostly been made for technical purposes, show that material known as bauxite varies very widely in composition, the maximum and minimum percentages of each constituent being as follows: alumina (Al_2O_3) 33.2-76.0; water (H_2O) 8.6-31.4; iron oxide (Fe_2O_3) 0.1-48.8; silica (SiO_2) 0.3-37.8; titanic acid (TiO_2) up to 4. The material is thus usually very impure, being mixed with clay, quartz-sand and hydroxides of iron in variable amounts, the presence of which may be seen by a microscopical examination. Analyses of purer material often approximate to diaspore or gibbsite in composition, and minute crystalline scales of these minerals have been detected under the microscope.

Bauxite can therefore scarcely be regarded as a simple mineral, but rather as a mixture of gibbsite and diaspore with various impurities; it is in fact strikingly like laterite, both in chemical composition and in microscopical structure. Laterite is admittedly a decomposition-product of igneous or other crystalline

rocks, and the same is no doubt also true of bauxite. The deposits in Co. Antrim occur with pisolitic iron ore interbedded with the Tertiary basalts, and similar deposits are met with in connexion with the basaltic rocks of the Westerwald in Germany. On the other hand, the more extensive deposits in the south of France (departments Bouches-du-Rhône, Ariège, Hérault, Var) and the southern United States (Georgia, Alabama, Arkansas) are often associated with limestones; in this case the origin of the bauxite has been ascribed to the chemical action of solutions of aluminium sulphate on the limestones.

Bauxite is of value chiefly as a source of metallic aluminium (*q.v.*); the material is first purified by chemical processes, after which the aluminium hydroxide is reduced in the electric furnace. Bauxite is also largely used in the manufacture of alum and other aluminium salts used in dyeing. Its refractory qualities render it available for the manufacture of fire-bricks and crucibles. (L. J. S.)

BAVAI, a town of northern France in the department of Nord, 15 m. E.S.E. of Valenciennes by rail. Pop. (1906) 1622. The town carries on the manufacture of iron goods and of fertilizers. Under the name of *Bagacum* or *Bavacum* it was the capital of the Nervii and, under the Romans, an important centre of roads, the meeting-place of which was marked by a milestone, destroyed in the 17th century and replaced in the 19th century by a column. Bavaï was destroyed during the barbarian invasions and never recovered its old importance. It suffered much during the wars of the 15th, 16th and 17th centuries.

BAVARIA (Ger. *Bayern*), a kingdom of southern Germany, next to Prussia the largest state of the German empire in area and population. It consists of two distinct and unequal portions, Bavaria proper, and the Palatinate of the Rhine, which lie from 25 to 40 m. W. apart and are separated by the grand-duchies of Baden and Hesse.

Physical Features.—Bavaria proper is bounded on the S. by the Alps, on the N.E., towards Bohemia, by a long range of mountains known as the Böhmerwald, on the N. by the Fichtelgebirge and the Frankenwald, which separate it from the kingdom of Saxony, the principality of Reuss, the duchies of Saxe-Coburg-Gotha and Meiningen and the Prussian province of Hesse-Cassel. The ranges seldom exceed the height of 3000 or 4000 ft.; but the ridges in the south, towards Tirol, frequently attain an elevation of 9000 or 10,000 ft. On the W. Bavaria is bounded by Württemberg, Baden and Hesse-Darmstadt. The country mainly belongs to the basins of the Danube and the Main; by far the greater portion being drained by the former river, which, entering from Swabia as a navigable stream, traverses the entire breadth of the kingdom, with a winding course of 200 m., and receives in its passage the Iller, the Lech, the Isar and the Inn from the south, and the Naab, the Altmühl and the Wörnitz from the north. The Inn is navigable before it enters Bavarian territory, and afterwards receives the Salzach, a large river flowing from Upper Austria. The Isar does not become navigable till it has passed Munich; and the Lech is a stream of a similar size. The Main traverses the northern regions, or Upper and Lower Franconia, with a very winding course and greatly facilitates the trade of the provinces. The district watered by the southern tributaries of the Danube consists for the most part of an extensive plateau, with a mean elevation of 2300 ft. In the mountainous parts of the country there are numerous lakes and in the lower portions considerable stretches of marshy ground. The smaller or western portion, the Palatinate, is bounded on the E. by the Rhine, which divides it from the grand-duchy of Baden, on the S. by Alsace, and on the W. and N. by a lofty range of hills, the Haardtgebirge, which separate it from Lorraine and the Prussian Rhine province.

The climate of Bavaria differs greatly according to the character of the region, being cold in the vicinity of Tirol but warm in the plains adjoining the Danube and the Main. On the whole, the temperature is in the winter months considerably colder than that of England, and a good deal hotter during summer and autumn.

Area and Population.—Bavaria proper, or the eastern portion,

contains an area of 26,098 sq. m., and the Palatinate or western, 2288 sq. m., making the whole extent of the kingdom about 29,286 sq. m. The total population, according to the census of 1905, was 6,512,824. Almost a quarter of the inhabitants live in towns, of which Munich and Nuremberg have populations exceeding 100,000, Augsburg, Würzburg, Fürth and Ludwigs-hafen between 50,000 and 100,000, while twenty-six other towns number from 10,000 to 50,000 inhabitants.

Ethnographically, the Bavarians belong to various ancient tribes; Germanized Slavs in the north-east, Swabians and Franks in the centre, Franks towards the west, and, in the Palatinate, Walloons. Politically, the country is divided into eight provinces, as follows:—

Provinces.	Capital.	Pop. of Province in 1905.	Area in sq. m.
Upper Bavaria	Munich	1,410,763	6,456
Lower Bavaria	Landsbut	706,345	4,152
Upper Palatinate	Regensburg	573,476	3,728
Upper Franconia	Bayreuth	637,239	2,702
Middle Franconia	Ansbach	868,072	2,925
Lower Franconia	Würzburg	680,769	3,243
Swabia	Augsburg	750,880	3,792
The Palatinate	Spire	885,280	2,288
Total		6,512,824	29,286

Religion.—The majority of the inhabitants (about 70%) are Roman Catholics. The Protestant-Evangelical Church claims about 29%, while Jews, and a very small number of other sects, account for the remainder.

The districts of Lower Bavaria, Upper Bavaria and the Upper Palatinate are almost wholly Roman Catholic, while in the Rhine Palatinate, Upper Franconia, and especially Middle Franconia, the preponderance is on the side of the Protestants. The exercise of religious worship in Bavaria is altogether free. The Protestants have the same civil rights as the Roman Catholics, and the sovereign may be either Roman Catholic or Protestant. Of the Roman Catholic Church the heads are the two archbishops of Munich-Freising and Bamberg, and the six bishops of Eichstätt, Spire, Würzburg, Augsburg, Regensburg and Passau, of whom the first three are suffragans of Bamberg. The "Old Catholic" party, under the bishop of Bonn, has failed, despite its early successes, to take deep root in the country. Among the Protestants the highest authority is the general consistory of Munich. The numbers of the different religions in 1900 were as follows:—Roman Catholics, 4,337,133; Protestants, 1,749,206; Jews, 54,928.

Education.—Bavaria, formerly backward in education, has recently done much in this connexion. The state has two Roman Catholic universities, Munich and Würzburg, and a Lutheran, Erlangen; in Munich there are a polytechnic, an academy of sciences and an academy of art.

Agriculture.—Of the total surface of Bavaria about one-half is under cultivation, one-third forest, and the remaining sixth mostly pasture. The level country, including both Lower Bavaria (extending northwards to the Danube) and the western and middle parts of Franconia, is productive of rye, oats, wheat, barley and millet, and also of hemp, flax, madder and fruit and vines. The last are grown chiefly in the vicinity of the Lake of Constance, on the banks of the Main, in the lower part of its course, and in the Palatinate of the Rhine. Hops are extensively grown in central Franconia; tobacco (the best in Germany) round Nuremberg and in the Palatinate, which also largely produces the sugar-beet. Potatoes are cultivated in all the provinces, but especially in the Palatinate and in the Spessart district, which lies in the north-west within a curve of the Main. The southern divisions of Swabia and Upper Bavaria, where pasture-land predominates, form a cattle-breeding district and the dairy produce is extensive. Here also horses are bred in large numbers.

The extent of forest forms nearly a third of the total area of Bavaria. This is owing to various causes: the amount of hilly and mountainous country, the thinness of the population and

the necessity of keeping a given extent of ground under wood for the supply of fuel. More than a third of the forests are public property and furnish a considerable addition to the revenue. They are principally situated in the provinces of Upper Bavaria, Lower Bavaria and the Palatinate of the Rhine. The forests are well stocked with game, deer, chamois (in the Alps), wild boars, capercaillie, grouse, pheasants, &c. being plentiful. The greater proportion of the land throughout the kingdom is in the hands of peasant proprietors, the extent of the separate holdings differing very much in different districts. The largest peasant property may be about 170 acres, and the smallest, except in the Palatinate, about 50.

Minerals.—The chief mineral deposits in Bavaria are coal, iron ore, graphite and salt. The coal mines lie principally in the districts of Amberg, Kissingen, Steben, Munich and the Rhine Palatinate. Salt is obtained on a large scale partly from brine springs and partly from mines, the principal centres being Halle, Berchtesgaden, Traunstein and Rosenheim. The government monopoly which had long existed was abolished in 1867 and free trade was established in salt between the members of the customs-union. Of quicksilver there are several mines, chiefly in the Palatinate of the Rhine; and small quantities of copper, manganese and cobalt are obtained. There are numerous quarries of excellent marble, alabaster, gypsum and building stone; and the porcelain-clay is among the finest in Europe. To these may be added emery, steatite, barytes, felspar and ochre, in considerable quantities; excellent lithographic stone is obtained at Solenhofen; and gold and silver are still worked, but to an insignificant extent.

Manufactures and Trade.—A great stimulus was given to manufacturing industry in Bavaria by the law of 1868, which abolished the last remains of the old restrictions of the guilds, and gave the whole country the liberty which had been enjoyed by the Rhine Palatinate alone. The chief centres of industry are Munich, Nuremberg, Augsburg, Fürth, Erlangen, Aschaffenburg, Regensburg, Würzburg, Bayreuth, Ansbach, Bamberg and Hof in Bavaria proper, and in the Palatinate Spire and the Rhine port of Ludwigshafen. The main centres of the hardware industry are Munich, Nuremberg, Augsburg and Fürth; the two first especially for locomotives and automobiles, the last for tin-foil and metal toys. Aschaffenburg manufactures fancy goods, Augsburg and Hof produce excellent cloth, and Munich has a great reputation for scientific instruments. In Franconia are numerous paper-mills, and the manufacture of wooden toys is largely carried on in the forest districts of Upper Bavaria. A considerable quantity of glass is made, particularly in the Böhmerwald. Brewing forms an important industry, the best-known breweries being those of Munich, Nuremberg, Erlangen and Kulmbach. Other articles of manufacture are leather, tobacco, porcelain, cement, spirits, lead pencils (Nuremberg), plate-glass, sugar, matches, aniline dyes, straw hats and baskets. The commerce of Bavaria is very considerable. The exports consist chiefly of corn, potatoes, hops, beer, wine, cloth, cotton goods, glass, fancy wares, toys, cattle, pigs and vegetables. The seat of the hop-trade is Nuremberg; of wool, Augsburg. The imports comprise sugar, tobacco, cocoa, coffee, oils, silk and pig iron.

Communications.—Trade is served by an excellent railway system and there are steamboat services on the navigable rivers, to the east by way of Passau on the Danube, and to the west by Ludwigshafen. The high roads of Bavaria, many of which are military roads laid out at the beginning of the 19th century, extend in all over about 10,000 m. There were 4377 m. of railways in operation in 1904, of which about 3800 were in the hands of the state, and about 440 m. belonged to the private system of the Palatinate. The principal canal is the Ludwigskanal, which connects the Rhine with the Danube, extending from Bamberg on the Regnitz to Dietfurt on the Altmühl. There is an extensive network of telegraph and telephone lines. All belong to the government post office, which forms an administrative system independent of the imperial German post office.

Constitution and Administration.—By the treaty of Versailles (23rd November 1870) and the imperial constitution of the 16th

of April 1871, Bavaria was incorporated with the German empire, reserving, however, certain separate privileges (*Sonderrechte*) in respect of the administration of the army, the railways and the posts, the excise duties on beer, the rights of domicile and the insurance of real estate. The king is the supreme chief of the army, and matters requiring adjudication in the adjutant-general's court are referred to a special Bavarian court attached to the supreme imperial military tribunal in Berlin. Bavaria is represented in the Bundesrat by six votes and sends forty-eight deputies to the imperial diet. The Bavarian constitution is mainly founded on the constitutional act of the 26th of May 1818, modified by subsequent acts—that of the 9th of March 1828 as affecting the upper house, and those of the 4th of June 1848 and of the 21st of March 1881 as affecting the lower—and is a limited monarchy, with a legislative body of two houses. The crown is hereditary in the house of Wittelsbach, according to the rights of primogeniture, females being excluded from succession so long as male agnates of equal birth exist. The title of the sovereign is king of Bavaria, that of his presumptive heir is crown-prince of Bavaria, and during the minority or incapacity of the sovereign a regency is declared, which is vested in the nearest male agnate capable of ascending the throne. Such a regency began on the 10th of June 1886, at first for King Louis II., and after the 14th of the same month for King Otto I., in the person of the prince regent Luitpold. The executive power resides in the king and the responsibility for the government of the kingdom in his ministers. The royal family is Roman Catholic, and the seat of government is Munich, the capital.

The upper house of the Bavarian parliament (*Kammer der Reichsräte*) is composed of (1) the princes of the blood royal (being of full age), (2) the ministers of the crown, (3) the arch-bishops of Munich, Freising and Bamberg, (4) the heads of such noble families as were formerly "immediate" so long as they retain their ancient possessions in Bavaria, (5) of a Roman Catholic bishop appointed by the king for life, and of the president for the time being of the Protestant consistory, (6) of hereditary counsellors (*Reichsräte*) appointed by the king, and (7) of other counsellors appointed by the king for life. The lower house (*Kammer der Abgeordneten*) or chamber of representatives, consists, since 1881, of 159 deputies, in proportion of one—reckoned on the census of 1875—to every 31,500 inhabitants. A general election takes place every six years, and, under the electoral law of 1906, is direct. Qualifications for the general body of electors are full age of twenty-five years, Bavarian citizenship of one year at least, and discharge of all rates and taxes. Parliament must be assembled every three years, but as the budget is taken every two years, it is regularly called together within that period. No laws affecting the liberty or property of the subject can be passed without the sanction of parliament.

Revenue.—The following is a fairly typical statement of the budget estimates (1902-1903), in marks (= 1 shilling sterling):—

Receipts.		Disbursements.	
	Mks.		Mks.
Direct taxes	38,199,000	Civil list	5,402,475
Customs and indirect taxes	50,900,990	State debt	51,323,200
State railways	184,551,000	Ministry of the Royal house and of Foreign dept.	688,398
Posts and telegraphs	41,665,100	Ministry of justice	20,615,299
Forests and agricultural dues	37,395,000	Ministry of interior	30,055,336
Imperial assignments	62,571,605	Public worship and education	34,667,673
		Minister of finance	6,696,780
		Contribution to imperial exchequer	72,647,090
	415,282,695		222,296,253
	= £20,764,135		= £11,114,813

The public debt amounts to about £95,000,000, of which over 75% was incurred for railways.

Army.—The Bavarian army forms a separate portion of the army of the German empire, with a separate administration, but in time of war is under the supreme command of the German

emperor. The regulations applicable to other sections of the whole imperial army are, however, observed. It consists, on a peace footing, of three army corps, 1st, 2nd and 3rd Royal Bavarian (each of two divisions), the headquarters of which are in Munich, Nuremberg and Würzburg respectively. The Bavarian army comprises sixty-seven battalions of infantry, two battalions of rifles, ten regiments of cavalry (two heavy, two Ulan and six Chevaulegers), a squadron of mounted infantry (*Jäger-zu-pferde*), twelve field- and two foot-artillery regiments, three battalions of engineers, three of army service, and a balloon section; in all 60,000 men with 10,000 horses. In time of war the total force is trebled. (P. A. A.)

HISTORY

The earliest known inhabitants of the district afterwards called Bavaria were a people, probably of Celtic extraction, who were subdued by the Romans just before the opening of the Christian era, when colonies were founded among them and their land was included in the province of Raetia. During the 5th century it was ravaged by the troops of Odoacer and, after being almost denuded of inhabitants, was occupied by tribes who, pushing along the valley of the Danube, settled there between A.D. 488 and 520. Many conjectures have been formed concerning the race and origin of these people, who were certainly a new and composite social aggregate. Most likely they were descendants of the Marcomanni, Quadi and Narisci, tribes of the Suevic or Swabian race, with possibly a small intermixture of Gothic or Celtic elements. They were called *Baiouarii*, *Baiouarii*, *Bavarii* or *Baiuvarii*, words derived most probably from *Baja* or *Baya*, corruptions of *Bojer*, and given to them because they came from *Bojerland* or *Bohemia*. Another but less probable explanation derives the name from a combination of the old high German word *uodra*, meaning league, and *bai*, a Gothic word for both. The Bavarians are first mentioned in a Frankish document of 520, and twenty years later Jordanes refers to them as lying east of the Swabians. Their country bore some traces of Roman influence, and its main boundaries were the Enns, the Danube, the Lech and the Alps; but its complete settlement was a work of time.

The Bavarians soon came under the dominion of the Franks, probably without a serious struggle; and were ruled from 555 to 788 by dukes of the Agilolfing family, who were possibly of Frankish descent. For a century and a half a succession of dukes resisted the inroads of the Slavs on their eastern frontier, and by the time of Duke Theodo I., who died in 717, were completely independent of the feeble Frankish kings. When Charles Martel became the virtual ruler of the Frankish realm he brought the Bavarians into strict dependence, and deposed two dukes successively for contumacy. Pippin the Short was equally successful in maintaining his authority, and several marriages took place between the family to which he belonged and the Agilolfings, who were united in a similar manner with the kings of the Lombards. The ease with which various risings were suppressed by the Franks gives colour to the supposition that they were rather the outcome of family quarrels than the revolt of an oppressed people. Between the years 739 and 748 the Bavarian law was committed to writing and supplementary clauses were afterwards added, all of which bear evident traces of Frankish influence. Thus, while the dukedom belongs to the Agilolfing family, the duke must be chosen by the people and his election confirmed by the Frankish king, to whom he owes fealty. He has a fivefold wergild, summons the nobles and clergy for purposes of deliberation, calls out the host, administers justice and regulates finance. There are five noble families, possibly representing a former division of the people, after whom come the freeborn, and then the freedmen. The country is divided into *gans* or counties, under their counts, who are assisted by judges responsible for declaring the law.

Christianity had lingered in Bavaria from Roman times; but a new era set in when Rupert, bishop of Worms, came to the county at the invitation of Duke Theodo I. in 696. He

founded several monasteries, and a similar work was also performed by St Emmeran, bishop of Poitiers; with the result that before long the bulk of the people professed Christianity and relations were established between Bavaria and Rome. The 8th century witnessed indeed a heathen reaction; but it was checked by the arrival in Bavaria about 734 of St Boniface, who organized the Bavarian church and founded or restored bishoprics at Salzburg, Freising, Regensburg and Passau.

Tassilo III., who became duke of the Bavarians in 749, recognized the supremacy of the Frankish king Pippin the Short in 757, but soon afterwards refused to furnish a contribution to the war in Aquitaine. Moreover, during the early years of the reign of Charlemagne, Tassilo gave decisions in ecclesiastical and civil causes in his own name, refused to appear in the assemblies of the Franks, and in general acted as an independent ruler. His position as possessor of the Alpine passes, as an ally of the Avars, and as son-in-law of the Lombard king Desiderius, was so serious a menace to the Frankish kingdom that Charlemagne determined to crush him. The details of this contest are obscure. Tassilo appears to have done homage in 781, and again in 787, probably owing to the presence of Frankish armies. But further trouble soon arose, and in 788 the duke was summoned to Ingelheim, where on a charge of treachery he was sentenced to death. He was, however, pardoned by the king; and he then entered a monastery and formally renounced his duchy at Frankfort in 794. The country was ruled by Gerold, a brother-in-law of Charlemagne, till his death in a battle with the Avars in 799, when its administration was entrusted to Frankish counts and assimilated with that of the rest of the Carolingian empire, while its condition was improved by the measures taken by Charlemagne for the intellectual progress and material welfare of his realm. The Bavarians offered no resistance to the change which thus abolished their dukedom; and their incorporation with the Frankish dominions, due mainly to the unifying influence of the church, was already so complete that Charlemagne did not find it necessary to issue more than two capitularies dealing especially with Bavarian affairs.

The history of Bavaria for the ensuing century is bound up with that of the Carolingian empire. Given at the partition of 817 to the king of the East Franks, Louis the German, *Unloin with* it formed part of the larger territories which were *Caro-* confirmed to him in 843 by the treaty of Verdun. *lingian* Louis made Regensburg the centre of his government, *empire.* and was active in improving the condition of Bavaria, and providing for its security by numerous campaigns against the Slavs. When he divided his possessions in 865 it passed to his eldest son, Carloman, who had already undertaken its government, and after his death in 880 it formed part of the extensive territories of the emperor Charles the Fat. Its defence was left by this incompetent emperor to Arnulf, an illegitimate son of Carloman, and it was mainly owing to the support of the Bavarians that Arnulf was able to take the field against Charles in 887, and to secure his own election as German king in the following year. Bavaria, which was the centre of the East Frankish kingdom, passed in 890 to Louis the Child, during whose reign it was constantly ravaged by the Hungarians. The resistance to these inroads became gradually feebler, and it is said that on the 5th of July 907 almost the whole of the Bavarian race perished in battle with these formidable enemies. For the defence of Bavaria the mark of Carinthia had been erected on the south-eastern frontier, and during the reign of Louis the Child this was ruled by Liutpold, count of Scheeyern, who possessed large domains in Bavaria. He was among those who fell in the great fight of 907; but his son Arnulf, surnamed the Bad, rallied the remnants of the race, drove back the Hungarians, and was chosen duke of the Bavarians in 911, when Bavaria and Carinthia were united under his rule. Refusing to acknowledge the supremacy of the German king Conrad I. he was unsuccessfully attacked by the latter, and in 920 was recognized as duke by Conrad's successor, Henry I., the Fowler, who admitted his

Christianity.

Frankish conquest.

Frankish influence.

right to appoint the bishops, to coin money and to issue laws. A similar conflict took place between Arnulf's son and successor

Eberhard and Otto the Great; but Eberhard was less successful than his father, for in 938 he was driven from Bavaria, which was given by Otto with reduced privileges to the late duke's uncle, Bertold; and a count palatine in the person of Eberhard's brother Arnulf was appointed to watch the royal interests. When Bertold died in 947 Otto conferred the duchy upon his own brother Henry, who had married Judith, a daughter of Duke Arnulf. Henry was disliked by the Bavarians and his short reign was spent mainly in disputes with his people. The ravages of the Hungarians ceased after their defeat on the Lechfeld in 955, and the area of the duchy was temporarily increased by the addition of certain adjacent districts in Italy. In 955 Henry was succeeded by his young son Henry, surnamed the Quarrelsome, who in 974 was implicated in a conspiracy against King Otto II. The reason for this rising was that the king had granted the duchy of Swabia to Henry's enemy, Otto, a grandson of the emperor Otto the Great, and had given the new Bavarian East Mark, afterwards known as Austria, to Leopold I., count of Babenberg. The revolt was, however, soon suppressed; but Henry, who on his escape from prison renewed his plots, was formally deposed in 976 when Bavaria was given to Otto, duke of Swabia. At the same time Carinthia was made into a separate duchy, the office of count palatine was restored, and the church was made dependent on the king instead of on the duke. Restored in 985, Henry proved himself a capable ruler by establishing internal order, issuing important laws and taking measures to reform the monasteries. His son and successor, who was chosen German king as Henry II. in 1002, gave Bavaria to his brother-in-law Henry of Luxemburg; after whose death in 1026 it passed successively to Henry, afterwards the emperor Henry III., and to another member of the family of Luxemburg, as Duke Henry VII. In 1061 the empress Agnes, mother of and regent for the German king Henry IV., entrusted the duchy to Otto of Nordheim, who was deposed by the king in 1070, when the duchy was granted to Count Welf, a member of an influential Bavarian family. In consequence of his support of Pope Gregory VII. in his quarrel with Henry, Welf lost but subsequently regained Bavaria; and was followed successively by his sons, Welf II. in 1101, and Henry IX. in 1120, both of whom exercised considerable influence among the German princes. Henry was succeeded in 1126 by his son Henry X., called the Proud, who obtained the duchy of Saxony in 1137. Alarmed at this prince's power, King Conrad III. refused to allow two duchies to remain in the same hands; and, having declared Henry deposed, he bestowed Bavaria upon Leopold IV., margrave of Austria. When Leopold died in 1141, the king retained the duchy himself; but it continued to be the scene of considerable disorder, and in 1143 he entrusted it to Henry II., surnamed Jasomirgott, margrave of Austria. The struggle for its possession continued until 1156, when King Frederick I. in his desire to restore peace to Germany persuaded Henry to give up Bavaria to Henry the Lion, a son of Duke Henry the Proud.

The duchy passes to the Welfs.

A new era of government set in when, in consequence of Henry being placed under the imperial ban in 1180, the duchy was given by Frederick I. to Otto, a member of the old Bavarian family of Wittelsbach (*q.v.*), and a descendant of the counts of Scheeyern. During the years following the destruction of the Carolingian empire the borders of Bavaria were continually changing, and for a lengthened period after 955 this process was one of expansion. To the west the Lech still divided Bavaria from Swabia, but on three other sides the opportunities for extension had been taken advantage of, and the duchy embraced an area of considerable dimensions north of the Danube. During the later years of the rule of the Welfs, however, a contrary tendency had operated, and the extent of Bavaria had been reduced. The immense energies of Duke Henry the Lion had been devoted to his northern rather than his southern duchy, and when the

Then to the Wittelsbachs.

dispute over the Bavarian succession was settled in 1156 the district between the Enns and the Inn had been transferred to Austria. The increasing importance of the mark of Styria, erected into a duchy in 1180, and the county of Tirol, had diminished both the actual and the relative strength of Bavaria, which was now deprived on almost all sides of opportunities for expansion. The neighbouring duchy of Carinthia, the great temporal possessions of the archbishop of Salzburg, as well as a general tendency to independence on the part of both clerical and lay nobles, were additional forces of similar influence.

When Otto of Wittelsbach was invested with Bavaria at Altenburg in September 1180 the duchy was bounded by the Böhmerwald, the Inn, the Alps and the Lech; and the power of the duke was practically confined to his extensive private domains around Wittelsbach, Kelheim and Straubing. Otto only enjoyed his new dignity for three years, and was succeeded in 1183 by his son Louis I., who took a leading part in German affairs during the earlier years of the reign of the emperor Frederick II., and was assassinated at Kelheim in September 1231. His son Otto II., called the Illustrious, was the next duke, and his loyalty to the Hohenstaufen caused him to be placed under the papal ban, and Bavaria to be laid under an interdict. Like his father, Otto increased the area of his lands by purchases; and he had considerably strengthened his hold upon the duchy before he died in November 1253. The efforts of the dukes to increase their power and to give unity to the duchy had met with a fair measure of success; but they were soon vitiated by partitions among different members of the family which for 250 years made the history of Bavaria little more than a jejune chronicle of territorial divisions bringing war and weakness in their train. The first of these divisions was made in 1255 between Louis II. and Henry I., the sons of Duke Otto II., who for two years after their father's death had ruled Bavaria jointly; and by it Louis obtained the western part of the duchy, afterwards called Upper Bavaria, and Henry secured eastern or Lower Bavaria. In the course of a long reign Louis, who was called the Stern, became the most powerful prince in southern Germany. He was the uncle and guardian of Conradin of Hohenstaufen, and when this prince was put to death in Italy in 1268, Louis and his brother Henry inherited the domains of the Hohenstaufen in Swabia and elsewhere. He supported Rudolph, count of Habsburg, in his efforts to secure the German throne in 1273, married the new king's daughter Mechtild, and aided him in campaigns in Bohemia and elsewhere. For some years after Louis' death in 1294 his sons Rudolph I. and Louis, afterwards the emperor Louis IV., ruled their duchy in common; but as their relations were never harmonious a division of Upper Bavaria was made in 1310, by which Rudolph received the land east of the Isar together with the town of Munich, and Louis the district between the Isar and the Lech. It was not long, however, before this arrangement led to war between the brothers, the outcome of which was that in 1317, three years after he had been chosen German king, Louis compelled Rudolph to abdicate, and for twelve years ruled alone over the whole of Upper Bavaria. But in 1329 a series of events induced him to conclude the treaty of Pavia with Rudolph's sons, Rudolph and Rupert, to whom he transferred the Palatinate of the Rhine, which had been in the possession of the Wittelsbach family since 1214, and also a portion of Upper Bavaria north of the Danube, which was afterwards called the Upper Palatinate. At the same time it was decided that the electoral vote should be exercised by the two lines alternately, and that in the event of either branch of the family becoming extinct the surviving branch should inherit its possessions.

Henry I. of Lower Bavaria spent most of his time in quarrels with his brother, with Ottakar II. of Bohemia and with various ecclesiastics. When he died in February 1200 Lower Bavaria was ruled by his three sons, Otto III., Louis III. and Stephen I. Louis died childless in 1206; Stephen left two sons at his death in 1310, namely, Henry II. and Otto IV., and Otto, who was king of Hungary from 1305 to

Rule of the Wittelsbachs.

Division of the duchy.

Upper Bavaria.

Lower Bavaria.

Area of Bavaria.

1308, died in 1312, leaving a son, Henry III. Lower Bavaria was governed by these three princes until 1333, when Henry III. died, followed in 1334 by his cousin Otto; and as both died without sons the whole of Lower Bavaria then passed to Henry II. Dying in 1339, Henry left an only son, John I., who died childless

Re-union of the duchy.

in the following year, when the emperor Louis IV., by securing Lower Bavaria for himself, united the whole of the duchy under his sway. The consolidation of Bavaria under Louis lasted for seven years, during which the emperor was able to improve the condition of the country. When he died in 1347 he left six sons to share his possessions, who agreed upon a division of Bavaria in 1349. Its history, however, was complicated by its connexion with Brandenburg, Holland and Tirol, all of which had also been left by the emperor to his sons. All the six brothers exercised some authority in Bavaria; but three alone left issue, and of these the eldest, Louis, margrave of Brandenburg, died in 1367; and two years later was followed to the grave by his only son Meinhard, who was childless. The two remaining brothers, Stephen II. and Albert I., ruled over Bavaria-Landshut and Bavaria-Straubing respectively, and when Stephen died in 1375 his portion of Bavaria was governed jointly by his three sons. In 1392, when all the lines except those of Stephen and Albert had died out, an important partition took place, by which the greater part of the duchy was divided among Stephen's three sons, Stephen III., Frederick and John II., who founded respectively the lines of Ingolstadt, Landshut and Munich. Albert's duchy of Bavaria-Straubing passed on his death in 1404 to his son William II., and in 1417 to his younger son John, who resigned the bishopric of Liège to take up his new position. When John died in 1425 this family became extinct, and after a contest between various claimants Bavaria-Straubing was divided between the three remaining branches of the family.

The main result of the threefold division of 1392 was a succession of civil wars which led to the temporary eclipse of Bavaria as a force in German politics. Neighbouring states encroached upon its borders, and the nobles ignored the authority of the dukes, who, deprived of the electoral vote, were mainly occupied for fifty years with intestine strife. This condition of affairs, however, was not wholly harmful. The government of the country and the control of the finances passed mainly into the hands of an assembly called the *Landtag* or *Landschaft*, which had been organized in 1392. The towns, assuming a certain independence, became strong and wealthy as trade increased, and the citizens of Munich and Regensburg were often formidable antagonists to the dukes. Thus a period of disorder saw the growth of representative institutions and the establishment of a strong civic spirit. Stephen III., duke of Bavaria-Ingolstadt, was distinguished rather as a soldier than as a statesman; and his rule was marked by struggles with various towns, and with his brother, John of Bavaria-Munich. Dying in 1413 he was followed by his son, Louis, called the Bearded, a restless and quarrelsome prince, who before his accession had played an important part in the affairs of France, where his sister Isabella was the queen of King Charles VI. About 1417 he became involved in a violent quarrel with his cousin, Henry of Bavaria-Landshut, fell under both the papal and the imperial ban, and in 1439 was attacked by his son Louis the Lame. This prince, who had married a daughter of Frederick I. of Hohenzollern, margrave of Brandenburg, was incensed at the favour shown by his father to an illegitimate son. Aided by Albert Achilles, afterwards margrave of Brandenburg, he took the elder Louis prisoner and compelled him to abdicate in 1443. When Louis the Lame died in 1445 his father came into the power of his implacable enemy, Henry of Bavaria-Landshut, and died in prison in 1447. The duchy of Bavaria-Ingolstadt passed to Henry, who had succeeded his father Frederick as duke of Bavaria-Landshut in 1393, and whose long reign was almost entirely occupied with family feuds. He died in July 1450, and was followed by his son, Louis IX. (called the Rich), and about this time Bavaria began to recover some of its former importance.

Intestine troubles.

Louis IX. expelled the Jews from his duchy, did something for the security of traders, and improved both the administration of justice and the condition of the finances. In 1472 he founded the university of Ingolstadt, attempted to reform the monasteries, and was successful in a struggle with Albert Achilles of Brandenburg. On his death in January 1479 he was succeeded by his son George, also called the Rich; and when George, a faithful adherent of the German king Maximilian I., died without sons in December 1503, a war broke out for the possession of his duchy. Bavaria-Munich passed on the death of John II. in 1397 to his sons Ernest and William III., but they only obtained possession of their lands after a struggle with Stephen of Bavaria-Ingolstadt. Both brothers were then engaged in warfare with the other branches of the family and with the citizens of Munich. William, a loyal servant of the emperor Sigismund, died in 1435, leaving an only son, Adolf, who died five years later; and Ernest, distinguished for his bodily strength, died in 1438. In 1440 the whole of Bavaria-Munich came to Ernest's son Albert, who had been estranged from his father owing to his union with the unfortunate Agnes Bernauer (*q.v.*). Albert, whose attempts to reform the monasteries earned for him the surname of Pious, was almost elected king of Bohemia in 1440. He died in 1460, leaving five sons, the two elder of whom, John IV. and Sigismund, reigned in common until the death of John in 1463. The third brother, Albert, who had been educated for the church, joined his brother in 1465, and when Sigismund abdicated two years later became sole ruler in spite of the claims of his two younger brothers. Albert, who was called the Wise, added the district of Abensberg to his possessions, and in 1504 became involved in the war which broke out for the possession of Bavaria-Landshut on the death of George the Rich. Albert's rival was George's son-in-law, Rupert, formerly bishop of Freising, and son of Philip, count palatine of the Rhine; and the emperor Maximilian I., interested as archduke of Austria and count of Tirol, interfered in the dispute. Rupert died in 1504, and the following year an arrangement was made at the diet of Cologne by which the emperor and Philip's grandson, Otto Henry, obtained certain outlying districts, while Albert by securing the bulk of George's possessions united Bavaria under his rule. In 1506 Albert decreed that the duchy should pass undivided according to the rules of primogeniture, and endeavoured in other ways also to consolidate Bavaria. He was partially successful in improving the condition of the country; and in 1500 Bavaria formed one of the six circles into which Germany was divided for the maintenance of peace. He died in March 1508, and was succeeded by his son, William IV., whose mother, Kunigunde, was a daughter of the emperor Frederick III. In spite of the decree of 1506 William was compelled in 1516, after a violent quarrel, to grant a share in the government to his brother Louis, an arrangement which lasted until the death of Louis in 1545.

Roman Catholicism to Bavaria.

William followed the traditional Wittelsbach policy, opposition to the Habsburgs, until in 1534 he made a treaty at Linz with Ferdinand, king of Hungary and Bohemia. This was strengthened in 1546, when the emperor Charles V. obtained the help of the duke during the war of the league of Schmalkalden by promising him in certain eventualities the succession to the Bohemian throne, and the electoral dignity enjoyed by the count palatine of the Rhine. William also did much at a critical period to secure Bavaria for Catholicism. The reformed doctrines had made considerable progress in the duchy when the duke obtained from the pope extensive rights over the bishoprics and monasteries, and took measures to repress the reformers, many of whom were banished; while the Jesuits, whom he invited into the duchy in 1541, made the university of Ingolstadt their headquarters for Germany. William, whose death occurred in March 1550, was succeeded by his son Albert IV., who had married a daughter of Ferdinand of Habsburg, afterwards the emperor Ferdinand I. Early in his reign Albert made some concessions to the reformers, who were still strong in Bavaria; but about 1563 he changed his attitude, favoured the decrees of the council of Trent, and pressed forward the work of

Louis IX. expelled the Jews from his duchy, did something for the security of traders, and improved both the administration of justice and the condition of the finances. In 1472 he founded the university of Ingolstadt, attempted to reform the monasteries, and was successful in a struggle with Albert Achilles of Brandenburg. On his death in January 1479 he was succeeded by his son George, also called the Rich; and when George, a faithful adherent of the German king Maximilian I., died without sons in December 1503, a war broke out for the possession of his duchy.

Bavaria-Munich passed on the death of John II. in 1397 to his sons Ernest and William III., but they only obtained possession of their lands after a struggle with Stephen of Bavaria-Ingolstadt. Both brothers were then engaged in warfare with the other branches of the family and with the citizens of Munich. William, a loyal servant of the emperor Sigismund, died in 1435, leaving an only son, Adolf, who died five years later; and Ernest, distinguished for his bodily strength, died in 1438. In 1440 the whole of Bavaria-Munich came to Ernest's son Albert, who had been estranged from his father owing to his union with the unfortunate Agnes Bernauer (*q.v.*). Albert, whose attempts to reform the monasteries earned for him the surname of Pious, was almost elected king of Bohemia in 1440. He died in 1460, leaving five sons, the two elder of whom, John IV. and Sigismund, reigned in common until the death of John in 1463. The third brother, Albert, who had been educated for the church, joined his brother in 1465, and when Sigismund abdicated two years later became sole ruler in spite of the claims of his two younger brothers. Albert, who was called the Wise, added the district of Abensberg to his possessions, and in 1504 became involved in the war which broke out for the possession of Bavaria-Landshut on the death of George the Rich. Albert's rival was George's son-in-law, Rupert, formerly bishop of Freising, and son of Philip, count palatine of the Rhine; and the emperor Maximilian I., interested as archduke of Austria and count of Tirol, interfered in the dispute. Rupert died in 1504, and the following year an arrangement was made at the diet of Cologne by which the emperor and Philip's grandson, Otto Henry, obtained certain outlying districts, while Albert by securing the bulk of George's possessions united Bavaria under his rule. In 1506 Albert decreed that the duchy should pass undivided according to the rules of primogeniture, and endeavoured in other ways also to consolidate Bavaria. He was partially successful in improving the condition of the country; and in 1500 Bavaria formed one of the six circles into which Germany was divided for the maintenance of peace. He died in March 1508, and was succeeded by his son, William IV., whose mother, Kunigunde, was a daughter of the emperor Frederick III. In spite of the decree of 1506 William was compelled in 1516, after a violent quarrel, to grant a share in the government to his brother Louis, an arrangement which lasted until the death of Louis in 1545.

War over the succession to Bavaria-Landshut.

Reigns of Albert the Wise and William IV.

William followed the traditional Wittelsbach policy, opposition to the Habsburgs, until in 1534 he made a treaty at Linz with Ferdinand, king of Hungary and Bohemia. This was strengthened in 1546, when the emperor Charles V. obtained the help of the duke during the war of the league of Schmalkalden by promising him in certain eventualities the succession to the Bohemian throne, and the electoral dignity enjoyed by the count palatine of the Rhine. William also did much at a critical period to secure Bavaria for Catholicism. The reformed doctrines had made considerable progress in the duchy when the duke obtained from the pope extensive rights over the bishoprics and monasteries, and took measures to repress the reformers, many of whom were banished; while the Jesuits, whom he invited into the duchy in 1541, made the university of Ingolstadt their headquarters for Germany. William, whose death occurred in March 1550, was succeeded by his son Albert IV., who had married a daughter of Ferdinand of Habsburg, afterwards the emperor Ferdinand I. Early in his reign Albert made some concessions to the reformers, who were still strong in Bavaria; but about 1563 he changed his attitude, favoured the decrees of the council of Trent, and pressed forward the work of

War over the succession to Bavaria-Landshut.

Reigns of Albert the Wise and William IV.

William followed the traditional Wittelsbach policy, opposition to the Habsburgs, until in 1534 he made a treaty at Linz with Ferdinand, king of Hungary and Bohemia. This was strengthened in 1546, when the emperor Charles V. obtained the help of the duke during the war of the league of Schmalkalden by promising him in certain eventualities the succession to the Bohemian throne, and the electoral dignity enjoyed by the count palatine of the Rhine. William also did much at a critical period to secure Bavaria for Catholicism. The reformed doctrines had made considerable progress in the duchy when the duke obtained from the pope extensive rights over the bishoprics and monasteries, and took measures to repress the reformers, many of whom were banished; while the Jesuits, whom he invited into the duchy in 1541, made the university of Ingolstadt their headquarters for Germany. William, whose death occurred in March 1550, was succeeded by his son Albert IV., who had married a daughter of Ferdinand of Habsburg, afterwards the emperor Ferdinand I. Early in his reign Albert made some concessions to the reformers, who were still strong in Bavaria; but about 1563 he changed his attitude, favoured the decrees of the council of Trent, and pressed forward the work of

the Counter-Reformation. As education passed by degrees into the hands of the Jesuits the progress of Protestantism was effectually arrested in Bavaria. Albert IV. was a great patron of art. His court at Munich was the resort of artists of all kinds, and the city was enriched with splendid buildings; while artistic works were collected from Italy and elsewhere. The expenses of a magnificent court led the duke to quarrel with the *Landschaft*, to oppress his subjects, and to leave a great burden of debt when he died in October 1579. The succeeding duke was Albert's son, William V. (called the Pious), who was educated by the Jesuits and was keenly attached to their tenets. He secured the archbishopric of Cologne for his brother Ernest in 1583, and this dignity remained in the possession of the family for nearly 200 years. In

1597 he abdicated in favour of his son Maximilian I., and retired into a monastery, where he died in 1626. Maximilian found the duchy encumbered with debt and filled with disorder, but ten years of his vigorous rule effected a remarkable change. The finances and the judicial system were reorganized, a class of civil servants and a national militia founded, and several small districts were brought under the duke's authority. The result was a unity and order in the duchy which enabled Maximilian to play an important part in the Thirty Years' War; during the earlier years of which he was so successful as to acquire the Upper Palatinate and the electoral dignity which had been enjoyed since 1356 by the elder branch of the Wittelsbach family. In spite of subsequent reverses these gains were retained by Maximilian at the peace of Westphalia in 1648. During the later years of this war Bavaria, especially the northern part, suffered severely. In 1632 it was invaded by the Swedes, and, when Maximilian violated the treaty of Ulm in 1647, was ravaged by the French and the Swedes. After repairing this damage to some extent, the elector died at Ingolstadt in September 1651, leaving his duchy much stronger than he had found it. The recovery of the Upper Palatinate made Bavaria compact; the acquisition of the electoral vote made it influential; and the duchy was able to play a part in European politics which intestine strife had rendered impossible for the past four hundred years. (A. W. H.*)

Whatever lustre the international position won by Maximilian I. might add to the ducal house, on Bavaria itself its effect during the next two centuries was more dubious. Maximilian's son, Ferdinand Maria (1651-1679), who was a minor when he succeeded, did much indeed to repair the wounds caused by the Thirty Years' War, encouraging agriculture and industries, and building or restoring numerous churches and monasteries. In 1669, moreover, he again called a meeting of the diet, which had been suspended since 1612. His good work, however, was largely undone by his son Maximilian II. Emmanuel (1679-1726), whose far-reaching ambition set him warring against the Turks and, on the side of France, in the great struggle of the Spanish succession. He shared in the defeat at Höchstädt on the 13th of August 1704; his dominions were temporarily partitioned between Austria and the elector palatine, and only restored to him, harried and exhausted, at the peace of Baden in 1714. Untaught by Maximilian Emmanuel's experience, his son, Charles Albert (1726-1745), devoted all his energies to increasing the European prestige and power of his house. The death of the emperor Charles VI. was his opportunity; he disputed the validity of the Pragmatic Sanction which secured the Habsburg succession to Maria Theresa, allied himself with France, conquered Upper Austria, was crowned king of Bohemia at Prague and, in 1742, emperor at Frankfurt. The price he had to pay, however, was the occupation of Bavaria itself by Austrian troops; and, though the invasion of Bohemia in 1744 by Frederick II. of Prussia enabled him to return to Munich, at his death on the 20th of January 1745 it was left to his successor to make what terms he could for the recovery of his dominions. Maximilian III. Joseph (1745-1777), by the peace of Füssen signed on the 22nd of April 1745, obtained the restitution of his dominions in return for a formal acknowledgment of the Pragmatic Sanction. He was a man of enlightenment, did much to encourage agri-

culture, industries and the exploitation of the mineral wealth of the country, founded the Academy of Sciences at Munich, and abolished the Jesuit censorship of the press. At his death, without issue, on the 30th of December 1777, the Bavarian line of the Wittelsbachs became extinct, and the succession passed to Charles Theodore, the elector palatine. After a separation of four and a half centuries, the Palatinate, to which the duchies of Jülich and Berg had been added, was thus reunited with Bavaria. So great an accession of strength to a neighbouring state, whose ambition she had so recently had just reason to fear, was intolerable to Austria, which laid claim to a number of lordships—forming one-third of the whole Bavarian inheritance—as lapsed fiefs of the Bohemian, Austrian, and imperial crowns. These were at once occupied by Austrian troops, with the secret consent of Charles Theodore himself, who was without legitimate heirs, and wished to obtain from the emperor the elevation of his natural children to the status of princes of the Empire. The protests of the next heir, Charles, duke of Zweibrücken (Deux-Ponts), supported by the king of Prussia, led to the war of Bavarian succession. By the peace of Teschen (May 13th, 1779) the Inn quarter was ceded to Austria, and the succession secured to Charles of Zweibrücken. For Bavaria itself Charles Theodore did less than nothing. He felt himself a foreigner among foreigners, and his favourite scheme, the subject of endless intrigues with the Austrian cabinet and the immediate cause of Frederick II.'s League of Princes (*Fürstenbund*) of 1785, was to exchange Bavaria for the Austrian Netherlands and the title of king of Burgundy. For the rest, the enlightened internal policy of his predecessor was abandoned. The funds of the suppressed order of Jesus, which Maximilian Joseph had destined for the reform of the educational system of the country, were used to endow a province of the knights of St John of Jerusalem, for the purpose of combating the enemies of the faith. The government was inspired by the narrowest clericalism, which culminated in the attempt to withdraw the Bavarian bishops from the jurisdiction of the great German metropolitans and place them directly under that of the pope. On the eve of the Revolution the intellectual and social condition of Bavaria remained that of the middle ages.

In 1792 the revolutionary armies overran the Palatinate; in 1795 the French, under Moreau, invaded Bavaria itself, advanced to Munich—where they were received with joy by the long-suppressed Liberals—and laid siege to Ingolstadt. Charles Theodore, who had done nothing to prevent or to resist the invasion, fled to Saxony, leaving a regency, the members of which signed a convention with Moreau, by which he granted an armistice in return for a heavy contribution (September 7th, 1796). Immediately afterwards he was forced to retire.

Between the French and the Austrians, Bavaria was now in an evil case. Before the death of Charles Theodore (February 16th, 1799) the Austrians had again occupied the country, preparatory to renewing the war with France. Maximilian IV. Joseph (of Zweibrücken), the new elector, succeeded to a difficult inheritance. Though his own sympathies, and those of his all-powerful minister, Max Josef von Montgelas (*q.v.*), were, if anything, French rather than Austrian, the state of the Bavarian finances, and the fact that the Bavarian troops were scattered and disorganized, placed him helpless in the hands of Austria; on the 2nd of December 1800 the Bavarian arms were involved in the Austrian defeat at Hohenlinden, and Moreau once more occupied Munich. By the treaty of Lunéville (February 9th, 1801) Bavaria lost the Palatinate and the duchies of Zweibrücken and Jülich.

In view of the scarcely disguised ambitions and intrigues of the Austrian court, Montgelas now believed that the interests of Bavaria lay in a frank alliance with the French republic; he succeeded in overcoming the reluctance of Maximilian Joseph; and, on the 24th of August, a separate treaty of peace and alliance with France was signed at Paris. By the third article of this the First Consul undertook to see that the compensation promised under the 7th article

Reign of Maximilian I. and the Thirty Years' War.

Beginning of modern period.

Re-union of the Palatinate.

The revolutionary wars.

French influence.

of the treaty of Lunéville for the territory ceded on the left bank of the Rhine, should be carried out at the expense of the Empire in the manner most agreeable to Bavaria (de Martens, *Recueil*, vol. vii. p. 365). In 1803, accordingly, in the territorial rearrangements consequent on Napoleon's suppression of the ecclesiastical states, and of many free cities of the Empire, Bavaria received the bishoprics of Würzburg, Bamberg, Augsburg and Freisingen, part of that of Passau, the territories of twelve abbeys, and seventeen cities and villages, the whole forming a compact territory which more than compensated for the loss of her outlying provinces on the Rhine.¹ Montgelas' ambition was now to raise Bavaria to the rank of a first-rate power, and he pursued this object during the Napoleonic epoch with consummate skill, allowing fully for the preponderance of France—so long as it lasted—but never permitting Bavaria to sink, like so many of the states of the confederation of the Rhine, into a mere French dependency. In the war of 1805, in accordance with a treaty of alliance signed at Würzburg on the 23rd of September, Bavarian troops, for the first time since Charles VII., fought side by side with the French, and by the treaty of Pressburg, signed on the 26th of December, the principality of Eichstätt, the margraviate of Burgau, the lordship of Voralberg, the countships of Hohenems and Königsegg-Rothenfels, the lordships of Argen and Tetnang, and the city of Lindau with its territory were to be added to Bavaria. On the other hand Würzburg, obtained in 1803, was to be ceded by Bavaria to the elector of Salzburg in exchange for Tirol. By the 1st article of the treaty the emperor acknowledged the assumption by the elector of the title of king, as Maximilian I.² The price which Maximilian had reluctantly to pay for this accession of dignity was the marriage of his daughter Augusta with Eugène Beauharnais.

For the internal constitution of Bavaria also the French alliance had noteworthy consequences. Maximilian himself was an "enlightened" prince of the 18th-century type, whose tolerant principles had already grievously offended his clerical subjects; Montgelas was a firm believer in drastic reform "from above," and, in 1803, had discussed with the rump of the old estates the question of reforms. But the revolutionary changes introduced by the constitution proclaimed on the 1st of May 1808 were due to the direct influence of Napoleon. A clean sweep was made of the medieval polity surviving in the somnolent local diets and corporations. In place of the old system of privileges and exemptions were set equality before the law, universal liability to taxation, abolition of serfdom, security of person and property, liberty of conscience and of the press. A representative assembly was created on paper, based on a narrow franchise and with very limited powers, but was never summoned.

In 1809 Bavaria was again engaged in war with Austria on the side of France, and by the treaty signed at Paris on the 28th of February 1810 ceded southern Tirol to Italy and some small districts to Württemberg, receiving as compensation parts of Salzburg, the quarters of the Inn and Hausrück and the principalities of Bayreuth and Regensburg. So far the policy of Montgelas had been brilliantly successful; but the star of Napoleon had now reached its zenith, and already the astute opportunist had noted the signs of the coming change. The events of 1812 followed; in 1813 Bavaria was summoned to join the alliance against Napoleon, the demand being passionately backed by the crown prince Louis and by Marshal Wrede; on

the 8th of October was signed the treaty of Ried, by which Bavaria threw in her lot with the Allies. Montgelas announced to the French ambassador that he had been compelled temporarily to bow before the storm, adding "Bavaria has need of France." (For Bavaria's share in the war see NAPOLEONIC CAMPAIGNS.)

Immediately after the first peace of Paris (1814), Bavaria ceded to Austria Tirol and Vorarlberg; by the congress of

Vienna it was decided that she was to add to these the greater part of Salzburg and the quarters of the Inn and Hausrück, receiving as compensation, besides Würzburg and Aschaffenburg, the Palatinate on the left bank of the Rhine and certain districts of Hesse and of the former abbacy of Fulda. But with the collapse of France the old fear and jealousy of Austria had revived in full force, and Bavaria only agreed to these cessions (treaty of Munich, April 16th, 1816) on Austria promising that, in the event of the powers ignoring her claim to the Baden succession in favour of that of the line of the counts of Hochberg, she should receive also the Palatinate on the right bank of the Rhine. The question was thus left open, the tension between the two powers remained extreme, and war was only averted by the authority of the Grand Alliance. At the congress of Aix (1818) the question of the Baden succession was settled in favour of the Hochberg line, without the compensation stipulated for in the treaty of Munich; and by the treaty of Frankfort, signed on behalf of the four great powers on the 20th of July 1819, the territorial questions at issue between Bavaria and Austria were settled, in spite of the protests of the former, in the general sense of the arrangement made at Vienna. A small strip of territory was added, to connect Bavaria with the Palatinate, and Bavarian troops were to garrison the federal fortress of Mainz.

Meanwhile, on the 1st of February 1817, Montgelas had been dismissed; and Bavaria had entered on a new era of constitutional reform. This implied no breach with the European policy of the fallen minister. In the new German confederation Bavaria had assumed the rôle of defender of the smaller states against the ambitions of Austria and Prussia, and Montgelas had dreamed of a Bavarian hegemony in South Germany similar to that of Prussia in the north. It was to obtain popular support for this policy and for the Bavarian claims on Baden that the crown prince pressed for a liberal constitution, the reluctance of Montgelas to concede it being the cause of his dismissal. On the 26th of May 1818 the constitution was proclaimed. The parliament was to consist of two houses; the first comprising the great hereditary landowners, government officials and nominees of the crown; the second, elected on a very narrow franchise, representatives of the small land-owners, the towns and the peasants. By additional articles the equality of religions was guaranteed and the rights of Protestants safeguarded, concessions which had been signed immediately before. The result of the constitutional experiment hardly justified the royal expectations; the parliament was hardly opened (February 5th, 1819) before the doctrinaire radicalism of some of its members, culminating in the demand that the army should swear allegiance to the constitution, so alarmed the king, that he appealed to Austria and Germany, undertaking to carry out any repressive measures they might recommend. Prussia, however, refused to approve of any *coup d'état*; the parliament, chastened by the consciousness that its life depended on the goodwill of the king, moderated its tone; and Maximilian ruled till his death as a model constitutional monarch. On the 13th of October 1825, he was succeeded by his son, Louis I., an enlightened patron of the arts and sciences, who transferred the university of Landshut to Munich, which, by his magnificent taste in building, he transformed into one of the most beautiful cities of the continent. The earlier years of his reign were marked by a liberal spirit and the reform, especially, of the financial administration; but the revolutions of 1831 frightened him into reaction, which was accentuated by the opposition of the parliament to his expenditure on building and works of art. In 1837 the Ultramontanes came into power with Karl von Abel (1788-1859) as prime minister. The Jesuits now gained the upper hand; one by one the liberal provisions of the constitution were modified or annulled; the Protestants were harried and oppressed; and a rigorous censorship forbade any free discussion of internal politics. The collapse of this régime was due, not to popular agitation, but to the resentment of Louis at the clerical

Relations with Austria.

Constitution of 1818.

¹ See *Recès de la députation de l'empire . . . du 25 fév. 1803, &c.*, § 11, vol. vii. p. 453 of G. F. de Martens, *Recueil des Traités*, 5. (Gottingue, 1831).

² Text in de Martens' *Recueil*, viii. p. 388.

opposition to the influence of his mistress, Lola Montez. On the 17th of February 1847, Abel was dismissed, for publishing his memorandum against the proposal to naturalize Lola, who was an Irishwoman; and the Protestant Georg Ludwig von Maurer (*q.v.*) took his place. The new ministry granted the certificate of naturalization; but riots, in which ultramontane professors of the university took part, were the result. The professors were deprived, the parliament dissolved, and, on the 27th of November, the ministry dismissed. Lola Montez, created Countess Landsfeld, was supreme in the state; and the new minister, Prince Ludwig von Oettingen-Wallerstein (1791-1870), in spite of his efforts to enlist Liberal sympathy by appeals to pan-German patriotism, was powerless to form a stable government. His cabinet was known as the "Lolaministerium"; in February 1848, stimulated by the news from Paris, riots broke out against the countess; on the 11th of March the king dismissed Oettingen, and on the 20th, realizing the force of public opinion against him, abdicated in favour of his son, Maximilian II.

Before his abdication Louis had issued, on the 6th of March, a proclamation promising the zealous co-operation of the Bavarian government in the work of German freedom and unity. To the spirit of this Maximilian was faithful, accepting the authority of the central government at Frankfurt, and (19th of December) sanctioning the official promulgation of the laws passed by the German parliament. But Prussia was henceforth the enemy, not Austria. In refusing to agree to the offer of the imperial crown to Frederick William IV., Maximilian had the support of his parliament. In withholding his assent to the new German constitution, by which Austria was excluded from the Confederation, he ran indeed counter to the sentiment of his people; but by this time the back of the revolution was broken, and in the events which led to the humiliation of Prussia at Olmütz in 1851, and the restoration of the old diet of the Confederation, Bavaria was safe in casting in her lot with Austria (see GERMANY: *History*). The guiding spirit in this anti-Prussian policy, which characterized Bavarian statesmanship up to the war of 1866, was Ludwig Karl Heinrich von der Pförtlen (1811-1880), who became minister for foreign affairs on the 19th of April 1849. His idea for the ultimate solution of the question of the balance of power in Germany was the so-called *Trias*, i.e. a league of the Rhenish states as a counterpoise to the preponderance of Austria and Prussia. In internal affairs his ministry was characterized by a reactionary policy less severe than elsewhere in Germany, which led none the less from 1854 onward to a struggle with the parliament, which ended in the dismissal of Pförtlen's ministry on the 27th of March 1859. He was succeeded by Karl Freiherr von Schrenk auf Notzing (1806-1884), an official of Liberal tendencies who had been Bavarian representative in the diet of the Confederation. Important reforms were now introduced, including the separation of the judicial and executive powers and the drawing up of a new criminal code. In foreign affairs Schrenk, like his predecessor, aimed at safeguarding the independence of Bavaria, and supported the idea of superseding the actual constitution of the Confederation by a supreme directory, in which Bavaria, as leader of the purely German states, would hold the balance between Prussia and Austria. Bavaria accordingly opposed the Prussian proposals for the reorganization of the Confederation, and one of the last acts of King Maximilian was to take a conspicuous part in the assembly of princes summoned to Frankfurt in 1863 by the emperor Francis Joseph (see GERMANY).

Maximilian was succeeded on the 10th of March 1864 by his son Louis II., a youth of eighteen. The government was at first carried on by Schrenk and Pförtlen in concert. Schrenk soon retired, when the Bavarian government found it necessary, in order to maintain its position in the Prussian *Zollverein*, to become a party to the Prussian commercial treaty with France, signed in 1862. In the complicated Schleswig-Holstein question (*q.v.*) Bavaria, under Pförtlen's guidance, consistently opposed Prussia, and headed the lesser states in their support of Frederick

of Augustenburg against the policy of the two great German powers. Finally, in the war of 1866, in spite of Bismarck's efforts to secure her neutrality, Bavaria sided actively with Austria.

The rapid victory of the Prussians and the wise moderation of Bismarck paved the way for a complete revolution in Bavaria's relation to Prussia and the German question. The South German Confederation, contemplated by the 6th article of the treaty of Prague, never came into being; and, though Prussia, in order not prematurely to excite the alarm of France, opposed the suggestion that the southern states should join the North German Confederation, the bonds of Bavaria, as of the other southern states, with the north, were strengthened by an offensive and defensive alliance with Prussia, as the result of Napoleon's demand for "compensation" in the Palatinate. This was signed at Berlin on the 22nd of August 1866, on the same day as the signature of the formal treaty of peace between the two countries. The separatist ambitions of Bavaria were thus formally given up; she had no longer "need of France"; and in the war of 1870-71, the Bavarian army marched, under the command of the Prussian crown prince, against the common enemy of Germany. It was on the proposal of King Louis II. that the imperial crown was offered to King William.

This was preceded, on the 23rd of November 1870, by the signature of a treaty between Bavaria and the North German Confederation. By this instrument, though Bavaria became an integral part of the new German empire, she reserved a larger measure of sovereign independence than any of the other constituent states. Thus she retained a separate diplomatic service, military administration, and postal, telegraph and railway systems. The treaty was ratified by the Bavarian chambers on the 21st of January 1871, though not without considerable opposition on the part of the so-called "patriot" party. Their hostility was increased by the *Kulturkampf*, due to the promulgation in 1870 of the dogma of papal infallibility. Munich University, where Döllinger (*q.v.*) was professor, became the centre of the opposition to the new dogma, and the "old Catholics" (*q.v.*) were protected by the king and the government. The federal law expelling the Jesuits was proclaimed in Bavaria on the 6th of September 1871 and was extended to the Redemptorists in 1873. On the 31st of March 1871, moreover, the bonds with the rest of the empire had been drawn closer by the acceptance of a number of laws of the North German Confederation, of which the most important was the new criminal code, which was finally put into force in Bavaria in 1879. The opposition of the "patriot" party, however, reinforced by the strong Catholic sentiment of the country, continued powerful, and it was only the steady support given by the king to successive Liberal ministries that prevented its finding disastrous expression in the parliament, where it remained in a greater or less majority till 1887, and has since, as the "centre," continued to form the most compact party in an assembly made up of "groups."

Meanwhile the royal dramer, whose passion for building palaces was becoming a serious drain on the treasury, had been declared insane, and, on the 7th of June 1886, the heir-presumptive, Prince Luitpold, was proclaimed regent. Six days later, on the 13th of June, Louis committed suicide. His brother, Otto I., being also insane, the regency was confirmed to Prince Luitpold.

Since 1871 Bavaria has shared to the full in the marvellous development of Germany; but her "particularism," founded on traditional racial and religious antagonism to the Prussians, was by no means dead, though it exhibited itself in no more dangerous form than the prohibition, reissued in 1900, to display any but the Bavarian flag on public buildings on the emperor's birthday; a provision which has been since so far modified as to allow the Bavarian and imperial flags to be hung side by side.

AUTHORITIES.—*Monumenta Boica* (44 vols., Munich, 1763-1900); G. T. Rudhart, *Altteste Geschichte Bayerns* (Hamburg, 1841); A. Quitzmänn, *Abstammung, Ursitte, und älteste Geschichte der Bayern* (Munich, 1857), and *Die älteste Geschichte der Bayern bis 911*

(Brunswick, 1873); S. Riezler, *Geschichte Bayerns* (Gotha, 1878-1899); Ad. Brecher, *Darstellung der geschichtlichen Entwicklung des bayerischen Staatsgebiets*, map (Berlin, 1890); E. Rosenthal, *Geschichte des Gerichtswezens und der Verwaltungsorganisation Bayerns* (Würzburg, 1889); A. Buchner, *Geschichte von Bayern* (Munich, 1820-1853); *Forschungen zur Geschichte Bayerns*, edited by K. von Reinhardt (Berlin, 1897 fol.). Much valuable detail will be found in the lives of Bavarian princes and statesmen in the *Allgemeine deutsche Biographie* (Leipzig, 1875-1906 in progr.) (W. A. P.)

BAVENO, a town of Piedmont, Italy, in the province of Novara, on the west shore of Lago Maggiore, 13 m. N.N.W. of Arona by rail. Pop. (1901) 2502. It is much frequented as a resort in spring, summer and autumn, and has many beautiful villas. To the north-west are the famous red granite quarries, which have supplied the columns for the cathedral of Milan, the church of S. Paolo fuori le Mura at Rome, the Galleria Vittorio Emanuele at Milan, and other important buildings.

BAWBEE (of very doubtful origin, the most plausible conjecture being that the word is a corruption from the name of the mint master Sillebawby, by whom they were first issued, c. 1541), the Scottish name for a halfpenny or other small coin, and hence used of money generally. A writer in 1573, quoted in Tytler's *History of Scotland*, speaks of "a coin called a bawbee, . . . which is in value English one penny and a quarter." The word was sometimes written "babie," and has therefore been identified merely with a "baby coin," but this etymology is less probable.

BAXTER, ANDREW (1686-1750), Scottish metaphysician, was born in Aberdeen and educated at King's College. He maintained himself by acting as tutor to noblemen's sons. From 1741 to 1747 he lived with Lord Blantyre and Mr Hay of Drummelzier at Utrecht, and made excursions in Flanders, France and Germany. Returning to Scotland, he lived at Whittingehame, near Edinburgh, till his death in 1750. At Spa he had met John Wilkes, then twenty years of age, and formed a lasting friendship with him. His chief work, *An Inquiry into the Nature of the Human Soul* (editions 1733, 1737 and 1745; with appendix added in 1750 in answer to an attack in MacLaurin's *Account of Sir I. Newton's Philosophical Discoveries*, and dedication to John Wilkes), examines the properties of matter. The one essential property of matter is its inactivity, *vis inertiae* (accepted later by Monboddo). All movement in matter is, therefore, caused by some immaterial force, namely, God. But the movements of the body are not analogous to the movements of matter; they are caused by a special immaterial force, the soul. The soul, as being immaterial, is immortal, and its consciousness does not depend upon its connexion with the body. The argument is supported by an analysis of the phenomena of dreams, which are ascribed to direct spiritual influences. Lastly Baxter attempted to prove that matter is finite. His work is an attack on Toland's *Letters to Serena* (1704), which argued that motion is essential to matter, and on Locke and Berkeley. His criticism of Berkeley (in the second volume) is, however, based on the common misinterpretation of his theory (see BERKELEY). Sir Leslie Stephen speaks of him as a curious example of "the effects of an exploded metaphysics on a feeble though ingenious intellect."

Beside the *Inquiry*, Baxter wrote *Matho sive Cosmotheoria Puerilis* (an exposition in Latin of the elements of astronomy written for his pupils—editions in English 1740, 1745 and 1765, with one dialogue re-written); *Evidence of Reason in Proof of the Immortality of the Soul* (published posthumously from MSS. by Dr Duncan in 1779).

See life in *Biographia Britannica*; McCosh's *Scottish Philosophy*, pp. 42-49.

BAXTER, RICHARD (1615-1691), English puritan divine, called by Dean Stanley "the chief of English Protestant Schoolmen," was born at Rowton, in Shropshire, at the house of his maternal grandfather, in November (probably the 15th) 1615. His ancestors had been gentilefolk, but his father had reduced himself to hard straits by loose living. About the time of Richard's birth, however, he changed decisively for the better. The boy's early education was poor, being mainly in the hands of the illiterate and dissolute clergy and readers who held the

neighbouring livings at that time. He was better served by John Owen, master of the free school at Wroxeter, where he studied from about 1629 to 1632, and made fair progress in Latin. On Owen's advice he did not proceed to Oxford (a step which he afterwards regretted), but went to Ludlow Castle to read with Richard Wickstead, the council's chaplain there. Wickstead neglected his pupil entirely, but Baxter's eager mind found abundant nourishment in the great library at the castle. He was persuaded—against his will—to turn his attention to a court life, and he went to London under the patronage of Sir Henry Herbert, master of the revels, to follow that course; but he very soon returned home with a fixed resolve—confirmed by the death of his mother—to study divinity. After three months' schoolmastering for Owen at Wroxeter he read theology, and especially the schoolmen, with Francis Garbet, the local clergyman. About this time (1634) he met Joseph Symonds and Walter Cradock, two famous Nonconformists, whose piety and fervour influenced him considerably. In 1638 he was nominated to the mastership of the free grammar school, Dudley, in which place he commenced his ministry, having been ordained and licensed by John Thornborough, bishop of Worcester. His success as a preacher was, at this early period, not very great; but he was soon transferred to Bridgnorth (Shropshire), where, as assistant to a Mr Madstard, he established a reputation for the vigorous discharge of the duties of his office.

He remained at Bridgnorth nearly two years, during which time he took a special interest in the controversy relating to Nonconformity and the Church of England. He soon, on some points, especially matters of discipline, became alienated from the Church; and after the requirement of what is called "the *et cetera* oath," he rejected episcopacy in its English form. He could not, however, be called more than a moderate Nonconformist; and such he continued to be throughout his life. Though commonly denominated a Presbyterian, he had no exclusive attachment to Presbyterianism, and often manifested a willingness to accept a modified Episcopalianism. All forms of church government were regarded by him as subservient to the true purposes of religion.

One of the first measures of the Long Parliament was to effect the reformation of the clergy; and, with this view, a committee was appointed to receive complaints against them. Among the complainants were the inhabitants of Kidderminster, a town which had become famous for its ignorance and depravity. This state of matters was so clearly proved that an arrangement was agreed to on the part of the vicar (Dance), by which he allowed £60 a year, out of his income £200, to a preacher who should be chosen by certain trustees. Baxter was invited to deliver a sermon before the people, and was unanimously elected as the minister of the place. This happened in April 1641, when he was twenty-six years of age.

His ministry continued, with very considerable interruptions, for about nineteen years; and during that time he accomplished a work of reformation in Kidderminster and the neighbourhood which is as notable as anything of the kind upon record. Civilized behaviour succeeded to brutality of manners; and, whereas the professors of religion had been but small exceptions to the mass, the unreligious people became the exceptions in their turn. He formed the ministers in the country around him into an association for the better fulfilment of the duties of their calling, uniting them together irrespective of their differences as Presbyterians, Episcopalians and Independents. The spirit in which he acted may be judged of from *The Reformed Pastor*, a book published in relation to the general ministerial efforts he promoted. It drives home the sense of clerical responsibility with extraordinary power. The result of his action is that, to this day his memory is cherished as that of the true apostle of the district where he laboured.

The interruptions to which his Kidderminster life was subjected arose from the condition of things occasioned by the civil war. Baxter blamed both parties, but Worcester was a cavalier county, and a man in his position was, while the war continued, exposed to annoyance and danger in a place like Kidderminster.

He therefore removed to Gloucester, and afterwards (1643-1645) settled in Coventry, where he preached regularly both to the garrison and the citizens. After the battle of Naseby he took the situation of chaplain to Colonel Whalley's regiment, and continued to hold it till February 1647. During these stormy years he wrote his *Aphorisms of Justification*, which on its appearance in 1649 excited great controversy.

Baxter's connexion with the Parliamentary army was a very characteristic one. He joined it that he might, if possible, counteract the growth of the sectaries in that field, and maintain the cause of constitutional government in opposition to the republican tendencies of the time. He regretted that he had not previously accepted an offer of Cromwell to become chaplain to the Ironsides, being confident in his power of persuasion under the most difficult circumstances. His success in converting the soldiery to his views does not seem to have been very great, but he preserved his own consistency and fidelity in a remarkable degree. By public disputation and private conference, as well as by preaching, he enforced his doctrines, both ecclesiastical and political, and shrank no more from urging what he conceived to be the truth upon the most powerful officers than he did from instructing the meanest followers of the camp. Cromwell disliked his loquacity and shunned his society; but Baxter having to preach before him after he had assumed the Protectorship, chose for his subject the old topic of the divisions and distractions of the church, and in subsequent interviews not only opposed him about liberty of conscience, but spoke in favour of the monarchy he had subverted. There is a striking proof of Baxter's insight into character in his account of what happened under these circumstances. Of Cromwell he says, "I saw that what he learned must be from himself." It is worthy of notice that this intercourse with Cromwell occurred when Baxter was summoned to London to assist in settling "the fundamentals of religion," and made the memorable declaration, in answer to the objection that what he had proposed as fundamental "might be subscribed by a Papist or Socinian,"—"So much the better, and so much the fitter it is to be the matter of concord." In 1647 he was staying at the home of Lady Rouse of Rouse-Lench, and there, in much physical weakness, wrote a great part of his famous work, *The Saints' Everlasting Rest* (1650). On his recovery he returned to his charge at Kidderminster, where he also became a prominent political leader, his sensitive conscience leading him into conflict with almost every one of the contending parties in state and church. His conduct now, as at all times, did "credit to his conscientiousness rather than to his wisdom."

After the Restoration in 1660 Baxter, who had helped to bring about that event, settled in London. He preached there till the Act of Uniformity took effect in 1662, and was employed in seeking for such terms of comprehension as would have permitted the moderate dissenters with whom he acted to have remained in the Church of England. In this hope he was sadly disappointed. There was at that time on the part of the rulers of the church no wish for such comprehension, and their object in the negotiations that took place was to excuse the breach of faith which their rejection of all reasonable methods of concession involved. The chief good that resulted from the Savoy conference was the production of Baxter's *Reformed Liturgy*, a work of remarkable excellence, though it was cast aside without consideration. The same kind of reputation which Baxter had obtained in the country he secured in the larger and more important circle of the metropolis. The power of his preaching was universally felt, and his capacity for business placed him at the head of his party. He had been made a king's chaplain, and was offered the bishopric of Hereford, but he could not accept the offer without virtually assenting to things as they were. This he could not do, and after his refusal he was not allowed, even before the passing of the Act of Uniformity, to be a curate in Kidderminster, though he was willing to serve that office gratuitously. Bishop Morley even prohibited him from preaching in the diocese of Worcester. Baxter, however, found much consolation in his marriage on the 24th of September 1662 with Margaret Charlton, a woman like-minded with himself. She died in 1681.

From the ejection of 1662 to the indulgence of 1687, Baxter's life was constantly disturbed by persecution of one kind or another. He retired to Acton in Middlesex, for the purpose of quiet study, and was dragged thence to prison for keeping a conventicle. The *mittimus* was pronounced illegal and irregular, and Baxter procured a *habeas corpus* in the court of common pleas. He was taken up for preaching in London after the licences granted in 1672 were recalled by the king. The meeting-house which he had built for himself in Oxendon Street was closed against him after he had preached there but once. He was, in 1680, seized in his house, and conveyed away at the risk of his life; and though he was released that he might die at home, his books and goods were distrained. He was, in 1684, carried three times to the sessions house, being scarcely able to stand, and without any apparent cause was made to enter into a bond for £400 in security for his good behaviour.

But his worst encounter was with the chief justice, Sir George Jeffreys, in May 1685. He had been committed to the king's bench prison on the ridiculous charge of libelling the Church in his *Paraphrase on the New Testament*, and was tried before Jeffreys on this accusation. The trial is well known as among the most brutal perversions of justice which have occurred in England, though it must be remembered that no authoritative report of the trial exists. If the partisan account on which tradition is based is to be accepted, it would appear that Jeffreys himself acted like an infuriated madman. (See JEFFREYS, SIR GEORGE.) Baxter was sentenced to pay 500 marks, to lie in prison till the money was paid, and to be bound to his good behaviour for seven years. It was even asserted at the time that Jeffreys proposed he should be whipped at the cart's tail through London. The old man, for he was now seventy, remained in prison for eighteen months, when the government, vainly hoping to win his influence to their side, remitted the fine and released him.

During the long time of oppression and injury which followed the ejection, Baxter was sadly afflicted in body. His whole life was indeed one continued illness, but in this part of it his pain and languor had greatly increased. Yet this was the period of his greatest activity as a writer. He was a most voluminous author, his separate works, it is said, amounting to 168. They are as learned as they are elaborate, and as varied in their subjects as they are faithfully composed. Such treatises as the *Christian Directory*, the *Methodus Theologiae Christianae*, and the *Catholic Theology*, might each have occupied the principal part of the life of an ordinary man. His *Breviate of the Life of Mrs Margaret Baxter* records the virtues of his wife, and reveals on the part of Baxter a tenderness of nature which might otherwise have been unknown. His editors have contented themselves with republishing his "Practical Works," and his ethical, philosophical, historical and political writings still await a competent editor.

The remainder of Baxter's life, from 1687 onwards, was passed in peace and honour. He continued to preach and to publish almost to the end. He was surrounded by attached friends, and revered by the religious world. His saintly behaviour, his great talents, and his wide influence, added to his extended age, raised him to a position of unequalled reputation. He helped to bring about the downfall of James II. and died with the Toleration Act under William and Mary. He died in London on the 8th of December 1691, and his funeral was attended by churchmen as well as dissenters. A similar tribute of general esteem was paid to him nearly two centuries later, when a statue was erected to his memory at Kidderminster in July 1875.

Baxter was possessed by an unconquerable belief in the power of persuasive argument. He thought every one was amenable to reason—bishops and levellers included. And yet he was as far as possible from being a quarrelsome man. He was at once a man of fixed belief and large appreciation, so that his dogmatism and his liberality sometimes came into collision. His popularity as a preacher was deservedly pre-eminent; but no more diligent student ever shut himself up with his books. He was singularly fitted for intellectual debate, but his devotional tendency was equally strong with his logical aptitude. Some of his writings, from their metaphysical subtlety, will always puzzle the learned;

but he could write to the level of the common heart without loss of dignity or pointedness. His *Reasons for the Christian Religion* is still, for its evidential purpose, better than most works of its kind. His *Poor Man's Family Book* is a manual that continues to be worthy of its title. His *Saints' Everlasting Rest* will always command the grateful admiration of pious readers. It is also charged with a robust and manly eloquence and a rare and unsought felicity of language that make it a masterpiece of style. Perhaps no thinker has exerted so great an influence upon nonconformity as Baxter has done, and that not in one direction only, but in every form of development, doctrinal, ecclesiastical and practical. He is the type of a distinct class of the Christian ministry—that class which aspires after scholarly training, prefers a broad to a sectarian theology, and adheres to rational methods of religious investigation and appeal. The rational element in him was very strong. He had a settled hatred of fanaticism. Even Quakerism he could scarcely endure. Religion was with him all and in all—that by which all besides was measured, and to whose interests all else was subordinated. Isaac Barrow said that "his practical writings were never minded, and his controversial ones seldom confuted," and John Wilkins, bishop of Chester, asserted that "if he had lived in the primitive time he had been one of the fathers of the church."

BIBLIOGRAPHY.—Our most valuable source is Baxter's autobiography, called *Reliquiae Baxterianae* or *Mr Richard Baxter's Narrative of the most memorable Passages of his Life and Times* (published by Matthew Sylvester in 1696). Edmund Calamy abridged this work (1702). The abridgment forms the first volume of the account of the ejected ministers, but whoever refers to it should also acquaint himself with the reply to the accusations which had been brought against Baxter, and which will be found in the second volume of Calamy's Continuation. William Orme's *Life and Times of Richard Baxter* appeared in 2 vols. in 1830; it also forms the first volume of "Practical Works" (1830, reprinted 1868). Sir James Stephen's interesting paper on Baxter, contributed originally to the *Edinburgh Review*, is reprinted in the second volume of his *Essays*. More recent estimates of Baxter are those given by John Tulloch in his *English Puritanism and its Leaders*, and by Dean Stanley in his address at the inauguration of the statue to Baxter at Kidderminster (see *Macmillan's Magazine*, xxiii. 385).

There is a good portrait of Baxter in the Williams library, Gordon Square, London.

BAXTER, ROBERT DUDLEY (1827-1875), English economist and statistician, was born at Doncaster in 1827. He was educated privately and at Trinity College, Cambridge. He studied law and entered his father's firm of Baxter & Co., solicitors, with which he was connected till his death. Though studiously attentive to business, he was enabled, as a member of the Statistical and other learned societies, to accomplish much useful economic work. His principal economic writings were *The Budget and the Income Tax* (1860), *Railway Extension and its Results* (1866), *The National Income* (1868), *The Taxation of the United Kingdom* (1869), *National Debts of the World* (1871), *Local Government and National Debt* (1874), and his purely political writings included *The Volunteer Movement* (1860), *The Redistribution of Seats and the Counties* (1866), *History of English Parties and Conservatism* (1870), and *The Political Progress of the Working Classes* (1871).

BAXTER, WILLIAM (1650-1723), British antiquarian, critic and grammarian, nephew of Richard Baxter, the divine, was born at Llanllugan, Montgomeryshire. When he went to Harrow school, at the age of eighteen, he was unable to read, and could speak no language except Welsh. His progress must have been remarkable, since he published his Latin grammar about ten years afterwards. During the greater part of his life Baxter was a schoolmaster, and was finally headmaster of the Mercers' school, where he remained till shortly before his death on the 31st of May 1723. He was an accomplished linguist, and his learning was undoubtedly very great. His published works are: *De Analogia* (1679), an advanced Latin grammar; *Anacreontis Teii Carmina*, including two odes of Sappho (1695; reprinted in 1710, "with improvements," which he was accused of having borrowed from the edition of Joshua Barnes); *Horace* (1701 and subsequent editions, regarded as remarkable for its abuse of Bentley); *Glossarium Antiquitatum Britannicarum* (1719); and *Glossarium*

Antiquitatum Romanarum (1826). The last two works were published by the Rev. Moses Williams, the second (which goes no farther than the letter A) under the title of *Reliquiae Baxterianae*, including an autobiographical fragment. Baxter also contributed to a joint translation of Plutarch's *Moralia*, and left notes on Juvenal and Persius.

BAY, a homonymous term of which the principal branches are as follows. (1) The name of the sweet laurel (*Laurus nobilis*) or bay tree (see LAUREL); this word is derived through the O. Fr. *baie*, from Lat. *baca*, berry, the bay bearing a heavy crop of dark purple berries. The leaves of the bay were woven in garlands to crown poets, and hence the word is often used figuratively in the sense of fame and reward. (2) A wide opening or indentation in a coast line. This may be of the same origin as "bay," in the architectural sense, or from a Latin word which is seen in the place name Baiae. (3) The name of a colour, of a reddish brown, principally used of the colour in horses; there are various shades, light bay, bright bay, &c. This word is derived from the Latin *baduus*, which is given by Varro (in *Nonnius*, pp. 80-82) as one of the colours of horses. The word is also seen in baize (*q.v.*). (4) The deep bark of dogs. This word is also seen in the expression "at bay," properly of a hunted animal who at the last turns on the "baying" hounds and defends itself. The origin of the word is the O. Fr. *bayer*, *bayerer*, Lat. *badare*, properly to gape, open wide the mouth. (5) An architectural term (Fr. *trabée*, Ital. *compartimento*, Ger. *Abteilung*) for any division or compartment of an arcade, roof, &c. Each space from pillar to pillar in a cathedral, church or other building is called a "bay" or "severy." This word is also to be referred to *bayer*, to gape.

A "bay-window" or "bow-window" is a window projecting outwards and forming a recess in the apartment. Bay-windows may be rectangular, polygonal or semicircular in plan, in the last case being better known as bow-windows. The bay-window would seem to have been introduced in the 15th century, but the earliest examples of importance are those which were built during the reign of Edward IV. (1461-1483), when it was largely employed in the colleges of Oxford and Cambridge and in the feudal castles of the period. Examples are found in the palace at Eltham, Cowdray Castle in Sussex, Thornbury Castle in Gloucestershire, and in the George Inn at Glastonbury; one of the finest of a later date is that of the Banqueting Hall at Hampton Court, some 50 ft. high. In the great entrance halls of ancient mansions the floor of the last bay of the hall was generally raised two or three steps, and this portion was reserved for the lord of the manor and his guests, and was known as the dais. The usual position of the bay-window is at one end of this dais, and occasionally but rarely at both ends. The sills of the windows are at a lower level than those in the hall, and, raised on one or two steps, are seats in the recess. The recess of the bay-window was generally covered with a ribbed vault of elaborate design, and the window itself subdivided by mullions and transoms. In some of the larger windows such as those at Cowdray and Hampton Court there are no fewer than five transoms, and this sub-division gave great scale to the design. The same feature when employed in an upper storey and supported by corbels or brackets is known as an oriel window. (See also DAIS and HALL.)

BAYAMO, an old inland city on the N. slope of the Sierra Maestra in Santiago province, Cuba. Pop. (1907) 4102. It lies on a plain by the Bayamo river, in a fertile country, but isolated from sea and from railway. Its older parts are extraordinarily irregular. The streets are of all widths, and of all degrees of crookedness, and run in all directions. Bayamo was the third of the seven cities founded by Diego Velazquez, and was established in 1513. During much of the 16th century it was one of the most important agricultural and commercial settlements of the island. Its inland situation gave it relative security against the pirates who then infested West Indian seas, and the misfortunes of Santiago were the fortunes of Bayamo. Down the river Cauto, then open to the sea for vessels of 200 tons, and through Manzanillo, Bayamo drove a thriving contraband trade that made it at the opening of the 17th century the leading town of Cuba. A tremendous flood, in 1616, choking the Cauto with trees and

wrecked vessels, cut it off from direct access to the sea; but through Manzanillo it continued a great clandestine traffic with Curaçao, Jamaica, and other foreign islands all through the 17th and 18th centuries. Bayamo was then surrounded by fine plantations. It was a rich and turbulent city. In the war of 1868-78 it was an insurgent stronghold; near it was fought one of the most desperate conflicts of the war, and it was nearly destroyed by the opposing parties. Bayamo was the birthplace and the home of Carlos Manuel de Céspedes (1819-1874), first president of the "first" Cuban republic, and was also the birthplace and home of Tomás Estrada Palma (1835-1908), first president of the present Cuban republic.

BAYARD, PIERRE TERRAIL, SEIGNEUR DE (1473-1524), French soldier, the descendant of a noble family, nearly every head of which for two centuries past had fallen in battle, was born at the château Bayard, Dauphiné (near Pontcharra, Isère), about 1473. He served as a page to Charles I., duke of Savoy, until Charles VIII. of France, attracted by his graceful bearing, placed him among the royal followers under the seigneur (count) de Ligry (1487). As a youth he was distinguished for comeliness, affability of manner, and skill in the tilt-yard. In 1494 he accompanied Charles VIII. into Italy, and was knighted after the battle of Fornova (1495), where he had captured a standard. Shortly afterwards, entering Milan alone in ardent pursuit of the enemy, he was taken prisoner, but was set free without a ransom by Lodovico Sforza. In 1502 he was wounded at the assault of Canossa. Bayard was the hero of a celebrated combat of thirteen French knights against an equal number of Germans, and his restless energy and valour were conspicuous throughout the Italian wars of this period. On one occasion it is said that, single-handed, he made good the defence of the bridge of the Garigliano against about 200 Spaniards, an exploit that brought him such renown that Pope Julius II. sought to entice him into the papal service, but unsuccessfully. In 1508 he distinguished himself again at the siege of Genoa by Louis XII., and early in 1509 the king made him captain of a company of horse and foot. At the siege of Padua he won further distinction, not only by his valour, but also by his consummate skill. He continued to serve in the Italian wars up to the siege of Brescia in 1512. Here his intrepidity in first mounting the rampart cost him a severe wound, which obliged his soldiers to carry him into a neighbouring house, the residence of a nobleman, whose wife and daughters he protected from threatened insult. Before his wound was healed, he hurried to join Gaston de Foix, under whom he served in the terrible battle of Ravenna (1512). In 1513, when Henry VIII. of England routed the French at the battle of the Spurs (Guinegate, where Bayard's father had received a lifelong injury in a battle of 1479), Bayard in trying to rally his countrymen found his escape cut off. Unwilling to surrender, he rode suddenly up to an English officer who was resting unarmed, and summoned him to yield; the knight complying, Bayard in turn gave himself up to his prisoner. He was taken into the English camp, but his gallantry impressed Henry as it had impressed Lodovico, and the king released him without ransom, merely exacting his parole not to serve for six weeks. On the accession of Francis I. in 1515 Bayard was made lieutenant-general of Dauphiné; and after the victory of Marignan, to which his valour largely contributed, he had the honour of conferring knighthood on his youthful sovereign. When war again broke out between Francis I. and Charles V., Bayard, with 1000 men, held Mézières, which had been declared untenable, against an army of 35,000, and after six weeks compelled the imperial generals to raise the siege. This stubborn resistance saved central France from invasion, as the king had not then sufficient forces to withstand the imperialists. All France rang with the achievement, and Francis gained time to collect the royal army which drove out the invaders (1521). The parlement thanked Bayard as the saviour of his country; the king made him a knight of the order of St Michael, and commander in his own name of 100 *gens d'armes*, an honour till then reserved for princes of the blood. After allaying a revolt at Genoa, and striving with the greatest assiduity to check a pestilence in Dauphiné, Bayard was sent, in 1523, into Italy with

Admiral Bonivivet, who, being defeated at Robecco and wounded in a combat during his retreat, implored Bayard to assume the command and save the army. He repulsed the foremost pursuers, but in guarding the rear at the passage of the Sesia was mortally wounded by an arquebus ball (April 30th, 1524). He died in the midst of the enemy, attended by Pescara, the Spanish commander, and by his old comrade the constable de Bourbon. His body was restored to his friends and interred at Grenoble. Chivalry, free of fantastic extravagance, is perfectly mirrored in the character of Bayard. As a soldier he was one of the most skillful commanders of the age. He was particularly noted for the exactitude and completeness of his information of the enemy's movements; this he obtained both by careful reconnaissance and by a well-arranged system of espionage. In the midst of mercenary armies Bayard remained absolutely disinterested, and to his contemporaries and his successors he was, with his romantic heroism, piety and magnanimity, the fearless and faultless knight, *le chevalier sans peur et sans reproche*. His gaiety and kindness won him, even more frequently, another name bestowed by his contemporaries, *le bon chevalier*.

Contemporary lives of Bayard are the following:—"*Le loyal serviteur*" (? Jacques de Maille); *La très joyeuse, plaisante, et récréative histoire . . . des faits, gestes, triumphe, et prouesses du bon chevalier sans peur et sans reproche, le gentil seigneur de Bayart* (original edition printed at Paris, 1527; the modern editions are very numerous, those of M. J. Roman and of L. Larchey appeared in 1878 and 1882); Symphorien Champier, *Les Gestes, ensemble la vie du preux chevalier Bayard* (Lyons, 1525); Aymar du Rivail, *Histoire des Allobroges* (edition of de Terrebasse, 1844); see Bayard in *Répertoire des sources historiques*, by Ulysse Chevalier, and in particular A. de Terrebasse, *Hist. de Pierre Terrail, seigneur de Bayart* (1st ed., Paris, 1828; 5th ed., Vienna, 1870).

BAYARD, THOMAS FRANCIS (1828-1898), American diplomatist, was born in Wilmington, Delaware, on the 29th of October 1828. His great-grandfather, Richard Bassett (1745-1815), governor of Delaware; his grandfather, James Asheton Bayard (1767-1815), a prominent Federalist, and one of the United States commissioners who negotiated the treaty of Ghent with Great Britain after the War of 1812; his uncle, Richard Henry Bayard (1796-1868); and his father, James Asheton Bayard (1790-1880), a well-known constitutional lawyer, all represented Delaware in the United States Senate. Intending to go into business, he did not receive a college education; but in 1848 he began the study of law in the office of his father, and was admitted to the bar in 1851. Except from 1855 to 1857, when he was a partner of William Shippen in Philadelphia, he practised chiefly in Wilmington. He was a United States senator from Delaware from 1860 to 1885, and in 1881 was (October 10th to 13th) president *pro tempore* of the Senate. His abilities made him a leader of the Democrats in the Senate, and his views on financial and legal questions gave him a high reputation for statesmanship. He was a member of the electoral commission of 1877. In the Democratic national conventions of 1872, 1876, 1880 and 1884 he received votes for nomination as the party candidate for the presidency. He was secretary of state, 1885-1889, during the first administration of President Cleveland, and pursued a conservative policy in foreign affairs, the most important matter with which he was called upon to deal being the Bering Sea controversy. As ambassador to Great Britain, 1893-1897, his tall dignified person, unflinching courtesy, and polished, if somewhat deliberate, eloquence made him a man of mark in all the best circles. He was considered indeed by many Americans to have become too partial to English ways; and, for the expression of some criticisms regarded as unfavourable to his own countrymen, the House of Representatives went so far as to pass, on the 7th of November 1895, a vote of censure on him. The value of Mr Bayard's diplomacy was, however, fully recognized in the United Kingdom, where he worthily upheld the traditions of a famous line of American ministers. He was the first representative of the United States in Great Britain to hold the diplomatic rank of an ambassador. He died in Dedham, Massachusetts, on the 28th of September 1898.

See Edward Spencer, *Public Life and Services of T. F. Bayard* (New York, 1880).

BAYAZID, or **BAJAZET**, a border fortress of Asiatic Turkey, chief town of a sanjak of the Erzerum vilayet, situated close to the frontiers of Russia and Persia, and looking across a marshy plain to the great cone of Ararat, at a general altitude of 6000 ft. It occupies a site of great antiquity, as the cuneiform inscriptions on the neighbouring rocks testify; it stands on the site of the old Armenian town of Pakovan. It is picturesquely situated in an amphitheatre of sharp, rocky hills. The great trade route from Trebizond by Erzerum into N.W. Persia crosses the frontier at Kizil Dize a few miles to the south and does not enter the town. A knoll above the town is occupied by the half-ruined fort or palace of former governors, built for Mahmud Pasha by a Persian architect and considered one of the most beautiful buildings in Turkey. It contains two churches and a monastery, the Kasa Kilissa, famous for its antiquity and architectural grandeur. The cuneiform inscriptions are on the rock pinnacles above the town, with some rock chambers, indicating a town or fortress of the Vannic period. The population has lately decreased and now numbers about 4000. A Russian consul resides here and the town is a military station. It was captured during the Russian campaigns of 1828 and 1854, also in 1878, but was then recaptured by the Turks, who subjected the Russian garrison to a long siege; the place was ultimately relieved, but a massacre of Christians then took place in the streets. Bayazid was restored to Turkey by the treaty of Berlin.

BAYBAY, a town of the province of Leyte, island of Leyte, Philippine Islands, on the W. coast. Pop. (1903) 22,990. The town proper is situated at the mouth of the Pagbañanan river, 45 m. S.S.W. of Tacloban, the provincial capital. A superior grade of hemp is exported. Other products are rice, corn, copra, cacao, sugar, cattle and horses. The Cebú dialect of the Visayan language is spoken.

BAY CITY, a city and the county seat of Bay county, Michigan, U.S.A., on the Saginaw river, about 2 m. from its entrance into Saginaw Bay and about 108 m. N.N.W. of Detroit. Pop. (1890) 27,839; (1900) 27,628, of whom 8485 were foreign-born, including 2413 English-Canadians, 1743 Germans, 1822 Poles—the city has a Polish weekly newspaper—and 1075 French-Canadians; (1910, census) 45,166. Bay City is served by the Michigan Central, the Perc Marquette, the Grand Trunk and the Detroit & Mackinac railways, and by lake steamers. The city extends for several miles along both sides of the river, and is in a good farming district, with which it is connected by stone roads. Among the public buildings are the Federal building, the city hall and the public library. The city has lumber and fishing interests (perch, whitefish, sturgeon, pickerel, bass, &c. being caught in Saginaw Bay), large machine shops and foundries (value of products in 1905, \$1,743,155, or 31% of the total of the city's factory products), and various manufactures, including ships (wooden and steel), wooden ware, wood-pipe, veneer, railroad machinery, cement, alkali and chicory. A salt basin underlies the city, and, next to the lumber industry, the salt industry was the first to be developed, but its importance has dwindled, the product value in 1905 being \$20,098 out of \$5,620,866 for all factory products. Near the city are valuable coal mines, and there is one within the city limits. At Essexville (pop. in 1910, 1477), N.E., at Banks, N.W., and at Salzbury, S.W. of Bay City, are beet-sugar factories—sugar beets are extensively grown in the vicinity. Alcohol is made from the refuse molasses obtained from these beet-sugar factories. The municipality owns and operates the water-works and electric-lighting plant. The settlements of Lower Saginaw and Portsmouth were made in 1837, and were later united to form Bay City, which was incorporated as a village in 1859, and chartered as a city in 1865. In 1905 West Bay City (pop. 1900, 13,119) and Bay City were consolidated.

BAYEUX, a town of north-western France, capital of an arrondissement in the department of Calvados, 18 m. N.W. of Caen on the Western railway. Pop. (1906) 6930. Bayeux is situated on the Aure, 5 m. from the English Channel. Its majestic cathedral was built in the 13th century on the site of a Romanesque church, to which the lateral arcades of the nave

and the two western towers with their high stone spires belonged. A third and still loftier tower, the upper part of which, in the florid Gothic style, is modern, surmounts the crossing. The chancel, surrounded with radiating chapels, is a fine example of early Gothic. Underneath it there is a crypt of the 11th century restored in the 15th century. The oak stalls in the choir are fine examples of late 16th-century carving. The former bishop's palace, parts of which are of great age though the main building is of the 18th century, serves as law-court and hôtel de ville. Bayeux possesses many quaint, timbered houses and stone mansions in its quiet streets. The museum contains the celebrated Bayeux tapestry (see below). The town is the seat of a bishop and of a sub-prefect; it has tribunals of first instance and of commerce, an ecclesiastical seminary, a communal college and a chamber of arts and manufactures. Dyeing, leather-dressing, lace-making and the manufacture of porcelain for household and laboratory purposes are carried on.

Till the 4th century Bayeux bore the name of *Augustodurum*, but afterwards, when it became the capital of the two tribes of the Baiocasses and Viduasses, took the name of Civitas Baiocassium. Its bishopric dates from the latter half of the 4th century. Before the Norman invasion it was governed by counts. Taken in 890 by the Scandinavian chief, Rollo, it was soon after peopled by the Normans and became a residence of the dukes of Normandy, one of whom, Richard I., built about 960 a castle which survived till the 18th century. During the quarrels between the sons of William the Conqueror it was pillaged and sacked by Henry I. in 1106, and in later times it underwent siege and capture on several occasions during the Hundred Years' War and the religious wars of the 16th century. Till 1790 it was the capital of the Bessin, a district of lower Normandy.

BAYEUX TAPESTRY, THE. This venerable relic consists of a band of linen, 231 ft. long and 20 in. wide, now light brown with age, on which have been worked with a needle, in worsteds of eight colours, scenes representing the conquest of England by the Normans. Of these scenes there are seventy-two, beginning with Harold's visit to Bosham on his way to Normandy, and ending with the flight of the English from the battle of Hastings, though the actual end of the strip has perished. Along the top and the bottom run decorative borders with figures of animals, scenes from fables of Aesop and of Phaedrus, from husbandry and the chase, and occasionally from the story of the Conquest itself (see *EMBROIDERY*, Plate I. fig. 7). Formerly known as the *Toile de St Jean*, it was used on certain feast days to decorate the nave of Bayeux cathedral. Narrowly escaping the perils of the Revolution, it was exhibited in Paris, by Napoleon's desire, in 1803-1804, and has since been in civil custody at Bayeux, where it is now exhibited under glass. In the Franco-German War (1871) it was hastily taken down and concealed.

"The noblest monument in the world relating to our old English history," as William Stukeley described it in 1746, it has been repeatedly described, discussed and reproduced, both in France and in England since 1730. The best coloured reproduction is that by C. A. Stothard in 1818, published in the sixth volume of *Vetusta Monumenta*; but in 1871-1873 the "tapestry" was photographed for the English education authorities by E. Dosseter.

Local tradition assigned the work to the Conqueror's wife, F. Pluquet, in his *Essai historique sur la ville de Bayeux* (Caen, 1820), was the first to reject this belief, and to connect it with the Conqueror's half-brother Odo, bishop of Bayeux, and this view, which is now accepted, is confirmed by the fact that three of the bishop's followers mentioned in Domesday Book are among the very few named figures on the tapestry. That Odo had it executed for his cathedral seems tolerably certain, but whether it was worked by English fingers or not has been disputed, though some of the words upon it have been held to favour that view. Freeman emphatically pronounced it to be "a contemporary work," and historically "a primary authority. . . in fact the highest authority on the Norman side." As some of its evidence is unique, the question of its authority is important, and Freeman's conclusions have been practically

confirmed by recent discussion. In 1902 M. Marignan questioned, on archaeological grounds, the date assigned to the tapestry, as the Abbé de la Rue had questioned it ninety years before; but his arguments were refuted by Gaston Paris and M. Lanore, and the authority of the tapestry was vindicated. The famous relic appears to be the solitary survivor of a class, for Abbot Baudri described in Latin verse a similar work executed for Adela, daughter of the Conqueror, and in earlier days the widow of Brihtnoth had wrought a similar record of her husband's exploits and death at the hard-fought battle of Maldon (991).

See E. A. Freeman, *Norman Conquest*, vol. iii. (ed. 1875), with summary of the discussion to date; *Archæologia*, vols. xvii.-xix.; Dawson Turner, *Tour in Normandy* (1820); C. A. Stothard's illustrations in *Vetusta Monumenta*, vol. vi.; *Gentleman's Magazine*, 1837; Bolton Conway, *Researches and Conjectures on the Bayeux Tapestry* (1836-1838); A. de Caumont, "Un mot sur . . . la tapisserie de Bayeux," in *Bulletin monumental de l'institut des provinces*, vol. viii. (1841); J. Lafetay, *Notice historique et descriptive sur la tapisserie* . . . (1874); J. Comte, *Tapisserie de Bayeux*; F. R. Fowke, *The Bayeux Tapestry* (ed. 1898); Marignan, *Tapisserie de Bayeux* (1902); G. Paris, "Tapisserie de Bayeux," in *Romania*, vol. xxxi.; Lanore, "La Tapisserie de Bayeux," in *Bibliothèque de l'école des chartes*, vol. lxiv. (1903); and J. H. Round, "The Bayeux Tapestry," in *Monthly Review*, xvii. (1904). (J. H. R.)

BAYEZID I. (1347-1403), Ottoman sultan, surnamed *YILDERIM* or "LICHNING," from the great rapidity of his movements, succeeded his father Murad I, on the latter's assassination on the field of Kosovo, 1389, and signaled his accession by ordering at once the execution of his brother Yakub, who had distinguished himself in the battle. His arms were successful both in Europe and Asia, and he was the first Ottoman sovereign to be styled "sultan," which title he induced the titular Abbasid caliph to confer on him. After routing the chivalry of Christendom at the battle of Nikopoli in 1396, he pursued his victorious career in Greece, and Constantinople would doubtless have fallen before his attack, had not the emperor Manuel Palaeologus bought him off by timely concessions which reduced him practically to the position of Bayezid's vassal. But his conquests met with a sudden and overpowering check at the hands of Timur (Tamerlane). Utterly defeated at Angora by the Mongol invader, Bayezid became his prisoner, and died in captivity some months later, in March 1403.

Bayezid first married Devlet Shah Khatun, daughter of the prince of Kermian, who brought him in dowry Kutaiah and its dependencies. Two years before his accession he also married a daughter of the emperor John Palaeologus.

BAYEZID II. (1447-1512), sultan of Turkey, was the son of Mahommed II., whom he succeeded in 1481, but only after gaining over the janissaries by a large donative, which henceforth became for centuries the invariable prerogative of that undisciplined body on the accession of a new sultan. Before he could establish himself on the throne a long struggle ensued with his brother Prince Jem. Being routed, Jem fled for refuge to the knights of St John at Rhodes, who, in spite of a safe-conduct granted to him, accepted a pension from Bayezid as the price for keeping him a close prisoner. (See *ABUSSON, PIERRE D'*.)

So long as Jem lived he was a perpetual menace to the sultan's peace, and there was considerable rivalry among the sovereigns of Europe for the possession of so valuable an instrument for bringing pressure to bear upon the Porte for the purpose of extracting money or concessions. By common consent the prince was ultimately entrusted to Pope Innocent VIII., who used him not only to extract an annual tribute out of the sultan, but to prevent the execution of Bayezid's ambitious designs in the Mediterranean. His successor, Alexander VI., used him for a more questionable purpose, namely, not only to extract the arrears of the pension due for Jem's safe-keeping, but, by enlarging on Charles V.'s intention of setting him up as sultan, to persuade Bayezid to aid him against the emperor. There appears, however, to be no truth in the report that Bayezid succeeded in bribing the pope to have Jem poisoned. The prince, who had lived on excellent terms with Alexander, died at Naples in February 1495, possibly as the result of excesses in which he had been deliberately encouraged by the pope.

Whether as a result of his fear of the rivalry of Jem, or of his personal character, Bayezid showed little of the aggressive spirit of his warlike predecessors; and Machiavelli said that another such sultan would cause Turkey to cease being a menace to Europe. He abandoned the attack on Rhodes at the first check, made concessions, for the sake of peace, to Venice and reduced the tribute due from Ragusa. His wars were of the nature of raids, on the Dalmatian coast and into Croatia, Hungary, Moldavia and Poland. The threat of the growing power in the Aegean of Venice, which had acquired Cyprus in 1489, at last roused him to a more serious effort; and in 1499 the war broke out with the republic, which ended in 1502 by the annexation to Turkey of Lepanto and Modon, Coron and Navarino in the Morea. Bayezid himself conducted the siege of Modon in 1500.

The comparative inactivity of Bayezid in the direction of Europe was partly due to preoccupation elsewhere. In the south he was threatened by the dangerous rivalry of Kait Bey, the Mameluke sultan of Egypt, who had extended his power northwards as far as Tarsus and Adana. In 1488 he gained a great victory over the Ottomans, and in 1491 a peace was made which was not again broken till after Bayezid's death. On the side of Persia too, where the decisive battle of Shurur (1502) had raised to power Ismail, the first of the modern line of shahs, danger threatened the sultan, and the latter years of his reign were troubled by the spread, under the influence of the new Persian power, of the Shi'ite doctrine in Kurdistan and Asia Minor. The forces destined to maintain his authority in Asia had been entrusted by Bayezid to his three sons, Ahmed, Corcud and Selim; and the sultan's declining years were embittered by their revolts and rivalry. Soon after the great earthquake of 1509, which laid Constantinople in ruins, Selim, the ungenerous pasha of Trebizond, whose vigorous rule in Asia had given Europe an earnest of his future career as sultan, appeared before Adrianople, where Bayezid had sought refuge. The sultan had designated Ahmed as his successor, but Selim, though temporarily defeated, succeeded in winning over the janissaries. On the 25th of April 1512 Bayezid was forced to abdicate in his favour, and died a few days later.

See J. B. Bury in the *Cambridge Modern History*, vol. i. chap. iii. and bibliography p. 700.

BAY ISLANDS (ISLAS DE LA BAHÍA), a small archipelago in the Caribbean Sea, off the coast of Honduras, of which country it forms an administrative district. Pop. (1905) about 3000, including 500 Indians. The archipelago consists of Roatan or Ruatan, Guanaja or Bonacca, Utila, Barbareta, Helena, Morat, the Puercos or Hog Islands, and many cays or islets. The Bay Islands have a good soil, a fine climate and an advantageous position. Roatan, the largest, is about 30 m. long by 9 m. broad, with mountains rising to the height of 900 ft., covered with valuable woods and abounding with deer and wild hogs. Its chief towns are Coxen Hole and Puerto Real. Its trade is chiefly with New Orleans in plantains, cocoa-nuts, pineapples and other fruit. Guanaja is 9 m. long by 5 m. broad; it lies 15 m. N.E. of Roatan. Wild hogs abound in its thickly-wooded limestone hills. The other islands are comparatively small, and may, in some cases, be regarded as detached parts of Roatan, with which they are connected by reefs. Guanaja was discovered in 1502 by Columbus, but the islands were not colonized until the 17th century, when they were occupied by British logwood cutters from Belize, and pearlers from the Mosquito Coast. Forts were built on Roatan in 1742, but abandoned in 1749. In 1852 the islands were annexed by Great Britain. In 1859 they were ceded to Honduras.

BAYLE, PIERRE (1647-1706), French philosopher and man of letters, was born on the 18th of November 1647, at le Carla-le-Comte, near Pamiers (Ariège). Educated by his father, a Calvinist minister, and at an academy at Puy-laurens, he afterwards entered a Jesuit college at Toulouse, and became a Roman Catholic a month later (1666). After seventeen months he resumed his former religion, and, to avoid persecution, fled to Geneva, where he became acquainted with Cartesianism. For some years he acted under the name of Bèle as tutor in various



1. SIEGE OF DINANT. Note the wooden castle on a mound, and the knight handing over the keys on his lance tip.



2. THE FUNERAL OF EDWARD THE CONFESSOR AT WESTMINSTER ABBEY.



3. CORONATION OF HAROLD.



4. APPEARANCE OF HALLEY'S COMET.



5. THE NORMANS CARRY THEIR ARMS TO THE SHIPS.

(By permission of G. Bell & Sons.)



6. THE NORMANS CROSS TO PEVENSEY.



7. BUILDING OF HASTINGS CASTLE.



8. HAROLD'S ADVANCE ANNOUNCED TO WILLIAM.
THE BURNING OF HASTINGS.



9. THE NORMAN CAVALRY ATTACKS THE ENGLISH SHIELD WALL.



10. WILLIAM RAISES HIS HELMET TO RALLY HIS MEN.

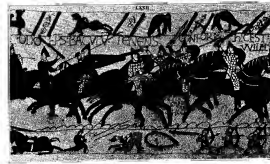

11. ODO, BISHOP OF BAYEUX, WIELDING HIS MACE.

Parisian families, but in 1675 he was appointed to the chair of philosophy at the Protestant university of Sedan. In 1681 the university at Sedan was suppressed, but almost immediately afterwards Bayle was appointed professor of philosophy and history at Rotterdam. Here in 1682 he published his famous *Pensées diverses sur la comète de 1680* and his critique of Maimbourg's work on the history of Calvinism. The great reputation achieved by this critique stirred the envy of Bayle's colleague, P. Jurieu, who had written a book on the same subject. In 1684 Bayle began the publication of his *Nouvelles de la république des lettres*, a kind of journal of literary criticism. In 1690 appeared a work entitled *Avis important aux réfugiés*, which Jurieu attributed to Bayle, whom he attacked with animosity. After a long quarrel Bayle was deprived of his chair in 1693. He was not depressed by this misfortune, especially as he was at the time closely engaged in the preparation of the *Historical and Critical Dictionary* (*Dictionnaire historique et critique*). The remaining years of Bayle's life were devoted to miscellaneous writings, arising in many instances out of criticisms made upon his *Dictionary*. He died in exile at Rotterdam on the 28th of December 1706. In 1906 a statue in his honour was erected at Pamiers, "la réparation d'un long oubli." Bayle's erudition, despite the low estimate placed upon it by Leclerc, seems to have been very considerable. As a constructive thinker, he did little. As a critic he was second to none in his own time, and even yet one can admire the delicacy and the skill with which he handles his subject. The *Nouvelles de la république des lettres* (see Louis P. Betz, *P. Bayle und die Nouvelles de la république des lettres*, Zürich, 1896) was the first thorough-going attempt to popularize literature, and it was eminently successful. The *Dictionary*, however, is Bayle's masterpiece.

EDITIONS.—*Historical and Critical Dictionary* (1695-1697; 1702, enlarged; best that of P. des Maizeaux, 4 vols., 1740); *Les Œuvres de Bayle* (3 vols., The Hague); see des Maizeaux, *Vie de Bayle*; A. Feuerbach, *Pierre Bayle* (1838); Damiron, *La Philosophie en France au XVIII^e siècle* (1858-1864); Sainte-Beuve, "Du génie critique et de Bayle" (*Revue des deux mondes*, 1st Dec. 1835); A. Deschamps, *La Gènesis du scepticisme français chez Bayle* (Liège, 1878); J. Denis, *Bayle et Jurieu* (Paris, 1886); F. Brunetière, *La Critique littéraire au XVIII^e siècle* (vol. i., 1890), and *La Critique de Bayle* (1893); Émile Gigas, *Choix de la correspondance inédite de Pierre Bayle* (Paris, 1890, reviewed in *Revue critique*, 22nd Dec. 1890); de Budé, *Lettres inédites adressées à J. A. Perrin* (Paris, 1887); J. F. Stephen, *Hours Sabbaticae* (London, 1892, 3rd ser. pp. 174-192); A. Cazes, *P. Bayle, sa vie, ses idées*, &c. (1905).

BAYLO (Lat. *bajulus* or *ballivus*; cf. Ital. *balio*, Fr. *bailli*, Eng. *baillif*), in diplomacy, the title borne by the Venetian representative at Constantinople. His functions were originally in the nature of those of a consul-general, but from the 16th century onwards he had also the rank and functions of a diplomatic agent of the first class. "Under the name of bayle," says A. de Wicquefort, "he performs also the functions of consul and judge; not only between members of his own nation, but also between all the other merchants who trade in the Levant under the flag of St Mark." (See DIPLOMACY.)

BAYLY, THOMAS HAYNES (1797-1839), English song-writer and dramatist, was born at Bath on the 13th of October 1797. He was educated at Winchester and at St Mary Hall, Oxford, with a view to entering the church. While on a visit to Dublin, however, he discovered his ability to write ballads, and on his return to England in 1824 he quickly gained a wide reputation with "I'd be a butterfly," following this up with "We met—'twas in a crowd," "She wore a wreath of roses," "Oh, no, we never mention her," and other light and graceful songs for which his name is still remembered. He set some of his songs to music himself; a well-known example is "Gaily the troubadour." Bayly also wrote two novels, *The Aymers* and *A Legend of Killarney*, and numerous plays. His most successful dramatic piece was *Perfection*, which was produced by Madame Vestris and received high praise from Lord Chesterfield. Bayly had married in 1826 an Irish heiress, but her estates were mismanaged and the anxiety caused by financial difficulties undermined his health. He died on the 22nd of April 1839.

His *Collected Works* (1844) contain a memoir by his wife.

BAYNES, THOMAS SPENCER (1823-1887), English editor and man of letters, the son of a Baptist minister, was born at Wellington, Somerset, on the 24th of March 1823. He studied at Edinburgh University, where he was a pupil of Sir William Hamilton, whose assistant he became and of whose views on logic he became the authorized exponent. This teaching was embodied in his *Essay on the New Analytic of Logical Forms*, published in 1850, the same year in which he took his London University degree. This was followed in the next year by a translation of Arnauld's *Port Royal Logic*. In 1850 he had become editor of the *Edinburgh Guardian*, but after four years' work his health gave way. He spent two years in Somerset and then went to London, becoming, in 1858, assistant editor of the *Daily News*. In 1864 he was appointed professor of logic metaphysics and English literature at the university of St Andrews, and in 1873 the editorship of the ninth edition of the *Encyclopaedia Britannica* was entrusted to him. He conducted it singly until 1881, when the decline of his health rendered it necessary to provide him with a coadjutor in the person of Prof. W. Robertson Smith. Baynes, however, continued to be engaged upon the work until his death on the 31st May 1887, shortly before its completion. His article on Shakespeare (*Encyclopaedia Britannica*, 9th ed.) was republished in 1894, along with other essays on Shakespearean topics and a memoir by Prof. Lewis Campbell.

BAYONET, a short thrusting weapon, fixed to the muzzle or fore-end of a rifle or musket and carried by troops armed with the latter weapons. The origin of the word is disputed, but there is some authority for the supposition that the name is derived from the town of Bayonne, where the short dagger called *bayonnette* was first made towards the end of the 15th century. The elder Puysegur, a native of Bayonne, says (in his *Memoirs*, published posthumously in Paris, 1747) that when he was commanding the troops at Ypres in 1647 his musketeers used bayonets consisting of a steel dagger fixed in a wooden haft, which fitted into the muzzle of the musket—in fact plug-bayonets. Courts-martial were held on some English soldiers at Tangier in 1663-1664 for using their daggers on their comrades. As bayonets were at first called daggers, and as there were few or no pikemen in Tangier until 1675, the probable conclusion is that the troops in Tangier used plug-bayonets. In 1671 plug-bayonets were issued to the French regiment of fusiliers then raised. They were issued to part of an English dragoon regiment raised in 1672 and disbanded in 1674, and to the Royal Fusiliers when raised in 1685. The danger incurred by the use of this bayonet (which put a stop to all fire) was felt so early that the younger Puysegur saw a ring-bayonet in 1678 which could be fixed without stopping the fire. The English defeat at Killiecrankie in 1689 was due (among other things) to the use of the plug-bayonet; and shortly afterwards the defeated leader, General Mackay, introduced a ring-bayonet of his own invention. A trial with badly-fitting socket or zigzag bayonets was made after the battle of Fleurus, 1600, in the presence of Louis XIV., who refused to adopt them. Shortly after the peace of Ryswick (1697) the English and Germans abolished the pike and introduced these bayonets, and plates of them are given in Surirey de St Remy's *Mémoires d'Artillerie*, published in Paris in that year; but owing to a military cabal they were not issued to the French infantry until 1703. Henceforward the bayonet became, with the musket or other firearm, the typical weapon of infantry. This bayonet remained in the British service until 1805, when Sir John Moore introduced a bayonet fastened to the musket by a spring clip. The triangular bayonet (so called from the cross-section of its blade) was used in the British army until the introduction of the magazine rifle, when it was replaced by the sword-bayonet or dagger-bayonet. Sword-bayonets—weapons which could be used as sword or dagger apart from the rifle—had long been in use by special troops such as engineers and rifles, and many ingenious attempts have been made to produce a bayonet fitted for several uses. A long curved sword-bayonet with a saw-edged back was formerly used by the Royal Engineers, but all troops are now supplied with the plain sword-

bayonet. The bayonet is usually hung in a scabbard on the belt of the soldier and only fixed during the final stages of a battle; the reason for this is that the "jump" of the rifle due to the shock of explosion is materially altered by the extra weight at the muzzle, which thus deranges the sighting. In the short Lee-Enfield rifle of 1903, the bayonet, not being directly attached to the barrel, does not influence accuracy, but with the long rifles, when the bayonet is fixed, the sight must be raised by two or three graduations to ensure correct elevation. In the Russian army troops almost invariably carry the bayonet (triangular) fixed; the model (1891) of Italian carbine has an inseparable bayonet; the United States rifle (the new short model of 1903) has a knife bayonet, the model of 1905, which is 20.5875 in. long, with the lower edge of the blade sharpened along its entire length and the upper edge sharpened 5 in. from the point; this bayonet is carried in a wooden and leather scabbard attached to the cartridge belt. The British bayonet (pattern 1903) has a blade 1 ft. in length. The length of the rifle and bayonet together, considered as an *arme blanche*, varies considerably, that of the French Lebel pattern of 1886 being 6 ft., as against the 4 ft. 8½ in. of the British short Lee-Enfield of 1903. The German rifles (1898) have a length with bayonet of 5 ft. 0½ in.; the Russian (1894) 5 ft. 9 in.; and the Japanese 5 ft. 5½ in. In 1908 a new British bayonet was approved, 5 in. longer than its predecessor of 1903, the shape of the point being modified to obtain the thrusting effect of a spear or lance head.

BAYONNE, a town of south-western France, capital of an arrondissement in the department of Basses-Pyrénées, 66 m. N.W.N. of Pau on the Southern railway. Pop. (1906) 21,779. Bayonne, a first-class fortified place, is situated at the confluence of the Adour and its left-hand tributary, the Nive, about 3 m. from the sea. The two rivers divide the town into three nearly equal parts, communicating with each other by bridges. Grand Bayonne lies on the left bank of the Nive; the two squares which lie close together at the mouth of that river constitute the most animated quarter of the town. Petit Bayonne lies between the right bank of the Nive and the Adour; Saint Esprit, dominated by a citadel which is one of the finest works of Vauban, occupies the right bank of the Adour. The last is inhabited partly by a colony of Jews dating at least from the early 16th century. To the north-west of the town are the Allées Marines, fine promenades which border the Adour for a mile and a quarter, and the Allées Paulmy, skirting the fortifications. The cathedral of Ste Marie in Grand Bayonne is an imposing Gothic structure of the 13th, 14th and 15th centuries. It consists of a choir with deambulatory and apsidal chapels (the oldest part of the church), a transept, nave and aisles. The towers at the west end were only completed during the general restoration which took place in the latter half of the 19th century. A fine cloister of the 13th century adjoins the south side of the church. Ste Marie contains glass windows of the 15th and 16th centuries and other rich decoration. The Vieux-Château, also in Grand Bayonne, dates from the 12th and 15th centuries and is built upon a portion of the old Roman fortifications; it is used for military purposes. The Château Neuf (15th and 16th centuries) serves as barracks and prison. Bayonne is the seat of a bishopric and of a sub-prefect; it has tribunals of first instance and of commerce, a chamber of commerce, a lycée, a school of music, a library, an art museum with a large collection of the works of the painter Léon Bonnat, and a branch of the Bank of France. There are consulates of the chief nations of Europe, of the United States of America and of several Central and South American republics. The town also possesses an important military arsenal and military hospital. The commerce of Bayonne is much more important than its industries, which include the manufacture of leather and of chocolate. The port consists of an outer harbour, the so-called "rade" (roadstead) and the port proper, and occupies the course of the Adour from its mouth, which is obstructed by a shifting bar, to the Pont St Esprit, and the course of the Nive as far as the Pont Mayou. Above these two bridges the rivers are accessible only to river navigation. Vessels drawing from 16 to 22 ft. can make the port in normal weather.

In the five years 1901-1905 the average value of the imports was £502,000, of the exports £572,000; for the five years 1896-1900 the average value of imports was £637,000, of exports £634,000. Exports include timber, mine-props, turpentine, resinous material from the Pyrenees and Landes and zinc ore; leading imports are the coal and Spanish minerals which supply the large metallurgical works of Le Boucau at the mouth of the river, the raw material necessary for the chemical works of the same town, wine, and the cereals destined for the flour mills of Pau, Peyrehorade and Orthez. During the early years of the 20th century the shipping of the port increased considerably in tonnage. In 1900 there entered 741 vessels, tonnage 277,959; and cleared 743, tonnage 276,902. In 1907 there entered 661 vessels, tonnage, 336,773; cleared 650, tonnage 335,840.

In the 3rd century Bayonne (*Lapurdum*) was a Roman military post and the principal port of Novempopulana. In the middle ages it belonged to the dukes of Aquitaine and then to the kings of England, one of whom, John, granted it full communal rights in 1216. In 1451 it offered a strenuous opposition to the French, by whom it was eventually occupied. By this time its maritime commerce had suffered disaster owing to the silting up of its port and the deflection of the Adour. New fortifications were constructed under Louis XII. and Francis I., and in 1523 the town was able to hold out against a Spanish army. In 1565 it was the scene of an interview between Charles IX. and Catherine de' Medici on the one hand and Elizabeth, queen of Spain, and the duke of Alva on the other. It is thought that on this occasion the plans were formed for the massacres of St Bartholomew, a crime in which Bayonne took no part, in 1572. In 1808 Napoleon met Charles IV., king of Spain, and his son Ferdinand at the Château de Marrac, near the town, and induced them to renounce their rights to the crown of Spain, which fell to Napoleon's brother Joseph. In 1814, after a severe siege, Bayonne was occupied by the English (see PENINSULAR WAR).

See J. Balasque and E. Dulaurens, *Études historiques sur la ville de Bayonne* (3 vols., Bayonne, 1862-1875); E. Ducéré, *Bayonne historique et pittoresque* (Bayonne, 1893); *Histoire topographique et anecdotique des rues de Bayonne* (Bayonne, 1894); H. Léon, *Histoire des juifs de Bayonne* (Paris, 1893).

BAYONNE, a city of Hudson county, New Jersey, U.S.A., occupying the peninsula (about 5½ m. long and about ¼ m. wide) between New York harbour and Newark Bay, and immediately adjoining the south boundary of Jersey City, from which it is partly separated by the Morris Canal. It is separated from Staten Island only by the narrow strip of water known as the Kill van Kull, and it has a total water frontage of about 10 m. Pop. (1890) 10,033; (1900) 32,722, of whom 10,786 were foreign-born (3168 Irish, 1868 Russian, 1656 German); (1910) 55,545. Land area about 4 sq. m. Bayonne is served by the Central of New Jersey and by the Lehigh Valley railways (the latter for freight only), and by electric railway lines to Newark and Jersey City. The principal public buildings are the city hall, the public library, the post-office and the city hospital. Besides having a considerable share in the commerce of the port of New York, Bayonne is an important manufacturing centre; among its manufactures are refined petroleum, refined copper and nickel (not from the ore), refined borax, foundry and machine-shop products, tubular boilers, electric launches and electric motors, chemicals (including ammonia and sulphuric acid and nitric acids), iron and brass products, wire cables and silk goods. In 1905 the value of its factory product was \$60,633,761, an increase of 57.1% over that of 1900, Bayonne ranking third in 1905 among the manufacturing cities of the state. It is the principal petroleum-distributing centre on the Atlantic seaboard, the enormous refineries and storehouses of the Standard Oil Company, among the largest in the world, being located here; there are connecting pipe lines with the Ohio and Pennsylvania oil fields, and with New York, Baltimore, Philadelphia and Washington. Much coal is shipped from the city. Bayonne, which comprises several former villages (Bayonne, Bergen Point, Pamrappo and Centerville), was settled about 1665-1670 by the Dutch. Originally a part of Bergen, it was set off as a township in 1861. It was chartered as a city in 1860.

BAYOU (pronounced bai-yoo, probably a corruption of Fr. *boyau*, gut), an "ox-bow" lake left behind by a river that has abandoned its old channel in the lower stages of its course. Good examples are found in Palmyra Lake, in the Mississippi valley below Vicksburg, and in Osage river, Missouri. As a river swings from side to side in a series of curves which widen laterally where the current is slow and the country more or less level, there is a tendency in flood times for the water to impinge more strongly upon the convex bank where the curve leaves the main channel. This bank will be eaten away, and the process will be repeated until the base of the "isthmus" is cut through, and the descending channel meets the returning curve, which is thus left stranded and filled with dead water, while the stream runs directly past it in the shorter course cut by the flood waters that deepen the new channel, and leave an isolated ox-bow lake in the old curve.

BAYREUTH, or **BAIREUTH**, a town of Bavaria, Germany, district of Upper Franconia, 58 m. by rail N.N.E. from Nuremberg. Pop. (1900) 29,384. In Richard-Wagner-strasse is Wagner's house, with his grave in the garden. Franz Liszt (1811-1886) is buried here, as well as Jean Paul Friedrich Richter, who is commemorated by a monument (1841). His house was in Friedrichstrasse. Most of the buildings are of comparatively modern date, the city having suffered severely from the Hussites in 1430 and from a conflagration in 1621. There should be mentioned the palace of Duke Alexander of Württemberg, the administrative offices, the statue of King Maximilian II. (1860) and the collections of the historical society. Among the ecclesiastical buildings, the *Stadt-Pfarrkirche*, dating from 1439, and containing the monuments of the margraves of Bayreuth, is the most important. Bayreuth is a railway junction and has an active trade, chiefly in grain and horses. It manufactures woollen, linen and cotton goods, leather, delit and other earthenware, and tobacco, and has also several breweries and distilleries. The village of St Georgen is a suburb to the north-east noted for its marble works; and about 2 m. to the east is the Hermitage, a fanciful building, erected in 1715 by the margrave George William (d. 1746), with gardens containing terraces, statues and fountains. Bayreuth was formerly the capital of a principality of the same name, which was annexed in 1791 to the kingdom of Prussia. In 1807 it was ceded by Prussia to France, which kept possession of it till 1810, when it was transferred to Bavaria.

The Wagner Theatre.—Among the many advantages which Wagner gained from his intimacy with Ludwig II., king of Bavaria, not the least was the practical support given to his plan of erecting a theatre for the ideal performance of his own music-dramas. The first plan of building a new theatre for the purpose in Munich itself was rejected, because Wagner rightly felt that the appeal of his advanced works, like the Nibelungen trilogy, would be far stronger if the comparatively small number of people who wished to hear them were removed from the distractions of a large capital; Bayreuth possessed the desired seclusion, being on a line of railway that could not be approached from any quarter without changing. The municipality furthered Wagner's scheme in every way, and in May 1872 the foundation stone of the Festspielhaus was laid, the event being commemorated by a notable performance of Beethoven's Choral Symphony in the old opera-house. The funds for the erection of the theatre were raised in part by the issue of 1000 certificates of patronage (*Patronatsscheine*), but the bulk of the sum was raised by founding "Wagner Societies" from St Petersburg to Cairo, from London to New York; these societies sprang up with such success that the theatre was opened in the summer of 1876 with the first complete performance of *Der Ring des Nibelungen*. The theatre, which stands on a height a little under a mile from the town, is built from the plans of Gustav Semper, the idea of the design being Wagner's own, an experiment indeed, but one which succeeded beyond all expectation. The seats are arranged on a kind of sloping wedge, in such a manner that every one has an almost equally good view of the stage, for there are no boxes, and the only galleries are quite

at the back, one, the *Firstenloge*, being reserved for distinguished guests, the other, above it, for the townspeople. Immediately in front of the foremost row of seats a hood or sloping screen of wood covers a part of the orchestra, and another hood of similar shape starts from the front of the stage at a slightly lower level. Thus there is left a space between the two hoods through which the sound of the orchestra ascends with wonderfully blended effect; the conductor, sitting at the highest point of the orchestra, though under the screen, has a complete view of the stage as well as of his instrumentalists, and the sound of the orchestra is sent most forcibly in the direction of the stage, so that the voices are always well supported.

As an important addition to the work of the theatre, a permanent school has been established at Bayreuth for the sake of training young musicians to take part in the festival performances, which were at first exclusively, and then partially, undertaken by artists from other German and foreign theatres. The special feature upon which most stress has been laid, ever since Wagner's death in 1883, has been not so much the musical as the dramatic significance of the works; it is contended by the inmost circle of Wagnerian adherents that none but they can fully realize the master's intentions or hand down his traditions. What is called the "Bayreuth Idea" is set forth in much detail from this point of view by Houston Stewart Chamberlain, in his *Richard Wagner* (1897 and 1900).

BAZA, a town of southern Spain, in the province of Granada; in the Hoya de Baza, a fruitful valley of the Sierra Nevada, not far from the small river Gallego, and at the terminus of a railway from Lorca. Pop. (1900) 12,770. The dome-shaped mountain of Javaleon (4715 ft.) overlooks the town from the north-west. The ancient collegiate church of San Maximo occupies the traditional site of a cathedral founded by the Visigothic king Reccared about 600, and afterwards converted into a mosque. There is a brisk local trade in farm produce, and in the linen, hempen goods and pottery manufactured in Baza. The town nearly doubled its population in the last quarter of the 19th century. Sulphurous springs exist in the vicinity.

Baza is the Roman *Basti*, the medieval *Basta* or *Bastiana*; and numerous relics of antiquity, both Roman and mediæval, have been found in the neighbourhood. Its bishopric was founded in 306. Under Moorish rule (c. 713-1489) it was one of the three most important cities in the kingdom of Granada, with an extensive trade, and a population estimated at 50,000. In 1489, after a stubborn defence lasting seven months, it was captured by the Spaniards under Isabella of Castile, whose cannon still adorn the *Alameda* or public promenade. On the 10th of August 1810 the French under Marshal Soult defeated a large Spanish force close to the town.

BAZAAR (Pers. *basar*, market), a permanent market or street of shops, or a group of short narrow streets of stalls under one roof. The word has spread westward into Arabic, Turkish and, in special senses, into European languages, and eastward it has invaded India, where it has been generally adopted. In southern India and Ceylon bazaar means a single shop or stall. The word seems to have early reached South Europe (probably through Turkish), for F. Balducci Pegolotti in his mercantile handbook (c. 1340) gives "bazzara" as a Genoese word for market-place. The Malayans peoples have adopted the word as *basar*. The meaning of the word has been much extended in English, where it is now equivalent to any sale, for charitable or mere commercial purposes, of mixed goods and fancy work.

BAZAINE, **ACHILLE FRANÇOIS** (1811-1888), marshal of France, was born at Versailles on the 13th of February 1811. He entered the army as a private soldier in 1831, with a view to service in Algeria, and received a commission as sub-lieutenant in 1833. By his gallantry in action he won the cross of the Legion of Honour, and he was promoted lieutenant in 1835. He served two campaigns with the Foreign Legion against the Carlists in Spain in 1837-38, returning to Africa as captain in 1839. During the succeeding decade he saw continual active service in Africa, and rose to be a brigadier-general with the charge of the district of Tlemçen. In the Crimean War he commanded a brigade, and maintained his reputation in the trenches before Sevastopol. On the capture of the south side he was appointed governor of the place, and was promoted general of

division. He also commanded the French forces in the expedition to Kinburn. In Lombardy in 1859 he was wounded when in command of a division at Melegnano, and took a conspicuous part in the battle of Solferino. For his services in the campaign he received the grand cross of the Legion of Honour, of which he was already (1855) a commander. He commanded with great distinction the first division under General (afterwards marshal) Forey in the Mexican expedition in 1862, succeeded him in supreme command in 1863, and became marshal and senator of France in the following year. He at first pursued the war with great vigour and success, entering Mexico in 1863 and driving President Juarez to the frontier. The marshal's African experience as a soldier and as an administrator stood him in good stead in dealing with the guerrilleros of the Juarez party, but he was less successful in his relations with Maximilian, with whose court the French headquarters was in constant strife. Here, as later in his own country, Bazaine's policy seems to have been directed, at least in part, to his own establishment in the rôle of a mayor of the palace. His own army thought that he aspired to play the part of a Bernadotte. His marriage to a rich Mexican lady, whose family were supporters of Juarez, still further complicated his relations with the unfortunate emperor, and when at the close of the American Civil War the United States sent a powerful war-trained army to the Mexican frontier, the French forces were withdrawn (see MEXICO, *History*). Bazaine skillfully conducted the retreat and embarkation at Vera Cruz (1867). On his return to Paris he was but coldly received by his sovereign; public opinion was, however, in his favour, and he was held to have been made a scapegoat for the faults of others.

At the outbreak of the Franco-German War (*q.v.*) Marshal Bazaine was placed in command of the III. corps of the Army of the Rhine. He took no part in the earlier battles, but Napoleon III. soon handed over the chief command of the army to him. How far his inaction was the cause of the disaster of Spicheren is a matter of dispute. The best that can be said of his conduct is that the evil traditions of warfare on a small scale and the mania for taking up "strong positions," common to the French generals of 1870, were in Bazaine's own case emphasized by his personal dislike for the "schoolmaster" Frossard, lately the Prince Imperial's tutor and now commander of the army corps posted at Spicheren. Frossard himself, the leader of the "strong positions" school, could only blame his own theories for the paralysis of the rest of the army, which left the corps at Spicheren to fight unsupported. Bazaine, indeed, when called upon for help, moved part of his corps forward, but only to "take up strong positions," not to strike a blow on the battlefield. A few days later he took up the chief command, and his tenure of it is the central act in the tragedy of 1870. He found the army in retreat, ill-equipped and numerically at a great disadvantage, and the generals and staffs discouraged and distrustful of one another. There was practically no chance of success. The question was one of extricating the army and the government from a disastrous adventure, and Bazaine's solution of it was to bring back his army to Metz. For the events which led up to the battles before Metz and the investment of Bazaine's whole army in the fortress, see FRANCO-GERMAN WAR and METZ, *Battles*.

It seems to be clearly established that the charges of treason to which later events gave so strong a colour had, as yet, no foundation in fact. Nor, indeed, can his unwillingness to leave the Moselle region, while there was yet time to slip past the advancing enemy, be considered even as proof of special incompetence. The resolution to stay in the neighbourhood of Metz was based on the knowledge that if the slow-moving French army ventured far out it would infallibly be headed off and brought to battle in the open by superior numbers. In "strong positions" close to his stronghold, however, Bazaine hoped that he could inflict damaging repulses and heavy slaughter on the ardent Germans, and in the main the result justified the expectation. The scheme was creditable, and even heroic, but the execution throughout all ranks, from the marshal to the battalion

commanders, fell far short of the idea. The minutely cautious methods of movement, which Algerian experience had evolved suitable enough for small African desert columns, which were liable to surprise rushes and ambushes, reduced the mobility of a large army, which had favourable marching conditions, to 5 m. a day as against the enemy's rate of 15. When, before he had finally decided to stay in Metz, Bazaine attempted half-heartedly to begin a retreat on Verdun, the staff work and organization of the movement over the Moselle was so ineffective that when the German staff calculated that Bazaine was nearing Verdun, the French had in reality barely got their artillery and baggage trains through the town of Metz. Even on the battlefield the marshal forbade the general staff to appear, and conducted the fighting by means of his personal orderly officers. After the cumbrous army had passed through Metz it encountered an isolated corps of the enemy, which was commanded by the brilliant leader Constantin von Alvensleben, and promptly attacked the French. At most every moment of the day victory was in Bazaine's hands. Two corps of the Germans fought all day for bare existence. But Bazaine had no confidence in his generals or his troops, and contented himself with inflicting severe losses on the most aggressive portions of the German army. Two days later, while the French actually retreated on Metz—taking seven hours to cover 5 to 6 m.—the masses of the Germans gathered in front of him, intercepting his communication with the interior of France. This Bazaine expected, and feeling certain that the Germans would sooner or later attack him in his chosen position, he made no attempt to interfere with their concentration. The great battle was fought, and having inflicted severe punishment on his assailants, Bazaine fell back within the entrenched camp of Metz. But although he made no appeals for help, public opinion, alarmed and excited, condemned the only remaining army of France, Marshal MacMahon's "Army of Châlons," to rescue Bazaine at all costs. The adventure ended at Sedan, and with Sedan the Third Empire collapsed.

Up to this point Bazaine had served his country perhaps as well as circumstances allowed, and certainly with enough skill and a sufficient measure of success to justify his appointment. His experience, wide as it was, had not fitted him for the command of a large army in a delicate position. Since his Mexican expedition, moreover, he had himself fallen into a state of moral and physical lethargy, which, imperceptible on the field of battle, because his reputation for impassive bearing under fire was beyond question, was only too obvious in the staff offices, where the work of manœuvring the army and framing plans and orders was chiefly done. But, in spite of these defects, it cannot be asserted that any one of Bazaine's subordinates would have done better, with the possible exception of Ladmirault, and Ladmirault was one of the junior corps commanders.

Bazaine, therefore, in the main justified his reputation for ability. He was now to justify his reputation for intriguing and underhand diplomacy. If in Mexico he aspired to the rôle of mayor of the palace, it was far more so in Metz, where, as commander of the only organized army of France, he conceived himself to be the ruler of the country's destiny. Accordingly he engaged in a series of diplomatic intrigues, some of which to this day have never been properly cleared up. Negotiations passed between the outer world and the besieged commander, the purport of which remains still to some extent obscure, but it is beyond question that he proposed with the permission of the Germans to employ his army in "saving France from herself." The scheme, however, collapsed, and the army of the Rhine became prisoners of war to the number of 140,000. At the moment of the surrender a week's further resistance would have enabled the levies of the National Defence government to crush the weak forces of the Germans on the Loire and to relieve Paris. But the army of Prince Frederick Charles, set free by the surrender, hurried up in time to check and to defeat the great effort at Orleans (*q.v.*). The responsibility for this crushing blow was naturally enough, and justly enough, placed on Bazaine's shoulders, and although, when he returned from captivity, the

marshal enjoyed a brief immunity, he was in 1873 brought to trial before a military court. He was found guilty of negotiating with and capitulating to the enemy before doing all that was prescribed by duty and honour, and sentenced to degradation and death, but very strongly recommended to mercy. His sentence was commuted to twenty years' seclusion, and the humiliating ceremonies attending degradation were dispensed with. He was incarcerated in the Île Sainte-Marguerite and treated rather as an exile than as a convict; thence he escaped in 1874 to Italy. He finally took up his abode in Madrid, where he was treated with marked respect by the government of Alfonso XII. He died there on the 23rd of September 1888. He published *Épisodes de la guerre de 1870* (Madrid, 1883). He also wrote *L'Armée du Rhin* (Paris, 1872).

See the bibliography appended to the article FRANCO-GERMAN WAR; also memoir by C. Pelletan in *La Grande Encyclopédie*; for Bazaine's conduct see *Bazaine et l'armée du Rhin* (1873); J. Valfrey, *Le Maréchal et l'armée du Rhin* (1873); Count A. de la Guéronnière, *L'Homme de Metz* (1871); Rossel, *Les Derniers Jours de Metz* (1871). See also the article BOURBAKI for the curious Regnier episode connected with the surrender of Metz.

BAZALGETTE, SIR JOSEPH WILLIAM (1819-1891), English engineer, was born at Enfield on the 28th of March 1819. At the age of seventeen he was articled to an engineer, and a few years later he began to practise successfully on his own account. His name is best known for the engineering works he carried out in London, especially for the construction of the main drainage system and the Thames embankment. In 1848 the control of London drainage, which had hitherto been divided among eight distinct municipal bodies, was consolidated under twelve commissioners, who were in 1849 superseded by a second commission. Under the latter Bazalgette accepted an appointment which he continued to hold under the three successive commissions which in the course of a year or two followed the second one, and when finally in 1855 these bodies were replaced by the Metropolitan Board of Works, he was at once appointed its chief engineer. His plans were ready, but the work was delayed by official obstruction and formality until 1858. Once begun, however, it was vigorously pushed on, and in 1865 the system was formally opened. It consisted of 83 m. of large intercepting sewers, draining more than 100 sq. m. of buildings, and calculated to deal with 420 million gallons a day. The cost was £4,600,000. Almost simultaneously Bazalgette was engaged on the plans for the Thames embankment. The section between Westminster and Vauxhall on the Surrey side was built between 1860 and 1869, and the length between Westminster and Blackfriars was declared open by the prince of Wales in 1870. The Chelsea embankment followed in 1871-1874, and in 1876 Northumberland Avenue was formed. The total outlay on the scheme exceeded £2,000,000. Bazalgette was also responsible for various other engineering works in the metropolitan area, designing, for example, new bridges at Putney and Battersea, and the steam ferry between north and south Woolwich. He also prepared plans for a bridge over the river near the Tower and for a tunnel under it at Blackwall, but did not live to see either of these projects carried out. He died on the 15th of March 1891 at Wimbledon.

BAZARD, AMAND (1791-1832), French socialist, the founder of a secret society in France corresponding to the Carbonari of Italy, was born at Paris. He took part in the defence of Paris in 1815, and afterwards occupied a subordinate situation in the prefecture of the Seine. About 1820 he united some patriotic friends into a society, called *Amis de la vérité*. From this was developed a complete system of Carbonarism, the peculiar principles of which were introduced from Italy by two of Bazard's friends. Bazard himself was at the head of the central body, and, while taking a general lead, contributed extensively to the Carbonarist journal, *L'Aristarque*. An unsuccessful outbreak at Belfort ruined the society, and the leaders were compelled to conceal themselves. Bazard, after remaining for some time in obscurity in Paris, came to the conclusion that the ends of those who wished well to the people would be most easily attained, not through political agitation,

but by effecting a radical change in their social condition. This train of thinking naturally drew him towards the socialist philosophers of the school of Saint-Simon, whom he joined. He contributed to their journal, *Le Producteur*; and in 1828 began to give public lectures on the principles of the school (see SAINT-SIMON). His opposition to the emancipation of women brought about a quarrel with *Enfantin* (q.v.) in 1831, and Bazard found himself almost deserted by the members of the society. He attacked *Enfantin* violently, and in a warm discussion between them he was struck down by apoplexy. After lingering for a few months he died on the 20th of July 1832.

BAZAS, a town of south-western France, in the department of Gironde, 38½ m. S.S.E. of Bordeaux by rail. Pop. (1906) town, 2505; commune, 4684. The town, which was the seat of a bishop from at least the beginning of the 6th century till 1790, has a Gothic church (formerly the cathedral) dating from the 13th to the 16th centuries. There are remains of ramparts (15th and 16th centuries) and several old houses of the 16th century. The vineyards of the vicinity produce white wine. The town is capital of an arrondissement, and carries on tanning, &c., and trade in the well-known Bazadais cattle.

Bazas (*Cossio*) was capital of the ancient tribe of the *Vasates*, and under the Romans one of the twelve cities of Novempopulana. In later times it was bloodshed of the district of Bazadais. It was the scene of much bloodshed during the religious wars of the 16th century.

BAZIGARS, a nomad gipsy-folk of India, found throughout the peninsula, and variously known as Bazigars, Panchipiri, Nats, Bedyias, &c. They live a life apart from the surrounding Hindu population, and still preserve a certain ethnical identity, scarcely justified by any indications given by their physique. They make a living as jugglers, dancers, basket-weavers and fortune-tellers; and in true European gipsy fashion each clan has its king.

BAZIN, RENÉ (1853-), French novelist and man of letters, was born at Angers on the 26th of December 1853. He studied law in Paris, and on his return to Angers became professor of law in the Catholic university there. He contributed to Parisian journals a series of sketches of provincial life and descriptions of travel, but he made his reputation by *Une Tache d'encre* (1888), which received a prize from the Academy. Other novels of great charm and delicacy followed: *La Sarcelle bleue* (1892); *Madame Corentine* (1893); *Humble Amour* (1894); *De toute son âme* (1897); *La Terre qui meurt* (1899); *Les Oberlé* (1901), an Alsatian story which was dramatized and acted in the following year; *L'Âme alsacienne* (1903); *Donatienne* (1903); *L'Isolée* (1905); *Le Blé qui lève* (1907); *Mémoires d'une vieille fille* (1908). *La Terre qui meurt*, a picture of the decay of peasant farming and a story of *La Vendée*, is an indirect plea for the development of provincial France. A volume of *Questions littéraires et sociales* appeared in 1906. René Bazin was admitted to the Academy on the 28th of April 1904.

BAZIRE, CLAUDE (1764-1794), French revolutionist, was deputy for the Côte d'Or in the Legislative Assembly, and made himself prominent by denouncing the court and the "Austrian committee" of the Tuileries. On the 20th of June 1792 he spoke in favour of the deposition of the king. In the Convention he sat with the Mountain, opposed adjourning the trial of Louis XVI., and voted for his death. He joined in the attack upon the Girondists, but, as member of the committee of general security, he condemned the system of the Terror. He was implicated by François Chabot in the falsification of a decree relative to the East India Company, and though his share seems to have been simply that he did not reveal the plot, of which he knew but part, he was accused before the Revolutionary Tribunal at the same time as Danton and Camille Desmoulins, and was executed on the 5th of April 1794.

BDELLIUM (βδέλλιον, used by Pliny and Dioscorides as the name of a plant which exuded a fragrant gum), a name applied to several gums or gum-resins that simulate and are sometimes found as adulterants of true myrrh (q.v.).

BEACH, a word of unknown origin; probably an old dialect word meaning shingle, hence, by transference, the place covered by shingle. Beach sometimes denotes the material thrown up by the waves, sometimes the long resulting ridge, but more frequently the area between high and low water, or even the area between land and sea covered with material thrown up by exceptional storms.

The actual character of beach material depends upon the nature and structure of the rocks inshore, the strength and direction of currents, and the force of the waves. The southern shore of the Isle of Wight furnishes a good example. The island ends westward in the well-known "Needles," consisting of chalk with flints. The disintegration of this rock by wave action separates the finer chalk, which is carried seawards in suspension, from the hard flint, which is piled in rough shingle upon the shore. The currents sweep constantly eastward up channel, and the rough flint shingle is rolled along by wave action toward the Ventnor rampart, and ground finer and finer until it arrives as a very fine flinty gravel at Ventnor pier. The sweep of Sandown Bay follows, where the cliffs are composed for the most part of greensand, and here the beach at low water is sandy and smooth. The eastern end of the island is again composed of chalk with flints, and here the beach material as at the western end consists of very coarse flint shingle. In this, as in similar cases, the material has been dragged seawards from the land by constant action of the undertow that accompanies each retreating tide and each returning wave. The resulting accumulated ridge is battered by every storm, and thrown above ordinary high-water mark in a ridge such as the Chesil Bank or the long grass-grown mound that has blocked the old channel of the Yar and diverted its waters into Yaverland Bay. Sandown furnishes an instructive example of the power of the eastward currents carrying high-storm waves. The groins built to preserve the foreshore are piled to the top with coarse shingle on the western side, while there is a drop of over 8 ft. on to the sands east of the wall, many thousands of tons of shingle having been moved bodily by the waves and deposited against each groin. The force of the waves has been measured on the west coast of Scotland and found to be as much as 3 tons per square foot. Against these forces the preservation of the shore from the advance of the sea becomes an extremely difficult and often a hopeless undertaking, since blocks of rock over 100 tons in weight have been moved by the waves. The beach is therefore unstable in its position. It advances in front of the encroaching sea, burying former beaches under the sand and mud of the now deeper water, or it retreats when the sea is withdrawn from the land or the land rises locally, leaving the old shingle stranded in a "raised beach," but its formation is in all cases due to the form and structure of the shore, the sapping action of the waves, the backward drag of the undertow plastering the shore with material, which is in turn bombarded by waves and swept by currents that cover the finer debris of the undertow with a layer of coarse fragments that are re-sorted by the daily action of currents and tides.

BEACHY HEAD, a promontory on the coast of Sussex, England, S.W. of Eastbourne, about 3 m. from the centre of the town. It consists of a perpendicular chalk cliff 532 ft. high, and forms the eastern termination of the hill-range known as the South Downs. The old Bell Tout lighthouse, 285 ft. above high-water mark, erected in 1831 on the second cliff to the westward, in $0^{\circ} 10' 18''$ E., $50^{\circ} 43' 30''$ N., has been superseded by a new lighthouse built in the sea at the foot of the head itself.

Battle of Beachy Head.—This naval battle, known to the French as *Bévisier* (a corruption of Pevensy), was fought on the 30th of June 1660. An allied force of 37 British sail of the line, under command of the earl of Torrington (Arthur Herbert), and of 22 Dutch under C. Evertsen, was at anchor under the headland, while a French fleet of over 70 sail, commanded by the comte de Tourville, was anchored some miles off to the south-west. The French fleet had orders to co-operate with an expected Jacobite rising in England. Torrington, to whom the general direction of the allied fleet belonged, was much disturbed by the enemy's superiority in number, and on the 26th had written to

the Council of Regency suggesting that he ought to retire to the Gunfleet at the mouth of the Thames, and observe the enemy from a distance till he could be reinforced. The council, which had the support of Admiral Russell, afterwards earl of Orford, considered that a retreat to the Gunfleet would have fatal consequences, by which they no doubt meant that it would leave the French free to land troops for the support of the Jacobites. They therefore ordered Herbert not to lose sight of the enemy, but rather to fight if he could secure an advantage of position. The admiral, who was on very bad terms with the council, elected to treat this as a peremptory order to fight. At daybreak on the 30th he got under way and bore down on the enemy. The wind was at north-east and gave him the weather-gage. As his fleet was only 57 sail in all he was not able to engage the enemy from end to end, but as the French were arranged in a line from east to west he could have fallen on the end nearest him, and could have guarded himself by telling off a part of his ships to watch the remainder. Torrington preferred to bring his fleet down in such a way that his van, consisting of the Dutch ships, should be opposite the enemy's van, his centre opposite their centre, and his rear should engage their rear. The inferiority of the allies in numbers made it therefore inevitable that there should be gaps between the different divisions. As the fleets actually did come to action, the Dutch with a few English ships pressed on the French van, their leading ship being abreast of the ninth or tenth Frenchman. Torrington took his station opposite the rear of the French centre, leaving a great gap between himself and the ships in the van. Being apprehensive that the French centre would tack and pass this gap so as to put him between two fires, he kept a long way off so as to be free to manœuvre against them if they made the attempt. The English rear division, consisting of the English blue squadron under Sir Ralph Delaval, fought a close action with the French opposite to them. In the meantime the French ships, ahead of the leading Dutchman, succeeded in turning to windward and putting part of Evertsen's squadron between two fires. The Dutch ships suffered heavily, and one of them which was dimasted drifted among the French and was taken. More severe loss would have followed if the better average seamanship of the English and Dutch had not stood them in good stead. The tide turned from flood to ebb during the action, and the surface current which in the Channel sets to the west with the ebb began to carry the fleets with it. The Dutch and English dropped anchor. The French, who were not equally alert, did not and were carried westward. When the tide turned the allies retreated to the Thames, abandoning several of the most damaged ships in Pevensy Bay. The pursuit of the French was ineffective, for Tourville persisted in keeping his ships in line of battle, which forced them to regulate their speed by the slowest among them. Torrington was tried for his conduct but acquitted.

A full account of the battle of Beachy Head, written with ample quotation of documents, and for the purpose of vindicating Herbert, will be found in Admiral Colomb's *Naval Warfare* (London, 1899). (D. H.)

BEACON (from the O. Eng. *bēacon*, a sign, esp. a "beckon," another form of the same word), a signal, especially a fire lit on a high hill, structure or building for the purpose of sending a message of alarm or of important news over long distances. Such was the courier-fire (*ἀγγαρος πύρι*) that brought the news of the fall of Troy to Argos (Aeschylus, *Agamemnon*), or the chain of signals that told of the approach of the Spanish Armada, or which circled the British Isles in the jubilee years of 1887 and 1897. The word occurs in many names for lofty and conspicuous hills, such as Dunkery Beacon in Somerset, the highest point on Exmoor. On many such hills the remains of old beacon towers and cressets are still found. The word is used generally of a lighthouse, but technically it means either a small unattended light, a superstructure on a floating buoy, such as a staff and cage, or staff and globe, or an unlighted structure, forming a conspicuous object at sea, used in each case to guide or warn sailors. (See LIGHTHOUSE and BUOY.)

BEACONSFIELD, BENJAMIN DISRAELI, EARL OF (1804-1881), British statesman, second child and eldest son of Isaac D'Israeli (q.v.) and Maria Basevi, who were married in 1802, was born at No. 6 John Street, Bedford Row, on the 21st of December 1804. Of Isaac D'Israeli's other children, Sarah was born in 1802, Naphthali in 1807, Ralph (Raphael) in 1809, and James (Jacob) in 1813. None of the family was akin to Benjamin for genius and character, except Sarah, to whom he was deeply indebted for a wise, unswerving and sympathetic devotion, when, in his earlier days, he needed it most. All Isaac D'Israeli's children were born into the Jewish communion, in which, however, they were not to grow up. It is a reasonable inference from Isaac's character that he was never at ease in the ritual of Judaism. His father died in the winter of 1816, and soon afterwards Isaac formally withdrew with all his household from the Jewish church. His son Benjamin, who had been admitted to it with the usual rites eight days after his birth, was baptized at St Andrew's church in Holborn on the 31st of July 1817. One of Isaac D'Israeli's reasons for quitting the tents of his people was that rabbinical Judaism, with its unyielding laws and fettering ceremonies, "cuts off the Jews from the great family of mankind." Little did he know, when therefore he cut off the D'Israeli family from Judaism, what great things he was doing for one small member of it. The future prime minister was then short of thirteen years old, and there was yet time to provide the utmost freedom which his birth allowed for the faculties and ambitions he was born with. Taking the worldly view alone, of course, most fortunate for his aspirations in youth was his withdrawal from Judaism in childhood. That it was fully sanctioned by his intellect at maturity is evident; but the vindication of unbiased choice would not have been readily accepted had Disraeli abandoned Judaism of his own will at the pushing *Vivian Grey* period or after. And though a mind like Disraeli's might work to satisfaction with Christianity as "completed Judaism," it could but dwell on a breach of continuity which means so much to Jews and which he was never allowed to forget amongst Christians. With all, he was proud of his race as truly, if not as vehemently, as his paternal grandmother detested it. Family pride contributed to the feeling in his case; for in his more speculative moods he could look back upon an ancestry which was of those, perhaps, who colonized the shores of the Mediterranean from before the time of the Captivity. More definite is the history of descent from an ennobled Spanish family which escaped from the Torquemada persecutions to Venice, there found a new home, took a new name, and prospered for six generations. The Benjamin D'Israeli, Lord Beaconsfield's grandfather, who came to England in 1748, was a younger son sent at eighteen to try his fortune in London. "A man of ardent character, sanguine, courageous, speculative, fortunate, with a temper which no disappointment could disturb" (so Lord Beaconsfield described him), he soon made the beginnings of a handsome fortune and turned country gentleman. That his grandson exaggerated his prosperity is highly probable; but that he became a man of wealth and consideration is certain. He married twice. His second wife was Sarah Sprout de Gabay, "a beautiful woman of strong intellect" and importunate ambitions, who hated the race she belonged to because it was despised by others. She felt so keenly the social disabilities it brought upon her, and her husband's indifference to them, that "she never pardoned him his name." Her literary son Isaac suffered equally or even more; for though he had ambitions he had none that she could recognize as such. She could ridicule him for the aspirations which he had not and for those which he had; on the other hand, he never heard from her a tender word "though she lived to be eighty." Nor did any other member of her family, according to her grandson.

Isaac D'Israeli was devoted to the reading and writing of books in domestic quiet; and his son Benjamin suffered appreciably from his father's gentle preoccupations. As a child—unruly and disturbing no doubt—he was sent to a school of small account at Blackheath, and was there "for years" before he was recalled at the age of twelve on the death of his grandfather.

Isaac D'Israeli was his father's sole heir, but change of fortune seems to have awakened in him no ambitions for the most hopeful of his sons. At fifteen, not before, Benjamin was sent to a Unitarian school at Walthamstow—a well-known school, populous enough to be a little world of emulation and conflict but otherwise unfit. Not there, nor in any similar institution at that illiberal time, perhaps, was a Jewish boy likely to make a fortunate entry into "the great family of mankind." His name, the foreign look of him, and some pronounced incompatibilities not all chargeable to young Disraeli (as afterwards the name came to be spelt), soon raised a crop of troubles. His stay at Walthamstow was brief, his departure abrupt, and he went to school no more. With the run of his father's library, and the benefits of that born bookman's guidance, he now set out to educate himself. This he did with an industry stiffened by matchless self-confidence and by ambitions fully mature before he was eighteen. Yet he yielded to an attempt to make a man of business of him. He was barely seventeen when (in November 1821) he was taken into the office of Messrs Swain, Stevens and Co., solicitors, in Frederick's Place, Old Jewry. Here he remained for three years—"most assiduous in his attention to business," said one of the partners, "and showing great ability in the transaction of it." It was then determined that he should go to the bar; and accordingly he was entered at Lincoln's Inn in 1824. But Disraeli had found other studies and an alien use for his pen. Though "assiduous in his attention to business" in Frederick's Place, he found time to write for the printer. Dr Smiles, in his *Memoirs of John Murray*, tells of certain pamphlets on the brightening prospects of the Spanish South American colonies, then in the first enjoyment of emancipation—pamphlets seemingly written for a Mr Powles, head of a great financial firm, whose acquaintance Disraeli had made. In the same year, apparently, he wrote a novel—his first, and never published. *Aylmer Papillon* was the title of it, Dr Smiles informs us; and he prints a letter from Disraeli to the John Murray of that day, which indicates its character pretty clearly. The last chapter, its author says, is taken up with "Mr Papillon's banishment under the Alien Act, from a ministerial misconception of a metaphysical sonnet." About the same time he edited a *History of Paul Jones*, originally published in America, the preface of the English edition being Disraeli's first appearance as an author. Murray could not publish *Aylmer Papillon*, but he had great hopes of its boyish writer (Isaac D'Israeli was an old friend of his), "took him into his confidence, and related to him his experiences of men and affairs." Disraeli had not completed his twenty-first year when (in 1825) Murray was possessed by the idea of bringing out a great daily newspaper; and if his young friend did not inspire that idea he keenly urged its execution, and was entrusted by "The Representative" with the negotiation of all manner of preliminaries, including the attempt to bring Lockhart in as editor. The title of the paper, *The Representative*, was Disraeli's suggestion. He chose reporters, looked to the setting-up of a printing-office, busied himself in all ways to Murray's great satisfaction, and, as fully appears from Dr Smiles's account of the matter, with extraordinary address. But when these arrangements were brought to the point of completion, Disraeli dropped out of the scheme and had nothing more to do with it. He was to have had a fourth share of the proprietorship, bringing in a corresponding amount of capital. His friend Mr Powles, whom he had enlisted for the enterprise, was to have had a similar share on the same conditions. Neither seems to have paid up, and that, perhaps, had to do with the quarrel which parted Benjamin Disraeli and John Murray before a sheet of the luckless *Representative* was printed. Many years afterwards (1853) Disraeli took an active interest in *The Press*, a weekly journal of considerable merit but meagre fortunes.

At the death of the elder Benjamin (1817), his son Isaac had moved from the King's Road, Gray's Inn (now Theobald's Road), to No. 6 Bloomsbury Square. Here he entertained the many distinguished friends, literary and political, who had been drawn to him by his "Curiosities" and other ingenious works,

and here his son Benjamin also had their acquaintance and conversation. In Bloomsbury Square lived the Austens, and to their house, a great resort of similar persons, Mrs Austen cordially welcomed him. Murray's friendship and associations helped him in like manner, no doubt; and thus was opened to Disraeli the younger a world in which he was to make a considerable stir. The very much smaller society of that day was, of course, more comprehensible to sight and hearing, when once you were within its borders, than the society of this. Reverberations of the gossip of St James's and Mayfair extended to Bloomsbury in those days. Yet Disraeli's range of observation

must have been not only brief but limited when he sat down at twenty or twenty-one to write *Vivian Grey*.

It is therefore a probable conjecture that Mrs Austen, a clever woman of the world, helped him from her knowledge. His own strongly perceptive imagination (the gift in which he was to excel every other politician of his time) and the bent of political reading and aspiration from boyhood completed his equipment; and so the wonder that so young a man in Disraeli's social position should write a book like *Vivian Grey* is accounted for. It was published in 1826. The success of this insolently clever novel, the immediate introduction of its author to the great world, and the daring eccentricities of dress, demeanour, and opinion by which he fixed attention on himself there, have always been among the most favourite morsels of Disraeli's history. With them it began, and successive generations of inquirers into a strange career and a character still shrouded and baffling refer to them as settled starting-points of investigation. What was the man who, in such a society and with political aspirations to serve, could thrive by such vagaries as these, or in spite of them? If unaffected, what is to be thought of them as keys to character? If affected, what then? Inquiry still takes this shape, and when any part of Disraeli's career is studied, the laces and essences, the rings over gloves, the jewelled satin shirt-fronts, the guitareries and chibouquies of his early days are never remote from memory. The report of them can hardly be doubted; and as the last relation was made (to the writer of this article) not with intent to ridicule Mr Disraeli's taste but to illustrate his conquering abilities, the story is repeated here. One of Disraeli's first friends in the world of fashion and genius was Sir Edward Lytton Bulwer. "And," said Sir Henry Bulwer ("Pelham's" brother), "we heard so much at the time of Edward's amazingly brilliant new friend that we were the less inclined to make his acquaintance." At length, however, Sir Edward got up a little dinner-party to convince the doubters. It was to meet at the early hour of those days at one of the Piccadilly hotels. "There was my brother, Alexander Cockburn, myself and (I think) Milnes; but for a considerable time no Mr Disraeli. Waiting for Mr Disraeli did not enhance the pleasure of meeting him, nor when he did arrive did his appearance predispose us in his favour. He wore green velvet trousers, a canary-coloured waistcoat, low shoes, silver buckles, lace at his wrists, and his hair in ringlets." The description of the coat is forgotten. "We sat down. Not one of us was more than five-and-twenty years old. We were all—if you will allow me to include myself—on the road to distinction, all clever, all ambitious, and all with a perfect conceit of ourselves. Yet if on leaving the table we had been severally taken aside and asked which was the cleverest of the party, we should have been obliged to say 'the man in the green velvet trousers.'" This story is a little lamp that throws much light. Here we see at their sharpest the social prejudices that Disraeli had to fight against, provocation of them carried to its utmost in every way open to him, and complete conquest in a company of young men less likely to admit superiority in a wit of their own years, probably, than any other that could have been brought together at that time.

Soon after the publication of *Vivian Grey*, Disraeli, who is said by Froude to have been "overtaken by a singular disorder," marked by fits of giddiness ("once he fell into a trance, and did not recover for a week"), went with the Austens on a long summer tour in France, Switzerland and Italy. Returning to a quiet life

at Bradenham—an old manor-house near High Wycombe, which his father had taken—Disraeli put law in abeyance and resumed novel-writing. His weakest book, and two or three other productions, brief, but in every literary sense the finest of his works, were written in the next two or three years. But for *Ixion in Heaven*, *The Infernal Marriage*, and *Popanilla*, Disraeli could not be placed among the greater writers of his kind; yet none of his imaginative books have been so little read as these. The mysterious malady continued, and Disraeli set out with William Meredith, who was to have married Sarah Disraeli, for a tour in southern Europe and the nearer East. He saw Cadix, Seville, Granada, Athens, Constantinople, Jerusalem, Cairo, Thebes; played the corsair with James Clay on a yacht voyage from Malta to Corfu; visited the terrible Reschid, then with a Turkish army in the Albanian capital; landed in Cyprus, and left it with an expectation in his singularly prescient mind that the island would one day be English. These travels must have profited him greatly, and we have our share of the advantage; not so much, however, in *The Wondrous Tale of Alroy or Tancred*, or the "Revolutionary Epic" which he was inspired to write on "the windy plains of Troy," but in the letters he sent home to his sister. These letters, written with the utmost freedom and fullness to the one whose affection and intellect he trusted more than any, are of the greatest value for interpreting the writer. Together with other letters also published some time after Disraeli's death, they tell more of him than anything that can be found in print elsewhere. They show, for example, that his extraordinary exuberances were unforced, leaping by natural impulse from an overcharged source. They also show that his Oriental fopperies were not so much "purposed affectation" as Froude and others have surmised. That they were so in great part is confessed again and again in these letters, but confessed in such a way as to reveal that they were permitted for his own enjoyment of them as much as planned. The "purposed affectation" sprang from an unaffected delight in gauds of attire, gauds of fancy and expression. It was not only to startle and impress the world that he paraded his eccentricities of splendour. His family also had to be impressed by them. It was to his sober father that he wrote, at the age of twenty-six: "I like a sailor's life much, though it spoils the toilette." It is in a letter from Gibraltar to the same hand that we read of his two canes—"a morning and an evening cane"—changed as the gun fires. And the same correspondent must be told that "Ralph's handkerchief which he brought me from Paris is the most successful thing I ever wore."

When Disraeli returned to England in 1831, all thought of the law was abandoned. The pen of romance was again taken up—the poet's also and the politician's. In the next five years he wrote *Contarini Fleming*, the *Revolutionary Epic*, *Alroy*, *Henrietta Temple*, *What is He?* (a pamphlet expository of his opinions), the *Runnymede Letters*, a *Vindication of the British Constitution*, and other matter of less note. The epic, begun in great hope and confidence, was ended in less, though its author was to the last unwilling that it should be forgotten. The novels revived the success he had with *Vivian Grey*, and restored him to his place among the brilliancies and powers of the time. The political writing, too, much of it in a garish, extravagant style, exercised his deeper ambitions, and stands as witness to the working of original thought and foresight. Both qualities are conspicuous in *What is He?* and the *Vindication*, of which it has been truly said that in these pages he "struck the keynote to the explanations he afterwards consistently offered of all his apparent inconsistencies." Here an interpretation of Tory principles as capable of running with the democratic idea, and as called upon to do so, is ingeniously attempted. The aristocratic principle of government having been destroyed by the Reform Bill, and the House of Lords being practically "abrogated" by that measure, it became necessary that Toryism should start from the democratic basis, from which it had never been alien. The filched liberties of the crown and the people should be restored, and the nation redeemed from the oligarchies which had stolen from both. When at the beginning of all this

"Vivian Grey,"

Travel.

Literary production.

writing Disraeli entered the political arena as candidate for High Wycombe (1832), he was nominated by a Tory and seconded by a Radical—in vain; and vain were two subsequent attempts in the autumn of 1832 and in 1834. In the first he was recommended to the electors by Daniel O'Connell and the Radical Hume. In his last candidature at Wycombe he stood on more independent ground, commending himself by a series of speeches which fully displayed his quality, though the presence which gilded them with more than one prophetic passage was veiled from his contemporaries. Among Disraeli's great acquaintances were many—Lyndhurst at their head—whose expectations of his future were confirmed by the Wycombe speeches. He was "thought of" for various boroughs, Marylebone among the number, but his democratic Toryism seems to have stood in his way in some places and his inborn dislike of Radicalism in others. It was an impracticable situation—no getting on from it; and so, at Lyndhurst's persuasion, as he afterwards acknowledged, he determined to side with the Tories. Accordingly, when in the spring of 1835 a vacancy occurred at Taunton, Disraeli contested the seat in the Tory interest with Carlton Club support. Here again he failed, but with enhanced reputation as a fighting politician and with other consequences good for notoriety. It was at Taunton that Disraeli fell upon O'Connell, rather ungratefully; whereupon the Liberator was roused to retort on his assailant vehemently as "a liar," and humorously as a probable descendant of the impenitent thief. And then followed the challenge which, when O'Connell declined it, was fastened on his son Morgan, and the interruption of the duel by seizure of Mr Disraeli in his bed, and his famous appearance in the Marylebone police court. He declared himself very well satisfied with this episode, but nothing in it can really have pleased him, not even the noise it made.

Here the first period of Disraeli's public life came to an end, a period of preliminaries and flourishes, and of what he himself called sowing his political wild oats. It was a more mature Disraeli who in the general election of 1837 was returned for Maidstone as the colleague of his providential friend Mr Wyndham Lewis. Though the fortunes of the Tory party were fast reviving under Peel's guidance, the victory was denied him on this occasion; but, for once, the return of the Whigs to power was no great disappointment for the junior member for Maidstone. To gain a footing in the House of Commons was all that his confident spirit ever asked, and Froude vouches for it that he succeeded only just in time to avert financial ruin. His electioneering ventures, the friendly backing of bills, and his own expense in keeping up appearances, had loaded him with debt. Yet (mark his worldly wisdom) "he had never entangled his friends in his financial dealings. He had gone frankly to the professional money-lenders, who made advances to him in a speculation on his success"; they were to get their money back with large interest or lose it altogether. Such conditions were themselves incitement enough to a prompt redemption of the promise of parliamentary distinction, even without the restless spurring of ambition. And Disraeli had another promise to redeem: that which he uttered when he told O'Connell that they would meet again at Philippi. Therefore when, three weeks after the session began, a debate on Irish election petitions gave him opportunity, Disraeli attempted that first House of Commons speech which imagination still dwells upon as something wondrous strange. That he should not have known better, even by hearsay, than to address the House of Commons in fantastic phrase from the mouth of a fantastic figure is indeed remarkable, but not that he retained self-confidence enough to tell the unwitting crew who laughed him down that a time would come when they would hear him. It was one of the least memorable of his prophecies. The speech was a humiliating but not an oppressive failure. In about a week afterwards he spoke again, which shows how little damage he felt, while the good sense, brevity, and blameless manner of the speech (on a copy-right bill) announced that he could learn. And for some time thereafter he affected no importance in the House, though not as withdrawing from attention.

Meanwhile, consciously and unconsciously, as is the way with men of genius, his mind was working upon problems of government, the magnitude, the relations and the natural developments of which he was more sensible of than any known politician of his time. "Sensible of," we say, to mark the difference between one sort of understanding and another which comes of labour and pains alone. Disraeli studied too, no doubt, reading and inquiring and applying set thought, but such means were insufficient to put into his mind all that he found there. It seems that opinions may be formed of inquiry and study alone, which are then constructive; but where intuitive perception or the perceptive imagination is a robust possession, the fruits of research become assimilative—the food of a divining faculty which needs more or less of it according to the power of divination. The better judgment in all affairs derives from this quality, which has some very covetable advantages for its possessor. His judgments may be held with greater confidence, which is an intellectual advantage; and, standing in his mind not so much an edifice as a natural growth, they cannot be so readily abandoned at the call of ease or self-interest.

They may be denied assertion or even outraged for a purpose, but they cannot be got rid of,—which is a moral advantage. Disraeli's mind and its judgments were of this character. Its greatest gift was not the romantic imagination which he possessed abundantly and employed overmuch, but the perceptive, interpretative, judicial or divining imagination, without which there can be no great man of affairs. Breadth of view, insight, foresight, are more familiar but less adequate descriptions of a faculty which Disraeli had in such force that it took command of him from first to last. Although he knew and acted on the principle that "a statesman is a practical character," whose business is to "serve the country according to its present necessities," he was unable to confine his vision to the nearer consequences of whatever policy, or course of action, or group of conditions it rested on. Without effort, and even without intention probably, it looked beyond first consequences to the farther or the final outcome; and to complete the operation, the faculty which detected the remoter consequences did not allow them to remain in obscurity, but brought them out as actualities no less than the first and perhaps far more important than the first. Moreover, it did not allow him to keep silence where the remoter consequences were of that character, and ought to be provided for betimes. Of course silence was always possible. These renderings to foresight might be denied assertion either for the sake of present ease (and Disraeli's presence of much of his country's later troubles only made him laughed at) or in deference to hopes of personal advancement. But the same divining imagination which showed him these things also showed him the near time when it would be too late to speak of them, and when not to have spoken would leave him irredeemably in the common herd of hand-to-mouth politicians. Therefore he spoke.

Remembrance of these characteristics—remembrance, too, that his mind, which was neither English nor European, worked in absolute detachment—should accompany the traveller through all the turns and incidents of Disraeli's long career. They are sometimes puzzling, often speculative; yet nearly all that is obscure in them becomes clear, much apparent contradiction disappears, when read by these persistent unvarying lights. The command which his idiosyncrasies had upon him is shown, for example, by reproachful speeches on the treatment of Ireland, and by a startling harangue on behalf of the Chartists, at a time when such irregularities could but damage him, a new man, where he hoped for influence and office. At about the same time his political genius directed him to open a resolute critical campaign against the Conservatism of the party he proposed to thrive in, and he could but obey. This he did in writing *Coningsby*, a novel of the day and for the day, but commended to us of a later generation not only by the undimmed truth of its character-portraits, but by qualities of insight and foresight which we who have seen the proof of them can measure as his contemporaries

Mental characteristics.

Enters Parliament.

"Coningsby," "Sphib."

could not. *Sybil*, which was written in the following year (1845), is still more remarkable for the faculties celebrated in the preceding paragraph. When *Sybil* was written a long historic day was ending in England, a new era beginning; and no eyes saw so clearly as Disraeli's the death of the old day, the birth of the new, or what and how great their differences would be. In *Coningsby* the political conditions of the country were illustrated and discussed from the constitutional point of view, and by light of the theory that for generations before the passing of the Reform Bill the authority of the crown and the liberties of the people had been absorbed and extinguished in an oligarchic system of government, itself become fossilized and soulless. In *Sybil* were exhibited the social relations of rich and poor (the "two nations") under this régime, and under changes in which, while the peasantry were neglected by a shoddy aristocracy ignorant of its duties, factory life and a purlind gospel of political economy imbruted the rest of the population. These views were enforced by a startling yet strictly accurate representation of the state of things in the factory districts at that time. Taken from the life by Disraeli himself, accompanied by one or two members of the Young England party of which he was the head, it was the first of its kind; and the facts as there displayed, and Disraeli's interpretation of them—a marvel of perceptive and prophetic criticism—opened eyes, roused consciences, and led direct to many reforms.

These two books, the *Vindication*, published in 1835, and his speeches up to this time and a little beyond, are quite enough to show what Disraeli's Tory democracy meant, how truly national was its aim, and how exclusive of partisanship for the "landed interest"; though he did believe the stability and prosperity of the agricultural class a national interest of the first order, not on economic grounds alone or even chiefly. And if Disraeli, possessed by these views, became aggressively insubordinate some time before Peel's proclaimed conversion to Free Trade, we can account for it on reasonable and even creditable grounds. Spite, resentment at being passed over when Peel formed the 1841 government, is one explanation of these outbreaks, and a letter to Peel, lately published, is proof to many minds that Disraeli's denial to Peel's face in 1846 that he had ever solicited office was daringly mendacious. The letter certainly reads like solicitation in the customary half-veiled form. All that can be said in doubt is that since the '41 government came into existence on the 6th of September, and the letter was written on the 5th, its interpretation as complaint of being publicly neglected, as a craving for some mark of recognition, is possible. More than possible it is if Disraeli knew on the 5th (as he very well might from his friend Lyndhurst, Peel's lord chancellor) that the appointments were then complete. The pecuniary need of office, if that comes into the question, had been lightened, if not extinguished, two years before by his marriage with Mrs Wyndham Lewis. Mrs Lewis—a lady fifteen years his senior—brought him a considerable fortune which, however, was but for her life. She lived to a great age, and would gladly have lived longer, in any of the afflictions that time brings on, to continue her mere money-worth to her "Dizzy." Her devotion to him, and his devotion to her, is the whole known story of their private life; and we may believe that nothing ever gratified him more than offering her a coronet from Mr Disraeli.

Disraeli made Peel's acquaintance early in his career and showed that he was proud of it. In his *Life of Lord George Bentinck* he writes of Peel fairly and even generously. But they were essentially antipathetic persons; and it is clear that the great minister and complete Briton took no pains to understand the dazzling young Jew of whom Lyndhurst thought so much, and wished to have little to do with him. Such men make such feelings evident; and there is no reason for thinking that when, after 1841, Disraeli charged at Peel in obedience to his principles, he gave himself pain. It was not long after it had settled in office that Peel's government, the creature of an anxious Conservative reaction, began to be suspected of drifting toward Manchester. That it was forced in that direction we should

say rather, looking back, for it was a time of dire distress, especially in the manufacturing districts of the north; so that in his second session Peel had to provide some relief by revising the corn laws and reducing import duties generally. His measures were supported by Disraeli, who understood that Protection must bend to the menacing poverty of the time, though unprepared for total abolition of the corn tax and strongly of opinion that it was not for Peel to abolish it. In the next session (1843) he and his Young England party took up a definitely independent rôle, which became more sharply critical to the end. Disraeli's first strong vote of hostility was on a coercion bill for perishing and rebellious Ireland. It was repeated with greater emphasis in the session of 1844, also in a condition-of-Ireland debate; and from that time forth, as if foreseeing Peel's course and its effect on the country party, Disraeli kept up the attack. Meanwhile bad harvests deepened the country's distress, Ireland was approached by famine, the Anti-Corn-Law League became menacingly powerful, and Peel showed signs of yielding to free trade. Disraeli's opportunity was soon to come now; and in 1845, seeing it on the way, he launched the brilliantly destructive series of speeches which, though they could not prevent the abolition of the corn-laws, abolished the minister who ended them. These speeches appeal more to admiration than to sympathy, even where the limitations of Disraeli's protectionist beliefs are understood and where his perception of the later consequences of free trade is most cordially acknowledged. That he remained satisfied with them himself is doubtful, unless for their foresight, their tremendous effect as instruments of punishment, and as they swept him to so much distinction. Within three years, on the death of Lord George Bentinck, there was none to dispute with him the leadership of the Conservative party in the House of Commons.

In the parliament of 1841 he was member for Shrewsbury. In 1847 he was returned for Buckinghamshire, and never again had occasion to change his constituency. Up to this time his old debts still embarrassed him, but now his private and political fortunes changed together. Froude reports that he "received a large sum from a private hand for his *Life of Lord George Bentinck*" (published in 1852), "while a Conservative millionaire took upon himself the debts to the usurers; the 3% with which he was content being exchanged for the 10% under which Disraeli had been staggering." In 1848 his father Isaac D'Israeli died, leaving to his son Benjamin nearly the whole of his estate. This went to the purchase of Hughenden Manor—not, of course, a great property, but with so much of the pleasant and picturesque, of the dignified also, as quite to explain what it was to the affectionate fancy of its lord. About this time, too (1851), his acquaintance was sought by an old Mrs Brydges Williams—born a Spanish Jewess and then the widow of a long-deceased Cornish squire—who in her distant home at Torquay had conceived a restless admiration for Benjamin Disraeli. She wrote to him again and again, pressing for an appointment to consult on an important matter of business: would meet him at the fountain of the Crystal Palace in Hyde Park. Her importunity succeeded, and the very small, oddly-dressed, strange-mannered old lady whom Disraeli met at the fountain became his adoring friend to the end of her life. Gratitude for her devotion brought him and his wife in constant intimacy with her. There were many visits to Torquay; he gratified her with gossiping letters about the great people with whom and the great affairs with which the man who did so much honour to her race was connected, that being the inspiration of her regard for him. She died in 1863, leaving him all her fortune, which was considerable; and, as she wished, was buried at Hughenden, close to the grave where Disraeli was to lie.

It is agreed that the first three years of Disraeli's leadership in Opposition were skillfully employed in reconstructing the shattered Tory party. In doing this he made it sufficiently clear that there could be no sudden return to Protectionist principles. At the same time, however, he insisted (as he did

from first to last) on the enormous importance to the country, to the character of its people no less than to its material welfare, of agricultural contentment and prosperity; and he also obtained a more general recognition of the fact that "the land" had borne fiscal burdens under the old régime which were unfair and unendurable under the new. So far he did well; and when in 1852 he took office as chancellor of the exchequer in Lord Derby's first administration, the prospect was a smiling one for a man who, striving against difficulties and prejudices almost too formidable for imagination in these days, had attained to a place where he could fancy them all giving way. That, however, they were not. New difficulties were to arise and old prejudices to revive in full force. His first budget was a quaint failure, and was thrown out by a coalition of Liberals and Peelites which he believed was formed against Mr Disraeli more than against the chancellor of the exchequer. It was on this occasion that he exclaimed, "England does not love coalitions." After a reign of ten months he was again in Opposition, and remained so for seven years. Of the Crimean War he had a better judgment than those whose weakness led them into it, and he could tell them the whole truth of the affair in twenty words: "You are going to war with an opponent who does not want to fight, and whom you are unwilling to encounter." Neither were they prepared; and the scandals and political disturbances that ensued revealed him as a party leader who could act on such occasions with a dignity, moderation and sagacity that served his country well, maintained the honour of party government and cost his friends nothing. The mismanagement of the war broke down the Aberdeen government in 1855, and then Disraeli had the mortification of seeing a fortunate chance of return to office lost by the timidity and distrust of his chief, Lord Derby—the distrust too clearly including the under-valuation of Disraeli himself. Lord Derby wanted Lord Palmerston's help, Mr Gladstone's, Mr Sidney Herbert's. This arrangement could not be made; Lord Derby therefore gave up the attempt to form a ministry and Lord Palmerston came in. The next chance was taken in less favourable times. The government in which Disraeli was again financial minister lasted for less than eighteen months (1858-1859), and then ensued another seven years in the cold and yet colder shade of Opposition. Both of these seven-year outings were bad, but the second by far the worse. Parliamentary reform had become a burning question and an embarrassing one for the Tory party. An enormous increase of business, consequent upon the use of steam machinery and free-trade openings to commerce, filled the land with prosperity, and discredited all statesmanship but that which steered by the star over Manchester. Mr Gladstone's budgets, made possible by this prosperity, were so many triumphs for Liberalism. Foreign questions arose which strongly excited English feeling—the arrangements of peace with Russia, Italian struggles for freedom, an American quarrel, the "Arrow" affair and the Chinese war, the affair of the French colonels and the Conspiracy Bill; and as they arose Palmerston gathered into his own sails (except on the last occasion) every wind of popular favour. Amid all this the Tory fortunes sank rapidly, becoming nearly hopeless when Lord Palmerston, without appreciable loss of confidence on his own side, persuaded many Tories in and out of parliament that Conservatism would suffer little while he was in power. Yet there was great despondency, of course, in the Conservative ranks; with despondency discontent; with discontent rancour. The prejudice against Disraeli as Jew, the revolt at his theatricalisms, the distrust of him as "mystery man," which up to this time had never died out even among men who were his nearest colleagues, were now more openly indulged. Out of doors he had a "bad press," in parliament he had some steady, enthusiastic friends, but more that were cold. Sometimes he was seen on the front Opposition bench for hours quite alone. Little conspiracies were got up to displace him, and might have succeeded but for an unconquerable dread of the weapon that destroyed Peel. In this state of things he patiently held his ground, working for his party more carefully than it knew, and never seizing upon false or discrediting

advantages. But it was an extremely bad time for Benjamin Disraeli.

Though Lord Palmerston stumbled over his Foreign Conspiracy Bill in 1858, his popularity was little damaged, and it was in no hopeful spirit that the Tories took office again in that year. They were perilously weak in the House of Commons, and affairs abroad, in which they had small practice and no prestige, were alarming. Yet the new administration did very well till, after resettling the government of India, and recovering from a blunder committed by their Indian secretary, Lord Ellenborough, they must needs launch a Reform Bill to put that dangerous question out of controversial politics. The well-intended but fantastic measure brought in for the purpose was rejected. The country was appealed to, with good but insufficient results; and at the first meeting of the new parliament the Tories were turned out on a no-confidence vote moved by Lord Hartington. Foreign affairs supplied the motive: failure to preserve the peace of Europe at the time of the Italian war of independence. It is said that the foreign office had then in print a series of despatches which would have answered its accusers had they been presented when the debate began, as for some unexplained reason they were not. Lord Palmerston now returned to Downing Street, and while he lived Disraeli and his colleagues had to satisfy themselves with what was meant for useful criticism, though with small hope that it was so for their own service. A Polish insurrection, the Schleswig-Holstein question, a commercial treaty with France, the Civil War in America, gave Disraeli occasions for speech that was always forcible and often wiser than all could see at the time. He never doubted that England should be strictly neutral in the American quarrel when there was a strong feeling in favour of the South. All the while he would have gladly welcomed any just means of taking an animated course, for these were dull, dark days for the Conservatives as a parliamentary party. Yet, unperceived, Conservatism was advancing. It was much more than a joke that Palmerston sheltered Conservative principles under the Liberal flag. The warmth of his popularity, to which Radical applause contributed nothing in his later days, created an atmosphere entirely favourable to the quiet growth of Conservatism. He died in 1865. Earl Russell succeeded him as prime minister, Mr Gladstone as leader of the House of Commons. The party most pleased with the change was the Radical, the party best served was Disraeli's. Another Reform Bill, memorable for driving certain good Liberals into a Cave of Adulam, broke up the new government in a few months; Disraeli contributing to the result by the delivery of opinions not new to him and of lasting worth, though presently to be subordinated to arguments of an inferior order and much less characteristic. "At this rate," he said in 1866, "you will have a parliament that will entirely lose its command over the executive, and it will meet with less consideration and possess less influence." Look for declining statesmanship, inferior aptitude, genius dying off. "Instead of these you will have a horde of selfish and obscure mediocrities, incapable of anything but mischief, and that mischief devised and regulated by the raging demagogue of the hour." The Reform legislation which promised these results in 1866 was thrown out. Lord Derby's third administration was then formed in the summer of the same year, and for the third time there was a Tory government on sufferance. Its followers were still a minority in the House of Commons; an angry Reform agitation was going on; an ingenious resolution founded on the demand for an enlarged franchise serviceable to Liberals might extinguish the new government almost immediately; and it is pretty evident that the Tory leaders took office meaning to seek a cure for this desperate weakness by wholesale extension of the suffrage. Their excuses and calculations are well known, but when all is said, Lord Derby's statement of his character, "a leap in the dark," and of its intention, "dishing the Whigs," cannot be bettered. Whether Lord Derby or Mr Disraeli originated this resolve has been much discussed, and it remains an unsettled question. It is known that Disraeli's private secretary, Mr Ralph Earle, quarrelled with him violently at about this time; and Sir William Fraser relates that, meeting

Mr Earle, that gentleman said: "I know what your feelings must be about this Reform Bill, and I think it right to tell you that it was not Disraeli's bill, but Lord Derby's. I know everything that occurred." Mr Earle gave the same assurances to the writer of these lines, and did so with hints and half-confidences (quite intelligible, however) as to the persuasions that wrought upon his chief. Mr Earle's listener on these occasions confesses that he heard with a doubting mind, and that belief in what he heard still keeps company with Mahomet's coffin. One thing, however, is clear. To suppose Disraeli satisfied with the excuses made for his adoption of the "dishing" process is forbidden by the whole tenor of his teaching and conduct. He could not have become suddenly blind to the fallacy of the expectations derived from such a course; and all his life it had been his distinction to look above the transient and trafficking expedients of the professional politician. However, the thing was done. After various remodellings, and amid much perturbation, secession, violent reproach, the Household Suffrage Bill passed in August 1867. Another memorable piece of work, the confederation of Canada, had already been accomplished. A few days after parliament met

Premier,
1868.

in the next year Lord Derby's failing health compelled him to resign, and Mr Disraeli became prime minister. Irish disaffection had long been astir; the Fenian menace looked formidable not only in Ireland but in England also. The reconstructed government announced its intention of dealing with Irish grievances. Mr Gladstone approved, proposing the abolition of the Irish Church to begin with. A resolution to that effect was immediately carried against the strong opposition of the government. Disraeli insisted that the question should be settled in the new parliament which the franchise act called for, and he seems to have had little doubt that the country would declare against Mr Gladstone's proposal. He was mistaken. It was the great question at the polls; and the first elections by the new constituencies went violently against the authors of their being.

The history of the next five years is Mr Gladstone's. The Irish Church abolished, he set to work with passionate good intention on the Irish land laws. The while he did so sedition took courage and flourished exceedingly, so that to pacify Ireland the constable went hand in hand with the legislator. The abolition of the Irish Church was followed by a coercion act, and the land act by suspension of *Habeas Corpus*. Disraeli, who at first preferred retirement and the writing of *Lothair*, came forward from time to time to point the moral and predict the end of Mr Gladstone's impulsive courses, which soon began to fret the confidence of his friends. Some unpleasant errors of conduct—the case of Sir R. Collier (afterwards Lord Monkswell, *q.v.*), the Ewelme rectory case,¹ the significant Odo Russell (Lord Amthill) episode (to help the government out of a scrape the ambassador was accused of exceeding his instructions)—told yet more. Above all, many humiliating proofs that England was losing her place among the nations came out in these days, the discovery being then new and unendurable. To be brief, in less than four years the government had well-nigh worn out its own patience with its own errors, failures and distractions, and would gladly have gone to pieces when it was defeated on an Irish university bill. But Disraeli, having good constitutional reasons for declining office at the moment, could not allow this. Still gathering unpopularity, still offending, alarming, alienating, the government went on till 1874, suddenly dissolved parliament, and was signally beaten, the Liberal party breaking up. Like most of his political friends, Disraeli had no expectation of such a victory—little hope, indeed, of any distinct success. Yet when he went to Manchester on a brief political outing two years before, he was received with such acclaim as he had never known in his life. He was then sixty-eight years old, and this was his first full banquet of popularity. The elation and confidence drawn from the Manchester meetings

¹ The crown had in 1871 appointed the Rev. W. W. Harvey (1810-1883), a Cambridge man, to the living of Ewelme, near Oxford, for which members of the Oxford house of convocation were alone eligible. Gladstone was charged with evading this limitation in allowing Harvey to qualify for the appointment by being formally admitted M.A. by incorporation.

were confirmed by every circumstance of the 1874 elections. But he was well aware of how much he owed to his opponents' errors, seeing at the same time how safely he could lay his future course by them. He had always rejected the political economy of his time, and it was breaking down. He had always refused to accept the economist's dictum without reference to other considerations than the turnover of trade; and even Manchester could pardon the refusal now. The national spirit, vaporized into a cosmopolitan mist, was fast condensing again under mortification and envy of cash profit. This was a changing England, and one that Disraeli could govern on terms of mutual satisfaction; but not if the reviving "spirit of the country" ran to extremes of self-assertion. At one of the great Manchester meetings he said, "Do not suppose, because I counsel firmness and decision at the right moment, that I am of that school of statesmen who are favourable to a turbulent and aggressive diplomacy. I have resisted it during a large part of my life."

But for the hubbub occasioned by the Public Worship Regulation Act, the first two years of the 1874 administration had no remarkable excitements till near the end of them. The Public Worship Act, introduced by the archbishop of Canterbury, was meant to restrain ritualism. Disraeli, who from first to last held to the Reformed Church as capable of dispensing social good as no other organization might, supported the Bill as "putting down ritualism"; spoke very vehemently; gave so much offence that at one time neither the bill nor the government seemed quite safe. For some time afterwards there was so little legislation of the kind called "enterprising" that even some friends of the government began to think it too tame; but at the end of the second year an announcement was made which put that fear to rest. The news that the khedive's Suez Canal shares had been bought by the government was received with boundless applause. It was a courageous thing to do; but it was not a Disraeli conception, nor did it originate in any government department. It was suggested from without at a moment when the possibility of ever acquiring the shares was passing away. On the morning of the 15th of November 1875, Mr Frederick Greenwood, then editor of the *Pall Mall Gazette*, went to Lord Derby at the foreign office, informed him that the khedive's shares were passing into the hands of a French syndicate, and urged arrest of the transaction by purchase for England. (The shares being private property their sale could not, of course, be forbidden.) Lord Derby thought there must be a mistake. He could not believe that bargaining of that kind could go on in Cairo without coming to the knowledge of the British consul there. He was answered that nevertheless it was going on. The difficulties of purchase by England were then arrayed by Lord Derby. They were more than one or two, and of course they had a formidable look, but so also had the alternative and the lost opportunity. One difficulty had already come into existence, and had to be met at once. Lord Derby had either to make direct inquiry of the khedive or to let the matter go. If he inquired, and there was no such negotiation, his question might be interpreted in a very troublesome way; moreover, we should put the idea of selling the shares into the khedive's head, which would be unfortunate. "There's my position, and now what do you say?" The answer given, Lord Derby drafted a telegram to the British consul-general at Cairo, and read it out. It instructed Colonel Stanton to go immediately to the khedive and put the question point blank. Meanwhile the prime minister would be seen, and Lord Derby's visitor might call next day to hear the reply from Cairo. It is enough to add here that on receipt of the answer the purchase for England was taken up and went to a speedy conclusion.²

² As if upon the impulse of this transaction, Disraeli opened the next session of parliament with a bill to confer upon the queen the title of empress of India—a measure which offended

¹ For a detailed, if somewhat controversial, account of this affair, see Lucien Wolf's article in *The Times* of December 26, 1905, and Mr Greenwood's letters on the subject.

the instincts of many Englishmen, and, for the time, revived the prejudices against its author. More important was the revival of disturbances in European Turkey, which, in their outcome, were to fill the last chapter of Disraeli's career. But for this interruption it is likely that he would have given much of his attention to Ireland, not because it was an attractive employment for his few remaining years, but because he saw with alarm the gathering troubles in that country. And his mind was strongly drawn in another direction. In a remarkable speech delivered in 1872, he spoke with great warmth of the slighting of the colonies, saying that "no minister in this country will do his duty who neglects any opportunity of reconstructing as much as possible our colonial empire, and of responding to those distant sympathies which may become the source of incalculable strength and happiness to this island." However, nothing was done in fulfilment of this duty in the first two years

from 1874, and early in the third the famous Andrássy note, the Berlin memorandum, the Bashi-Bazouk atrocities, and the accumulative excitement thereby created in England, reopened the Eastern question with a vengeance. The policy which Disraeli's government now took up may be truly called the national policy. Springing from the natural suggestions of self-defence against the march of a dangerous rivalry, it had the sanction of all British statesmanship for generations, backed by the consenting instinct of the people. It was quite unsentimental, being pro-Turkish or anti-Russian only as it became so in being pro-British. The statesmen by whom it was established and continued saw in Russia a power which, unless firmly kept within bounds, would dominate Europe; more particularly that it would undermine and supersede British authority in the East. And without nicely considering the desire of Russia to expand to the Mediterranean, the Pacific or in any other direction, they thought it one of their first duties to maintain their own Eastern empire; or, to put it another way, to contrive that Great Britain should be subject to Russian ascendancy (if ever), at the remotest period allowed by destiny. Such were the ideas on which England's Russian policy was founded. In 1876 this policy revived as a matter of course in the cabinet, and as spontaneously, though not upon a first provocation, became popular almost to fury. And furiously popular it remained. But a strong opposing current of feeling, equally passionate, set in against the Turks; war began and lasted long; and as the agitation at home and the conflict abroad went on, certain of Disraeli's colleagues, who were staunch enough at the beginning, gradually wavered. It is certainly true that Disraeli was prepared, in all senses of the word, to take strong measures against such an end to the war as the San Stefano treaty threatened. Rather than suffer that, he would have fought the Russians in alliance with the Turks, and had gone much farther in maturing a scheme of attack and defence than was known at the time or is commonly known now. That there was a master motive for this resolution may be taken for granted; and it is to be found in a belief that not to throw back the Russian advance then was to lose England's last chance of postponing to a far future the predominance of a great rival power in the East. How much or how little judgment shows in that calculation, when viewed in the light of later days, we do not discuss. What contention it had from his colleagues dropped away. At the end their voices were strong enough to insist upon the diplomatic action which at no point falls back on the sword; Lord Derby (foreign minister) being among the first to make a stand on that resolution, though he was not the first seceder from the government. Such diplomacy in such conditions is paralytic. It cannot speak thrice, with whatever affectation of boldness, without discovering its true character to trained ears; which should be remembered when Disraeli's successes at Berlin are measured. It should be remembered that what with the known timidity of his colleagues, and what with the strength and violence of the Russian party in England, his achievement at Berlin was like the reclamation of butter from a dog's mouth; as Prince Bismarck understood in acknowledging Disraeli's gifts of statesmanship. It should also be

Eastern question.

remembered, when his Eastern policy in 1876-1878 is denounced as malign and a failure, that it was never carried out. Good or bad, ill or well-calculated, effective existence was denied to it; and a man cannot be said to have failed in what he was never permitted to attempt. The nondescript course of action which began at the Constantinople conference and ended at Berlin was not of his direction until its few last days. It only marked at various stages the thwarting and suppression of his policy by colleagues who were haunted night and day by memories of the Crimean War, and not least, probably, by the fate of the statesmen who suffered for its blunders and their own. Disraeli also looked back to those blunders, and he was by no means insensible to the fate of fallen ministers. But just as he maintained at the time of the conflict, and after, that there would have been no Crimean War had not the British government convinced the tsar that it was in the hands of the peace party, so now he believed that a bold policy would prevent or limit war, and at the worst put off grave consequences which otherwise would make a rapid advance.

As if aware of much of this, the country was well content with Disraeli's successes at Berlin, though sore on some points, he himself sharing the soreness. Yet there were great days for him after his return. At the Berlin conference he had established a formidable reputation; the popularity he enjoyed at home was affectionately enthusiastic; no minister had ever stood in more cordial relations with his sovereign; and his honours in every kind were his own achievement against unending disadvantage. But he was soon to suffer irretrievable defeat. A confused and unsatisfactory war in Afghanistan, troubles yet more unsatisfactory in South Africa, conspired with two or three years of commercial distress to invigorate "the swing of the pendulum" when he dissolved parliament in 1880. Dissolution the year before would have been wiser, but a certain pride forbade. The elections went heavily against him. He took the blow with composure, and sank easily into a comparative retirement. Yet he still watched affairs as a great party leader should, and from time to time figured vigorously in debate. Meanwhile he had another novel to sit down to—the poor though highly characteristic *Endymion*; which, to his great surprise and equal pleasure, was replaced on his table by a cheque for ten thousand pounds. Yet even this satisfaction had its tang of disappointment; for though *Endymion* was not wholly written in his last days, it was in no respect the success that *Lithair* was. This also he could bear. His description of his grandfather recurs to us: "A man of ardent character, sanguine, courageous and fortunate, with a temper which no disappointment could disturb."

As earl of Beaconsfield (failing health had compelled him to take refuge in the House of Lords in 1876) Benjamin Disraeli died in his house in Curzon Street on the 19th of April 1881. The likelihood of his death was publicly known for some days before the event, and then the greatness of his popularity and its warmth were declared for the first time. No such demonstration of grief was expected even by those who grieved the most. He lies in Hughenden churchyard, in a rail-enclosed grave, with liberty for the turf to grow between him and the sky. Within the church is a marble tablet, placed there by his queen, with a generous inscription to his memory. The anniversary of his death has since been honoured in an unprecedented manner, the 19th of April being celebrated as "Primrose Day"—the primrose, for reasons impossible accurately to define, being popularly supposed to have been Disraeli's favourite flower. Even among his friends in youth (Sir Edward Lytton Bulwer, for example), and not improbably among the city men who waged their *Death and influence.* money in irrevocable loans to him on the chance of his success, there may have been some who compassed the thought of Benjamin Disraeli as prime minister and peer; but at no time could any fancy have imagined him remembered so enduringly as Lord Beaconsfield has been. It is possible that Sarah Disraeli (the Myra of *Endymion*), or that "the most severe of critics but a perfect wife," may have had such dreams—hardly that they could have occurred to any mind but a devoted woman's. Disraeli's life was a succession of surprises, but none

was so great as that he should be remembered after death more widely, lastingly, respectfully, affectionately, than any other statesman in the long reign of Queen Victoria. While he lived he did not seem at all cut out for that distinction even as an Imperialist. Significant as was the common grief when he died, no such consequence could be inferred from it, and certainly not from the elections of 1880. It stands, however, this high distinction, and with it the thought that it would have been denied to him altogether had the "adventurer" and "mystery man" of the 'sixties died at the age of threescore years and ten. We have said that never till 1872 did he look upon the full cup of popularity. It might have been said that even at that time intrigue to get rid of him had yet to cease in his own party; and but a few years before, a man growing old, he was still in the lowest depths of his disappointments and humiliations. How, then, could it be imagined that with six years of power from his seventieth year, the Jew "adventurer," mysterious and theatrical to the last, should fill a greater space in the mind of England twenty years after death than Peel or Palmerston after five? Of course it can be explained; and when explained, we see that Disraeli's good fortune in this respect is not due entirely to his own merits. His last years of power might have been followed by as long a period of more acceptable government than his own, to the effacement of his own from memory; but that did not happen. What did follow was a time of universal turbulence and suspicion, in which the pride of the nation was wounded again and again. To say "Majuba" and "Gordon" recalls its deepest hurts, but not all of them; and it may be that a pained and angry people, looking back, saw in the man whom they lately displaced more than they had ever seen before. From that time, at any rate, Disraeli has been acknowledged as the regenerator and representative of the Imperial idea in England. He has also been accused on the same grounds; and if the giver of good wine may be blamed for the guest who gets drunk on it, there is justice in the accusation. It is but a statement of fact, however, that Disraeli retains his hold upon the popular mind on this account mainly. The rekindling of the Imperial idea is understood as a timely act of revolt and redemption: of revolt against continuous humiliations deeply felt, redemption from the fate of nations obviously weak and suspected of timidity. It has been called rescue-work—deliverance from the dangers of invited aggression and a philosophical neglect of the means of defence. And its first achievement for the country (this is again a mere statement of fact) was the restoration of a much-damaged self-respect and the creation of a great defensive fleet not a day too soon for safety. So much for "the great heart of the people." Meanwhile political students find to their satisfaction that he never courted popularity, and never practised the art of working for "quick returns" of sympathy or applause. As "adventurer," he should have done so; yet he neglected the cultivation of that paying art for the wisdom that looks to the long future, and bears its fruit, perchance, when no one cares to remember who sowed the seed. So it is that to read some of his books and many of his speeches is to draw more respect and admiration from their pages than could have been found there originally. The student of his life understands that Disraeli's claim to remembrance rests not only on the breadth of his views, his deep insight, his long foresight, but even more on the courage which allowed him to declare opinions supplied from those qualities when there was no visible likelihood of their justification by experience, and therefore when their natural fate was to be slighted. His judgments had to wait the event before they were absolved from ridicule or delivered from neglect. The event arrives; he is in his grave; but his reputation loses nothing by that. It gains by regret that death was beforehand with him.

"Adventurer," as applied to Disraeli, was a mere term of abuse. "Mystery-man" had much of the same intention, but in a blameless though not in a happy sense it was true of him to the end of his days. Even to his friends, and to many near him, he remained mysterious to the last. It is impossible to doubt that some two or three, four or five perchance, were at home in his mind, being freely admitted there; but of partial admissions

to its inner places there seem to have been few or none. Men who were long associated with him in affairs, and had much of his stunted companionship, have confessed that with every wish to understand his character they never succeeded. Sometimes they fancied they had got within the topping walls of the maze, and might hope to gain the point whence survey could be made of the whole; but as often they found themselves, in a moment, where they stood at last and at first—outside. His speeches carry us but a little way beyond the mental range; his novels rather baffle than instruct. It is commonly believed that Disraeli looked in the glass while describing Sidonia in *Coningsby*. We group the following sentences from this description for a purpose that will be presently seen:—(1) "He was admired by women, idolized by artists, received in all circles with great distinction, and appreciated for his intellect by **Character.** the very few to whom he at all opened himself." (2) "For, though affable and generous, it was impossible to penetrate him: though unreserved in his manners his frankness was limited to the surface. He observed everything, thought ever, but avoided serious discussion. If you pressed him for an opinion he took refuge in rallery, and threw out some paradox with which it was not easy to cope. The secret history of the world was Sidonia's pastime. His great pleasure was to contrast the hidden motive with the public pretext of transactions." (3) "He might have discovered a spring of happiness in susceptibilities of the heart; but this was a sealed fountain for Sidonia. In his organization there was a peculiar, perhaps a great deficiency; he was a man without affection. It would be hard to say that he had no heart, for he was susceptible of deep emotions; but not for individuals. Woman was to him a toy, man a machine." These sentences are separately grouped here for the sake of suggesting that they will more truly illustrate Disraeli's character if taken as follows:—The first as representing his most cherished social ambitions—in whatever degree achieved. The second group as faithfully and closely descriptive of himself; descriptive too of a character purposely cloaked. The third as much less simple; in part a mixture of truth with Byronic affectation, and for the rest (and more significantly), as intimating the resolute exercise of extraordinary powers of control over the promptings and passions by which so many capable ambitions have come to grief. So read, Sidonia and Benjamin Disraeli are brought into close resemblance by Disraeli himself; for what in this description is untrue to the suspected fundamentals of his character is true to his known foibles. But for a general interpretation of Lord Beaconsfield and his career none serves so well as that which Froude insists on most. He was thoroughly and unchangeably a Jew. At but one remove by birth from southern Europe and the East, he was an Englishman in nothing but his devotion to England and his solicitude for her honour and prosperity. It was not wholly by volition and design that his mind was strange to others and worked in absolute detachment. He had "none of the hereditary prepossessions of the native Englishman." No such prepossessions disturbed his vision when it was bent upon the rising problems of the time, or rested on the machinery of government and the kind of men who worked it and their ways of working. The advantages of Sidonia's intellect and temperament were largely his, in affairs, but not without their drawbacks. His pride in his knowledge of the English character was the pride of a student; and we may doubt if it ever occurred to him that there would have been less pride but more knowledge had he been an Englishman. It is certain that in shrouding his own character he checked the communication of others to himself, and so could continue to the end of his career the costly mistake of being theatrical in England. There was a great deal too (though little to his blame) in Lord Malmesbury's observation that he was not only disliked in the House of Commons for his mysterious manner, but prejudiced by a pronounced foreign air and aspect. Lord Malmesbury does not put it quite as strongly as that, but he might have done so with truth. No Englishman could approach Disraeli without some immediate consciousness that he was in the presence of a foreigner.

Lord Beaconsfield has been praised for his integrity in money matters; the praise could have been spared—it does not rise high enough. It is also said to his honour that he "never struck at a little man," and that was well; but it is explained as readily by pride and calculation as by magnanimity. A man of extraordinary coolness and self-control, his faults in every kind were faults of excess: it is the mark of them all. But whatever offence they gave, whatever mischief they did, was soon exhausted, and has long since been pardoned.

AUTHORITIES.—The writer's personal knowledge is largely represented in the above article. Among the biographical literature available prior to the authoritative *Life* the following may be cited:—Lord Beaconsfield's Preface to 1849 edition of Isaac D'Israeli's works; *Correspondence with his Sister*, and *Home Letters*, edited by Ralph Disraeli; Samuel Smiles, *Memoirs and Correspondence of John Murray: Life of the Earl of Beaconsfield*, by F. Hitchman; *Memoir* by T. E. Kebbel; *Memoir* by J. A. Froude; *Memoir* by Harold Gorst; Sir William Fraser's *Disraeli and his Day*; *The Speeches of Lord Beaconsfield*, edited by T. E. Kebbel. In 1904, however, the large collection of material for Lord Beaconsfield's life, in the hands of his executors Lord Rowton and Lord Rothschild, was acquired by *The Times*, and the task of preparing the biography was assigned to Mr W. F. Monypenny, an assistant editor of *The Times* (1894-1899), who was best known to the public as editor of the *Johannesburg Star* during the crisis of 1899-1903. (F. G.)

BEACONSFIELD, a town of Devon county, Tasmania, on the river Tamar, 28 m. direct N.W. of Launceston. Pop. (1901) 2658. From its port at Beauty Point, 3½ m. distant, with which it is connected by a steam tramway, communication is maintained with Georgetown and Launceston. It is the centre of the most important gold-field in the island.

BEACONSFIELD, a town of South Africa in Griqualand West, about 3 m. S.W. of Kimberley, of which it is practically a suburb, though possessing a separate municipality. Pop. (1904) 9378, of whom 2780 were whites. Beaconsfield was founded in 1879 near the famous Dutoitspan diamond mine. The land on which the town is built belongs to the De Beers Company. (See **KIMBERLEY**.)

BEACONSFIELD, a town in the Wycombe parliamentary division of Buckinghamshire, England, 23 m. W. by N. of London, on the main road to Oxford, and on the Great Central & Great Western joint railway. Pop. of urban district (1901) 1570. It lies in a hilly well-wooded district above the valley of the small river Wye, a tributary of the Thames. The broad Oxford road forms its picturesque main street. It was formerly a posting station of importance, and had a considerable manufacture of ribbons. The perpendicular church of St Mary and All Saints is the burial place of Edmund Burke (d. 1797), who lived at Gregories, or as he named it Butler's Court, near the town. He would have taken his title from Beaconsfield had he survived to enter the peerage. A monument to his memory was erected in 1808. Edmund Waller the poet owned the property of Hall Barn, and died here in 1687. His tomb is in the churchyard. Benjamin Disraeli chose the title of earl of Beaconsfield in 1876, his wife having in 1868 received the title of Viscountess Beaconsfield. The opening of railway communication with London in 1906 resulted in a considerable accretion of residential population.

BEAD, a small globe or ball used in necklaces, and made of different materials, as metal, coral, diamond, amber, ivory, stone, pottery, glass, rock-crystal and seeds. The word is derived from the Middle Eng. *bede*, from the common Teutonic word for "to pray," cf. German *beten* and English *bedesman*, the meaning being transferred from "prayer" to the spherical bodies strung on a rosary and used in counting prayers. Beads have been made from remote antiquity, and are found in early Egyptian tombs; variegated glass beads, found in the ground in certain parts of Africa, as Ashantiland, and highly prized by the natives as *aggy*-beads, are supposed to be of Egyptian or Phœnician origin. Beads of the more expensive materials are strung in necklaces and worn as articles of personal adornment, while the cheaper kinds are employed for the decoration of women's dress. Glass beads have long been used for purposes of barter with savage tribes, and are made in enormous numbers and varieties, especially in Venice, where the manufacture has existed from at least the 14th century. Glass, either transparent, or of opaque

coloured enamel (*smalti*), or having complex patterns produced by the twisting of threads of coloured glass through a transparent body, is drawn out into long tubes, from which the beads are pinched off, and finished by being rotated with sand and ashes in heated cylinders.

In architecture, the term "bead" is given to a small cylindrical moulding, in classic work often cut into bead and reel.

BEADLE, also **BEDEL** or **BEDELL** (from A.S. *bydel*, from *beodan*, to bid), originally a subordinate officer of a court or deliberative assembly, who summoned persons to appear and answer charges against them (see Du Cange, *supra* tit. *Bedelli*). As such, the beadle goes back to early Teutonic times; he was probably attached to the moot as its messenger or summoner, being under the direction of the reeve or constable of the leet. After the Norman Conquest, the beadle seems to have diminished in importance, becoming merely the crier in the manor and forest courts, and sometimes executing processes. He was also employed as the messenger of the parish, and thus became, to a certain extent, an ecclesiastical officer, but in reality acted more as a constable by keeping order in the church and churchyard during service. He also attended upon the clergy, the churchwardens and the vestry. He was appointed by the parishioners in vestry, and his wages were payable out of the church rate. From the Poor Law Act of 1601 till the act of 1834 by which poor-law administration was transferred to guardians, the beadle in England was an officer of much importance in his capacity of agent for the overseers. In all medieval universities the bedel was an officer who exercised various executive and spectacular functions (H. Rashdall, *Hist. of Universities in the Middle Ages*, i. 193). He still survives in many universities on the continent of Europe and in those of Oxford and Cambridge, but he is now shorn of much of his importance. At Oxford there are four bedels, representing the faculties of law, medicine, arts and divinity. Their duties are chiefly processional, the junior or sub-bedel being the official attendant on the vice-chancellor, before whom he bears a silver mace. At Cambridge there are two, termed esquire-bedels, who both walk before the vice-chancellor, bearing maces.

BEAK (early forms *beke* and *becke*, from Fr. *bec*, late Lat. *beccus*, supposed to be a Gaulish word; the Celtic *bec* and *beq*, however, are taken from the English), the horny bill of a bird, and so used of the horny ends of the mandibles of the octopus, the duck-billed platypus and other animals; hence the rostrum (*q.v.*) or ornamented prow of ancient war vessels. The term is also applied, in classic architecture, to the pendent fillet on the edge of the corona of a cornice, which serves as a drip, and prevents the rain from flowing inwards.

The slang use of "beak" for a magistrate or justice of the peace has not been satisfactorily explained. The earlier meaning, which lasted down to the beginning of the 19th century, was "watchman" or "constable." According to *Slang and its Analogues* (J. S. Farmer and W. E. Henley, 1890), the first example of its later use is in the name of "the Blind Beak," which was given to Henry Fielding's half-brother, Sir John Fielding (about 1750). Thomas Harman, in his book on vagrants, *Caveat or Warning for common cursitors*, *Vulgarely called Vagabones*, 1573, explains *harmans beck* as "countstable," *harm* being the word for the stocks. Attempts have been made to connect "beak" in this connexion with the Old English *bæg*, a gold torque or collar, worn as a symbol of authority, but this could only be plausible on the assumption that "magistrate" was the earlier significance of the word.

BEAKER (Scottish *bicker*, Lat. *bicarium*, Ger. *Becher*, a drinking-bowl), a large wide-mouthed drinking-cup or laboratory vessel. See **DRINKING-VESSELS**.

BEALE, DOROTHEA (1831-1906), English schoolmistress, was born on the 21st of March 1831 in London, her father being a physician of good family and cultivated tastes. She had already shown a strong intellectual bent and considerable force of character when in 1848 she was one of the first to attend lectures at the newly opened Queen's College for Ladies, London, and from 1849 to 1856 she herself took classes there. In 1857

for a few months she became head teacher of the Clergy Daughters' school at Casterton, Westmoreland, but narrow religious prejudices on the part of the governors led to her retirement. In 1858 she was appointed principal of the Ladies College at Cheltenham (opened 1854), then in very low water. Her tact and strenuousness, backed by able financial management, led to its success being thoroughly established by 1864, and as the college increased in numbers new buildings were erected from 1873 onwards. Under Miss Beale's headship it grew into one of the great girls' schools of the country, and its development and example played an important part in the revolution effected in regard to the higher education of women. Miss Beale retained her post till her death on the 9th of November 1906. Strongly religious by nature, broad-minded and keenly interested in all branches of culture, she exercised a far-reaching influence on her pupils.

Her *Life* was written by Elizabeth Raikes (1908).

BEAM (from the O. Eng. *bēam*, cf. Ger. *Baum*, a tree, to which sense may be referred the use of "beam" as meaning the roof or crucifix, and the survival in certain names of trees, as horn-beam), a solid piece of timber, as a beam of a house, of a plough, a loom, or a balance. In the last case, from meaning simply the cross-bar of the balance, "beam" has come to be used of the whole, as in the expression "the king's beam," or "common beam," which refers to the old English standard balance for wholesale goods, for several hundred years in the custody of the Grocers' Company, London. As a nautical term, "beam" was transferred from the main cross-timbers to the side of the ship; thus "on the weather-beam" means "to windward," and a ship is said to be "wide in the beam" when she is wide horizontally. The phrase "to be on one's beam-ends," denoting a position of extreme peril or helplessness, is borrowed from the position of a ship which has heeled over so far as to stand on the ends of her horizontal beams. The meaning of "beam" for shafts or rays of light comes apparently from the use of the word to translate the Latin *columna lucis*, a pillar of light.

BEAN (a common Teutonic word, cf. Ger. *Bohne*), the seed of certain leguminous plants cultivated for food all over the world, and furnished chiefly by the genera *Vicia*, *Phaseolus*, *Dolichos* and others. The common bean, in all its varieties, as cultivated in Britain and on the continents of Europe and America, is the produce of *Vicia Faba*. The French bean, kidney bean, or haricot, is the seed of *Phaseolus vulgaris*; but in India several other species of this genus of plants are raised, and form no small portion of the diet of the inhabitants. Besides these there are numerous other pulses cultivated for the food both of man and domestic animals, to which the name bean is frequently given. The common bean is even more nutritious than wheat; and it contains a very high proportion of nitrogenous matter under the form of legumin, which amounts on an average to 24%. It is, however, a rather coarse food, and difficult of digestion, and is chiefly used to feed horses, for which it is admirably adapted. In England French beans are chiefly, almost exclusively, used in the green state; the whole pod being eaten as a table vegetable or prepared as a pickle. It is wholesome and nutritious; and in Holland and Germany the pods are preserved in salt by almost every family for winter and spring use. The green pods are cut across obliquely, most generally by a machine invented for the purpose, and salted in barrels. When wanted for use they are steeped in fresh water to remove the salt, and broiled or stewed they form an agreeable addition to the diet at a time when no other vegetable may be had.

The broad bean—*Vicia Faba*, or *Faba vulgaris*, as it is known by those botanists who regard the slight differences which distinguish it from the great majority of the species of the vetch genus (*Vicia*) as of generic importance—is an annual which has been cultivated from prehistoric times for its nutritious seeds.

The lake-dwellers of Switzerland, and northern Italy in the bronze age cultivated a small-fruited variety, and it was grown in ancient Egypt, though, according to Herodotus, regarded by the priests as unclean. The ancient Greeks called it *κίναρος*, the Latins *faba*, but there is no suggestion that the plant is a

native of Europe. Alphonse de Candolle (*Origin of Cultivated Plants*, p. 320) concludes that the bean was introduced into Europe probably by the western Aryans at the time of their earliest migrations. He suggests that its wild habitat was twofold some thousands of years ago, one of the centres being to the south of the Caspian, the other in the north of Africa, and that its area has long been in process of diminution and extinction. The nature of the plant favours this hypothesis, for its seed has no means of dispersing itself, and rodents or other animals can easily make prey of it; the struggle for existence which was going against this plant as against maize would have gradually isolated it and caused it to disappear, if man had not saved it by cultivation. It was introduced into China a little before the Christian era, later into Japan and more recently into India, though it has been suggested that in parts of the higher Himalayas its cultivation has survived from very ancient times. It is a plant which will flourish in all ordinary good garden soil. The seeds are sown about 4 in. apart, in drills 2½ ft. asunder for the smaller and 3 ft. for the larger sorts. The soil should, preferably, be a rather heavy loam, deeply worked and well enriched. For an early crop, seeds may be sown in November, and protected during winter in the same manner as early peas. An early crop may also be obtained by dibbling in the seeds in November, sheltering by a frame, and in February transplanting them to a warm border. Successional crops are obtained by sowing suitable varieties from January to the end of June. All the culture necessary is that the earth be drawn up about the stems. The plants are usually topped when the pods have set, as this not only removes the black aphides which often settle there, but is also found to promote the filling of the pods.

The following are some of the best sorts:—for early use, Early Mazagan, Long-pod, Marshall's Early Prolific and Seville Long-pod; for late use, Carter's Mammoth Long-pod and Broad Windsor.

The horse-bean is a variety—var. *equina*.

Cultivation of Field-bean.—Several varieties of *Vicia Faba* (e.g. the horse bean, the mazagan, the tick bean, the winter bean) are cultivated in the field for the sake both of the grain, which is used as food for live-stock, and of the haulm, which serves for either fodder or litter. They are best adapted for heavy soils such as clays or clayey loams. The time for sowing is from the end of January to the beginning of March, or in the case of winter beans from the end of September to the middle of November. The bean-crop is usually interposed between two crops of wheat or some other cereal. If spring beans are to be sown, the land after harvest is dressed with farmyard manure, which is then ploughed in. In January the soil is levelled with the harrows, and the seed, which should be hard and light brown in colour, is drilled in rows from 15 to 24 in. apart at the rate of from 2 to 2½ bushels to the acre and then harrowed in. The alternative is to "dibble" the seed in the furrow left by the autumn ploughing and cover it in with the harrows; or the land may be ridged with the double-breasted plough, manure deposited in the furrows and the seed sown broadcast, the ridges being then split back so as to cover both manure and seed. After the plant shows, horse-hoeing and hand-hoeing between the rows is carried on so long as the plant is small enough to suffer no injury therefrom. The routine of cultivation for winter beans hardly differs from that described except as regards the time of sowing.

Beans are cut when the leaf is fallen and the haulm is almost black either with the fagging hook or the reaping machine, though the stoutness of the stalks causes a severe strain on the latter implement. They are tied and stooked, and are so left for a considerable time before stacking. There is less fear of injury to the crop through damp than in the case of other cereals. Their value for feeding purposes increases in the stack, where they may remain for a year or more before threshing. Pea and bean weevils, both striped (*Sitona lineatus*) and spotted (*Sitona crinitus*), and the bean aphid (*Aphis rumicis*), are noted pests of the crop. Winter beans come to maturity earlier than the spring-sown varieties, and are therefore strong enough to resist

the attacks of the aphid by the end of June, when it begins its ravages. Field-beans yield from 25 to 35 bushels to the acre.

Phaseolus vulgaris, the kidney, French or haricot bean, an annual, dwarf and bushy in growth, is widely cultivated in temperate, sub-tropical and tropical regions, but is nowhere known as a wild plant. It was long supposed to be of Indian origin, an idea which was disproved by Alphonse de Candolle, who sums up the facts bearing on its origin as follows:—*Phaseolus vulgaris* has not been long cultivated in India, the south-west of Asia and Egypt, and it is not certain that it was known in Europe before the discovery of America. At the latter epoch the number of varieties in European gardens suddenly increased, and all authors began to mention them. The majority of the species of the genus exist in South America, and seeds apparently belonging to the species in question have been found in Peruvian tombs of an uncertain date, intermixed with many species, all American. Hence it is probable that the plant is of South American origin.

It is a tender annual, and should be grown in a rich light loamy soil and a warm sheltered situation. The soil should be well enriched with hot-bed dung. The earliest crop may be sown by the end of March or beginning of April. If, however, the temperature of the soil is below 45°, the beans make but little progress. The main crops should be got in early in May; and a later sowing may be made early in July. The earlier plantings may be sown in small pots, and put in frames or houses, until they can be safely planted out-of-doors. A light covering of straw or some other simple shelter suffices to protect from late frosts. The seeds should be covered 1½ or 2 in. deep, the distance between the rows being about 2 ft., or for the dwarf sorts 18 in., and that between plants from 4 to 6 in. The pods may be used as a green vegetable, in which case they should be gathered whilst they are so crisp as to be readily snapped in two when bent; but when the dry seeds are to be used the pods should be allowed to ripen. As the green pods are gathered others will continue to be formed in abundance, but if old seed-forming pods are allowed to remain the formation of young ones will be greatly checked. There are numerous varieties; among the best are Canadian Wonder, Canterbury and Black Negro.

Phaseolus multiflorus, scarlet runner, is nearly allied to *P. vulgaris*, of which it is sometimes regarded as a variety, but differs in its climbing habit. It is naturally perennial and has a thick fleshy root, but is grown in Great Britain as a tender annual. Its bright, generally scarlet flowers, arranged in long racemes, and the fact that it will flourish in any ordinary good garden soil, combine to make it a favourite garden plant. It is also of interest as being one of the few plants that twine in a direction contrary to the apparent motion of the sun. The seeds of the runner beans should be sown in an open plot,—the first sowing in May, another at the beginning of June, and a third about the middle of June. In the London market-gardens they are sown 8 to 12 in. apart, in 4 ft. rows if the soil is good. The twining tops are pinched or cut off when the plants are from 2 to 2½ ft. high, to save the expense of staking. It is better, however, in private gardens to have the rows standing separately, and to support the plants by stakes 6 or 7 ft. high and about a foot apart, the tops of the stakes being crossed about one-third down. If the weather is dry when the pods are forming abundantly, plenty of tepid water should be supplied to the plants. In training the shoots to their supports, they should be twined from right to left, contrary to the course of the sun, or they will not lay hold. By frequently picking the pods the plants are encouraged to form fresh blooms from which pods may be picked until the approach of frost.

The ordinary scarlet runner is most commonly grown, but there is a white-flowered variety which has also white seeds; this is very prolific and of excellent quality. Another variety called Painted Lady, with the flowers red and white, is very ornamental, but not so productive. Carter's Champion is a large-podded productive variety.

Another species *P. lunatus*, the Lima bean, a tall biennial with a scimitar-shaped pod (whence the specific name) 2 to 3 in. long containing a few large seeds, is widely cultivated in the warmer parts of the world.

The young pods of another leguminous climbing herb, *Dolichos Lablab*, as well as the seeds, are widely used in the tropics, as we use the kidney bean. The plant is probably a native of tropical Africa, but is now generally cultivated in the tropics. The word *Dolichos* is of Greek origin, and was used by Theophrastus for the scarlet runner.

Another species, *D. biflorus*, is the horse gram, the seed of which is eaten by the poorer class of natives in India, and is also, as are the pods, a food for horses and cattle.

The Soy bean, *Glycine hispida*, was included by Linnaeus in the genus *Dolichos*. It is extensively cultivated in China and Japan, chiefly for the pleasant-flavoured seed from which is prepared a piquant sauce. It is also widely grown in India, where the bean is eaten, while the plant forms a valuable fodder; it is cultivated for the latter purpose in the United States.

Other references to beans will be found under special headings, such as CALABAR BEAN, LOCUST-TREE. There are also several non-leguminous seeds to which the popular name bean is attached. Among these may be mentioned the sacred Egyptian or Pythagorean bean (*Nelumbium speciosum*), and the Ignatius bean (probably *Strychnos multiflora*), a source of strychnine.

The ancient Greeks and Romans made use of beans in gathering the votes of the people, and for the election of magistrates. A white bean signified absolution, and a black one condemnation. Beans had a mysterious use in the *lemuralia* and *parentalia*, where the master of the family, after washing his hands three times, threw black beans over his head nine times, reiterating the words "I redeem myself and my family by these beans."

BEAN-FEAST, primarily an annual dinner given by an employer to his workpeople, and then colloquially any jollification. The phrase is variously derived. The most probable theory is that which connects it with the custom in France, and afterwards in Germany and England, of a feast on Twelfth Night, at which a cake with a bean buried in it was a great feature. The banking was he who had the good fortune to have the slice of cake in which was the bean. This choosing of a king or queen by a bean was formerly a common Christmas diversion at the English and Scottish courts, and in both English universities. This monarch was master of the revels like his congener the lord of misrule. A clue to his original functions is possibly found in the old popular belief that the weather for the ensuing twelve months was determined by the weather of the twelve days from Christmas to Twelfth Night, the weather of each particular month being prognosticated from each day. Thus the king of the bean of Twelfth Night may have originally reigned for the twelve days, his chief duty being the performance of magical ceremonies for ensuring good weather during the ensuing twelve months. Probably in him and the lord of misrule it is correct to find the lineal descendant of the old king of the Saturnalia, the real man who personated Saturn and, when the revels ceased, suffered a real death in his assumed character. Another but most improbable derivation for bean-feast connects it with M.E. *bene* "prayer," "request," the allusion being to the soliciting of alms towards the cost of their Twelfth Night dinner by the workpeople.

See WATZGOOSE; MISRULE, LORD OF; also J. Boemus, *Mores, leges et ritus omnium gentium* (Lyons, 1541), p. 222; Laisnel de la Salle, *Croyances et légendes du centre de la France*, i. 19-29; Lecœur, *Esquisses du Bocage normand*, ii. 125; Schmitz, *Sitten und Sagen des Eifler Volkes*, i. 6; Brand, *Popular Antiquities of Great Britain* (Hazlitt's edn. 1905), under "Twelfth Night"; Cortet, *Fêtes religieuses*, p. 29 sqq.

BEAR, properly the name of the European brown bear (*Ursus arctus*), but extended to include all the members of the *Ursidae*, the typical family of Arctoid carnivora, distinguished by their massive bodies, short limbs, and almost rudimentary tails. With the single exception of the Indian sloth-bear, all the species have forty-two teeth, of which the incisors and canines closely resemble those of purely carnivorous mammals; while the molars, and especially the one known as the "sectorial" or "carnassial," have their surfaces tuberculated so as to adapt them for grinding vegetable substances. As might have been supposed from their dentition, the bears are omnivorous; but most prefer vegetable food, including honey, when a sufficient

supply of this can be had. The grizzly bear, however, is chiefly carnivorous; while the polar bear is almost wholly so.

Bears are five-toed, and provided with formidable claws, which are not retractile, and thus better fitted for digging and climbing than for tearing. Most climb trees in a slow, lumbering fashion, and, in descending, always come hind-quarters first. The grizzly bear is said to lose this power of climbing in the adult stage. In northern countries bears retire during the winter into caves and the hollows of trees, or allow the falling snow to cover them, and there remain dormant till the advent of spring, about which time the female usually produces her young. These are born naked and blind, and it is commonly five weeks before they see, or become covered with hair. Before hibernating the adults grow very fat, and it is by the gradual consumption of this fat—known in commerce as bear's grease—that such vital action as is necessary to the continuance of life is sustained.

The bear family is widely distributed, being found in every quarter of the globe except Australia, and in all climates, from the highest northern latitudes yet reached by man to the warm regions of India and Malaya. In the north-west corner of Africa the single representative of the family found on that continent occurs.

The polar or white bear (*Ursus maritimus*), common to the Arctic regions of both hemispheres, is distinguished from the other species by having the soles of the feet covered with close-set hairs,—in adaptation to the wants of the creature, the bear being thereby enabled to walk securely on slippery ice. In the whiteness of its fur also, it shows such an assimilation in colour to that of surrounding nature as must be of considerable service in concealing it from its prey. The food of the white bear consists chiefly of seals and fish, in pursuit of which it shows great power of swimming and diving, and a considerable degree of sagacity; but its food also includes the carcasses of whales, birds and their eggs, and grass and berries when these can be had. That it can sustain life on a purely vegetable diet is proved by instances on record of its being fed for years on bread only, in confinement. These bears are strong swimmers, Sir Edward Sabine having found one "swimming powerfully 40 m. from the nearest shore, and with no ice in sight to afford it rest." They are often carried on floating ice to great distances, and to more southern latitudes than their own, no fewer than twelve Polar bears having been known to reach Iceland in this way during one winter. The female always hibernates, but the male may be seen abroad at all seasons. In bulk the white bear exceeds most other members of the family, measuring nearly 9 ft. in length, and often weighing 1600 lb.

Land bears have the soles of the feet destitute of hair, and their fur more or less shaggy. On these the brown bear (*Ursus arctus*,—*ἄρκτος* of Aristotle) is found in one or other of its varieties all over the temperate and north temperate regions of the eastern hemisphere, from Spain to Japan. The fur is usually brownish, but there are black, blackish-grey and yellowish varieties. It is a solitary animal, frequenting the wooded parts of the regions it inhabits, and living on a mixed diet of fruits, vegetable, honey, fish and the smaller animals. In winter it hibernates, concealing itself in some hollow or cavern. It does not seek to attack man; but when baited, or in defence of its young, shows great courage and strength, rising on its hind legs and endeavouring to grasp its antagonist in an embrace. Bear-baiting, till within comparatively recent times, was a favourite sport throughout Europe, but, along with cock-fighting and badger-baiting, has gradually disappeared before a more humane civilization. It was a favourite pastime among the Romans, who imported their bears from Britain, a proof that the animal was then comparatively abundant in that country; indeed, from reference made to it in early Scottish history, the bear does not appear to have been extirpated in Britain before the end of the 11th century. It is now found in greatest abundance in Norway, Russia and Siberia, where hunting the bear is a favourite sport, and where, when dead, its remains are highly valued. Among the Kamchadales "the skin of the bear," says a traveller,

"forms their beds and their coverlets, bonnets for their heads, gloves for their hands and collars for their dogs. The flesh and fat are their dainties. Of the intestines they make masks or covers for their faces, to protect them from the glare of the sun in the spring, and use them as a substitute for glass, by extending them over their windows. Even the shoulder-blades are said to be put in requisition for cutting grass." In confinement the brown bear is readily tamed; and advantage has been taken of the facility with which it can sustain itself on the hind feet to teach it to dance to the sound of music. It measures 4 ft. in length, and is about 2½ ft. high. Of this species Crowthier's bear from the Atlas Mountains, the Syrian bear (*Ursus arctus pyriacus*) and the snow or isabelline bear (*Ursus arctus isabellinus*) of the Himalaya are local races, or at most subspecies.¹ American naturalists regard the big brown bears of Alaska as a distinct group. They range from Sitka to the extremity of the Alaskan Peninsula, over Kodiak Island, and inland. Their distinctive external features are their large size, light-brown colour, high shoulders, massive heads of great breadth and shaggy coat.

The grizzly bear (*Ursus arctus horribilis*, formerly known as *U. ferox*) is regarded by some naturalists as a distinct species and by others as a variety of the brown bear, to which it is closely allied. It was said to exceed all other American mammals in ferocity of disposition and muscular strength. Stories were told of its attacking the bison, and it has been reported to carry off the carcass of a wapiti, weighing nearly 1000 lb, for a considerable distance to its den, there to devour it at leisure. It also eats fruit and vegetables. Its fur is usually of a yellowish-brown colour, coarse and grizzled, and of little value commercially, while its flesh, unlike that of other bears, is uneatable even by the Indians. The grizzly bear is now rare in the United States, save in the Yellowstone Park and the Clearwater Mountains of Idaho, though more common in British Columbia. Several geographical races are recognized. The Tibet bear (*U. pruinosus*) is a light-coloured small species.

The American black bear (*Ursus americanus*) occurs throughout the wooded parts of the North American continent, whence it is being gradually driven to make room for man. It is similar in size to the brown bear, but its fur is of a soft even texture, and of a shining black colour, to which it owes its commercial value. At the beginning of the 19th century black bears were killed in enormous numbers for their furs, which at that time were highly valued. In 1803 the skins imported into England numbered 25,000, but the imports have since decreased to one-half of that number. They are chiefly used for military accoutrements. This is a timid animal, feeding almost solely on fruits, and lying dormant during winter, at which period it is most frequently killed. It is an object of superstitious reverence to the Indians, who never kill it without apologizing and deploring the necessity which impels them to do so.

The Himalayan black bear (*U. torquatus*) is found in the forest regions ranging from the Persian frontier eastward to Assam. The average length is about 5 ft.; there is no under-fur, and the coat is smooth, black in colour, with the exception of a white horseshoe-mark on the chest. It feeds chiefly on fruit and roots, but kills sheep, goats, deer, ponies and cattle, and sometimes devours carrion.

The small bruang or Malayan bear (*Ursus malayanus*) is of a jet-black colour, with a white semilunar mark on the chest, and attains a length of 4½ ft. Its food consists almost solely of vegetables and honey, but the latter is its favourite food,—the extreme length and pliability of the tongue enabling it to scoop out the honeycombs from the hollows of trees. It is found in the Malay Peninsula and Islands, and is readily tamed.

Not much larger than the Malay bear is the South American spectacled bear of the Andes (*U. ornatus*), distinguished from all the rest by the presence of a perforation in the lower end of the humerus, and hence sometimes separated as *Tremarctus*. It is black, with tawny rings round the eyes, and white cheeks, throat and chest. A second race or species exists.

The sloth-bear (*Melursus labiatus* or *ursinus*) is distinguished

¹ Lydekker, in *Proc. Zool. Soc.*, 1897, p. 412.

by the absence of one pair of upper incisors, the small size of the cheek-teeth and the very extensible character of the lips. It is also known as the aswail and the honey-bear, the last name being also given to the Malay bear and the kinkajou. It is about the size of the brown bear, is covered with long, black hair, and of extremely uncouth aspect. It inhabits the mountainous regions of India, is readily tamed and is the bear usually exhibited by the Hindu jugglers. The food consists of fruits, honey and white ants.

Fossil remains of extinct bears first occur in strata of the Pliocene age. Those of the great cave bear (*Ursus spelaeus*), found abundantly in certain caverns of central Europe and Asia, show that it must have exceeded in size the polar bear of the present day. Its remains are also found in similar situations in Britain associated with those of an allied species (*Ursus priscus*).

BEAR-BAITING and **BULL-BAITING**, sports formerly very popular in England but now suppressed on account of their cruelty. They took place in arenas built in the form of theatres which were the common resort even of cultivated people. In the bear-gardens, which are known to have existed since the time of Henry II., the bear was chained to a stake by one hind leg or by the neck and worried by dogs. Erasmus, writing (about 1500) from the house of Sir Thomas More, spoke of "many herds of bears maintained in the country for the purpose of baiting." Sunday was the favourite day for these sports. Hentzner, writing in 1598, describes the bear-garden at Bankside as "another place, built in the form of a theatre, which serves for the baiting of Bulls and Bears. They are fastened behind, and then worried by great English bull-dogs, but not without great risk to the dogs from the horns of the one and the teeth of the other, and it sometimes happens they are killed upon the spot; fresh ones are immediately supplied in the places of those that are wounded or tired." He also describes the whipping of a blinded bear, a favourite variation of bear-baiting. For a famous baiting which took place before Queen Elizabeth in 1575 thirteen bears were provided. Of it Robert Laneham (fl. 1575) wrote, "it was a sport very pleasant to see, to see the bear, with his pink eyes, tearing after his enemies' approach; the nimbleness and wait of the dog to take his advantage and the force and experience of the bear again to avoid his assaults: if he were bitten in one place how he would pinch in another to get free; that if he were taken once, then by what shift with biting, with clawing, with roaring, with tossing and tumbling he would work and wind himself from them; and when he was loose to shake his ears twice or thrice with the blood and the slaver hanging about his physiognomy." The famous "Paris Garden" in Southwark was the chief bear-garden in London. A Spanish nobleman of the time, who was taken to see a pony baited that had an ape tied to its back, expressed himself to the effect that "to see the animal kicking amongst the dogs, with the screaming of the ape, beholding the curs hanging from the ears and neck of the pony, is very laughable." Butler describes a bear-baiting at length in the first canto of his *Hudibras*.

The Puritans endeavoured to put an end to animal-baiting, although Maçaulay sarcastically suggested that this was "not because it gave pain to the bear, but because it gave pleasure to the spectators." The efforts of the Puritans seem, however, to have had little effect, for we find the sport flourishing at the Restoration; but the conscience of cultivated people seems to have been touched, for Evelyn wrote in his *Diary*, under the date of June 16th, 1670: "I went with some friends to the bear-garden, where was cock-fighting, dog-fighting, bear and bull baiting, it being a famous day for all these butcherly sports, or rather barbarous cruelties. The bulls did exceedingly well, but the Irish wolf-dog exceeded, which was a tall greyhound, a stately creature indeed, who beat a cruel mastiff. One of the bulls tossed a dog full into a lady's lap, as she sat in one of the boxes at a considerable height from the arena. Two poor dogs were killed, and so all ended with the ape on horseback, and I most heartily weary of the rude and dirty pastime, which I had not seen, I think, in twenty years before." Steele also attacked these cruel sports in the *Tatler*. Nevertheless, when the tsar

Nicholas I. visited England as cesarevich, he was taken to see a prize-fight and a bull-baiting. In this latter form of the sport the bull's nose was usually blown full of pepper to render him the more furious. The bull was often allowed a hole in the ground, into which to thrust his nose and lips, his most vulnerable parts. Sometimes the bull was tethered, and dogs, trained for the purpose, set upon him one by one, a successful attack resulting in the dog fastening his teeth firmly in the bull's snout. This was called "pinning the bull." A sport called bull-running was popular in several towns of England, particularly at Tutbury and Stamford. Its establishment at Tutbury was due to John of Gaunt, to whose minstrels, on the occasion of their annual festival on August 16th the prior of Tutbury, for his tenure, delivered a bull, which had his horns sawn off, his ears and tail cut off, his nostrils filled with pepper and his whole body smeared with soap. The minstrels gave chase to the bull, which became the property of any minstrel of the county of Stafford who succeeded in holding him long enough to cut off a lock of his hair. Otherwise he was returned to the prior. At the dissolution of the monasteries this tenure devolved upon the dukes of Devonshire, who suppressed it in 1788. At Stamford the running took place annually on November 13th, the bull being provided by the butchers of the town, the townspeople taking part in the chase, which was carried on until both people and beast were exhausted, and ended in the killing of the bull. Certain rules were strictly observed, such as the prohibition of carrying sticks or staves that were shod with iron. The Stamford bull-running survived well into the 19th century. Bear-baiting and bull-baiting were prohibited by act of parliament in 1835.

BEARD, WILLIAM HOLBROOK (1825-1900), American painter, was born on the 13th of April 1825 at Painesville, Ohio. He studied abroad, and in 1861 removed to New York City, where in 1862 he became a member of the National Academy of Design. He was a prolific worker and a man of much inventiveness and originality, though of modest artistic endowment. His humorous treatment of cats, dogs, horses and monkeys, generally with some human occupation and expression, usually satirical, gave him a great vogue at one time, and his pictures were largely reproduced. His brother, James Henry Beard (1814-1893), was also a painter.

BEARD (A.S. *beard*, O. H. and Mod. Ger. *Bart*, Dan. *baard*, Icel. *bar*, rim, edge, beak of a ship, &c., O. Slav. *barða*, Russ. *barodá*. Cf. Welsh *barf*, Lat. *barba*, though, according to the *New English Dictionary*, the connexion is for phonetic reasons doubtful). Modern usage applies this word to the hair grown upon a man's chin and cheek. When the chin is shaven, what remains upon the cheeks is called whiskers. "Moustache" or "moustaches" describes the hair upon the upper lip. But the words have in the past had less exact meaning. Beard has stood alone for all these things, and whisker has in its time signified what we now call moustache, as in the case of Robinson Crusoe's great pair of "Turkish whiskers."

The bearded races of mankind have ever held the beard in high honour. It is the sign of full manhood; the lad or the eunuch is beardless, and the bearded woman is reckoned a witch, a loathsome thing to all ages. Also the beard shrinks from the profane hand; a tug at the beard is sudden pain and dishonour. The Roman senator sat like a carving thing until the wondering Goth touched his long beard; but then he struck, although he died for the blow. The future King John gave deadly offence to the native chieftains, when visiting Ireland in 1185, by plucking at their flowing beards.

David's ambassadors had their beards despitely shaven by a bold heathen. Their own king mercifully covered their shame—"Tarry ye at Jericho until your beards be grown"—but war answered the insult. The oath on the beard is as old as history, and we have an echo of it in the first English political ballad when Sir Simon de Montfort swears "by his chin" revenge on Warren.

Adam, our first father, was by tradition created with a beard; Zeus Allfather is bearded, and the old painters and carvers who hardly pictured the first person of the Trinity gave Him the

long beard of his fatherhood. The race-fathers have it and the ancient heroes. Abraham and Agamemnon, Woden and King Arthur and Charlemagne, must all be bearded in our pictures. With the Mahomedan peoples the beard as worn by an unshaven prophet has ever been in high renown, the more so that amongst most of the conquering tribes who first acknowledged the unity of God and prophethood of Mahomet it grew freely. But before Mahomet's day, kings of Persia had plaited their sacred beards with golden thread, and the lords of Nineveh had curiously curled and oiled beards such as their winged bull wears. Bohadin tells us that Saladin's little son wept for terror when he saw the crusaders' envoys "with their clean-shaven chins." Selim I. (1512-1521) comes down as a Turkish sultan who broke into holy custom and cut off his beard, telling a remonstrating Mufti that his vizier should now have nothing to lead him by. But such tampering with tradition has its dangers, and the absolute rule of Petr the Great is made clear when we know that he taxed Russian beards and shaved his own, and yet died in his bed. Alexander the Great did as much and more with his well-drilled Macedonians, and was obeyed when he bade them shave off the handle by which an enemy could seize them.

With other traditions of their feudal age, the Japanese nation has broken with its ancient custom of the razor, and their emperor has beard and moustache; a short moustache is common amongst Japanese officers and statesmen, and generals and admirals of Nippon follow the imperial example. The Nearer East also is abandoning the full beard, even in Mahomedan lands. Earlier shahs of the Kajar house have glorious beards below their girdles, but Nâşîrû'd-Dîn and his successor have shaved their chins. In later years the sultan of Turkey has added a beard to his moustache; the khedive of Egypt, son of a bearded father, has a soldier's moustache only. In Europe the great Russian people is faithful to the beard, Peter's law being forgotten. The tsar Alexander III.'s beard might have satisfied Ivan the Terrible, whose hands played delightedly with the five-foot beard of Queen Elizabeth's agent George Killingworth. Indeed the royal houses of Europe are for the most part bearded or whiskered. It may be that the race of Olivier le Dain, of the man who can be trusted with a sharp razor near a crowned king's throat, is extinct. Leopold II., king of the Belgians, however, was in 1909 the only sovereign with the full beard unclipped. The Austrian emperor, Francis Joseph, retained the moustache and whiskers of the 'sixties, and the German emperor, William II., for a short period, commemorated by a few very rare photographs, had a beard, although it was never suffered to reach the length of that beard which gave his father an air of Charlemagne or Barbarossa. In France bearded presidents have followed each other, but it may be noted that the waxed moustache and "imperial" beard of the Second Empire is now all but abandoned to the Frenchman of English comedy. The modern English fashion of shaving clean is rare in France save among actors, and during 1907 many Parisian waiters struck against the rule which forbade them to grow the moustache.

For the most part the clergy of the Roman obedience have clean; as have done the popes for two centuries and more. But missionary bishops cultivate the long beard with some pride, and the orders have varying customs, the Dominican shaving and the Franciscan allowing the hair to grow. The Roman Catholic clergy of Dalmatia, secular and regular, are allowed to wear the moustache without beard or whiskers, as a concession to national prejudices.

Amongst English people, always ready to be swayed by fashion, the hair of the face has been, age by age, cherished or shaved away, curled or clipped into a hundred devices. Before the immigration from Sleswick the Briton knew the use of the razor, sometimes shaving his chin, but leaving the moustaches long. The old English also wore moustaches and forked beards, but, save for aged men, the beard had passed out of fashion before the Norman Conquest. Thus, in the Bayeux needlework, Edward the king is venerable with a long beard, but Harold and his younger fighting men have their chins reaped. "The English,"

says William of Malmesbury, "leave the upper lip unshaven, suffering the hair continually to increase," and to Harold's spies the Conqueror's knights, who had "the whole face with both lips shaven," were strange and priest-like. Matthew Paris had a strange idea that the beard was distinctive of Englishmen; he asserts that those who remained in England were compelled to shave their beards, while the native nobles who went into exile kept their beards and flowing locks "like the Easterns and especially the Trojans." He even believed that "William with the beard," who headed a rising in London under Richard I., came of a stock which had scorned to shave, out of hatred for the Normans, a statement which Thierry deprede.

The *Chanson de Roland* shows us "the pride of France" as "that good bearded folk," with their beards hanging over coats of mail, and it makes the great emperor swear to Naimes by his beard. It was only about the year 1000, according to Rodolf Glaber, that men began in the north of France to wear short hair and shave "like actor"; and even in the Bayeux tapestry the old Norman shipwrights wear the beard. But so rare was hair on the face amongst the Norman invaders that William, the forefather of the Percys, was known in his lifetime and remembered after his death as William "Asergnus" or "Oht les gernus," i.e. "William with the moustaches," the epithet revived by one of his descendants making our modern name of Algeron. Count Eustace of Boulogne was similarly distinguished. Fashion swung about after the Conquest, and, in the day of Henry I., Serle the bishop could compare bearded men of the Norman-English court with "filthy goats and bristly Saracens." The crusades, perhaps, were accountable for the beards which were oddly denounced as effeminate in the young courtiers of William Rufus. Not only the Greeks but the Latins in the East sometimes adopted the Saracen fashion, and the siege of Antioch (1098) was as unfavourable to the use of the razor as that of Sevastopol. When the Latins stormed the town by night, bearded knights owed their death to the assumption that every Christian would be a shaven man. But for more than four centuries diversity is allowed, beards, moustaches and shaven faces being found side by side, although now and again one fashion or another comes uppermost to be followed by those nice in such matters. Henry II. is a close-shaven king, and Richard II.'s effigy shows but a little tuft on each side of the chin, tufts which are two curled locks on the chin of Henry IV. But Henry III. is long-bearded, Edward II. curls his beard in three great ringlets, and the third Edward's long forked beard flows down his breast in patriarchal style. The mid-13th century, as seen in the drawings attributed to Matthew Paris, is an age of many full and curled beards, although the region about the lips is sometimes clipped or shaved. The beard is common in the 14th century, the forked pattern being favoured and the long drooping moustache. Amongst those who ride with him to Canterbury, Chaucer, a bearded poet, notes the merchant's "forked beard," the white beard of the franklin and the red beard of the miller, but the Reeve's beard is "shave as ny as ever he can." Henry of Monmouth and his son are shaven, and thereafter beards are rare save with a few old folk until they come slowly back with the 16th century. In Ireland the statute enacted by a parliament at Trim in 1447 recited that no man of man who will be taken for an Englishman should have beard above his mouth—the upper lip must be shaven at least every fortnight or be of equal growth with the nether lip,—and this statute remained unrepealed for nigh upon two hundred years. Henry VIII., always a law to himself, brought back the beard to favour, Stowe's annals giving 1535 as the year in which he caused his beard "to be knotted and no more shaven," his hair being polled at the same time. Many portraits give his fashion of wearing a thin moustache, whose ends met a short and squarely trimmed beard parted at the chin, a fashion in which he was followed by his brother-in-law Charles Brandon. But it is remarkable that those about him rarely imitated their most dread sovereign. While Cromwell and Howard the Admiral go clean shaven, the Seymour brothers, Denny and Russell, have the beard long and flowing. Even the forty shilling a year man, says Hooper in 1548, will waste his morning time while he sets his

beard in order. About this time the clergy began to break with the long tradition of smooth faces. A priest in 1531 is commanded to abstain from wearing a beard, and Cardinal Pole, coming from the court of a bearded pope, appears bearded like a Greek patriarch. The law too, the church's kinswoman, begins to forbid, a sign of the change, and from 1542 the society of Lincoln's Inn makes rules for fining and expelling those who appear bearded at their mess, rules which the example of exalted lawyers caused to be withdrawn in 1560.

The age of Elizabeth saw lawyers, soldiers, courtiers and merchants all bearded. Her Cecils, Greshams, Raleighs, Drakes, Dudleys and Walsingham have the beard. A shaven chin such as that seen in the portrait of Philip Howard, earl of Arundel, is rare, but the beards take a hundred fashions, and satirists and Puritan pamphleteers were busy with them and with the men who wasted hours in perfuming or starching them, in dusting them with orris powder, in curling them with irons and quills. Stubbs gives them a place amongst his abuses. "It is a world to consider how their mowchatoes must be preserved or laid out from one cheek to another and turned up like two horns towards the forehead." Of the English variety of beards Harrison has a good word: "beards of which some are shaven from the chin like those of Turks, not a few cut short like to the beard of Marquess Otto, some made round like a rubbing brush, others with a *pique de vant* (O! fine fashion) or now and then suffered to grow long, the barbers being grown to be so cunning in this behalf as the tailors. And therefore if a man have a lean and straight face, a Marquess Otto's cut will make it broad and large; if it be platter-like, a long slender beard will make it seem the narrower; if he be weasel-beaked, then much hair left on the cheeks will make the owner look big like a bowlded hen, and as grim as a goose, if Cornelis of Chelmersford say true." Nevertheless he adds that "many old men do wear no beards at all." The Elizabethan fashions continued under King James, the beard trimmed to a point being common wear; but under King Charles there is a certain reaction, and the royal style of shaving the cheeks and leaving the moustache whose points sweep upward and the chin beard like a downward flame is followed by most of the gentry. With some the beard disappears altogether or remains a mere fleck below the lip. Archbishop Laud has a cavalier-like chin tuft and upturned moustache, but Abbot his predecessor wore the spade beard, the "cathedral beard" of Randle Holme, seen in all its dignity on the Chigwell brass of Samuel Harnsett, archbishop of York (died 1631), a grim figure with his angry moustache and a long and broad beard, cut square at the bottom.

From the Restoration year the razor comes more into use. Young men shave clean. The restored king curls a few dark hairs of a moustache over each cheek, but his brother James is shaven. With the reign of Queen Anne the country enters the beardless age, and beards, moustaches and whiskers are no more seen. In the 18th century the moustache indicated a soldier from beyond sea. A Jew or a Turk was known by the beard, an appendage loathsome as comic. Matthew Robinson, the second Lord Rokeby, was indeed wearing a beard in 1798, but he was reckoned a madman therefor, and Phillips's *Public Character* pictures him as "the only peer and perhaps the only gentleman of either Great Britain or Ireland who is thus distinguished." That George III. in his madness should have been left unshaved was a circumstance of his misery that wrung the hearts of all loyal folk. But in the very year of 1798, when Lord Rokeby's image was engraved for the curious, the Worcestershire militia officers quartered near Brighton were copying the Austrian moustache of the foreign troops, and we may note that the hair of the face, which disappeared when wigs came in, began to reappear as wigs went out. Early in the 19th century the bucks began to show a patch of whisker beside the ear, and the soldier's moustache became a common sight. Before Waterloo, guardsmen were complaining that officers of humbler regiments imitated their fashion of the moustache, and by the Waterloo year most young cavalry officers were moustached. The Horse Artillery were the next moustached corps, the rest of the army, already whiskered,

following their example in the 'fifties. But for a civilian to grow a moustache was long reckoned a piece of unseemly swagger. Clive Newcome, it will be remembered, wore one until the taunting question whether he was "going in the Guards" shamed him into shaving clean. When in 1840 Mr George Frederick Muntz appeared in parliament with a full beard there were those who felt that this tall Radical had taken his own strange method of insulting English parliamentary institutions. James Ward, R.A. (d. 1859), painter of animals, was another braker of the unwritten law, defending his beard in a pamphlet of eighteen arguments as a thing pleasing at once to the artist and to his Creator. Freedom in these matters only came when the troops were home from the Crimea, when officers who had grown beards and acquired the taste for tobacco during the long months in the trenches showed their beards and their cigars in Piccadilly. Then came the Volunteer movement, and every man was a soldier, taking a soldier's licence. The dominant fashion was the moustache, worn with long and drooping whiskers. But the "Piccadilly weepers" of the 'sixties were out of the mode for the younger men when the 'eighties began, and by the end of the century whiskers were seen in the army only upon a few veteran officers. The fashion of clean shaving had made some way, the popularity of the shaven actor having a part in this. In 1909 all modes of dealing with the hair of the face might be recognized, but the full beard had become somewhat rare in England and the full whiskers rarer still. The upper class showed an inclination to shave clean, although the army grudgingly recognized a rule which ordered the moustache to be worn. Naval men, by regulation, shaved or wore both beard and moustache, but their beards were always trimmed. Most barristers shaved the lips, although the last judge unable to hear an advocate whose voice a moustache interrupted had left the bench. Clergymen followed the lay fashions as they did under the first Stuart kings, although there was still some prejudice against the moustache as an ornament military and inappropriate. A newspaper of 1857, describing the appearance of Livingstone the missionary at a Mansion House meeting, records that he came wearing a moustache, "braving the prejudices of his countrymen and thus evincing a courage only inferior to that exhibited by him amongst the savages of Central Africa." Even as late as 1884 the *Pall Mall Gazette* has some surprised comments on the beard of Bishop Ryle, newly consecrated to the see of Liverpool.

The footman, whose full-dress livery is the court dress of a hundred years ago, must show no more than the rudimentary whisker of the early eighteen-hundreds, and butler, coachman and groom come under the same rule. The jockey and the hunt whip are shaven likewise, but the courier has the whiskers and moustache that once marked him as a foreigner in the English milor's service, and the chauffeur, a servant with no tradition behind him, is often moustached.

Lastly, we may speak of the practice of the royal house since England came out of the beardless century. The regent took the new fashion, and sat "in whiskered state," but his brother and successor shaved clean and disliked even the husbar's moustache. The prince consort wore the moustache as a young man, adding whiskers in later years. King Edward VII. wore moustache and trimmed beard, and his heir apparent also followed the fashion of many fellow admirals. (O. BA.)

BEARDSLEY, AUBREY VINCENT (1872-1898), English artist in black and white, was born at Brighton on the 24th of August 1872. In 1883 his family settled in London, and in the following year he appeared in public as an "infant musical phenomenon," playing at several concerts with his sister. In 1888 he obtained a post in an architect's office, and afterwards one in the Guardian Life and Fire Insurance Company (1889). In 1891, under the advice of Sir Edward Burne-Jones and Puvis de Chavannes, he took up art as a profession. In 1892 he attended the classes at the Westminster School of Art, then under Professor Brown; and from 1893 until his death, at Mentone, on the 16th of March 1898, his work came continually before the public, arousing a storm of criticism and much hostile feeling. Beardsley had an unswerving tendency towards the fantastic of

the gloomier and "unwholesome" sort. His treatment of most subjects was revolutionary; he deliberately ignored proportion and perspective, and the "freedom from convention" which he displayed caused his work to be judged with harshness. In certain phases of technique he especially excelled; and his earlier methods of dealing with the single line in conjunction with masses of black are in their way unsurpassed, except in the art of Japan, the country which probably gave his ideas some assistance. He was always an ornamentist, rather than an illustrator; and his work must be judged from that point of view. His frontispiece to *Volpone* is held by some to be, from this purely technical standpoint, one of the best pen-drawings of the age. His posters for the Avenue theatre and for Mr Fisher Unwin were among the first of the modern cult of that art.

The following are the chief works which are illustrated with drawings by Beardsley: the *Bon Mot Library*, *The Pall Mall Budget*, and *The Studio* (1893); Sir Thomas Malor's *Morte d'Arthur* (1893-1894); *Salomé* (1894); *The Yellow Book* (1894-1895); *The Savoy Magazine* (1896); *The Rape of the Lock* (1896).

See also J. Pennell, *The Studio* (1893); Symons, *Aubrey Beardsley* (1898); R. Ross, *Volpone* (1898); H. C. Marillier, *The Early Work of Aubrey Beardsley* (1899); Smithers, *Reproductions of Drawings by Aubrey Beardsley*; John Lane, *The Later Works of Aubrey Beardsley* (1901); R. Ross, *Aubrey Beardsley* (1908). (E. F. S.)

BEARDSTOWN, a city of Cass county, Illinois, U.S.A., in the W. part of the state, on the E. bank of the Illinois river, about 111 m. N. of St. Louis, Missouri. It is served by the Baltimore & Ohio South-Western, and the Burlington (Chicago, Burlington & Quincy) railways, and by steamboats plying between it and St. Louis. Pop. (1890) 4226; (1900) 4827 (444 foreign-born); (1910) 6107. The industrial establishments of the city include flour, planing and saw mills, the machine shops (of the St. Louis division) of the Chicago, Burlington & Quincy railway, ice factories, pearl button factories and a shoe factory. The fishing interests are also important. Beardstown was laid out in 1827 and was incorporated as a city in 1806. It was named in honour of Thomas Beard, who settled in the vicinity in 1820. During the Black Hawk War (1832) it was a base of supplies for the Illinois troops. The old court house in which Abraham Lincoln, in 1854, won his famous "Armstrong murder case," is now used for a city hall.

BEARER, strictly "one who carries," a term used in India for a palanquin-bearer, and now especially for a body-servant. The term is also used in connexion with military ambulances, and "bearer" companies formed part of the Royal Army Medical Corps until amalgamated with the field-hospitals to form field-ambulances (1905). In banking and commerce the word is applied to the holder or presenter of a cheque or draft not made payable to a specific person; it has also a technical use, as in printing, of anything that supports pressure in machinery, &c.

BEARINGS. In engineering a "bearing" is that particular kind of support which, besides carrying the load imposed upon it by the shaft associated with it, allows the shaft freedom to revolve. Or, put in another way, a bearing forms with the shaft a pair of elements having one degree of freedom to turn relatively to one another about their common axis. The part of the shaft in the bearing is commonly called the *journal*. The component parts of a small bearing, pillow block, plummer block or pedestal, as it is variously styled, are illustrated in fig. 1, and these parts, put together, are further illustrated in fig. 2 with the shaft added. Corresponding parts are similarly lettered in the two illustrations. The shaft (S) is encircled by the *brasses* (B_1 and B_2) made of gun metal, phosphor bronze or other suitable material. The lower brass fits into the main casting (A) in the semicircular seat provided for it, and is prevented from moving endways by the flanges (F, F) and from turning with the shaft by the projections (P, P), which fit into corresponding recesses in the casting (A), one of which is shown at β . After the shaft has been placed in position, the upper brass (B_2) and the cap (C) are put on and both are held in place by the bolts (Q_1, Q_2). The brasses are bedded into the main casting (A) and the cap (C) respectively at the surfaces D, D, D. The complete bearing is held to the framework of the machine by bolts (R_1, R_2) passing

through holes (H, H) which are slotted to allow endwise adjustment of the whole bearing in order to facilitate the alignment of the shaft. Oil or other lubricant is introduced through the hole (G), and it passes through the top brass to grooves or oilways cut into the surface of the brass for the purpose of distributing the oil uniformly to the journal.

Some form of lubricator is usually fitted at G in order to supply oil to the bearing continuously. A form of lubricator used for this purpose is shown in place, fig. 2, and an enlarged section is shown in fig. 3. It will be seen that the lubricator consists essentially of a cup the base of which is pierced centrally by a tube which reaches to within a small distance of the lid of the cup inside, and projects into the oilway leading to the journal outside. The annular space round the tube inside is filled with oil which is transferred to the central tube and thence to the bearing by the capillary action of a cotton wick thrust down on a piece of wire. It is only necessary to withdraw the wick from the central tube to stop the supply of oil. The lubricator is fitted through a hole in the lid which is usually plugged with a piece of cane or closed by more elaborate means. A line of shafting would be supported by several bearings of the

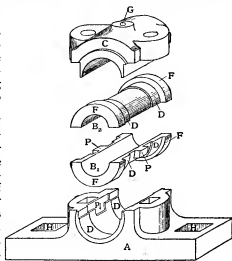

FIG. 1.

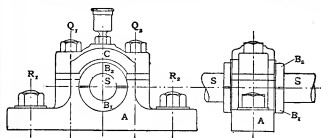

FIG. 2.

kind illustrated, themselves supported by brackets projecting from or rigidly fixed to the walls of the workshop, or on frames resting on the floor, or on hangers attached to the roof girders or principals.

In bearings of modern design for supporting a line shaft the general arrangement shown in fig. 1 is modified so that the alignments of the shaft can be made both vertically or horizontally by means of adjusting screws, and the brass is jointed with the supporting main body so that it is free to follow the small deflections of the shaft which take place when the shaft is working. Another modern improvement is the formation of an oil reservoir or well in the base of the bearing itself, and the transference of the oil from this well to the shaft by means of one or two rings riding loosely on the shaft. The bottom part of the ring dips into the oil contained in the well of the bearing and, as the shaft rotates, the ring rolls on the shaft and thus carries oil up to the shaft continuously, from which it finds its way to the surfaces of the shaft and bearing in contact. It should be understood that the upper brass is slotted crossways to allow the ring to rest on the shaft. When the direction of the load carried by the bearing is constant it is unnecessary to provide



FIG. 3.

more than one brass, and the construction is modified accordingly. Figs. 4 and 5 show an axle box used for goods wagons on the Great Eastern railway, and they also illustrate the method of

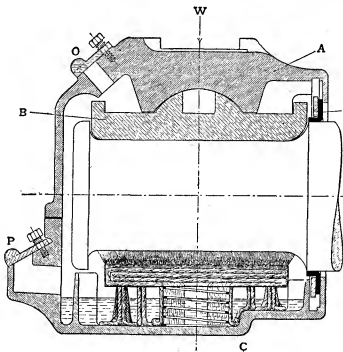

FIG. 4.

pad lubrication in general use for this kind of bearing. The main casting, A, is now uppermost, and is designed so that the upper part supports and constrains the spring buckle through which the load W is transmitted to the bearing, and the lower part inside is arranged to support the brass, B. The brass is joined freely with the main casting by means of a hemispherical hump resting in a corresponding recess in the casting. What may be called the cap, C, forms the lower part of the axle box,

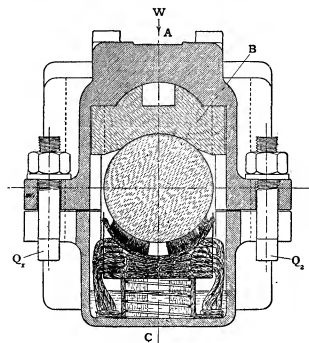

FIG. 5.

but instead of supporting a second brass it is formed into an oil reservoir in which is arranged a pad of cotton wick woven on a tin frame. The upper part of the pad is formed into a kind of

brush, shaped to fit the underside of the journal, whilst the lower part consists of streamers of wick resting in the oil. The oil is fed to the brush by the capillary action of the streamers. The reservoirs are filled with oil through the apertures P and O. The bottom cap is held in position by the T-headed bolts Q₁ and Q₂ (fig. 5). By slackening the nuts and turning the T-heads fair with the slots in the cap, the cap comes right away and the axle may be examined. A leather ring L is fitted as shown to prevent dust from entering the axle box.

Footsteps.—A bearing arranged to support the lower end of a vertical shaft is called a footstep, sometimes a pivot bearing. A simple form of footstep is shown in fig. 6. A casting A, designed so that it can be conveniently bolted to a foundation block, cross beam, or bracket is bored out and fitted with a brass B, which is turned inside to carry the end of the shaft S. The whole vertical load on the shaft is carried by the footstep, so that it is important to arrange efficient lubricating apparatus. Results of experiments made on a footstep, reported in *Proc. Inst. Mech. Eng.*, 1891, show that if a diametral groove be cut in the brass, as indicated at g (fig. 6), and if the oil is led to the centre of this groove by a channel c communicating with the exterior, the rotation of the shaft draws in a plentiful supply of oil which radiates from the centre and makes its way vertically between the shaft and the brass and finally overflows at the top of the brass. The overflowing oil may be led away and may be re-introduced into the footsteps at c. The rotation of the shaft thus causes a continuous circulation of oil through the footstep. One experiment from the report mentioned above may be quoted. A 3-in. shaft, revolving 128 times per minute and supported on a manganese bronze bearing lubricated in the way explained above sustained increasing loads until, at a load of 300 pounds per square inch of the area of the end of the shaft, it seized. The mechanical details of a footstep may be varied for purposes of adjustment in a variety of ways similarly to the variations of a common bearing already explained.

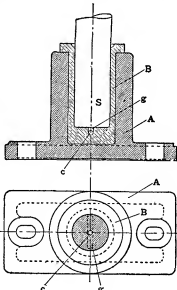

FIG. 6.

Thrust Block Bearing.—In cases where a bearing is required to resist a longitudinal movement of the shaft through it, as for example in the case of the propeller shaft of a marine engine or a vertical shaft supporting a heavy load not carried on a footstep, the shaft is provided with one or more collars which are grooved with corresponding recesses in the brasses of the bearing. A general sketch of a thrust block for a propeller shaft is shown in fig. 7. There are seven collars turned on the shaft and into the

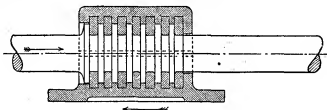

FIG. 7.

circumferential grooves between them fit corresponding circumferential projections on the brasses, these projections being formed in the case illustrated by means of half rings which are

fitted into grooves turned in the brasses. This method of construction allows an individual ring to be replaced or adjusted if it should get hot. The total area of the rubbing surfaces should be proportioned so that the average load is not more than from 50 to 70 lb per sq. in. Arrangements are usually made for cooling a thrust block with water in case of heating. The spindles of drilling machines, boring machine spindles, turbine shafts may be cited as examples of vertical shafts supported on one collar. Experiments on the friction of a collar bearing have been made by the Research Committee of the Institution of Mechanical Engineers (*Proc. Inst. Mech. Eng.*, 1888).

Roller and Ball Bearings.—If rollers are placed between two surfaces having relative tangential motion the frictional resistance to be overcome is the small resistance to rolling. The rollers move along with a velocity equal to one half the relative velocity of the surfaces. This way of reducing frictional resistance has been applied to all kinds of mechanical contrivances, including bearings for shafts, railway axle boxes, and axle boxes for trams. An example of a roller bearing for a line shaft is illustrated in figs. 8 and 9. The main casting, A, and cap, C, bolted together, form a spherical seating for the part of the bearing E corresponding to the brasses in a bearing of the usual type. Between the inside of the casting E and the journal are placed rollers held in position relatively to one another by a "squirrel cage" casting, the section of the bars of which are clearly shown in the half sectional elevation, fig. 9. This squirrel cage ensures that the several axes of the rollers keep parallel to the axis of the journal during the rolling motion. The rollers are made of hard tool steel, and the

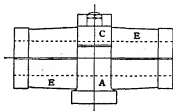

FIG. 8.

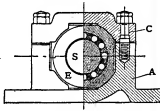

FIG. 9.

surfaces of the journal and bearing between which they roll are hardened.

Two rings of balls may be used instead of a single ring of rollers, and the kind of ball bearing thus obtained is in general use principally in connexion with bicycles and motor cars (see *BICYCLE*). In ball bearings the load is concentrated at a few points, the points where the balls touch the race, and in the roller bearing at a few lines, the lines of contact between the rollers and the surfaces of the journal and bearing; consequently the load which bearings of this kind carry must not be great enough to cause any indentation at the points or lines of contact. Both rollers and balls, and the paths on which they roll, therefore, are made of hard material; further, balls and rollers must all be exactly the same size in an individual bearing in order to distribute the load between the points or lines of contact as uniformly as possible. The finest workmanship is required therefore to make good roller or good ball bearings.

Bearings for High Speeds and Forced Lubrication.—When the shaft turns the metallic surfaces of the brass and the journal are prevented from actual contact by a film of oil which is formed and maintained by the motion of the shaft and which sustains the pressure between the journal and the brass provided the surfaces are accurately formed and the supply of oil is unlimited. This film changes what would otherwise be the friction between metallic surfaces into a viscous resistance within the film itself. When through a limited supply of oil or imperfect lubrication this film is imperfect or fails altogether and allows the journal to make metallic contact with the brass, the friction increases; and it may increase so much that the bearing rapidly becomes hot and may ultimately seize, that is to say the rubbing surfaces may become stuck together. With the object of reducing the friction at the points of metallic contact and of confining the damage of a hot bearing to the easily renewable brass, the latter is partially,

sometimes wholly, lined with a soft fusible metal, technically known as white metal, which melts away before actual seizure takes place, and thus saves the journal which is more expensive because it is generally formed on a large and expensive shaft. However perfectly the film fulfils its function, the work required to overcome the viscous resistance of the film during the continuous rotation of the shaft appears as heat, and in consequence the temperature of the bearing gradually rises until the rate at which heat is produced is equal to the rate at which it is radiated from the bearing. Hence in order that a journal may revolve with a minimum resistance and without undue heating two precautions must be taken: (1) means must be taken to ensure that the film of oil is complete and never fails; and (2) arrangements must be made for controlling the temperature should it rise too high. The various lubricating devices already explained supply sufficient oil to form a partial film, since experiments have shown that the friction of bearings lubricated in this way is akin to solid friction, thus indicating at least partial metallic contact. In order to supply enough oil to form and maintain a film with certainty the journal should be run in an oil bath, or oil should be supplied to the bearing under pressure sufficient to force it in between the surfaces against the load. A bearing to which forced lubrication and water cooling are applied is illustrated in fig. 10, which represents one of the bearings of a Westinghouse turbo-alternator installed at the power station of the Underground Electric Railways Company of London at Lots Road, Chelsea. Oil flows under pressure from a tank on the top of a tower along a supply pipe to the oil inlet O, and after passing through the bearing and performing its duty as a film it falls away from each end of the journal into the bottom of the main casting, from which a pipe, E, conveys the oil back to the base of the tank tower where it is cooled and finally pumped back into the tank. There is thus a continuous circulation of oil through the bearing. The space C is for cooling water; in fact the bearing is water jacketed and the jacket is connected to a supply pipe and a drain pipe so that a continuous circulation may be maintained if desired. This bearing is 12 in. in diameter and 48 in. long, and it carries a load of about 12.8 tons. The rise in temperature of the bearing under normal conditions of working without water circulating in the jacket is approximately 38° F. The speed of rotation is such that the surface velocity is about 50 ft. per second.

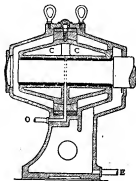

FIG. 10.

Forced lubrication in connexion with the bearings of high-speed engines was introduced in 1890 by Messrs Belliss & Morcom, Ltd., under patents taken out in the name of A. C. Pain. It should be understood that providing the film of oil in the bearing of an engine can be properly maintained a double-acting engine can be driven at a high speed without any knocking, and without perceptible wear of the rubbing surfaces. Fig. 11 shows that the general arrangement of the bearings of a Belliss & Morcom engine arranged for forced lubrication. A small force-pump F, driven from the eccentric strap X, delivers oil into the pipe P, along which it passes to A, the centre of the right-hand main bearing. There is a groove turned on the inside of the brass from which a slanting hole leads to B. The oil when it arrives at A thus has two paths open to it, one to the right and left of the groove through the bearing, the other along the slanting hole to B. At B it divides again into two streams, one stream going upwards to the eccentric sheave, and a part continuing up the pipe Q to the eccentric pin. The second stream from B follows the slanting hole in the crank shaft to C, where it is led to the big end journal through the pipe R to the crosshead pin, and through the slanting hole to D, where it finds its way into the left main bearing. The oil forced through each bearing falls away to the right and to the left of the journal and drops into

the bottom of the engine framing, whence it is again fed to the pump through a strainer. The parts of an engine lubricated in this way must be entirely enclosed.

Load on bearings.—The distribution of pressure over the

film of lubricant separating the rubbing surfaces of a bearing is variable, being greatest at a point near but not at the crown of the brass, and falling away to zero in all directions towards the boundaries of the film. It is usual in practice to ignore this variation of pressure through the film, and to indicate the severity with which the bearing is loaded by stating the load per square inch of the rubbing surfaces projected on to the diametral plane of the journal. Thus the projected area of the surfaces of a journal 6 in. in diameter and 8 in. long is 48 sq. in., and if the total load carried by the bearing is 20,000 pounds, the

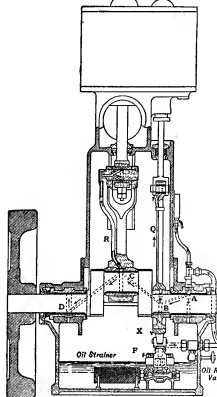

FIG. 11.

bearing would be said to carry a load of 417 pounds per square inch. When a shaft rotates in a bearing continuously in one direction the load per square inch with which it is safe to load the bearing in order to avoid undue heating is much less than if the motion is intermittent. A table of a few values of the bearing loads used in practice is given in the article LUBRICANTS.

Bearing Friction.—If W is the total load on a bearing, and if μ is the coefficient of friction between the rubbing surfaces, the tangential resistance to turning is expressed by the product μW . If v is the relative velocity of the rubbing surfaces, the work done per second against friction is μWv foot pounds. This quantity of work is converted into heat, and the heat produced per second is therefore $\mu Wv/778$ British Thermal Units. The coefficient μ is a variable quantity, and bearing in mind that a properly lubricated journal is separated from its supporting brass by a film of lubricant it might be expected that μ would have values characteristic of the coefficient of friction between two metallic surfaces, according to the characteristics properly belonging to fluid friction, merging as the oil film varied from an imperfect to a perfect condition, that is, according as the lubrication is partial or complete, completeness being attained by the use of an oil bath or by some method of forced lubrication. This expectation is entirely borne out by experimental researches. Beauchamp Tower ("Report on Friction Experiments," *Proc. Inst. Mech. Eng.*, November 1883) found that when oil was supplied to a bearing by means of a pad the coefficient of friction was approximately constant with the value of $1/100$, thus following the law of solid friction; but when the journal was lubricated by means of an oil bath the coefficient of friction varied nearly inversely as the load on the bearing, thus making $\mu W = \text{constant}$. The tangential resistance in this case is characteristic of fluid friction since it is independent of the pressure. Tower's experiments were carried out at a nearly constant temperature. The later experiments of O. Lasche (*Zeitsch. Verein deutsche Ingenieure*, 1902, 46, pp. 1881 et seq.) show how μ depends upon the temperature. Lasche's main results with regard to the variation of μ are briefly:— μW is a constant quantity, thus confirming Tower's earlier experiments; μ is practically independent of the relative velocity of the rubbing surfaces within the limits of 3 to 50 ft. per second; and the product μt is constant, t being the temperature of the bearing. Writing ρ for the load per unit of projected area of the bearing, Lasche found that the result of the experiments could be expressed

by the simple formula $\mu t = \text{constant} = 2$, where ρ = the pressure in kilograms per square centimetre, and t = the temperature in degrees centigrade. If ρ is changed to pounds per square inch the constant in the expression is approximately 30. The expression is valid between limits of pressure 1.4 to 213 pounds per square inch, limits of temperature 30° to 100°C. , and between limits of velocity 3 to 50 ft. per second.

Theory of Lubrication.—After the publication of Tower's experiments on journal friction Professor Osborne Reynolds showed (*Phil. Trans.*, 1886, p. 157) that the facts observed in connection with a journal lubricated by means of an oil bath could be explained by a theory based upon the general principles of the motion of a viscous fluid. It is first established as an essential part of the theory that the radius of the brass must be slightly greater than the radius of the journal as indicated in fig. 12, where J is the centre of the journal and I the centre of the brass.

Given this difference of curvature and a sufficient supply of oil, the rotation of the journal produces and maintains an oil film between the rubbing surfaces, the circumferential extent of which depends upon the rate of the oil supply and the external load. With an unlimited supply of oil, that is with oil-bath lubrication, the film extends continuously to the extremities of the brass, unless such extension would lead to negative pressures and therefore to a discontinuity, in which case the film ends where the pressures in the film become negative. The minimum distance between the journal and the brass occurs at the point H (fig. 12), on the off side of the point O where the line of action of the load cuts the surface of the journal. To the right and left of H the thickness of the film gradually increases, this being the condition that the oil-flow to and from the film may be automatically maintained. With an unlimited supply of oil the point H moves farther from O as the load increases until it reaches a maximum distance, and then it moves back again towards O as the load is further increased until a limiting load is reached at which the pressure in the film becomes negative at the boundaries of the film, when the boundaries recede from the edges of the brass as though the supply of oil were limited.

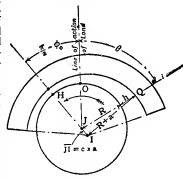

FIG. 12.

In the mathematical development of the theory it is first necessary to define the coefficient of viscosity. This is done as follows:—If two parallel surfaces AB , CD are separated by a viscous film, and if whilst CD is fixed AB moves in a tangential direction with velocity U , the surface of the film in contact with CD clings to it and remains at rest, whilst the lower surface of the film clings to and moves with the surface AB . At intermediate points in the film the tangential motion of the fluid will vary uniformly from zero to U , and the tangential resistance will be $F = \mu U/h$, where μ is the coefficient of viscosity and h is the thickness of the film. With this definition of viscosity and from the general equations representing the stress in a viscous fluid, the following equation is established, giving the relations between ρ , the pressure at any point in the film, h the thickness of the film at a point x measured round the circumference of the journal in the direction of relative motion, and U the relative tangential velocity of the surfaces,

$$\frac{d}{dx} \left(h \frac{d\rho}{dx} \right) = 6\mu U \frac{dh}{dx} \quad (1)$$

In this equation all the quantities are independent of the co-ordinate parallel to the axis of the journal, and U is constant. The thickness of the film h is some function of x , and for a journal Professor Reynolds takes the form,

$$h = a[1 + c \sin(\theta - \phi_0)]$$

in which the various quantities have the significance indicated in fig. 12. Reducing and integrating equation (1) with this value of h it becomes

$$\frac{d\rho}{d\theta} = \frac{6\mu U c [\sin(\theta - \phi_0) - \frac{\sin(\phi_1 - \phi_0)}{\theta^2 + c \sin(\theta - \phi_0)}]}{a^2 [1 + c \sin(\theta - \phi_0)]^2} \quad (2)$$

ϕ_0 being the value of θ for which the pressure is a maximum. In order to integrate this the right-hand side is expanded into a trigonometrical series, the values of the coefficients are computed, and the integration is effected term by term. If, as suggested by Professor J. Perry, the value of h is taken to be $h = h_0 + ax^2$, where h_0 is the minimum thickness of the film, the equation reduces to the form

$$-\frac{d\rho}{dx} = \frac{6\mu U}{(h_0 + ax^2)^2} + \frac{C}{(h_0 + ax^2)^3} \quad (3)$$

and this can be integrated. The process of reduction from the form (2) to the form (3) with the latter value of h , is shown in full in *The Calculus for Engineers*, by Professor Perry (p. 331), and also the final solution of equation (3), giving the pressure in terms of x .

Professor Reynolds, applying the results of his investigation to one of Tower's experiments, plotted the pressures through the film both circumferentially and longitudinally, and the agreement with the observed pressure of the experiment was exceedingly close. The whole investigation of Professor Reynolds is a remarkable one, and is in fact the first real explanation of the fact that oil is able to insinuate itself between the journal and the brass of a bearing carrying a heavy load. (See also LUBRICATING.) (W. E. D.)

BEAR-LEADER, formerly a man who led bears about the country. In the middle ages and Tudor times these animals were chiefly used in the brutal sport of bear-baiting and were led from village to village. Performing bears were also common, and are even still sometimes seen perambulating the country with their keepers, generally Frenchmen or Italians. The phrase "bear-leader" has now come colloquially to mean a tutor or guardian, who escorts any lad of rank or wealth on his travels.

BÉARN, formerly a small frontier province in the south of France, now included within the department of Basses-Pyrénées. It was bounded on the W. by Soule and Lower Navarre, on the N. by Chalosse, Tursan and Astarac, E. by Bigorre and S. by the Pyrenees. Its name can be traced back to the town of Beneharnum (Lescar). The *civitas Beneharnensium* was included in the *Nosemopolitania*. It was conquered by the *Vascones* in the 6th century, and in 819 became a viscounty dependent on the dukes of Aquitaine—a feudal link which was broken in the 11th century, when the viscounts ceased to acknowledge any suzerain. They then reigned over the two dioceses of Lescar and Oloron; but their capital was Morlaas, where they had a mint which was famous throughout the middle ages. In the 13th century Gaston VII., of the Catalonian house of Moncade, made Orthez his seat of government. His long reign (1229-1290) was a perpetual struggle with the kings of France and England, each anxious to assert his suzerainty over Béarn. As Gaston left only daughters, the viscounty passed at his death to the family of Foix, from whom it was transmitted through the houses of Grailly and Albret to the Bourbons, and they, in the person of Henry IV., king of Navarre, made it an appanage of the crown of France. It was not formally incorporated in the royal domains, however, until 1620. None of these political changes weakened the independent spirit of the Béarnais. From the 11th century onward, they were governed by their own special customs or *fors*. These were drawn up in the language of the country, a Romance dialect (1288 being the date of the most ancient written code), and are remarkable for the manner in which they define the rights of the sovereign, determining the reciprocal obligations of the viscount and his subjects or vassals. Moreover, from the 12th century Béarn enjoyed a kind of representative government, with *cours plénières* composed of deputies from the three estates. From 1220 onward, the judiciary powers of these assemblies were exercised by a *cour majeure* of twelve *barons jurats* charged with the duty of maintaining the integrity of the *fors*. When Gaston-Phoebus wished to establish a regular annual hearth-tax (*fovaige*) in the viscounty, he convoked the deputies of the three estates in assemblies called *diats*. These soon acquired extensive political and financial powers, which continued in operation till 1789. Although, when Béarn was annexed to the domains of the crown, it was granted a *conseil d'état* and a parlement, which sat at Pau, the province also retained its *fors* until the Revolution.

See also Olhagaray, *Histoire de Foix, Béarn et Navarre* (1609); Pierre de Marca, *Histoire de Béarn* (1640). This work does not go beyond the end of the 13th century; it contains a large number of documents. Faget de Baure, *Essais historiques sur le Béarn* (1818); *Les Fors de Béarn*, by Mazure and Hatoulet (1839), completed by J. Brissaud and P. Rogé in *Papiers additionnels aux anciens Fors de Béarn* (1905); Léon Cadier, *Les États de Béarn depuis leur origine jusqu'au commencement du XVI^e siècle* (1888). (C. B.)

BEAS or **BIAS**, a river of India. The Beas, which was the Hyphasis of the Greeks, is one of the Five Rivers of the Punjab. It issues in the snowy mountains of Kulu at an altitude of 13,326 ft. above sea-level, flows through the Kangra valley and the plains of the Punjab, and finally joins the Sutlej after a course of 290 m. It is crossed by a railway bridge near Jullundur.

BEAT (a word common in various forms to the Teutonic languages; it is connected with the similar Romanic words derived from the Late Lat. *battere*), a blow or stroke; from the many applications of the verb "to beat" come various meanings of the substantive, in some of which the primary sense has become obscure. It is applied to the throbbing of the pulse or heart, to the beating of a drum, either for retreat, or charge, or to quarters; in music to the alternating sound produced by the striking together of two notes not exactly of the same pitch (see **SOUND**), and also to the movement of the baton by which a conductor of an orchestra or chorus indicates the time, and to the divisions of a bar. As a nautical term, a "beat" is the zigzag course taken by a ship in sailing against the wind. The application of the word to a policeman's or sentry's round comes either from beating a covert for game and hence the term means an exhaustive search of a district, or from the repeated strokes of the foot in constantly walking up and down. In this sense the word is used in America, particularly in Alabama and Mississippi, of a voting precinct.

BEATIFICATION (from the Lat. *beatus*, happy, blessed, and *facere*, to make), the act of making blessed; in the Roman Catholic Church, a stage in the process of canonization (*q.v.*).

BEATON (or **BETHUNE**), **DAVID**, (c. 1494-1546), Scottish cardinal and archbishop of St Andrews, was a younger son of John Beaton of Balfour in the county of Fife, and is said to have been born in the year 1494. He was educated at the universities of St Andrews and Glasgow, and in his sixteenth year was sent to Paris, where he studied civil and canon law. About this time he was presented to the rectory of Campsie by his uncle James Beaton, then archbishop of Glasgow. When James Beaton was translated to St Andrews in 1522 he resigned the rich abbacy of Arbroath in his nephew's favour, under reservation of one half of the revenues to himself during his lifetime. The great ability of Beaton and the patronage of his uncle ensured his rapid promotion to high offices in the church and kingdom. He was sent by King James V. on various missions to France, and in 1528 was appointed keeper of the privy seal. He took a leading part in the negotiations connected with the king's marriages, first with Madeleine of France, and afterwards with Mary of Guise. At the French court he was held in high estimation by King Francis I., and was consecrated bishop of Mirepoix in Languedoc in December 1537. On the 20th of December 1538 he was appointed a cardinal priest by Pope Paul III., under the title of St Stephen in the Coelian Hill. He was the only Scotsman who had been named to that high office by an undisputed right, Cardinal Wardlaw, bishop of Glasgow, having received his appointment from the anti-pope Clement VII. On the death of Archbishop James Beaton in 1539, the cardinal was raised to the primatial see of Scotland.

Beaton was one of King James's most trusted advisers, and it was mainly due to his influence that the king drew closer the French alliance and refused Henry VIII.'s overtures to follow him in his religious policy. On the death of James in December 1542 he attempted to assume office as one of the regents for the infant sovereign Mary, founding his pretensions on an alleged will of the late king; but his claims were disregarded, and the earl of Arran, head of the great house of Hamilton, and next heir to the throne, was declared regent by the estates. The cardinal was, by order of the regent, committed to the custody of Lord Seaton; but his imprisonment was merely nominal, and he was soon again at liberty and at the head of the party opposed to the English alliance. Arran too was soon won over to his views, dismissed the preachers by whom he had been surrounded, and joined the cardinal at Stirling, where in September 1543 Beaton crowned the young queen. In the same year he was raised to the office of chancellor of Scotland, and was appointed protonotary apostolic and legate *a latere* by the pope. Had Beaton confined himself to secular politics, his strenuous opposition to the plans of Henry VIII. for the subjugation of Scotland would have earned him the lasting gratitude of his countrymen. Unfortunately politics were inextricably interwoven with the religious controversies of the time, and resistance to English influence involved resistance to

the activities of the reformers in the church, whose ultimate victory has obscured the cardinal's genuine merits as a statesman. During the lifetime of his uncle, Beaton had shared in the efforts of the hierarchy to suppress the reformed doctrines, and pursued the same line of conduct still more systematically after his elevation to the primacy. The popular accounts of the persecution for which he was responsible are no doubt exaggerated, and it sometimes ceased for considerable periods so far as capital punishments were concerned. When the sufferers were of humble rank not much notice was taken of them. It was otherwise when a more distinguished victim was selected in the person of George Wishart. Wishart had returned to Scotland, after an absence of several years, about the end of 1544. His sermons produced a great effect, and he was protected by several barons of the English faction. These barons, with the knowledge and approbation of King Henry, were engaged in a plot to assassinate the cardinal, and in this plot Wishart was now proved to have been a willing agent. The cardinal, though ignorant of the details of the plot, perhaps suspected Wishart's knowledge of it, and in any case was not sorry to have an excuse for seizing one of the most eloquent supporters of the new opinions. For some time he was unsuccessful; but at last, with the aid of the regent, he arrested the preacher, and carried him to his castle of St Andrews. On the 28th of February 1546 Wishart was brought to trial in the cathedral before the cardinal and other judges, the regent declining to take any active part, and being found guilty of heresy, was condemned to death and burnt.

The death of Wishart produced a deep effect on the Scottish people, and the cardinal became an object of general dislike, which encouraged his enemies to proceed with the design they had formed against him. Naturally resolute and fearless, he seems to have under-estimated his danger, the more so since his power had never seemed more secure. He crossed over to Angus, and took part in the wedding of his illegitimate daughter with the heir of the earl of Crawford. On his return to St Andrews he took up his residence in the castle. The conspirators, the chief of whom were Norman Leslie, master of Rothes, and William Kirkaldy of Grange, contrived to obtain admission at daybreak of the 20th of May 1546, and murdered the cardinal under circumstances of horrible mockery and atrocity.

The character of Beaton has already been indicated. As a statesman he was able, resolute, and in his general policy patriotic. As an ecclesiastic he maintained the privileges of the hierarchy and the dominant system of belief conscientiously, but always with harshness and sometimes with cruelty. His immoralities, like his acts of persecution, were exaggerated by his opponents; but his private life was undoubtedly a scandal to religion, and has only the excuse that it was not worse than that of most of his order at the time. The authorship of the writings ascribed to him in several biographical notices rests on no better authority than the apocryphal statements of Thomas Dempster.

Beaton's uncle, James Beaton, or Bethune (d. 1530), archbishop of Glasgow and St Andrews, was lord treasurer of Scotland before he became archbishop of Glasgow in 1509, was chancellor from 1513 to 1526, and was appointed archbishop of St Andrews and primate of Scotland in 1522. He was one of the regents during the minority of James V., and was chiefly responsible for this king's action in allying himself with France and not with England. He burned Patrick Hamilton and other heretics, and died at St Andrews in September 1530.

This prelate must not be confused with another, James Beaton, or Bethune (1517-1603), the last Roman Catholic archbishop of Glasgow. A son of John Bethune of Auchmuty and a nephew of Cardinal Beaton, James was a trusted adviser of the Scottish regent, Mary of Lorraine, widow of James V., and a determined foe of the reformers. In 1552 he was consecrated archbishop of Glasgow, but from 1560 until his death in 1603 he lived in Paris, acting as ambassador for Scotland at the French court.

See John Knox, *Hist. of the Reformation in Scotland*, ed. D. Laing (1846-1864); John Spottiswoode, archbishop of St Andrews, *Hist. of the Church of Scotland* (Spottiswoode Soc., 1847-1851); Art. in *Dict. of Nat. Biog.*, and works there quoted; and A. Lang, *Hist. of Scotland*, vols. i. and ii. (1900-1902).

BEATRICE, a city and the county-seat of Gage county, in S.E. Nebraska, U.S.A., about 40 m. S. of Lincoln. Pop. (1900) 7875 (852 foreign-born); (1910) 9356. It is served by the Chicago, Burlington & Quincy, the Chicago, Rock Island & Pacific, and the Union Pacific railways. Beatrice is the seat of the state institute for feeble-minded youth, and has a Carnegie library. The city is very prettily situated in the valley of the Big Blue river, in the midst of a fine agricultural region. Among its manufactures are dairy products (there is a large creamery), canned goods, flour and grist mill products, gasoline engines, well-machinery, barbed wire, tiles, ploughs, windmills, corn-huskers, and hay-balers. Beatrice was founded in 1857, becoming the county-seat in the same year. It was reached by its first railway and was incorporated as a town in 1871, was chartered as a city in 1873, and in 1901 became a city of the first class.

BEATTIE, JAMES (1735-1803), Scottish poet and writer on philosophy, was born at Laurencekirk, Kincardine, Scotland, on the 25th of October 1735. His father, a small farmer and shopkeeper, died when he was very young; but an elder brother sent him to Marischal College, Aberdeen, where he gained a bursary. In 1753 he was appointed schoolmaster of Fordoun in his native county. Here he had as neighbours the eccentric Francis Garden (afterwards Lord Gardenstone, judge of the supreme court of Scotland), and Lord Monboddo. In 1758 he became an usher in the grammar school of Aberdeen, and two years later he was made professor of moral philosophy at Marischal College. Here he became closely acquainted with Dr Thomas Reid, Dr George Campbell, Dr Alexander Gerard and others, who formed a kind of literary or philosophic society known as the "Wise Club." They met once a fortnight to discuss speculative questions, David Hume's philosophy being an especial object of criticism. In 1761 Beattie published a small volume of *Original Poems and Translations*, which contained little work of any value. Its author in later days destroyed all the copies he found. In 1770 Beattie published his *Essay on the Nature and Immutability of Truth in opposition to sophistry and scepticism*, the object of which, as explained by its author, was to "prove the universality and immutability of moral sentiment" (letter to Sir W. Forbes, 17th January 1765). It was in fact a direct attack on Hume, and part of its great popularity was due to the fact. Hume is said to have justly complained that Beattie "had not used him like a gentleman," but made no answer to the book, which has no philosophical value. Beattie's portrait, by Sir Joshua Reynolds, hangs at Marischal College, Aberdeen. The philosopher is painted with the *Essay on Truth* in his hand, while a figure of Truth thrusts down three figures representing, according to Sir W. Forbes, sophistry, scepticism and infidelity. Reynolds in a letter to Beattie (February 1774) intimates that he is well enough pleased that one of the figures is identified with Hume, and that he intended Voltaire to be one of the group. Beattie visited London in 1773, and was received with the greatest honour by George III., who conferred on him a pension of £200 a year. In 1771 and 1774 he published the first and second parts of *The Minstrel*, a poem which met with great and immediate success. The Spenserian stanza in which it is written is managed with smoothness and skill, and there are many fine descriptions of natural scenery. It is entirely on his poetry that Beattie's reputation rests. The best known of his minor poems are "The Hermit" and "Retirement."

In 1773 he was offered the chair of moral philosophy at Edinburgh University, but did not accept it. Beattie made many friends, and lost none. "We all love Beattie," said Dr Johnson. "Mrs Thrale says, if ever she has another husband she will have him." He was in high favour too with Mrs Montagu and the other *bas bleus*. Beattie was unfortunate in his domestic life. Mary Dunn, whom he married in 1767, became insane, and his two sons died just as they were attaining manhood. The elder, James Hay Beattie, a young man of great promise, who at the age of nineteen had been associated with his father in his professorship, died in 1790. In 1794 the father published *Essays and Fragments in Prose and Verse* by James Hay Beattie with a

touching memoir. The younger brother died in 1796. Beattie never recovered from this second bereavement. His mind was seriously affected, and, although he continued to lecture occasionally, he neither wrote nor studied. In April 1799 he had a stroke of paralysis, and died on the 18th of August 1803.

Beattie's other poetical works include *The Judgment of Paris* (1765), and "Verses on the death of [Charles] Churchill," a bitter attack which the poet afterwards suppressed. The best edition is the *Poetical Works* (1831, new ed. 1866) in the *Aldine Edition of the British Poets*, with an admirable memoir by Alexander Dyce.

See also *An Account of the Life of James Beattie* (1804), by A. Bower; and *An Account of the Life and Writings of James Beattie* (1807), by Sir William Forbes; a quantity of new material is to be found in *Beattie and his Friends* (1904), by the poet's great-grand-niece, Margaret Forbes; and *James Beattie, the Minstrel. Some Unpublished Letters*, edited by A. Mackie (Aberdeen, 1908).

BEATUS, of Liébana and Valcavado, Spanish priest and monk, theologian and geographer, was born about 730, and died in 798. About 776 he published his *Commentaria in Apocalypsin*, containing one of the oldest Christian world-maps. He took a prominent part in the Adoptionist controversy, and wrote against the views of Felix of Urgel, especially as upheld by Elipandus of Toledo. As confessor to Queen Adosinda, wife of King Silo of Oviedo (774-783), and as the master of Alcuin and Etherius of Osma, Beatus exercised wide influence. His original map, which was probably intended to illustrate, above all, the distribution of the Apostolic missions throughout the world—depicting the head of Peter at Rome, of Andrew in Achaia, of Thomas in India, of James in Spain, and so forth—has survived in ten more or less modified copies. One only of these—the "Osma" of 1203—preserves the Apostolic pictures; among the remaining examples, that of "St Sever," now at Paris, and dating from about 1030, is the most valuable; that of "Valcavado," recently in the Ashburnham Library, executed in 970, is the earliest; that of "Turin," dating from about 1100, is perhaps the most curious. Three others—"Valladolid" of about 1035, "Madrid" of 1047, and "London" of 1109—are derivatives of the "Valcavado-Ashburnham" of 970; the eighth, "Paris II.," is connected, though not very intimately, with "St Sever," otherwise "Paris I.," the ninth and tenth, "Gerona" and "Paris III.," belong to the Turin group of Beatus maps. All these works are emphatically of "dark-age" character; very seldom do they suggest the true forms of countries, seas, rivers or mountains, but they embody some useful information as to early medieval conditions and history. St Isidore appears to be their principal authority; they also draw, directly or indirectly, from Orosius, St Jerome, St Augustine, and probably from a lost map of classical antiquity, represented in a measure by the Peutinger Table of the 13th century.

The chief MSS. of the *Commentaria in Apocalypsin* are (1-3) Paris, National Library, Lat. 8878; Lat. nouv. acq. 1366 and 2290; (4) Ashburnham MSS. xv.; (5) London, B. Mus., Addit. MSS. 11695; (6) Turin, National Library 1, ii. (1); (7) Valladolid, University Library, 229; (8) the MS. in the Episcopal Library at Osma, in Old Castile.

There is only one complete edition of the text, that by Florez (Madrid, 1770). See also Konrad Miller, *Die Weltkarte des Beatus*, Heft I, of *Mappaemundi: die ältesten Weltkarten* (Stuttgart, 1895); d'Arveac in *Annales de . . . géographie* (June 1870); Beazley, *Dawn of Modern Geography*, i. 387-388 (1897); ii. 549-559; 591-605 (1901). (C. R. B.)

BEAUCAIRE, a town of south-eastern France, in the department of Gard, 17 m. E. by S. of Nîmes on the Paris-Lyon railway. Pop. (1906) 7284. Beaucuire is situated on the right bank of the Rhone, opposite Tarascon, with which it is connected by two handsome bridges, a suspension-bridge of four spans and 1476 ft. in length, and a railway bridge. A triangular keep, a chapel, and other remains of a château (13th and 14th centuries) of the counts of Toulouse stand on the rocky pine-clad hill which rises to the north of the town; the chapel, dedicated to St Louis, belongs to the latest period of Romanesque architecture, and contains fine sculptures. The town derives celebrity from the great July fair, which has been held here annually since the 12th century, but has now lost its former importance (see FAIR).

Beaucuire gives its name to the canal which communicates with the sea (near Aigues-Mortes) and connects it with the Canal du Midi, forming part of the line of communication between the Rhone and the Garonne. The town is an important port on the Rhone, and its commerce, the chief articles of which are wine, and freestone from quarries in the vicinity, is largely water-borne. Among its industries are distilling and the manufacture of furniture, and the preparation of vermicelli, sausages and other provisions.

Beaucuire occupies the site of the ancient *Ugernum*, and several remains of the Roman city have been discovered, as well as (in 1734) the road that led from Nîmes. The present name is derived from *Bellum Quadrum*, a descriptive appellation applied in the middle ages either to the château or to the rock on which it stands. In 1125 Beaucuire came into the possession of the counts of Toulouse, one of whom, Raymond VI., established the importance of its fairs by the grant of privileges. In the Wars of the League it suffered severely, and in 1632 its castle was destroyed by Richelieu.

BEAUCE (Lat. *Belsia*), a physical region of north-central France, comprising large portions of the departments of Eure-et-Loir and Loir-et-Cher, and also extending into those of Loiret and Seine-et-Oise. It has an area of over 2800 sq. m., its limits being roughly defined by the course of the Essonne on the E., of the Loire on the S., and of the Brenne, the Loir and the Eure towards the W., though in the latter direction it extends somewhat beyond these boundaries. The Beauce is a treeless, arid and monotonous plain of limestone formation; windmills and church spires are the only prominent features of the landscape. Apart from the rivers on its borders, it is watered by insignificant streams, of which the Conie in the west need alone be mentioned. The inhabitants live in large villages, and are occupied in agriculture, particularly in the cultivation of wheat, for which the Beauce is celebrated. Clover and lucerne are the other leading crops, and large flocks of sheep are kept in the region. Chartres is its chief commercial centre.

BEAUCHAMP, the name of several important English families. The baronial house of Beauchamp, of Bedford was founded at the Conquest by Hugh de Beauchamp, who received a barony in Bedfordshire. His eldest son Simon left a daughter, whose husband Hugh (brother of the count of Meulan) was created earl of Bedford by Stephen. But the heir-male, Miles de Beauchamp, nephew of Simon, held Bedford Castle against the king in 1137-1138. From his brother Payn descended the barons of Bedford, of whom William held Bedford Castle against the royal forces in the struggle for the Great Charter, and was afterwards made prisoner at the battle of Lincoln, while John, who sided with the barons under Simon de Montfort, fell at Evesham. With him the line ended, but a younger branch was seated at Eaton Socon, Beds., where the earthworks of their castle remain, and held their barony there into the 14th century.

The Beauchamps of Elmley, Worcestershire, the greatest house of the name, were founded by the marriage of Walter de Beauchamp with the daughter of Urise d'Abetot, a Domesday baron, which brought him the shrievalty of Worcestershire, the office of a royal steward, and large estates. His descendant William, of Elmley, married Isabel, sister and eventually heiress to William Mauduit, earl of Warwick, and their son succeeded in 1268 to Warwick Castle and that earldom, which remained with his descendants in the male line till 1445. The earls of the Beauchamp line played a great part in English history. Guy, the 2nd, distinguished himself in the Scottish campaigns of Edward I., who warned him at his death against Piers Gaveston. Under Edward II. he was one of the foremost foes of Piers, who had styled him "the black cur of Arden," and with whose death he was closely connected. As one of the "lords ordainers" he was a recognized leader of the opposition to Edward II. By the heiress of the Tonis he left at his death in 1315 a son Earl Thomas, who distinguished himself at Crécy and Poitiers, was marshal of the English host, and, with his brother John, one of the founders of the order of the Garter. In 1369 his son Earl Thomas succeeded; from 1376 to 1379 he was among the lords

striving for reform, and in the latter year he was appointed governor to the king. Under Richard II. he joined the lords appellants in their opposition to the king and his ministers, and was in power with them 1388-1389; treacherously arrested by Richard in 1397, he was imprisoned in the Tower of London (the Beauchamp Tower being called after him), but liberated by Henry IV. on his triumph (1399). In 1401 he was succeeded by his son Earl Richard, a brave and chivalrous warrior, who defeated Owen Glendower, fought the Percys at Shrewsbury, and, after travelling in state through Europe and the Holy Land, was employed against the Lollards and afterwards as lay ambassador from England to the council of Constance (1414). He held command for a time at Calais, and took an active part in the French campaigns of Henry V., who created him earl and count of Auvergne in Normandy. He had charge of the education of Henry VI., and in 1437 was appointed lieutenant of France and of Normandy. Dying at Rouen in 1439, he left by Isabel, widow of Richard Beauchamp, earl of Worcester, a son, Earl Henry, who was created duke of Warwick, 1445, and is alleged, but without authority, to have been crowned king of the Isle of Wight by Henry VI. He died, the last of his line, in June 1445. On the death of Anne, his only child, in 1449, his vast inheritance passed to Anne, his sister of the whole blood, wife of Richard Neville, earl of Salisbury ("the Kingmaker"), who thereupon became earl of Warwick.

Of the cadet branches of the house, the oldest was that of Powyke and Alcester, which obtained a barony in 1447 and became extinct in 1496; from it sprang the Beauchamps, Lords St Amand from 1448, of whom was Richard, bishop of Salisbury, first chancellor of the order of the Garter, and who became extinct in 1508, being the last known male heirs of the race. Another cadet was Sir John Beauchamp of Holt, minister of Richard II., who was created Lord Beauchamp of Kidderminster (the first baron created by patent) 1387, but beheaded 1388; the barony became extinct with his son in 1400. Roger, Lord Beauchamp of Bletsoe, summoned in 1363, is said to have been descended from the Powyke branch; his line ended early in the 15th century. Later cadets were John, brother of the 3rd earl, who carried the standard at Crécy, became captain of Calais, and was summoned as a peer in 1350, but died unmarried; and William, brother of the 4th earl, who was distinguished in the French wars, and succeeding to the lands of the Lords Abergavenny was summoned in that barony 1392; his son was created earl of Worcester in 1420, but died without male issue in 1422; from his daughter, who married Sir Edward Neville, descended the Lords Abergavenny.

The Lords Beauchamp of "Hache" (1299-1361) were so named from their seat of Hatch Beauchamp, Somerset, and were of a wholly distinct family. Their title, "Beauchamp of Hache," was revived for the Seymours in 1536 and 1559. The title of "Beauchamp of Powyke" was revived as a barony in 1806 for Richard Lygon (descended through females from the Beauchamps of Powyke), who was created Earl Beauchamp in 1815.

See Sir W. Dugdale, *Baronage* (1675-1676) and *Warwickshire* (2nd ed., 1730); G. E. C[ockayne], *Complete Peerage* (1887-1898); W. Courthope, *Royal Roll* (1859); and J. H. Round, *Geoffrey de Mandeville* (1892).

BEAUCHAMP, ALPHONSE DE, French historian and man of letters, was born at Monaco in 1767, and died in 1832. In 1784 he entered a Sardinian regiment of marines, but on the outbreak of war with the French Republic, he refused to fight in what he considered an unjust cause, and was imprisoned for several months. After being liberated he took up his residence in Paris, where he obtained a post in one of the government offices. On the fall of Robespierre, Beauchamp was transferred to the *bureau* of the minister of police, and charged with the superintendence of the press. This situation opened up to him materials of which he made use in his first and most popular historical work, *Histoire de la Vendée et des Chouans*, 3 vols., 1806. The book, received with great favour by the people, was displeasing to the authorities. The third edition was confiscated; its writer was deprived of his post, and in 1809 was compelled to leave Paris and take up his

abode in Reims. In 1811 he obtained permission to return, and again received a government appointment. This he had to resign on the Restoration, but was rewarded with a small pension, which was continued to his widow after his death.

Beauchamp wrote extensively for the public journals and for the magazines. His biographical and historical works are numerous, and those dealing with contemporary events are valuable, owing to the sources at his disposal. They must, however, be used with great caution. The following are worth mention:—*Vie politique, militaire et privée du général Moreau* (1814); *Catastrophe de Murat, ou Récit de la dernière révolution de Naples* (1815); *Histoire de la guerre d'Espagne et du Portugal, 1807-1813* (2 vols., 1819); *Collection de mémoires relatifs aux révolutions d'Espagne* (2 vols., 1824); *Histoire de la révolution de Piémont* (2 vols., 1821, 1823); *Mémoires secrets et inédits pour servir à l'histoire contemporaine* (2 vols., 1825). The *Mémoires de Fouché* have also been ascribed to him, but it seems certain that he only revised and completed a work really composed by Fouché himself.

See an article by Louis Madelin in *La Révolution française* (1900).

BEAUFORT, the name of the family descended from the union of John of Gaunt, duke of Lancaster, with Catherine, wife of Sir Hugh Swynford, taken from a castle in Anjou which belonged to John of Gaunt. There were four children of this union—John, created earl of Somerset and marquess of Dorset; Henry, afterwards bishop of Winchester and cardinal (see **BEAUFORT, HENRY**); Thomas, made duke of Exeter and chancellor; and Joan, who married Ralph Neville, first earl of Westmorland, and died in 1440. In 1306, some years after the birth of these children, John of Gaunt and Catherine were married, and in 1307 the Beauforts were declared legitimate by King Richard II. In 1407 this action was confirmed by their half-brother, King Henry IV., but on this occasion they were expressly excluded from the succession to the English throne.

JOHN BEAUFORT, earl of Somerset (c. 1373-1410), assisted Richard II. in 1397 when the king attacked the lords appellants, and made himself an absolute ruler. For these services he was made marquess of Dorset, but after the deposition of Richard in 1399, he was degraded to his former rank as earl. In 1401, however, he was declared loyal, and appeared later in command of the English fleet. He married Margaret, daughter of Thomas Holland, second earl of Kent, and died in March 1410, leaving three sons, Henry, John, and Edmund, and two daughters, Jane or Joan, who married James I., king of Scotland, and Margaret, who married Thomas Courtenay, earl of Devon.

THOMAS BEAUFORT (d. 1426) held various high offices under Henry IV., and took a leading part in suppressing the rising in the north in 1405. He became chancellor in 1410, but resigned this office in January 1412 and took part in the expedition to France in the same year. He was then created earl of Dorset, and when Henry V. became king in 1413, he was made lieutenant of Aquitaine and took charge of Harfleur when this town passed into the possession of the English. In 1416 he became lieutenant of Normandy, and was created duke of Exeter; and returning to England he compelled the Scots to raise the siege of Roxburgh. Crossing to France in 1418 with reinforcements for Henry V., he took an active part in the subsequent campaign, was made captain of Rouen, and went to the court of France to treat for peace. He was then captured by the French at Baugé, but was soon released and returned to England when he heard of the death of Henry V. in August 1422. He was one of Henry's executors, and it is probable that the king entrusted his young son, King Henry VI., to his care. However this may be, Exeter did not take a very prominent part in the government, although he was a member of the council of regency. Having again shared in the French war, the duke died at Greenwich about the end of the year 1426. He was buried at Bury St Edmunds, where his remains were found in good condition 350 years later. He married Margaret, daughter of Sir Thomas Neville of Nornby, but left no issue. The Beaufort family was continued by HENRY BEAUFORT (1401-1419), the eldest son of John Beaufort, earl of Somerset, who was succeeded as earl of Somerset by his brother

JOHN BEAUFORT (1403-1444). The latter fought under Henry V. in the French wars, and having been taken prisoner remained in France as a captive until 1437. Soon after his release he returned to the war, and after the death of Richard Beauchamp, earl of Warwick, in 1439, acted as commander of the English forces, and, with his brother Edmund, was successful in recapturing Harfleur. Although chagrined when Richard, duke of York, was made regent of France, Beaufort led an expedition to France in 1442, and in 1443 was made duke of Somerset. He died, probably by his own hand, in May 1444. He married Margaret, daughter of Sir John Beauchamp, and left a daughter, MARGARET BEAUFORT, afterwards countess of Richmond and Derby, who married, for her first husband, Edmund Tudor, earl of Richmond, by whom she became the mother of King Henry VII. In this way the blood of the Beauforts was mingled with that of the Tudors, and of all the subsequent occupants of the English throne.

The title of earl of Somerset descended on the death of John Beaufort in 1444 to his brother EDMUND BEAUFORT, duke of Somerset (*q.v.*), who was killed at St Albans in 1455. By his marriage with Eleanor Beauchamp, daughter of the fifth earl of Warwick, he left three sons, Henry, Edmund and John, and a daughter, Margaret.

HENRY BEAUFORT (1436-1464) became duke of Somerset in 1455, and soon began to take part in the struggle against Richard, duke of York, but failed to dislodge Richard's ally, Richard Neville, earl of Warwick, from Calais. He took part in the victory of the Lancastrians at Wakefield in 1460, escaped from the carnage at Towton in 1461, and shared the attainder of Henry VI. in the same year. In May 1464 he was captured at Hexham and was beheaded immediately after the battle. The title of duke of Somerset was assumed by his brother, EDMUND BEAUFORT (c. 1438-1471), who fled from the country after the disasters to the Lancastrian arms, but returned to England in 1471, in which year he fought at Tewkesbury, and in spite of a promise of pardon was beheaded after the battle on the 6th of May 1471. His younger brother JOHN BEAUFORT had been killed probably at this battle, and so on the execution of Edmund the family became extinct.

MARGARET BEAUFORT married Humphrey, earl of Stafford, and was the mother of Henry Stafford, duke of Buckingham. Henry Beaufort, third duke of Somerset (d. 1464), left an illegitimate son, Charles Somerset, who was created earl of Worcester by Henry VIII. in 1514. His direct descendant, Henry Somerset, fifth earl of Worcester, was a loyal partisan of Charles I. and in 1642 was created marquis of Worcester. His grandson, Henry, the third marquis, was made duke of Beaufort in 1682, and the present duke of Beaufort is his direct descendant.

See Thomas Walsingham, *Historia Anglicana*, edited by H. T. Riley (London, 1863-1864); W. Stubbs, *Constitutional History of England*, vols. ii. and iii. (Oxford, 1895); *The Paston Letters*, edited by James Gairdner (London, 1904).

BEAUFORT, FRANÇOIS DE VENDÔME, DUC DE (1616-1669), a picturesque figure in French history of the 17th century, was the second son of César de Vendôme, and grandson of Henry IV., by Gabrielle d'Éstrées. He began his career in the army and served in the first campaigns of the Thirty Years' War, but his ambitions and unscrupulous character soon found a more congenial field in the intrigues of the court. In 1642 he joined in the conspiracy of Cinq Mars against Richelieu, and upon its failure was obliged to live in exile in England until Richelieu's death. Returning to France, he became the centre of a group, known as the "Importants," in which court ladies predominated, especially the duchess of Chevreuse and the duchess of Montbazou. For an instant after the king's death, this group seemed likely to prevail, and Beaufort to be the head of the new government. But Mazarin gained the office, and Beaufort, accused of a plot to murder Mazarin, was imprisoned in Vincennes, in September 1643. He escaped on the 31st of May 1648, just in time to join the Fronde, which began in August 1648. He was then with the parlement and the princes, against Mazarin. His personal appearance, his affectation of popular manners, his quality of grandson (legitimized), of Henry IV., rendered him a favourite

of the Parisians, who acclaimed him everywhere. He was known as the *Roi des Halles* ("king of the markets"), and popular subscriptions were opened to pay his debts. He had hopes of becoming prime minister. But among the members of the parlement and the other leaders of the Fronde, he was regarded as merely a tool. His intelligence was but mediocre, and he showed no talent during the war. Mazarin, on his return to Paris, exiled him in October 1652; and he was only allowed to return in 1654, when the cardinal had no longer any reason to fear him. Henceforth Beaufort no longer intrigued. In 1658 he was named general superintendent of navigation, or chief of the naval army, and faithfully served the king in naval wars from that on. In 1664 he directed the expedition against the pirates of Algiers. In 1660 he led the French troops defending Candia against the Turks, and was killed in a night sortie, on the 15th of June 1669. His body was brought back to France with great pomp, and official honours rendered it.

See the memoirs of the time, notably those of La Rochefoucauld, the Cardinal de Retz, and Madame de Motteville. Also D'Avenel, *Richelieu et la monarchie absolue* (1884); Cheruel, *La France sous le ministère de Mazarin* (1879); and *La France sous la minorité de Louis XIV* (1882).

BEAUFORT, HENRY (c. 1377-1447), English cardinal and bishop of Winchester, was the second son of John of Gaunt, duke of Lancaster, by Catherine, wife of Sir Hugh Swynford. His parents were not married until 1396, and in 1397 King Richard II. declared the four children of this union to be legitimate. Henry spent some of his youth at Aix-la-Chapelle, and having entered the church received various appointments, and was consecrated bishop of Lincoln in July 1398. When his half-brother became king as Henry IV. in 1399, Beaufort began to take a prominent place in public life; he was made chancellor in 1403, but he resigned this office in 1404, when he was translated from Lincoln to Winchester as the successor of William of Wykeham. He exercised considerable influence over the prince of Wales, afterwards King Henry V., and although he steadily supported the house of Lancaster he opposed the party led by Thomas Arundel, archbishop of Canterbury. A dispute over money left by John Beaufort, marquis of Dorset, caused or widened a breach in the royal family which reached a climax in 1411. The details are not quite clear, but it seems tolerably certain that the prince and the bishop, anxious to retain their power, sought to induce Henry IV. to abdicate in favour of his son. Angry at this request, the king dismissed his son from the council, and Beaufort appears to have shared his disgrace. When Henry V. ascended the throne in 1413 the bishop again became chancellor and took a leading part in the government until 1417, when he resigned his office, and proceeded to the council which was then sitting at Constance. His arrival had an important effect on the deliberations of this council, and the compromise which was subsequently made between the rival parties was largely his work. Grateful for Beaufort's services, the new pope Martin V. offered him a cardinal's hat which Henry V. refused to allow him to accept. Returning to England, he remained loyal to Henry; and after the king's death in 1422 became a member of the council and was the chief opponent of the wild and selfish schemes of Humphrey, duke of Gloucester. In 1424 he became chancellor for the third time, and was mainly responsible for the conduct of affairs during Gloucester's expedition to Hainaut. He was disliked by the citizens of London; and this ill-feeling was heightened when Gloucester, who was a favourite of the Londoners, returned to England and was doubtless reproached by Beaufort for the folly of his undertaking. A riot took place in London, and at the bishop's entreaty, the protector, John, duke of Bedford, came back to England. As this dispute was still unsettled when the parliament met at Leicester in February 1426, Bedford and the lords undertook to arbitrate. Charged by Gloucester with treason against Henry IV. and his successors, Beaufort denied the accusations. But although a reconciliation was effected, the bishop evidently regarded this as a defeat; and having resigned the chancellorship his energies were diverted into another channel.

Anxious to secure his aid for the crusade against the Hussites, Pope Martin again offered him a cardinal's hat, which Beaufort

accepted. He went to France in 1427, and was then appointed papal legate for Germany, Hungary and Bohemia; and proceeding eastwards, he made a bold but futile effort to rally the crusaders at Tachau. Returning to England to raise money for a fresh crusade, he was received with great state in London; but his acceptance of the cardinalate had weakened his position and Gloucester refused to recognize his legate commission. Beaufort gave way on this question, but an unsuccessful attempt was made in 1429 to deprive him of his see. Having raised some troops he set out for Bohemia; but owing to the disasters which had just attended the English arms in France, he was induced to allow these soldiers to serve in the French war; and in February 1431 the death of Martin V. ended his commission as legate. Meanwhile an attempt on the part of Gloucester to exclude the cardinal from the council had failed, and it was decided that his attendance was required except during the discussion of questions between the king and the papacy. He accompanied King Henry VI. to Normandy in April 1430, and in December 1431 crowned him king of France. About this time Gloucester made another attempt to deprive Beaufort of his see, and it was argued in the council that as a cardinal he could not hold an English bishopric. The general council was not inclined to press the case against him; but the privy council, more clerical and more hostile, sealed writs of praemunire and attachment against him, and some of his jewels were seized. On his return to England he attended the parliament in May 1432, and asked to hear the charges against him. The king declared him loyal, and a statute was passed freeing him from any penalties which he might have incurred under the Statute of Provisors or in other ways. He supported Bedford in his attempts to restore order to the finances. In August 1435 he attended the congress at Arras, but was unable to make peace with France; and after Bedford's death his renewed efforts to this end were again opposed by Gloucester, who favoured a continuance of the war. On two occasions the council advised the king to refuse him permission to leave England, but in 1437 he obtained a full pardon for all his offences. In 1439 and 1440 he went to France on missions of peace, and apparently at his instigation the English council decided to release Charles, duke of Orleans. This step further irritated Gloucester, who drew up and presented to the king a long and serious list of charges against Beaufort; but the council defended the policy of the cardinal and ignored the personal accusations against him. Beaufort, however, gradually retired from public life, and after witnessing the conclusion of the treaty of Troyes died at Wolvesey palace, Winchester, on the 10th of April 1447. The "black despair" which Shakespeare has cast round his dying hours appears to be without historical foundation. He was buried in Winchester cathedral, the building of which he finished. He also refounded and enlarged the hospital of St Cross near Winchester.

Beaufort was a man of considerable wealth, and on several occasions he lent large sums of money to the king. He was the lover of Lady Alice Fitzalan, daughter of Richard, earl of Arundel, by whom he had a daughter, Joan, who married Sir Edward Stradling of St Donat's in Glamorganshire. His interests were secular and he was certainly proud and ambitious; but Stubbs has pictured the fairer side of his character when he observes that Beaufort "was merciful in his political enmities, enlightened in his foreign policy; that he was devotedly faithful, and ready to sacrifice his wealth and labour for the king; that from the moment of his death everything began to go wrong, and went worse and worse until all was lost."

See *Historiae Croylandensis continuatio*, translated by H. T. Riley (London, 1854); *Proceedings and Ordinances of the Privy Council*, edited by N. H. Nicolas (London, 1831-1837); Aeneas Sylvius Piccolomini, *Historica Bohemica* (Frankfurt and Leipzig, 1707); W. Stubbs, *Constitutional History*, vol. iii. (Oxford, 1895); M. Creighton, *A History of the Papacy during the Period of the Reformation* (London, 1897); and L. B. Radford, *Henry Beaufort* (1908).

BEAUFORT, LOUIS DE (d. 1795), French historian, of whose life little is known. In 1738 he published at Utrecht a *Dissertation sur l'incertitude des cinq premiers siècles de l'histoire romaine*, in which he showed what untrustworthy guides even the his-

torians of highest repute, such as Livy and Dionysius of Halicarnassus, were for that period, and pointed out by what methods and by the aid of what documents truly scientific bases might be given to its history. This was an ingenious plea, bold for its time, against traditional history such as Rollin was writing at that very moment. A German, Christopher Saxius, endeavoured to refute it in a series of articles published in vols. i.-iii. of the *Miscellanea Liviana*. Beaufort replied by some brief and ironical *Remarques* in the appendix to the second edition of his *Dissertation* (1750). Beaufort also wrote an *Histoire de César Germanicus* (Leyden, 1761), and *La République romaine, ou plan général de l'ancien gouvernement de Rome* (The Hague, 1766, 2 vols. quarto). Though not a scholar of the first rank, Beaufort has at least the merit of having been a pioneer in raising the question, afterwards elaborated by Niebuhr, as to the credibility of early Roman history.

BEAUFORT SCALE, a series of numbers from 0 to 12 arranged by Admiral Sir Francis Beaufort (1774-1857) in 1805, to indicate the strength of the wind from a calm, force 0, to a hurricane, force 12, with sailing directions such as "5, smacks shorten sails" for coast purposes, and "royals, &c., full and by" for the open sea. An exhaustive report was made in 1906 by the Meteorological Office on the relation between the estimates of wind-force according to Beaufort's scale and the velocities recorded by anemometers belonging to the office, from which the following table is taken:—

Beaufort scale.	Corresponding wind.	Limits of hourly velocity.
Numbers.		Miles per hour.
0	Calm	Under 2
1-3	Light breeze	2-12
4-5	Moderate wind	13-23
6-7	Strong wind	24-37
8-9	Gale	38-55
10-11	Storm	56-75
12	Hurricane	Above 75

BEAUFORT WEST, in Cape province, South Africa, the capital of a division of this name, 339 m. by rail N.E. of Cape Town. Pop. (1904) 5481. The largest town in the western part of the Great Karroo, it lies, at an elevation of 2792 ft., at the foot of the southern slopes of the Nieuwveld mountains. It has several fine public buildings and the streets are lined with avenues of pear trees, while an abundant supply of water, luxuriant orchards, fields and gardens give it the appearance of an oasis in the desert. It is a favourite resort of invalids. The town was founded in 1819, and in its early days was largely resorted to by Griquas and Bechuana for the sale of ivory, skins and cattle. The Beaufort West division has an area of 6374 sq. m. and a pop. (1904) of 10,762, 45% being whites. Sheep-farming is the principal industry.

BEAUGENCY, a town of central France, in the department of Loiret, 16 m. S.W. of Orleans on the Orleans railway, between that city and Blois. Pop. (1906) 2993. It is situated at the foot of vine-clad hills on the right bank of the Loire, to the left bank of which it is united by a bridge of twenty-six arches, many of them dating from the 13th century. The chief buildings are the chateau, mainly of the 15th century, of which the massive donjon of the 11th century known as the Tour de César is the oldest portion; and the abbey-church of Notre-Dame, a building in the Romanesque style of architecture, frequently restored. Some of the buildings of the Benedictine abbey, to which this church belonged, remain. The hôtel de ville, the façade of which is decorated with armorial bearings of Renaissance carving, and the church of St Étienne, an unblemished example of Romanesque architecture, are of interest. Several old houses, some remains of the medieval ramparts and the Tour de l'Horloge, an ancient gateway, are also preserved. The town carries on trade in grain, and has flour mills.

The lords of Beaugency attained considerable importance in the 11th, 12th and 13th centuries; at the end of the 13th century the fief was sold to the crown, and afterwards passed to the house of Orleans, then to those of Dunois and Longueville and

ultimately again to that of Orleans. Joan of Arc defeated the English here in 1429. In 1567 the town was sacked and burned by the Protestants. On the 8th, 9th and 10th of December 1870 the German army, commanded by the grand-duke of Mecklenburg, defeated the French army of the Loire, under General Chanzy, in the battle of Beaugency (or Villorceau-Josnes), which was fought on the left bank of the Loire to the N.W. of Beaugency.

BEAUHARNAIS, the name of a French family, well known from the 15th century onward in Orléanais, where its members occupied honourable positions. One of them, Jean Jacques de Beauharnais, seigneur de Miramion, had for wife Marie Bonneau, who in 1661 founded a female charitable order, called after her the Miramiones. François de Beauharnais, marquis de la Ferté-Beauharnais, was a deputy in the states-general of 1789, and a devoted defender of the monarchy. He emigrated and served in Condé's army. Later he gave his adherence to Napoleon, and became ambassador in Etruria and Spain; he died in 1823. His brother Alexandre, vicomte de Beauharnais, married Josephine Tascher de la Pagerie (afterwards the wife of Napoleon Bonaparte) and had two children by her—Eugène de Beauharnais (q.v.) and Hortense, who married Louis Bonaparte, king of Holland, and became mother of Napoleon III. Claude de Beauharnais, comte des Roches-Baritaud, uncle of the marquis and of the vicomte de Beauharnais, served in the navy and became a vice-admiral. He married Marie Anne Françoise (called Fanny) Mouchard, a woman of letters who had a celebrated salon. His son, also named Claude (d. 1819), was created a peer of France in 1814, and was the father of Stéphanie de Beauharnais, who married the grand-duke of Baden. The house of Beauharnais is still represented in Russia by the dukes of Leuchtenberg, descendants of Prince Eugène. (M. P.)*

BEAUHARNAIS, EUGÈNE DE (1781-1824), step-son of Napoleon I., was born at Paris on the 3rd of September 1781. He was the son of the general Viscount Alexandre de Beauharnais (1760-1794) and Josephine Tascher de la Pagerie. The father, who was born in Martinique, and served in the American War of Independence, took part in the politics of the French Revolution, and in June-August 1793 commanded the army of the Rhine. His failure to fulfil the tasks imposed on him (especially that of the relief of Mainz) led to his being arrested, and he was guillotined (23rd June 1794) not long before the fall of Robespierre. The marriage of his widow Josephine to Napoleon Bonaparte in March 1796 was at first resented by Eugène and his sister Hortense; but their step-father proved to be no less kind than watchful over their interests. In the Italian campaigns of 1796-1797 Eugène served as aide-de-camp to Bonaparte, and accompanied him to Egypt in the same capacity. There he distinguished himself by his activity and bravery, and was wounded during the siege of Acre. Bonaparte brought him back to France in the autumn of 1799, and it is known that the intervention of Eugène and Hortense helped to bring about the reconciliation which then took place between Bonaparte and Josephine. The services rendered by Eugène at the time of the *coup d'état* of Brumaire (1799) and during the Consulate (1799-1804) served to establish his fortunes, despite the efforts of some of the Bonapartes to destroy the influence of the Beauharnais and bring about the divorce of Josephine.

After the proclamation of the Empire, Eugène received the title of prince, with a yearly stipend of 200,000 francs, and became general of the *chasseurs à cheval* of the Guard. A year later, when the Italian republic became the kingdom of Italy, with Napoleon as king, Eugène received the title of viceroy, with large administrative powers. (See ITALY.) Not long after the battle of Austerlitz (2nd December 1805) Napoleon dignified the elector of Bavaria with the title of king and arranged a marriage between Eugène and the princess Augusta Amelia of Bavaria. On the whole the government of Eugène gave general satisfaction in the kingdom of Italy; it comprised the districts between the Simplon Pass and Rimini, and also after the peace of Presburg (December 1805), Istria and Dalmatia. In 1808 (on the further partition of the papal states) the frontier of the

kingdom was extended southwards to the borders of the kingdom of Naples, in the part known as the Abruzzi. In the campaign of 1809 Eugène commanded the army of Italy, with General (afterwards Marshal) Macdonald as his *adjuvant*. The battle of Sacile, where he fought against the Austrian army of the Archduke John, did not yield proofs of military talent on the part of Eugène or of Macdonald; but on the retreat of the enemy into Austrian territory (owing to the disasters of their main army on the Danube) Eugène's forces pressed them vigorously and finally won an important victory at Raab in the heart of the Austrian empire. Then, joining the main army under Napoleon, in the island of Lobau in the Danube, near Vienna, Eugène and Macdonald acquitted themselves most creditably in the great battle of Wagram (6th July 1809). In 1810 Eugène received the title of grand-duke of Frankfurt. Equally meritorious were his services and those of the large Italian contingent in the campaign of 1812 in Russia. He and they distinguished themselves especially at the battles of Borodino and Malojarslavitz; and on several occasions during the disastrous retreat which ensued, Eugène's soldierly constancy and devotion to Napoleon shone out conspicuously in 1813-1814, especially by contrast with the tergiversations of Murat. On the downfall of the Napoleonic régime Eugène retired to Munich, where he continued to reside, with the title duke of Leuchtenberg and prince of Eichstädt. He died in 1824, leaving two surviving sons and three daughters.

For further details concerning Eugène see *Mémoires et correspondance politique et militaire du Prince Eugène*, edited by Baron A. Ducasse (10 vols., Paris, 1858-1860); F. J. A. Schneidewind, *Prinz Eugen, Herzog von Leuchtenberg in den Feldzügen seiner Zeit* (Stockholm, 1837); A. Puritzner, *Uns' Adler, unser Napoleon I.—Le roman du Prince Eugène* (Paris, 1895); F. Masson, *Napoléon et sa famille* (Paris, 1897-1900). (J. H. L. R.)

BEAUJEU. The French province of Beaujolais was formed by the development of the ancient seigniorie of Beaujeu (department of Rhône, arrondissement of Villefranche). The lords of Beaujeu held from the 10th century onwards a high rank in feudal society. In 1210 Guichard of Beaujeu was sent by Philip Augustus on an embassy to Pope Innocent III.; he was present at the French attack on Dover, where he died in 1216. His son Humbert took part in the wars against the Albigenses and became constable of France. Isabeau, daughter of this Humbert, married Renaud, count of Forez; and their second son, Louis, assumed the name and arms of Beaujeu. His son Guichard, called the Great, had a very warlike life, fighting for the king of France, for the count of Savoy and for his own hand. He was taken prisoner by the Dauphinois in 1325, thereby losing important estates. Guichard's son, Edward of Beaujeu, marshal of France, fought at Crécy, and perished in the battle of Ardes in 1351. His son died without issue in 1374, and was succeeded by his cousin, Edward of Beaujeu, lord of Perreux, who gave his estates of Beaujolais and Dombes to Louis II., duke of Bourbon, in 1400. Pierre de Bourbon was lord of Beaujeu in 1474, when he married Anne of France, daughter of Louis XI., and this is why that princess retained the name of lady of Beaujeu. Louise of Savoy, mother of Francis I., got Beaujolais assigned to herself despite the claims of the constable de Bourbon. In 1531 the province was reunited to the crown; but Francis II. gave it back to the Montpensier branch of the Bourbons in 1560, from which house it passed to that of Orleans. The title of comte de Beaujolais was borne by a son of Philippe "Égalité," duke of Orleans, born in 1779, died in 1808. (M. P.)*

BEAULIEU, a village in the French department of Alpes-Maritimes. Pop. (1906) 1460. It is about 4 m. by rail E. of Nice (1½ m. from Villefranche), and on the main line between Marseilles and Mentone; it is also connected with Nice and Mentone by an electric tramway. Of late years it has become a much frequented winter resort, and many handsome villas (among them that built by the 3rd marquis of Salisbury) have been constructed in the neighbourhood. The harbour has been extended and adapted for the reception of yachts. (W. A. B. C.)

BEAULY (pronounced *Beulley*; a corruption of *Beaulieu*), a town of Inverness-shire, Scotland, on the Beauly, 10 m. W. of

Inverness by the Highland railway. Pop. (1901) 855. Its chief interest is the beautiful remains of the Priory of St John, founded in 1230 by John Bisset of the Aird, for Cistercian monks. At the Reformation the buildings (except the church, now a ruin) passed into the possession of Lord Lovat. On the right bank of the river is the site of Lovat Castle, which once belonged to the Bissets, but was presented by James VI. to Hugh Fraser and afterwards demolished. To the south-east is the church of Kirkhill containing the vault of the Lovats. Three miles south of Beaulieu is Beaufort Castle, the chief seat of the Lovats, a fine modern mansion in the Scottish baronial style. It occupies the site of a fortress erected in the time of Alexander II., which was besieged in 1303 by Edward I. This was replaced by several castles in succession, of which one—Castle Doune—was taken by Cromwell and burned by the duke of Cumberland in 1746, the conflagration being witnessed from a neighbouring hill by Simon, Lord Lovat, before his capture on Loch Morar. The land around Beaulieu is fertile and the town drives a brisk trade in coal, timber, lime, grain and fish.

BEAUMANOIR, a seignior in what is now the department of Côtes-du-Nord, France, which gave its name to an illustrious family. Jean de Beaumanoir, marshal of Brittany for Charles of Blois, and captain of Josselin, is remembered for his share in the famous battle of the Thirty. This battle, sung by an unknown trouvère and retold with variations by Froissart, was an episode in the struggle for the succession to the duchy of Brittany between Charles of Blois, supported by the king of France, and John of Montfort, supported by the king of England. John Bramborough, the English captain of Plôérmel, having continued his ravages, in spite of a truce, in the district commanded by the captain of Josselin, Jean de Beaumanoir sent him a challenge, which resulted in a fight between thirty picked champions, knights and squires, on either side, which took place on the 25th of March 1351, near Plôérmel. Beaumanoir commanded thirty Bretons, Bramborough a mixed force of twenty Englishmen, six German mercenaries and four Breton partisans of Montfort. The battle, fought with swords, daggers and axes, was of the most desperate character, in its details very reminiscent of the last fight of the Burgundians in the *Nibelungenlied*, especially in the celebrated advice of Geoffroy du Bois to his wounded leader, who was asking for water: "Drink your blood, Beaumanoir; that will quench your thirst!" In the end the victory was decided by Guillaume de Montauban, who mounted his horse and overthrew seven of the English champions, the rest being forced to surrender. All the combatants on either side were either dead or seriously wounded, Bramborough being among the slain. The prisoners were well treated and released on payment of a small ransom. (See *Le Poème du combat des Trente*, in the *Pantheon littéraire*; Froissart, *Chroniques*, ed. S. Luce, c. iv. pp. 45 and 110 ff., and pp. 338-340).

JEAN DE BEAUMANOIR (1551-1614), seigneur and afterwards marquis de Lavardin, count of Nègrepelisse by marriage, served first in the Protestant army, but turned Catholic after the massacre of St Bartholomew, in which his father had been killed, and then fought against Henry of Navarre. When that prince became king of France, Lavardin changed over to his side, and was made a marshal of France. He was governor of Maine, commanded an army in Burgundy in 1602, was ambassador extraordinary to England in 1612, and died in 1614. One of his descendants, Henry Charles, marquis de Lavardin (1643-1701), was sent as ambassador to Rome in 1689, on the occasion of a difference between Louis XIV. and Innocent XI.

BEAUMANOIR, PHILIPPE DE RÉMI, SIRE DE (c. 1250-1296), French jurist, was born in the early part of the 13th century and died in 1296. The few facts known regarding his life are to be gathered from legal documents in which his name occurs. From these it appears that in 1273 he filled the post of *bailli* at Senlis, and in 1280 held a similar office at Clermont. He is also occasionally referred to as presiding at the assizes held at various towns. His great work is entitled *Coutumes de Beauvoisis* and first appeared in 1690, a second edition with introduction by A. A. Bugnot being published in 1842. It is regarded as one of

the best works bearing on old French law, and was frequently referred to with high admiration by Montesquieu. Beaumanoir also obtained fame as a poet, and left over 20,000 verses, the best known of his poems being *La Manekine*, *Jehan et Blonde* and *Salut d'amour*.

BEAUMARCHAIS, PIERRE AUGUSTIN CARON DE (1732-1799), French dramatist, was born in Paris on the 24th of January 1732. His father, a watchmaker named Caron, brought him up to the same trade. He was an unusually precocious and lively boy, shrewd, sagacious, passionately fond of music and imbued with a strong desire for rising in the world. At the age of twenty-one he invented a new escapement for watches, which was pirated by a rival maker. Young Caron at once published his grievance in the *Mercur*, and had the matter referred to the Academy of Sciences, which decided in his favour. This affair brought him into notice at court; he was appointed, or at least called himself, watchmaker to the king, who ordered from him a watch similar to one he had made for Mme de Pompadour. His handsome figure and cool assurance enabled him to make his way at court. Mme Franquet, the wife of an old court official, persuaded her husband to make over his office to young Caron, and, on her husband's death, a few months later, married the handsome watchmaker. Caron at the same time assumed the name Beaumarchais; and four years later, by purchasing the office of secretary to the king obtained a patent of nobility.

At court his musical talents brought him under the notice of the king's sisters, who engaged him to teach them the harp. This position enabled him to confer a slight favour on the great banker Joseph Duverney, who testified his gratitude by giving Beaumarchais a share in his speculations. The latter turned the opportunity to good account, and soon realized a handsome fortune. In 1764 he took a journey to Spain, partly with commercial objects in view, but principally on account of the Clavijo affair. José Clavijo y Fajardo had twice promised to marry the sister of Beaumarchais, and had failed to keep his word. The adventure had not the tragic ending of Goethe's *Clavijo*, for Beaumarchais did not pursue his vengeance beyond words. Beaumarchais made his first essay as a writer for the stage with the sentimental drama *Eugénie* (1767), in which he drew largely on the Clavijo incident. This was followed after an interval of two years by *Les Deux Amis*, but neither play had more than moderate success. His first wife had died within a year of the marriage and in 1768 Beaumarchais married Mme Lévéque. Her death in 1771 was the signal for unfounded rumours of poisoning. Duverney died in 1770; but some time before his death a duplicate settlement of the affairs between him and Beaumarchais had been drawn up, in which the banker acknowledged himself debtor to Beaumarchais for 15,000 francs. Duverney's heir, the comte de La Blache, denied the validity of the document though without directly stigmatizing it as a forgery. The matter was put to trial. Beaumarchais gained his cause, but his adversary at once carried the case before the parlement. In the meantime the duc de Chaulnes forced Beaumarchais into a quarrel over Mlle Menard, an actress at the Comédie Italienne, which resulted in the imprisonment of both parties. This moment was chosen by La Blache to demand judgment from the parlement in the matter of the Duverney agreement. Beaumarchais was released from prison for three or four days to see his judges. He was, however, unable to obtain an interview with Goetzman, the member of the parlement appointed to report on his case. At last, just before the day on which the report was to be given in, he was informed privately that, by presenting 200 *louis* to Mme Goetzman and 15 to her secretary, the desired interview might take place, if the result should prove unfavourable the money would be refunded. The money was sent and the interview obtained; but the decision was adverse, and 200 *louis* were returned, the 15 going as business expenses to the secretary. Beaumarchais, who had learned that there was no secretary save Mme Goetzman herself, insisted on restitution of the 15 *louis*, but the lady denied all knowledge of the affair. Her husband, who was probably not cognisant of the details of the transaction at first, doubtless thought the defeated

litigant would be easily put down, and at once brought an accusation against him for an attempt to corrupt justice. The battle was fought chiefly through the *Mémoires*, or reports published by the adverse parties, and in it Beaumarchais's success was complete. For vivacity of style, fine satire and broad humour, his famous *Mémoires* have never been surpassed. Even Voltaire was constrained to envy them. Beaumarchais was skilful enough to make his particular case of universal application. He was attacking the parlement through one of its members, and the parlement was the universally detested body formed by the chancellor Maupeou. The *Mémoires* were, therefore, hailed with general delight; and the author, from being perhaps the most unpopular man in France, became at once the idol of the people. The decision went against Beaumarchais. The parlement condemned both him and Mme Goezman *au blâme*, i.e. to civic degradation, while the husband was obliged to abandon his position. Beaumarchais was reduced to great straits, but he obtained restitution of his rights within two years, and finally triumphed over his adversary La Blache.

During the next few years he was engaged in the king's secret service. One of his missions was to England to destroy the *Mémoires secrets d'une femme publique* in which Charles Theveneau de Morande made an attack on Mme Du Barry. Beaumarchais secured this pamphlet, and burnt the whole impression in London. Another expedition to England and Holland to seize a pamphlet attacking Marie Antoinette led to a series of incidents more amazing than the intrigues in Beaumarchais's own plays, but his own account must be received with caution. Beaumarchais pursued the libeller to Germany and overtook him in a wood near Neustadt. After a struggle he had gained possession of the document when he was attacked by brigands. Unfortunately the wound alleged to have been received in this fight was proved to be self-inflicted. The Austrian government regarded Beaumarchais with a suspicion justified by the circumstances. He was imprisoned for some time in Vienna, and only released on the receipt of explanations from Paris.

His various visits to England led him to take a deep interest in the impending struggle between the American colonies and the mother-country. His sympathies were entirely with the former; and by his unwearied exertions he succeeded in inducing the French government to give ample, though private, assistance in money and arms to the Americans. He himself, partly on his own account, but chiefly as the agent of the French and Spanish governments, carried on an enormous traffic with America. Under the name of Rodrigue Hortalez et Cie, he employed a fleet of forty vessels to provide help for the insurgents.

During the same period he produced his two famous comedies. The earlier, *Le Barbier de Séville*, after a prohibition of two years, was put on the stage in 1775. The first representation was a complete failure. Beaumarchais had overloaded the last scene with allusions to the facts of his own case and the whole action of the piece was laboured and heavy. But he cut down and remodelled the piece in time for the second representation, when it achieved a complete success. The intrigues which were necessary in order to obtain a licence for the second and more famous comedy, *Le Mariage de Figaro*, are highly amusing, and throw much light on the unsettled state of public sentiment at the time. The play was completed in 1778, but the opposition of Louis XVI., who alone saw its dangerous tendencies, was not overcome till 1784. The comedy had an unprecedented success. The principal character in both plays, Figaro, is a completely original conception; in fact Beaumarchais drew a portrait of himself in the resourceful adventurer, who, for mingled wit, shrewdness, gaiety and philosophic reflection, may not unjustly be ranked with Tartuffe. To English readers the Figaro plays are generally known through the adaptations of them in the grand opera of Mozart and Rossini; and in France they long retained popularity as acting pieces. The success of *Le Mariage de Figaro* was helped on by the methods of self-advertisement so well understood by Beaumarchais. The proceeds of the

fiftieth performance were devoted to a charity, the choice of which provoked numerous epigrams. Beaumarchais had the imprudence to retaliate by personalities that were reported by his enemies to be dedicated against the king and queen. Beaumarchais was imprisoned for a short time by royal order in the prison of St Lazare. Brilliant pamphleteer as he was, Beaumarchais was at last to meet more than his match. He undertook to defend the company of the "Eaux de Paris," in which he had a large interest, against Mirabeau, and brought down on himself an invective to which he could offer no reply. His real influence was gone from that date (1785-1786). Shortly afterwards he was violently attacked by Nicolas Bergasse, whom he sued for defamation of character. He gained his case, but his reputation had suffered in the pamphlet war. Beaumarchais's later productions, the bombastic opera *Tarare* (1787) and the drama *La Mère coupable* (1792), which was very popular, are in no way worthy of his genius.

By his writings Beaumarchais contributed greatly, though quite unconsciously, to hurry on the events that led to the Revolution. At heart he hardly seems to have been a republican, and the new state of affairs did not benefit him. The astonishing thing is that the society travestied in *Le Mariage de Figaro* was the most vehement in its applause. The court looked on at a play justly characterized by Napoleon as the "revolution already in action" apparently without a suspicion of its real character. His popularity had been destroyed by the Mirabeau and Bergasse affairs, and his great wealth exposed him to the enmity of the envious. A speculation into which he entered, to supply the Convention with muskets from Holland, proved a ruinous failure. He was accused of concealing arms and corn in his house, but when his house was searched nothing was discovered but some thousands of copies of the edition (1783-1790) of the works of Voltaire which he had had printed at his private press at Kehl, in Baden. He was charged with treason to the republic and was imprisoned in the Abbaye on the 20th of August 1792. A week later he was released at the intercession of Mme Houtret de la Marinière, who had been his mistress. He took refuge in Holland and England. His memoirs entitled, *Mes six époques*, detailing his sufferings under the republic, are not unworthy of the Goezman period. His courage and happy disposition never deserted him, although he was hunted as an agent of the Convention in Holland and England, while in Paris he was proscribed as an *émigré*. He returned to Paris in 1796, and died there, suddenly, on the 18th of May 1799.

Gudin de la Brenellerie's *Histoire de Beaumarchais* (1809) was edited by M. Maurice Tourneux in 1888. See also L. de Loménie, *Beaumarchais et son temps* (1855), Eng. trans. by H. S. Edwards, (4 vols., 1856); A. Hallay's *Beaumarchais* (1897); M. de Lescure, *Éloge de Beaumarchais* (1886); and Sainte-Beuve, *Causeries du lundi*, vol. vi. Beaumarchais's works have been edited by Gudin (7 vols., 1809); by Furne (6 vols., 1827); and by E. Fournier (1876). A variorum edition of his *Théâtre complet* was published by MM. d'Heyll and de Maressot (4 vols., 1869-1875); and a *Bibliographie des œuvres de Beaumarchais*, by H. Cordier in 1883.

BEAUMARIS, a market town and municipal borough, and the county town of Anglesey, N. Wales, situated on the Bay of Beaumaris, not far from Penmon, the northern entrance of the Menai Strait. Pop. (1901) 2326. It has but one considerable street. The large castle chapel, dedicated to the Virgin, has some fine monuments. David Hughes, of Jesus College, Oxford, founded the free grammar school in 1603. Buildings include town-hall and county-hall, with St Mary's church of the 13th century, with chancel of the 16th. Practically without trade and with no manufactures, Beaumaris is principally noted as a bathing-place. Its earliest charter dates from 1283 and was revised under Elizabeth. The town was formerly called Barnover and, still earlier, Rhosfair, and bears its present name of French origin since Edward I. built its castle in 1293. This extensive building was erected on low ground, so that the fosse might communicate with the sea, and vessels might unload under its walls. The castle capitulated, after siege, to General Mytton (1646).

BEAUMONT, BELMONT, or BELLOMONT, the name of a Norman and English family, taken from Beaumont-le-Roger in

Normandy. Early in the 11th century Roger de Beaumont, a kinsman of the dukes of Normandy, married a daughter of Waleran, count of Meulan, and their son, ROBERT DE BEAUMONT (d. 1118), became count of Meulan or Mellent about 1080. Before this date, however, he had fought at Hastings, and had added large estates in Warwickshire to the Norman fiefs of Beaumont and Pont Audemer, which he received when his father entered the abbey of St Peter at Préaux. It was during the reigns of William II. and Henry I. that the count rose to eminence, and under the latter monarch he became "the first among the counsellors of the king." A "strenuous and sagacious man" he rendered valuable service to both kings in their Norman wars, and Henry I. was largely indebted to him for the English crown. He obtained lands in Leicestershire, and it has been said he was created earl of Leicester; this statement, however, is an error, although he exercised some of the privileges of an earl. His abilities as a counsellor, statesman and diplomatist gained him the admiration of his contemporaries, and Henry of Huntingdon describes him as "the wisest man between this and Jerusalem." He seems to have been a man of independent character, for he assisted Anselm against William Rufus, although he supported Henry I. in his quarrel with Pope Paschal II. When Robert died on the 5th of June 1118 his lands appear to have been divided between his twin sons, Robert and Waleran, while a third son, Hugh, became earl of Bedford in 1138.

ROBERT DE BEAUMONT (1104-1168), justiciar of England, married a granddaughter of Ralph Guader, earl of Norfolk, and receiving his father's English fiefs in 1118 became earl of Leicester. He and his brother, Waleran, were the chief advisers of Stephen, and helped this king to seize the bishops of Salisbury and Lincoln in 1139; later, however, Robert made his peace with Henry II., and became chief justiciar of England. First among the lay nobles he signed the Constitutions of Clarendon, he sought to reconcile Henry and Archbishop Becket, and was twice in charge of the kingdom during the king's absences in France. The earl founded the abbey of St Mary de Pré at Leicester and other religious houses, and by a charter confirmed the burgesses of Leicester in the possession of their merchant-gild and customs. His son, Robert, succeeded to the earldom of Leicester, and with other English barons assisted prince Henry in his revolt against his father the king in 1173. For this participation, and also on a later occasion, he was imprisoned; but he enjoyed the favour of Richard I., and died in Greece when returning from a pilgrimage in 1190. His son and heir, Robert, died childless in 1204.

WALERAN DE BEAUMONT (1104-1166) obtained his father's French fiefs and the title of count of Meulan in 1118. After being imprisoned for five years by Henry I. he spent some time in England, and during the civil war between Stephen and the empress Matilda he fought for the former until about 1150, when he deserted the king and assisted the empress. His later history appears to have been uneventful. The county of Meulan remained in possession of the Beaumont family until 1204, when it was united with the royal domain.

Another member of the Beaumont family, possibly a relative of the earlier Beaumonts, was LOUIS DE BEAUMONT (d. 1333), bishop of Durham from 1317 until his death. This prelate was related to the English king, Edward II., and after a life spent in strife and ostentation, he died on the 24th of September 1333. JOHN BEAUMONT, master of the rolls under Edward VI., was probably a member of the same family. A dishonest and corrupt judge, he was deprived of his office and imprisoned in 1552.

The barony of Beaumont dates from 1309, when HENRY BEAUMONT (d. 1340), who was constable of England in 1322, was summoned to parliament under this title. It was retained by his descendants until the death of William, the 7th baron and the 2nd viscount,¹ in 1507, when it fell into abeyance. In 1840 the barony was revived in favour of Miles Thomas Stapleton (1805-1854), a descendant of Joan, Baroness Lovel, a daughter

of the 6th baron, and it has since been retained by his descendants.

In 1906 WENTWORTH BLACKETT BEAUMONT (1829-1907), the head of a family well known in the north of England, was created Baron Allendale.

BEAUMONT, CHRISTOPHE DE (1703-1781), French ecclesiastic and archbishop of Paris, was a cadet of the Les Adrets and Saint-Quentin branch of the illustrious Dauphiné family of Beaumont. He became bishop of Bayonne in 1741, then archbishop of Vienne in 1743, and in 1746, at the age of forty-three, archbishop of Paris. Beaumont is noted for his struggle with the Jansenists. To force them to accept the bull *Unigenitus* which condemned their doctrines, he ordered the priests of his diocese to refuse absolution to those who would not recognize the bull, and to deny funeral rites to those who had confessed to a Jansenist priest. While other bishops sent Beaumont their adhesion to his crusade, the parlement of Paris threatened to confiscate his temporalities. The king forbade the parlement to interfere in these spiritual questions, and upon its proving obdurate it was exiled (September 18, 1753). The "royal chamber," which was substituted, having failed to carry on the administration of justice properly, the king was obliged to recall the parlement, and the archbishop was sent into honourable exile (August 1754). An effort was made to induce him to resign the active duties of his see to a coadjutor, but in spite of the most tempting offers—including a cardinal's hat—he refused. On the contrary, to his polemic against the Jansenists he added an attack on the *philosophes*, and issued a formal mandatory letter condemning Rousseau's *Émile*. Rousseau replied in his masterly *Lettre à M. de Beaumont* (1762), in which he insists that freedom of discussion in religious matters is essentially more religious than the attempt to impose belief by force.

De Beaumont's *Mandements, lettres et instructions pastorales* were published in two volumes in 1780, the year before his death.

BEAUMONT, SIR JOHN (1583-1627), English poet, second son of the judge, Sir Francis Beaumont, was born at Grace-Dieu in Leicestershire in 1583. The deaths of his father (in 1598) and of his elder brother, Sir Henry Beaumont (in 1605), made the poet early the head of this brilliant family; the dramatist, Francis Beaumont, being a younger brother. John went to Oxford in February 1597, and entered as a gentleman commoner in Broadgates Hall, the present Pembroke College. He was admitted to the Inner Temple in 1600, but on the death of Henry he no doubt went down to Grace-Dieu to manage the family estates. He began to write very early, and in 1602, at the age of nineteen, he published anonymously his *Metamorphosis of Tabacco*, written in very smooth couplets, in which he addressed Drayton as his "loving friend." He lived in Leicestershire for many years as a bachelor, being one "who never felt Love's dreadful arrow." But in process of time he became a tardy victim, and married a lady of the Fortescue family, who bore him four stout sons, the eldest of whom, another John, was accounted one of the most athletic men of his time. "He could leap 16 ft. at one leap, and would commonly, at a stand-leap, jump over a high long table in the hall, light on a settle beyond the table, and raise himself straight up." This magnificent young man was not without literary taste; he edited his father's posthumous poems, and wrote an enthusiastic elogy on him; he was killed in 1644 at the siege of Gloucester. Another of Sir John Beaumont's sons, Gervaise, died in childhood, and the incidents of his death are recorded in one of his father's most touching poems. Sir John Beaumont concentrated his powers on a poem in eight books, entitled *The Crown of Thorns*, which was greatly admired in MS. by the earl of Southampton and others, but which is lost. After long retirement, Beaumont was persuaded by the duke of Buckingham to move in larger circles; he attended court and in 1626 was made a baronet. This honour he did not long survive, for he died on the 19th of April 1627, and was buried in Westminster Abbey ten days later. The new Sir John, the strong man, published in 1620 a volume entitled *Bosworth Field; with a taste of the variety of other Poems*

¹ Sir John Fohn (d. 1460), the 6th baron, great chamberlain and constable of England, was the first person advanced to the dignity of a viscount in England.

left by Sir John Beaumont. No more "tastes" were ever vouchsafed, so that it is by this volume and by the juvenile *Metamorphosis of Tobacco* that Beaumont's reputation has to stand. Of late years, the peculiarities of John Beaumont's prosody have drawn attention to his work. He wrote the heroic couplet, which was his favourite measure, with almost unprecedented evenness. Bosworth Field, the scene of the battle of which Beaumont's principal poem gives a vaguely epic narrative, lay close to the poet's house of Grace-Dieu. He writes on all occasions with a smoothness which was very remarkable in the first quarter of the 17th century, and which marks him, with Edmund Waller and George Sandys, as one of the pioneers of the classic reformation of English verse.

The poems of Sir John Beaumont were included in A. Chalmers's *English Poets*, vol. vi. (1810). An edition, with "memorial introduction" and notes, was included (1869) in Dr A. B. Grosart's *Fuller Worthies' Library*; and the *Metamorphosis of Tobacco* was included in J. P. Collier's *Illustrations of Early English Popular Literature*, vol. i. (1863). (E. G.)

BEAUMONT and FLETCHER, English dramatists.¹ The names of FRANCIS BEAUMONT (1584-1616) and JOHN FLETCHER (1579-1625) are inseparably connected in the history of the English drama. John Fletcher was born in December 1579 at Rye in Sussex, and baptized on the 20th of the same month. Richard Fletcher, his father, afterwards queen's chaplain, dean of Peterborough, and bishop successively of Bristol, Worcester and London, was then minister of the parish in which the son was born who was to make their name immortal. That son was just turned of seven when the dean distinguished and disgraced himself as the spiritual tormentor of the last moments on earth of Mary Stuart. When not quite twelve he was admitted pensioner of Bene't College, Cambridge, and two years later was made one of the Bible-clerks: of this college Bishop Fletcher had been president twenty years earlier, and six months before his son's admission had received from its authorities a first letter of thanks for various benefactions, to be followed next year by a second. Four years later than this, when John Fletcher wanted five or six months of his seventeenth year, the bishop died suddenly of over much tobacco and the displeasure of Queen Elizabeth at his second marriage—this time, it appears, with a lady of such character as figures something too frequently on the stage of his illustrious son. He left eight children by his first marriage in such distress that their uncle, Dr Giles Fletcher, author of a treatise on the Russian commonwealth which is still held in some repute, was obliged to draw up a petition to the queen on their behalf, which was supported by the intercession of Essex, but with what result is uncertain.

From this date we know nothing of the fortunes of John Fletcher, till the needy orphan boy of seventeen reappears as the brilliant and triumphant poet whose name is linked for all time with the yet more glorious name of Francis Beaumont, third and youngest son of Sir Francis Beaumont of Grace-Dieu, one of the justices of the common pleas—born, according to general report, in 1586, but, according to more than one apparently irrefragable document, actually born two years earlier. The first record of his existence is the entry of his name, together with those of his elder brothers Henry and John, as a gentleman-commoner of Broadgates Hall, Oxford, now supplanted by Pembroke College. But most lovers of his fame will care rather to remember the admirable lines of Wordsworth on the "eager child" who played among the rocks and woodlands of Grace-Dieu; though it may be doubted whether even the boy's first verses were of the peaceful and pastoral character attributed to them by the great laureate of the lakes. That passionate and fiery genius which was so soon and for so short a time to "shake the buskined stage" with heroic and tragic notes of passion and of sorrow, of scorn and rage, and

slighted love and jealousy, must surely have sought vent from the first in fancies of a more ardent and ambitious kind; and it would be a likelier conjecture that when Frank Beaumont (as we know on more authorities than one that he was always called by his contemporaries, even in the full flush of his adult fame—"never more than Frank," says Heywood) went to college at the ripe age of twelve, he had already committed a tragedy or two in emulation of *Tamburlaine*, *Andronicus* or *Jeronymo*. The date of his admission was the 4th of February 1597; on the 22nd of April of the following year his father died; and on the 3rd of November 1600, having left Oxford without taking his degree, the boy of fifteen was entered a member of the Inner Temple, his two brothers standing sponsors on the grave occasion. But the son of Judge Beaumont was no fitter for success at the bar than the son of Bishop Fletcher for distinction in the church: it is equally difficult to imagine either poet invested with either gown. Two years later appeared the poem of *Salmacis and Hermaphroditus*, generally attributed to Beaumont, a voluptuous and voluminous expansion of the Ovidian legend, not on the whole discreditable to a lad of eighteen, fresh from the popular love-poems of Marlowe and Shakespeare, which it naturally exceeds in long-winded and fantastic diffusion of episodes and conceits. At twenty-three Beaumont prefixed to the magnificent masterpiece of Ben Jonson some noticeable verses in honour of his "dear friend" the author; and in the same year (1607) appeared the anonymous comedy of *The Woman-Hater*, usually assigned to Fletcher alone; but being as it is in the main a crude and puerile imitation of Jonson's manner, and certainly more like a man's work at twenty-two than at twenty-eight, internal evidence would seem to justify, or at least to excuse those critics who in the teeth of high authority and tradition would transfer from Fletcher to Beaumont the principal responsibility for this first play that can be traced to the hand of either. As Fletcher also prefixed to the first edition of *Volpone* a copy of commendatory verses, we may presume that their common admiration for a common friend was among the earliest and strongest influences which drew together the two great poets whose names were thenceforward to be for ever indivisible. During the dim eleven years between the death of his father and the dawn of his fame, we cannot but imagine that the career of Fletcher had been unprosperous as well as obscure. From seventeen to twenty-eight his youth may presumably have been spent in such painful struggles for success, if not for sustenance, as were never known to his younger colleague, who, as we have seen, was entered at Oxford a few months after Fletcher must in all likelihood have left Cambridge to try his luck in London; a venture most probably resolved on as soon as the youth had found his family reduced by the father's death to such ruinous straits that any smoother course can hardly have been open to him. Entering college at the same age as Fletcher had entered six years earlier, Beaumont had before him a brighter and briefer line of life than his elder. But whatever may have been their respective situations when, either by happy chance or, as Dyce suggests, by the good offices of Jonson, they were first brought together, their intimacy soon became so much closer than that of ordinary brothers that the household which they shared as bachelors was conducted on such thoroughly communistic principles as might have satisfied the most trenchant theorist who ever proclaimed as the cardinal point of his doctrine, a complete and absolute community of bed and board, with all goods thereto appertaining. But in the year following that in which the two younger poets had united in homage to Jonson, they had entered into a partnership of more importance than this in "the same clothes and cloak, &c.," with other necessities of life specified by Aubrey.

In 1608, if we may trust the reckoning which seems trustworthiest, the twin stars of our stage rose visibly together for the first time. The loveliest, though not the loftiest, of tragic plays that we owe to the comrades or the successors of Shakespeare, *Philaster*, has generally been regarded as the first-born issue of their common genius. The noble tragedy of *Thierry and Theodoret* has sometimes been dated earlier and assigned to Fletcher alone; but we can be sure neither of the early date nor the single

¹ Recent research has resulted in some variation of opinion as to the precise authorship of some of the plays commonly attributed to them; but this article, contributed to the ninth edition of the *Encyclopædia Britannica*, remains the classical modern criticism of Beaumont and Fletcher, and its value is substantially unaffected. As representing to the end the views of its distinguished author, it is therefore retained as written, the results of later research being epitomized in the Bibliographical Appendix at the end. (Ed.)

authorship. The main body of the play, comprising both the great scenes which throw out into full and final relief the character of our heroine for perfect good or evil, bears throughout the unmistakable image and superscription of Fletcher; yet there are parts which for gravity and steady strength of style, for reserve and temperance of effect, would seem to suggest the collaboration of a calmer and more patient hand; and these more equable and less passionate parts of the poem recall rather the touch of Massinger than of Beaumont. In the second act, for example, the regular structure of the verse, the even scheme of the action, the exaggerated braggardism which makes of the hero a mere puppet or mouthpiece of his own self-will, are all qualities which, for better or for worse, remind us of the strength or the weakness of a poet with whom we know that Fletcher, before or after his alliance with Beaumont, did now and then work in common. Even the Arbaces of Beaumont, though somewhat too highly coloured, does not "write himself down an ass," like Thierry on his first entrance, after the too frequent fashion of Massinger's braggarts and tyrants; does not proclaim at starting or display with mere wantonness of exposure his more unwelcome qualities in the naked nature of their deformity. Compare also the second with the first scene of the fourth act. In style and metre this second scene is as good an example of Massinger as the first is of Fletcher at his best. Observe especially in the elaborate narrative of the pretended self-immolation of Ordella these distinctive notes of the peculiar style of Massinger; the excess of parenthetical sentences, no less than five in a space of twenty lines; the classical common-place of allusion to Athens, Rome and Sparta in one superfluous breath; the pure and vigorous but somewhat level and prosaic order of language, with the use of certain cheap and easy phrases familiar to Massinger as catch-words; the flat and feeble terminations by means of which the final syllable of one verse runs on into the next without more pause or rhythm than in a passage of prose; the general dignity and gravity of sustained and measured expression. These are the very points in which the style of Massinger differs from that of Fletcher; whose lightest and looser verses do not overlap each other without sensible distinction between the end of one line and the beginning of the next; who is often too fluent and facile to be choice or forcible in his diction, but seldom if ever proser or conventional in phrase or allusion, and by no means habitually given to weave thoughts within thoughts, knit sentence into sentence, and hang whole paragraphs together by the help of loops and brackets. From these indications we might infer that this poem belongs altogether to a period later than the death of Beaumont; though even during his friend's life it appears that Fletcher was once at least allied with Massinger and two lesser dramatists in the composition of a play, probably the *Honest Man's Fortune*, of which the accounts are to be found in Henslowe's papers.

Hardly eight years of toil and triumph of joyous and glorious life were spared by destiny to the younger poet between the date assigned to the first radiant revelation of his genius in *Philaster* and the date which marks the end of all his labours. On the 6th of March 1616 Francis Beaumont died—according to Jonson and tradition, "ere he was thirty years of age," but this we have seen to be inconsistent with the registry of his entrance at Oxford. If we may trust the elegiac evidence of friends, he died of his own genius and fiery overwork of brain; yet from the magnificent and masculine beauty of his portrait one should certainly never have guessed that any strain of spirit or stress of invention could have worn out so long before its time so fair and royal a temple for so bright and affluent a soul. A student of physiognomy will not fail to mark the points of likeness and of difference between the faces of the two friends; both models of noble manhood, handsome and significant in feature and expression alike;—Beaumont's the stately and serene of the two, with clear thoughtful eyes, full arched brows, and strong aquiline nose, with a little cleft at the tip; a grave and beautiful mouth, with full and finely curved lips; the form of face a long pure oval, and the imperial head with its "fair large front" and clustering hair set firm and carried high with an aspect at once of quiet command and kingly observation:

Fletcher's a more keen and fervid face, sharper in outline every way, with an air of bright ardour and glad fiery impatience; sanguine and nervous, suiting the complexion and colour of hair; the expression of the eager eyes and lips almost recalling that of a noble hound in act to break the leash it strains at;—two heads as lordly of feature and as expressive of aspect as any gallery of great men can show. That spring of 1616, we may note in passing, was the darkest that ever dawned upon England or the world; for, just forty-eight days afterwards, it witnessed, on the 23rd of April, the removal from earth of the mightiest genius that ever dwelt among men. Scarcely more than a month and a half divided the death-days of Beaumont and of Shakespeare. Some three years earlier by Dyce's estimate, when about the age of twenty-nine, Beaumont had married Ursula, daughter and co-heiress to Henry Isley of Sundridge in Kent, by whom he left two daughters, one of them posthumous. Fletcher survived his friend just nine years and five months; he died "in the great plague, 1625," and was buried on the 29th of August in St Saviour's, Southwark; not, as we might have wished, beside his younger fellow in fame, who but three days after his untimely death had added another deathless memory to the graves of our great men in Westminster Abbey, which he had sung in such noble verse. Dying when just four months short of forty-six, Fletcher had thus, as well as we can now calculate, altogether some fourteen years and six months more of life than the poet who divides with him the imperial inheritance of their common glory.

The perfect union in genius and in friendship which has made one name of the two names of these great twin brothers in song is a thing so admirable and so delightful to remember, that it would seem ungracious and unkindly to claim for either a precedence which we may be sure he would have been eager to disclaim. But if a distinction must be made between the Dioscuri of English poetry, we must admit that Beaumont was the twin of heavenlier birth. Only as Pollux was on one side a demigod of diviner blood than Castor can it be said that on any side Beaumont was a poet of higher and purer genius than Fletcher; but so much must be allowed by all who have eyes and ears to discern in the fabric of their common work a distinction without a difference. Few things are stranger than the avowal of so great and exquisite a critic as Coleridge, that he could trace no faintest line of demarcation between the plays which we owe mainly to Beaumont and the plays which we owe solely to Fletcher. To others this line has always appeared in almost every case unmistakable. Were it as hard and broad as the line which marks off, for example, Shakespeare's part from Fletcher's in *The Two Noble Kinsmen*, the harmony would of course be lost which now informs every work of their common genius, and each play of their writing would be such another piece of magnificent patchwork as that last gigantic heir of Shakespeare's invention, the posthumous birth of his parting Muse which was suckled at the breast of Fletcher's as a child of godlike blood might be reared on the milk of a mortal mother—or in this case, we might sometimes be tempted to say, of a she-goat who left in the veins of the heaven-born suckling somewhat too much of his nurse Amalthea. That question however belongs in any case more properly to the study of Shakespeare than to the present subject in hand. It may suffice here to observe that the contributions of Fletcher to the majestic temple of tragedy left incomplete by Shakespeare show the lesser workman almost equally at his best and at his worst, at his weakest and at his strongest. In the plays which we know by evidence surer than the most trustworthy tradition to be the common work of Beaumont and Fletcher, there is indeed no trace of such incongruous and incompatible admixture as leaves the greatest example of romantic tragedy—for *Cymbeline* and the *Winter's Tale*, though not guiltless of blood, are in their issues no more tragic than *Pericles* or the *Tempest*—a unique instance of glorious imperfection, a hybrid of heavenly and other than heavenly breed, disproportioned and divine. But throughout these noblest of the works inscribed generally with the names of both dramatists we trace on every other page the touch of a surer hand, we hear at every other turn the note of a deeper

voice, than we can ever recognize in the work of Fletcher alone. Although the beloved friend of Jonson, and in the field of comedy his loving and studious disciple, yet in that tragic field where his freshest bays were gathered Beaumont was the worthiest and the closest follower of Shakespeare. In the external but essential matter of expression by rhythm and metre he approves himself always a student of Shakespeare's second manner, of the style in which the graver or tragic part of his historical or romantic plays is mostly written; doubtless, the most perfect model that can be studied by any poet who, like Beaumont, is great enough to be in no danger of sinking to the rank of a mere copyist, but while studious of the perfection set before him is yet conscious of his own personal and proper quality of genius, and enters the presence of the master not as a servant but as a son. The general style of his tragic or romantic verse is as simple and severe in its purity of note and regularity of outline as that of Fletcher's is by comparison lax, effusive, exuberant. The matchless fluency and rapidity with which the elder brother pours forth the stream of his smooth swift verse gave probably the first occasion for that foolish rumour which has not yet fallen duly silent, but still murrns here and there its suggestion that the main office of Beaumont was to correct and contain within bounds the overflowing invention of his colleague. The poet who while yet a youth had earned by his unaided mastery of hand such a crown as was bestowed by the noble love and the loving "envy" of Ben Jonson was, according to this tradition, a mere precocious pedagogue, fit only to revise and restrain the too liberal effusions of his elder in genius as in years. Now, in every one of the plays common to both, the real difficulty for a critic is not to trace the hand of Beaumont, but to detect the touch of Fletcher. Throughout the better part of every such play, and above all of their two masterpieces, *Philaster* and *The Maid's Tragedy*, it should be clear to the most sluggish or cursory of readers that he has not to do with the author of *Valentinian* and *The Double Marriage*. In those admirable tragedies the style is looser, more fluid, more feminine. From the first scene to the last we are swept as it were along the race of a running river, always at full flow of light and buoyant melody, with no dark reaches or perilous eddies, no stagnant pools or sterile sandbanks; its bright course only varied by sudden rapids or a stronger ripple here and there, but in rough places or smooth still stirred and sparkling with summer wind and sun. But in those tragic poems of which the dominant note is the note of Beaumont's genius a subtler chord of thought is sounded, a deeper key of emotion is touched, than ever was struck by Fletcher. The lighter genius is palpably subordinate to the stronger, and loyally submits itself to the impression of a loftier spirit. It is true that this distinction is never grave enough to produce a discord: it is also true that the plays in which the predominance of Beaumont's mind and style is generally perceptible make up altogether but a small section of the work that bears their names conjointly; but it is no less true that within this section the most precious part of that work is comprised. Outside it we shall find no figures so firmly drawn, no such clearness of outline, no such cunning of hands as we recognize in the three great studies of Bellario, Evadne and Aspatia. In his male characters, as for instance in the parts of Philaster and Arbaces, Beaumont also is apt to show something of that exaggeration or inconsistency for which his colleague is perhaps more frequently and more heavily to blame; but in these there is not a jarring note, not a touch misplaced; unless, indeed, a rigid criticism may condemn as unfeminine and incongruous with the gentle beauty of her pathetic patience the device by which Aspatia procures herself the death desired at the hand of Amintor. This is noted as a fault by Dyce; but may well be forgiven for the sake of the magnificent scene which follows, and the highest tragic effect ever attained on the stage of either poet. That this as well as the greater part of those other scenes which are the glory of the poem is due to Beaumont might readily be shown at length by the process of comparison. The noble scene of regicide, which it was found expedient to cancel during the earlier years of the Restoration, may indeed be the work of

Fletcher; but the part of Evadne must undoubtedly be in the main assigned to the more potent hand of his fellow. There is a fine harmony of character between her naked audacity in the second act and her fierce repentance in the fourth, which is not unworthy a disciple of the tragic school of Shakespeare; Fletcher is less observant of the due balance, less heedful of the nice proportions of good and evil in a faulty and fiery nature, compounded of perverse instinct and passionate reaction. From him we might have had a figure as admirable for vigour of handling, but hardly in such perfect keeping as this of Beaumont's Evadne, the murderess-Magdalen, whose penitence is of one crimson colour with her sin. Nor even in Fletcher's Ordella, worthy as the part is throughout even of the precious and exquisite praise of Lamb, is there any such cunning touch of tenderness or delicate perfume of pathos as in the parts of Bellario and Aspatia. These have in them a bitter sweetness, a subtle pungency of mortal sorrow and tears of divine delight, beyond the reach of Fletcher. His highest studies of female character have dignity, energy, devotion of the heroic type; but they never touch us to the quick, never waken in us any finer and more profound sense than that of applause and admiration. There is a modest pathos now and then in his pictures of feminine submission and slighted or outraged love; but this submission he is apt to make too servile, this love too dog-like in its abject devotion to retain that tender reverence which so many generations of readers have paid to the sweet memories of Aspatia and Bellario. To excite compassion was enough for Fletcher as in the masculine parts of his work it was enough for him to excite wonder, to sustain curiosity, to goad and stimulate by any vivid and violent means the interest of readers or spectators. The single instance of noble pathos, the one scene he has left us which appeals to the higher and purer kind of pity, is the death of the child Hengo in *Bonduca*—a scene which of itself would have sufficed to enrol his name for ever on the list of our great tragic poets. To him we may probably assign the whole merit of that fiery and high-toned tragedy, with all its spirit and splendour of national and martial passion; the conscious and demonstrative exchange of courtesy between Roman and Briton, which is one of the leading notes of the poem, has in it a touch of overstrained and artificial chivalry characteristic of Fletcher; yet the parts of Caratach and Poenius may be counted among the loftiest and most equal of his creations. But no surer test or better example can be taken of the distinctive quality which denotes the graver genius of either poet than that supplied by a comparison of Beaumont's *Triumph of Love* with Fletcher's *Triumph of Death*. Each little play, in the brief course of its single act, gives proof of the peculiar touch and special trick of its author's hand: the deeper and more delicate passion of Beaumont, the rapid and ardent activity of Fletcher, have nowhere found a more noticeable vent for the expression respectively of the most tender and profound simplicity of quiet sweetness, the most buoyant and impatient energy of tragic emotion.

In the wider field of their comic or romantic drama it is yet easier to distinguish the respective work of either hand. The bias of Fletcher was towards mixed comedy; his lightest and wildest humour is usually crossed or tempered by an infusion of romance; like Shakespeare in this one point at least, he has left no single play without some touch on it of serious interest, of poetic eloquence or fancy, however slight and fugitive. Beaumont, evidently under the imperious influence of Ben Jonson's more rigid theories, seems rather to have bent his genius with the whole force of a resolute will into the form or mould prescribed for comedy by the elder and greater comic poet. The admirable study of the worthy citizen and his wife, who introduce to the stage and escort with their applause *The Knight of the Burning Pestle* through his adventurous career to its untimely end, has all the force and fulness of Jonson's humour at its best, with more of freshness and freedom. In pure comedy, varied with broad farce and mock-heroic parody, Beaumont was the earliest as well as the ablest disciple of the master whose mantle was afterwards to be shared among the academic poets of a younger generation, the Randolphs and Cartwrights who

sought shelter under the shadow of its voluminous folds. The best example of the school of Jonson to be found outside the ample range of his own work is *The Scornful Lady*, a comedy whose exceptional success and prolonged popularity must have been due rather to the broad effect of its forcible situations, its wealth and variety of ludicrous incidents, and the strong gross humour of its dialogue, than to any finer quality of style, invention or character. It is the only work of Beaumont and Fletcher which a critic who weighs the meaning of his words can admit to be as coarse as the coarsest work of Ben Jonson. They are prone, indeed, to indulge elsewhere in a wanton and exuberant licence of talk; and Fletcher, at least, is liable to confuse the shades of right and wrong, to deface or efface the boundary lines of good and evil, to stain the ermine of virtue and palliate the nakedness of vice with the same indecorous and incongruous laxity of handling. Often in mere haste to despatch the business of a play, to huddle up a catastrophe or throw out some particular scene into sharp and immediate relief, he will sacrifice all seemliness and consistency of character to the present aim of stage effect, and the instant impression of strong incident or audacious eloquence. His heroines are too apt to utter sentiments worthy of Diana in language unworthy of Doll Tear-sheet. But in this play both style and sentiment are throughout on a lower level, the action and emotion are of a baser kind than usual; the precept of Aristotle and the practice of Jonson have been so carefully observed and exaggerated that it might almost be said to offer us in one or two places an imitation not merely of the sordid but of the sorriest qualities of human nature; and full as it is of spontaneous power and humorous invention, the comedy extolled by the moral Steele (with just so much of reservation as permits him to deprecate the ridicule cast upon the clerical character) is certainly more offensive to artistic law and æsthetic judgment by the general and ingrained coarseness of its tone, than the tragi-comedy denounced by the immoral Dryden as exceeding in licence his own worst work and that of his fellow playwrights; an imputation, be it said in passing, as groundless as the protest pleaded on their behalf is impudent; for though we may hardly agree with the uncompromising panegyrist who comments that play in particular to the approval of "the austere scarlet" (remembering, perhaps, that Aristophanes was the chosen bedfellow of Chrystostom), there is at least no such offence against art or taste in the eccentricity of its situations or the daring of its dialogue. The buoyant and facile grace of Fletcher's style carries him lightly across quagmires in which a heavier-footed poet, or one of slower tread, would have stuck fast, and come forth beiried to the knees. To Beaumont his stars had given as birthright the gifts of tragic pathos and passion, of tender power and broad strong humour; to Fletcher had been allotted a more fiery and fruitful force of invention, a more aerial ease and swiftness of action, a more various readiness and fulness of bright exuberant speech. The genius of Beaumont was deeper, sweeter, nobler than his elder's; the genius of Fletcher more brilliant, more supple, more prodigal, and more voluble than his friend's. Without a taint or a shadow on his fame of such imitative servility as marks and degrades the mere henchman or satellite of a stronger poet, Beaumont may fairly be said to hold of Shakespeare in his tragedy, in his comedy of Jonson; in each case rather as a kinsman than as a client, as an ally than as a follower: but the more special province of Fletcher was a land of his own discovering, where no later colonist has ever had power to settle or to share his reign. With the mixed or romantic comedy of Shakespeare it has nothing in common except the admixture or alternation of graver with lighter interest, of serious with humorous action. Nothing is here of his magic exaltation or charm of fairy empire. The rare and rash adventures of Fletcher on that forbidden track are too sure to end in pitiful and shameful failure. His crown of praise is to have created a wholly new and wholly delightful form of mixed comedy or dramatic romance, dealing merely with the humours and sentiments of men, their passions and their chances; to have woven of all these a web of emotion and event with such gay dexterity, to have blended his colours

and combined his effects with such exquisite facility and swift light sureness of touch, that we may return once and again from those heights and depths of poetry to which access was forbidden him, ready as ever to enjoy as of old the fresh incomparable charm, the force and ease and grace of life, which fill and animate the radiant world of his romantic invention. Neither before him nor after do we find, in this his special field of fancy and of work, more than shadows or echoes of his coming or departing genius. Admirable as are his tragedies already mentioned, rich in splendid eloquence and strong in large grasp of character as is the Roman history of *The False One*, full of interest and vigour as is the better part of *Rollo Duke of Normandy*, and sublime in the loveliness of passion as is the one scene of perfect beauty and terror which crowns this latter tragedy, Fletcher may claim a yet higher and more special station among his great dramatic peers by right of his comic and romantic than by right of his tragic and historic plays. Even in these he is more a romantic than a tragic poet. The quality of his genius, never sombre or subtle or profound, bears him always towards fresh air and sunshine. His natural work is in a midday world of fearless boyish laughter and hardly bitter tears. There is always more of rainbow than of storm in his skies; their darkest shadow is but a tragic twilight. What with him is the noon of night would seem as sunshine on the stage of Ford or Webster. There is but one passage in all these noble plays which lifts us beyond a sense of the stage, which raises our admiration out of speech into silence, tempers and transfigures our emotion with a touch of awe. And this we owe to the genius of Beaumont, exalted for an instant to the very tone and manner of Shakespeare's tragedy, when Amintor stands between the dead and the dying woman whom he has unwittingly slain with hand and tongue. The first few lines that drop from his stricken lips are probably the only verses of Beaumont or Fletcher which might pass for Shakespeare's even with a good judge of style—

"This earth of mine doth tremble," &c.

But in Fletcher's tragedy, however we may be thrilled and kindled with high contagious excitement, we are never awed into dumb delight or dread, never pierced with any sense of terror or pity too deep or even deep enough for tears. Even his Brunhals and Martias can hardly persuade us to forget for the moment that "they do but jest, poison in jest." A critic bitten with the love of classification might divide those plays of Fletcher usually ranked together as comedies into three kinds: the first he would class under the head of pure comedy, the next of heroic or romantic drama, the third of mixed comedy and romance; in this, the last and most delightful division of the poet's work the special qualities of the two former kinds being equally blended and delicately harmonized. The most perfect and triumphant examples of this class are *The Spanish Curate*, *Monsieur Thomas*, *The Custom of the Country*, and *The Elder Brother*. Next to these and not too far below them, we may put *The Little French Lawyer* (a play which in its broad conception of a single eccentric humour suggests the collaboration of Beaumont and the influence of Jonson, but in style and execution throughout is perfect Fletcher), *The Humorous Lieutenant* (on which an almost identical verdict might be passed), *Women Pleas'd*, *Beggars' Bush*, and perhaps we might add *The Fair Maid of the Inn*; in most if not in all of which the balance of exultant and living humour with serious poetic interest of a noble and various kind is held with even hand and the skill of a natural master. In pure comedy *Rule a Wife and have a Wife* is the acknowledged and consummate masterpiece of Fletcher. Next to it we might class, for comic spirit and force of character, *Wit without Money*, *The Wildgoose Chase*, *The Chances*, and *The Noble Gentleman*,—a broad poetic farce to whose overflowing fun and mastedom of extravagance no critic has ever done justice but Leigh Hunt, who has ventured, not without reason, to match its joyous and preposterous audacities of superlative and sovereign foolery with the more sharp-edged satire and practical merriment of *King and No King*, where the keen prosaic humour of Bessus and his swordsmen is as typical of the comic style in which Beaumont had been trained up under Ben Jonson as the high interest and graduated action of the

serious part of the play are characteristic of his more earnest genius. Among the purely romantic plays of Fletcher, or those in which the comic effect is throughout subordinate to the romantic, *The Knight of Malta* seems most worthy of the highest place for the noble beauty and exaltation of spirit which informs it with a lofty life, for its chivalrous union of heroic passion and Catholic devotion. This poem is the fairest and the first example of those sweet fantastic paintings in rose-colour and azure of visionary chivalry and ideal holiness, by dint of which the romance of more recent days has sought to cast the glamour of a mirage over the darkest and deadliest "ages of faith." The pure and fervent eloquence of the style is in perfect keeping with the high romantic interest of character and story. In the same class we may rank among the best samples of Fletcher's workmanship *The Pilgrim*, *The Loyal Subject*, *A Wife for a Month*, *Love's Pilgrimage*, and *The Lover's Progress*,—rich all of them in exquisite writing, in varied incident, in brilliant effects and graceful and passionate interludes. In *The Coxcomb*, and *The Honest Man's Fortune*—two plays which, on the whole, can hardly be counted among the best of their class—there are tones of homelier emotion, touches of a simpler and more pathetic interest than usual; and here, as in the two admirable first scenes between Leucippus and Bacha, which relieve and redeem from contempt the tragic burlesque of *Cupid's Revenge*, the note of Beaumont's manner is at once discernible.

Even the most rapid revision of the work done by these great twin poets must impress every capable student with a sense of the homage due to this living witness of their large and liberal genius. The loss of their names from the roll of English poetry would be only less than the loss of the few greatest inscribed on it. Nothing could supply the want of their tragic, their comic or romantic drama; no larger or more fiery planet can ever arise to supplant or to eclipse the twin lights of our zodiac. Whatever their faults of shortcoming or excess, there is in their very names or the mere thought of their common work a kind of special and personal attraction for all true lovers of high dramatic poetry. There is the glory and grace of youth in all they have left us; if there be also somewhat too much of its graceless as well as its gracious qualities, yet there hangs about their memory as it were a music of the morning, a breath and savour of bright early manhood, a joyous and vigorous air of freer life and fruitful labour, which might charm asleep for ever all thought or blame of all mortal infirmity or folly, or any stain of earth that may have soiled in passing the feet of creatures half human and half divine while yet they dwelt among men. For good or for evil, they are above all things poets of youth; we cannot conceive of them grown grey in the dignity of years, venerable with the authority of long life, and weighted with the wisdom of experience. In the Olympian circle of the gods and giants of our race who on earth were their contemporaries and cornivals, they seem to move among the graver presences and figures of sedate fame like the two spoilt boys of heaven, lightest of foot and heart and head of all the brood of deity. Shakespeare may have smiled as Jonson may have nodded approval of their bright swift work, neither of these great elders grudging his praise to the special charm which won for it a preference during one generation at least even over their own loftier and weightier verse; and indeed the advance in natural ease, in truth and grace of dialogue, is alike manifest whether we turn to such of their comic characters as Valentine and Don John, Rutilio and Monsieur Thomas, from the *Trucutit* of Jonson or even from the *Mercutio* of Shakespeare; the one too stiff with classic starch, the other too full of mere verbal catches and forced conceits, to persuade us that either can in any age have fairly represented the light free talk and facile humour of its youth. In another field than this Beaumont and Fletcher hold as high and secure a station of their own as any poet of their race. In perfect workmanship of lyrical jewellery, in perfect bloom and flower of song-writing, they equal all compeers whom they do not excel; the blossoms of their growth in this kind may be matched for colour and fragrance against Shakespeare's, and for morning freshness and natural purity of form exceed the finest grafts of Jonson. *The Faithful Shepherdess* alone might speak for Fletcher

on this score, being as it is simply a lyric poem in semi-dramatic shape, to be judged only as such, and as such almost faultless; but in no wise to be classed for praise or blame among the acting plays of its author, whose one serious error in the matter was the submission of his Dryad to the critical verdict of an audience too probably in great part composed of clowns and satyrs far unlike the loving and sweet-tongued sylvan of his lovely fancy. And whether we assign to him or to Beaumont the divine song of melancholy (*moestius lacrymis Simonideis*), perfect in form as Catullus and profound in sentiment as Shelley, which Milton himself could but echo and expand, could not heighten or deepen its exquisite intensity of thought and word alike, there will remain witness enough for the younger brother of a lyric power as pure and rare as his elder's.

The excess of influence and popularity over that of other poets usually ascribed to the work of Beaumont and Fletcher for some half century or so after their own time has perhaps been somewhat overstated by tradition. Whatever may have been for a season the fashion of the stage, it is certain that Shakespeare can show two editions for one against them in folio; four in all from 1623 to 1685, while they have but their two of 1647 and 1679. Nor does one see how it can accurately or even plausibly be said that they were in any exact sense the founders of a school either in comedy or in tragedy. Massinger, for some years their survivor, and in some points akin to them as a workman, cannot properly be counted as their disciple; and no leading poet of the time had so much in common with them as he. At first sight, indeed, his choice of romantic subject and treatment of foreign stories, gathered from the fertile tale-tellers of the south, and ranging in date from Boccaccio to Cervantes, may seem to mark him out as a member of the same school; but the deepest and most distinctive qualities of his genius set it far apart from theirs; though undoubtedly not so far that any discrepancy or discord should impair the excellence or injure the keeping of works in which he took part with Fletcher. Yet, placed beside theirs, the tone of his thought and speech seems by comparison severe as well as sober, and sad as well as severe. Their extravagant and boyish insanity of prostrate alacrity is not more alien from his half pensive and half angry undertone of political protest than his usually careful and complete structure of story from their frequently lax and slovenly incoherence of character or plot, than his well composed and proportioned metre from their lighter and looser melodies, than the bitter insistence and elaborate acrimony of his judicial satire on hypocrisy or oppression from the gaiety or facility of mood which suffers them in the shifting of a scene to redeem their worst characters by some juggler's trick of conversion at the last moment allowed them to wind up a play with universal reconciliation and an act of oblivion on all hands. They could hardly have drawn with such steady skill and explicit finish an *Overreach* or a *Luke*; but the strenuous and able work of Massinger at its highest point of success has no breath in it of their brighter and more immediate inspiration. Shirley, on the other hand, may certainly be classed as a pupil who copied their style in water-colour; his best tragedy and his best comedy, *The Traitor* and *The Lady of Pleasure*, might pass muster undetected among the plays of Fletcher, and might fairly claim to take rank above the lowest class of these. In the finest work of Middleton we recognize an almost exact reproduction of Fletcher's metrical effects,—a reverberation of that flowing music, a reiteration of those feminine final notes. In his later tragicomedies, throughout his masterpiece of *Women beware Women*, and in the noble scenes which make up the tragic or serious parts of *The Changing of the Spanish Gipsy*,—wherever, in a word, we find the admirable but unequal genius of this poet at its best—we find a likeness wholly wanting in his earlier and ruder work, which undoubtedly suggests the influence of Fletcher. Other instances of imitation, other examples of discipleship, might perhaps be found among lesser men of the next generation; but the mass of succeeding playwrights began in a very short time to lower the style and debase the scheme of dramatic poetry; and especially to loosen the last ties of harmony, to deface the very

form and feature of tragic verse. In Shirley, the last and least of those in whom the lineal blood of the old masters was yet discernible, we find side by side with the fine ancestral indications of legitimate descent exactly such marks of decadence rather than degeneracy as we might have anticipated in the latest heir of a long line which began with the rise of Marlowe, "sun of the morning," in the highest heaven of our song, to prepare a pathway for the sun. After Shakespeare there was yet room for Beaumont and Fletcher; but after these and the other constellations had set, whose lights filled up the measure of that diviner zodiac through which he moved, there was but room in heaven for the pallid moonrise of Shirley; and before this last reflex from a sunken sun was itself eclipsed, the glory had passed away from English drama, to alight upon that summit of epic song, whence Milton held communion with darkness and the stars. (A. C. S.)

BIBLIOGRAPHICAL APPENDIX

The chief collected editions of the plays of Beaumont and Fletcher are: *Comedies and Tragedies written by Francis Beaumont and John Fletcher Gentlemen*, printed by Humphrey Moseley in folio in 1647 as containing plays "never printed before"; *Fifty Comedies and Tragedies written, &c.* (fol. 1679); *Works . . .* (11 vols. 1843-1846), edited by Alexander Dyce, which superseded earlier editions by L. Theobald, G. Colman and H. Weber, and presented a modernized text; a second two-volume edition by Dyce in 1852; *The Works of Francis Beaumont and John Fletcher* (15 vols. 1905, &c.) edited by Arnold Glover and A. R. Waller in the "Cambridge English Classics" from the text of the 2nd folio, and giving variant readings from all separate issues of the plays previous to that edition; and *Works . . .* (12 vols. 1904, &c.), under the general editorship of A. H. Bullen, the text of which is founded on Dyce but with many variant readings, the last volume containing memoirs and excursions by the editor.

The foundation of all critical work on Beaumont and Fletcher is to be found in Dyce. Discrimination between the work of the two dramatists and their collaborators has been the object of a series of studies for the establishment of metrical and other tests. Fletcher's verse is recognizable by the frequency of an extra syllable, often an accented one, at the end of a line, the use of stopped lines, and the frequency of trisyllabic feet. He thus obtained an adaptable instrument enabling him to dispense with prose even in comic scenes. The pioneer work in these matters was done by F. G. Fleay in a paper read before the New Shakspeare Society in 1874 on "Metrical Tests as applied to Fletcher, Beaumont and Massinger." His theories were further developed in the article "Fletcher" in his *Biog. Chron. of the Eng. Drama*. Further investigations were published by R. Boyle in *Englische Studien* (vols. v.-x., Heilbronn, 1882-1887), and in the New Shakspeare Society Transactions (1880-1886), by Benno Leonhardt in *Anglia* (Halle, vols. xix. seq.), and by E.H. Oliphant in *Englische Studien* (vols. xiv. seq.). Mr Oliphant restores to Beaumont much which other critics had been inclined to deny him. On the sources of the plays see E. Köppel in *Münchener Beiträge zur roman. u. eng. Phil.* (Erlangen and Leipzig, 1895). Consult further articles by A. H. Bullen and R. Boyle respectively on Fletcher and Massinger in the *Dict. of Nat. Biog.*; G. C. Macaulay, *Francis Beaumont, a Critical Study* (1883); and D. A. W. Ward's chapter on "Beaumont and Fletcher" in vol. ii. of his *Hist. of Eng. Dram. Lit.* (new ed. 1890).

A list of the plays attributed to Beaumont and Fletcher, with some details, is added, with the premiss that beyond the main lines of criticism laid down in Mr Swinburne's article above it is often difficult to dogmatize on authorship. Even in cases where the play was produced long after Beaumont had ceased to write for the stage there can be no certainty that we are not dealing with a piece which is an adaptation of an earlier play by a later hand.

The Joint Works of Beaumont and Fletcher.—The Scornful Lady (acted c. 1609, pr. 1616) is a farcical comedy of domestic life, in which Oliphant finds traces of alteration by a third and perhaps a

fourth hand. *Philaster or Love Lies a-Bleeding* is assigned by Macaulay to Beaumont practically in its entirety, while Fleay attributes only three scenes to Fletcher. It was probably acted c. 1609, and was printed 1620; it was revised (1605) by Elkanah Settle and (1763) by the younger Colman, probably owing its long popularity to the touching character of Bellario. Beaumont's share also predominated in *The Maid's Tragedy* (acted c. 1609, pr. 1619), in *A King and No King* (acted at court December 26, 1611, and perhaps earlier, pr. 1610), while *The Knight of the Burning Pestle* (c. 1610, pr. 1613), burlesquing the heroic and romantic play of which Heywood's *Four Prentices* is an example, might perhaps be transferred entire to Beaumont's account. In *Cupid's Revenge* (acted at court January 1612, and perhaps at Whitehairs in 1610, pr. 1615), founded on Sidney's *Arcadia*, the two dramatists appear to have had a third collaborator in Massinger and perhaps a fourth in Nathaniel Field. *The Coxcomb* (acted c. 1610, and by the Children of the Queen's Revels in 1612, pr. 1647) seems to have undergone later revision by Massinger. Fletcher's collaboration with other dramatists had begun during his connexion with Beaumont, who apparently ceased to write for the stage two or three years before his death.

Works Assigned to Beaumont's Sole Authorship.—The Woman Hater (pr. 1607, as "lately acted by the children of Paul's") was assigned formerly to Fletcher. *The Masque of the Inner Temple and Gray's Inn* was presented at Whitehall on the 26th of February 1612, on the marriage of the Prince and Princess Palatine. Of *Four Plays, or Moral Representations, in One* (acted 1608, pr. 1617), the first, together with *The Triumph of Honour and The Triumph of Love*, both founded on tales from the *Decameron*, are by Beaumont.

Works Assigned to Fletcher's Sole Authorship.—The Faithful Shepherdess (pr. c. 1609) was ill received on its original production, but was revived in 1634. That Fletcher was the sole author is practically unquestioned, though Ben Jonson in *Drummond's Conversations* is made to assert that "Beaumont and Fletcher ten years since hath written *The Faithful Shepherdess*." It was translated into Latin verse by Sir R. Fanshawe in 1648, and Milton's *Comus* owes not a little to it. In *Four Plays in One*, the two last, *The Triumph of Death and The Triumph of Time*, are Fletcher's. In the indifferent comedy of *The Captain* (acted 1612-1613, revived 1626, pr. 1647) there is no definite evidence of any other hand than Fletcher's, though the collaboration of Beaumont, Massinger and Rowley has been advanced. Other Fletcher plays are: *Will without Money* (acted 1614, pr. 1639); the two romantic tragedies of *Bonduca* (in which Caradach or Caractacus is the chief figure rather than Bonduca or Boadicea) and *Valentinian*, both dating from c. 1616 and revised in folio; *The Loyal Subject* (acted 1617, pr. 1647) and court 1633, pr. 1647); *The Mad Lover* (acted before March 1619, pr. 1647), which borrows something from the story of Mundus and Paulina in Josephus (bk. xviii.); *The Humorous Lieutenant* (1619, pr. 1647); *Woman Pleas'd* (c. 1620, pr. 1647); *The Woman's Prize or The Tamer Tam'd* (produced probably between 1610 and 1613, acted 1633 at Blackfriars and at court, pr. 1647), a kind of sequel to *The Taming of the Shrew*; *The Chances* (uncertain date, pr. 1647), taken from *La Sennora Cornelia* of Cervantes, and repeatedly revived after the Restoration and in the 18th century; *Meliora Tomas* (acted perhaps as early as 1609, pr. 1639); *The Island Princess* (c. 1621, pr. 1647); *The Pilgrim and The Wild Goose- Chase* (pr. 1652), the second of which was adapted in prose by Farquhar, both acted at court in 1621, and possibly then not new pieces; *A Wife for a Month* (acted 1624, pr. 1647); *Rule a Wife and Have a Wife* (lic. 1624, pr. 1640). *The Pilgrim* received additions from Dryden, and was adapted by Vanbrugh.

Fletcher in Collaboration with other Dramatists.—External evidence of Fletcher's connexion with Massinger is given by Sir Ascham Coke, who in 1837, in his edition of Fletcher's Massinger works, says they did write together, were great friends, and elsewhere claimed for Massinger a share in the plays printed in the 1647 folio. James Shirley and William Rowley have their part in the works that used to be included in the Beaumont and Fletcher canon; and to a letter from Field, Daborne and Massinger, asking for £5 for their joint necessities from Henslowe about the end of 1615, there is a postscript suggesting the deduction of the sum from the many remaines for the play of Mr Fletcher and ours. The problem is complicated by the existence of an existing version of *The Pilgrim*, possibly Field's, of an earlier play which Oliphant thinks was probably written by Beaumont about 1608. The same remarks (with the exclusion of Field's name) apply to *Thierry and Theodoret* (acted c. 1617, pr. 1621), perhaps a satire on contemporary manners at the French court, though Beaumont's share in either must be regarded as problematical. Fletcher and Massinger's great tragedy of *Sir John van Olden Barnaveldt* (acted 1619) was first printed in Bullen's *Old Plays* (vol. ii., 1883). They followed it up with *The Custom of*

the Country (acted 1619, pr. 1647), based on an English translation (1619) of *Los Trabajos de Persiles y Sigismunda; The Double Marriage* (c. 1620, pr. 1647); *The Little French Lawyer* (c. 1620, pr. 1647), the plot of which can be traced indirectly to a *novellino* by Massuccio Salernitano; *The Lusus of Candy* (c. 1618, pr. 1647), of disputed authorship; *The False One* (c. 1620, pr. 1647), dealing with the subject of Caesar and Cleopatra; *The Spanish Curate* (acted 1622, pr. 1647), repeatedly revived after the Restoration, was derived from Leonard Digges's translation (1622) of a Spanish novel, *Gerardo, the Unfortunate Spaniard; The Prophess* (1622, pr. 1647), afterwards made into an opera by Betterton to Purcell's music; *The Sea Voyage* (acted 1647); *The Elder Brother* (perhaps originally written by Fletcher; c. 1614; revised and acted 1635, pr. 1647); *Beggars Bush* (acted at court 1622, probably then not new, pr. 1647); and *The Noble Gentleman* (1625-1626, pr. 1647). Fletcher only had a small share in *Wit at Several Weapons*—"if he but writ an act or two," says an epilogue on its revival (1623 or 1626).—and the play is probably a revision by Rowley and Middleton of an early Beaumont and Fletcher play. *A Very Woman* (1634, pr. 1655) is a revision by Massinger of *The Woman's Plot* ascribed to Fletcher and acted at court in 1621. Field worked with Fletcher and Massinger on the lost play of the *Jeweller of Amsterdam* (1619), as on the *Faithful Friends* (1613-1614) and *The Queen of Corinth* (c. 1618, pr. 1647); *The Lover's Progress* (acted 1634, pr. 1647) is probably a revision by Massinger of the Fletcher play licensed in 1623 as *The Wandering Loner*, and is perhaps identical with *Cleander*, licensed in 1634; *Love's Cure or The Martial Maid* (1623 or 1625) is thought by Mr Fleay to be a revision by Massinger of a Beaumont and Fletcher play produced as early as 1607-1608. W. Rowley joined Fletcher in *The Maid in the Mill* (1623, pr. 1647), and had a share with Massinger in the revision of *The Fair Maid of the Inn* (licensed 1626, pr. 1647), based on *La illustre Fregona* of Cervantes. *Nice Valour* (acted 1625-1626, pr. 1647) seems to have been altered by Middleton from an earlier play; *The Widow*, printed in 1652 as by Jonson, Fletcher and Middleton, must be ascribed almost exclusively to Middleton. *The Night Walker* (1633) is a revision by Shirley of a Fletcher play.

Fletcher and Jonson in Collaboration.—The history of *The Bloody Brother or Rollo, Duke of Normandy*, printed in 1637 as by "B. J. F.," is matter of varied speculation. Mr Oliphant thinks the basis of the play to be an early work (c. 1604) of Beaumont, on which is superimposed a revision (1616) by Fletcher, Jonson and Middleton, and a subsequent revision (1636-1637) by Massinger. The general view is that the main portion of the play is referable to Jonson and Fletcher. Jonson apparently had a share in Fletcher's *Love's Pilgrimage* (pr. 1647), which seems to have been revised by Massinger in 1635.

Fletcher and Shakespeare.—*The Two Noble Kinsmen* was printed in 1634 as by Mr John Fletcher and Mr William Shakespeare. If its first representation was in 1625 it was in the year of Fletcher's death. It was included in the second folio of Beaumont and Fletcher's comedies and tragedies. If Shakespeare and Fletcher worked in concert it was probably in 1612-1613, and the existing play probably represents a revision by Massinger in 1625. *Henry VIII.* (played at the Globe in 1613) is usually ascribed mainly to Fletcher and Massinger, and the conditions of its production were probably similar. Fletcher and Shakespeare are together credited at Stationers' Hall with the lost play of *Cardenio*, destroyed by Warburton's cook. (M. Br.)

BEAUMONT, a city and the county-seat of Jefferson county, Texas, U.S.A., situated on the Neches river, in the E. part of the state, about 28 m. from the Gulf of Mexico and 72 m. N.E. of Galveston. Pop. (1890) 3296; (1900) 9427, of whom 2953 were negroes; (1910, census) 20,640. It is served by the Gulf & Interstate, the Gulf, Colorado & Santa Fé, the Kansas City Southern, the Texas & New Orleans, the Colorado Southern, New Orleans & Pacific, the Beaumont, Sour Lake & Western (from Beaumont to Sour Lake, Tex.), and the (short) Galveston, Beaumont & North-Eastern railways. The Neches river from Beaumont to its mouth has a depth of not less than 19 ft.; from its mouth extends a canal (9 ft. deep, 100 ft. wide, and 12 m. long), which connects with the Port Arthur Canal (180 ft. wide and 25 ft. deep) extending to the sea. Situated in the midst of a region covered with dense forests of pine and cypress, Beaumont is one of the largest lumber centres of the southern states; it is also the centre of a large rice-growing region. The manufacturing include rice mills, saw mills, sash, door and blind factories, shingle mills, iron works, oil refineries, broom factories and a dynamite factory. In 1905 the cleaning and polishing of rice was the most important industry, its output being valued at \$1,203,123, being nearly twice the value of the product of the rice mills of the city in 1900, 25.9% of the total value of the state's product of polished and cleaned rice, 46.1% of the value

(\$2,600,820) of all of Beaumont's factory products, and about 7.4% of the value of the product of polished and cleaned rice for the whole United States in 1905. After the sinking of oil wells in 1901, Beaumont became one of the principal oil-producing places in the United States; its oil refineries are connected by pipe lines with the surrounding oil fields, and two 6-in. pipe lines extend from Beaumont to Oklahoma. Beaumont was first settled in 1828, and was first chartered as a city in 1899.

BEAUNE, a town of eastern France, capital of an arrondissement in the department of Côte-d'Or, on the Bouzoise, 23 m. S.S.W. of Dijon on the main line of the Paris-Lyon railway. Pop. (1906) 11,668. Beaune lies at the foot of the hills of Côte-d'Or. Portions of its ancient fortifications are still to be seen, but they have been for the most part replaced by a shady promenade which separates the town from its suburbs. The most interesting feature of Beaune is the old hospital of St Esprit, founded in 1443 by Nicolas Rolin, chancellor of Burgundy. Though it is built largely of wood, the fabric is in good preservation. The exterior is simple, but the buildings which surround the main courtyard have high-pitched roofs surmounted by numerous dormer windows with decorated gables, recalling the Flemish style of architecture. In the interior there are several interesting apartments; the chief of these is the ample council chamber with its fine tapestries, where an important wine sale is held annually. The hospital possesses many artistic treasures, among them the mural paintings of the 17th century in the Salle St Hugues and an altar-piece, the Last Judgment, attributed to Roger van der Weyden. The principal church of the town, Notre-Dame, dating mainly from the 12th and 13th centuries, has a fine central tower and a triple portal with handsome wooden doors. In the interior there is some valuable tapestry of the 15th century, and other works of art. Two round towers (15th century) are a survival of the castle of Beaune, dismantled by Henry IV. A belfry of 1403 and several houses of the Renaissance period, some of which are built over ancient wine-cellar, are architecturally notable. There is a statue to the mathematician, G. Monge, born in the town (1746), and a monument to Pierre Joigneaux the politician (d. 1892). Beaune has tribunals of first instance and of commerce, a chamber of commerce, a school of agriculture and viticulture and colleges for girls and boys. It carries on considerable trade in live-stock and cereals and in the vegetables of its market-gardens, and manufactures of casks, corks, white metal, oil, vinegar and machinery for the wine-trade are included among the industries; it is chiefly important for its vineyards and as the centre of the wine-trade of Burgundy.

Beaune was a fortified Roman camp and a stronghold during the middle ages. It was the capital of a separate county which in 1227 was united to the duchy of Burgundy; it then became the first seat of the Burgundian parlement or *jours généraux* and a ducal residence. On the death of Charles the Bold, it sided with his daughter, Mary of Burgundy, but was besieged and taken by the forces of Louis XI. in 1478. Its rank as commune, conceded to it in 1203, was confirmed by Francis I. in 1521. In the Wars of Religion it at first sided with the League, but afterwards opened its gates to the troops of Henry IV., from whom it received the confirmation of its communal privileges and permission to demolish its fortifications. The revocation of the edict of Nantes struck a severe blow at the cloth and iron industries, which had previously been a source of prosperity to the town. In the 18th century there were no fewer than seven monastic buildings in Beaune, besides a Bernardine abbey, a Carthusian convent and an ecclesiastical college.

BEAUREGARD, MARQUIS DE (c. 1772-?), French adventurer, the son of a poor vinegrower named Leuthaud, was born about 1772. He received the name Beauregard from a nobleman in whose service he was engaged as valet. On the outbreak of the revolution, this nobleman converted all his fortune into gold, and entrusting the bag containing the cash to his valet, fled to the frontier. For security's sake master and man took different roads, but Beauregard turned back with the money to Paris. By speculations in provisions and military equipments under

the Directorate he amassed a considerable fortune, and styling himself the marquis de Beauregard, purchased a splendid mansion and began giving magnificent entertainments. Detected at the height of his success, the impostor was arrested and condemned to four years in irons and to be branded. He soon escaped from prison, and had the audacity to reappear in Paris and start his old life afresh. After a short time, however, he disappeared again, and is supposed to have committed suicide. It is probable that most of the information available about him is a blend of fact and fiction.

BEAUREGARD, PIERRE GUSTAVE TOUTANT (1818-1893), American soldier, was born near New Orleans, Louisiana, on the 28th of May 1818. At the United States military academy he graduated second in his class in July 1838, and was appointed lieutenant of engineers. In the Mexican War he distinguished himself in siege operations at Vera Cruz, and took part in all the battles around Mexico, being wounded at Chapultepec, and receiving the brevets of captain and major. In 1853 he became captain and was in charge of fortification and other engineer works of various points, on the Gulf coast from 1853 to 1860. He had just been appointed superintendent of West Point when the secession of his state brought about his resignation (20th February 1861). As a brigadier-general of the new Confederate army he directed the bombardment of Fort Sumter, S.C. As the commander of the Southern "Army of the Potomac" he opposed McDowell's advance to Bull Run, and during the battle was second in command under Joseph E. Johnston, who had joined him on the previous evening. He was one of the five full generals appointed in August 1861, and in 1862 was second in command under Sidney Johnston on the Tennessee. After Johnston's death he directed the battle of Shiloh, subsequent to which he retired to Corinth. This place he defended against the united armies under Halleck, until the end of May 1862, when he retreated in good order to the southward. His health now failing, he was employed in less active work. He defended Charleston against the Union forces from September 1862 to April 1864. In May 1864 he fought a severe and eventually successful battle at Drury's Bluff against General Butler and the Army of the James. Later in the year he endeavoured to gather troops wherewith to oppose Sherman's advance from Atlanta, and eventually surrendered with Johnston's forces in April 1865. After the war he engaged in railway management, became adjutant-general of his state and managed the Louisiana lottery. He declined high commands which were offered to him in the Rumanian and later in the Egyptian armies. General Beauregard died in New Orleans on the 20th of February 1893. He was the author of *Principles and Maxims of the Art of War* (Charleston, 1863); *Report on the Defence of Charleston* (Richmond, 1864).

See Alfred Roman, *Military Operations of General Beauregard* (New York, 1883).

BEAUSOBRE, ISAAC DE (1659-1738), French Protestant divine, was born at Niort on the 8th of March 1659. After studying theology at the Protestant academy of Saumur, he was ordained at the age of twenty-two, becoming pastor at Châtillon-sur-Indre. After the revocation of the edict of Nantes he fled to Rotterdam (November 1685), and in 1686 was appointed chaplain to the princess of Dessau, Henrietta Catherine of Orange. In 1693, on the death of the prince of Dessau, he went to Berlin and became chaplain to the court at Oranienbaum, and in 1695 pastor of the French church at Berlin. He became court preacher, counsellor of the Consistory, director of the *Maison française*, a hospice for French people, inspector of the French gymnasium and superintendent of all the French churches in Brandenburg. He died on the 5th of June 1738. He had strong sense with profound erudition, was one of the best writers of his time and an excellent preacher.

BEAUVAIS, a town of northern France, capital of the department of Oise, 49 m. N. by W. of Paris, on the Northern railway. Pop. (1906) 17,045. Beauvais lies at the foot of wooded hills on the left bank of the Thérain at its confluence with the Avelon. Its ancient ramparts have been destroyed, and it is now surrounded

by boulevards, outside which run branches of the Thérain. In addition, there are spacious promenades in the north-east of the town. Its cathedral of St Pierre, in some respects the most daring achievement of Gothic architecture, consists only of a transept and choir with apse and seven apse-chapels. The vaulting in the interior exceeds 150 ft. in height. The small Romanesque church of the 10th century known as the Basse-Œuvre occupies the site destined for the nave. Begun in 1247, the work was interrupted in 1284 by the collapse of the vaulting of the choir, in 1573 by the fall of a too ambitious central tower, after which little addition was made. The transept was built from 1500 to 1548. Its façades, especially that on the south, exhibit all the richness of the late Gothic style. The carved wooden doors of both the north and the south portals are masterpieces respectively of Gothic and Renaissance workmanship. The church possesses an elaborate astronomical clock (1866) and tapestries of the 15th and 17th centuries; but its chief artistic treasures are stained glass windows of the 13th, 14th and 16th centuries, the most beautiful of them from the hand of the Renaissance artist, Engrand Le Prince, a native of Beauvais. To him also is due some of the stained glass in St. Étienne, the second church of the town, and an interesting example of the transition stage between the Romanesque and Gothic styles.

In the Place de l'Hôtel de Ville and in the old streets near the cathedral there are several houses dating from the 12th to the 16th centuries. The hôtel de ville, close to which stands the statue of Jeanne Hachette (see below), was built in 1752. The episcopal palace, now used as a court-house, was built in the 16th century, partly upon the Gallo-Roman fortifications. The industry of Beauvais comprises, besides the state manufacture of tapestry, which dates from 1664, the manufacture of various kinds of cotton and woollen goods, brushes, toys, boots and shoes, and bricks and tiles. Market-gardening flourishes in the vicinity and an extensive trade is carried on in grain and wine.

The town is the seat of a bishop, a prefect and a court of assizes; it has tribunals of first instance and of commerce, together with a chamber of commerce, a branch of the Bank of France, a higher ecclesiastical seminary, a lycée and training colleges.

Beauvais was known to the Romans as *Caesaremagus*, and took its present name from the Gallic tribe of the Bellovaci, whose capital it was. In the 9th century it became a countship, which about 1013 passed to the bishops of Beauvais, who ultimately became peers of France. In 1346 the town had to defend itself against the English, who again besieged it in 1433. The siege which it suffered in 1472 at the hands of the duke of Burgundy was rendered famous by the heroism of the women, under the leadership of Jeanne Hachette, whose memory is still celebrated by a procession on the 14th of October (the feast of St Angadrême), in which the women take precedence of the men.

See V. Lhuillier, *Choses du vieux Beauvais et du Beauvaisis* (1896).

BEAUVILLIER, the name of a very ancient French family belonging to the country around Chartres, members of which are found filling court offices from the 15th century onward. For Charles de Beauvillier, gentleman of the chamber to the king, governor and *bailli* of Blois, the estate of Saint Aignan was created a countship in 1537. François de Beauvillier, comte de Saint Aignan, after having been through the campaigns in Germany (1634-1635), Franche-Comté (1636), and Flanders (1637), was sent to the Bastille in consequence of his having lost the battle of Thionville in 1640. In reward for his devotion to the court party during the Fronde he obtained many signal favours, and Saint Aignan was raised to a duchy in the peerage of France (*duché-pairie*) in 1663. His son Paul, called the *duc de Beauvillier*, was several times ambassador to England; he became chief of the council of finance in 1685, governor of the dukes of Burgundy, Anjou and Berry from 1689 to 1693, minister of state in 1691, and grandee of Spain in 1701. He married a daughter of Colbert. Paul Hippolyte de Beauvillier, comte de Montrésor, afterwards *duc de Saint Aignan*, was ambassador at Madrid from 1715 to 1718 and at Rome in 1731, and a member of the council of regency in 1719. (M. P. *)

BEAUVOIR, ROGER DE, the *nom de plume* of EUGÈNE AUGUSTE ROGER DE BULLY (1806–1866), French writer, who was born on the 8th of November 1806 in Paris. He was the son and nephew of public officials who did not approve his literary inclinations, and it was at their request that he wrote over the signature of Roger de Beauvoir. A good-looking young fellow, of independent means, an indefatigable *viveur*, he astonished all Paris with his ostentatious luxury and his adventures, while his romantic novels gave him a more serious if not durable reputation. Among the best of them are *L'École de Cluny ou le Sophisme* (1832), which is said to have furnished Alexandre Dumas and Theodore Gaillardet (1808–1882) with the idea of the *Tour de Nesle*, and *Le Chevalier de Saint Georges* (1840). He had married in 1847 an actress, Eléonore Léocadie Doze (1822–1859), from whom he obtained a judicial separation a year or two later after a long and notorious trial, following which his mother-in-law got him imprisoned for three months and fined 500 francs for a satirical poem, *Mon Procès* (1849). Ruined by extravagance and tied to his chair by gout, he spent the last years of his life in retirement, and died in Paris on the 27th of August 1866.

BEAUX, CECILIA (1863–), American portrait-painter, was born in Philadelphia, Pennsylvania, where she became a pupil of William Sartain. But her real art training was obtained in Paris, where she started in the atelier Julian and had the coaching of painters like Robert-Fleury, Bouguereau and Dagnan Bouveret. In 1890 she exhibited at the Paris Exposition. Returning to Philadelphia, Miss Beaux obtained in 1893 the gold medal of the Philadelphia Art Club, and also the Dodge prize at the New York National Academy, and later various other distinctions. She became a member of the National Academy of Design, New York, in 1902. Among her portraits are those of Bishop-Coadjutor Greer (exhibited at the Salon in 1896); Mrs Roosevelt and her daughter; and Mrs Larz Anderson. Her "Dorothea and Francesca," and "Ernesta and her Little Brother," are good examples of her skill in painting children.

BEAVER,¹ the largest European aquatic representative of the mammalian order RODENTIA (*q.v.*), easily recognized by its large trowel-like, scaly tail, which is expanded in the horizontal direction. The true beaver (*Castor fiber*) is a native of Europe and northern Asia, but it is represented in North America by a closely-allied species (*C. canadensis*), chiefly distinguished by the form of the nasal bones of the skull. Beavers are nearly allied to the squirrels (*Sciuridae*), agreeing in certain structural peculiarities of the lower jaw and skull. In the *Sciuridae* the two main bones (tibia and fibula) of the lower half of the leg are quite separate, the tail is round and hairy, and the habits are arboreal and terrestrial. In the beavers or *Castoridae* these bones are in close contact at their lower ends, the tail is depressed, expanded and scaly, and the habits are aquatic. Beavers have webbed hind-feet, and the claw of the second hind-toe double. In length beavers—European and American—measure about 2 ft. exclusive of the tail, which is about 10 in. long. They are covered with a fur to which they owe their chief commercial value; this consists of two kinds of hair—the one close-set, silky and of a greyish colour, the other much coarser and longer, and of a reddish brown. Beavers are essentially aquatic in their habits, never travelling by land unless driven by necessity. Formerly common in England, the European beaver has not only been exterminated there, but likewise in most of the countries of the continent, although a few remain on the Elbe, the Rhone and in parts of Scandinavia. The American species is also greatly diminished in numbers from incessant pursuit for the sake of its valuable fur. Beavers are sociable animals, living in streams, where, so as to render the water of sufficient depth, they build dams of mud and of the stems and boughs of trees felled by their powerful incisor teeth. In the neighbourhood they make their "lodges," which are roomy chambers, with the entrance beneath the water. The mud is

plastered down by the fore-feet, and not, as often supposed, by the tail, which is employed solely as a rudder. They are mainly nocturnal, and subsist chiefly on bark and twigs or the roots of water plants. The dam differs in shape according to the nature of particular localities. Where the water has little motion it is almost straight; where the current is considerable it is curved, with its convexity towards the stream. The materials made use of are driftwood, green willows, birch and poplars; also mud and stones intermixed in such a manner as contributes to the strength of the dam; but there is no particular method observed, except that the work is carried on with a regular sweep, and that all the parts are made of equal strength. "In places," writes Hearne, "which have been long frequented by beavers undisturbed, their dams, by frequent repairing, become a solid bank, capable of resisting a great force both of ice and water; and as the willow, poplar and birch generally take root and shoot up, they by degrees form a kind of regular planted hedge, which I have seen in some places so tall that birds have built their nests among the branches." Their houses are formed of the same materials as the dams, with little order or regularity of structure, and seldom contain more than four old, and six or eight young beavers. It not unfrequently happens that some of the larger houses have one or more partitions, but these are only posts of the main building left by the bulldozers to support the roof, for the apartments have usually no communication with each other except by water. The beavers carry the mud and stones with their fore-paws and the timber between their teeth. They always work in the night and with great expedition. They cover their houses late every autumn with fresh mud, which, freezing when the frost sets in, becomes almost as hard as stone, so that neither wolves nor wolverines can disturb their repose.

The favourite food of the American beaver is the water-lily (*Nuphar luteum*), which bears a resemblance to a cabbage-stalk, and grows at the bottom of lakes and rivers. Beavers also gnaw the bark of birch, poplar and willow trees; but during the summer a more varied herbage, with the addition of berries, is consumed. When the ice breaks up in spring they always leave their embankments, and rove about until a little before the fall of the leaf, when they return to their old habitations, and lay in their winter stock of wood. They seldom begin to repair the houses till the frost sets in, and never finish the outer coating till the cold becomes severe. When they erect a new habitation they fell the wood early in summer, but seldom begin building till towards the end of August.

The flesh of the American beaver is eaten by the Indians, and when roasted in the skin is esteemed a delicacy and is said to taste like pork. *Castoreum* is a substance contained in two pear-shaped pouches situated near the organs of reproduction, of a bitter taste and slightly foetid odour, at one time largely employed as a medicine, but now used only in perfumery.

Fossil remains of beavers are found in the peat and other superficial deposits of England and the continent of Europe; while in the Pleistocene formations of England and Siberia occur remains of a giant extinct beaver, *Trogontherium cuvieri*, representing a genus by itself.

For an account of beavers in Norway see R. Collett, in the *Bergens Museums Aarbog* for 1897. See also R. T. Martin, *Castorologia, a History and Traditions of the Canadian Beaver* (London, 1892).

(R. L. *)

BEAVER (from Fr. *bavière*, a child's bib, from *bave*, saliva), the lower part of the helmet, fixed to the neck-armor to protect the face and cheeks; properly it moved upwards, as the visor moved down, but the word is sometimes used to include the visor. The right form of the word, "baver," has been altered from a confusion with "beaver," a hat made of beaver-fur or a silk imitation, also, in slang, called a "castor," from the zoological name of the beaver family.

BEAVER DAM, a city of Dodge county, Wisconsin, U.S.A., situated in the S.E. part of the state, 63 m. N.W. of Milwaukee, on Beaver Lake, which is 9 m. long and 3 m. wide. Pop. (1890) 4222; (1900) 5128, of whom 1023 were foreign-born; (1905) 5615; (1910) 6758. Most of the population is of German

¹ The word is descended from the Aryan name of the animal, cf. Sanskrit *babhrās*, brown, the great ichneumon, *Lat. fiber*, Ger. *Biber*, Swed. *bäfer*, Russ. *bobr*; the root *bhrū* has given "brown," and, through Romance, "bronze" and "burnish."

descent. Beaver Dam is served by the Chicago, Milwaukee & St Paul railway. The city is a summer resort, has a public library, and is the seat of Wayland Academy (1855, Baptist), a co-educational preparatory school affiliated with the university of Chicago. Beaver Dam is situated in the midst of a fine farming country; it has a good water-power derived from Beaver Lake, and among its manufactures are woollen and cotton goods, malleable iron, foundry products, gasoline engines, agricultural implements, stoves and beer. The city was first settled about 1841, and was incorporated in 1856.

BEAVER FALLS, a borough of Beaver county, Pennsylvania, U.S.A., on Beaver river, about $\frac{3}{4}$ m. from its confluence with the Ohio, opposite New Brighton, and about 32 m. N.W. of Pittsburg. Pop. (1800) 9735; (1900) 10,054, of whom 1554 were foreign-born; (1910, census, 12,101. The borough is served by the Pennsylvania and the Pittsburg & Lake Erie railways. It is built for the most part on a plateau about 50 ft. above the river, hemmed in on either side by hills that rise abruptly, especially on the W., to a height of more than 200 ft. Bituminous coal, natural gas and oil abound in the vicinity; the river provides excellent water-power; the borough is a manufacturing centre of considerable importance, its products including iron and steel bridges, boilers, steam drills, carriages, saws, files, axes, shovels, wire netting, stoves, glass-ware, scales, chemicals, pottery, cork, decorative tile, bricks and typewriters. In 1905 the city's factory products were valued at \$4,907,536. Geneva College (Reformed Presbyterian, co-educational), established in 1849 at Northwood, Logan county, Ohio, was removed in 1880 to the borough of College Hill (pop. in 1900, 890), 1 m. N. of Beaver Falls; it has a preparatory and a collegiate department, departments of music, oratory and art, and a physical department, and in 1907-1908 had 13 instructors and 235 students. Beaver Falls was first settled in 1801; was laid out as a town and named Brighton in 1806; received its present name a few years later; and in 1868 was incorporated as a borough.

BEAWAR, or **NAYANAGAR**, a town of British India, the administrative headquarters of Merwara district in Ajmere-Merwara. It is 33 m. from Ajmere. Pop. (1901) 21,928. It is an important centre of trade, especially in raw cotton, and has cotton presses and the Krishna cotton mills. It was founded by Colonel Dixon in 1835.

BEBEL, FERDINAND AUGUST (1840—), German socialist, was born at Cologne on the 22nd of February 1840; he became a turner and worked at Leipzig. Here he took a prominent part in the workmen's movement and in the association of working men which had been founded under the influence of Schultz-Delitzsch; at first an opponent of socialism, he came under the influence of Liebknecht, and after 1865 he was a confirmed advocate of socialism. With Liebknecht he belonged to the branch of the socialists which was in close correspondence with Karl Marx and the International, and refused to accept the leadership of Schweitzer, who had attempted to carry on the work after Lassalle's death. He was one of those who supported a vote of want of confidence in Schweitzer at the Eisenach conference in 1867, from which his party was generally known as "the Eisenacher." In this year he was elected a member of the North German Reichstag for a Saxon constituency, and, with an interval from 1881 to 1883, remained a member of the German parliament. His great organizing talent and oratorical power quickly made him one of the leaders of the socialists and their chief spokesman in parliament. In 1870 he and Liebknecht were the only members who did not vote the extraordinary subsidy required for the war with France; the followers of Lassalle, on the other hand, voted for the government proposals. He was the only Socialist who was elected to the Reichstag in 1871, but he used his position to protest against the annexation of Alsace-Lorraine and to express his full sympathy with the Paris Commune. Bismarck afterwards said that this speech of Bebel's was a "ray of light," showing him that Socialism was an enemy to be fought against and crushed; and in 1872 Bebel was accused in Brunswick of preparation for high treason, and condemned to two years' imprisonment in a fortress, and, for

insulting the German emperor, to nine months' ordinary imprisonment. After his release he helped to organize, at the congress of Gotha, the united party of Social Democrats, which had been formed during his imprisonment. After the passing of the Socialist Law he continued to show great activity in the debates of the Reichstag, and was also elected a member of the Saxon parliament; when the state of siege was proclaimed in Leipzig he was expelled from the city, and in 1886 condemned to nine months' imprisonment for taking part in a secret society. Although the rules of the Social Democratic party do not recognize a leader or president, Bebel subsequently became by far the most influential member of the party. In the party meetings of 1890 and 1891 his policy was severely attacked, first by the extremists, the "young" Socialists from Berlin, who wished to abandon parliamentary action; against these Bebel won a complete victory. On the other side he was involved in a quarrel with Volmar and his school, who desired to put aside from immediate consideration the complete attainment of the Socialist ideal, and proposed that the party should aim at bringing about, not a complete overthrow of society, but a gradual amelioration. This conflict of tendencies continued, and Bebel came to be regarded as the chief exponent of the traditional views of the orthodox Marxist party. He was exposed to some natural ridicule on the ground that the "Kladderadatsch," which he often spoke of as imminent, failed to make its appearance. On the other hand, though a strong opponent of militarism, he publicly stated that foreign nations attacking Germany must not expect the help or the neutrality of the Social Democrats. His book, *Die Frau und der Socialismus* (1893), which went through many editions and contained an attack on the institution of marriage, identified him with the most extreme forms of Socialism.

See also Mehring, *Geschichte der deutschen Social-Demokratie* (Stuttgart, 1898); *Reports of the Annual Meetings of the Social Democratic Party*, Berlin Vorwärts Publishing Company (from 1890); B. Russell, *German Social-Democracy* (London, 1897). (J. W. H.E.)

BECCAFICO (Ital. for "fig-pecker"), a small migratory bird of the warbler (*Sylviidae*) family, which frequents fig-trees and vineyards, and, when fattened, is considered a great delicacy.

BECCAFUMI, DOMENICO DI PACE (1486-1551), Italian painter, of the school of Siena. In the early days of the Tuscan republics Siena had been in artistic genius, and almost in political importance, the rival of Florence. But after the great plague in 1348 the city declined; and though her population always comprised an immense number of skilled artists and artificers, yet her school did not share in the general progress of Italy in the 15th century. About the year 1500, indeed, Siena had no native artists of the first importance; and her public and private commissions were often given to natives of other cities. But after the uncovering of the works of Raphael and Michelangelo at Rome in 1508, all the schools of Italy were stirred with the desire of imitating them. Among these accomplished men who now, without the mind and inspiration of Raphael or Michelangelo, mastered a great deal of their manner, and initiated the decadence of Italian art, several of the most accomplished arose in the school of Siena. Among these was Domenico, the son of a peasant, one Giacomo di Pace, who worked on the estate of a well-to-do citizen named Lorenzo Beccafumi. Seeing some signs of a talent for drawing in his labourer's son, Lorenzo Beccafumi took the boy into his service and presently adopted him, causing him to learn painting from masters of the city. Known afterwards as Domenico Beccafumi, or earlier as Il Mecarino (from the name of a poor artist with whom he studied), the peasant's son soon gave proof of extraordinary industry and talent. In 1509 he went to Rome and steeped himself in the manner of the great men who had just done their first work in the Vatican. Returning to his native town, Beccafumi quickly gained employment and a reputation second only to Sodoma. He painted a vast number both of religious pieces for churches and of mythological decorations for private patrons. But the work by which he will longest be remembered is that which he did for the celebrated pavement of the cathedral of Siena. For a hundred and fifty years the best artists of the state had been engaged

laying down this pavement with vast designs in *commesso* work, — white marble, that is, engraved with the outlines of the subject in black, and having borders inlaid with flat patterns in many colours. From the year 1517 to 1544 Beccafumi was engaged in continuing this pavement. He made very ingenious improvements in the technical processes employed, and laid down multitudinous scenes from the stories of Ahab and Elijah, of Melchisedec, of Abraham and of Moses. These are not so interesting as the simpler work of the earlier schools, but are much more celebrated and more jealously guarded. Such was their fame that the agents of Charles I. of England, at the time when he was collecting for Whitehall, went to Siena expressly to try and purchase the original cartoons. But their owner would not part with them, and they are now in the Siena Academy and elsewhere. The subjects have been engraved on wood, by the hand, as it seems, of Beccafumi himself, who at one time or another essayed almost every branch of fine art. He made a triumphal arch and an immense mechanical horse for the procession of the emperor Charles V. on his entry into Siena. In his later days, being a solitary liver and continually at work, he is said to have accelerated his death by over-exertion upon the proceeds of bronze-casting.

BECCARIA, GIOVANNI BATTISTA (1716–1781), Italian physicist, was born at Mondovì on the 3rd of October 1716, and entered the religious order of the Pious Schools in 1732. He became professor of experimental physics, first at Palermo and then at Rome, and was appointed to a similar situation at Turin in 1748. He was afterwards made tutor to the young princes de Chablais and de Carignan, and continued to reside principally at Turin during the remainder of his life. In May 1755 he was elected a fellow of the Royal Society of London, and published several papers on electrical subjects in the *Phil. Trans.* He died at Turin on the 27th of May 1781. Beccaria did much, in the way both of experiment and exposition, to spread a knowledge of the electrical researches of Franklin and others. His principal work was the treatise *Dell' Elettricismo Naturale ed Artificiale* (1753), which was translated into English in 1776.

BECCARIA-BONESANA, CESARE, MARCHESE DE (1735–1794), Italian publicist, was born at Milan on the 15th of March 1735. He was educated in the Jesuit college at Parma, and showed at first a great aptitude for mathematics. The study of Montesquieu seems to have directed his attention towards economic questions; and his first publication (1762) was a tract on the derangement of the currency in the Milanese states, with a proposal for its remedy. Shortly after, in conjunction with his friends the Verris, he formed a literary society, and began to publish a small journal, in imitation of the *Spectator*, called *Il Caffè*. In 1764 he published his brief but justly celebrated treatise *Dei Delitti e delle Pene* ("On Crimes and Punishments"). The weighty reasonings of this work were expounded with all the additional force of a clear and animated style. It pointed out distinctly and temperately the grounds of the right of punishment, and from these principles deduced certain propositions as to the nature and amount of punishment which should be inflicted for any crime. The book had a surprising success. Within eighteen months it passed through six editions. It was translated into French by Morellet in 1766, and published with an anonymous commentary by Voltaire. An English translation appeared in 1768 and it was translated into several other languages. Many of the reforms in the penal codes of the principal European nations are traceable to Beccaria's treatise. In November 1768 he was appointed to the chair of law and economy, which had been founded expressly for him at the Palatine college of Milan. His lectures on political economy, which are based on strict utilitarian principles, are in marked accordance with the theories of the English school of economists. They are published in the collection of Italian writers on political economy (*Scrittori Classici Italiani di Economia politica*, vols. xi. and xii.). In 1771 Beccaria was made a member of the supreme economic council; and in 1791 he was appointed one of the board for the reform of the judicial code. In this post his labours were of very great value. He died at Milan on the 28th of November 1794.

BECCLES, a market town and municipal borough, in the Lowestoft parliamentary division of Suffolk, England; on the right bank of the river Waveney, 100 m. N.E. from London by the Great Eastern railway. Pop. (1901) 6898. It has a pleasant, well-wooded site overlooking the flat lands bordering the Waveney. The church of St Michael, wholly Perpendicular, is a fine example of the style, having an ornate south porch of two storeys and a detached bell tower. There are a grammar school (1712), and boys' school and free school on the foundation of Sir John Leman (1631). Rose Hall, in the vicinity, is a moated manor of brick, of the 16th century. Printing works, malting, brick and tile, and agricultural implement works are the chief industries. Beccles was incorporated in 1584. It is governed by a mayor, 4 aldermen and 12 councillors. Area, 2017 acres.

BECCERA, GASPAR (1520–1570), Spanish painter and sculptor, was born at Baeza in Andalusia. He studied at Rome, it is said under Michelangelo, and assisted Vasari in painting the hall of the Concilleria. He also contributed to the anatomical plates of Valverde. After his return to Spain he was extensively employed by Philip II., and decorated many of the rooms in the palace at Madrid with frescoes. He also painted altar-pieces for several of the churches, most of which have been destroyed. His fame as a sculptor almost surpassed that as a painter. His best work was a magnificent figure of the Virgin, which was destroyed during the French war. He became court painter at Madrid in 1563, and played a prominent part in the establishment of the fine arts in Spain.

BÈCHE-DE-MER (sometimes explained as "sea-spade," from the shape of the prepared article, but more probably from the Port. *bicho*, a worm or grub), or **TREPANG** (Malay, *tripang*), an important food luxury among the Chinese and other Eastern peoples, connected with the production of which considerable trade exists in the Eastern Archipelago and the coasts of New Guinea, and also in California. It consists of several species of echinoderms, generally referred to the genus *Holothuria*, especially *H. edulis*. The creatures, which exist on coral reefs, have bodies from 6 to 15 in. long, shaped like a cucumber, hence their name of "sea-cucumbers." The skin is sometimes covered with spicules or prickles, and sometimes quite smooth, and with or without "teats" or ambulacral feet disposed in rows. Five varieties are recognized in the commerce of the Pacific Islands, the finest of which is the "brown with teats." The large black come next in value, followed by the small black, the red-bellied and the white. They are used in the gelatinous soups which form an important article of food in China. They are prepared for use by being boiled for about twenty minutes, and then dried first in the sun and afterwards over a fire, so that they are slightly smoked.

BECHER, JOHANN JOACHIM (1635–1682), German chemist, physician, scholar and adventurer, was born at Spire in 1635. His father, a Lutheran minister, died while he was yet a child, leaving a widow and three children. The mother married again; the stepfather spent the tiny patrimony of the children; and at the age of thirteen Becher found himself responsible not only for his own support but also for that of his mother and brothers. He learned and practised several small handicrafts, and devoting his nights to study of the most miscellaneous description earned a pittance by teaching. In 1654, at the age of nineteen, he published an edition of Salzhall's *Tractatus de lapide trismegisto*; his *Metalurgia* followed in 1660; and the next year appeared his *Character pro notitia linguarum universalis*, in which he gives 10,000 words for use as a universal language. In 1663 he published his *Oedipum Chemicum* and a book on animals, plants and minerals (*Thier- Kräuter- und Bergbuch*). At the same time he was full of schemes, practical and unpractical. He negotiated with the elector palatine for the establishment of factories at Mannheim; suggested to the elector of Bavaria the creation of German colonies in Guiana and the West Indies; and brought down upon himself the wrath of the Munich merchants by planning a government monopoly of cloth manufacture and of trade. He fled from Munich, but found a ready welcome elsewhere. In 1666 he was appointed teacher of

medicine at Mainz and body-physician to the archbishop-elect; and the same year he was made councillor of commerce (*Commerzienrat*) at Vienna, where he had gained the powerful support of Albrecht, Count Zinzendorf, prime minister and grand chamberlain of the emperor Leopold I. Sent by the emperor on a mission to Holland, he there wrote in ten days his *Methodus Didactica*, which was followed by the *Regeln der Christlichen Bundesgenossenschaft* and the *Politischer Discurs vom Auf- und Abblühen der Südde*. In 1669 he published his *Physica subterranea*, and the same year was engaged with the count of Hanau in a scheme for settling a large territory between the Orinoco and the Amazon. Meanwhile he had been appointed physician to the elector of Bavaria; but in 1670 he was again in Vienna advising on the establishment of a silk factory and propounding schemes for a great company to trade with the Low Countries and for a canal to unite the Rhine and Danube. He then returned to Bavaria, and his absence bringing him into ill odour at Vienna, he complained of the incompetence of the council of commerce and dedicated a tract on trade (*Commerciën-Tractat*) to the emperor Leopold. His *Psychosophia* followed, and "An invitation to a psychological community" (*Einladung zu einer psychologischen Societät*), for the realization of which Duke Gustavus Adolphus of Mcklenburg-Gustrow (d. 1695) offered him in 1674 a site in his duchy. The plan came to nothing, and next year Becher was again busy at Vienna, trying to transmute Danube sand into gold, and writing his *Theses chemicæ veritatem transmutationis metallorum evincentes*. For some reason he incurred the disfavour of Zinzendorf and fled to Holland, where with the aid of the government he continued his experiments. Pursued even there by the resentment of his former patron, he crossed to England, whence he visited the mines of Scotland at the request of Prince Rupert. He afterwards went for the same purpose to Cornwall, where he spent a year. At the beginning of 1680 he presented a paper to the Royal Society, *De nova temporis dimetiendi ratione et accurata horologiorum constructione*, in which he attempted to deprive Huygens of the honour of applying the pendulum to the measurement of time. The views of Becher on the composition of substances mark little essential advance on those of the two preceding centuries, and the three elements or principles of salt, mercury and sulphur reappear as the vitrifiable, the mercurial and the combustible earths. When a substance was burnt he supposed that the last of these, the *terra pinguis*, was liberated, and this conception is the basis on which G. E. Stahl founded his doctrine of "phlogiston." His ideas and experiments on the nature of minerals and other substances are voluminously set forth in his *Physica Subterranea* (Frankfort, 1669); an edition of this, published at Leipzig in 1703, contains two supplements (*Experimentum chymicum novum* and *Demonstratio Philosophica*), proving the truth and possibility of transmuting metals, *Experimentum novum ac curiosum de minera arenaria perpelua*, the paper on timpepieces already mentioned and also *Specimen Becherianum*, a summary of his doctrines by Stahl, who in the preface acknowledges indebtedness to him in the words *Becheriano sunt quæ profero*. At Falmouth he wrote his *Laboratorium portabile* and at Truro the *Alphabetum minerale*. In 1682 he returned to London, where he wrote the *Chemischer Glückshafen oder grosse Concordanz und Collection von 1500 Processen* and died in October of the same year.

BECHUANA, a South African people, forming a branch of the great Bantu-Negroid family. They occupy not only Bechuana-land, to which they have given their name, and Basutoland, but are the most numerous native race in the Orange River Colony and in the western and northern districts of the Transvaal. It seems certain that they reached their present home later than the Zulu-Xosa [Kaffir] peoples who came down the east coast of the continent, but it is probable that they started on their southward journey before the latter. It would appear that the forerunners of the movement were the Kalahari and Balala, who were subsequently reduced to the condition of serfs by the later arrivals, and who by intermingling to a certain extent with the aborigines gave rise to the "Kalahari Bushmen" (see

KALAHARI DESERT). The Bechuana family may be classed in two great divisions, the western or Bechuana proper, and the eastern or Basuto. The Bechuana proper consist of a large number of tribes, whose early history is extremely confused and involved owing to continual inter-tribal wars and migrations, during which many tribes were practically annihilated. Further confusion was produced by subsequent marauding expeditions by the coast "Kaffirs." An ingenious attempt to disentangle the highly complicated tribal movements which took place in the early 19th century may be found in Stow's *Native Races of South Africa*. One migration of particular interest calls for mention. In the early part of the 19th century a number of Basuto, led by the chief Sebituane, crossed the Zambezi near the Victoria Falls, and, under the name Makololo, established a supremacy over the Barotse and neighbouring tribes on the upper portion of the river, imposing their language on the conquered peoples. After the death of Skeketu, Sebituane's successor, the vassal tribes arose and exterminated their conquerors. Only a few escaped, whom Skeketu had sent with David Livingstone to the coast. These established themselves to the south of Lake Nyasa, where they are still to be found. Sesuto speech, however, still prevails in Barotse-land. The chief Bechuana tribes were the Batlapin and Barolong (the last including the Baratlou, Bataung, Barapulana and Baseleka), together with the great Bakueno or Bakone people (including the Bahurutsi, Batlaru, Bamangwato, Batauana, Bangwaketse and Bakueno). The clans representing the southern Bakueno were in comparatively recent times welded together to form the Basuto nation, of which the founder was the chief Moshesh (see BASUTOLAND). The Basuto have been not only influenced in certain cultural details (e.g. the form of their huts) by the neighbouring Zulu-Xosa [Kaffir] peoples, but have moreover received an infusion of their blood which has improved their physique. They are good riders and make considerable use of their horses in war and the chase.

The Bechuana, though not so tall as Kaffirs, average 5 ft. 6 in. in stature; they are of slender build and their musculature is but moderately developed except where a Kaffir strain is found. Their skin is of a reddish-brown or bronze colour, and their features are fairly regular, though in all cases coarser than those of Europeans. One of their chief peculiarities lies in the fact that each tribe respects (usually) a particular animal, which the members of the tribe may not eat, and the killing of which, if necessary, must be accompanied by profuse apologies and followed by subsequent purification. Many of the tribes take their name from their *siboko*, as the animal in question is called; e.g. the Batlapin, "they of the fish"; Bakueno, "they of the crocodile." The *siboko* of the Barolong, who as a tribe are accomplished smiths, is not an animal but the metal iron; other tribes have adopted as their particular emblem respectively the sun, rain, dew, &c. Certain ceremonies are performed in honour of the tribal emblem, hence an inquiry as to the tribe of an individual is put in the form "What do you dance?" In certain tribes the old and feeble and the sickly children were killed, and albinos and the deaf and dumb exposed; those born blind were strangled, and if a mother died in childbirth the infant was buried alive in the same grave. With the extension of British authority these practices were prohibited. Circumcision is universally practised, though there is no fixed age for it. It is performed at puberty, when the boys are secluded for a period in the bush. The operation is accompanied by whipping and even tortures. Girls at puberty must undergo trials of endurance, e.g. the holding of a bar of heated iron without crying out. The Bechuana inhabit, for the most part, towns of considerable size, containing from 5000 to 40,000. Politically they live under a tribal despotism limited by a council of elders, the chief seldom exercising his individual authority independently, though the extent of his power naturally depends on his personality. They have their public assemblies, but only when circumstances, chiefly in reference to war, require. These are generally characterized by great freedom of speech, and there is no interruption of the speaker. The chief generally closes the meeting with a long speech, referring to the subjects which each

speaker has either supported or condemned, not forgetting to clear his own character of any imputation. These public assemblies are now, except in Basutoland, of very rare occurrence. The clothing of the men consists of a leather bandage; the women wear a skin apron, reaching to the knee, under which is a fringed girdle. Skin cloaks (*kaross*) are worn by both sexes, with the difference that the male garment is distinguished by a collar. The hair is kept short for the most part; women shave the head, leaving a tuft on the crown which is plastered with fat and earth, and adorned with beads. Beads are worn, and various bracelets of iron, copper and brass.

The Bechuana are mainly an agricultural people, the Bangwaketse and Bakwena excelling as cultivators. Cattle they possess, but these are used chiefly for the purpose of purchasing wives, especially among the Basuto. At the same time they are excellent craftsmen, and show no little skill in smelting and working iron and copper and the preparation of hides and pottery vessels. The most efficient smiths are the Barolong and Bamangwato (the latter were spared by the Matabele chief Umsilikazi on this account); the Bangwaketse excel as potters; the Barolong as wood carvers, and the Bakwena as hut builders. The huts, with the exception of those of the Basuto who have adopted the Kaffir model, are cylindrical, with clay-plastered walls and a conical roof of thatch. In spite of the constant tribal feuds dating from the beginning of the 19th century, the Bechuana cannot be classed as a warlike people, especially when they are compared with the Zulu. Their weapons consist of the throwing assegai, usually barbed, axes, daggers in carved sheaths, and, occasionally, bows and arrows, the last sometimes poisoned. Hide shields of a peculiar shape, resembling a depressed hour-glass, are found except among the Basuto, who use a somewhat different pattern. Hunting usually takes the form of great drives organized in concert, and the game is driven by means of converging fences to a large pitfall or series of pits. Their religious beliefs are very vague; they appear to recognize a somewhat indeterminate spirit of, mainly, evil tendencies, called *Morimo*. The plural form of this word, *Barimo*, is used of the *manes* of dead ancestors, to whom a varying amount of reverence is paid. There is universal belief in charms and witchcraft, and divination by means of dice is common. Witch-doctors, who are supposed to counteract evil magic, play a not insignificant part, and the magician who claims the power of making rain occupies a very important position, as might be expected among an agricultural people inhabiting a country where droughts are not infrequent. They have a great dread of anything connected with death; when an old man is on the point of expiring, a net is thrown over him, and he is dragged from his hut by a hole in the wall, if possible before life is extinct. The dead are buried in a sitting position with their faces to the north, in which direction lies their ancestral home. Under the influence of missionaries, however, large numbers of the Bechuana have become Christianized, and many of the customs mentioned are no longer practised.

Polygamy is the rule, but, except in the case of chiefs, is not found to the same extent as among the Zulu-Xosa (Kaffirs). The woman is purchased from her father, chiefly by means of cattle, though among the western Bechuana other articles are included, many of which become the property of the girl herself. The wives live in separate huts, and the first is given priority over those purchased subsequently. Chastity after marriage is the rule, and adultery and rape are severely punished, as offences against property. Cannibalism is found, but is rare and confined to certain tribes.

The Bechuana language, which belongs to the Bantu linguistic family, is copious, with but few slight dialectic differences, and is free from the Hottentot elements found in the Kaffir and Zulu tongues. The richness of the language may be judged from the fact that, though only oral until reduced to writing by the missionaries, it has sufficed for the translation of the whole Bible.

BIBLIOGRAPHY.—G. W. Stow, *The Native Races of South Africa* (London, 1905); Gustav Fritsch, *Die Eingeborenen Süd-Afrikas*

(Breslau, 1872); Robert Moffat, *Missionary Labours and Scenes in Southern Africa* (1842); David Livingstone, *Missionary Travels and Researches in South Africa* (London, 1857); J. C. MacGregor, *Basuto Traditions* (Cape Town, 1905). (T. A. J.)

BECHUANALAND (a name given from its inhabitants, the Bechuana, *q.v.*), a country of British South Africa occupying the central part of the vast tableland which stretches north to the Zambezi. It is bounded S. by the Orange river, N.E. and E. by Matabeleland, the Transvaal and Orange River Colony, and W. and N. by German South-West Africa. Bechuanaaland geographically and ethnically enjoys almost complete unity, but politically it is divided as follows:—

I. British Bechuanaaland, since 1895 an integral part of Cape Colony. Area, 51,424 sq. m. Pop. (1904) 84,210, of whom 9276 were whites.

II. The Bechuanaaland Protectorate, the northern part of the country, governed on the lines of a British crown colony. Area (estimated), 225,000 sq. m. Pop. (1904) 120,776, of whom Europeans numbered 1004. The natives, in addition to the Bechuana tribes, include some thousands of Bushmen (Masarwa). Administratively attached to the protectorate is the Tati concession, which covers 2500 sq. m. and forms geographically the south-west corner of Matabeleland.

The Griqualand West province of Cape Colony belongs also geographically to Bechuanaaland, and except in the Kimberley diamond mines region is still largely inhabited by Bechuana. (See GRIQUALAND.)

Physical Features.—The average height of the tableland of which Bechuanaaland consists is nearly 4000 ft. The surface is hilly and undulating with a general slope to the west, where the level falls in considerable areas to little over 2000 ft. A large part of the country is covered with grass or shrub, chiefly acacia. There is very little forest land. The western region, the Kalahari Desert (*q.v.*), is mainly arid, with a sandy soil, and is covered in part by dense bush. In the northern region are large marshy depressions, in which the water is often salt. The best known of these depressions, Ngami (*q.v.*), lies to the north-west and is the central point of an inland water system apparently in process of drying up. To the north-east and connected with Ngami by the Botletle river, is the great Makari-Kari salt pan, which also drains a vast extent of territory, receiving in the rainy season a large volume of water. The marsh then becomes a great lake, the water surface stretching beyond the horizon, while in the dry season a mirage is often seen. The permanent marsh land covers a region 60 m. from south to north and from 30 to 60 m. east to west. In the south the rivers, such as the Molopo and the Kuruman, drain towards the Orange. Other streams are tributaries of the Limpopo, which for some distance is the frontier between Bechuanaaland and the Transvaal.

The rivers of Bechuanaaland are, with few exceptions, intermittent or lose themselves in the desert. It is evident, however, from the extent of the beds of these streams and of others now permanently dry, and from remains of ancient forests, that at a former period the country must have been abundantly watered. From the many cattle-folds and walls of defence scattered over the country, and ruins of ancient settlements, it is also evident that at that period stone-dykes were very common. The increasing dryness of the land is partly, perhaps largely, attributable to the cutting down of timber trees both by natives and by whites, and to the custom of annually burning the grass, which is destructive to young wood.

Climate.—The climate is healthy and bracing, except in the lower valleys along the river banks and in the marsh land, where malarial fever is prevalent. Though in great part within the tropics, the heat is counteracted by the dryness of the air. Throughout the year the nights are cool and refreshing; in winter the cold at night is intense. In the western regions the rainfall does not exceed 10 in. in the year; in the east the average rainfall is 26 in. and in places as much as 30 in. The rainy season is the summer months, November to April, but the rains are irregular, and, from the causes already indicated, the rainfall is steadily declining. From December to February violent

thunder and hail storms are experienced. In the winter or dry season there are occasional heavy dust storms.

Geology.—The greater part of Bechuanaland is covered with superficial deposits consisting of the sands of the desert regions of the Kalahari and the alluvium and saliferous marls of the Okavango basin. The oldest rocks, granites, gneisses and schistose sandstones, the Ngami series, rise to the surface in the east and south-east and doubtless immediately underlie much of the sand areas. A sandstone found in the neighbourhood of Palapye is considered to be the equivalent of the Waterberg formation of the Transvaal. The Karroo formation and associate dolerites (*Loalemandelstein*) occur in the same region. A deposit of sinter and a calcareous sandstone, known as the Kalahari Kalk, considered by Dr Passarge to be of Miocene age, overlies a sandstone and curious breccia (*Botlette Schichten*). These deposits are held by Passarge to indicate Tertiary desert conditions, to which the basin of the Zambesi is slowly reverting.

Fauna.—Until towards the close of the 19th century Bechuanaland abounded in big game, and the Kalahari is still the home of the lion, leopard, hyena, jackal, elephant, hippopotamus, rhinoceros, buffalo, antelope of many species, ostrich and even the giraffe. Venomous reptiles, e.g. puff-adders and cobras, are met with, enormous frogs are common, and walking and flying locusts, mosquitoes, white ants, flying beetles, scorpions, spiders and tarantulas are very numerous. The crocodile is found in some of the rivers. Many of the rivers are well stocked with fish. In those containing water in the rainy season only, the fish preserve life when the bed is dry by burrowing deeply in the ooze before it hardens. The principal fish are the baba or cat-fish (*darias* sp.) and the yellow-fish, both of which attain considerable size. Bustards (the great kori and the koorhaan) are common.

Flora.—In the eastern district are stretches of grass land, both sweet and sour veld. In the "bush" are found tufts of tall coarse grass with the space between bare or covered with herbaceous creepers or water-bearing tubers. A common creeper is one bearing a small scarlet cucumber, and a species of water-melon called *tsoma* is also abundant. Of the melon and cucumber there are both bitter and sweet varieties. Besides the grass and the creepers the bush is made up of berry-yielding bushes (some of the bushes being rich in aromatic resinous matter), the wait-a-bit thorn and white thorned mimosa. The indigo and cotton plants grow wild. Among the rare big trees—found chiefly in the north-east—are baobab and palmyra and certain fruit trees, one bearing a pink plum. There are remains of ancient forests consisting of wild olive trees and the camel thorn, near which grows the *ngotwane*, a plant with a profusion of fine, strongly scented yellow flowers.

Chief Towns.—The chief town in southern Bechuanaland, *i.e.* the part incorporated in Cape Colony, is Mafeking (q.v.), near the headwaters of the Molopo river. It is the headquarters of the Barolong tribe, and although within the Cape border is the seat of the administration of the protectorate. Vryburg (pop., 1904, 2085), founded by Boer filibusters in 1882, and Taungs, are towns on the railway between Kimberley and Mafeking. Taungs has some 22,000 inhabitants, being the chief kraal of the Batlapin tribe. About 7 m. south of Vryburg, at Tiger Kloof, is an Industrial Training Institute for natives founded in 1904 by the London Missionary Society. Upington (2508) on the north bank of the Orange, an agricultural centre, is the chief town in Gondonia, the western division of southern Bechuanaland. Kuruman (q.v.) is a native town near the source of the Kuruman river, 85 m. south-west of Vryburg. It has been the scene of missionary labours since the early years of the 19th century. North of Mafeking on the railway to Bulawayo are the small towns of Gaberones and Francistown. The last named is the chief township in the Tati concession, the centre of a gold-mining region, and the most important white settlement in the protectorate. Besides these places there are five or six large native towns, each the headquarters of a distinct tribe. The most important is Serowe, with over 20,000 inhabitants, the capital of the Bamatlwato, founded by the chief Khama in 1903. It is about 250 m. north-north-east of Mafeking, and took the place of

the abandoned capital Palapye, which in its turn had succeeded Shoshong. The chief centre in the western Kalahari is Lehututu.

Agriculture and Trade.—The soil is very fertile, and if properly irrigated would yield abundant harvests. Unirrigated land laid under wheat by the natives is said to yield twelve bushels an acre. Cereals are grown in many of the river valleys. Maize and millet are the chief crops. The wealth of the Bechuana consists principally in their cattle, which they tend with great care, showing a shrewd discrimination in the choice of pasture suited to oxen, sheep and goats. Water can usually be obtained all the year round by sinking wells from 20 to 30 ft. deep. The "sweet veld" is specially suitable to cattle, and the finer shorter grass which succeeds it affords pasturage for sheep.

Gold mines are worked in the Tati district, the first discoveries having been made there in 1864. There are gold-bearing quartz reefs at Madibi, near Mafeking, where mining began in 1906. Diamonds have been found near Vryburg. The existence of coal near Palapye about 60 ft. below the surface has been proved. The coal, however, is not mined, and much of the destruction of timber in southern Bechuanaland was caused by the demand for fuel for Kimberley. Copper ore has been found near Francistown.

Formerly there was a trade in ostrich feathers and ivory; but this has ceased, and the chief trade has since consisted in supplying the natives with European goods in exchange for cattle, hides, the skins and horns of game, firewood and fencing poles, and in forwarding goods north and south. The protectorate is a member of the South African Customs Union. The value of the goods imported into the protectorate in 1906 was £118,322; the value of the exports was £77,736. The sale of spirits to natives is forbidden.

Communications.—As the great highway from Cape Colony to the north, Bechuanaland has been described as the "Suez canal of South Africa." The trunk railway from Cape Town to the Victoria Falls traverses the eastern edge of Bechuanaland throughout its length. The railway enters the country at Fourteen Streams, 695 m. from Cape Town, and at Ramaquabane, 584 m. farther north, crosses into Rhodesia. The old trade route to Bulawayo, which skirts the eastern edge of the Kalahari, is now rarely used. Wagon tracks lead to Ngami, 320 m. N.W. from Palapye Road Station, and to all the settlements. From the scarcity of water on the main routes through the Kalahari these roads are known as "the thirsts"; along some of them wells have been sunk by the administration.

Government.—The protectorate is administered by a resident commissioner, responsible to the high commissioner for South Africa. Legislation is enacted by proclamations in the name of the high commissioner. Order is maintained by a small force of semi-military police recruited in Basutoland and officered by Europeans. Revenue is obtained mostly from customs and a hut tax, while the chief items of expenditure have been the police force and a subsidy of £20,000 per annum towards the cost of the railway, a liability which terminated in the year 1908. The average annual revenue for the five years ending the 31st of March 1906 was £30,074; the average annual expenditure during the same period was £80,114. There is no public debt, the annual deficiency being made good by a grant-in-aid from the imperial exchequer. The tribal organization of the Bechuana is maintained, and native laws and customs, with certain modifications, are upheld.

History.—Bechuanaland was visited by Europeans towards the close of the 18th century. The generally peaceful disposition of the tribes rendered the opening up of the country comparatively easy. The first regular expedition to penetrate far inland was in 1801–1802, when John (afterwards Sir John) Truter, of the Cape judicial bench, and William Somerville—an army physician and afterwards husband of Mary Somerville—were sent to the Bechuana tribes to buy cattle. The London Missionary Society established stations in what is now Griqualand West in 1803, and in 1818 the station of Kuruman, in Bechuanaland proper, was founded. In the meantime, M.H.K. Lichtenstein (1804) and W. J. Burchell (1811–1812), both distinguished naturalists, and other explorers, had made familiar the general characteristics of the southern part of the

country. The Rev. John Campbell, one of the founders of the Bible Society, also travelled in southern Bechuanaland and the adjoining districts in 1812-1814 and 1819-1821, adding considerably to the knowledge of the river systems. About 1817 Mosilikatze, the founder of the Matabele nation, fleeing from the wrath of Chaka, the Zulu king, began his career of conquest, during which he ravaged a great part of Bechuanaland and enrolled large numbers of Bechuana in his armies. Eventually the Matabele settled to the north-east in the country which afterwards bore their name. In 1821 Robert Moffat arrived at Kuruman as agent of the London Missionary Society, and made it his headquarters for fifty years. Largely as the result of the work of Moffat (who reduced the Bechuana tongue to writing), and of other missionaries, the Bechuana advanced notably in civilization. The arrival of David Livingstone in 1841 marked the beginning of the systematic exploration of the northern regions. His travels, and those of C. J. Andersson (1853-1858) and others, covered almost every part of the country hitherto unknown. In 1864 Karl Mauch discovered gold in the Tati district.

At the time of the first contact of the Bechuana with white men the Cape government was the only civilized authority in South Africa; and from this cause, and the circumstance that the missionaries who lived among and exercised great influence over them were of British nationality, the connexion between Bechuanaland and the Cape became close. As early as 1836 an act was passed extending the jurisdiction of the Cape courts in certain cases as far north as 25° S.—a limit which included the southern part of Bechuanaland. Although under strong British influence the country was nevertheless ruled by its own chiefs, among whom the best-known in the middle of the 19th century were Montsioa, chief of the Barolong, and Sechele, chief of the Bakwena and the friend of Livingstone. At this period the Transvaal Boers were in a very unsettled state, and those living in the western districts showed a marked inclination to encroach upon the lands of the Bechuana. In 1852 Great Britain by the Sand river convention acknowledged the independence of the Transvaal. Save the Vaal river no frontier was indicated, and "boasting," writes Livingstone in his *Missionary Travels*, "that the English had given up all the blacks into their power . . . they (the Boers) assaulted the Bakwains" (Bakwena).

With this event the political history of Bechuanaland may be said to have begun. Not only was Sechele attacked at his capital Kolobeng, and the European stores and Livingstone's house there looted, but the Boers stopped a trader named M'Cabe from going northward. Again to quote Livingstone, "The Boers resolved to shut up the interior and I determined to open the country." In 1858 the Boers told the missionaries that they must not go north without their (the Boers') consent. Moffat complained to Sir George Grey, the governor of Cape Colony, through whose intervention the molestation by Transvaal Boers of British subjects in their passage through Bechuanaland was stopped. At a later date (1865) the Boers tried to raise taxes from the Barolong, but without success, a commando sent against them in 1868 being driven off by Montsioa's brother Molema. This led to a protest (in 1870) from Montsioa, which he lodged with a landdrost at Potchefstroom in the Transvaal, threatening to submit the matter to the British high commissioner if any further attempt at taxation were made on the part of the Boers. The Boers then resorted to cajolery, and at a meeting held in August 1870, at which President Pretorius and Paul Kruger represented the Transvaal, invited the Barolong to join their territories with that of the republic, in order to save them from becoming British. Montsioa's reply was short: "No one ever spanned in an ass with an ox in one yoke." In the following year the claims of the Boers, the Barolong, and other tribes were submitted to the arbitration of R. W. Keate, lieutenant-governor of Natal, and his award placed Montsioa's territory outside the limits of the Transvaal. This attempt of the Boers to gain possession of Bechuanaland having failed, T. F. Burgers, the president of the Transvaal in 1872, endeavoured to replace Montsioa as chief of the Barolong by Moshette, whom

he declared to be the rightful ruler and paramount chief of that people. The attacks of the Boers at length became so unbearable that Montsioa in 1874 made a request to the British authorities to be taken under their protection. In formulating this appeal he declared that when the Boers were at war with Mosilikatze, chief of the Matabele, he had aided them on the solemn understanding that they were to respect his boundaries. This promise they had broken. Khama, chief of the Bamangwato in northern Bechuanaland, wrote in August 1876 to Sir Henry Barkly making an appeal similar to that sent by the Barolong. The letter contained the following significant passages:

"I write to you, Sir Henry, in order that your queen may preserve for me my country, it being in her hands. The Boers are coming into it, and I do not like them." "Their actions are cruel among us black people. We are like money, they sell us and our children." "I ask Her Majesty to defend me, as she defends all her people. There are three things which distress me very much—war, selling people, and drink. All these things I shall find in the Boers, and it is these things which destroy people to make an end of them in the country. The custom of the Boers has always been to cause people to be sold, and to-day they are still selling people."

The statements of Khama in this letter do not appear to have been exaggerated. The testimony of Livingstone confirms them, and even a Dutch clergyman, writing in 1860, described the system of apprenticeship of natives which obtained among the Boers "as slavery in the fullest sense of the word." These representations on the part of the Barolong, and the Bamangwato under Khama, supported by the representations of Cape politicians, led in 1878 to the military occupation of southern Bechuanaland by a British force under Colonel (afterwards General Sir Charles) Warren. A small police force continued to occupy the district until April 1881, but, ignoring the wishes of the Bechuana and the recommendations of Sir Bartle Frere (then high commissioner), the home government refused to take the country under British protection. On the withdrawal of the police, southern Bechuanaland fell into a state of anarchy, nor did the fixing (on paper) of the frontier between it and the Transvaal by the Pretoria convention of August 1881 have any beneficial effect. There was fighting between Montsioa and Moshette, while Massow, a Batlapin chief, invited the aid of the Boers against Mankoroane, who claimed to be paramount chief of the Batlapin. The Transvaal War of that date offered opportunities to the freebooting Boers of the west which were not to be lost. At this time the British, wearied of South African troubles, were disinclined to respond to native appeals for help. Consequently the Boers proceeded without let or hindrance with their conquest and annexation of territory. In 1882 they set up the republic of Stellaland, with Vryburg as its capital, and forthwith proceeded to set up the republic of Goshen, farther north, in spite of the protests of Montsioa, and established a small town called Rooi Grond as capital. They then summoned Montsioa to quit the territory. The efforts of the British authorities at this period (1882-1883) to bring about a satisfactory settlement were feeble and futile, and fighting continued until peace was made entirely on Boer lines. The Transvaal government was to have supreme power, and to be the final arbiter in case of future quarrels arising among the native chiefs. This agreement, arrived at without any reference to the British government, was a breach of the Pretoria convention, and led to an intimation on the part of Great Britain that she could not recognize the new republics. In South Africa, as well as in England, strong feeling was aroused by this act of aggression. Unless steps were taken at once, the whole of Bechuanaland might be permanently lost, while German territory on the west might readily be extended to join with that of the Boers. In the London convention of February 1884, conceded by Lord Derby in response to the overtures of Boer delegates, the Transvaal boundaries were again defined, part of eastern Bechuanaland being included in Boer territory. In spite of the convention the Boers remained in Stellaland and Goshen—which were west of the new Transvaal frontier, and in April 1884 the Rev. John Mackenzie, who had succeeded Livingstone, was sent to the country to arrange

Stellaland
and
Goshen.

matters. He found very little difficulty in negotiating with the various Bechuana chiefs, but with the Boers he was not so successful. In Goshen the Boers defied his authority, while in Stellaland only a half-hearted acceptance of it was given. At the instance of the new Cape government, formed in May and under control of the Afrikaner Bond, Mackenzie, who was accused of being too "pro-Bechuana" and who had been refused the help of any armed force, was recalled on the 30th of July by the high commissioner, Sir Hercules Robinson. In his place Cecil Rhodes, then leader of the Opposition in the Cape parliament, was sent to Bechuanaaland.

Rhodes's mission was attended with great difficulty. British prestige after the disastrous Boer War of 1881 was at a very low ebb, and he realized that he could not count on any active help from the imperial or colonial authorities.

Rhodes's mission. He adopted a tone of conciliation, and decided that the Stellaland republic should remain under a sort of British suzerainty. But in Goshen the Boers would let him do nothing. Commandant P. J. Joubert, after meeting him at Rooi Grond, entered the country and attacked Montsioa. Rhodes then left under protest, declaring that the Boers were making war against Great Britain. The Boers now (10th of September) proclaimed the country under Transvaal protection. This was a breach of the London convention, and President Kruger explained that the steps had been taken in the "interests of humanity."

Warren expedition. Indignant protest in Cape Town and throughout South Africa, as well as England, led to the despatch in October 1884 of the Warren expedition, which was sent out by the British government to remove the filibusters, to bring about peace in the country, and to hold it until further measures were decided upon. Before Sir Charles Warren reached Africa, Sir Thomas Uppington, the Cape premier, and Sir Gordon Sprigg, the treasurer-general, went to Bechuanaaland and arranged a "settlement" which would have left the Boer filibusters in possession, but the imperial government refused to take notice of this "settlement." Public opinion throughout Great Britain was too strong to be ignored. The limit of concessions to the Boers had been reached, and Sir Charles Warren's force—4000 strong—had reached the Vaal river in January 1885. On the 22nd of January Kruger met Warren at the Modder river, and endeavoured to stop him from proceeding farther, saying that he would be responsible for keeping order in the country. Warren, however, continued his march, and without firing a shot broke up the republics of Stellaland and Goshen. Bechuanaaland was formally taken under British protection (30th of September 1885), and the sphere of British influence was declared to extend N. to 22° S. and W. to 20° E. (which last-mentioned line marks the eastern limit of German South-West Africa).

The natives cheerfully accepted this new departure in British policy, and from this time forward Khama's country was known as the British protectorate of Bechuanaaland. That portion lying to the south of the Molopo river was described as British Bechuanaaland, and was constituted a crown colony. In 1891 the northern frontier of the protectorate was extended to its present boundaries, and the whole of it placed under the administration of a resident commissioner, a protest being made at the time by the British South Africa Company on the ground that the protectorate was included in the sphere of their charter. Under the able administration (1885-1895) of Sir Sidney Shippard (*q.v.*) peace was maintained among the natives, who have shown great loyalty to British rule.

The history of the country shows how much has been due to the efforts of men like Livingstone, Mackenzie and Rhodes. It is quite clear that had they not represented the true state of affairs to the authorities the whole of this territory would have gradually been absorbed by the Boers, until they had effected a union with the Germans on the west. The great road to the north would thus have been effectually shut against trade and British colonization. With regard to the precise effect of missionary influence upon the natives, opinion will always

remain divided. But Livingstone, who was not only a missionary but also an enlightened traveller, stated that a considerable amount of benefit had been conferred upon the native races by missionary teaching. Livingstone was a great advocate of the prohibition of alcohol among the natives, and that policy was always adhered to by Khama.

In 1891 the South African Customs Union was extended to British Bechuanaaland, and in 1895 the country was annexed to Cape Colony. At the same time it was provisionally arranged that the Bechuanaaland protectorate should pass under the administration of the British South Africa Company (see *RHODESIA*). Khama and two other Bechuana chiefs came to England and protested against this arrangement. The result was that their territories and those of other petty chiefs lying to the north of the Molopo were made native reserves, into which the importation of alcohol was forbidden. A British resident officer was to be appointed to each of the reserves. A stipulation, however, was made with these chiefs that a strip of country sufficient for the purposes of a railway to Matabeleland should be conceded to the Chartered Company. In December 1895 the occurrence of the Jameson Raid, which started from these territories, prevented the completion of negotiations, and the administration of the protectorate remained in the hands of the imperial government. The administration, besides fostering the scanty material resources of the country, aids the missionaries in their endeavours to raise the Bechuana in the scale of civilization. The results are full of encouragement. The natives proved staunch to the British connexion during the war of 1899-1902, and Khama and other chiefs gave help by providing transport. Anxiety was caused on the western frontier during the German campaigns against the Hottentots and Herero (1903-1908), many natives seeking refuge in the protectorate. A dispute concerning the chieftainship of the Batawana in the Ngami district threatened trouble in 1906, but was brought to a peaceful issue. The Bechuana were entirely unaffected by the Kaffir rebellion in Natal.

BIBLIOGRAPHY.—Of early works the most valuable are David Livingstone, *Missionary Travels in South Africa* (London, 1857); Robert Moffat, *Missionary Labours and Scenes in Southern Africa* (London, 1842); J. Campbell, *Travels in South Africa* (London, 1815); *Travels . . . a Second Journey . . .* (2 vols., London, 1822); and A. A. Anderson, *Twenty-five Years in a Wagon in the Gold Regions of Africa*, vol. i. (London, 1887). See also J. D. Hepburn, *Twenty Years in Khama's Country* (London, 1895); S. Passarge's *Die Kalahari* (Berlin, 1904) deals chiefly with geological and allied questions; John Mackenzie's *Austral Africa, Losing it or Ruling it* (London, 1887); *John Mackenzie*, a biography by W. D. Mackenzie (London, 1902); and the article "Bechuanaaland" by Sir S. Shippard in *British Africa* (London, 1899), give the story of the beginnings of British rule in the protectorate. Of larger works dealing incidentally with Bechuanaaland consult G. M. Theal's *History of South Africa*; E. A. Pratt's *Leading Points in South African History* (London, 1900); and Cecil Rhodes, *His Political Life and Speeches*, by Vindex (London, 1900). See also the *Statistical Register, Cape of Good Hope*, issued yearly at Cape Town, and the *Annual Report, Bechuanaaland Protectorate*, issued by the Colonial Office, London.

(F. R. C.; A. P. H.)

BECK, CHRISTIAN DANIEL (1757-1832), German philologist, historian, theologian and antiquarian, one of the most learned men of his time, was born at Leipzig on the 22nd of January (1755) professor of Greek and Latin literature. He was appointed (1785) professor of Greek and Latin literature. This post he resigned in 1819 in order to take up the professorship of history, but resumed it in 1825. He also had the management of the university library, was director of the institute for the deaf and dumb, and filled many educational and municipal offices. In 1784 he founded a philological society, which grew into a philological seminary, superintended by him until his death. In 1808 he was made a *Hofrath* by the king of Saxony, and in 1820 a knight of the civil order of merit. His philological lectures, in which grammar and criticism were subordinated to history, were largely attended by hearers from all parts of Germany. He died at Leipzig on the 13th of December 1832. He edited a number of classical authors: *Pedro Albinovanus* (1783), Pindar and the *Scholia* (1792-1795), *Archistophanes* (with others, 1794, &c.),

Euripides (1778-1788), Apollonius Rhodius (1797), Demosthenes *De Pace* (1799), Plato (1813-1819), Cicero (1795-1807), Titus Calpurnius Siculus (1803). He translated Ferguson's *Fall of the Roman Republic* and Goldsmith's *History of Greece*, and added two volumes to Bauer's Thucydides. He also wrote on theological and historical subjects, and edited philological and bibliographical journals. He possessed a large and valuable library of 24,000 volumes.

See Nobbe, *Vita C. D. Bechii* (1837); and G. Hermann, *Opuscula*, v. 312.

BECK (OF BEEK), DAVID (1621-1656), Dutch portrait-painter, was born at Arnheim in Guelderland. He was trained by Van Dyck, from whom he acquired the fine manner of pencilling and sweet style of colouring peculiar to that great master. He possessed likewise that freedom of hand and readiness, or rather rapidity of execution, for which Van Dyck was so remarkable, inasmuch that when King Charles I. observed the expeditious manner of Beck's painting, he exclaimed, "Faith! Beck, I believe you could paint riding post." He was appointed portrait-painter and chamberlain to Queen Christina of Sweden, and he executed portraits of most of the sovereigns of Europe to adorn her gallery. His death at the Hague was suspected of being due to poisoning.

BECK, JAKOB SIGISMUND (1761-1840), German philosopher, was born at Danzig in 1761. Educated at Königsberg, he became professor of philosophy first at Halle (1791-1799) and then at Rostock. He devoted himself to criticism and explanation of the doctrine of Kant, and in 1793 published the *Erläuternder Auszug aus Kants kritischen Schriften*, which has been widely used as a compendium of Kantian doctrine. He endeavoured to explain away certain of the contradictions which are found in Kant's system by saying that much of the language is used in a popular sense for the sake of intelligibility, e.g. where Kant attributes to things-in-themselves an existence under the conditions of time, space and causality, and yet holds that they furnish the material of our apprehensions. Beck maintains that the real meaning of Kant's theory is idealism; that of objects outside the domain of consciousness, knowledge is impossible, and hence that nothing positive remains when we have removed the subjective element. Matter is deduced by the "original synthesis." Similarly, the idea of God is a symbolical representation of the voice of conscience guiding from within. The value of Beck's exegesis has been to a great extent overlooked owing to the greater attention given to the work of Fichte. Beside the three volumes of the *Erläuternder Auszug*, he published the *Grundriss der brit. Philosophie* (1796), containing an interpretation of the Kantian *Kritik* in the manner of Salomon Maimon.

See Ueberweg, *Grundriss der Gesch. der Philos. der Neuzeit*; Dilthey in the *Archiv für Geschichte der Philos.*, vol. ii. (1889), pp. 592-650. For Beck's letters to Kant, see R. Reicke, *Aus Kants Briefwechsel* (Königsberg, 1885).

BECKENHAM, an urban district in the Sevenoaks parliamentary division of Kent, England, 10 m. S.E. of London by the South Eastern & Chatham railway. Pop. (1881) 13,045; (1901) 26,331. It is a long straggling parish extending from the western tower of the Crystal Palace almost to the south end of Bromley, and contains the residential suburb of Shortlands. Its rapid increase in size in the last decade of the 19th century was owing to the popularity which it attained as a place of residence for London business men. It retains, however, some of its rural character, and has wide thoroughfares and many handsome residences standing in extensive grounds. King William IV.'s Naval Asylum was endowed by Queen Adelaide for 12 widows of naval officers. The church of St George was built in 1866 on the site of an ancient Perpendicular church. Some 16th-century brasses, an altar tomb and a piscina were removed hither from the old church. The tower of the church was completed in 1903, and furnished with two bells in memory of Cecil Rhodes, in addition to the old bells, one of which dates from 1624.

BECKER, HEINRICH (1770-1822), German actor, whose real name was BLUMENTHAL, was born at Berlin. He obtained, while quite a young man, an appointment in the court theatre

at Weimar, at that time under Goethe's auspices. The poet recognized his talent, appointed him stage-manager, entrusted him with several of the leading rôles in his dramas and consulted him in all matters connected with the staging of his plays. For many years Becker was the favourite of the Weimar stage, and although he was at his best in comedy, he played, to Goethe's great satisfaction, Vansen in *Egmont*, and was also seen to great advantage in the leading parts of several of Schiller's plays; notably Burlough in *Maria Stuart*, Karl Moor in *Die Räuber*, and Antonio in *Torquato Tasso*. Becker left Weimar in the spring of 1809, played for a short time at Hamburg (under Schröder) and at Breslau, and then began a wandering life, now joining travelling companies, now playing at provincial theatres. Broken in health and ruined in fortune he returned in 1820 to Weimar, where he was again cordially received by Goethe, who reinstated him at the theatre. After playing for two short years with indifferent success, he died at Weimar in 1822.

Becker was twice married. His first wife, CHRISTIANE LUISE AMALIE BECKER (1778-1797), was the daughter of a theatrical manager and dramatic poet, Johann Christian Neumann, and made her first stage appearance in 1787 at Weimar. Here she received some training from Goethe and from Corona Schröter, the singer, and her beauty and charm made her the favourite both of court and public. She married Heinrich Becker in 1793. She died on the 22nd of September 1797. Her last part was that of Euphrosyne in the opera *Das Petermännchen*, and it is under this name that Goethe immortalized her in a poem which first appeared in Schiller's *Musen Almanach* of 1799.

BECKER, WILHELM ADOLF (1796-1846), German classical archaeologist, was born at Dresden. At first destined for a commercial life, he was in 1812 sent to the celebrated school at Pforta. In 1816 he entered the university of Leipzig, where he studied under Beck and Hermann. After holding subordinate posts at Zerbst and Meissen, he was in 1842 appointed professor of archaeology at Leipzig. He died at Meissen on the 30th of September 1846. The works by which Becker is most widely known are the *Gallus or Römische Scenen aus der Zeit Augustus* (1838, new ed. by Göll, 1880-1882), and the *Charicles or Bilder altgriechischer Sitte* (1840, new ed. by Göll, 1877-1878). These two books, which have been translated into English by Frederick Metcalfe, contain a very interesting description of the everyday life of the ancient Greeks and Romans, in the form of a romance. The notes and appendices are valuable. More important is the great *Handbuch der röm. Alterthümer* (1843-1868), completed after Becker's death by Marquardt and Mommsen. Becker's treatises *De Comicis Romanorum Fabulis* (1837), *De Romae Veteris Muris atque Portis* (1842), *Die römische Topographie in Rom* (1844), and *Zur römischen Topographie* (1845) may also be mentioned.

BECKET, THOMAS (c. 1118-1170), by his contemporaries more commonly called Thomas of London, English chancellor and archbishop of Canterbury under Henry II., was born about the year 1118 in London. His mother was a native of Caen; his father, who came of a family of small Norman landowners, had been a citizen of Rouen, but migrated to London before the birth of Thomas, and held at one time the dignified office of portreeve, although he ended his life in straitened circumstances. The young Thomas received an excellent education. At the age of ten he was put to school with the canons of Merton priory in Surrey. Later he spent some time in the schools of London, which enjoyed at that time a high reputation, and finally studied theology at Paris. Returning at the age of twenty-two he was compelled, through the misfortunes of his parents, to become a notary in the service of a wealthy kinsman, Osbert Huit Deniers, who was of some importance in London politics. About 1142 a family friend brought Thomas under the notice of Archbishop Theobald, of whose household he at once became an inmate. He accompanied the primate to Rome in 1143, and also to the council of Reims (1148), which Theobald attended in defiance of a prohibition from the king. It appears to have been at some time between the dates of these two journeys that he visited

Bologna and Auxerre, and began those studies in the canon law to which he was in no small degree indebted for his subsequent advancement and misfortunes. Although the bent of his mind was legal, he never made himself an expert jurist; but he had the art of turning his knowledge, such as it was, to excellent account. In 1151 he was sent to Rome by the archbishop with instructions to dissuade the Curia from sanctioning the coronation of Stephen's eldest son Eustace. It is said that Thomas distinguished himself by the ability with which he executed his commission; in any case it gave him a claim on the gratitude of the Angevin party which was not forgotten. In 1154 he was promoted to be archdeacon of Canterbury, after first taking deacon's orders. In the following year Henry II., at the primate's recommendation, bestowed on him the important office of chancellor. In this capacity Thomas controlled the issue of royal writs and the distribution of ecclesiastical patronage; but it was more important for his future that he had ample opportunities of exercising his personal fascination upon a prince who was comparatively inexperienced, and thirteen or fourteen years his junior. He became Henry's bosom friend and was consulted in all affairs of state. It had been the hope of Theobald that Becket's influence would be exercised to support the extensive privileges which the Church had wrested from Stephen. But the chancellor, although preserving friendly relations with his old patron, subordinated the interests of the Church to those of his new master. Under his administration the Church was severely taxed for the prosecution of Henry's foreign wars; and the chancellor incurred the reproach "of plunging his sword into the bowels of his mother." Like Wolsey he identified himself with the military aspirations of his sovereign. It was Thomas who organized the Toulouse campaign of 1159; even in the field he made himself conspicuous by commanding a company of knights, directing the work of devastation, and superintending the conduct of the war after the king had withdrawn his presence from the camp. When there was war with France upon the Norman border, the chancellor acted as Henry's representative; and on one occasion engaged in single combat and unhorsed a French knight of reputation. Later it fell to his part to arrange the terms of peace with France. He discharged the duties of an envoy with equal magnificence and dexterity; the treaty of May 1160, which put an end to the war, was of his making.

In 1162 he was transferred to a new sphere of action. Henry bestowed on him the see of Canterbury, left vacant by the death of Theobald. The appointment caused some murmurs; since Becket, at the time when it was made, was still a simple deacon. But it had been desired by Theobald as the one means of averting an attack on clerical privileges which had been impending almost since the accession of Henry II.; and the bishops accepted it in silence. Henry on his side looked to find in Becket the archbishop a coadjutor as loyal as Becket the archdeacon; and anticipated that the Church would once more be reduced to that state of dependence in which she had stood during the latter years of Henry I. Becket, however, disappointed all the conflicting expectations excited by his appointment. He did not allow himself to be made the king's tool; nor on the other hand did he attempt to protect the Church by humouring the king in ordinary matters. He devoted himself to ascetic practices, confined himself to the society of churchmen, and resigned the chancellorship in spite of a papal dispensation (procured by the king) which authorized him to hold that office concurrently with the primacy. By nature a violent partisan, the archbishop now showed himself the uncompromising champion of his order and his see. Hence he was on the worst of terms with the king before a year had elapsed. They came into open conflict at the council of Woodstock (July 1163), when Becket successfully opposed the king's proposal that a land-tax, known as the sheriff's aid, which formed part of that official's salary, should be henceforth paid into the Exchequer. But there were more serious differences in the background. Becket had not shrunk from excommunicating a tenant in chief who had encroached upon the lands of Canterbury, and had protected

against the royal courts a clerk named Philip de Brois who was charged with an assault upon a royal officer. These disputes involved questions of principle which had long occupied Henry's attention, and Becket's defiant attitude was answered by the famous Constitutions of Clarendon (*g. s.*), in which the king defined, professedly according to ancient use and custom, the relations of Church and State. Becket and the bishops were required to give these constitutions their approval. Henry's demands were more defensible in substance than might be supposed from the manner in which he pressed them on the bishops. On the most burning question, that of criminous clerks, he offered a compromise. He was willing that the accused should be tried in the courts Christian provided that the punishment of the guilty were left to the lay power. Becket's opposition rested upon a casuistic interpretation of the canon law, and an extravagant conception of the dignity attaching to the priesthood; he showed, moreover, a disposition to quibble, to equivocate, and to make promises which he had no intention of fulfilling. His conduct may be excused on the ground that the bishops were subjected to unwarrantable intimidation. But when he renounced his promise to observe the constitutions his conduct was reprobated by the other bishops, although approved by the pope. It was fortunate for Becket's reputation that Henry punished him for his change of front by a systematic persecution in the forms of law. The archbishop was thus enabled to invoke the pope's assistance, and to quit the country with some show of dignity.

Becket fled to France in November 1164. He at once succeeded in obtaining from Alexander III. a formal condemnation of the constitutions. But Alexander, a fugitive from Italy and menaced by an alliance of the emperor with an antipope, was indisposed to take extreme measures against Henry; and six years elapsed before the king found himself definitely confronted with the choice between an interdict and a surrender. For the greater part of this time the archbishop resided at the Burgundian monastery of Pontigny, constantly engaged in negotiations with Alexander, whose hand he desired to force, and with Henry, from whom he hoped to extract an unconditional submission. In 1166 Becket received from the pope a commission to publish what censures he thought fit; of which he at once availed himself to excommunicate the king's principal counsellors. In 1169 he took the same step against two of the royalist bishops. In more sweeping measures, however, the pope refused to support him, until in 1170 Henry infringed the rights of Canterbury by causing Archbishop Roger of York to crown the young king. In that year the threats of the pope forced Henry to a reconciliation which took place later at Fréteval on the 22nd of July. It was a hollow truce, since the subject of the constitutions was not mentioned; and Thomas returned to England with the determination of riding roughshod over the king's supporters. If he had not given a definite pledge to forgive the bishops who had taken part in the young king's coronation, he had at least raised expectations that he would overlook all past offences. But the archbishop prevailed upon the pope to suspend the bishops, and before his return published papal letters which, in announcing these sentences, spoke of the constitutions as null and void. It was only to be expected that such a step, which was virtually a declaration of war against the king, should arouse in him the strongest feelings of resentment. The archbishop's murder, perpetrated within a month of his return to England (20th December 1170), was, however, the work of over zealous courtiers and regretted by no one more than Henry.

Becket was canonized in 1172. Within a short time his shrine at Canterbury became the resort of innumerable pilgrims. Plenary indulgences were given for a visit to the shrine, and an official register was kept to record the miracles wrought by the relics of the saint. The shrine was magnificently adorned with the gold and silver and jewels offered by the pious. It was plundered by Henry VIII., to whom the memory of Becket was specially obnoxious; but the reformers were powerless to expunge the name of the saint from the Roman calendar, on which it still remains. Even to those who are in sympathy with

the principles for which he fought, the posthumous reputation of Becket must appear strangely exaggerated. It is evident that in the course of his long struggle with the state he fell more and more under the dominion of personal motives. At the last he fought not so much for an idea as for the humiliation of an opponent by whom he had been ungenerously treated. William of Newburgh appears to express the verdict of the most impartial contemporaries when he says that the bishop was *zelo justitiae fervidus, utrum autem plene secundum scientiam novit Deus*: "burning with zeal for justice, but whether altogether according to wisdom God knows."

AUTHORITIES.—*Original*.—The correspondence of Becket and most of the contemporary biographies are collected by J. C. Robertson in *Materials for the History of Thomas Becket* (7 vols., Rolls Series, 1875-1885). See also the *Vie de Saint Thomas*, by Garnier de Pont Sainte Maxence (ed. Hippéau, Paris, 1859). For the chronology of the controversy see *Etton's Itinerary of Henry II.*

Modern.—Morris, *Life and Martyrdom of St Thomas Becket* (London, 1885); Lhuillier, *Saint Thomas de Cantorbéry* (2 vols., Paris, 1891-1892); J. C. Robertson, *Becket* (London, 1859); F. W. Maitland, *Roman Canon Law in the Church of England*, c. iv.; J. A. Froude in his *Short Studies*, vol. iv., and Fremantle in his *Historical Essays* (1871), give noteworthy but conflicting appreciations. (H. W. C. D.)

BECKFORD, WILLIAM (1760-1844), English author, son of Alderman William Beckford (1709-1770), was born on the 1st of October 1760. His father was lord mayor of London in 1762 and again in 1769; he was a famous supporter of John Wilkes, and on his monument in the Guildhall were afterwards inscribed the words of his manly and outspoken reproof to George III. on the occasion of the City of London address to the king in 1770. At the age of eleven young Beckford inherited a princely fortune from his father. He married Lady Margaret Gordon in 1783, and spent his brief married life in Switzerland. After his wife's death (1786) he travelled in Spain and Portugal, and wrote his *Portuguese Letters* (published 1834, 1835), which rank with his best work. He afterwards returned to England, and after selling his old house, Fonthill Abbey, Wiltshire, began to build a magnificent residence there, on which he expended in about eighteen years the sum of £273,000. His eccentricities, together with the strict seclusion in which he lived, gave rise to scandal, probably unjustified. In 1822 he sold his house, together with its splendid library and pictures, to John Farquhar, and soon after one of the towers, 260 ft. high, fell, destroying part of the villa in the ruins. Beckford erected another lofty structure on Lansdowne Hill, near Bath, where he continued to reside till his death in 1844. His first work, *Biographical Memoirs of Extraordinary Painters* (1780) was a slight, sarcastic *jeu d'esprit*. In 1782 he wrote in French his oriental romance, *The History of the Caliph Vathek*, which appeared in English, translated by the Rev. Samuel Henley, in 1786 and has taken its place as one of the finest productions of luxuriant imagination.

Beckford's wealth and large expenditure, his position as a collector and patron of letters (he bought Gibbon's library at Lausanne), his literary industry, and his reputation as author of *Vathek*, make him an interesting figure in literary history. He had a seat in parliament from 1784 to 1793, and again from 1806 to 1820. He left two daughters, the eldest of whom was married to the 10th duke of Hamilton.

Cyrus Redding's *Memoir* (1859) is the only full biography, but profix; see Dr R. Garnett's introduction to his edition of *Vathek* (1893).

BECKINGTON (or BEKYNTON), **THOMAS** (c. 1300-1465), English statesman and prelate, was born at Beckington in Somerset, and was educated at Winchester and New College, Oxford. Having entered the church he held many ecclesiastical appointments, and became dean of the Arches in 1423; then devoting his time to secular affairs he was sent on an embassy to Calais in 1430, and to John IV., count of Armagnac, in 1442. At this time Beckington was acting as secretary to Henry VI., and soon after his return in 1443 he was appointed lord privy seal and bishop of Bath and Wells. The bishop erected many buildings in Wells, and died there on the 14th of January 1465. The most important results of Beckington's missions to France

were one Latin journal, written by himself, referring to the embassy to Calais; and another, written by one of his attendants, relating to the journey to Armagnac.

Beckington's own journal is published in the *Proceedings of the Privy Council*, vol. v., edited by N. H. Nicolas (1835); and the other journal in the *Official Correspondence of Thomas Bekynton*, edited by G. Williams for the Rolls Series (1872), which contains many interesting letters. This latter journal has been translated into English by N. H. Nicolas (1828). See G. C. Perry, "Bishop Beckington and Henry VI.," in the *English Historical Review* (1894).

BECKMANN, JOHANN (1739-1811), German scientific author, was born on the 4th of June 1739 at Hoya in Hanover, where his father was postmaster and receiver of taxes. He was educated at Stade and the university of Göttingen. The death of his mother in 1762 having deprived him of his means of support, he went in 1763 on the invitation of the pastor of the Lutheran community, Anton Friedrich Büsching, the founder of the modern historic statistical method of geography, to teach natural history in the Lutheran academy, St Petersburg. This office he relinquished in 1765, and travelled in Denmark and Sweden, where he studied the methods of working the mines, and made the acquaintance of Linnaeus at Upsala. In 1766 he was appointed extraordinary professor of philosophy at Göttingen. There he lectured on political and domestic economy with such success that in 1770 he was appointed ordinary professor. He was in the habit of taking his students into the workshops, that they might acquire a practical as well as a theoretical knowledge of different processes and handicrafts. While thus engaged he determined to trace the history and describe the existing condition of each of the arts and sciences on which he was lecturing, being perhaps incited by the *Bibliothecae* of Albrecht von Haller. But even Beckmann's industry and ardour were unable to overtake the amount of study necessary for this task. He therefore confined his attention to several practical arts and trades; and to these labours we owe his *Beiträge zur Geschichte der Erfindungen* (1780-1805), translated into English as the *History of Inventions*—a work in which he relates the origin, history and recent condition of the various machines, utensils, &c., employed in trade and for domestic purposes. This work entitles Beckmann to be regarded as the founder of scientific technology, a term which he was the first to use in 1772. In 1772 Beckmann was elected a member of the Royal Society of Göttingen, and he contributed valuable scientific dissertations to its proceedings until 1783, when he withdrew from all further share in its work. He died on the 3rd of February 1811. Other important works of Beckmann are *Entwurf einer allgemeinen Technologie* (1806); *Anleitung zur Handelswissenschaft* (1780); *Vorbereitung zur Warenkunde* (1795-1800); *Beiträge zur Ökonomie, Technologie, Polizei- und Kameralwissenschaft* (1777-1791).

BECKWITH, JAMES CARROLL (1852-), American portrait-painter, was born at Hannibal, Missouri, on the 23rd of September 1852. He studied in the National Academy of Design, New York City, of which he afterwards became a member, and in Paris (1873-1878) under Carolus Duran. Returning to the United States in 1878, he gradually became a prominent figure in American art. He took an active part in the formation of the Fine Arts Society, and was president of the National Free Art League, which attempted to secure the repeal of the American duty on works of art. Among his portraits are those of W. M. Chase (1882), of Miss Jordan (1883), of Mark Twain, T. A. Janvier, General Schofield and William Walton. He decorated one of the domes of the Manufactures Building at the Columbian Exposition, Chicago, 1893.

BECKWITH, SIR THOMAS SYDNEY (1772-1831), British general, was the son of Major-General John Beckwith, who was colonel of the 20th regiment (Lancashire Fusiliers) in the charge at Minden. In 1791 he entered the 71st regiment (then commanded by Colonel David Baird), in which he served in India and elsewhere until 1800, when he obtained a company in Colonel Coote Manningham's experimental regiment of riflemen, shortly afterwards numbered as the 95th Rifles and now called the Rifle Brigade. In 1802 he was promoted major, and in the following

year lieutenant-colonel. Beckwith was one of the favourite officers of Sir John Moore in the famous camp of Shorncliffe, and aided that general in the training of the troops which afterwards became the Light Division. In 1806 he served in the expedition to Hanover, and in 1807 in that which captured Copenhagen. In 1806 the Rifles were present at Vimeira, and in the campaign of Sir John Moore they bore the brunt of the rearguard fighting. Beckwith took part in the great march of Craufurd to the field of Talavera, in the advanced guard fights on the Coa in 1810 and in the campaign in Portugal. On the formation of the Light Division he was given a brigade command in it. After the brilliant action of Sabugal, Beckwith had to retire for a time from active service, but the Rifles and the brigade he had trained and commanded added to their fame on every subsequent battlefield. In 1812 he went to Canada as assistant quartermaster-general, and he took part in the war against the United States. In 1814 he became major-general, and in 1815 was created K.C.B. In 1827 he was made colonel commandant of the Rifle Brigade. He went to India as commander-in-chief at Bombay in 1829, and was promoted lieutenant-general in the following year. He died on the 15th of January 1831 at Mahabeshwar.

His elder brother, Sir GEORGE BECKWITH (1753-1823), distinguished himself as a regimental officer in the American War of Independence, and served subsequently in high administrative posts and in numerous successful military operations in the West Indies during the French Revolutionary and Napoleonic wars. He was made a K.B. for his capture of Martinique in 1809, and attained the full rank of general in 1814. Sir George Beckwith commanded the forces in Ireland, 1816-1820. He died in London on the 20th of March 1823.

Their nephew, Major-General JOHN CHARLES BECKWITH (1780-1862), joined the 50th regiment in 1803, exchanging in 1804 into the 95th Rifles, with which regiment he served in the Peninsular campaigns of 1808-10. He was subsequently employed on the staff of the Light Division, and he was repeatedly mentioned in despatches, becoming in 1814 a brevet-major, and after the battle of Waterloo (in which he lost a leg) lieutenant-colonel and C.B. In 1820 he left active service. Seven years later an accident drew his attention to the Waldenses, whose past history and present condition influenced him so strongly that he settled in the valleys of Piedmont. The rest of his life was spent in the self-imposed task of educating the Waldenses, for whom he established and maintained a large number of schools, and in reviving the earlier faith of the people. In 1848 King Charles Albert made him a knight of the order of St Maurice and St Lazarus. He was promoted colonel in the British army in 1837 and major-general in 1846. He died on the 10th of July 1862 at La Torre, Piedmont.

BECKX, PIERRE JEAN (1705-1887), general of the Society of Jesus, was born at Sichein in Belgium on the 8th of February 1705, and entered the novitiate of the order at Hildesheim in 1810. His first important post was as procurator for the province of Austria, 1847; next year he became rector of the Jesuit college at Louvain, and, after serving as secretary to the provincials of Belgium and Austria, was elected head of the order in 1853. His tenure of office was marked by an increased zeal for missions in Protestant lands, and by the removal of the society's headquarters from Rome to Fiesole near Florence in 1870. His chief literary work was the often-translated *Month of Mary* (Vienna, 1843). He retired in September 1883, being succeeded by Anthony M. Anderledy, a Swiss, who had seen service in the United States. He died at Rome on the 4th of March 1887.

BECQUE, HENRY FRANÇOIS (1837-1899), French dramatist, was born on the 9th of April 1837 in Paris. He wrote the book of an opera *Sardanapale* in imitation of Lord Byron for the music of M. Victorin Joncières in 1867, but his first important work, *Michel Paupier*, appeared in 1870. The importance of this sombre drama was first realized when it was revived at the Odéon in 1886. *Les Corbeaux* (1882) established Becque's position as an innovator, and in 1885 he produced his most successful

play, *La Parisienne*. Becque produced little during the last years of his life, but his disciples carried on the tradition he had created. He died in May 1899.

See his *Querelles littéraires* (1890), and *Souvenirs d'un auteur dramatique* (1895), consisting chiefly of reprinted articles in which he does not spare his opponents. His *Théâtre complet* (3 vols., 1899) includes *L'Enfant prodige* (Vaudeville-Théâtre, 6th of Nov. 1868); *Michel Paupier* (Théâtre de la Porte-Saint-Martin, 17th of June 1870); *L'Éléonore* (Vaudeville, 18th of Nov. 1871); *La Navette* (Gymnase, 15th of Nov. 1878); *Les Hommes Femmes* (Gymnase, 5th of Jan. 1880); *Les Corbeaux* (Comédie Française, 14th of Sept. 1882); *La Parisienne* (Théâtre de la Renaissance, 7th of Feb. 1885).

BÉCQUER, GUSTAVO ADOLFO (1836-1870), Spanish poet and romance-writer, was born at Seville on the 17th of February 1836. Left an orphan at an early age, he was educated by his godmother, refused to adopt any profession, and drifted to Madrid, where he obtained a small post in the civil service. He was dismissed for carelessness, became an incorrigible Bohemian, and earned a precarious living by translating foreign novels; he died in great poverty at Madrid on the 22nd of December 1870. His works were published posthumously in 1873. In such prose tales as *El Rayo de Luna* and *La Mujer de piedra*, Bécquer is manifestly influenced by Hoffmann, and as a poet he has analogies with Heine. He dwells in a fairyland of his own, crooning a weird elfin music which has no parallel in Spanish; his work is unfinished and unequal, but it is singularly free from the rhetoric characteristic of his native Andalusia, and its lyrical ardour is of a beautiful sweetness and sincerity.

BECQUEREL, the name of a French family, several members of which have been distinguished in chemical and physical research.

ANTOINE CÉSAR BECQUEREL (1788-1878), was born at Châtillon sur Loing on the 8th of March 1788. After passing through the École Polytechnique he became *ingénieur-officier* in 1808, and saw active service with the imperial troops in Spain from 1810 to 1812, and again in France in 1814. He then resigned from the army and devoted the rest of his life to scientific investigation. His earliest work was mineralogical in character, but he soon turned his attention to the study of electricity and especially of electrochemistry. In 1837 he received the Copley medal from the Royal Society "for his various memoirs on electricity, and particularly for those on the production of metallic sulphures and sulphur by the long-continued action of electricity of very low tension," which it was hoped would lead to increased knowledge of the "recomposition of crystallized bodies, and the processes which may have been employed by nature in the production of such bodies in the mineral kingdom." In biological chemistry he worked at the problems of animal heat and at the phenomena accompanying the growth of plants, and he also devoted much time to meteorological questions and observations. He was a prolific writer, his books including *Traité d'électricité et du magnétisme* (1834-1840), *Traité de physique dans ses rapports avec la chimie* (1842), *Éléments de l'électro-chimie* (1843), *Traité complet du magnétisme* (1845), *Éléments de physique terrestre et de météorologie* (1847), and *Des climats et de l'influence qu'exercent les sols boisés et déboisés* (1853). He died on the 18th of January 1878 in Paris, where from 1837 he had been professor of physics at the Musée d'Histoire Naturelle.

His son, ALEXANDRE EDMOND BECQUEREL (1820-1891), was born in Paris on the 24th of March 1820, and was in turn his pupil, assistant and successor at the Musée d'Histoire Naturelle; he was also appointed professor at the short-lived Agronomic Institute at Versailles in 1849, and in 1853 received the chair of physics at the Conservatoire des Arts et Métiers. Edmond Becquerel was associated with his father in much of his work, but he himself paid special attention to the study of light, investigating the photochemical effects and spectroscopic characters of solar radiation and the electric light, and the phenomena of phosphorescence, particularly as displayed by the sulphides and by compounds of uranium. It was in connexion with these latter inquiries that he devised his phosphoscope, an apparatus which enabled the interval between exposure to the source of light and observation of the resulting effects to

be varied at will and accurately measured. He published in 1867-1868 a treatise in two volumes on *La Lumière, ses causes et ses effets*. He also investigated the diamagnetic and paramagnetic properties of substances; and was keenly interested in the phenomena of electrochemical decomposition, accumulating much evidence in favour of Faraday's law and proposing a modified statement of it which was intended to cover certain apparent exceptions. He died in Paris on the 11th of May 1891.

ANTOINE HENRI BEQUEREL (1852-1908), son of the last-named, who succeeded to his chair at the Musée d'Histoire Naturelle in 1892, was born in Paris on the 15th of December 1852, studied at the École Polytechnique, where he was appointed a professor in 1895, and in 1875 entered the department *des ponts et chaussées*, of which in 1894 he became *ingénieur en chef*. He was distinguished as the discoverer of radioactivity, having found in 1896 that uranium at ordinary temperatures emits an invisible radiation which in many respects resembles Röntgen rays, and can affect a photographic plate after passing through thin plates of metal. For his researches in this department he was in 1903 awarded a Nobel prize jointly with Pierre Curie. He also engaged in work on magnetism, the polarization of light, phosphorescence and the absorption of light in crystals. He died at Croisic in Brittany on the 25th of August 1908.

BED (a common Teutonic word, cf. German *Bett*, probably connected with the Indo-European root *bhōdh*, seen in the Lat. *foedere*, to dig; so "a dug-out place" for safe resting, or in the same sense as a garden "bed"), a general term for a resting or sleeping place for men and animals, and in particular for the article of household furniture for that object, and so used by analogy in other senses, involving a supporting surface or layer. The accompaniments of a domestic bed (bedding, coverlets, &c.) have naturally varied considerably in different times, and its form and decoration and social associations have considerable historical interest. The Egyptians had high bedsteads which were ascended by steps, with bolsters or pillows, and curtains to hang round. Often there was a head-rest as well, semi-cylindrical and made of stone, wood or metal. Assyrians, Medes and Persians had beds of a similar kind, and frequently decorated their furniture with inlays or *appliqués* of metal, mother-of-pearl and ivory. The oldest account of a bedstead is probably that of Ulysses which Homer describes him as making in his own house, but he also mentions the inlaying of the woodwork of beds with gold, silver and ivory. The Greek bed had a wooden frame, with a board at the head and bands of hide laced across, upon which skins were placed. At a later period the bedstead was often veneered with expensive woods; sometimes it was of solid ivory veneered with tortoise-shell and with silver feet; often it was of bronze. The pillows and coverings also became more costly and beautiful; the most celebrated places for their manufacture were Miletus, Corinth and Carthage. Folding beds, too, appear in the vase paintings. The Roman mattresses were stuffed with reeds, hay, wool or feathers; the last was used towards the end of the Republic, when custom demanded luxury. Small cushions were placed at the head and sometimes at the back. The bedsteads were high and could only be ascended by the help of steps. They were often arranged for two persons, and had a board or railing at the back as well as the raised portion at the head. The counterpanes were sometimes very costly, generally purple embroidered with figures in gold; and rich hangings fell to the ground masking the front. The bedsteads themselves were often of bronze inlaid with silver, and Elagabalus, like some modern Indian princes, had one of solid silver. In the walls of some of the houses at Pompeii bed niches are found which were probably closed by curtains or sliding partitions. The marriage bed, *lectus genialis*, was much decorated, and was placed in the atrium opposite the door. A low pallet-bed used for sick persons was known as *scimpodium*. Other forms of couch were called *lectus*, but were not beds in the modern sense of the word except the *lectus funebris*, on which the body of a dead person lay in state for seven days, clad in a toga and rich garments, and surrounded by flowers and foliage. This bed rested on ivory legs, over which purple blankets

embroidered with gold were spread, and was placed in the atrium with the foot to the door and with a pan of incense by its side. The ancient Germans lay on the floor on beds of leaves covered with skins, or in a kind of shallow chest filled with leaves and moss. In the early middle ages they laid carpets on the floor or on a bench against the wall, placed upon them mattresses stuffed with feathers, wool or hair, and used skins as a covering. They appear to have generally lain naked in bed, wrapping themselves in the large linen sheets which were stretched over the cushions. In the 13th century luxury increased, and bedsteads were made of wood much decorated with inlaid, carved and painted ornament. They also used folding beds, which served as couches by day and had cushions covered with silk laid upon leather. At night a linen sheet was spread and pillows placed, while silk-covered skins served as coverlets. Curtains were hung from the ceiling or from an iron arm projecting from the wall. The Carolingian MSS. show metal bedsteads much higher at the head than at the feet, and this shape continued in use till the 13th century in France, many cushions being added to raise the body to a sloping position. In the 12th-century MSS. the bedsteads appear much richer, with inlays, carving and painting, and with embroidered coverlets and mattresses in harmony. Curtains were hung above the bed, and a small hanging lamp is often shown. In the 14th century the woodwork became of less importance, being generally entirely covered by hangings of rich materials. Silk, velvet and even cloth of gold were much used. Inventories from the beginning of the 14th century give details of these hangings lined with fur and richly embroidered. Then it was that the tester bed made its first appearance, the tester being slung from the ceiling or fastened to the walls, a form which developed later into a room within a room, shut in by double curtains, sometimes even so as to exclude all draughts. The space between bed and wall was called the *ruelle*, and very intimate friends were received there. In the 15th century beds became very large, reaching to 7 or 8 ft. by 6 or 7 ft. Viollet-le-Duc says that the mattresses were filled with pea-shucks or straw—neither wool nor horsehair is mentioned—but feathers also were used. At this time great personages were in the habit of carrying most of their property about with them, including beds and bed-hangings, and for this reason the bedsteads were for the most part mere frameworks to be covered up; but about the beginning of the 16th century bedsteads were made lighter and more decorative, since the lords remained in the same place for longer periods. In the museum at Nancy is a fine bedstead of this period which belonged to Antoine de Lorraine. It has a carved head and foot as well as the uprights which support the tester. Another is in the Musée Cluny ascribed to Pierre de Gondi, very architectural in design, with a bracketed cornice, and turned and carved posts; at the head figures of warriors watch the sleeper. Louis XIV. had an enormous number of sumptuous beds, as many as 413 being described in the inventories of his palaces. Some of them had embroideries enriched with pearls, and figures on a silver or golden ground. The carving was the work of Proux or Caffieri, and the gilding by La Baronnière. The great bed at Versailles had crimson velvet curtains on which "The Triumph of Venus" was embroidered. So much gold was used that the velvet scarcely showed. Under the influence of Madame de Maintenon "The Sacrifice of Abraham," which is now on the tester, replaced "The Triumph of Venus." In the 17th century, which has been called "the century of magnificent beds," the style *à la duchesse*, with tester and curtains only at the head, replaced the more enclosed beds in France, though they lasted much longer in England. In the 18th century feather pillows were first used as coverings in Germany, which in the fashions of the bed and the curious etiquette connected with the bedchamber followed France for the most part. The beds were *à la duchesse*, but in France itself there was great variety both of name and shape—the *lit à alcove*, *lit d'ange*, which had no columns, but a suspended tester with curtains drawn back, *lit à l'Anglaise*, which looked like a high sofa by day, *lit en baldouin*, with the tester fixed against the wall,

lit à couronne with a tester shaped like a crown, a style which appeared under Louis XVI., and was fashionable under the Restoration and Louis Philippe, and *lit à l'imperiale*, which had a curved tester, are a few of their varieties. The *lit en baldaquin* of Napoleon I. is still at Fontainebleau, and the Garde Meuble contains several richly carved beds of a more modern date. The custom of the "bed of justice" upon which the king of France reclined when he was present in parliament, the princes being seated, the great officials standing, and the lesser officials kneeling, was held to denote the royal power even more than the throne. Louis XI. is credited with its first use, and the custom lasted till the end of the monarchy. From the habit of using this bed to hear petitions, &c., came the usage of the *grand lit*, which was provided wherever the king stayed, called also *lit de parement* or *lit de parade*, rather later. Upon this bed the dead king lay in state. The beds of the king and queen were saluted by the courtiers as if they were altars, and none approached them even when there was no railing to prevent it. These railings were apparently placed for other than ceremonial reasons originally, and in the accounts of several castles in the 15th century mention is made of a railing to keep dogs from the bed. In the *chambre de parade*, where the ceremonial bed was placed, certain persons, such as ambassadors or great lords, whom it was desired to honour, were received in a more intimate fashion than the crowd of courtiers. The *petit lever* was held in the bedroom itself, the *grand lever* in the *chambre de parade*. At Versailles women received their friends in their beds, both before and after childbirth, during periods of mourning, and even directly after marriage—in fact in any circumstances which were thought deserving of congratulation or condolence. During the 17th century this curious custom became general, perhaps to avoid the tiresome details of etiquette. Portable beds were used in high society in France till the end of the *ancien régime*. The earliest of which mention has been found belonged to Charles the Bold (see *Memoirs* of Philippe de Comines). They had curtains over a light framework, and were in their way as fine as the stationary beds. Iron beds appear in the 18th century; the advertisements recommend them as free from the insects which sometimes infested wooden bedsteads, but one is mentioned in the inventory of the furniture of the castle of Nerac in 1569, "un lit de fer et de cuivre, avec quatre petites colonnes de laiton, ensemble quatre satyres de laiton, quatre petits vases de laiton pour mettre sur les colonnes; dedans le dit lit il y a la figure d'Oloperne ensemble de Judith, qui sont d'albâtre." In Scotland, Brittany and Holland the closed bed with sliding or folding shutters has persisted till our own day, and in England—where beds were commonly quite simple in form—the four-poster, with tester and curtains all round, was the usual citizen's bed till the middle of the 19th century. Many fine examples exist of 17th-century carved oak bedsteads, some of which have found their way into museums. The later forms, in which mahogany was usually the wood employed, are much less architectural in design. Some exceedingly elegant mahogany bedsteads were designed by Chippendale, Hepplewhite and Sheraton, and there are signs that English taste is returning to the wooden bedstead in a lighter and less monumental form. (J. P.-B.)

BED, in geology, a term for certain kinds of rock usually found to be arranged in more or less distinct layers; these are the beds of rock or strata. Normally, the bedding of rocks is horizontal or very nearly so; when the upper and lower surfaces of a bed are parallel, the bedding is said to be regular; if it is thickest at one point and thins away thence in every direction, the bedding is lenticular. Beds may be thick (50 ft. or more) or so thin as to be like sheets of paper, e.g. paper shales, such thin beds being often termed layers or laminae; intermediate regular varieties may be called flags, flagstones or tilestones. In fine-grained rocks the bedding is usually thinner and more regular than in coarser rocks, such as sandstones and grits. Bedding is confined to rocks which have been formed under water or by the agency of wind; these are the "stratified" rocks.

The deposition of rock material by moving water is not as

a rule uniform, slight changes in the velocity produce an immediate change in the size of the particles deposited upon a given area; thus a coarse sand layer may be succeeded by a finer sand or a mud, or two sandy layers may be separated by a thin layer of muddy shale. Bedding is most often induced by a change in the nature of the contiguous strata; thus a sandstone is followed by a shale or vice versa—changes which may be due to the varying volume or velocity of a current. Or the nature of the deposit may be influenced by chemical actions, whereby we get beds of rock-salt or gypsum between beds of marl. Or again, organic activities may influence the deposit, beds of coal may succeed layers of shale, iron-stone may lie between limestones or clays, a layer of large fossils or of flints may determine a bedding plane in massive limestones. Flaky minerals like mica frequently assist in the formation of bedding planes; and the pressure of superincumbent strata upon earlier formed deposits has no doubt often produced a tendency in the particles to arrange themselves normal to the direction of pressure, thus causing the rock to split more readily along the same direction.

Where rapidly-moving currents of water (or air) are transporting or depositing sand, &c., the bedding is generally not horizontal, but inclined more or less steeply; this brings about the formation of what is variously called "cross-bedding," "diagonal bedding," "current bedding" or improperly "false bedding." Igneous materials, when deposited through the agency of water or air, exhibit bedding, but no true stratification is seen in igneous rocks that have solidified after cooling, although in granites and similar rocks the process of weathering frequently produces an appearance resembling this structure. Miners not infrequently describe a bed of rock as a "vein," if it is one that has some economic value, e.g. a "vein of coal or ironstone." (J. A. H.)

BEDARESI, YEDAIAH (1270-1340), Jewish poet, physician and philosopher of Provence. His most successful work was an ethical treatise, *Behinath Olom* (Examination of the World), a didactic poem in thirty-seven short sections. The work is still very popular. It was translated into English by Tobias Goodman.

BÉDARIEUX, a town of southern France, in the department of Hérault, on the Orb, 27 m. N.N.W. of Béziers by rail. Pop. (1906) 5504. The town has a 16th-century church, a board of trade arbitration, a chamber of arts and manufactures, a communal college and a school of drawing. Bédarieux was at one time a notable manufacturing centre. Its cloth-weaving industry, carried on under a special royal privilege from the end of the 17th century to the Revolution, employed in 1789 as many as 5000 workmen, while some thousand more were occupied in wool and cotton spinning, &c. In spite of the introduction of modern machinery from England, the industries of the place declined, mainly owing to the loss of the trade with the Levant; but of late years they have somewhat revived, owing partly to the opening up of coal mines in the neighbourhood. Besides cloth factories and wool-spinning mills, there are now numerous tanneries and leather-dressing works. There is some trade in timber, wool and agricultural produce.

BEDDGELEERT ("Gelert's grave"), a village in Carnarvonshire, North Wales, at the foot of Snowdon. The tradition of Gelert, Llewelyn's hound, being buried there is old in Wales; and common to it and India is the legend of a dog (or ichneumon) saving a child from a beast of prey (or reptile), and being killed by the child's father under the delusion that the animal had slain the infant. The English poet, W. R. Spencer, has versified the tale of Llewelyn, king of Wales, leaving Gelert and the baby prince at home, returning to find Gelert stained with the blood of a wolf, and killing the hound because he thought his child was slain. Sir W. Jones, the Welsh philologist and linguist, gives the Indian equivalent (Lord Teignmouth's *Life of Jones*, ed. Rev. S. C. Wilkes, editor's supplement). A Brahmin, leaving home, left his daughter in charge of an ichneumon, which he had long cherished. A black snake came up and was killed by the ichneumon, mistakenly killed, in its turn, by the Brahmin on

his coming back. Another version is the medieval romance in *The Seven Wise Masters of Rome*. In the edition printed by Wynkyn de Worde it is told by "the first master"—a knight had one son, a greyhound and a falcon; the knight went to a tourney, a snake attacked the son, the falcon roused the hound, which killed the serpent, lay down by the cradle, and was killed by the knight, who discovered his error, like Llewelyn, and similarly repented (Villon Society, British Museum reprint, by Gomme and Wheatley).

On the west of Beddgelert is Moel Hebog (Bare-hill of the falcon), a hiding-place of Owen Glendower. Here, in 1784, was found a brass Roman shield. Near is the famous Aberglaslyn Pass, dividing Carnarvon and Merioneth. In the centre is Cadair Rhys Goch o'r Eryri, a rock named as the chair of Rhys Goch, a bard contemporary with Glendower (died traditionally, 1420). Not far hence passed the Roman road from Uriconium to Segontium (see CARNARVON).

BEDDOES, THOMAS (1760–1808), English physician and scientific writer, was born at Shiffnal in Shropshire on the 13th of April 1760. After being educated at Bridgnorth grammar school and at Pembroke College, Oxford, he studied medicine in London under John Sheldon (1752–1808). In 1784 he published a translation of L. Spallanzani's *Dissertations on Natural History*, and in 1785 produced a translation, with original notes, of T. O. Bergman's *Essays on Elective Attractions*. He took his degree of doctor of medicine at Oxford in 1786, and, after visiting Paris, where he became acquainted with Lavoisier, was appointed reader in chemistry at Oxford University in 1788. His lectures attracted large and appreciative audiences; but his sympathy with the French Revolution exciting a clamour against him, he resigned his readership in 1792. In the following year he published *Observations on the Nature of Demonstrative Evidence*, and the *History of Isaac Jenkins*, a story which powerfully exhibits the evils of drunkenness, and of which 40,000 copies are reported to have been sold. About the same time he began to work at his project for the establishment of a "Pneumatic Institution" for treating disease by the inhalation of different gases. In this he was assisted by Richard Lovell Edgeworth, whose daughter, Anna, became his wife in 1794. In 1798 the institution was established at Clifton, its first superintendent being Humphry Davy, who investigated the properties of nitrous oxide in its laboratory. The original aim of the institution was gradually abandoned; it became an ordinary sick-hospital, and was relinquished by its projector in the year before his death, which occurred on the 24th of December 1808. Beddoes was a man of great powers and wide acquirements, which he directed to noble and philanthropic purposes. He strove to effect social good by popularizing medical knowledge, a work for which his vivid imagination and glowing eloquence eminently fitted him. Besides the writings mentioned above, he was the author of *Political Pamphlets* (1795–1797), a popular *Essay on Consumption* (1799), which won the admiration of Kant, an *Essay on Fever* (1807), and *Hygiene, or Essays Moral and Medical* (1807). He also edited John Brown's *Elements of Medicine* (1795), and *Contributions to Physical and Medical Knowledge, principally from the West of England* (1799).

A life of Beddoes by Dr John E. Stock was published in 1810.

BEDDOES, THOMAS LOVELL (1803–1849), English dramatist and poet, son of the physician, Thomas Beddoes, was born at Clifton on the 20th of July 1803. His mother was a sister of Maria Edgeworth, the novelist. He was sent to Bath grammar school and then to the Charterhouse. At school he wrote a good deal of verse and a novel in imitation of Fielding. In 1820 he was entered at Pembroke College, Oxford, and in his first year published *The Improvisator*, afterwards carefully suppressed, and in 1822 *The Bride's Tragedy*, which showed him as the disciple of the later Elizabethan and Jacobean dramatists. The play found a small circle of admirers, and procured for Beddoes the friendship of Bryan Waller Procter (Barry Cornwall). Beddoes retired to Southampton to read for his degree, and there Procter introduced him to a young lawyer, Thomas Forbes Kelsall, with whom he became very intimate, and who became

his biographer and editor. At this time he composed the dramatic fragments of *The Second Brother* and *Torrismond*. Unfortunately he lacked the power of constructing a plot, and seemed to suffer from a constitutional inability to finish anything. Beddoes was one of the first outside the limited circle of Shelley's own friends to recognize Shelley's genius, and he was certainly one of the earliest imitators of his lyrical method. In the summer of 1824 he was summoned to Florence by the illness of his mother, but she died before he arrived. He remained some time in Italy, and met Mrs Shelley and Walter Savage Landor before he returned to England. In 1825 he took his degree at Oxford, and in that year he began what he calls (*Letters*, p. 68) "a very Gothic styled tragedy" with "a jewel of a name." This work was completed in 1820 as the fantastic and incoherent drama, *Death's Jest Book* or *The Fool's Tragedy*; but he continued to revise it until his death, and it was only published posthumously. On leaving Oxford he decided to study anatomy and physiology, not, however, without some hope that his studies might, by increasing his knowledge of the human mechanism, further his efforts as a dramatist. In the autumn of 1825 he entered on his studies at Göttingen, where he remained for four years. In 1829 he removed to Würzburg, and in 1832 obtained his doctorate in medicine, but his intimate association with democratic and republican leaders in Germany and Switzerland forced him to leave Bavaria without receiving his diploma. He settled in Zürich, where he practised for some time as a physician, and was even elected to be professor of comparative anatomy at the university, but the authorities refused to ratify his appointment because of his revolutionary views. He frequently contributed political poems and articles to German and Swiss papers, but none of his German work has been identified. The years at Zürich seem to have been the happiest of his life, but in 1839 the anti-liberal riots in the town rendered it unsafe for him, and early in the next year he had to escape secretly. From this time he had no settled home, though he stored his books at Baden in Aargau. His long residence in Germany was only broken by visits to England in 1828 to take his master of arts degree, in 1835, in 1842 and for some months in 1846. He had adopted German thought and manners to such an extent that he hardly felt at home in England; and his study of the German language, which he had begun in 1825, had almost weaned him from his mother-tongue; he was, as he says in a letter, "a non-conductor of friendship"; and it is not surprising that his old friends found him much changed and eccentric. In 1847 he returned to Frankfurt, where he lived with a baker called Degen, to whom he became much attached, and whom he persuaded to become an actor. He took Degen with him to Zürich, where he chartered the theatre for one night to give his friend a chance of playing *Hotspur*. The two separated at Basel, and in a fit of dejection (May 1848) Beddoes tried to bleed himself to death. He was taken to the hospital, and wrote to his friends in England that he had had a fall from horseback. His leg was amputated, and he was in a fair way to recovery when, on the first day he was allowed to leave the hospital, he took curare, from the effects of which he died on the 26th of January 1849. His MSS. he left in the charge of his friend Kelsall.

In one of his letters to Kelsall Beddoes wrote:—"I am convinced the man who is to awaken the drama must be a bold, trampling fellow—no creeper into worm-holes—no reviser even—however good. These reanimations are vampire cold. Such ghosts as Marlow, Webster, &c., are better dramatists, better poets, I dare say, than any contemporaries of ours—but they are ghosts—the worm is in their pages" (*Letters*, p. 50). In spite of this wise judgment, Beddoes was himself a "creeper into worm-holes," a close imitator of Marston and of Cyril Tourneur, especially in their familiar handling of the phenomena of death, and in the remoteness from ordinary life of the passions portrayed. In his blank verse he caught to a certain degree the manner of his Jacobean models, and his verse abounds in beautiful imagery, but his *Death's Jest Book* is only finished in the sense of having five acts completed; it remains a bizarre

production which appeals to few minds, and to them rather for the occasional excellence of the poetry than as an entire composition. His lyrics show the influence of Shelley as well as the study of 17th-century models, but they are by no means mere imitations, and some of them, like the "Dirge for Wolfram" ("If thou wilt ease thy heart?"), and "Dream Pedlary" ("If there were dreams to sell?"), are among the most exquisite of 19th-century lyrics.

Kellsall published Beddoes' great work, *Death's Jest Book; or, The Fool's Tragedy*, in 1850. The drama is based on the story that a certain Duke Boleslaus of Münsterberg was stabbed by his court-fool, the "Isbrand" of the play (see C. F. Floegel, *Geschichte der Hofnarren*, Leipzig, 1789, pp. 297 et seq.). He followed this in 1851 with *Poems of the late Thomas Lovell Beddoes*, to which a memoir was prefixed. The two volumes were printed together (1851) with the title of *Poems, Posthumous and Collected*. All these volumes are very rare. Kellsall bequeathed the Beddoes MSS. to Robert Browning, with a note stating the real history of Beddoes' illness and death, which was kept back out of consideration for his relatives. Browning is reported to have said that if he were ever Professor of Poetry his first lecture would be on Beddoes, "a forgotten Oxford poet." Mr Edmund Gosse obtained permission to use the documents from Browning, and edited a fuller selection of the *Poetical Works* (2 vols., 1890) for the "Temple Library," supplying a full account of his life. He also edited the *Letters of Thomas Lovell Beddoes* (1894), containing a selection from his correspondence, which is full of gaiety and contains much amusing literary criticism. See also the edition of Beddoes by Ramsay Colles in the "Muses' Library" (1906).

BEDE, BEDA, or BÆDA (672 or 673-735). English historian and theologian. Of Bæda, commonly called "the Venerable Bede," almost all that we know is contained in the short autobiographical notice which he has appended to his *Ecclesiastical History*:—"Thus much concerning the ecclesiastical history of Britain, and especially of the race of the English, I, Bæda, a servant of Christ and priest of the monastery of the blessed apostles St Peter and St Paul, which is at Wearmouth and at Jarrow, have with the Lord's help composed, so far as I could gather it, either from ancient documents, or from the tradition of the elders, or from my own knowledge. I was born in the territory of the said monastery, and at the age of seven I was, by the care of my relations, given to the reverend Abbot Benedict (Biscop), and afterwards to Ceolfrid, to be educated. From that time I have spent the whole of my life within that monastery devoting all my pains to the study of the scriptures; and amid the observance of monastic discipline, and the daily charge of singing in the church, it has ever been my delight to learn or teach or write. In my nineteenth year I was admitted to the diaconate, in my thirtieth to the priesthood, both by the hands of the most reverend Bishop John (of Hexham), and at the bidding of Abbot Ceolfrid. From the time of my admission to the priesthood to my (present) fifty-ninth year, I have endeavoured, for my own use and that of my brethren, to make brief notes upon the Holy Scripture, either out of the works of the venerable fathers, or in conformity with their meaning and interpretation." Then follows a list of his works, so far as, at that date, they had been composed. As the *Ecclesiastical History* was written in 731, we obtain the following dates for the principal events in Bede's uneventful life:—birth, 672-673; entrance into the monastery, 679-680; ordination as deacon, 691-692; as priest, 702-703.

The monastery of Wearmouth was founded by Benedict Biscop in 674, and that of Jarrow in 681-682. Though some 5 or 6 m. apart, they were intended to form a single monastery under a single abbot, and so Bede speaks of them in the passage given above. It is with Jarrow that Bede is chiefly associated, though no doubt from the close connexion of the two localities he would often be at Wearmouth. The preface to the prose life of Cuthbert proves that he had stayed at Lindisfarne prior to 721, while the Epistle to Egbert shows that he had visited him at York in 733. The tradition that he went to Rome in obedience to a summons from Pope Sergius is contradicted by his own words above, and by his total silence as to any such visit. In the passage cited above, "monastic discipline, the daily charge of singing in the church, learning, teaching, writing," in other words devotion and study make up the even tenor of Bede's tranquil life. Anecdotes have been preserved which illustrate his piety both in

early and in later years; of his studies the best monument is to be found in his writings. As a little boy he would take his place among the pupils of the monastic school, though he would soon pass to the ranks of the teachers, and the fact that he was ordained deacon at nineteen, below the canonical age, shows that he was regarded as remarkable both for learning and goodness.

For the rest, it is in his works that we must chiefly seek to know him. They fall into three main classes: (1) scientific; (2) historical; (3) theological. The first class comprises works on grammar, one on natural phenomena, and two on chronology and the calendar. These last were inspired largely by the Paschal Question, which was the subject of such bitter controversy between the Roman and Celtic Churches in the 7th century. They form a natural transition to the second class. In this the chief place is held by the *Ecclesiastical History of the English Nation*. By this Bede has justly earned the title of the Father of English History. By this almost exclusively he is known to others than professed students. It is indeed one of the most valuable and one of the most beautiful of historical works. Bede has the artist's instinct of proportion, the artist's sense for the picturesque and the pathetic. His style too, modelled largely, in the present writer's opinion, on that of Gregory in the *Dialogues*, is limpid and unaffected. And though it would be wrong to call Bede a critical historian in the modern sense of the words, he shows a very unusual conscientiousness in collecting his information from the best available sources, and in distinguishing between what he believed to be fact, and what he regarded only as rumour or tradition. Other historical works of Bede are the *History of the Abbots* (of Wearmouth and Jarrow), and the lives of Cuthbert in verse and prose. The *History of the Abbots* and the prose life of Cuthbert were based on earlier works which still survive. In the case of the latter it cannot honestly be said that Bede has improved on his original. In the *History of the Abbots* he was much nearer to the facts, and could make additions out of his own personal knowledge. The Epistle to Egbert, though not historical in form, may be mentioned here, because of the valuable information which it contains as to the state of the Northumbrian Church, on which the disorders and revolutions of the Northumbrian kingdom had told with disastrous effect. It is probably the latest of Bede's extant works, as it was written in November 734, only six months before his death. The third or theological class of writings consists mainly of commentaries, or of works which, if not commentaries in name, are so in fact. They are based largely on the works of the four great Latin Fathers, SS. Augustine, Jerome, Ambrose and Gregory; though Bede's reading is very far from being limited to these. His method is largely allegorical. For the text of scripture he uses both the Latin versions, the Itala and the Vulgate, often comparing them together. But he certainly knew Greek, and possibly some Hebrew. Indeed it may be said that his works, scientific, historical and theological, practically sum up all the learning of western Europe in his time, which he thus made available for his countrymen. And not for them only; for in the school of York, founded by his pupil Archbishop Egbert, was trained Alcuin (Ealhwin) the initiator under Charles the Great of the Frankish schools, which did so much for learning on the continent. And though Bede makes no pretensions to originality, least of all in his theological works, freely taking what he needed, and (what is very rare in medieval writers) acknowledging what he took, "out of the works of the venerable Fathers," still everything he wrote is informed and impressed with his own special character and temper. His earnest yet sober piety, his humility, his gentleness, appear in almost every line. "In history and in science, as well as in theology, he is before all things the Christian thinker and student." (Plummer's *Bede*, i. 2.) Yet it should not be forgotten that Bede could hardly have done what he did without the noble library of books collected by Benedict Biscop.

Several quaint and beautiful legends have been handed down as to the origin of the epithet of "venerable" generally attached to his name. Probably it is a mere survival of a title commonly given to priests in his day. It has given rise to a false idea that

he lived to a great age; some medieval authorities making him ninety when he died. But he was not born before 672 (see above); and though the date of his death has been disputed, the traditional year, 735, is most probably correct. This would make him at most sixty-three. Of his death a most touching and beautiful account has been preserved in a contemporary letter. His last hours were spent, like the rest of his life, in devotion and teaching, his latest work being to dictate, amid ever-increasing bodily weakness, a translation into the vernacular of the Gospel of St. John, a work which unhappily has not survived. It was a fitting close to such a life as his.

BIBLIOGRAPHY.—The above sketch is largely based on the present writer's essay on Bede's Life and Works, prefixed to his edition of Bede's *Historia Ecclesiastica*, &c. (2 vols., Clarendon Press, 1896). *Beda der Ehrwürdige und seine Zeit*, by Dr Karl Werner (Vienna, 1875), is excellent. *Gehle, Disputatio . . . de Bedae vita et Scriptis* (Leiden, 1838), is still useful. Dr William Bright's *Chapters of Early English Church History* (3rd ed., Clarendon Press, 1897) is indispensable. See also *Keen's Dark Ages*, pp. 141 ff. Of the collected works of Bede the most convenient edition is that by Dr Giles in twelve volumes (8vo., 1843-1844), which includes translations of the *Historical Works*. The Continental folio editions (Basel, 1563; Cologne, 1612 and 1688) contain many works which cannot by any possibility be Bede's. The edition of Migne, *Patrologia Latina* (1862 ff.), is based on a comparison of the Cologne edition with Giles and Smith (see below), and is open to the same criticism. On the chronology and genuineness of the works commonly ascribed to Bede, see Plummer's ed., i., cxlv-clix.

On the MSS. early editions and translations of the *Historia Ecclesiastica*, see Plummer, *u.s.*, i., lxxx-cxxxii. The edition of Whelock (Cambridge, fol. 1648-1644) is noteworthy as the first English edition of the Latin text, and as the *editio princeps* of the Anglo-Saxon version ascribed to King Alfred (see ALFRED THE GREAT). Smith's edition (Cambridge, fol. 1722) contained not only these, but also the other historical works of Bede, with notes and appendices. It is a monument of learning and scholarship. The most recent edition is that with notes and introduction by the present writer, *u.s.* It includes also the *History of the Abbots*, and the *Epistle to Egbert*. Of books iii. and iv. only, there is a learned edition by Professors Mayor and Lumby of Cambridge (3rd ed., 1881). A cheap and handy edition of the text alone is that by A. Holder (Freiburg in Breisgau, 1882, &c.). The best-known modern English translation is that by the Rev. L. Gidley (1870). Of the minor historical works a good edition was edited by Rev. J. Stevenson in 1827. His edition of the Latin text, and as the *editio princeps* of the Anglo-Saxon version included in *Church Historians of England*, vol. i., part ii. (1853). See also Plummer's edition, pp. cxxiii-cxxii. (C. P.)

BEDE, CUTHBERT, the pen-name of Edward Bradley (1827-1880), English author, who was born at Kidderminster on the 25th of March 1827. He entered University College, Durham, in 1845, and later studied at Oxford, where he made the acquaintance of J. G. Wood, the naturalist. He took holy orders, and eventually became rector of Stretton in Rutlandshire. Here he gained a reputation as a humorist and numbered among his friends Cruikshank, Frank Smedley, Mark Lemon and Albert Smith. He wrote for various magazines and, in the pages of the *Illustrated London News*, introduced the double acrostic. He is chiefly known as the author of *The Adventures of Mr Verdant Green*, an *Oxford Freshman* (1853), which he also illustrated and of which a third part appeared in 1856. Several well-known Oxford characters of the time are depicted in its pages, such as Dr Plumtre the vice-chancellor, Dr Bliss the registrar, and the waiter at the Mitre. The book abounds in innocent fun. In 1883 he was given the living of Lenton, or Lavington, Lincolnshire, where he died on the 12th of December 1880.

BEDELL, WILLIAM (1571-1642), Anglican divine, was born at Black Notley in Essex, in 1571. He was educated at Cambridge, became fellow of Emmanuel in 1593, and took orders. In 1607 he was appointed chaplain to Sir H. Wotton, then English ambassador at Venice, where he remained for four years, acquiring a great reputation as a scholar and theologian. He translated the *Book of Common Prayer* into Italian, and was on terms of closest friendship with the reformer, Sarpi (Fra Paolo). In 1616 he was appointed to the rectory of Horningsheath (near Bury St Edmunds, where he had previously laboured), which he held for twelve years. In 1627 he became provost of Trinity College, Dublin, and, in 1629, bishop of Kilmore and Ardagh. He set himself to reform the abuses of his diocese, encouraged the use of the Irish language, and personally undertook the duties generally discharged by the bishop's lay chancellor. In 1633

he resigned his see. In 1641, when the Protestants were being massacred, Bedell's house was not only left untouched, but became the place of refuge for many fugitives. In the end, however, the rebels insisted upon the dismissal of all who had taken shelter in his house, and on the bishop's refusal he was seized and imprisoned with some others in the ruined castle of Loughborough. Here he was detained for several weeks, and when released, rapidly sank from the effects of exposure, and died on the 7th of February 1642.

His life was written by Bishop Gilbert Burnet in 1685, and also by his elder son (ed. T. W. Jones, for the Camden Society, 1872).

BEDESMAN, or **BRADSMAN** (Med. Eng. *bede*, prayer, from O. Eng. *biddan*, to pray; literally "a man of prayer"), generally a pensioner or almsman whose duty it was to pray for his benefactor. In Scotland there were public almsmen supported by the king and expected in return to pray for his welfare and that of the state. These men wore long blue gowns with a pewter badge on the right arm, and were nicknamed Blue Gowns. Their number corresponded to the king's years, an extra one being added each royal birthday. They were privileged to ask alms throughout Scotland. On the king's birthday each bedesman received a new blue gown, a loaf, a bottle of ale, and a leathern purse containing a penny for every year of the king's life. On the pewter badge which they wore were their name and the words "pass and repass," which authorized them to ask alms. In 1833 the appointment of bedesmen was stopped. In 1863 the last payment was paid to a bedesman. In consequence of its use in this general sense of pensioner, "bedesman" was long used in English as equivalent to "servant." The word had a special sense as the name for those almsmen attached to cathedral and other churches, whose duty it was to pray for the souls of deceased benefactors. A relic of pre-Reformation times, these old men still figure in the accounts of English cathedrals.

BEDFORD, EARLS AND DUKES OF. The present English title of duke of Bedford comes from a line of earls and dukes in the Russell family. In January 1550 John, Baron Russell, was created earl of Bedford, and in May 1694 his descendant, William, the 5th earl, became duke of Bedford. The Russell line is dealt with in the later part of this article. The title of duke of Bedford had, however, been previously held, notably by the third son of Henry IV.; and the earlier creations may first be considered here.

JOHN PLANTAGENET, duke of Bedford (1389-1435), third son of Henry IV., king of England, was born on the 20th of June 1389. He received various dignities after his father became king in 1399, and gained his early experiences in warfare when he undertook the office of warden of the east marches of Scotland in 1404; he was fairly successful in this command, which he held until September 1414. In the previous May his brother, the new king Henry V., had created him duke of Bedford, and after resigning the wardenship he began to take a leading part in the royal councils. He acted as lieutenant of the kingdom during Henry's expedition to France in 1415, and in August 1416 commanded the ships which defeated the French fleet at the mouth of the Seine, and was instrumental in relieving Harfleur. Again appointed lieutenant in July 1417, he marched against the Scots, who abandoned the siege of Berwick at his approach; and on his return to London he brought Sir John Oldcastle to trial and was present at his execution. He appears to have governed the country with considerable success until December 1419, when he resigned his office as lieutenant and joined the king in France. Returning to England, he undertook the lieutenancy for the third time in June 1421, and in the following May conducted the queen to join Henry in Normandy. He then took his brother's place and led the English troops to the relief of Cosne, but on hearing of the king's serious illness he left the army and hurried to his side. Henry's last wish was that Bedford should be guardian of the kingdom and of the young king, and that Philip the Good, duke of Burgundy, should act as regent in France. But when Philip declined to undertake this office, it too was assumed by Bedford, who, after the death of the French king Charles VI. in October 1422, presided at a session of the

parlement of Paris, and compelled all present to take an oath of fidelity to King Henry VI. Meanwhile the English parliament had decided that Bedford should be "protector and defender" of the kingdom, and that in his absence the office should devolve upon his brother Humphrey, duke of Gloucester. Confining himself to the conduct of affairs in France the protector took up Henry V's work of conquest, captured Meulan and other places, and sought to strengthen his position by an alliance with Philip of Burgundy. This task was rendered more difficult as Gloucester had just married Jacqueline, countess of Holland and Hainaut, a union which gave the English duke a claim on lands which Philip hoped to secure for himself. Bedford, however, having allayed Philip's irritation, formed an alliance with him and with John VI., duke of Brittany, at Amiens in April 1423, and himself arranged to marry Anne, a sister of the Burgundian duke. This marriage was celebrated at Troyes in the following June, and the war against Charles, the dauphin of France, was prosecuted with vigour and success. Bedford sought to restore prosperity to the districts under his rule by reforming the debased coinage, granting privileges to merchants and manufacturers, and removing various abuses. He then granted some counties to Philip to check the growing hostility between him and Gloucester, and on the 17th of August 1424 gained a great victory over a combined army of French and Scots at Verneuil. But in spite of the efforts of the protector the good understanding between England and Burgundy was partially destroyed when Gloucester invaded Hainaut in October 1424. The ambition of his brother gave Bedford trouble in another direction also; for on his return from Hainaut Gloucester quarrelled with the chancellor, Henry Beaufort, bishop of Winchester, and the council implored Bedford to come to England to settle this dispute. He reached London in January 1426, and after concluding a bond of alliance with Gloucester effected a reconciliation between the duke and the chancellor; and knighted the young king, Henry VI. Bedford then promised to act in accordance with the will of the council, and in harmony with the decision of this body raised a body of troops and returned to France in March 1427. Having ordered Gloucester to desist from a further attack on Hainaut, he threatened Brittany and compelled Duke John to return to the English alliance; and the success of his troops continued until the siege of Orleans, to which he consented with reluctance, was undertaken in October 1428. Having assured himself that Philip was prepared to desert him, Bedford sent orders to his army to raise the siege in April 1429. He then acted with great energy and judgment in attempting to stem the tide of disasters which followed this failure, strengthened his hold upon Paris, and sent to England for reinforcements; but before any engagement took place he visited Rouen, where he sought to bind the Normans closer to England, and after his return to Paris resigned the French regency to Philip of Burgundy in accordance with the wish of the Parisians. Retaining the government of Normandy Bedford established himself at Rouen and directed the movements of the English forces with some success. He did not interfere to save the life of Joan of Arc. He was joined by Henry VI. in April 1430, when the regency was temporarily suspended, and he secured Henry's coronation at Paris in December 1431. In November 1432 his wife Anne died, and in April 1433 he was married at Therouanne to Jacqueline, daughter of Pierre I., count of St Pol. But notwithstanding Bedford's vigour the English lost ground steadily; and the death of Anne and this marriage destroyed the friendly relations between England and Burgundy. Negotiations for peace had no result, and when the duke returned to England in June 1433 he told parliament that he had come home to defend himself against the charge that the losses in France were caused by his neglect, and demanded that his detractors should make their accusations public. The chancellor replied that no such charges were known to the king or the council, and the duke was thanked for his great services. His next act was to secure an inquiry into the national finances; and when asked by the parliament to stay in England he declared that his services were at the king's disposal. As

chief councillor he offered to take a smaller salary than had been previously paid to Gloucester, and undertook this office in December 1433, when his demands with regard to a continual council were conceded. Bedford, who was anxious to prosecute the war in France, left England again in 1434, but early in 1435 was obliged to consent to the attendance of English representatives at a congress held to arrange terms of peace at Arras. Unable to consent to the French terms the English envoys left Arras in September, and Philip of Burgundy made a separate treaty with France. Bedford only lived to see the ruin of the cause for which he struggled so loyally. He died at Rouen on the 14th of September 1435, and was buried in the cathedral of that city. He left a natural son, Richard, but no legitimate issue. Bedford was a man of considerable administrative ability, brave and humane in war, wise and unselfish in peace. He was not responsible for the misfortunes of the English in France, and his courage in the face of failure was as admirable as his continued endeavour to make the people under his rule contented and prosperous.

The chief contemporary authorities for Bedford's life are: *Vita et gesta Henrici Quinti*, edited by T. Hearne (Oxford, 1727); E. de Monstrelet, *Chronique*, edited by L. D. d'Arcey. (Paris, 1857-1862); William of Worcester, *Annales rerum Anglicarum*, edited by J. Stevenson (London, 1864). See also *Proceedings and Ordinances of the Privy Council of England*, edited by J. R. Dasent (London, 1890-1899); W. Stubbs, *Constitutional History*, vol. iii. (Oxford, 1895); P. A. Barant, *Histoire des ducs de Bourgogne* (Paris, 1824).

In 1470 GEORGE NEVILL (c. 1457-1483), son of John, earl of Northumberland, was created duke of Bedford; but after his father's attainder and death at the battle of Barnet in 1471 he was degraded from the peerage.

The next duke of Bedford was JASPER TUDOR (c. 1430-1495), half-brother of King Henry VI. and uncle of Henry VII. He was made earl of Pembroke in 1453. Having survived the vicissitudes of the Wars of the Roses he was restored to his earldom and created duke of Bedford in 1485. The duke, who was lord-lieutenant of Ireland from 1486 to 1494, died without legitimate issue on the 21st of December 1495.

JOHN RUSSELL, 1st earl of Bedford (c. 1486-1553), was a son of James Russell (d. 1509). Having travelled widely, he attained some position at the court of Henry VII., and was subsequently in great favour with Henry VIII. In 1513 he took part in the war with France, and, having been knighted about the same time, was afterwards employed on several diplomatic errands. He was with Henry at the Field of the Cloth of Gold in 1520, and, returning to military service when the French war was renewed, lost his right eye at the siege of Morlaix in 1522. He was soon made knight marshal of the royal household, and in 1523 went secretly to France, where he negotiated a treaty between Henry and Charles, duke of Bourbon, who was anxious to betray the French king Francis I. After a short visit to England Russell was sent with money to Bourbon, joining the constable at the siege of Marseilles. In 1524 he visited Pope Clement VII. at Rome, and, having eluded the French, who endeavoured to capture him, was present at the battle of Pavia in February 1525, returning to England about the close of the year. In January 1527 he was sent as ambassador to Clement, who employed him to treat on his behalf with Charles de Lannoy, the general of Charles V. The next few years of Russell's life were mainly spent in England. He was member of parliament for Buckingham in the parliament of 1529, and although an opponent of the party of Anne Boleyn, retained the favour of Henry VIII. He took an active part in suppressing the Pilgrimage of Grace in 1536, and was one of the commissioners appointed to try the Lincolnshire prisoners. Honours now crowded upon him. His appointment as comptroller of the king's household in 1537 was followed by that of a privy councillor in 1538; then he was made lord high admiral, high steward of the duchy of Cornwall and a knight of the garter. In March 1539 he was created Baron Russell of Chenies, and in 1542 became high steward of the university of Oxford, and keeper of the privy seal. In 1539, when Charles V. and Francis I. were threatening to invade England, he was sent into the west, and

crossed to France when Henry attacked Francis in 1544. He was in command of an army in the west of England in 1545, and when Henry died in January 1547 was one of the executors of his will. Under Edward VI. Russell was lord high steward and keeper of the privy seal, and the defeat which he inflicted on the rebels at Clist St Mary near Exeter in August 1549, was largely instrumental in suppressing the rising in Devonshire. In January 1550 he was created earl of Bedford, and was one of the commissioners appointed to make peace with France in this year. He opposed the proposal to seat Lady Jane Grey on the throne; supported Queen Mary, who reappointed him lord privy seal; and assisted to prevent Sir Thomas Wyatt's rising from spreading to Devonshire. In 1554 he went to Spain to conclude the marriage treaty between Mary and Philip II., and soon after his return died in London on the 14th of March 1555. By extensive acquisitions of land Bedford was the founder of the wealth and greatness of the house of Russell. Through his wife, Anne (d. 1550), daughter of Sir Guy Sapcote, whom he married in 1526, he obtained Chenies, and in 1530 was granted the forest of Exmoor, and also Tavistock, and a number of manors in Devon, Cornwall and Somerset, which had formerly belonged to the abbey of Tavistock. In 1549 he received Thorney, the abbey of Woburn, and extensive lands in the eastern counties; and in 1552 Covent Garden and seven acres of land in London, formerly the property of the protector Somerset. He left an only son, Francis, who succeeded him in the title.

See *Letters and Papers of Henry VIII.* (London, 1862-1901); *State Papers during the Reign of Henry VIII.* (London, 1831-1852); *Calendar of State Papers, Edward VI. and Mary* (London, 1861); J. H. Wiffen, *Historical Memoirs of the House of Russell* (London, 1833); J. A. Froude, *History of England, passim* (London, 1881 fol.).

FRANCIS RUSSELL, 2nd earl of Bedford (c. 1527-1585), was educated at King's Hall, Cambridge. He accompanied his father to the French war in 1544, and from 1547 to 1552 was member of parliament for Buckinghamshire, being probably the first heir to a peerage to sit in the House of Commons. He assisted to quell the rising in Devonshire in 1549, and after his father had been created earl of Bedford in January 1550, was known as Lord Russell, taking his seat in the House of Lords under this title in 1552. Russell was in sympathy with the reformers, whose opinions he shared, and was in communication with Sir Thomas Wyatt; and in consequence of his religious attitude was imprisoned during the earlier part of Mary's reign. Being released he went into exile; visited Italy; came into touch with foreign reformers; and fought at the battle of St Quentin in 1557. Afterwards he seems to have enjoyed some measure of the royal favour, and was made lord-lieutenant of the counties of Devon, Cornwall and Dorset early in 1558. When Elizabeth ascended the throne in November 1558 the earl of Bedford, as Russell had been since 1555, became an active figure in public life. He was made a privy councillor, and was sent on diplomatic errands to Charles IX. of France and Mary queen of Scots. From February 1564 to October 1567 he was governor of Berwick and warden of the east marches of Scotland, in which capacity he conducted various negotiations between Elizabeth and Mary. He appears to have been an efficient warden, but was irritated by the vacillating and tortuous conduct of the English queen. When the northern insurrection broke out in 1569, Bedford was sent into Wales, and he sat in judgment upon the duke of Norfolk in 1572. In 1576 he was president of the council of Wales, and in 1581 was one of the commissioners deputed to arrange a marriage between Elizabeth and Francis, duke of Anjou. Bedford, who was made a knight of the garter in 1564, was lord warden of the Stannaries from 1553 to 1580. He appears to have been a generous and popular man, and died in London on the 28th of July 1585. He was buried at Chenies. His first wife was Margaret (d. 1562), daughter of Sir John St John, by whom he had four sons and three daughters. His three eldest sons predeceased their father. His second wife was Bridget (d. 1601), daughter of John, Lord Hussey. He was succeeded as 3rd earl by his grandson, EDWARD (1572-1627), only son of Francis, Lord Russell (c. 1550-1585).

The 3rd earl left no children when he died on the 3rd of May 1627, and was succeeded by his cousin.

FRANCIS RUSSELL, 4th earl of Bedford (1593-1641), was the only son of William, Lord Russell of Thornhaugh, to which barony he succeeded in August 1613. For a short time previously he had been member of parliament for the borough of Lyme Regis; in 1623 he was made lord-lieutenant of Devonshire; and in May 1627 became earl of Bedford by the death of his cousin, Edward, the 3rd earl. When the quarrel broke out between Charles I. and the parliament, Bedford supported the demands of the House of Commons as embodied in the Petition of Right, and in 1629 was arrested for his share in the circulation of Sir Robert Dudley's pamphlet, "Proposition for His Majesty's service," but was quickly released. The Short parliament meeting in April 1640 found the earl as one of the king's leading opponents. He was greatly trusted by John Pym and Oliver St John, and is mentioned by Clarendon as among the "great contrivers and designers" in the House of Lords. In July 1640 he was among the peers who wrote to the Scottish leaders refusing to invite a Scottish army into England, but promising to stand by the Scots in all legal and honourable ways; and his signature was afterwards forged by Thomas, Viscount Savile, in order to encourage the Scots to invade England. In the following September he was among those peers who urged Charles to call a parliament, to make peace with the Scots, and to dismiss his obnoxious ministers; and was one of the English commissioners appointed to conclude the treaty of Ripon. When the Long parliament met in November 1640, Bedford was generally regarded as the leader of the parliamentarians. In February 1641 he was made a privy councillor, and during the course of some negotiations was promised the office of lord high treasurer. He was essentially a moderate man, and seemed anxious to settle the question of the royal revenue in a satisfactory manner. He did not wish to alter the government of the Church, was on good terms with Archbishop Laud, and although convinced of Strafford's guilt, was anxious to save his life. In the midst of the parliamentary struggle Bedford died of smallpox on the 9th of May 1641. Clarendon described him as "a wise man, and of too great and plentiful a fortune to wish the subversion of the government," and again referring to his death said that "many who knew him well thought his death not unseasonable as well to his fame as his fortune, and that it rescued him as well from some possible guilt as from those visible misfortunes which men of all conditions have since undergone." Bedford was the head of those who undertook to drain the great level of the fens, called after him the "Bedford level." He spent a large sum of money over this work and received 43,000 acres of land, but owing to various jealousies and difficulties the king took the work into his own hands in 1638, making a further grant of land to the earl. Bedford married Catherine (d. 1657), daughter of Giles, 3rd Lord Chandos, by whom he had four sons and four daughters. His eldest son, WILLIAM (1613-1700), succeeded him as 5th earl, fought first on the side of the parliament and then on that of the king during the Civil War, and in 1694 was created marquess of Tavistock and duke of Bedford.

See Clarendon, *History of the Rebellion, passim* (Oxford, 1888); J. H. Wiffen, *Historical Memoirs of the House of Russell* (London, 1833); J. L. Sanford, *Studies and Illustrations of the Great Rebellion* (London, 1858).

The first duke, who married Anne (d. 1684), daughter of Robert Carr, earl of Somerset, was succeeded in the title by his grandson Wriothersley (1680-1711), who was a son of Lord William Russell (q.v.) by his marriage with Rachel, daughter of Thomas Wriothersley, 4th earl of Southampton, and who became second duke in 1700. Eleven years later the second duke was succeeded by his eldest son Wriothersley (1708-1732), who died without issue in October 1732, when the title passed to his brother John.

JOHN RUSSELL, 4th duke of Bedford (1710-1771), second son of Wriothersley Russell, 2nd duke of Bedford, by his wife, Elizabeth, daughter and heiress of John Howland of Streatham, Surrey, was born on the 30th of September 1710. Known as Lord John Russell, he married in October 1731 Lady Diana Spencer, daughter of Charles, 3rd earl of Sunderland; became duke of

Bedford on his brother's death a year later; and having lost his first wife in 1735, married in April 1737 Lady Gertrude Leveson-Gower (d. 1794), daughter of John, Earl Gower. In the House of Lords he joined the party hostile to Sir Robert Walpole, took a fairly prominent part in public business, and earned the dislike of George II. When Carteret, now Earl Granville, resigned office in November 1744, Bedford became first lord of the admiralty in the administration of Henry Pelham, and was made a privy councillor. He was very successful at the admiralty, but was not equally fortunate after he became secretary of state for the southern department in February 1748. Pelham accused him of idleness; he was constantly at variance with the duke of Newcastle, and resigned office in June 1751. Instigated by his friends he was active in opposition to the government, and after Newcastle's resignation in November 1756, became lord-lieutenant of Ireland in the ministry of William Pitt and the duke of Devonshire, retaining this office after Newcastle, in alliance with Pitt, returned to power in June 1757. In Ireland he favoured a relaxation of the penal laws against Roman Catholics, but did not keep his promises to observe neutrality between the rival parties, and to abstain from securing pensions for his friends. His own courtly manners and generosity, and his wife's good qualities, however, seem to have gained for him some popularity, although Horace Walpole says he disgusted everybody. In March 1761 he resigned this office. Having allied himself with the earl of Bute and the party anxious to bring the Seven Years' War to a close, Bedford was noticed as the strongest opponent of Pitt, and became lord privy seal under Bute after Pitt resigned in October 1761. The cabinet of Bute was divided over the policy to be pursued with regard to the war, but pacific counsels prevailed, and in September 1762 Bedford went to France to treat for peace. He was considerably annoyed because some of the peace negotiations were conducted through other channels, but he signed the peace of Paris in February 1763. Resigning his office as lord privy seal soon afterwards, various causes of estrangement arose between Bute and Bedford, and the subsequent relations of the two men were somewhat virulent. The duke refused to take office under George Grenville on Bute's resignation in April 1763, and sought to induce Pitt to return to power. A report, however, that Pitt would only take office on condition that Bedford was excluded, incensed him and, smarting under this rebuff, he joined the cabinet of Grenville as lord president of the council in September 1763. His haughty manner, his somewhat insulting language, and his attitude with regard to the regency bill in 1765 offended George III., who sought in vain to supplant him, and after this failure was obliged to make humiliating concessions to the ministry. In July 1765, however, he was able to dispense with the services of Bedford and his colleagues, and the duke became the leader of a political party, distinguished for rapacity, and known as the "Bedford party," or the "Bloomsbury gang." During his term of office he had opposed a bill to place high import duties on Italian silks. He was consequently assaulted and his London residence attacked by a mob. He took some part in subsequent political intrigues, and although he did not return to office, his friends, with his consent, joined the ministry of the duke of Grafton in December 1767. This proceeding led "Junius" to write his "letter to the duke of Bedford," one of especial violence. Bedford was hostile to John Wilkes, and narrowly escaped from a mob favourable to the agitator at Honiton in July 1769. His health had been declining for some years, and in 1770 he became partially paralysed. He died at Woburn on the 15th of January 1771, and was buried in the family burying-place at Cheney. His three sons all predeceased him, and he was succeeded in the title by his grandson, Francis. The duke held many public offices: lord-lieutenant of Bedfordshire and Devonshire, and chancellor of Dublin University among others, and was a knight of the garter. Bedford was a proud and conceited man, but possessed both ability and common-sense. The important part which he took in public life, however, was due rather to his wealth and position than to his personal taste or ambition. He was neither above nor below the standard of political morality

of the time, and was influenced by his duchess, who was very ambitious, and by followers who were singularly unscrupulous.

See *Correspondence of John, 4th Duke of Bedford*, edited by Lord John Russell (London, 1822-1846); J. H. Wiffen, *Historical Memoirs of the House of Russell* (London, 1833); W. E. H. Lecky, *History of England*, vol. iii. (London, 1892); Horace Walpole, *Memoirs of the Reign of George II.* (London, 1847); and *Memoirs of the Reign of George III.*, edited by G. F. R. Barker (London, 1894.)

FRANCIS RUSSELL, 5th duke of Bedford (1765-1802), eldest son of Francis Russell, marquess of Tavistock (d. 1767), by his wife, Elizabeth (d. 1768), daughter of William Keppel, 2nd earl of Albemarle, was baptized on the 23rd of July 1765. In January 1771 he succeeded his grandfather as duke of Bedford, and was educated at Westminster school and Trinity College, Cambridge, afterwards spending nearly two years in foreign travel. Regarding Charles James Fox as his political leader, he joined the Whigs in the House of Lords, and became a member of the circle of the prince of Wales, afterwards George IV. Having overcome some nervousness and educational defects, he began to speak in the House, and soon became one of the leading debaters in that assembly. He opposed most of the measures brought forward by the ministry of William Pitt, and objected to the grant of a pension to Edmund Burke, an action which drew down upon him a scathing attack from Burke's pen. Bedford was greatly interested in agriculture. He established a model farm at Woburn, and made experiments with regard to the breeding of sheep. He was a member of the original board of agriculture, and was the first president of the Smithfield club. He died at Woburn on the 2nd of March 1802, and was buried in the family burying-place at Cheney. The duke was never married, and was succeeded in the title by his brother, John.

See Lord Holland, *Memoirs of the Whig Party* (London, 1854); J. H. Wiffen, *Historical Memoirs of the House of Russell* (London, 1833); E. Burke, *Letter to a Noble Lord* (Edinburgh, 1837); and Earl Stanhope, *Life of Pitt* (London, 1861-1862).

JOHN RUSSELL, 6th duke of Bedford (1766-1839), was succeeded as seventh duke by his eldest son, Francis (1788-1861), who had an only son, William (1809-1872), who became duke on his father's death in 1861. When the eighth duke died in 1872, he was succeeded by his cousin, Francis Charles Hastings (1819-1891), who was member of parliament for Bedfordshire from 1847 until he succeeded to the title. The ninth duke was the eldest son of Major-General Lord George William Russell (1790-1846), who was a son of the sixth duke. He married Elizabeth, daughter of George John, 5th Earl de la Warr, and both his sons, George William Francis Sackville (1852-1893), and Herbrand Arthur (b. 1858), succeeded in turn to the title.

BEDFORD, a municipal and parliamentary borough, and the county town of Bedfordshire, England, 50 m. north-north-west of London by the Midland railway; served also by a branch of the London & North-Western. Pop. (1901) 35,144. It lies in the fertile valley of the Ouse, on both banks, but mainly on the north, on which stands the mound which marks the site of the ancient castle. The church of St Paul is Decorated and Perpendicular, but its central tower and spire are modern; it contains the tomb of Sir William Harper or Harpur (c. 1496-1573), lord mayor of London, a notable benefactor of his native town of Bedford. St Peter's church has in its central tower masonry probably of pre-Conquest date; that of St Mary's is in part Norman, and that of St John's Decorated; but the bodies of these churches are largely restored. There are some remains of a Franciscan friary of the 14th century. The Congregational chapel called Bunyan's or the "Old Meeting" stands on the site of the building in which John Bunyan preached from 1636 onward. His chair is preserved here, and a tablet records his life in the town, where he underwent a long but in part nominal imprisonment. He was born at Elstow, 1½ m. from Bedford, where, while playing on the green, he believed himself to have received the divine summons to renounce sin. In the panels of a fine pair of bronze doors in the chapel are scenes illustrative of Bunyan's *Pilgrim's Progress*. Bedford is noted for its grammar school, founded by Edward VI. in 1552, and endowed by Sir William Harpur. The existing buildings date from 1891, and have been increased since

that date, and the school is one of the important public schools of England. Harper's endowment includes land in London, and is now of great value, and the Harper Trust supports in addition modern and elementary schools for boys and girls, a girls' high school, and almshouses. The grammar school annually awards both entrance exhibitions and two exhibitions to a university or other higher educational institution. The old grammar school buildings are used as a town hall; and among other modern buildings may be mentioned the shire hall and county hospital. There are statues of John Bunyan (1874) and John Howard (1894) the philanthropist (1726-1790), who founded the Congregational chapel which bears his name, and resided at Cardington in the vicinity. There are two parks. Bedford has a large trade as a market town for agricultural produce, and extensive engineering works and manufactures of agricultural implements. The parliamentary borough returns one member. The municipal borough is under a mayor, 6 aldermen and 18 councillors. Area, 2223 acres.

Bedford (Bedcanforda, Bedanforda, Bedeford) is first mentioned in 571, when Cuthwulf defeated the Britons here. It subsequently became a Danish borough, which in 914 was captured by Edward the Elder. In Domesday, as the county town, it was entered apart from the rest of the shire, and was assessed at half a hundred for the host and for ship service. The prescriptive borough received its first charter from Henry II., who gave the town to the burgesses to hold at a fee-farm rent of £40 in lieu of all service. The privileges included a gild-merchant, all tolls, and liberties and laws in common with the citizens of Oxford. This charter was confirmed by successive sovereigns down to Charles II. During the 15th century, owing to the rise of other market towns, Bedford became less prosperous, and the fee-farm rent was finally reduced to £20 by charter of Henry VII. Henry VIII. granted a November fair to St Leonard's hospital, which was still held in the 19th century at St Leonard's farm, the site of the hospital. Mary granted two fairs, one in Lent and one on the Feast of the Conception, and also a weekly market. A 17th century pamphlet on river navigation in Bedfordshire mentions the trade which Bedford carried on in coal, brought by the Ouse from Lynn and Yarmouth. The town was also one of the earliest centres of the lace trade, to the success of which French refugees in the 17th and 18th centuries largely contributed.

Bedford was represented in the parliament of 1295, and after that date two members were returned regularly, until by the Redistribution of Seats Act in 1885 Bedford lost one of its members. The unlimited power of creating freemen, an inherent right of the borough, led to great abuse, noticeably in 1769 when 500 freemen¹ were created to support the political interest of Sir Robert Barnard, afterwards recorder of the borough.

Bedford castle, of which mention is first heard during Stephen's reign (1136), was destroyed by order of Henry III. in 1224. The mound marking its site is famous as a bowling-green.

BEDFORD, a city and the county-seat of Lawrence county, Indiana, U.S.A., in the south-central part of the state, about 60 m. north-west of Louisville, Kentucky. Pop. (1890) 3351; (1910) 8716. It is served by the Baltimore & Ohio Southwestern, the Chicago, Indianapolis & Louisville, the Southern Indiana, and (for freight from the Wallner quarries about 5 m. distant) the Bedford & Wallner railways. It is the shipping point of the Bedford Indiana (oolitic) limestone, which is found in the vicinity and is one of the most valuable and best known building stones in the United States—of this stone were built the capitols of Indiana, Georgia, Mississippi and Kentucky; the state historical library at Madison, Wisconsin; the art building at St Louis, Missouri; and many other important public buildings. The city has large cement works, foundries and machine shops (stone-working machinery being manufactured), and the repair shops of the Southern Indiana railway. Bedford was settled in 1826 and received a city charter in 1889.

BEDFORD, a borough and the county-seat of Bedford county, Pennsylvania, U.S.A., on the Raystown branch of the Juniata river, about 35 m. south by west of Altoona. Pop. (1890) 2242;

¹ Called "ginea-pigs."

(1910) 2235. Bedford is served by the Bedford branch of the Pennsylvania railway. It lies in a beautiful valley. In the borough are some interesting old houses, erected in the latter part of the 18th century, an art gallery and a soldiers' monument. There are deposits of hematite and limestone near the borough, and less than 2 m. south of it are the widely-known Bedford Mineral Springs—a magnesia spring, a limestone spring, a sulphur spring, and a "sweet-water" spring—which attract many visitors during the summer season. There are also chalybeate and other less important springs about the same distance east of the borough, and a white sulphur spring 10 m. south-west of it. Bedford has a large wholesale grocery trade, manufactures flour, dressed lumber, kegs and handles, and is situated in a fine fruit-growing district, especially known for its apples and plums. The borough owns and operates the water works. A temporary settlement was made on or near the site of the present borough about 1750 by an Indian trader named Ray, and for a few years the place was known as Raystown; the present name was adopted not later than 1759. In July 1758 Fort Bedford, for many years an important military post on the frontier, was constructed, and here, later in the year, General John Forbes brought together his troops preparatory to advancing against Fort Duquesne. The town of Bedford was laid out in 1769, and in 1771 it was made the county-seat of Bedford county, which was organized in that year. The borough was incorporated in 1795, and received a new charter in 1817. Washington came here in 1794 to review the army sent to quell the Whisky Insurrection, and the Espy house, which he then occupied, is still standing.

BEDFORDSHIRE (abbreviated Beds), a south midland county of England, bounded N. E. by Huntingdonshire, E. by Cambridgeshire, S. E. by Hertfordshire, W. by Buckinghamshire and N. W. by Northamptonshire. It is the fourth smallest English county, having an area of 466.4 sq. m. It lies principally in the middle part of the basin of the river Ouse, which, entering in the north-west, traverses the rich and beautiful Vale of Bedford with a serpentine course past the county town of Bedford to the north-eastern corner near St Neots. North of it the land is undulating, but low; to the south, a well-wooded spur of the Chiltern Hills separates the Vale of Bedford from the flat open tributary valley of the Ivel. A small part of the main line of the Chilterns is included in the south of the county, the hills rising sharply from the lowland to bare heights exceeding 600 ft. above Dunstable. In this neighbourhood the county includes the headwaters of the Lea, and thus a small portion of it falls within the Thames basin. In the north a few streams are tributary to the Nene.

Geology.—The general trend of the outcrops of the various formations is from south-west to north-east; the dip is south-easterly. In the northern portion of the county, the Middle Oolites are the most important, and of these, the Oxford Clay predominates over most of the low ground upon which Bedford is situated. At Ampt-hill a development of clay, the Ampt-hill clay, represents the Corallian limestone of neighbouring counties. The Corallian is represented by no more than about 2 ft. of limestone; but the Kellaways Rock is well exposed near Bedford; the sandy parts of this rock are frequently cemented to form hard masses called "doggers." The Great Ouse, from the point where it enters the county on the west, has carved through the Middle Oolites and exposed the Great Oolite as far as Bedford; their alternating limestones and clays may be seen in the quarries not far from the town. From Woburn through Ampt-hill to Potton a more elevated tract is formed by the Lower Greensand. These rocks are sandy throughout. At Leighton Buzzard they are dug on a large scale for various purposes. Beds of fuller's earth occur in this formation at Woburn. At Potton, ammonite, phosphatized nodules may be obtained, and here a hard bed, the "Carstone," lies at the top of the formation. Above the Lower Greensand comes the Gault Clay, which lies in the broad vale south-east of the former and north-west of the Chalk hills. The Chalk rises up above the Gault and forms the high ground of Dunshill Moors and the Chiltern Hills. At the base of the Chalk is the Chalk Marl, above this is the Totternhoe Stone, which, on account of its great hardness, usually stands out as a well-marked feature. The Lower Chalk, which comes next in the upward succession, is capped in a similar manner by the hard Chalk Rock, as at Royston and elsewhere. The upper Chalk-with-Flints occurs near the south-eastern boundary. Patches of glacial boulder clay and gravel lie upon the older rocks over most of the area. Many interesting mammalian fossils, rhinoceros, mammoth, &c., with palaeolithic implements, have been found in the valley gorges of the river Ouse and its tributaries.

Industries.—Agriculture is important, nearly nine-tenths of the total area being under cultivation. The chief crop is wheat, for which the soil in the Vale of Bedford is specially suited; while on the sandy loam of the Ivel valley, in the neighbourhood of Biggleswade, market-gardening is extensively carried on, the produce going principally to London, whither a considerable quantity of butter and other dairy-produce is also sent. The manufacture of agricultural machinery and implements employs a large number of hands at Bedford and Luton. Luton, however, is specially noted for the manufacture of straw hats. Straw-plaiting was once extensively carried on in this neighbourhood by women and girls in their cottage homes, but has now almost entirely disappeared owing to the importation of Chinese and Japanese plaited straw. Another local industry in the county is the manufacture of pillow-lace. Many of the lace designs are French, as a number of French refugees settled in and near Cranfield. Mechlin and Maltese patterns are also copied.

Communications are provided in the east by the Great Northern main line, passing Biggleswade, and in the centre by that of the Midland railway, serving Ampthill and Bedford. The Bletchley and Cambridge branch of the London & North-Western railway crosses these main lines at Bedford and Sandy respectively. The main line of the same company serves Leighton Buzzard in the south-west, and there is a branch thence to Dunstable, which, with Luton, is also served by a branch of the Great Northern line. A branch of the Midland railway south from Bedford connects with the Great Northern line at Hitchin, and formerly afforded the Midland access to London over Great Northern metals.

Population and Administration.—The area of the ancient county is 298,404 acres, with a population in 1801 of 161,704 and in 1901 of 171,242. The area of the administrative county is 302,947 acres. The municipal boroughs are Bedford (pop. 35,144), Dunstable (5157) and Luton (36,404). The other urban districts are—Ampthill (2177), Biggleswade (5120), Kempston, connected with Bedford to the south-west (4720), and Leighton Buzzard (6331). Potton (2033), Shefford (874), and Woburn (1120) are lesser towns, and local centres of the agricultural trade. The county is the midland circuit, and assizes are held at Bedford. It has one court of quarter-sessions, and is divided into eight petty sessional divisions. The boroughs of Bedford, Dunstable and Luton have separate commissions of the peace, and Bedford has a separate court of quarter-sessions. There are 133 civil parishes. Bedfordshire forms an archdeaconry in the diocese of Ely, with 125 ecclesiastical parishes and parts of 6 others. The county has two parliamentary divisions, Northern (or Biggleswade), and Southern (or Luton), each returning one member; and Bedford is a parliamentary borough, returning one member. The principal institution, apart from those in the towns, is the great Three Counties asylum (for Bedfordshire, Hertfordshire and Huntingdonshire), in the south-east of the county near Arlesley.

History.—Although the Saxon invaders were naturally attracted to Bedfordshire by its abundant water supply and facilities for agriculture, the remains of their settlements are few and scattered. They occur, with one exception, south of the Ouse, the most important being a cemetery at Kempston, where two systems—cremation and earth-burial—are found side by side. Early reference to Bedfordshire political history is scanty. In 571 Cuthwulf inflicted a severe defeat on the Britons at Bedford and took four towns. During the Heptarchy what is now the shire formed part of Mercia; by the treaty of Wedmore, however, it became Danish territory, but was recovered by King Edward (919-921). The first actual mention of the county comes in 1016 when King Canute laid waste to the whole shire. There was no organized resistance to the conqueror within Bedfordshire, though the Domesday survey reveals an almost complete substitution of Norman for English holders. In the civil war of Stephen's reign the county suffered severely; the great Roll of the Exchequer of 1165 proves the shire receipts had depreciated in value to two-thirds of the assessment for the

Danegeld. Again the county was thrown into the barons' war when Bedford Castle, seized from the Beauchamps by Falkes de Breaute, one of the royal partisans, was the scene of three sieges before it was demolished by the king's orders in 1224. The peasants' revolt (1377-1381) was marked by less violence here than in neighbouring counties; the Annals of Dunstable make brief mention of a rising in that town and the demand for and granting of a charter. In 1638 ship-money was levied on Bedfordshire, and in the Civil War that followed, the county was one of the foremost in opposing the king. Clarendon observes that here Charles had no visible party or fixed quarter.

Bedfordshire is divided into nine hundreds, Barford, Biggleswade, Clifton, Flitt, Manshead, Redbornestoke, Stodden, Willey and Wiscamtree, and the liberty, half hundred or borough of Bedford. From the Domesday survey it appears that in the 11th century there were three additional half hundreds, viz. Stanburge, Buchelai and Weneslai, which had by the 14th century become parts of the hundreds of Manshead, Willey and Biggleswade respectively. Until 1574 one sheriff did duty for Bedfordshire and Buckinghamshire, the shire court of the former being held at Bedford. The jurisdiction of the hundred courts, excepting Flitt, remained in the king's possession. Flitt was parcel of the manor of Luton, and formed part of the marriage portion of Eleanor, sister of Henry III. and wife of William Marshall. The burgesses of Bedford and the prior of Dunstable claimed jurisdictional freedom in those two boroughs. The *Hundred Rolls* and the *Placita de quo warranto* show that important jurisdiction had accrued to the great over-lordships, such as those of Beauchamp, Wahull and Caynho, and to several religious houses, the prior of St John of Jerusalem claiming rights in more than fifty places in the county.

With regard to parliamentary representation, the first original writ which has been discovered was issued in 1200 when two members were returned for the county. In 1205 in addition to the county members, writs are found for two members to represent Bedford borough. Subsequently until modern times two county and two borough members were returned regularly.

Owing to its favourable situation Bedfordshire has always been a prominent agricultural rather than manufacturing county. From the 13th to the 15th century sheep farming flourished, Bedfordshire wool being in request and plentiful. Surviving records show that in assessments of wool to the king, Bedfordshire always provided its full quota. Tradition says that the straw-plait industry owes its introduction to James I., who transferred to Luton the colony of Lorraine plaiters whom Mary queen of Scots had settled in Scotland. Similarly the lace industry is associated with Catherine of Aragon, who, when trade was dull, burnt her lace and ordered new to be made. As late as the 19th century the lace makers kept "Catter's Day" as the holiday of their craft. The Flemings, expelled by Alva's persecutions (1569), brought the manufacture of Flemish lace to Cranfield, whence it spread to surrounding districts. The revocation of the edict of Nantes, and consequent French immigration, gave further impetus to the industry. Defoe writing in 1724-1727 mentions the recent improvements in the Bedfordshire bone-lace manufacture. In 1794 further French refugees joined the Bedfordshire lace makers.

Woburn Abbey, belonging to the Russells since 1547, is the seat of the duke of Bedford, the greatest landowner in the county. The Burgoynes of Sutton, whose baronetcy dates from 1641, have been in Bedfordshire since the 15th century, whilst the Osborn family have owned Chicksands Priory since its purchase by Peter Osborn in 1576. Sir Phillip Monoux Payne represents the ancient Monoux family of Wootton. Other county families are the Crawleys of Stockwood near Luton, the Brandreths of Houghton Regis, and the Orlebars of Hinwick.

With the division of the Mercian diocese in 679 Bedfordshire fell naturally to the new see of Dorchester. It formed part of Lincoln diocese from 1075 until 1837, when it was finally transferred to Ely. In 1291 Bedfordshire was an archdeaconry

including six rural deaneries, which remained practically unaltered until 1880, when they were increased to eleven with a new schedule of parishes.

Antiquities.—The monastic remains in Bedfordshire include the fine fragment of the church of the Augustinian priory at Dunstable, serving as the parish church; the church (also imperfect) of Elstow near Bedford, which belonged to a Benedictine nunnery founded by Judith, niece of William the Conqueror; and portions of the Gilbertine Chicksands Priory and of a Cistercian foundation at Old Warden. In the parish churches, many of which are of great interest, the predominant styles are Decorated and Perpendicular. Work of pre-Conquest date, however, is found in the massive tower of Clapham church, near Bedford on the north, and in a door of Stevington church. Fine Norman and Early English work is seen at Dunstable and Elstow, and the later style is illustrated by the large cruciform churches at Leighton Buzzard and at Felmersham on the Ouse above Bedford. Among the Perpendicular additions to the church last named may be noted a very beautiful oaken rood-screen. To illustrate Decorated and Perpendicular the churches of Clifton and Marston Moretaine, with its massive detached campanile, may be mentioned; and Cople church is a good specimen of fine Perpendicular work. The church of Cockayne Hatley, near Potten, is fitted with rich Flemish carved wood, mostly from the abbey of Aine near Charleroi, and dating from 1680, but brought here by a former rector early in the 19th century. In medieval domestic architecture the county is not rich. The mansion of Woburn Abbey dates from the middle of the 18th century.

AUTHORITIES.—*Victoria County History* (London, 1904, &c.); *Fishe, Collections, Historical, Genealogical and Topographical, for Bedfordshire* (London, 1812-1816, and also 1812-1836); J. D. Parrv, *Select Illustrations of Bedfordshire* (London, 1827); *Bedfordshire Domesday Book* (Bedford, 1881); *Visitation of Bedford, 1506, 1582, and 1634*, in *Harleian Society's Publications*, vol. xiv. (London, 1884); *Genealogical Bedfordians*, 1538, 1800 (London, 1890); and *Illustrated Bedfordshire* (Nottingham, 1895). See also *Bedfordshire Notes and Queries*, ed. F. A. Blades, and *Transactions of the Bedfordshire Natural History and Field Club*.

BEDLAM, or BETHLEHEM HOSPITAL, the first English lunatic asylum, originally founded by Simon FitzMary, sheriff of London, in 1247, as a priory for the sisters and brethren of the order of the Star of Bethlehem. It had as one of its special objects the housing and entertainment of the bishop and canons of St Mary of Bethlehem, the mother-church, on their visits to England. Its first site was in Bishopsgate Street. It is not certain when lunatics were first received in Bedlam, but it is mentioned as a hospital in 1330 and some were there in 1403. In 1547 it was handed over by Henry VIII. with all its revenues to the city of London as a hospital for lunatics. With the exception of one such asylum in Granada, Spain, the Bethlehem Hospital was the first in Europe. It became famous and afterwards infamous for the brutal ill-treatment meted out to the insane (see *INSANITY: Hospital Treatment*). In 1675 it was removed to new buildings in Moorfields and finally to its present site in St George's Fields, Lambeth. The word "Bedlam" has long been used generally for all lunatic asylums.

BEDLINGTON, an urban district of Northumberland, England, within the parliamentary borough of Morpeth, 5 m. S.E. of that town on a branch of the North Eastern railway. Pop. (1901) 18,766. It lies on high ground above the river Blyth, 2½ m. above its mouth. The church of St Cuthbert shows good transitional Norman details. Its dedication recalls the transportation of the body of the saintly bishop of Lindisfarne from his shrine at Durham by the monks of that foundation to Lindisfarne, when in fear of attack from William the Conqueror. They rested here with the coffin. The modern growth of the town is attributable to the valuable collieries of the neighbourhood, and to manufactures of nails and chains. It is one of the most populous mining centres in the county. On the south bank of the river is the township and urban district of Cowpen (pop. 17,879), with collieries and glass works; coal is shipped from this point by river.

Bedlington (Betlington) and the hamlets belonging to it were bought by Cuthbert, bishop of Durham, between 900 and 915, and although locally situated in the county of Northumberland became part of the county palatine of Durham over which Bishop Walcher was granted royal rights by William the Conqueror. When these rights were taken from Cuthbert Tunstall, bishop of Durham, in 1536, Bedlington among his other property lost its special privileges, but was confirmed to him in 1541 with the other property of his predecessors. Together with the other lands of the see of Durham, Bedlington was made over to the ecclesiastical commissioners in 1866. Bedfordshire was made part of Northumberland for civil purposes by acts of parliament in 1832 and 1844.

BEDLOE, WILLIAM (1650-1680), English informer, was born at Chepstow on the 20th of April 1650. He appears to have been well educated; he was certainly clever, and after coming to London in 1670 he became acquainted with some Jesuits and was occasionally employed by them. Calling himself now Captain Williams, now Lord Gerard or Lord Newport or Lord Cornwallis, he travelled from one part of Europe to another; he underwent imprisonments for crime, and became an expert in all kinds of duplicity. Then in 1678, following the lead of Titus Oates, he gave an account of a supposed popish plot to the English government, and his version of the details of the murder of Sir E. B. Godfrey was rewarded with £500. Emboldened by his success he denounced various Roman Catholics, married an Irish lady, and having become very popular lived in luxurious fashion. Afterwards his fortunes waned, and he died at Bristol on the 20th of August 1680. His dying depositions, which were taken by Sir Francis North, chief justice of the common pleas, revealed nothing of importance. Bedloe wrote a *Narrative and impartial discovery of the horrid Popish Plot* (1679), but all his statements are extremely untrustworthy. See J. Pollock, *The Popish Plot* (1903).

BEDMAR, ALPHONSO DELLA CUEVA, MARQUIS OF (1572-1655), Spanish diplomatist, became ambassador to the republic of Venice in 1667. This was a very important position owing to the amount of information concerning European affairs which passed through the hands of the representative of Spain. When Bedmar took up this appointment, Venice had just concluded an alliance with France, Switzerland and the Netherlands, to counterbalance the power of Spain, and the ambassador was instructed to destroy this league. Assisted by the duke of Ossuna, viceroy of Naples, he formed a plan to bring the city into the power of Spain, and the scheme was to be carried out on Ascension Day 1618. The plot was, however, discovered; and Bedmar, protected by his position from arrest, left Venice and went to Flanders as president of the council. In 1622 he was made a cardinal, and soon afterwards became bishop of Oviedo, a position which he retained until his death, which occurred at Oviedo on the 2nd of August 1655. The authorship of an anonymous work, *Spiritino della libertà Veneta*, published at Mirandola in 1612, has been attributed to him.

Some controversy has arisen over the Spanish plot of 1618, and some historians have suggested that it only existed in the minds of the Venetian senators, and was a ruse for forcing Bedmar to leave Venice. From what is known, however, of the policy of Spain at this time, it is by no means unlikely that such a scheme was planned.

See C. V. de Saint-Réal, *Œuvres*, tome iv. (Paris, 1745); P. J. Grosley, *Discussion historique et critique sur la conjuration de Venise* (Paris, 1756); P. A. N. B. Daru, *Histoire de la république de Venise* (Paris, 1853); A. Baschet, *Histoire de la chancellerie secrète à Venise* (Paris, 1870).

BED-MOULD, in architecture, the congeries of mouldings which is under the projecting part of almost every cornice, of which, indeed, it is a part.

BEDOUNS (*Aht Bedu*, "dwellers in the open land," or *Aht el beit*, "people of the tent," as they call themselves), the name given to the most important, as it is the best known, division of the Arab race. The Bedouins are the descendants of the Arabs of North Arabia whose traditions claim Ishmael as

their ancestor (see ARABS). The deserts of North Arabia seem to have been their earliest home, but even in ancient times they had migrated to the lowlands of Egypt and Syria. The Arab conquest of northern Africa in the 7th century A.D. caused a wide dispersion, so that to-day the Arab element is strongly represented in the Nile Valley, Saharan, and Nubian peoples. Among the Hamitic-Negroid races the Bedouins have largely lost their nomadic character; but in the deserts of the Nile lands they remain much what their ancestors were. Thus the name has suffered much ethnic confusion, and is often incorrectly reserved to describe such pastoral peoples as the Bishārin, the Hadendā and the Abābā. This article treats solely of the Arabian Bedouin, as affording the purest type of the people. They are shepherds and herdsmen, reduced to an open-air, roving life, partly by the nature of their occupations, partly by the special characteristics of the countries in which they dwell. For, while land, unsuited to all purposes except pasture, forms an unusually large proportion of the surface in the Arabian territory, the prolonged droughts of summer render considerable portions of it unfit even for that, and thus continually oblige the herdsmen to migrate from one spot to another in search of sufficient herbage and water for their beasts. The same causes also involve the Bedouins in frequent quarrels with each other regarding the use of some particular well or pasture-ground, besides reducing them not infrequently to extreme want, and thus making them plunderers of others in self-support. Professionally, the Bedouins are shepherds and herdsmen; their raids on each other or their robbery of travellers and caravans are but occasional exceptions to the common routine. Their intertribal wars (they very rarely venture on a conflict with the better-armed and better-organized sedentary population) are rarely bloody; cattle-lifting being the usual object. Private feuds exist, but are usually limited to two or three individuals at most, one of whom has perhaps been ridiculed in satirical verse, to which they are very sensitive, or had a relation killed in some previous fray. But bloodshed is expensive, as it must be paid for either by more bloodshed or by blood-money—the *diya*, which varies, according to the importance of the person killed, from ten to fifty camels, or even more. Previous to Mahomet's time it was optional for the injured tribe either to accept this compensation or to insist on blood for blood; but the Prophet, though by his own account despairing of ever reducing the nomad portion of his countrymen to law and order, succeeded in establishing among them the rule, that a fair *diya* if offered must be accepted. Instances are, however, not wanting in Arab history of fiercer and more general Bedouin conflicts, in which the destruction, or at least the complete subjugation, of one tribe has been aimed at by another, and when great slaughter has taken place. Such were the wars of Pekr and Taghleḡ in the 6th century, of Kelb and Howazin in the 8th, of Harb and Ateba in the 18th.

The Bedouins regard the plundering of caravans or travellers as in lieu of the custom dues exacted elsewhere. The land is theirs, they argue, and trespassers on it must pay the forfeit. Hence whoever can show anything equivalent to a permission of entrance into their territory has, in the regular course of things, nothing to fear. This permission is obtained by securing the protection of the nearest Bedouin sheik, who, for a politely worded request and a small sum of money, will readily grant the pass, in the shape of one or two or more men of his tribe, who accompany the wayfarers as far as the next encampment on their road, where they hand their charge over to fresh guides, equally bound to afford the desired safeguard. In the interior of Arabia the passport is given in writing by one of the town governors, and is respected by the Bedouins of the district; for, however impudent and unamenable to law these nomads may be on the frontiers of the impotent Ottoman government in Syria or the Hejaz, they are submissive enough in other and Arab-governed regions. But the traveller who ventures on the desert strip without such precautions will be robbed and perhaps killed.

Ignorant of writing and unacquainted with books, the Bedouins trust to their memory for everything; where memory fails,

they readily eke it out with imagination. Hence their own assertions regarding the antiquity, numbers, strength, &c., of their clans are of little worth; even their genealogies, in which they pretend to be eminently versed, are not to be much depended on; the more so that their own family names hardly ever exceed the limits of a patronymic, whilst the constantly renewed subdivisions of a tribe, and the temporary increase of one branch and decrease of another, tend to efface the original name of the clan. Few tribes now preserve their ancient, or at least their historical titles; and the mass of the Bedouin multitude resembles in this respect a troubled sea, of which the substance is indeed always the same, but the surface is continually shifting and changing. As, however, no social basis or ties are acknowledged among them except those of blood and race, certain broad divisions are tolerably accurately kept up, the wider and more important of which may here be noted. First, the Aneza clan, who extend from Syria southward to the limits of Jebel Shammar. It is numerous, and, for a Bedouin tribe, well armed. Two-thirds of the Arab horse trade, besides a large traffic in sheep, camels, wool, and similar articles, are in their hands. Their principal subdivisions are the Sebaā on the north, the Walid Ali on the west, and the Ruāla on the south; these are generally on bad terms with each other. If united, they could muster, it is supposed, about 30,000 lances. They claim descent from Rabi'a. Second, the Shammar Bedouins, whose pasturages lie continuous to those of the Aneza on the east. Their numbers are about the same. Thirdly, in the northern desert, the Huwet and Sherarat, comparatively small and savage tribes. There is also the Solibi clan, which, however, is disowned by the Arabs, and seems to be of gipsy origin. Next follow, in the western desert, the Beni-Harb, a powerful tribe, supposed to muster about 20,000 fighting men. They are often troublesome to the Meccan pilgrims. In the eastern desert are the Muter, the Beni-Khalid, and the Ajmans, all numerous clans, often at war with each other. To the south, in Nejd itself or on its frontiers, are the Hodeil, Ateba, and others. These all belong to the "Mustareḡ," or northern Arabs.

The Bedouins of southern or "pure Arab" origin are comparatively few in number, and are, with few exceptions, even poorer and more savage than their northern brethren. Al-Morrah, on the confines of Oman, Al-Yam and Kahtan, near Yemen, and Beni-Yas, between Harik and the Persian Gulf, are the best known. The total number of the Bedouin or pastoral population throughout Arabia, including men, women, and children, appears not to exceed a million and a half, or about one fifth of the total population. The only tribal authority is the "elder," or "sheik," a title not necessarily implying advanced age, but given to any one who, on account of birth, courage, wealth, liberality or some other quality, has been chosen to the leadership. Descent has something to do with rank, but not much, as every individual of the tribe considers himself equal to the others; nor are the distinctions of relative riches and poverty greatly taken into account. To the "sheik" all disputes are referred; he is consulted, though not necessarily obeyed, on every question which regards the general affairs of the tribe, whether in peace or war; there is no other magistrature, and no law except what he and the other chief men may consider proper. But in fact, for what personal and private affairs, every man does pretty much what is right in his own eyes.

All the Bedouins, with the exception of certain tribes in Syria, are nominally Mahomedans, but most pay but slight attention to the ceremonial precepts of the Koran; the five daily prayers and the annual fast of Ramadan are not much in favour among them; and however near a tribe may be to Mecca; few of them visit it as pilgrims. The militant Wahhabi have, however, from time to time enforced some degree of Islamic observance among the Bedouins of Nejd and the adjoining districts; elsewhere Mahomedanism is practically confined to the profession of the Divine Unity; among the remoter and wilder tribes sun-worship, tree-worship, and no worship at all, are not uncommon. Some clans even omit the rite of circumcision altogether; others,

like the tribe of Hodeil, south of Mecca, perform it after a fashion peculiar to themselves.

Though polygamy is not common among Bedouins, marriages are contracted without any legal intervention or guarantee; the consent of the parties, and the oral testimony of a couple of witnesses, should such be at hand, are all that are required; and divorce is equally easy. Nor is mutual constancy much expected or observed either by men or women; and the husband is rarely strict in exacting from the wife a fidelity that he himself has no idea of observing. Jealousy may indeed occasionally bring about tragic results, but this rarely occurs except where publicity, to which the Bedouins, like all other Arabs, are very sensitive, is involved. Burckhardt writes: "The Bedouins are jealous of their women, but do not prevent them from laughing and talking with strangers. It seldom happens that a Bedouin strikes his wife; if he does so she calls loudly on her *wasy* or protector, who pacifies the husband and makes him listen to reason. . . . The wife and daughters perform all domestic business. They grind the wheat in the handmill or pound it in the mortar; they prepare the breakfast and dinner; knead and bake the bread; make butter, fetch water, work at the loom, mend the tent-covering . . . while the husband or brother sits before the tent smoking his pipe." A maiden's honour is, on the other hand, severely guarded; and even too openly avowed a courtship, though with the most honourable intentions, is ill looked on. But marriage, if indeed so slight and temporary a connexion as it is among Bedouins deserves the name, is often merely a passport for mutual licence. In other respects Bedouin morality, like that of most half-savage races, depends on custom and public feeling rather than on any fixed code or trained conscience, and hence admits of the strangest contradictions. Not only are lying and exaggeration no reproach in ordinary discourse, but even deliberate perjury and violation of the most solemn engagements are frequent occurrences. Not less frequent, however, are instances of prolonged fidelity and observance of promise carried to the limits of romance. "The wind," "the wood," and "the honour of the Arabs" are the most ordinary oaths in serious matters; but even these do not give absolute security, while a simple verbal engagement will at other times prove an inviolable guarantee. Thus, too, the extreme abstemiousness of a Bedouin alternates with excessive gorgings; and, while the name and deeds of "robber" are hardly a reproach, those of "thief" are marked by abhorrence and contempt. In patience, or rather endurance, both physical and moral, few Bedouins are deficient; wariness is another quality universally developed by their mode of life. And in spite of an excessive coarseness of language, and often of action, gross vice, at least of the more debasing sorts that dishonour the East, is rare.

Most Bedouins, men and women, are rather undersized; their complexion, especially in the south, is dark; their hair coarse, thick and black; their eyes dark and oval; the nose is generally aquiline, and the features well formed; the beard and moustache are usually scanty. The men are active, but not strong; the women are generally plain. The dress of the men consists of a long cotton shirt, open at the breast, often girt with a leathern girdle; a black or striped cloak of hair is sometimes thrown over the shoulders; a handkerchief, folded once, black, or striped yellow and red, covers the head, round which it is kept in its place by a piece of twine or a twisted hairband. To this costume a pair of open sandals is sometimes added. Under the shirt, round the naked waist, a thin strip of leather plait is wound several times, not for any special object, but merely out of custom. In his hand a Bedouin almost always carries a slight crooked wand, commonly of almond-wood. Among the Bedouins of the south a light wrapper takes the place of the handkerchief on the head, and a loin-cloth that of the shirt. The women usually wear wide loose drawers, a long shirt, and over it a wide piece of dark blue cloth enveloping the whole figure and head, and trailing on the ground behind. Very rarely does a Bedouin woman wear a veil, or even cover her face with her overcloak, contenting herself with narrowing the folds of the latter over her head on the approach of a stranger. Her wrists and ankles are

generally adorned with bracelets and rings of blue glass or copper or iron, very rarely of silver; her neck with glass beads; ear-rings are rare, and nose-rings rarer. Boys, till near puberty, usually go stark naked; girls also wear no clothes up to the age of six or seven.

On a journey a Bedouin invariably carries with him a light, sharp-pointed lance, the stem of which is made of Persian or African cane; the manner in which this is carried or trailed often indicates the tribe of the owner. The lance is the favourite and characteristic weapon of the Arab nomad, and the one in the use of which he shows the greatest skill. An antiquated sword, an out-of-date musket, an ornamented dagger or knife, a coat of mail, the manufacture of Yemen or Bagdad, and a helmet, a mere iron head-piece, without visor or crest, complete his military outfit.

A Bedouin's tent consists of a few coverings of the coarsest goat-hair, dyed black, and spread over two or more small poles, in height from 8 to 9 ft., gipsy fashion. If it be the tent of a sheik, its total length may be from 30 to 40 ft.; if of an ordinary person, less than 20 ft. Sometimes a partition separates the quarters of the women and children; sometimes they are housed under a lower and narrower covering. A rough carpet or mat is spread on the ground; while camel-saddles, ropes, halters, two or three cooking pots, one or two platters, a wooden drinking bowl, the master's arms at one side of the tent, and his spear stuck in the ground at the door, complete the list of household valuables. On striking camp all these are fastened on the backs of camels; the men mount their saddles, the women their litters; and in an hour the blackened stones that served for a cooking hearth are the only sign of the encampment. For food the Bedouin relies on his herds, but rice, vegetables, honey, locusts and even lizards are at times eaten.

BIBLIOGRAPHY.—Johann Ludwig Burckhardt, *Notes on the Bedouins and Wahabis* (1831); Karstens Niebuhr, *Travels through Arabia* (orig. Germ. edit. 1772), translated into English by Robert Heron (2 vols., Edinburgh, 1792); H. H. Tesson, *Women of the Arabs* (New York, 1874); W. S. Blunt, *Bedouin Tribes of the Euphrates* (1879); Lady Anne Blunt, *Pilgrimage to Nejd* (1881); Desmoulin, *Les Français d'aujourd'hui* (Paris, 1898); C. M. Doughty, *Arabia Deserta* (2 vols., 1888); E. Reclus, *Les Arabes* (Brussels, 1898); Rev. S. M. Zwemer, *Arabia, the Cradle of Islam* (1900); W. Robertson Smith, *Kinship and Marriage in Early Arabia* (Cambridge, 1885); H. C. Trumbull, *The Blood Covenant* (Philadelphia, 1891).

BEDSORE, a form of ulceration or sloughing, occasioned in people who, through sickness or old age, are confined to bed, resulting from pressure or the irritation of sweat and dirt. Bedsores usually occur when there is a low condition of nutrition of the tissues. The more helpless the patient the more liable he is to bedsores, and especially when he is paralysed, delirious or insane, or when suffering from one of the acute specific fevers. They may occur wherever there is a pressure, more especially when any moisture is allowed to remain on the bedding; and thus lack of cleanliness is an important factor in the production of this condition. In large hospitals a bed sore is now a great rarity, and this, considering the helplessness of many of the patients treated, shows what good nursing can do. The bed must be made with a firm smooth mattress; the undersheet and blanket must be changed whenever they become soiled; the drawsheet is spread without creases, and changed the moment it becomes soiled. Preventive treatment must be followed from the first day of the illness. This consists in the most minute attention to cleanliness, and constant variation in the position of the patient. All parts subjected to pressure or friction must be frequently washed with soap and hot water, then thoroughly dried with a warm soft towel. The part should next be bathed in a solution of corrosive sublimate in spirits of wine, and finally dusted with an oxide of zinc and starch powder. This routine should be gone through not less than four times in the twenty-four hours in any case of prolonged illness. The pressure may be relieved over bony prominences by a water-pillow or by a piece of thick felt cut into a ring. Signs of impending bedsores must constantly be watched for. Where one threatens, the skin loses its proper colour, becoming either a deadly white or a dusky red,

and the redness does not disappear on pressure. The surrounding tissues become oedematous, and pain is often severe, except in a case of paralysis. As the condition progresses further the pain ceases. The epidermis now becomes raised as in a blister, and finally becomes detached, forming an excoriation and exposing the papillae. Even at this late stage an actual ulceration can still be prevented if proper care is taken; but failing this, the skin sloughs and an ulcer forms. In treating this, the position of the patient must be such that no pressure is ever allowed on the sloughing tissue. A hot boracic pad under oil-silk should be applied, the affected part being first dusted with iodoform. If, however, the slough is very large, it is safer to avoid wet applications, and the parts should be dusted with animal charcoal and iodoform, and protected with a dry dressing. When the slough has separated and the sore is clean, friar's balsam will hasten the healing process. In any serious illness the formation of a bed sore makes the prognosis far more grave, and may even bring about a fatal issue, either directly or indirectly.

BEDWORTH, a manufacturing town in the Nuneaton parliamentary division of Warwickshire, England; on the Nuneaton-Coventry branch of the London & North Western railway, 100 m. north-west from London. Pop. (1900) 7,169. A tramway connects with Coventry, and the Coventry canal passes through. Coal and ironstone are mined; there are iron-works, and bricks, hats, ribbons and tape and silk are made. Similar industries are pursued in the populous district (including the villages of Exhall and Foleshill) which extends southward towards Coventry.

BEE (Sanskrit *bha*, A.S. *beō*, Lat. *apis*), a large and natural family of the zoological order *Hymenoptera*, characterized by the plumose form of many of their hairs, by the large size of the basal segment of the foot, which is

always elongate and in the hindmost limb sometimes as broad as the shin, and by the development of a "tongue" for sucking liquid food; this organ has been variously interpreted as the true insectan tongue (hypopharynx) or as a ligula formed by fused portions of the second maxillae (probably the latter).

Bees are specialized in correspondence with the flowers from which they draw the bulk of their food supply, the flexible tongue being used for sucking nectar, the plumed hairs and the modified legs (fig. 7) for gathering pollen. These floral products which form the food of bees and of their larvae, are in most cases collected and stored by the industrious insects; but some genera of bees act as inquilines in the nests of other bees, so that their larvae may feed at the expense of the rightful owners of the nest. In a few cases, the parasitic bee-

grub devours not only the food-supply, but also the larva of its host.

Solitary and Social Bees.—Many genera of bees are represented, like most other insects, by ordinary males and females, each female constructing a nest formed of several chambers ("cells") and storing in each chamber a supply of food for the grub to be hatched from the egg that she lays therein. Such bees, although a number of individuals often make their nests close together, are termed "solitary," their communities differing in nature from those of the "social" bees, among which there are two kinds of females—the normal fertile females or "queens," and those specially modified females with undeveloped ovaries (see fig. 6) that are called "workers" (fig. 1). The workers

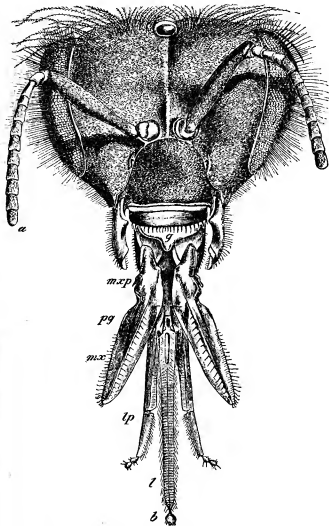

FIG. 2.—Head and Appendages of Honey-bee (*Apis*).

- | | | | |
|------|--|-----|--------------------------------|
| a, | Antenna or feeler. | mx, | 1st maxilla. |
| g, | Epipharynx. | lp, | Labial palp. |
| mxp, | Maxillary palp. | l, | Ligula or "tongue." |
| pg, | Opposite to galeae of 2nd maxillae (labium). | b, | Bouton or spoon of the ligula. |

(From Frank R. Cheshire's *Bee and Bee-keeping*.)

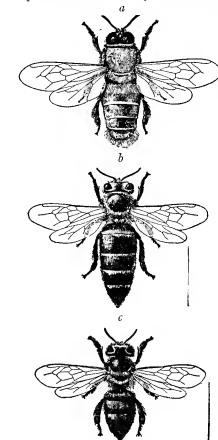

FIG. 1.—Honey-bee (*Apis mellifica*). a, male (drone); b, queen; c, worker.

(After Benton, *Bull. 1 (n. s.) Div. Ent., U.S. Dept. Agr.*)

or "cuckoo-parasites," laying their eggs in the nests of other bees, so that their larvae may feed at the expense of the rightful owners of the nest. In a few cases, the parasitic bee-

are the earliest developed offspring of the queen, and it is their associated work which renders possible the rise of an insect state—a state which evidently has its origin in the family. It is interesting to trace various stages in the elaboration of the bee-society. Among the humble-bees (*Bombus*) the workers help the queen, who takes her share in the duties of the nest; the distinction between queen and workers is therefore less absolute than in the hive-bees (*Apis*), whose queen, relieved of all nursing and building cares by the workers, devotes her whole energies

to egg-laying. The division of labour among the two castes of female becomes therefore most complete in the most highly organized society.

Structure.—Details of the structure of bees are given in the article HYMENOPTERA. The feelers (fig. 2, *a*) are divided into "scape" and "flagellum" as in the ants, and the mandibles vary greatly in size and sharpness in different genera. The proboscis or "tongue" (fig. 2, *l*) is a hollow organ enclosing an outgrowth of the body-cavity which is filled with fluid, and with its flexible under-surface capable of invagination or protrusion. Along this surface stretches a groove which is surrounded by thickened cuticle and practically formed into a tube by numerous fine hairs. Along this channel the nectar is drawn into the pharynx and passes, mixed with saliva, into the crop or "honey-bag"; the action of the saliva changes the saccharose into dextrose and levulose, and the nectar becomes honey, which the bee regurgitates for storage in the cells or for the feeding of the grubs. The sting (fig. 6, *pg*, *st.*) of female bees is usually highly specialized, but in a few genera it is reduced and useless.

Many modifications in details of structure may be observed within the family. The tongue is bifid at the tip in a few genera; usually it is pointed and varies greatly in length, being comparatively short in *Andrena*, long in the humble-bees (*Bombus*), and longest in *Euglossa*, a tropical American genus of solitary bees. The legs, which are so highly modified as pollen-carriers in the higher bees, are comparatively simple in certain primitive genera. The hairy covering, so notable in the hive-bee and especially in humble-bees, is greatly reduced among bees that follow a parasitic mode of life.

Early stages.—As is usual where an abundant food supply is provided for the young insects, the larvae of bees (fig. 3, *SL*)

in each of which an egg is laid and a supply of food stored up. J. H. Fabre has found that in the nests of some species of *Osmia* the young bee developed in the first-formed cell, if (as often happens) she emerges from her cocoon before the inmates of the later cells, will try to work her way round these or to bite a lateral hole through the bramble shoot; should she fail to do this, she will wait for the emergence of her sisters and not make her escape at the price of injury to them. But when Fabre substituted dead individuals of her own species or live larvae of another genus, the *Osmia* had no scruple in destroying them, so as to bite her way out to air and liberty.

The leaf-cutter bees (*Megachile*)—which differ from *Andrena* and *Halicictus* and agree with *Osmia*, *Apis* and *Bombus* in having elongate tongues—cut neat circular disks from leaves, using them for lining the cells of their underground nests. The carpenter-bees (*Xylocopa* and allied genera), unrepresented in the British Islands, though widely distributed in warmer countries, make their nests in dry wood. The habits of *X. violacea*, the commonest European species, were minutely described in the 18th century in one of R. A. F. de Réaumur's memoirs. This bee excavates several parallel galleries to which access is gained by a cylindrical hole. In the galleries are situated the cells, separated from one another by transverse partitions, which are formed of chips of wood, cemented by the saliva of the bee.

Among the solitary bees none has more remarkable nesting habits than the mason bee (*Chalcidodoma*) represented in the south of France and described at length by Fabre. The female constructs on a stone a series of cells, built of cement, which she compounds of particles of earth, minute stones and her own saliva. Each cell is provided with a store of honey and pollen beside which an egg is laid; and after eight or nine cells have been successively built and stored, the whole is covered by a dome-like mass of cement. Fabre found that a *Chalcidodoma* removed to a distance of 4 kilometres from the nest that she was building, found her way back without difficulty to the exact spot. But if the nest were removed but a few yards from its former position, the bee seemed no longer able to recognize it, sometimes passing over it, or even into the unfinished cell, and then leaving it to visit again uselessly the place whence it had been moved. She would accept willingly, however, another nest placed in the exact spot where her own had been. If the unfinished cell in the old nest had been only just begun, while that in the substituted nest were nearly completed, the bee would add so much material as to make the cell much larger than the normal size, her instinct evidently being to do a certain amount of building work before filling the cell with food. The food, too, is always placed in the cell after a fixed routine—first honey disgorged from the mouth, then pollen brushed off the hairs beneath the body (fig. 7, *c*) after which the two substances are mixed into a paste.

Inquilines and Parasites.—The working bees, such as have been mentioned, are victimized by bees of other genera, which throw upon the industrious the task of providing for the young of the idle. The nests of *Andrena*, for example, are haunted by the black and yellow species of *Nomada*, whose females lay their eggs in the food provided for the larva of the *Andrena*. According to H. Friese, the relations between the host and the inquiline are quite friendly, and the insects if they meet in the nest-galleries courteously get out of each other's way. D. Sharp, in commenting on this strange behaviour, points out that the host can have no idea why the inquiline haunts her nest. "Why then should the *Andrena* feel alarm? If the species of *Nomada* attack the species of *Andrena* too much, it brings about the destruction of its own species more certainly than that of the *Andrena*."

More violent in its methods is the larva of a *Stelis*, whose operations in the nest of *Osmia leucomelana* have been studied by Verhoeff. The female *Stelis* lays her eggs earlier than the *Osmia*, and towards the bottom of the food-mass; the egg of the *Osmia* is laid later, and on the surface of the food. Hence the two eggs are at opposite ends of the food, and both larvae

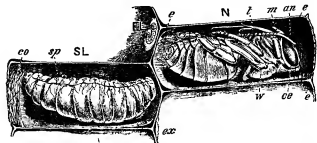

FIG. 3.—Larva and Pupa of *Apis*.

SL, Spinning larva.	<i>sp</i> , Spiracles.	<i>w</i> , Wing.
N, Pupa.	<i>l</i> , "Tongue."	<i>ce</i> , Compound Eye.
FL, Feeding larva.	<i>m</i> , Mandible.	<i>ex</i> , Excrement.
<i>co</i> , Cocoon.	<i>an</i> , Antenna.	<i>exv</i> , Exuvium.

(From Cheshire's *Bees and Bee-keeping*.)

are degraded maggots; they have no legs, but possess fairly well-developed heads. The successive cuticles that are cast as growth proceeds are delicate in texture and sometimes separate from the underlying cuticle without being stripped off. The maggots may pass no excrement from the intestine until they have eaten all their store of food. When fully grown the final larval cuticle is shed, and the "free" pupa (fig. 3, *N*) revealed. The larvae of some bees spin cocoons (fig. 3, *co*) before pupation.

Nests of Solitary Bees.—Bees of different genera vary considerably in the site and arrangement of their nests. Many—like the common "solitary" bees *Halicictus* and *Andrena*—burrow in the ground; the holes of species of *Andrena* are commonly seen in springtime opening on sandy banks, grassy lawns or gravel paths. Our knowledge of such bees is due to the observations of F. Smith, H. Friese, C. Verhoeff and others. The nest may be simple, or, more frequently, a complex excavation, cells opening off from the entrance or from a main passage. Sometimes the passage is the conjoint work of many bees whose cells are grouped along it at convenient distances apart. Other bees, the species of *Osmia* for example, choose the hollow stem of a bramble or other shrub, the female forming a linear series of cells

feed for a time without conflict, but the *Stelis*, being the older, is the larger of the two. Finally the parasitic larva attacks the *Osmia*, and digging its mandibles into its victim's head kills and eats it, taking from one to two days for the completion of the repast.

Social Bees.—The bees hitherto described are "solitary," all the individuals being either males or unmated females. The most highly developed of the long-tongued bees are "social"



FIG. 4.—Under Side of Worker, carrying Wax Scales.

(From Cheshire's *Bees and Bee-keeping*.)

species, in which the females are differentiated into egg-laying queens and (usually) infertile "workers" (fig. 6). Verhoeff has discussed the rise of the "social" from the "solitary" condition, and points out that for the formation of an insect community three

conditions are necessary—a nest large enough for a number of individuals, a close grouping of the cells, and an association between mother and daughters in the winged state. For the fulfilment of this last condition, the older insects of the new generation must emerge from the cells while the mother is still occupied with the younger eggs or larvae. One species of *Holictus* nearly reaches the desired stage; but the first young bees to appear in the perfect state are males, and when the females emerge the mother dies.

Among the social bees the mother and daughter-insects co-operate, and they differ from the "solitary" groups in the nature of their nest, the cells (fig. 25) of which are formed of wax secreted by special glands (fig. 5) in the bee's abdomen, the wax being pressed out between the segmental sclerites in the form of plates (fig. 4), which are worked by the legs (fig. 7) and jaws into the requisite shape. In our well-known hive-bee (*Apis*) and humble-bees (*Bombus*) the wax glands are ventral

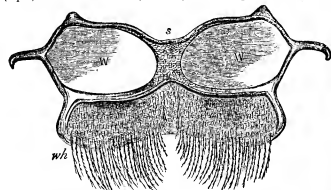

FIG. 5.—Abdominal Plate (worker of *Apis*), under side, third segment. W, wax-yielding surface, covering true gland; s, septum, or carina; wh, webbed hairs.

(From Cheshire's *Bees and Bee-keeping*.)

in position, but in the "stingless" bees of the tropics (*Trigona* and *Melipona*) they are dorsal. A colony of humble-bees is started in spring by a female "queen" which has survived the winter. She starts her nest underground or in a surface depression, forming a number of waxen cells, roughly globular in shape and arranged irregularly. The young females ("workers") that develop from the eggs laid in these early cells assist the queen by building fresh cells and gathering food for storage therein. The queen may be altogether relieved of the work of the nest as the season advances, so that she can devote all her energies to egg-laying, and the colony grows rapidly. The

distinction between queen and worker is not always clear among humble-bees, the female insects varying in size and in the development of their ovaries. If any mishap befall the queen, the workers can sometimes keep the community from dying out. In autumn males are produced, as well as young queens. The community is broken up on the approach of winter, the males and workers perish, and the young queens after hibernation start fresh nests in the succeeding year.

The appearance of the heavy-bodied hairy *Bombi* is well known. They are closely "mimicked" by bees of the genus *Psithyrus*, which often share their nests. These *Psithyrus* have

no pollen-carrying structures on the legs and their grubs are dependent for their food-supply on the labours of the *Bombi*, though, according to E. Hoffer's observations, it seems that the female *Psithyrus* builds her own cells. The colonies of *Bombus* illustrate the rise of the inquiline habit. Many of the species are very variable and have been differentiated into races or varieties. F. W. L. Sladen states that a queen belonging to the *virginialis* form of *Bombus terrestris* often invades a nest

belonging to the *lucorum* workers, kills the rightful queen, and takes possession of the nest, getting the *lucorum* workers to rear her young. In the nests of *Bombi* are found various beetle larvae that live as inquilines or parasites, and also maggots of drone-flies (*Volucella*), which act as scavengers; the *Volucella*-fly is usually a "mimic" of the *Bombus*, whose nest she invades.

The "stingless" bees (*Trigona*) of the tropics have the parts of the sting reduced and useless for piercing. As though to compensate for the loss of this means of defence, the mandibles are very powerful, and some of the bees construct tubular entrances to the nest with a series of constrictions easy to hold against an enemy. The habits of the Brazilian species of these bees have been described in detail by H. von Jhering, who points out that their wax glands are dorsal in position, not ventral as in *Bombus* and *Apis*.

With *Apis*, the genus of the hive-bee, we come to the most highly-specialized members of the family—better known, perhaps, than any other insects, on account of the long domestication of many of the species or races. In *Apis* the workers differ structurally from the queen, who neither builds cells, gathers food, nor tends brood, and is therefore without the special organs adapted

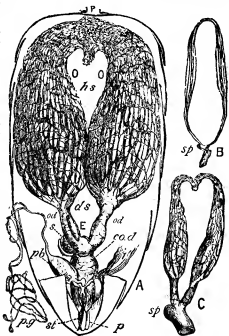

FIG. 6.—Ovaries of Queen and Workers (*Apis*).

- A, Abdomen of queen, under side.
- B, Rudimentary ovaries of ordinary worker.
- C, Partially-developed ovaries of fertile worker.
- ph, Poison bag.
- pg, Poison gland.
- st, Sting.
- pl, "Palps" or "feelers" of sting.
- P, Petiole.
- o, o, Ovaries.
- hs, Position filled by honey-sack.
- ds, Position through which digestive system passes.
- od, Oviduct.
- co.d, Vagina.
- E, Egg-passing oviduct.
- s, Spermatheca.
- i, Intestine.
- sp, Rudimentary spermatheca.

(From Cheshire's *Bees and Bee-keeping*.)

for those functions which are possessed in perfection by the workers. The differentiation of queen and workers is correlated with the habit of storing food supplies, and the consequent permanence of the community, which finds relief for its surplus population by sending off a swarm, consisting of a queen and a number of workers, so that the new community is already specialized both for reproduction and for labour.

The workers of *Apis* may be capable (fig. 6, C) of laying eggs—necessarily unfertilized—which always give rise to males (“drones”), and, since the researches of J. Dzierzon (1817-1906) in 1848, it has been believed that the queen bee lays fertilized eggs in cells appropriate for the rearing of queens or

inadvertently this single fertilized egg in a drone instead of in a worker cell.

The cells of the honeycomb of *Apis* are usually hexagonal in form, and arranged in two series back to back (figs. 3, 25). Some of these cells are used for storage, others for the rearing of brood. The cells in which workers are reared are smaller than those appropriate for the rearing of drones, while the “royal cells,” in which the young queens are developed, are large in size and of an irregular oval in form (fig. 25). It is believed that from the nature of the cell in which she is ovipositing, the queen derives a reflex impulse to lay the appropriate egg—fertilized in the queen or worker cell, unfertilized in the drone cell, as previously mentioned. Whether the fertilized egg shall develop into a queen or a worker depends upon the nature of the food. All young grubs are at first fed with a specially nutritious food, discharged from the worker's stomach, to which is added a digestive secretion derived from special salivary glands in the worker's head. If this “royal jelly” continue to be given to the grub throughout its life, it will grow into a queen; if the ordinary mixture of honey and digested pollen be substituted, as is usually the case from the fourth day, the grub will become a worker. The workers, who control the polity of the hive (the “queen” being exceedingly “limited” in her monarchy), arrange if possible that young queens shall develop only when the population of the hive has become so congested that it is desirable to send off a swarm. When a young queen has emerged, she stings her royal sisters (still in the pupal stage) to death. Previous to the emergence of the young queen, the old queen, prevented by the workers from attacking her daughters, has led off a swarm to find a new home elsewhere. The young queen, left in the old home, mounts high into the air for her nuptial flight, and then returns to the hive and her duties of egg-laying. The number of workers increases largely during the summer, and so hard do the insects work that the life of an individual may last only a few weeks. On the approach of winter the males, having no further function to perform for the community, are refused food-supplies by the workers, and are either excluded or banished from the hive to perish. Such ruthless habits of the bee-commonwealth, no less than the altruistic labours of the workers, are adapted for the survival and dominance of the species. The struggle for life may deal hardly with the individual, but it results—to quote Darwin's well-known title—in “the preservation of favoured races.”

BIBLIOGRAPHY.—More has been written on bees, and especially on the genus *Apis*, than on any other group of insects. The classical observations of Réaumur *Mémoires pour servir à l'histoire des insectes*, vols. v, vi (Paris, 1749-1724) and Fabre's *Nouvelles observations sur les abeilles* (Geneve, 1792) will never be forgotten; they have been matched in recent times by J. H. Fabre's *Souvenirs entomologiques* (Paris, 1879-1891); and M. Maeterlinck's poetic yet scientific *La vie des abeilles* (Paris, 1901). Among writers on the solitary and parasitic species may be specially mentioned F. Smith, *Hymenoptera in the British Museum* (London, 1853-1859); H. Friese, *Zool. Jahrb. Syst.*, iv, (1891) J. Pérez, *Actes Soc. Bordeaux*, xlviii, (1895); and C. Verhoef, *Zool. Jahrb. Syst.*, vi, (1892). For the social species we have valuable papers by E. Hoffer, *Mitt. Naturwiss. Ver. Steiermark*, xxxi, (1881); H. von Herting, *Zool. Jahrb. Syst.*, xix, (1903); and others. For recent controversy on parthenogenesis in the hive bee, see J. Pérez, *Ann. Sci. Nat. Zool.* (6), vii, (1878); F. Dickel, *Zool. Anz.*, xxv, (1901); and *Anatoni. Anzeiger*, xix, (1902); A. Petrunkevich, *Zoolog. Jahrb. Anat.*, xiv, (1901); and A. Weismann, *Anatom. Anzeiger*, xvii, (1901). F. R. Cheshire's *Bees and Bee-keeping* (London, 1885-1888), and T. W. Cowan's *Honey Bee* (2nd ed., 1904), are invaluable to the naturalist, and contain extensive bibliographies of *Apis*. D. Sharp's summary in the *Cambridge Natural History*, vol. vi., should be consulted for further information on bees generally. British bees are described in the catalogues of Smith, mentioned above, and by E. Saunders, *The Hymenoptera of the British Islands* (London, 1896). (G. H. C.)

BEE-KEEPING

Bee-keeping, or the cultivation of the honey-bee as a source of income to those who practise it, is known to have existed from the most ancient times. Poets, philosophers, historians and naturalists (among whom may be mentioned Virgil, Aristotle, Cicero and Pliny) have eulogized the bee as unique among insects, endowed by nature with wondrous gifts beneficial to

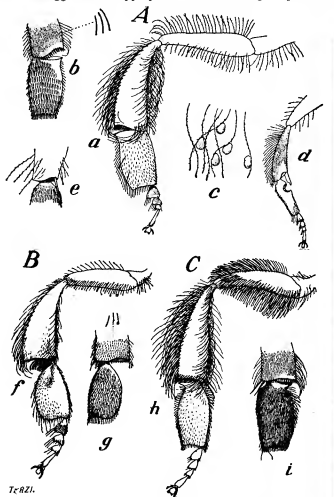

FIG. 7.—Modifications in the Legs of Bees.

- A, a-d, Hive-bee (*Apis*).
 B, f-g, Stingless-bee (*Melipona*).
 C, h-i, Humble-bee (*Bombus*).
 a, f, h, Outer view of hind-leg.
 b, g, i, Inner view.
 c, Feathered hairs with pollen grains, magnified.
 d, Fore-leg of *Apis* showing notch in tarsal segment for cleaning feeler.
 e, Tip of intermediate shin with spurs.
 f, g, i, Inner view of fore-leg of *Apis* showing feathered hairs with pollen grains, magnified.

(After Riley, *Insect Life* (U.S. Dept. Agr.), vol. 6.)

workers, and unfertilized eggs in “drone-cells,” virgin reproduction or parthenogenesis being there a normal factor in the life of these insects. F. Dickel and others have lately claimed that fertilized eggs can give rise to either queens, workers or males, according to the food supplied to the larvae and the influence of supposed “sex-producing glands” possessed by the nurse-workers. Dickel states that a German male bee mated with a female of the Italian race transmits distinct paternal characters to hybrid male offspring. A. Weismann, however, doubts these conclusions, and having found a sperm-aster in every one of the eggs that he examined from worker-cells, and in only one out of 272 eggs taken from drone-cells, he supports Dzierzon's view, explaining the single exception mentioned above as a mistake of the queen, she having laid

mankind in a greater degree than any other creature of the insect world. We are told that some of these ancient scientists passed years of their lives studying the wonders of bee-life, and left accurate records of their observations, which on many points agree with the investigations of later observers. As a forcible illustration of the manner in which a colony of bees was recognized as the embodiment of government by a chief or ruler, in the earliest times of which there is any existing record, it may be mentioned that on the sarcophagus containing the mummified remains of Mykerinos (now in the British Museum and dating back 3633 years B.C.) will be found a hieroglyphic bee (fig. 8) representing the king of Lower Egypt.



FIG. 8.—Sign of the king of Lower Egypt; from the coffin of Mykerinos, 3633 B.C. (British Museum).

In dealing with the practical side of bee-keeping as now understood, it may be said that, compared with the methods in vogue during the first decade of the 19th century, or even within the memory of men still living at the beginning of the 20th, it is as the modern locomotive to the stage-coach of a previous generation. Almost everything connected with bee-craft has been revolutionized, and apiculture, instead of being classed with such homely rural occupations as that of the country housewife who carries a few eggs weekly to the market-town in her basket, is to-day regarded in many countries as a pursuit of considerable importance. Remarkable progress has also been made in the art of queen-rearing, and in improving the common or native bee by judicious crossing with the best foreign races, selected mainly for hardiness, working qualities and the prolific capacity of their queens. American bee-breeders are conspicuous in this respect, extensive apiaries being exclusively devoted to the business of rearing queens by the thousand for sale and export.

On the European continent queen-rearing apiaries are plentiful, but less attention is paid there to hybridizing than to keeping the respective races pure. In England also, some bee-keepers include queen-rearing as part of their business, while one large apiary on the south coast is exclusively devoted to the rearing of queen bees on the latest scientific system, and to breeding by selection from such races as are most suited to the exceptional climatic conditions of the country.

Extensive apiaries have been established on the American continent, some containing from 2000 to 3500 colonies of bees, and in these honey is harvested in hundreds of tons yearly. The magnitude of the bee industry in the United States may be judged from the fact of a single bee-farmer located in California having harvested from 150,000 lb of honey in one year from 2000 stocks of bees, and, as an instance of the enormous weight of honey obtainable from good hives in that favoured region, the same farmer secured 60,000 lb of comb-honey in one season from his best 300 colonies. This is probably the maximum, and the hives were necessarily located in separate apiaries some few miles apart in order to avoid the evils of overstocking, but all in the midst of thousands of acres of honey-yielding flowers. Results like the above compared with those of the skeptic bee-keeper of former days, who was well pleased with an average of 20 to 25 lb per hive, may be regarded as wonderful, but they are matters of fact. The consumption of honey as an article of food has also largely increased of late years; a recent computation shows that from 100 to 125 million lb of honey, representing a money value of from eight to ten million dollars, is consumed annually in the United States alone. Many of the larger bee-farmers of the United States of America and Canada harvest from 50,000 to 60,000 lb of honey in a single season, and some of them sell the whole crop direct to consumers.

It is a notable fact that in the United States, Canada, Australia, New Zealand, and indeed all English-speaking countries outside the United Kingdom, honey is far more extensively used than it is there as an article of daily food. The natural result of this is that the trade in honey is conducted, in those countries, on

entirely different lines from those followed in the British Isles, where honey production as an occupation has, until quite recent years, been regarded as too insignificant for official notice in any form. The value of the bee industry is now recognized, however, by the British government as worthy of state aid, in the promotion of technical instruction connected with agriculture. On the American continent apiculture is officially recognized by the respective states' governments; and by the federal government at Washington it is taken into account as a section of the Agricultural Department, with fully equipped experimental apiaries and qualified professors engaged therein for educational work. In several Canadian provinces also, the public funds are used in promoting the bee industry in various ways, mainly in combating the bee-disease known as "foul brood." In New Zealand the government of the colony has displayed the most praiseworthy earnestness and vigour in promoting apiculture. State-aided apiaries have been established under the supervision of a skilled bee-keeper, who travels over the colony giving instruction in practical bee-work at the public schools, and forming classes at various centres where pupils are taught bee-keeping in all its branches.

In Europe similar progress is observable; technical schools, with well-equipped apiaries attached, are supported by the state, and in them the science and practice of modern bee-keeping is taught free by scientists and practical experts. Institutions of this kind have been established in Germany, Russia, Switzerland and elsewhere, all tending in the same direction, viz. the cultivation of the honey-bee as an appreciable source of income to the farmer, the peasant cultivator, and dwellers in districts where bee-forage is abundant and, if unvisited by the bee, lies wasting its sweetness on the desert air. It may be safely said that the value of the bee to the fruit-grower and the market-gardener has been proved beyond dispute; and the technical instruction now afforded by county councils in the rural districts of England has an appreciable effect. In proof thereof, we may quote the case of an extensive grower in the midland counties—sending fruit to the London market in tons—whose crop of gooseberries increased nearly fourfold after establishing a number of stocks of bees in close proximity to the gooseberry bushes. The fruit orchards and raspberry fields of Kent are also known to be greatly benefited by the numerous colonies of bees owned by more than 3000 bee-keepers in the county. The important part played by the bee in the economy of nature as a fertilizer is shown in fig. 9.

In the United Kingdom the prevailing conditions, climatic

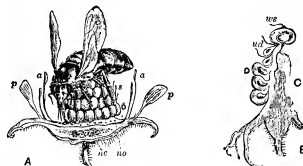

FIG. 9.—A, Raspberry (*Rubus idaeus*, order *Rosaceae*), being fertilized. B, Cross section.

- | | |
|-----------------------|-----------------------------------|
| A, Flower. | B, Section through core, or torus |
| p, p, Petals. | (C) and drupels (D). |
| a, a, Anthers. | sd, Unfertilized drupel. |
| s, Stigma. | wt, Withered stigma. |
| no, Nectary openings. | |
| nc, Nectar cells. | |
| D, Drupels. | |

(From Cheshire's *Bees and Bee-keeping, Scientific and Practical*.)

and otherwise, with regard to apiculture—as well as the lack of sufficient natural bee-forage for large apiaries—are such as to preclude the possibility of establishing apiaries on a scale comparable with those located in less confined lands. On the other

State aid for bee-keeping.

Value of bees as fertilizers.

hand, even in England the value of bee-keeping is worthy of recognition as a minor industry connected with such items of agriculture as fruit-growing, market-gardening or poultry-raising. The fact that British honey is second to none for quality, and that the British market is eagerly sought by the bee-keepers of other nationalities, has of late impressed itself on the minds of thinking men. Moreover, their views are confirmed by the constant references to bees and the profits obtainable from bee-keeping in the leading papers on all sides. This newly-aroused interest in the subject is no doubt to a large extent fostered by the grants in aid of technical instruction afforded by county councils in rural districts. The British Bee-keepers' Association (instituted in 1874) has been untiring in its efforts to raise the standard of efficiency among those who are desirous of qualifying as experts and teachers of bee-keeping on modern methods. This body had for its first president the distinguished naturalist Sir John Lubbock (Lord Avebury). Subsequently the baroness Burdett-Coutts accepted the office in the year 1878, and was re-elected annually until her death in 1906. During this time she presided at its meetings and took an active part in its work, until advancing years prevented her attendance, but her interest in the welfare of the association was maintained to the last. Branch societies of bee-keepers were established throughout the English counties, mainly by the efforts of the parent body in London, with the object of securing co-operation in promoting the sale

of honey, and showing the most modern methods of producing it in its most attractive form at exhibitions held for the purpose. Nearly the whole of these county societies affiliated with the central association, paying an affiliation fee yearly, and receiving in return the silver medal, bronze medal and certificate of the association, to be offered as prizes for competition at the annual county shows. Other advantages are given in connexion with the qualifying of experts, &c., while nearly all the county associations in the United Kingdom employ qualified men who visit members in spring and autumn for the purpose of examining hives and giving advice on bee management to those needing it. Another advantage of membership is the use of a "county label" for affixing to each section of honey in comb, or jar of extracted honey, offered for sale by members. These labels are numbered consecutively, and thus afford a guarantee of the genuineness and quality of the honey, the label enabling purchasers to trace the producer if needed. The British Bee-keepers' Association is an entirely philanthropic body, the only object of its members being to promote all that is good in British bee-keeping, and to "teach humanity to that industrious little labourer, the honey-bee." Bee-appliance manufacturers are not eligible for membership of its council, nor are those who make bee-keeping their main business; thus no professional jealousies can possibly arise. In this respect the association appears to stand alone among the bee-keepers' societies of the world. There are many equally beneficial societies, framed on different lines, existing in Germany, France, Russia and Switzerland, but they are mainly co-operative bodies instituted for the general benefit of members, who are without exception either bee-keepers on a more or less extensive scale, or scientists interested in the study of insect life.

The bee-keepers' associations of the United States, Canada and most of the British colonies, are—like those last mentioned above—formed for the sole and laudable purpose of promoting the business interests of their members, the latter being either bee-farmers or bee-appliance manufacturers. Thus they make no pretension of any but business discussions at their conferences, and much benefit to all concerned follows as a matter of course. In fact, we find enthusiastic bee-men and women travelling several hundreds of miles and devoting time, money and labour in attending conferences of bee-keepers in America, while the proceedings usually last for several days and are largely attended. The extent of the industry compared with that of Great Britain is so great that it fully accounts for the difference in procedure of the respective associations.

As a natural consequence of this activity, the trade in bee-appliance making has assumed enormous proportions in the United States, where extensive factories have been established; one firm—employing over 500 hands, and using electric-power machinery of the most modern type—being devoted entirely to the manufacture of bee-goods and apianian requisites. From this establishment alone the yearly output is about 25,000 bee-hives, and upwards of 100 millions of the small wooden boxes used for holding comb-honey. The most generally approved form of this box is known as the "1-lb section," made from a strip of wood $\frac{1}{2}$ in. thick, 2 in. wide, and of such length that when folded by joining the morticed and tenoned ends A B (fig. 10) it forms the section or box C, measuring $4\frac{1}{2} \times 4\frac{1}{2} \times 2$ " when complete, and holds about 1 lb of comb-honey when filled by the bees and ready for table use. The V-shaped groove D (cut across and partly through the wood) shows the joint when in the flat, and E the same joint when closed for use. All the section boxes used in the United Kingdom are made in the U.S.A. or in Canada from the timber known as basswood, no native wood being suitable for the purpose.

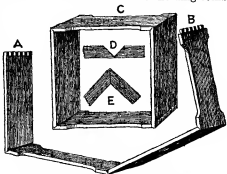

FIG. 10.—"1-lb section" wooden box for holding Comb-honey.

(Redrawn from the *A B C of Bee-Culture*, published by the A. I. Root Co., Medina, Ohio, U.S.A.)

Development of the Movable-frame Hive.—The dome-shaped straw skep of our forefathers may be regarded as the typical bee-hive of all time and of all civilized countries; indeed, it may with truth be said that as a healthy and convenient home for the honey-bee it has no equal. A swarm of bees hived in a straw skep, the picturesque little domicile known the world over as the personification of industry, will furnish their home with waxen combs in form and shape so admirably adapted to their requirements as to need no improvement by man. Why the circular form was chosen for the skep need not be inquired into, beyond saying that its shape conforms to that of a swarm, as the bees usually hang clustered on the branch of a neighbouring tree or bush after issuing from the parent hive. Fig. 11 shows a straw skep in section, and explains

As illustrating the admirable way in which the bees furnish their dwelling. The vertical section (A) shows the lower portion of the combs devoted to brood-rearing, the higher and thicker combs being reserved for honey, and midway between the brood and food is stored the pollen required for mixing with honey in feeding the larvae. It will be seen how well the upper part of the combs are fitted for bearing the weight of stores they contain,

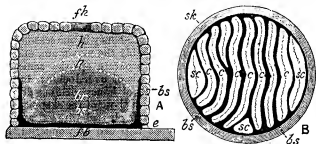

FIG. 11.—Straw skep in section, showing arrangement of Combs

A, Vertical section. *p*, Pollen. B, Horizontal section.
fb, Floor board. *h*, Honey. *sk*, Skep-side.
e, Entrance. *fh*, Feeding hole. *c, c*, Combs.
br, Brood. *bs, bs*, Bee spaces. *sc, sc*, Store combs.
bs, bs, Bee spaces.

(From Cheshire's *Bees and Bee-keeping*, Scientific and Practical.)

As illustrating the admirable way in which the bees furnish their dwelling. The vertical section (A) shows the lower portion of the combs devoted to brood-rearing, the higher and thicker combs being reserved for honey, and midway between the brood and food is stored the pollen required for mixing with honey in feeding the larvae. It will be seen how well the upper part of the combs are fitted for bearing the weight of stores they contain,

Bee and honey shows.

Honey labels.

The bee-appliance trade.

The straw skep.

and how the lower portion allows the bees to cluster around the tender larvae and thus maintain the warmth necessary during its metamorphosis from the egg to the perfect insect. The horizontal section (B) with equal clearness demonstrates the bee's ingenuity in economizing space, showing how the outer combs are used exclusively for stores, and, as such, may be built of varying thickness as more or less storage room is required. The straw skep has, however, the irredeemable fault of fixed combs,

The movable-frame hive.

and the gradual development of the movable-frame hive of to-day may be said to have first appeared in 1789 with the leaf-hive of Huber, so called from its opening like the leaves of a book. Prior to that date wooden box-hives of various shapes had been adopted by advanced bee-masters anxious to increase their output of honey, and by enthusiastic naturalists desirous of studying and investigating the wonders of bee-life apart from the utilitarian standpoint. Foremost among the latter was the distinguished Swiss naturalist and bee-keeper, François Huber, who was led to construct the leaf-hive bearing his name after experimenting with a single comb observatory hive recommended by Réaumur. Huber found that although he could induce swarms to occupy the glass-sided single frame advised by Réaumur, if the frame was fitted with ready-built pieces of comb patched together before hiving the swarm, the experiment was successful, while if left to themselves the bees built small combs across the space between the sheets of glass, and the desired inspection from the outside was thus rendered impossible. He also gathered that the abnormal conditions forced upon the bees by a ready-built single comb might so turn aside their natural instincts as to render his investigations less trustworthy than if conducted under perfectly natural conditions; so, in order to remove all doubt, he decided to have a series of wooden frames made, measuring 12 in. sq., each of rather more than the ordinary width allowed for brood-combs. These frames were numbered consecutively 1 to 12, and hinged together as shown in fig. 12 (h, A). In this way the

Ten of these frames had a small piece of comb fixed to the top-bar in each, supported (temporarily) by a thin lath wedged up with pegs at side, the latter being removed when the comb had been made secure by the bees. When closed, the ten frames, together with the two outside ones (fitted with squares of glass for inspection), which represent the covers of the book, were tied together with a couple of stout strings. In a subsequent form of the same hive Huber was enabled—with the help of very long thumb-screws at each side (fig. 13)—to raise up any frame between two sheets of glass which confined the bees and allowed him to study the process of comb-building better than any hive we know of to-day. By means of the leaf-hive and using the entrances (fig. 12, e, e, A) Huber made artificial swarms by dividing and the use of division-boards, though not in quite the same fashion as is practised at the present day. On the other hand, it must be admitted that

Huber's observatory hive.

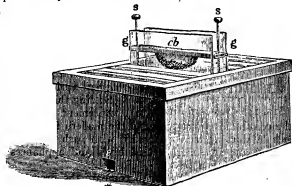

FIG. 13.—Huber's bar-hive, showing how comb is built. *cb*, Comb bar; *g, g*, glass sheets; *s, s*, screws; *e*, entrance.

(From Cheshire's *Bees and Bee-keeping, Scientific and Practical*.)

Huber's hive was defective in many respects; the parting of each frame, thus letting loose the whole colony, caused much trouble at times, but it remained the only movable-comb hive till 1838, when Dr Dzierzon—whose theory of parthenogenesis has made his name famous—devised a box-hive with a loose top-bar on which the bees built their combs and a movable side or door, by means of which the frames could be lifted out for inspection. This improvement was at once appreciated, and in the year 1852 Baron Berlepsch added side-bars and a bottom-bar, thus completing the movable frame.

About the same time the Rev. L. L. Langstroth was experimenting on the same lines in America, and in 1852 his important invention was made known, giving to the world of bee-keepers a movable frame which in its most important details will never be excelled. We refer to the respective distances left between the side-bars and hive walls on each side, and between the lower edge of the bottom-bars and the floor-board. Langstroth, in his measurements, hit upon the happy mean which keeps bees from propolizing or fastening the frames to the hive body, as they assuredly would do if sufficient space had not been allowed for free passage round the side-bars; it is equally certain that if too much space had been provided, they would fill it with comb and thus render the frame immovable. In addition to these benefits, Langstroth's frame and hive possessed the enormous advantage over Dzierzon's of being manipulated from above, so that any single frame could be raised for inspection without disturbing the others. Langstroth's space-measurements have remained practically unaltered notwithstanding the many improvements in hive-making, and in the various sizes of movable frames, since introduced and used in different parts of the world.

Langstroth's hive.

In the United States of America Langstroth's frame and hive are the acknowledged "standards" among the great body of bee-keepers, although about a dozen different frames, varying more or less in size, have their adherents. Size of frames in the U.S.A. Among these may be named the American, Adair, the American, Dandenbaker, Gallup, Heddon, Langstroth and Quinby. Three of these, the American, Adair and Gallup, may

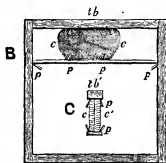
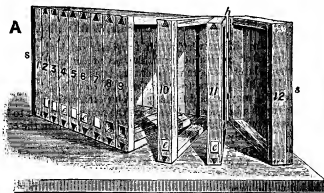

FIG. 12.—Huber's book or leaf hive.

- A, Book hive. B, Side view of frame or leaf. C, Part of bin, cross section, lettering as before.
e, e, Entrances. *tb*, Top-bar.
s, s, Side leaves. *c, c*, Comb.
h, h, Hinges. *p, p*, Pegs.

(From Cheshire's *Bees and Bee-keeping, Scientific and Practical*.)

frames of comb could be opened for inspection like a book, while when closed the bees clustered together as in an ordinary hive.

be termed square frames, the others being oblong, but the latter shape appears to possess the most all-round advantages to the modern bee-keeper. Amid the different climatic conditions of so vast a continent as America, variation in size, and in the capacity of frames used, is in some measure accounted for.

In the British Isles, though the conditions are variable enough, they are less extreme, and, fortunately for those engaged in the pursuit, only one size of frame is acknowledged by the great majority of bee-keepers, viz. the British Bee-keepers' Association "Standard" (fig. 14). This frame, the outside measurement of which is 14 by 8½ in., was the outcome of deliberations extending over a considerable time on the part of a committee of well-known bee-keepers, specially appointed in 1882 to consider the matter. In this way,

whatever type or form of hive is used, the frames are interchangeable. Differences in view may, and do, exist regarding the thickness of the wood used in frame-making, but the outside measurement never varies. Notwithstanding this fact, the advancement of apiculture

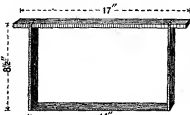

FIG. 14.—Standard Frame.

and the continuous development of the modern frame-hive and methods of working have proceeded with such rapidity, both in England and in America, that hives and appliances used prior to 1885 are now obsolete.

It may, therefore, be useful to compare the progress made in the United States of America and in Great Britain in order to show that, while the industry is incomparably larger and of more importance in America and Canada than in Great Britain, British bee-keepers have been abreast of the times in all things apicultural. The original Langstroth hive was single-walled, held ten frames (size 17½ by 9 in.), and had a deep roof, made to cover a case of small honey boxes like the sections now in use; but the cumbersome projecting porch and sides, made to support the roof, are now dispensed with, and the number of frames reduced to eight. Although various modifications have since been made in minor details—all tending to improvement—its main features are unaltered. The typical hive of America is the improved Langstroth (fig. 15), which has no other covering for the frame tops but a flat roof-board allowing ¼ in. space between the roof and top-bars for bees to pass from frame to frame. Consequently, on the roof being raised the bees can take wing if not prevented from doing so. This feature finds no favour with British bee-keepers, nevertheless the "improved Langstroth" is a useful and simple

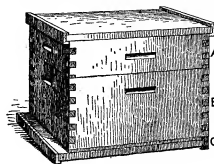

FIG. 15.—Langstroth Hive.

(Redrawn from the *A B C of Bee-Culture*, published by the A. I. Root Co., Medina, Ohio, U. S. A.)

and no doubt efficient, but not suitable for bees wintered on their summer stands, as nearly all hives are in Great Britain. American bee-keepers, therefore, find it necessary to provide underground cellars, into which the bees are carried in the fall of each year, remaining there till work begins in the following spring. Those among them who cannot, for various reasons, adopt the cellar-wintering plan are obliged to provide what are termed "chaff-covers" for protecting their bees in winter. Of late years they have also introduced, as an improvement, the plan long followed in England of using double-walled chaff-packed hives. The difference here is that packing is now dispensed with, it being found

that bees winter equally well with an outer case giving 1½ in. of free space on all sides of the hive proper, but with no packing in between. Thus no change is needed in winter or summer, the air-space protecting the bees from cold in winter and heat in summer. Another point of difference between the English and American hive is the roof, which being gable-shaped in the former allows warm packing to be placed directly on the frame tops, so that the bees are covered in when the roof is removed and may be examined or fed with very little disturbance. Again, the American hive is, as a general rule, set close down on the ground, while stands or short legs are invariably used in Great Britain. One of the best-known hives in England is that known as the W.B.C. hive, devised in 1890 by W. Broughton Carr.

Figs. 16 and 17 explain its construction and, as will be seen, it is equally suitable when working for comb or for extracted honey.

Various causes have contributed to the development of the modern hive, the most important of which are the improvements in methods of extracting honey from combs, and in the manufacture of comb-foundation. Regarding the first of these, it cannot be said that the honey extractor, even in its latest form, differs very much from the original machine (fig. 18) invented by Major Hruschka, an officer in the Italian army, who in later life became an enthusiastic apiculturist. Hruschka's extractor, first brought to public notice in 1865, may be said to have revolutionized the bee-industry as a business. It enabled the honey producer to increase his output considerably by extracting honey from the cells

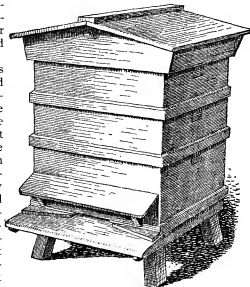

FIG. 16.—Exterior, W.B.C. Hive.

in most cleanly fashion without damaging the combs, and in a fraction of the time previously occupied in the draining, heating and squeezing process. At the same time the combs were preserved for refilling by the bees, in lieu of melting them down for wax. The principle of the honey extractor (throwing the liquid honey out of the cells by centrifugal force) was discovered quite by accident. Major Hruschka's little son chanced to have in his hand a bit of unsealed comb-honey in a basket to which was attached a piece of string, and, as the boy playfully whirled the basket round in the air, his father noticed a few drops of honey,

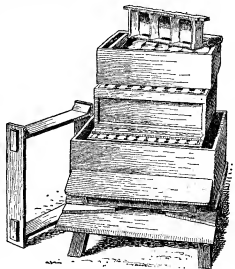

FIG. 17.—Interior, W.B.C. Hive.

Winter cellars for bees.

Honey extractors.

thrown out of the comb by the centrifugal force employed to keep the basket suspended. The value of the idea at once struck him; he set to work on utilizing the principle involved, and ere long had constructed a machine admirably adapted to serve its purpose. Since that time changes, of more or less value, have been introduced to meet present-day requirements.

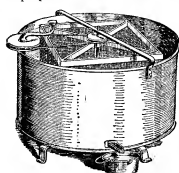

FIG. 18.—Hruschka Extractor.

(Redrawn from the *A B C of Bee-Culture*, published by the A. I. Root Co., Medina, Ohio, U.S.A.)

One of the first to take advantage of Hruschka's invention was Mr A. I. Root, who in 1869 perfected a machine on similar lines to the Hruschka one but embodying various improvements. This appliance, known as the "Novice Honey Extractor," became very popular in the United States of America, but it had the fault of wasting time in removing the combs for reversing after one side had been emptied of its contents. A simple form of machine for extracting honey by centrifugal force was brought to notice in England in 1875, and was soon improved upon, as will be seen in fig. 19, which shows a section of one of the best English machines at that time. Various plans were tried in America to improve on the "Novice" machine, and Mr T. W. Cowan, who was experimenting in the same direction in England, invented in the year 1875 a machine called the "Rapid," in which the combs were reversed without removal of the cages (fig. 20).

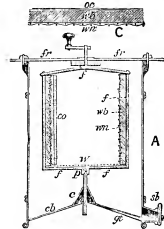

FIG. 19.—Diagram of the Raynor Extractor.

- A, Section of extractor.
 fr, Fixing rail.
 ffj, Frame for cage.
 w, Metal webbing.
 wv, Wire netting.
 c, Comb.
 w, Wire bottom.
 p, Pivot.
 c, Stiffening cone.
 cb, Coned bottom.
 gl, Gutter.
 st, Syrup tap.

C, Perpendicular section of side of cage enlarged.

- oc, Outer casing.
 w, Metal webbing.
 wv, Wire netting.
 (From *Chester's Bees and Bee-keeping*, Scientific and Practical.)

taking eight or more frames at one time. It may also be claimed for the honey extractor that it does away with the objection entertained by many persons to the use of honey, by enabling the apiculturist to remove his produce from the honey-combs in its purest form untaunted by crushed brood and untouched by hand.

Next in importance, to bee-keepers, is the enormous advance made in late years through the invention of a machine for manufacturing the impressed wax sheets known as "comb foundation," aptly so named, because upon it the bees build the cells wherein they store their food.

Comb foundation.

We need not dwell upon the evolution from the crude idea, which first took form in the endeavour to compel bees to build straight combs in a given direction by offering them a guiding line of wax along the under side of each top-bar of the frame in which the combs were built; but we may glance at the more important improvements which gradually developed as time went on. In 1843 a German bee-keeper, Krehner by name, conceived the idea of first dipping fine linen into molten wax, then pressing the sheets so made between rollers, and thus forming a waxen midrib on which the bees would build their combs. This experiment was partially successful, but the instinctive dislike of bees to anything of a fibrous nature caused them completely to spoil their work of comb-building in the endeavour to tear or gnaw away the linen threads whenever they got in touch with them. In 1857 Mehring (also a German) made a further advance by the use of wooden moulds for casting sheets of wax impressed with the hexagonal form of the bee-cell. These sheets were readily accepted by the bees, and afterwards plates cast from metal were employed, with so good a result as to give to the bees as perfect a midrib as that of natural comb with the deep cell walls cut away. Fig. 22 shows a portion of one of these metal plates with worker-cells of natural size, i.e. five cells to the inch. Thus Mehring is justly claimed as the originator of comb-foundation, though the value of his invention was less eagerly taken advantage of even in Germany than its merits deserved. Probably it was ahead of the times, for not until nearly twenty years later was any prominence given to it, when Samuel Wagner, founder and editor of the *American Bee Journal*, became impressed with Mehring's invention and warmly advocated it in his paper. Mr Wagner first conceived the idea of adding slightly raised side walls to the hexagonal outlines of the cells, by means of which the bees are supplied with the material for building out one-half or more of the complete cell walls or sides. The manifest advantage of this was at once realized by practical American apiculturists as saving labour to the bees and money to the bee-keeper. One of the first to recognize its value was Mr A. I. Root, of Medina, Ohio, who suggested the substitution of embossed rollers in lieu of flat plates, in order to increase the output of foundation and lessen its cost to the bee-keeper. He lost no time in giving practical shape to his views, and mainly through the inventive genius of a skilled machinist (Mr A. Washburn) the A. I. Root Co. constructed a roller press (fig. 23) for producing foundation in sheets. This form of machine came

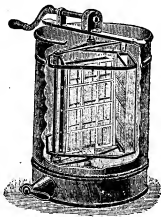

FIG. 20.—Cowan's rapid Extractor.

of comb-building in the endeavour to tear or gnaw away the linen threads whenever they got in touch with them. In 1857 Mehring (also a German) made a further advance by the use of wooden moulds for casting sheets of wax impressed with the hexagonal form of the bee-cell. These sheets were readily accepted by the bees, and afterwards plates cast from metal were employed, with so good a result as to give to the bees as perfect a midrib as that of natural comb with the deep cell walls cut away. Fig. 22 shows a portion of one of these metal plates with worker-cells of natural size, i.e. five cells to the inch. Thus Mehring is justly claimed as the originator of comb-foundation, though the value of his invention was less eagerly taken advantage of even in Germany than its merits deserved. Probably it was ahead of the times, for not until nearly twenty years later was any prominence given to it, when Samuel Wagner, founder and editor of the *American Bee Journal*, became impressed with Mehring's invention and warmly advocated it in his paper. Mr Wagner first conceived the idea of adding slightly raised side walls to the hexagonal outlines of the cells, by means of which the bees are supplied with the material for building out one-half or more of the complete cell walls or sides. The manifest advantage of this was at once realized by practical American apiculturists as saving labour to the bees and money to the bee-keeper. One of the first to recognize its value was Mr A. I. Root, of Medina, Ohio, who suggested the substitution of embossed rollers in lieu of flat plates, in order to increase the output of foundation and lessen its cost to the bee-keeper. He lost no time in giving practical shape to his views, and mainly through the inventive genius of a skilled machinist (Mr A. Washburn) the A. I. Root Co. constructed a roller press (fig. 23) for producing foundation in sheets. This form of machine came

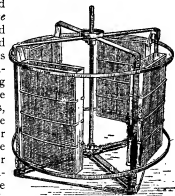

FIG. 21.—Cowan's four-frame Extractor; interior.

(Redrawn from the *A B C of Bee-Culture*, published by the A. I. Root Co., Medina, Ohio, U.S.A.)

by means of which the bees are supplied with the material for building out one-half or more of the complete cell walls or sides. The manifest advantage of this was at once realized by practical American apiculturists as saving labour to the bees and money to the bee-keeper. One of the first to recognize its value was Mr A. I. Root, of Medina, Ohio, who suggested the substitution of embossed rollers in lieu of flat plates, in order to increase the output of foundation and lessen its cost to the bee-keeper. He lost no time in giving practical shape to his views, and mainly through the inventive genius of a skilled machinist (Mr A. Washburn) the A. I. Root Co. constructed a roller press (fig. 23) for producing foundation in sheets. This form of machine came

into extensive use in the United States of America and afterwards in Great Britain. The first roller press was made by the A. I. Root Co. and imported by Mr William Raitt, a Scottish bee-keeper of repute in Perthshire, N.B. In all roller machines used at that time the plain sheets of wax were first made by the "dipping" process, *i.e.* by repeated dippings of

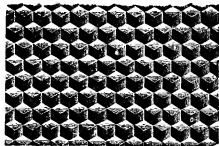

FIG. 22.—Portion of a type-metal plate—*i.e.* form of Comb Midrib (five cells to the inch).

(From Cheshire's *Bees and Bee-keeping, Scientific and Practical*.)

damped boards in molten wax (kept in liquid condition in tanks immersed in hot water) until the sheet was of suitable thickness for the purpose. The prepared sheets were then passed through the rollers, and after being cut out and trimmed were ready for use.

Owing to the enormous demand for comb-foundation at

that time various devices were tried with the view of securing (1) more rapid production, and (2) a foundation thin enough to be used in surplus chambers when working for comb-honey intended for table use. Foremost among the able men who experimented in this latter direction was Mr F. B. Weed, a skillful American machinist, who, after some years of strenuous effort, succeeded in devising and perfecting special rollers and dies, by the use of which foundation was produced with a midrib so thin as to compare favourably with natural comb built by the bees. "Dipping," however, proved not only a stumbling-block to speed but to the production of continuous sheets of wax; and in the end Mr Weed, acting in concert with Mr A. I. Root (who

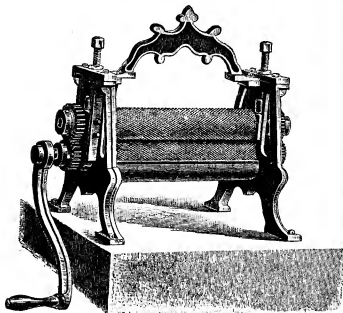

FIG. 23.—Foundation Machine.

(From Cheshire's *Bees and Bee-keeping, Scientific and Practical*.)

placed the resources of his enormous factory at his disposal), devised and perfected machinery—driven by motor power—for manufacturing foundation by what is known as the "Weed" process. By this process "dipping" is abolished, and in its latest form sheets of wax of any length are produced, passed between engraved rollers 6 in. in diameter, cut to given lengths, trimmed, counted and paper-tissued ready for packing, at a rate of speed previously undreamt of.

Practical Management of Bees.—Among the world of insects

the honey-bee stands pre-eminent as the most serviceable to mankind; from the day on which the little labourer leaves its home for the first time in search of food, its mission is undoubtedly useful. Launched upon an unknown world, and guided by unerring instinct to the very flowers it seeks, the bee fertilizes fruit and flowers while winging its happy flight among the blossoms, gathering pollen for the nurslings of its own home and honey for the use of man. Nothing seems to be lost, nor can any part of the bee's work be accounted labour in vain; the very wax from which the insect builds the store-combs for its food and the cells in which its young are hatched and reared is valuable to mankind in many ways, and is regarded to-day no less than in the past ages as an important commercial product. The hive bee is, moreover, the only insect known to be capable of domestication, so far as labouring under the direct control of the bee-master is concerned, its habits being admirably adapted for embodying human methods of working for profit in our present-day life.

In dealing with the practical side of apiculture it will not be necessary to do more than mention the salient points to be considered by those desirous of acquiring more complete knowledge of the subject. Authoritative text-books specially written for the guidance of bee-keepers are numerous and cheap, and on no account should any one engage in an attempt to manage bees on modern lines without a careful perusal of one or more of these. Bearing this in mind the reader will understand that so much of the natural history of the honey-bee as is necessary for elucidating the practical part of our subject may be comprised in (1) the life of the insect, (2) its mission in life, and (3) utilizing to the utmost the brief period during which it can labour before being worn out with toil.

A prosperous bee-colony managed on modern lines will in the height of summer consist of three kinds of bees: a queen or mother-bee, a certain number of drones, and from 80,000 to 100,000 workers. With regard to sex, the queen is a fully-developed female, the drones are males and the workers may be termed neuters or partially developed females. These last possess ovaries like the queen, but shrunken and aborted so as to render the insect normally incapable of egg-production. The relative importance of the three kinds of bees differs greatly in degree and in somewhat curious fashion. For instance, the queen (or "king" of the hives as it was termed by our forefathers) is of paramount importance at certain seasons, her death or disablement during the period when the male element is absent meaning extinction of the whole colony. Fecundation would under such conditions be impossible, and without this the eggs of a resultant queen will produce nothing but drones. During the summer season, however (from May to July), when drones are abundant, the loss of a queen is of comparatively little moment, as the workers can transform eggs (or young larvae not more than three days old), which would in the ordinary course produce worker bees, into fully-developed queens, capable of fulfilling all the maternal duties of a mother-bee. The value of this wonderful provision of nature to the bee-keeper of to-day may be estimated from the fact that bees managed according to modern methods are necessarily subject to so much manipulating or handling, that fatal accidents are as likely to happen in bee-life as among human beings.

Authorities differ with regard to the age during which the queen-bee is useful to the bee-keeper who works for profit. Under normal conditions the insect will live for three, four or sometimes five years, but the stimulation given, together with



FIG. 24.—Hive bee (*Apis mellifica*).
a, Worker; b, queen; c, drone.

(From Cheshire's *Bees and Bee-keeping, Scientific and Practical*.)

Sex of
bees.

Loss of
queens.

the high-pressure system followed in modern bee-management, exhausts the period of her greatest fecundity in two years, so that queens are usually superseded after their second season has expired and egg-production gradually decreases. This can hardly cause wonder if it is borne in mind that for many weeks during the height of the season a prolific queen will deposit eggs at the rate of from two to three thousand every twenty-four hours.

Drones (or male bees) are more or less numerous in hives according to the skill of the bee-keeper in limiting their production. It is admitted by those best able to judge that the proportion of about a hundred drones in each hive is conducive to the prosperity of the colony, but beyond that number they are worse than useless, being non-producers and heavy consumers. Thus in times of scarcity, which are not infrequent during the early part of the season, they become a heavy tax upon the food-supply of the colony at the critical period when brood-rearing is accelerated by an abundance of stores, while shortness of food means a falling-off in egg-production. The modern bee-keeper, therefore, allows just so much drone comb in the hive as will produce a sufficient number of drones to ensure queen-mating, while affording to the bees the satisfaction of dwelling in a home equipped according to natural conditions, and containing all the elements necessary to bee-life. The action of the bees themselves makes this point clear, for when the season of mating is past the drone is no longer needed, the providing of winter stores taking first place in the economy of the hive. So long as honey is being gathered in plenty drones are tolerated, but no sooner does the honey harvest show signs of being over than they are mercilessly killed and cast out of the hive by the workers, after a brief idle life of about four months' duration. Thus the "lazy yawning drone," as Shakespeare puts it, has a short shrift when his usefulness to the community is ended.

Finally we have the aptly named worker-bee, on whom devolves the entire labour of the colony. The worker-bee is incapable of egg-production and can therefore take no part in the perpetuation of its species, so that individually its value to the community is infinitesimal. Yet it forms an item in a commonwealth, the members of which are in all respects equally well endowed. They are in turn skilled scientists, architects, builders, artisans, labourers and even scavengers; but collectively they are the rulers on whom the colony depends for the wonderful condition of law and order which has made the bee-community a model of good government for all mankind. Then so far as regards longevity, the period of a worker-bee's existence is not measured by numbering its days but simply by wear and tear, the marvellous intricacy and wonderful perfection of its framework

being so delicate in construction that after six or seven weeks of strenuous toil, such as the bee undergoes in summer time, the little creature's labour is ended by a natural death. On the other hand, worker-bees hatched in the autumn will seven months later be strong with the vigour of lusty youth; able to take their full share in the labour of the hive for six weeks or more in the early spring, which is the most critical period in the colony's existence; hence the value to the apiarist of bees hatched in the autumn.

The mission of the worker-bee is *work*; not so much for itself as for the younger members of the community to which it belongs. We cannot claim for it the virtue of strict honesty with regard to the stranger, but for its own "kith and kin" it is a model of socialism in an ideal form, possessing nothing of its own yet toiling unceasingly for the good of all. The increasing warmth of each recurring spring finds the bee awake, and full of eagerness to be up and doing; its sole mission being apparently to accomplish as much work as possible while life lasts. The earliest pollen is sought out from far and near, and has its immediate effect upon the mother bee of the colony. If healthy and young she begins egg-laying at once, and brood-rearing proceeds at an ever-increasing rate as each week passes, until the hive is brimming over with bees in time for the first honey flow. Then

comes the almost human foresight with which the bee prevents the inevitable chaos created by an overcrowded home. There is no cell-room either for storing the abundant supply of food constantly being brought in, or for the thousands of eggs which a prolific queen will produce daily as a consequence of general prosperity; therefore unless help comes from without an exodus is prepared for, and what is known as "swarming" takes place.

It would be difficult to imagine anything more exhilarating to a beginner in bee-keeping than the sight of his first hive in the act of swarming. The little creatures are seen rushing in frantic haste from the hive like a living stream, filling the air with ever-increasing thousands of bees on the wing. The incoming workers returning pollen-laden from the fields, carried away by the prevailing excitement, do not stop to unload their burdens in the old home, but join the enthusiastic emigrants, tumbling over each other pell-mell in the outrush; among them the queen of the colony will in due course have taken her place, bound like her children for a new home. It soon becomes apparent to the onlooker when the queen has joined the flying multitude of bees in the air, for they are seen to be closing up their ranks, and in a few moments begin to form a solid cluster, usually on the branch of a small tree or bush close to the ground. When this stage of swarming is reached the bee-keeper has but to take his hiving skep, hold it under the swarm, and shake the bees into it, preparatory to transferring them into a frame-hive already prepared for their reception. The process of hiving a swarm is very simple and need not occupy many moments of time under ordinary conditions, but so many unlooked-for contingencies may arise that the apiarist would do well to prepare himself beforehand by carefully reading the directions in his text-book.

The illustration given in fig. 25 will serve more readily than words to enlighten the would-be bee-keeper. It shows a portion of honeycomb (natural size) not precisely as it appears when the frame containing it is lifted out of the hive, but as would be seen on two or more combs in the same hive, namely, the various cells built for—and occupied by—queens, drones and workers; also the larvae or grubs in the various stages of transformation

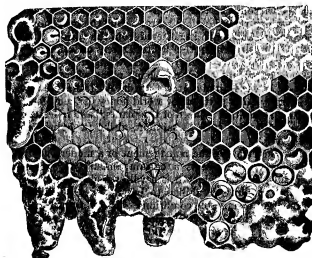

FIG. 25.—Honeycomb, Metamorphoses of the Honey Bee.

(From Cheshire's *Bees and Bee-keeping, Scientific and Practical*.)

from egg to perfect insect, with the latter biting their way out of sealed cells. It also shows sealed honey and pollen in cells, &c. To familiarize himself with the various objects depicted, all of which are drawn from nature, will not only help the reader to understand the different phases of bee-life during the swarming season, but tend to increase the interest of beginners in the pursuit. "Early drones, early swarms" was the ancient bee-man's favourite adage, and the skilled apiarist of to-day

experiences the same pleasurable thrill as did the skeppist of old at the sight of the first drone of the year, which betokens an early swarm. As the drones increase in number queen-cells are formed, unless steps be taken to turn aside the swarming impulse by affording additional room beforehand in the hive. The above brief outline of the guiding principles of natural swarming is merely intended as introductory to the fuller information given in a good text-book.

Management of an Apiary.—The main consideration in establishing an apiary is to secure a favourable location, which means a place where honey of good marketable quality may be gathered from the bee-forest growing around without any planting on the part of the bee-keeper himself. It is impossible to deal here with the varying conditions under which apiculture is carried on in all parts of the world, but, as a rule, the same principle applies everywhere. The bee industry prospers greatly in America, where amid the vast stretches of mountain and canyon in California the bee-forest extends for miles without a break, and the climatic conditions are so generally favourable as to reduce to a minimum the chances of the honey crop failing through adverse weather.

The bee-keeper's object is to utilize to the utmost the brief space of a worker-bee's life in summer, by adopting the best methods in vogue for building up stocks to full strength before the honey-gathering time begins, and preparing for it by the exercise of skill and intelligence in carrying out this work.

In the United Kingdom there is a difference of several weeks in the honey season between north and south. Swarming usually begins in May in the south of England, and in mid-July in the north of Scotland, the issue of swarms coinciding with the early part of the main honey flow. The weather is naturally more precarious in autumn than earlier in the year, and chances of success proportionately smaller for northern bee-men, but the disadvantage to the latter is more than compensated for by the heather season, which extends well into September. With regard to the British bee-keeper located in the south, and the early fruit crop is what concerns him most, and

Value of pollen.

where pollen (the fertilizing dust of flowers) is plentiful his bees will make steady progress. If pollen is scarce, a substitute in the form of either pea-meal or wheaten flour must be supplied to the bees, as brood-rearing cannot make headway without the nitrogenous element indispensable in the food on which the young are reared. But the main honey-crop of both north and south is gathered from the various trifoliums,

The queen of bee-plants.

among which the white Dutch or common clover (*Trifolium repens*) is acknowledged to be the most important honey-producing plant wherever it grows. In the United States, Canada, Australia, New Zealand and in many other parts of the world-honey of the finest quality is obtained from this "queen of bee-plants," and in lesser degree from other clovers such as sainfoin, alsike (a hybrid clover), trefoil, &c.

Before undertaking the management of a modern apiary, the bee-keeper should possess a certain amount of aptitude for the pursuit, without which it is hardly possible to succeed. He must also acquire the ability to handle bees judiciously and well under all imaginable conditions. In doing this it is needful to remember that bees resent outside interference with either their work or their hives, and will resolutely defend themselves when aroused even at the cost of life itself. Experience has also proved that, when alarmed, bees instinctively begin to fill their honey-sacs with food from the nearest store-cells as a safeguard against contingencies, and when so provided they are more amenable to interference. The bee-keeper, therefore, by the judicious application of a little smoke from smouldering fuel, blown into the hive by means of an appliance known as a bee-smoker, alarms the bees and is thus able to manipulate the frames of comb with ease and almost no disturbance. The smoker (fig. 26) devised by T. F. Bingham of Farwell, Michigan, U.S.A., is the one most used in America and in the United Kingdom. No other protection is needed beyond a bee-veil of fine black net, which slipped over a wide-brimmed straw hat protects the

face from stings when working among bees; as experience is gained the veil is not always used. The man who is hasty and nervous in temperament, who fears an occasional sting, and resents the same by viciously killing the bee that inflicts it will rarely make a good apiarist. The methods of handling bees vary in different countries, this being in a great measure accounted for by the number of hives kept. Very few apiaries in the United Kingdom contain more than a hundred hives; consequently the British bee-keeper has no need for employing the forceful or "hustling" methods found necessary in America, where the honey-crop is gathered in car-loads and the hives numbered by thousands. It naturally follows that bee-life is there regarded very slightly by comparison, and the "bee-garden" in England becomes the "bee-yard" in America, where the apiarist when at work must thoroughly protect himself from being stung, and, safe in his immunity from damage, cares little for bee-life in getting through his task, the loss of a few hundred bees being considered of no account. There are, however, other reasons, apart from humanity, to account for the difference in handling bees as advocated in the United Kingdom. The great majority of apiaries owned by British bee-keepers are located in close proximity to neighbours; consequently a serious upset among the bees would in many cases involve an amount of trouble which should if possible be avoided; therefore quietness and the exercise of care when manipulating are always recommended by teachers, and practised by those who wisely take their lessons to heart.

Having made himself proficient in practical bee-work and chosen a suitable location for his apiary, the bee-keeper should carefully select the particular type of hive most suited to his means and requirements. This point settled, uniformity is secured, and all loose parts of the hives being interchangeable time will be saved during the busy season when time means money. Beginning with not too many stocks he can test the capabilities of his location before investing much capital in the undertaking, so that by utilizing the information already given and adopting the wise adage "make haste slowly" he will realize in good time whether it will pay best to work for honey in comb or extracted honey in bulk; not only so, but the knowledge gained will enable him to select such appliances as are suited to his needs. As a rule, it may be said that the man content to start with an apiary of moderate size—say fifty stocks—may realize a fair profit from comb-honey only; but so limited a venture would need to be supplemented by some other means before an adequate income could be secured. On the other hand, the owner of one or two hundred colonies would find it more lucrative to work for extracted honey and send it out to wholesale buyers in that form. By so doing a far greater weight of surplus per hive may be secured, and extracted honey will keep in good condition for years, while comb-honey must be sold before granulation sets in. At the same time it is but fair to say that bee-culture in the United Kingdom, if limited to honey-production alone, is not sufficiently safe for entire reliance to be placed on it for obtaining a livelihood. The uncertain climate renders it necessary to include either other branches of the craft less dependent on warmth and sunshine, or to combine it with fruit-growing, poultry-rearing, &c. Under such conditions the bees will usually occupy a good position in the balance-sheet.

Another indispensable feature of good bee-management is "forethought," coupled with order and neatness; the rule of

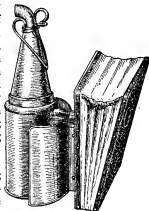

FIG. 26.—Bee-Smoker.
(Redrawn from the *ABC of Bee-Culture*, published by the A. I. Root Co., Medina, Ohio, U.S.A.)

Choosing a location.

Bee-keeping for profit.

"a place for everything and everything in its place" prepares the bee-keeper for any emergency; constant watchfulness is also necessary, not only to guard against disease in his hives, but to overlook nothing that tends to be of advantage to the bees at all seasons. Among the many ways of saving time nothing is more useful than a carefully-kept note-book, wherein are recorded brief memoranda regarding such items as condition of each stock when packed for winter, amount of stores, age and prolific capacity of queen, strength of colony, healthiness or otherwise, &c., all of which particulars should be noted and the hives to which they refer plainly numbered. It also enables the bee-keeper to arrange his day's work indoors while avoiding disturbance to such colonies as do not need interference. In the early spring stores must be seen to and replenished where required; breeding stimulated when pollen begins to be gathered; and appliances cleaned and prepared for use during the busy season.

The main honey-gathering time (lasting about six or seven weeks) is so brief that in no pursuit is it more important to "make hay while the sun shines," and if the bee-keeper needs a reminder of this truism he surely has it in the example set by his bees. As the season advances and the flowers yield nectar more freely, visible signs of comb-building will be observed in the whitened edges of empty cells in the brood-chambers; the thoughtful workers are lengthening out the cells for honey-storing, and the bee-master takes the hint by giving room in advance, thus lessening the chance of undesired swarms. In other words, order and method, combined with the habit of taking time by the forelock, are absolutely necessary to the bee-keeper, seeing that the enormous army of workers under his control is multiplying daily by scores of thousands. As spring merges into summer, sunny days become more frequent; the ever-increasing breadth of bee-forestage yields still more abundantly, and the excitement among the labourers crowding the hives increases, rendering room in advance, shade and ventilation, a *sine qua non*. It requires a level head to keep cool amongst a couple of hundred strong stocks of bees on a hot summer's day in a good honey season.

Moreover, it will be too late to think of giving ventilation at noontide, when the temperature has risen to 80° F. in the shade; the necessary precautions for swarm prevention must therefore be taken in advance, for when what is known as the "swarming fever" once starts it is most difficult to overcome.

The well-read and intelligent bee-keeper, content to work on orthodox lines, will be able to manage an apiary—large or small—by guiding and controlling the countless army he commands in a way that will yield him both pleasure and profit. All he needs is good bee weather and an apiary free from disease to make him appreciate bee-craft as one of the most remunerative of rural industries; affording a wholesome open-air life conducive to good health and yielding an abundance of contentment.

Diseases of Bees.—It is quite natural that bees living in colonies should be subject to diseases, and only since the introduction of movable-comb hives has it been possible to learn something about these ailments. The most serious disease with which the bee-keeper has to contend is that commonly known as "bee-pest" or "foul brood," so called because of the young brood dying and rotting in the cells. This disease has been known from the earliest ages, and is probably the same as that designated by Pliny as *blapsigonia* (*Natural History*, bk. xi. ch. xx.). Coming to later times, Della Rocca minutely describes a disease to which bees were subject in the island of Syra, between the years 1777 and 1780, and through which nearly every colony in the island perished. From the description given it was undoubtedly foul brood, and the bee-keepers of the island became convinced, after bitter experience, that it was extremely contagious. Schirach also mentioned and described the disease in 1760, and was the first to give it the name of "foul brood." Still later, in 1874, Dr Cohn, after the most exhaustive experiments and bacteriological research, realized that the disease was caused by a bacillus, and—nine years later—the name *Bacillus*

alvei was given to it by Cheyne and Cheshire, whose views were in agreement with those of Dr Cohn.

The illustration (fig. 27) shows a portion of comb affected with foul brood in its worst form. The sealed cells are dark-coloured and sunken, pierced with irregular holes, and the larvae in all stages from the crescent-shaped healthy condition to that in which the dead larvae are seen lying at the bottom of the cells, flaccid and shapeless. The remains then change to buff colour, afterwards turning brown, when decomposition sets in, and as the bacilli present in the dead larvae increase and the nutrient matter is consumed, the mass in some cases becomes sticky and ropy in character, making its removal impossible by the bees. In course of time it dries up, leaving nothing but a brown scale adhering to the bottom or side of the cell. In the worst cases the larvae even die after the cells are sealed over; a strong characteristic and offensive odour being developed in some phases of the disease, noticeable at times some distance away from the hive.

Two forms of foul brood have been long known, one foul smelling, the other odourless; and investigations made during 1906 and 1907 showed that the etiology of the disease is not by

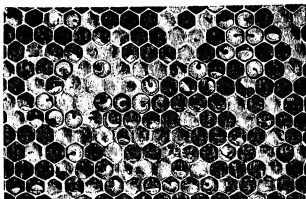

FIG. 27.—Foul Brood (*Bacillus alvei*).

(From Cheshire's *Bees and Bee-keeping, Scientific and Practical*.)

any means simple, but that it is produced by different microbes, two others in addition to *Bacillus alvei* playing an important part. These are *Bacillus brandenburgiensis*, Maassen (syn. *B. burri*, Burri; *B. larvae*, white), and *Streptococcus apis*, Maassen (syn. *B. Guntheri*, Burri). The first two are found in both forms of foul brood, whereas the last is only present with *B. alvei* in the strong-smelling form of the disease, in which the larvae are attacked prior to the cells being sealed over.

The brood of bees, when healthy, lies in the combs in compact masses, the larvae being plump and of a pearly whiteness, and when quite young curled up on their sides at the base of the cells. When attacked by the disease, the larva moves uneasily, stretches itself out lengthwise in the cell, and finally becomes loose and flabby, an appearance which plainly indicates death.

When the disease attacks the larvae before they are sealed over *Bacillus alvei* is present, usually associated with *Streptococcus apis*, which latter imparts a sour smell to the dead brood. In cases where the disease is odourless the larvae are attacked after the cells are sealed over, and just before they change to pupae, when they become slimy, sputum-like masses, difficult to remove from the cells. Under these conditions *Bacillus brandenburgiensis* is found, although *Bacillus alvei* may also be present. The two bacilli are antagonistic, each striving for supremacy, first one then the other predominating. Various other microbes are also present in large numbers, but are not believed to be pathogenic or disease-producing in character.

It is, therefore, seen that at least three different microbes play an important part in the same disease. The danger of contagion lies in the wonderful vitality of the spores, and their great resistance to heat and cold. Dr Maassen records a case where he had no difficulty in obtaining cultures from spores removed from combs after being kept dry for twenty years. It should be

borne in mind that the disease is much easier to cure in the earlier stages while the bacilli are still rod-shaped than when the rods have turned to spores.

Since the bacterial origin of foul brood has been established, the efforts of some bacteriologists have been employed in finding a simple remedy by means of which the disease may be checked in its earliest stages, and in this an appreciable amount of success has been attained. Nor has foul brood in its more advanced forms been neglected, all directions for treatment being found in text-books written by distinguished writers on apiculture in the United Kingdom, America and throughout the European continent.

The only other disease to which reference need be made here is dysentery, which sometimes breaks out after the long confinement bees are compelled to undergo during severe winters. This trouble may be guarded against by feeding the bees in the early autumn with good food made from cane sugar, and housing them in well-ventilated hives kept warm and dry by suitable coverings. When bees are wintered on thin, watery food not sealed over, and are unable for months to take cleansing flights, they become weak and involuntarily discharge their excrement over the combs and hive, a state of things never seen in a healthy colony under normal conditions. The stocks of bee-keepers who attend to the instructions given in text-books are rarely visited by this disease.

The above embraces all that is necessary to be said in relation to diseases, though bees have been subject to other ailments such as paralysis, constipation, &c.

In the Isle of Wight a serious epidemic broke out in 1906 which caused great destruction to bee-life in the following year. The malady was of an obscure character, but its cause has been under investigation by the British Board of Agriculture and Fisheries, and by European bacteriologists in 1908.

AUTHORITIES.—Though in modern times a great deal has appeared in the daily newspapers on the subject, it is a notable fact that not a tithe of the wonderful things published in such articles about bees and bee-keeping is worthy of credence or possesses any real value. Indeed, a pressman possessing any technical knowledge of the subject—beyond that obtainable from books—would be a *rara avis*; and the account given above is the result of forty years' practical experience with bees in England, the writer having for a great portion of the time been connected editorially with the only two papers in that country entirely devoted to bees and bee-keeping, *The British Bee Journal* (weekly, founded 1873), and *Bee-keepers' Record* (monthly, founded 1882), the former being the only weekly journal in the world. The following books on the subject may be consulted for further details:—François Huber, *New Observations on the Natural History of Bees*; T. W. Cowan, *British Bee-keepers' Guide-Book*; *The Honey Bee, its Natural History, Anatomy and Physiology*; *Langstroth on the Honey Bee*, revised by C. Daugant & Son; A. J. Root, *A B C and X Y Z of Bee-culture*; F. R. Cheshire, *Bees and Bee-keeping*; Dr Dzierzon, *Rational Bee-keeping*; E. Bertrand, *Condite du rucher*; A. J. Cook, *Manual of the Apiary*; Dr C. C. Miller, *Forty Years among the Bees*; F. W. L. Sladen, *Queen-rearing in England*; S. Simmins, *A Modern Bee Farm*.

(W. B. C.)

BEECH, a well-known tree, *Fagus sylvatica*, a member of the order Fagaceae to which belong the sweet-chestnut (*Castanea*) and oak. The name beech is from the Anglo-Saxon *beo*, *bece* or *beoce* (Ger. *Buche*, Swedish, *bök*), words meaning at once a book and a beech-tree. The connexion of the beech with the graphic arts is supposed to have originated in the fact that the ancient Runic tablets were formed of thin boards of beech-wood. "The origin of the word," says Prior (*Popular Names of British Plants*), "is identical with that of the Sanskrit *bōka*, letter, *bōkōs*, writings; and this correspondence of the Indian and our own is interesting as evidence of two things, viz. that the Brahmins had the art of writing before they detached themselves from the common stock of the Indo-European race in West Asia, and that we and other Germans have received alphabetic signs from the East by a northern route and not by the Mediterranean." Beech-mast, the fruit of the beech-tree, was formerly known in England as buck; and the county of Buckingham is so named from its being a beech-growing country. Buckwheat (*Buckweizen*) derives its name from the similarity of its angular seeds to beech-mast. The generic name *Fagus* is derived from *φάγειν*, to eat; but the

φάγος of Theophrastus was probably the sweet chestnut (*Aesculus*) of the Romans. Beech-mast has been used as food in times of distress and famine; and in autumn it yields an abundant supply of food to park-deer and other game, and to pigs, which are turned into beech-woods in order to utilize the fallen mast. In France it is used for feeding pheasants and domestic poultry. Well-ripened beech-mast yields from 17 to 20 % of non-drying oil, suitable for illumination, and said to be used in some parts of France and other European countries in cooking, and as a substitute for butter.

The beech is one of the largest British trees, particularly on chalky or sandy soils, native in England from Yorkshire southwards, and planted in Scotland and Ireland. It is one of the common forest trees of temperate Europe, spreading from southern Norway and Sweden to the Mediterranean. It is found on the Swiss Alps to about 5000 ft. above sea-level, and in southern Europe is usually confined to high mountain slopes; it is plentiful in southern Russia, and is widely distributed in Asia Minor and the northern provinces of Persia.

It is characterized by its sturdy pillar-like stem, often from 15 to 20 ft. in girth, and smooth olive-grey bark. The main branches rise vertically, while the subsidiary branches spread outwards and give the whole tree a rounded outline. The slender brown pointed buds give place in April to clear green leaves fringed with delicate silky hairs. The flowers which appear in May are inconspicuous and, as usual with our forest trees, of two kinds; the male, in long-stalked globular clusters, hang from the axils of the lower leaves of a shoot, while the female, each of two or three flowers in a tiny cup (cupule of bracts), stand erect nearer the top of the shoot. In the ripe fruit or mast the four-sided cupule, which has become much enlarged, brown and tough, encloses two or three three-sided rich chestnut-brown fruits, each containing a single seed. It is readily propagated by its seeds. It is a handsome tree in every stage of its growth, but is more injurious to plants under its drip than other trees, so that shade-bearing trees, such as holly, yew and thuja, suffer. Its leaves, however, enrich the soil. The beech has a remarkable power of holding the ground where the soil is congenial, and the deep shade prevents the growth of other trees. It is often and most usefully mixed with oak and Scotch fir. The timber is not remarkable for either strength or durability. It was formerly much used in mill-work and turnery; but its principal use at present is in the manufacture of chairs, bedsteads and a variety of minor articles. It makes excellent fuel and charcoal. The copper-beech is a variety with copper-coloured leaves, due to the presence of a red colouring-matter in the sap. There is also a weeping or pendulous-branched variety; and several varieties with more or less cut leaves, are known in cultivation.

The genus *Fagus* is widely spread in temperate regions, and contains in addition to our native beech, about 15 other species. A variety (*F. sylvatica* var. *Sieboldii*) is a native of Japan, where it is one of the finest and most abundant of the deciduous-leaved forest trees. *Fagus americana* is one of the most beautiful and widely-distributed trees of the forests of eastern North America. It was confounded by early European travellers with *F. sylvatica*, from which it is distinguished by its paler bark and lighter green, more sharply-toothed leaves. Several species are found in Australia and New Zealand, and in the forests of southern Chile and Patagonia. The dense forests which cover the shore of the Straits of Magellan and the mountain-slopes of Tierra del Fuego consist largely of two beeches—one evergreen, *Fagus betuloides*, and one with deciduous leaves, *F. antarctica*.

BEECHER, CHARLES EMERSON (1856–1904), American palaeontologist, was born at Dunkirk, New York, on the 9th of October 1856. He graduated at the university of Michigan in 1878, and then became assistant to James Hall in the state museum at Albany. Ten years later he was appointed to the charge of the invertebrate fossils in the Peabody Museum, New Haven, under O. C. Marsh, whom he succeeded in 1899 as curator. Meanwhile in 1889 he received the degree of Ph.D. from Yale University for his memoir on the *Brachiospondylae*, a remarkable

group of Silurian sponges; later on he did good work among the fossil corals, and other groups, being ultimately regarded as a leading authority on fossil crustacea and brachiopoda; his researches on the development of the brachiopoda, and on the *Trilobites Triarthrus* and *Trinucleus*, were especially noteworthy. In 1802 he was appointed professor of palaeontology in Yale University. He died on the 14th of February 1904.

Memoir by C. Schuchert in *Amer. Journ. Science*, vol. xvii., June 1904 (with portrait and bibliography).

BEECHER, HENRY WARD (1813-1887), American preacher and reformer, was born in Litchfield, Connecticut, on the 24th of June 1813. He was the eighth child of Lyman and Roxana Foote Beecher, and brother of Harriet Beecher Stowe. Entering Amherst College in 1830, and graduating four years later, he gave more attention to his own courses of reading than to college studies, and was more popular with his fellows than with the faculty. With a patience foreign to his impulsive nature, he submitted to minute drill in elocution, and became a fluent extemporaneous speaker. Reared in a Puritan atmosphere, he has graphically described the mystical experience which, coming to him in his early youth, changed his whole conception of theology and determined his choice of the ministry. "I think," he says, "that when I stand in Zion and before God, the highest thing that I shall look back upon will be that blessed morning of May when it pleased God to reveal to my wondering soul the idea that it was His nature to love a man in his sins for the sake of helping him out of them." In 1837 he graduated from Lane Theological Seminary in Ohio, of which his father was president, and entered upon his work as pastor of a missionary Presbyterian church at Lawrenceburg, Indiana, a village on the Ohio, about 20 m. below Cincinnati. The membership numbered nineteen women and one man. Beecher was sexton as well as preacher. Two years later he accepted a call to Indianapolis. His unconventional preaching shocked the more staid members of the flock, but filled the church to overflowing with people unaccustomed to churchgoing. He studied men rather than books; became acquainted with the vices in what was then a pioneer town; and in his *Seven Lectures to Young Men* (1844) treated these with genuine power of realistic description and with youthful and exuberant rhetoric. Eight years later (1847) he accepted a call to the pastorate of Plymouth Church (Congregational), then newly organized in Brooklyn, New York. The situation of the church, within five minutes' walk of the chief ferry to New York, the stalwart character of the man who had organized it, and the peculiar eloquence of Beecher, combined to make the pulpit a national platform. The audience-room of the church, capable of seating 2000 or 2500 people, frequently contained 500 or 1000 more.

Beecher at once became a recognized leader. On the all-absorbing question of slavery he took a middle ground between the pro-slavery or peace party, and abolitionists like William Lloyd Garrison and Wendell Phillips, believing, with such statesmen as W. H. Seward, Salmon P. Chase, and Abraham Lincoln, that slavery was to be overthrown under the constitution and in the Union, by forbidding its growth and trusting to an awakened conscience, enforced by an enlightened self-interest. He was always an anti-slavery man, but never technically an abolitionist, and he joined the Republican party soon after its organization. In the earlier days of the agitation, he challenged the hostility which often mobbed the anti-slavery gatherings; in the later days he consulted with the political leaders, inspiring the patriotism of the North, and sedulously setting himself to create a public opinion which should confirm and ratify the emancipation proclamation whenever the president should issue it. When danger of foreign intervention cast its threatening shadow across the national path, he went to England, and by his famous addresses did what probably no other American could have done to strengthen the spirit in England favourable to the United States, and to convert that which was doubtful and hostile. In 1861-1863 he was the editor-in-chief of the *Independent*, then a Congregational journal; and in his editorials, copied far and wide, produced a profound impression on the

public mind by clarifying and defining the issue. Later (in 1870), he founded and became editor-in-chief of the *Christian Union*, afterwards the *Outlook*, a religious un denominational weekly. His lectures and addresses had the spirit if not the form of his sermons, just as his sermons were singularly free from the homiletical tone. Yet his work as a reformer was subsidiary to his work as a preacher. He was not indeed a parish pastor; he inspired church activities which grew to large proportions, but trusted the organization of them to laymen of organizing abilities in the church; and for acquaintance with his people he depended on such social occasions as were furnished in the free atmosphere of this essentially New England church at the close of every service. But during his pastorate the church grew to be probably the largest in membership in the United States.

It was in the pulpit that Beecher was seen at his best. His mastery of the English tongue, his dramatic power, his instinctive art of impersonation, which had become a second nature, his vivid imagination, his breadth of intellectual view, the catholicity of his sympathies, his passionate enthusiasm, which made for the moment his immediate theme seem to him the one theme of transcendent importance, his quaint humour alternating with genuine pathos, and above all his simple and singularly unaffected devotional nature, made him as a preacher without a peer in his own time and country. His favourite theme was love: love to man was to him the fulfilment of all law; love of God was the essence of all Christianity. Retaining to the day of his death the forms and phrases of the New England theology in which he had been reared, he poured into them a new meaning and gave to them a new significance. He probably did more than any other man in America to lead the Puritan churches from a faith which regarded God as a moral governor, the Bible as a book of laws, and religion as obedience to a conscience to a faith which regards God as a father, the Bible as a book of counsels, and religion as a life of liberty in love. The later years of his life were darkened by a scandal which Beecher's personal, political and theological enemies used for a time effectively to shadow a reputation previously above reproach, he being charged by Theodore Tilton, whom he had befriended, with having had improper relations with his (Tilton's) wife. But in the midst of these accusations (February 1876), the largest and most representative Congregational council ever held in the United States gave expression to a vote of confidence in him, which time has absolutely justified. Not a student of books nor a technical scholar in any department, Beecher's knowledge was as wide as his interests were varied. He was early familiar with the works of Matthew Arnold, Charles Darwin and Herbert Spencer; he preached his *Bible Studies* sermons in 1878, when the higher criticism was wholly unknown to most evangelical ministers or known only to be dreaded; and his sermons on *Evolution and Religion* in 1885, when many of the ministry were denouncing evolution as atheistic. He was stricken with apoplexy while still active in the ministry, and died at Brooklyn on the 8th of March 1887, in the seventy-fourth year of his age.

The principal books by Beecher, besides his published sermons, are: *Seven Lectures to Young Men* (1844); *Plymouth Collection of Hymns and Tunes* (1855); *Star Papers, Experiences of Art and Nature* (1855); *Life Thoughts* (1858); *New Star Papers; or Views and Experiences of Religious Subjects* (1859); *Plain and Pleasant Talks about Fruits, Flowers and Farming* (1859); *American Rebellion, Report of Speeches delivered in England at Public Meetings in Manchester, Glasgow, Edinburgh, Liverpool, and London* (1864); *Prayers from Plymouth Pulpit* (1867); *Norwood: A Tale of Village Life in New England* (1867); *The Life of Jesus the Christ* (1871), completed in 2 vols., by his sons (1891); and *Yale Lectures on Preaching* (3 vols., 1872-1874).

The principal lives are: Noyes L. Thompson, *The History of Plymouth Church* (1847-1872); Thomas W. Knox, *The Life and Work of Henry Ward Beecher* (Hartford, Conn., 1887); Frank S. Child, *The Boyhood of Henry Ward Beecher* (Pamphlet, New Creston, Conn., 1887); Joseph Howard, Jr., *Life of Henry Ward Beecher* (Philadelphia, 1887); T. W. Hanford, *Beecher: Christian Philosopher, Pulpit Orator, Patriot and Philanthropist* (Chicago, 1887); Lyman Abbott and S. B. Halliday, *Henry Ward Beecher: A Sketch of His Career* (New York, 1887); William C. Beecher, Rev. Samuel Scoville and Mrs H. W. Beecher, *A Biography of Henry Ward Beecher* (New York, 1888); John R. Howard, *Henry Ward Beecher:*

A Study (1891); John Henry Barrows, *Henry Ward Beecher* (New York, 1893); and Lyman Abbott, *Henry Ward Beecher* (Boston, 1903).

BEECHER, LYMAN (1775-1863), American clergyman, was born at New Haven, Connecticut, on the 12th of October 1775. He was a descendant of one of the founders of the New Haven colony, worked as a boy in an uncle's blacksmith shop and on his farm, and in 1797 graduated from Yale, having studied theology under Timothy Dwight. He preached in the Presbyterian church at East Hampton, Long Island (1798-1810, being ordained in 1799); in the Congregational church at Litchfield, Connecticut (1810-1826), in the Hanover Street church of Boston (1826-1832), and in the Second Presbyterian church of Cincinnati, Ohio (1833-1843); was president of the newly established Lane Theological Seminary at Walnut Hills, Cincinnati, and was professor of didactic and polemic theology there (1832-1850), being professor emeritus until his death. At Litchfield and in Boston he was a prominent opponent of the growing "heresy" of Unitarianism, though as early as 1836 he was accused of being a "moderate Calvinist" and was tried for heresy, but was acquitted. Upon his resignation from Lane Theological Seminary he lived in Boston for a short time, devoting himself to literature; but he broke down, and the last ten years of his life were spent at the home of his son, Henry Ward Beecher, in Brooklyn, New York, where he died on the 10th of January 1863. Magnetic in personality, incisive and powerful in manner of expression, he was in his prime one of the most eloquent of American pulpit orators. In 1806 he preached a widely circulated sermon on duelling, and about 1814 a series of six sermons on intemperance, which were reprinted frequently and greatly aided temperance reform. Thrice married, he had a large family, his seven sons becoming Congregational clergymen, and his daughters, Harriet Beecher Stowe (*q.v.*) and Catherine Esther Beecher, attaining literary distinction.

Lyman Beecher's published works include: *A Plea for the West* (1835), *Views in Theology* (1836), and various sermons; his *Collected Works* were published at Boston in 1852 in 3 vols. Consult his *Autobiography and Correspondence* (2 vols., New York, 1863-1864), edited by his son Charles; D. H. Allen, *Life and Services of Lyman Beecher* (Cincinnati, 1863); and James C. White, *Personal Reminiscences of Lyman Beecher* (New York, 1882).

His daughter, CATHERINE ESTHER (1800-1878), was born at East Hampton, Long Island, on the 6th of September 1800. She was educated at Litchfield Seminary, and from 1822 to 1832 conducted a school for girls at Hartford, Connecticut, with her sister Harriet's assistance, and from 1832 to 1834 conducted a similar school in Cincinnati. She wrote and lectured on women's education and in behalf of better primary schools, and radically opposed woman suffrage and college education for women, holding woman's sphere to be domestic. The National Board of Popular Education, a charitable society which she founded, sent hundreds of women as teachers into the South and West. She died on the 12th of May 1878 in Elmira, New York. She published *An Essay on Slavery and Abolition with Reference to the Duty of American Females* (1837), *A Treatise on Domestic Economy* (1842), *The True Remedy for the Wrongs of Women* (1851), *Letters to the People on Health and Happiness* (1855), *The Religious Training of Children* (1864), and *Woman's Profession as Mother and Educator* (1871).

His son, EDWARD BEECHER (1803-1895), was born at East Hampton, Long Island, on the 27th of August 1803, graduated at Yale in 1822, studied theology at Andover, and in 1826 became pastor of the Park Street church in Boston. From 1830 to 1844 he was president of Illinois College, Jacksonville, Illinois, and subsequently filled pastorates at the Salem Street church, Boston (1844-1855), and the Congregational church at Galesburg, Illinois (1855-1871). He was senior editor of the *Congregationalist* (1840-1855), and an associate editor of the *Christian Union* from 1870. In 1872 he settled in Brooklyn, New York, where in 1885-1889 he was pastor of the Parkville church and where he died on the 28th of July 1895. He wrote *Addresses on the Kingdom of God* (1827), *History of the Alton Riots* (1837), *Statement of Anti-Slavery Principles* (1837), *Baptism, its Import*

and Modes (1850), *The Conflict of Ages* (1853), *The Papal Conspiracy Exposed* (1855), *The Concord of Ages* (1860), and *History of Opinions on the Scriptural Doctrine of Future Retribution* (1878).

CHARLES BEECHER (1815-1900), another of Lyman's sons, was born at Litchfield, Connecticut, on the 7th of October 1815. He graduated at Bowdoin College in 1834, and subsequently held pastorates at Newark, New Jersey (1837-1857), and Georgetown, Massachusetts; and from 1870 to 1877 lived in Florida, where he was state superintendent of public instruction in 1871-1873. He died at Georgetown, Massachusetts, on the 21st of April 1900. He was an accomplished musician, and assisted in the selection and arrangement of music in the *Plymouth Collection of Hymns and Tunes*. He wrote *David and His Throne* (1855), *Pen Pictures of the Bible* (1855), *Redeemer and Redeemed* (1864), and *Spiritual Manifestations* (1870).

THOMAS KINNICUTT BEECHER (1824-1900), another son, born at Litchfield, Connecticut, on the 10th of February 1824, was pastor of the Independent Congregational church (now the Park church), at Elmira, New York, one of the first institutional churches in the country, from 1854 until his death at Elmira on the 14th of March 1900. He wrote *Our Seen Churches* (1870).

BEECHER, FREDERICK WILLIAM (1796-1856), English naval officer and geographer, son of Sir William Beecher, R.A., was born in London on the 17th of February 1796. In 1806 he entered the navy, and saw active service during the wars with France and America. In 1818 he served under Lieutenant (afterwards Sir) John Franklin in Buchan's Arctic expedition, of which at a later period he published a narrative; and in the following year he accompanied Lieutenant W. E. Parry in the "Hecla." In 1821 he took part in the survey of the Mediterranean coast of Africa under the direction of Captain, afterwards Admiral, William Henry Smyth. He and his brother Henry William Beecher, made an overland survey of this coast, and published a full account of their work in 1828 under the title of *Proceedings of the Expedition to Explore the Northern Coast of Africa from Tripoly Eastward in 1821-1822*. In 1825 Beecher was appointed to command the "Blossom," which was intended to explore Bering Strait, in concert with Franklin and Parry operating from the east. He passed the strait and penetrated as far as 71° 23' 31" N., and 156° 21' 30" W., reaching a point only 146 m. west of that reached by Franklin's expedition from the Mackenzie river. The whole voyage lasted more than three years; and in the course of it Beecher discovered several islands in the Pacific, and an excellent harbour near Cape Prince of Wales. In 1831 there appeared his *Narrative of a Voyage to the Pacific and Bering's Strait to Co-operate with the Polar Expeditions, 1825-1828*. In 1835 and the following year Captain Beecher was employed on the coast survey of South America, and from 1837 to 1847 carried on the same work along the Irish coasts. He was appointed in 1850 to preside over the Marine Department of the Board of Trade. In 1854 he was made rear-admiral, and in the following year was elected president of the Royal Geographical Society. He died on the 29th of November 1856.

BEECHER, SIR WILLIAM (1753-1839), English portrait-painter, was born at Burford. He was originally meant for a conveyancer, but a strong love for painting induced him to become a pupil at the Royal Academy in 1772. Some of his smaller portraits gained him considerable reputation; he began to be employed by the nobility, and in 1793 became associate of the Academy. In the same year he was made portrait-painter to Queen Charlotte. He painted the portraits of the members of the royal family, and of nearly all the most famous or fashionable persons of the time. What is considered his finest production is a review of cavalry, a large composition, in the foreground of which he introduced portraits of George III., the prince of Wales and the duke of York, surrounded by a brilliant staff on horseback. It was painted in 1798, and obtained for the artist the honour of knighthood, and his election as R.A.

BEECHING, HENRY CHARLES (1850-), English clergyman and author, was born on the 15th of May 1850, and educated at the City of London school and at Balliol College, Oxford. He took holy orders in 1882, and after three years in a Liverpool

curacy he was for fifteen years rector of Yattendon, Berkshire. From 1900 to 1903 he lectured on pastoral and liturgical theology at King's College, London, and was chaplain of Lincoln's Inn, where he became preacher in 1903. He became a canon of Westminster in 1902, and examining chaplain to the bishop of Carlisle in 1905. As a poet he is best known by his share in two volumes—*Love in Idleness* (1883) and *Love's Looking Glass* (1891)—which contained also poems by J. W. Mackail and J. Bowyer Nichols. He was a sympathetic editor and critic of the works of many 16th and 17th century poets, of Richard Crashaw (1905), of Herrick (1907), of John Milton (1909), of Henry Vaughan (1896). Under the pseudonym of "Urbanus Sylvan" he published two successful volumes of essays, *Pages from a Private Diary* (1898) and *Provincial Letters and other Papers* (1906). His works also include numerous volumes of sermons and essays on theological subjects.

BEECHWORTH, a town of Bogong county, Victoria, Australia, 172 m. by rail N.E. of Melbourne. Pop. (1901) 7359. The town is the centre of the Ovens goldfields, and the district is mainly devoted to mining with both alluvial and reef working, but much of the land is under cultivation, yielding grain and fruit. The water supply is derived from Lake Kerferd in the vicinity, which is a favourite resort of visitors; the scenery near the town, which lies at an elevation of 1805 ft. among the May Day Hills, being singularly beautiful. The industries of Beechworth include tanning, ironfounding and coach-building.

BEEF (through O. Fr. *boef*, mod. *boeuf*, from Lat. *bos*, *bovis*, ox, Gr. *βοῦς*, which show the ultimate connexion with the Sanskrit *go*, *gāus*, ox, and thus with "cow"), the flesh of the ox, cow or bull, as used for food. The use of the French word for the meat, while the Saxon name was retained for the animal, has been often noticed, and paralleled with the use of veal, mutton and pork. "Beef" is also used, especially in the plural "beeves," for the ox itself, but usually in an archaic way. "Corned" or "corn" beef is the flesh cured by salting, i.e. sprinkling with "corns" or granulated particles of salt. "Collared" beef is so called from the roll or collar into which the meat is pressed, after extracting the bones. "Jerked" beef, i.e. meat cut into long thin slices and dried in the sun, like "biltong" (q.v.), comes through the Spanish-American *charque*, from *charqui*, the Peruvian word for this species of preserved meat. For "Beef-eater" see YEOMEN OF THE GUARD.

BEEFSTEAK CLUB, the name of several clubs formed in London during the 18th and 19th centuries. The first seems to have been that founded in 1709 with Richard Estcourt, the actor, as steward. Of this the chief wits and great men of the nation were members and its badge was a gridiron. Its fame was, however, entirely eclipsed in 1735 when "The Sublime Society of Steaks" was established by John Rich at Covent Garden theatre, of which he was then manager. It is said that Lord Peterborough supping one night with Rich in his private room, was so delighted with the steak the latter grilled him that he suggested a repetition of the meal the next week. From this started the Club, the members of which delighted to call themselves "The Steaks." Among them were Hogarth, Garrick, Wilkes, Bubb Doddington and many other celebrities. The rendezvous was the theatre till the fire in 1808, when the club moved first to the Bedford Coffee House, and the next year to the Old Lyceum. In 1785 the prince of Wales joined, and later his brothers the dukes of Clarence and Sussex became members. On the burning of the Lyceum, "The Steaks" met again in the Bedford Coffee House till 1838, when the New Lyceum was opened, and a large room there was allotted the club. These meetings were held till the club ceased to exist in 1867. Thomas Sheridan founded a Beefsteak Club in Dublin at the Theatre Royal in 1749, and of this Peg Woffington was president. The modern Beefsteak Club was founded by J. L. Toole, the actor, in 1876.

See J. Timbs *Clubs and Club Life in London* (1873); Walter Arnold, *Life and Death of the Sublime Society of Steaks* (1871).

BEEZEBUB, **BEEZEBUL**, **BAALZEBUB**. In 2 Kings i. we read that Ahaziah ben Ahab, king of Israel, fell sick, and sent to inquire of Baalzebub, the god of the Philistine city Ekron,

whether he should recover. There is no other mention of this god in the Old Testament. *Baal*, "lord," is the ordinary title or word for a deity, especially a local deity, cf. such place names as Baal Hazor (2 Sam. xiii. 23), Baal Hermon (Judges iii. 3), which are probably contractions of fuller forms, like Beth Baal Meon (Josh. xiii. 17), the House or Temple of the Baal of Meon. According to these analogies we should expect *Zebub* to be a place. No place *Zebub*, however, is known; and it has been objected that the Baal of some other place would hardly be the god of Ekron. These objections are hardly conclusive.

Usually *Zebub* is identified with a Hebrew common noun *zebul*=flies,¹ occurring twice in the Old Testament,² so that Baalzebub "is the Baal to whom flies belong or are holy. As children of the summer they are symbols of the warmth of the sun, to which . . . Baal stands in close relation. Divination by means of flies was known at Babylon."³ There are other cases of names compounded of Baal and an element equivalent to a descriptive epithet, e.g. Baalgad, the Baal of Fortune.⁴ For the "Fly-god," sometimes interpreted as the "avertor of insects," cf. *Zeṓs ἀρούρος, μύιαρος*, and the Hercules *μύιαρος*. Clemens Alexander speaks of a Hercules *ἀρούρος* as worshipped at Rome. It has been suggested that Baalzebub was the dung-beetle, *Scarabæus pillularius*, worshipped in Egypt.

A name of a deity on an Assyrian inscription of the 12th century B.C. has been read as *Baal-zabubi*, but this reading has now been abandoned in favour of *Baal-sapnu* (Baal-Zephon).⁵ Cheyne considers that Baalzebub is a "contemptuous unepiphonic Jewish modification of the true name Baalzebul."⁶

In the New Testament we meet with Beelzebub,⁷ which some of the versions, especially the Vulgate and Syriac, followed by the Authorized Version, have changed to Beelzebub, under the influence of 2 Kings. In Matt. x. 25, Christ speaks of men calling the master of the house, i.e. Himself, Beelzebub.⁸ In Mark iii. 22-27,⁹ the scribes explain that Jesus is possessed by Beelzebub¹⁰ and is thus enabled to cast out devils. The passage speaks of Beelzebub as Satan and as the prince of the demons.

The origin of the name Beelzebub is variously explained. (a) It is "a phonetic corruption, perhaps a softening of the original word," as Bab-el-mandel is a corruption of Babel-mandeb. (b) *Zebul* is from *zebul*, a word found in the Targums in the sense of "dung," so that Beelzebub would mean "Lord of Dung," a term of contempt. The further suggestion has been made that *zebul* itself in the sense of "dung" is a term for a heathen deity, cf. the Old Testament use of "abomination" &c. for heathen deities, so that Beelzebub would mean "Chief of false gods," and so arch-fiend. (c) *Zebul* is found in 1 Kings viii. 13 in the sense of "height," *beth-zebul*—lofty house, and in Rabbinical writings in the sense of "house" or "temple," or "the fourth heaven,"¹¹ and Beelzebub may equal "Lord of the High House" or "Lord of Heaven." This view is perhaps favoured by Matt. x. 25, "if they have called the lord of the house Beelzebub." It appears, however, that Rabbinical writings use *yōm* (day-of) *zebul* for the festival of a heathen deity; and Jastrow connects this usage with the meaning "house" or "temple," so that the meaning "Lord of the False Gods" might be arrived at in a different way.

The names *Zebulun*, *Izebel* (Jezebel), suggest that *Zebul* may be an ancient name of a deity; cf. the names זְבֻל זְבֻל (B'L 'ZBL) זְבֻל (ShMZBL) in Punic and Phoenician

¹ So Clarendon Press, *Hebrew Lexicon*, p. 127, with LXX.

² Eccl. x. 1; Isaiah vii. 18.

³ Baethgen, *Beiträge zu semitischen Religionsgeschichte*, p. 25, cf. pp. 65, 261.

⁴ Josh. xii. 7.

⁵ Art. "Baalzebub," Black and Cheyne's *Ency. Bibl.*

⁶ With various spellings (e.g. Beelzebub, and in XB, Beezebub), all variants of Beelzebub. Cf. Deissmann, *Bible Studies*, 332.

⁷ There is a variation of reading, which has been held to support the view that the passage means that men reproached Jesus with His supposed connexion with Beelzebub; cf. A. B. Bruce, *in loco*.

⁸ And in the parallel passages, Matt. xii. 22-29; Luke xi. 14-22.

⁹ Cf. John vii. 20, viii. 48, 52, x. 20.

¹⁰ Swete, *in loco*.

¹¹ Jastrow, *Dict. of the Targumim*, &c., sub voce.

inscriptions.¹ The substitution of Beelzebub for Beelzebub by the Syriac, Vulgate and other versions implies the identification of the New Testament arch-fiend with the god of Ekron; this substitution, however, may be due to the influence of the Aramaic *B'el-debaba*, "adversary," sometimes held to be the original of these names.

There is no trace of Beelzebub or Beelzebub outside of the Biblical passages mentioned, and the literature dependent on them. If we assume a connexion between the two names, there is nothing to show how the god became in later times the devil.

In *Paradise Lost*, Book ii., Beelzebub appears as second only to Satan himself.

BIBLIOGRAPHY.—Lightfoot, *Horae Hebraicae et Talmudicae*, Works, vol. ii. pp. 188 f., 429, ed. Strype (1684); Baethgen, *Beiträge zur semitischen Religionsgeschichte*, pp. 25, 65, 261. Commentaries on the Biblical passages especially Burney and Skinner on *Kings*, Meyer and A. B. Bruce on the *Synoptic Gospels*, and Swete on *Mark*. Articles on "Baal," "Baalzebub," "Beelzebub," "Beelzebub," in Hastings' *Bible Dict.*, Black and Cheyne's *Encycl. Bibl.*, and Hauck's *Realencyklopädie*; on בְּלֵזְבוּב in Clarendon Press *Hebr. Lex.*; and on בְּלֵזְבוּב in Jastrow's *Dict. of the Targumim*, &c. (W. H. BE.)

BEER, a beverage obtained by a process of alcoholic fermentation mainly from cereals (chiefly malted barley), hops and water. The history of beer extends over several thousand years. According to Dr Bush, a beer made from malt or red barley is mentioned in Egyptian writings as early as the fourth dynasty.

It was called $\frac{R}{A}$ or *hega*. Papyri of the time of Seti I. (1300 B.C.) allude to a person inebriated from over-indulgence in beer. In the second book (c. 77) of Herodotus (450 B.C.) we are told that the Egyptians, being without vines, made wine from barley (cf. Aesch. *Suppl.* 954); but as the grape is mentioned so frequently in Scripture and elsewhere as being most abundant there, and no record exists of the vine being destroyed, we must conclude that the historian was only partially acquainted with the productions of that most fertile country. Pliny (*Natural History*, xxii. 82) informs us that the Egyptians made wine from corn, and gives it the name of *zithum*, which, in the Greek, means drink from barley. The Greeks obtained their knowledge of the art of preparing beer from the Egyptians. The writings of Archilochus, the Parian poet and satirist who flourished about 650 B.C., contain evidence that the Greeks of his day were acquainted with the process of brewing. There is, in fact, little doubt that the discovery of beer and its use as an exhilarating beverage were nearly as early as those of the grape itself, though both the Greeks and the Romans despised it as a barbarian drink. Dioscorides mentions two kinds of beer, namely $\xi\theta\eta\sigma$ and $\kappa\omega\beta\eta\mu$, but he does not describe them sufficiently to enable us to distinguish them. Sophocles and other Greek writers, again, styled it $\beta\epsilon\upsilon\beta\eta\omega\nu$. In the time of Tacitus (1st century after Christ), according to him, beer was the usual drink of the Germans, and there can be little doubt that the method of malting barley was then known to them. Pliny (*Nat. Hist.* xxii. 82) mentions the use of beer in Spain under the name of *celia* and *ceria* and in Gaul under that of *cerevisia*; and elsewhere (xiv. 29) he says:—"The natives who inhabit the west of Europe have a liquid with which they intoxicate themselves, made from corn and water. The manner of making this liquid is somewhat different in Gaul, Spain and other countries, and it is called by different names, but its nature and properties are everywhere the same. The people in Spain in particular brew this liquid so well that it will keep good a long time. So exquisite is the cunning of mankind in gratifying their vicious appetites that they have thus invented a method to make water itself produce intoxication."

The knowledge of the preparation of a fermented beverage from cereals in early times was not confined to Europe. Thus, according to Dr H. H. Mann, the Kaffir races of South Africa have made for ages—and still make—a kind of beer from millet, and

similarly the natives of Nubia, Abyssinia and other parts of Africa prepare an intoxicating beverage, generally called *bousa*, from a variety of cereal grains. The Russian *quass*, made from barley and rye, the Chinese *samschu*, made from rice, and the Japanese *saké* (*q.v.*) are all of ancient origin. Roman historians mention the fact that the Britons in the south of England at the time of the Roman invasion brewed a species of ale from barley and wheat. The Romans much improved the methods of brewing in vogue among the Britons, and the Saxons—among whom ale had long been a common beverage—in their turn profited much by the instruction given to the original inhabitants of Great Britain by the Romans. We are informed by William of Malmesbury that in the reign of Henry II. the English were greatly addicted to drinking, and by that time the monasteries were already famous, both in England and on the continent, for the excellence of their ales. The waters of Burton-on-Trent began to be famous in the 13th century. The secret of their being so especially adapted for brewing was first discovered by some monks, who held land in the adjacent neighbourhood of Wetmore. There is a document dated 1295 in which it is stated that Matilda, daughter of Nicholas de Shoben, had re-leased to the abbot and convent of Burton-on-Trent certain tenements within and without the town; for which re-lease they granted her, daily for life, two white loaves from the monastery, two gallons of conventual beer, and one penny, besides seven gallons of beer for the men. The abbots of Burton apparently made their own malt, for it was a common covenant in leases of mills belonging to the abbey that the malt of the lords of the manor, both spiritual and temporal, should be ground free of charge. Robert Plot, in his *Natural History of Staffordshire* (1686), refers to the peculiar properties of the Burton waters, from which, he says, "by an art well known in this country good ale is made, in the management of which they have a knack of fining it in three days to that degree that it shall not only be potable, but is clear and palatable as we could desire any drink of this kind to be." In 1630 Burton beer began to be known in London, being sold at "Ye Peacocke" in Gray's Inn Lane, and according to the *Spectator* was in great demand amongst the visitors in Vauxhall. Until tea and coffee were introduced, beer and ale (see ALE) were, practically speaking, the only popular beverages accessible to the general body of consumers. Since the advent of tea, coffee, cocoa and mineral waters, the character of British beers has undergone a gradual modification, the strongly alcoholic, heavily hopped liquids consumed by the previous generation slowly giving place to the lighter beverages in vogue at the present time. The old "stock bitter" has given way to the "light dinner ale," and "porter" (so called from the fact that it was the popular drink amongst the market porters of the 18th century) has been largely replaced by "mild ale." A certain quantity of strong beer—such as heavy stouts and "stock" and "Scotch" ales—is still brewed nowadays, but it is not an increasing one. The demand is almost entirely for medium beers such as mild ale, light stout, and the better class of "bitter" beers, and light beers such as the light "family ales," "dinner ales" and lager.

The general run of beers contain from 3 to 6% of alcohol and 4 to 7% of solids, the remainder being water and certain flavouring and preservative matters derived from the malt, hops and other materials employed in their manufacture. The solid, *i.e.* non-volatile, matter contained in solution in beer consists mainly of maltose or malt sugar, of several varieties of dextrin (see BREWING), of substances which stand in an intermediate position between the sugars and the dextrins proper, and of a number of bodies containing nitrogen, such as the non-coagulable proteids, peptones, &c. In addition there is an appreciable quantity of mineral matter, chiefly phosphates and potash. Dietetically regarded, therefore, beer possesses considerable food value, and, moreover, the nutritious matter in beer is present in a readily assimilable form.

It is probable that the average adult member of the British working classes consumes not less than two pints of beer daily. A reasonable calculation places the total proteids and carbohydrates consumed by the average worker at 140 and 400

¹ Lidzbarski, *Handbuch der nordsemitischen Epigraphik*, i. pp. 240, 377.

grammes respectively. Taking the proteid content of the average beer at 0.4% and the carbohydrate content at 4%, a simple calculation shows that about 3% of the total proteid and 11% of the total carbohydrate food of the average worker will be consumed in the shape of beer.

The chemical composition of beers of different types will be gathered from the following tables.

A. ENGLISH BEERS.

(Analyses by J. L. Baker, Hulton & P. Schidrowitz.)

I. Mild Ales.

Number.	Original Gravity.	Alcohol %.	Extractives(Solids)%.
1. ¹	1055-13	4.17	6.1
2. ¹	1055-64	4.47	5.7
3. ²	1071-78	5.57	7.3

II. Light Bitters and Ales.

Number.	Original Gravity.	Alcohol %.	Extractives(Solids)%.
1.	1046-81	4.15	4.0
2.	1047-69	4.23	4.1
3.	1047-79	4.61	3.2
4.	1050-30	4.53	4.2
5.	1038-31	3.81	3.5

III. Pale and Stock Ales.

Number.	Original Gravity.	Alcohol %.	Extractives(Solids)%.
1. ³	1059-01	4.77	5.8
2. ⁴	1068-58	5.48	7.1
3. ⁴	1076-80	6.68	5.9

IV. Stouts and Porter.

Number.	Original Gravity.	Alcohol %.	Extractives(Solids)%.
1. ⁵	1072-92	6.14	6.3
2. ⁴	1054-26	4.73	4.5
3. ⁴	1081-62	6.02	8.8
4. ⁷	1054-11	3.90	6.5

The figures in the above tables are very fairly representative of different classes of British and Irish beers. It will be noticed that the *Mild Ales* are of medium original gravity⁸ and alcoholic strength, but contain a relatively large proportion of solid matter. The *Light Bitters and Ales* are of a low original gravity, but compared with the *Mild Ales* the proportion of alcohol to solids is higher. The *Pale and Stock Ales*, which represent the more expensive bottle beers, are analytically of much the same character as the *Light Bitters*, except that the figures all round are much higher. The *Stouts*, as a rule, are characterized by a high gravity, and contain relatively more solids (as compared with alcohol) than do the heavy beers of light colour. With

¹ London Ales.² Strong Burton Mild Ale.³ Fairly representative of "Pale Ales."⁴ Heavy Stock Ales.⁵ Irish Stout.⁶ Nos. 2 and 3 are respectively "single" and "double" London Stouts from the same brewery.⁷ London Porter of Cooper.

⁸ The specific gravity, or "gravity" as it is always termed in the industry, of the brewer is 1000 times the specific gravity of the physicist. This is purely a matter of convention and convenience. Thus when a brewer speaks of a wort of a "gravity" of 1045 (ten-forty-five) he means a wort having a specific gravity of 1.045. Each unit in the brewer's scale of specific gravity is termed a "degree of gravity." The wort referred to above, therefore, possesses forty-five degrees of gravity. The "original gravity," it may here be mentioned, represents the specific gravity of the wort (see BREWING) before fermentation. The solids in the original wort may be ascertained by dividing the excess of the gravity over 1000 by 3.86. Thus in the case of Mild Ale No. 1 the excess of the original gravity over 1000 is 1055.13 - 1000 = 55.13. Dividing this by 3.86 we get 14.28, which indicates that the wort from which the beer was manufactured contained 14.28% of solids. In the trade the gravity of a beer (or rather of the wort from which it is derived) is generally expressed in pounds per barrel. This means the excess in weight of a barrel of the wort over the weight of a barrel of water. The weight of a barrel (36 gallons) of water is 360 lb; in the above example the weight of a barrel of the beer wort is 360 × 1.05513 = 379.8 lb. The gravity of the wort in lb is therefore 379.8 - 360 = 19.8 lb. The beer which is made from this wort would also be called a 19.8 lb beer, the reference in all cases being to the original wort.

regard to the proportions of the various matters constituting the extractives (solids) in English beers, roughly 20-30% consists of maltose and 20-50% of dextrinous matter. In mild ales the proportion of maltose to dextrin is high (roughly 1:1), thus accounting for the full sweet taste of these beers. Pale and stock ales, on the other hand, which are of a "dry" character, contain relatively more dextrin, the general ratio being about 1:1½ or 1:2. The mineral matter ("ash") of beers is generally in the neighbourhood of 0.2 to 0.3%, of which about one-fourth is phosphoric acid. The proteid ("nitrogenous matters") content of beers varies very widely according to character and strength, the usual limits being 0.3 to 0.8%, with an average of roughly 0.4%.

B. CONTINENTAL BEERS.

(Analyses by A. Doemens.)

Description.	Original Gravity.	Alcohol %.	Extractives (Solids) %.
Munich Draught Dark	1056.4	3.76	6.58
" " "	1052.6	3.38	6.45
" " Light	1048.0	3.18	5.55
" " "	1048.1	4.05	3.92
" Export "	1054.3	3.68	6.32
" " "	1059.5	4.15	7.48
" Bock Beer "	1076.6	4.53	10.05
Pilsener Bottle	1047.7	3.47	4.90
" Draught	1044.3	3.25	4.58
Berlin Dark	1055.2	3.82	6.17
" Light	1050.5	4.36	5.46
" Weissbier	1033.1	2.64	3.01

It will be seen that, broadly speaking, the original gravity of German and Austrian beers is lower than that of English beers, and this also applies to the alcohol. On the other hand, the foreign beers are relatively very rich in solids, and the extractives: alcohol ratio is high. (See BREWING.)

C. AMERICAN BEERS AND ALES.

(Analyses by M. Wallerstein.)

Description.	Original Gravity.	Alcohol %.	Extractives (Solids) %.	
Bottom Fermentation Beers (Lager Type).	1.	1046.7	3.48	5.08
	2.	1055.6	3.56	6.50
	3.	1063.4	4.12	7.43
	4.	1046.0	2.68	5.96
	5.	1051.7	3.42	5.86
Top Fermentation Ales (British Type).	1.	1084.2	5.89	8.60
	2.	1073.5	6.46	6.69
	3.	1068.0	5.50	5.53

It will be noted that the American beers (i.e. bottom fermentation products of the lager type) are very similar in composition to the German beers, but that the ales are very much heavier than the general run of the corresponding British products.

Production and Consumption.—(For manufacture of beer, see BREWING.) Germany is the greatest beer-producing nation, if liquid bulk be taken as a criterion; the United States comes next, and the United Kingdom occupies the third place in this regard. The consumption per head, however, is slightly greater in the United Kingdom than in Germany, and very much greater than is the case in the United States. The 1905 figures with regard to the total production and consumption of the three great beer-producing countries, together with those for 1885, are as under:—

Country.	Total Production (Gallons).		Consumption per Head of Population (Gallons).	
	1905.	1885.	1905.	1885.
German Empire.	1,538,240,000	932,228,000	26.3	19.8
United States	1,434,114,180	494,854,000	19.9	8.8
United Kingdom	1,227,933,468 ⁹	993,759,000	27.9 ¹⁰	27.1

⁹ A particularly heavy beer, only brewed at certain times in the year.¹⁰ The maxima of production and consumption were reached in 1899/1900, when the production amounted to 1,337,509,116 gallons (at the standard gravity) and consumption to 32.28 gallons per head.

The chief point of interest in the preceding table is the enormous increase in the United States. In considering the figures, the character of the beer produced must be taken into consideration. Thus, although Germany produces roughly 25 % more beer in liquid measurement than the United Kingdom, the latter actually uses about 50 % more malt than is the case in the German breweries. According to a Viennese technical journal, the quantities of malt employed for the production of one hectolitre (22 gallons) of beer in the respective countries is 0.40 cwt. in the German empire, 0.72 cwt. in the United States, and 0.81 cwt. in the United Kingdom. In a sense, therefore, England may still claim pre-eminence as a beer-producing nation. Large as the *per capita* consumption in the United Kingdom may seem, it is considerably less than is the case in Bavaria, which stands at the head of the list with over 50 gallons, and in Belgium, which comes second with 47.7 gallons. In the city of Munich the consumption is actually over 70 gallons, that is to say, about 1½ pints a day for every man, woman and child. It is curious to note that in *Germany*, which is usually regarded as a beer-drinking country *par excellence*, the consumption per head of this article is slightly less than in England, and that inversely the average German consumes more alcohol in the shape of spirits than does the inhabitant of the British Islands (consumption of spirits per head: Germany, 1.76 gallons; United Kingdom, 0.99 gallons). This is accounted for by the fact that the peasantry of the northern and eastern portions of the German empire consume spirits almost exclusively. In the British colonies beer is generally one of the staple drinks, but if we except Western Australia, where about 25 gallons per head of population are consumed, the demand is much smaller than in the United Kingdom. In Australia generally, the *per capita* consumption amounts to about 12 gallons, in New Zealand to 10 gallons, and in Canada to 5 gallons. (P. S.)

BEERSHEBA, a place midway between Gaza and Hebron (28 m. from each), frequently referred to in the Bible as the southern limit of Palestine ("Dan to Beersheba," Judg. xx. 1, &c.) Its foundation is variously ascribed to Abraham and Isaac, and different etymologies for its name are suggested, in the fundamental documents of Genesis (xxi. 22, xxvi. 26). It was an important holy place, where Abraham planted a sacred tree (Gen. xxi. 23), and where divine manifestations were vouchsafed to Hagar (Gen. xxi. 17), Isaac (xxvi. 24), Jacob (xlvii. 2) and Elijah (1 Kings xix. 5). Amos mentions it in connexion with the shrines of Bethel and Gilgal (Amos v. 5) and denounces oaths by its *numen* (viii. 14). The most probable meaning of the name is "seven wells," despite the non-Semitic construction involved in this interpretation. Seven ancient wells still exist here, though two are stopped up. Eusebius and Jerome mention the place in the 4th century as a large village and the seat of a Roman garrison. Extensive remains of this village exist, though they are being rapidly quarried away for building; some inscriptions of great importance have been found here. Later it appears to have been the site of a bishopric; remains of its churches were still standing in the 14th century. Some fine mosaics have been here unearthed and immediately destroyed, in sheer wantonness, by the natives quarrying building-stone. The Biblical Beersheba probably exists at Bir es-Seba', 2 m. distant.

BEESLY, EDWARD SPENCER (1831—), English historian and positivist, son of the Rev. James Beesly, was born at Feckenham, Worcestershire, on the 23rd of January 1831. He was educated at Wadham College, Oxford, which may be regarded as the original centre of the English positivist movement. Richard Congreve (*q.v.*) was tutor at Wadham from 1840 to 1854, and three men of that time, Frederic Harrison (*q.v.*), Beesly and John Henry Bridges (1832—1906), became the leaders of Contism in England. Beesly left Oxford in 1854 to become assistant-master at Marlborough College. In 1859 he was appointed professor of history at University College, London, and of Latin at Bedford College, London, in 1860. He resigned these appointments in 1863 and 1880, and in 1863 became the editor of the newly-established *Positivist Review*. He collaborated in the translation of Comte's system of *Positive Polity* (4 vols., 1875—

1870), translated his *Discourse on the Positive Spirit* (1903), and wrote a biography of Comte for a translation of the first two chapters of his *Cours de philosophie positive*, entitled *Fundamental Principles of Positive Philosophy* (1905). Professor Beesly stood unsuccessfully as Liberal candidate for Westminster in 1885 and for Marylebone in 1886, and is the author of numerous review articles on social and political topics, treated from the positivist standpoint, especially on the Irish question. His works also include a series of lectures on Roman history, entitled *Catiline, Clodius, Tiberius* (1878), in which he rehabilitates in some degree the character of each of his subjects, and *Queen Elizabeth* (1892), in the "Twelve English Statesmen" series.

BEET, a cultivated form of the plant *Beta vulgaris* (natural order Chenopodiaceae), which grows wild on the coasts of Europe, North Africa and Asia as far as India. It is a biennial, producing, like the carrot, a thick, fleshy tap-root during the first year and a branched, leafy, flowering stem in the following season. The small, green flowers are borne in clusters. A considerable number of varieties are cultivated for use on account of their large fleshy roots, under the names of mangel-wurzel or mangold, field-beet and garden-beet. The cultivation of beet in relation to the production of sugar, for which purpose certain varieties of beet stand next in importance to the sugar cane, is dealt with under SUGAR. The garden-beet has been cultivated from very remote times as a salad plant, and for general use as a table vegetable. The variety most generally grown has long, tapering, carrot-shaped roots, the "flesh" of which is of a uniform deep red colour throughout, and the leaves brownish red. It is boiled and cut into slices for being eaten cold; and it is also prepared as a pickle, as well as in various other forms. Beet is in much more common use on the continent of Europe as a culinary vegetable than in Great Britain, where it has, however, been cultivated for upwards of two centuries. The white beet, *Beta cicla*, is cultivated for the leaves, which are used as spinach. The midribs and stalks of the leaves are also stewed and eaten as sea-kale, under the name of Swiss chard. *B. cicla* is also largely used as a decorative plant for its large, handsome leaves, blood red or variegated in colour.

The beet prospers in a rich deep soil, well pulverized by the spade. If manure is required, it should be deposited at the bottom of the trench in preparing the ground. The seeds should be sown in drills 15 ins. asunder, in April or early in May, and the plants are afterwards to be thinned to about 8 in. apart in the lines, but not more, as moderate-sized roots are preferable. The plants should grow on till the end of October or later, when a portion should be taken up for use, and the rest laid in a sheltered corner, and covered up from frost. The roots must not be bruised and the leaves must be twisted off—not closely cut, as they are then liable to bleed. In the north the crop may be wholly taken up in autumn, and stored in a pit or cellar, beyond reach of frost. If it is desired to have fresh roots early, the seeds should be sown at the end of February or beginning of March; and if a succession is required, a few more may be sown by the end of March.

BEETHOVEN, LUDWIG VAN (1770—1827), German musical composer, was baptized (probably, as was usual, the day after birth) on the 17th of December 1770 at Bonn. His family is traceable to a village near Louvain, in Belgium, in the 17th century. In 1650 a lineal ancestor of the composer settled in Antwerp. Beethoven's grandfather, Louis, quarrelled with his family, came to Bonn in 1732, and became one of the court musicians of the archbishop-elect of Cologne. He was a genial man of estimable character, and though Ludwig van Beethoven was only four years old when his grandfather died, he never forgot him, but cherished his portrait to the end of his life. Beethoven's father, a tenor singer at the archbishop-elect's court, was of a rough and violent temper, not improved by his passion for drink, nor by the dire poverty under which the family laboured. He married Magdelena Leim or Laym, the widow of a *blut-de-chambre* of the elector of Trier and daughter of the chief cook at Ehrenbreitstein. Beethoven's father wished to profit as early as possible by his son's talent, and accordingly

began to give him a severe musical training, especially on the violin, when he was only five years old, at about which time they left the house in which he was born (515 Bonngasse, now preserved as a Beethoven museum, with a magnificent collection of manuscripts and relics). By the time Beethoven was nine his father had no more to teach him, and he entered upon a perhaps healthier course of clavier lessons under a singer named Pfeiffer. A little general education was also edged in by a certain Zambona. Van den Eeden, the court organist, and an old friend of his grandfather, taught him the organ and the pianoforte, and so rapid was Beethoven's progress that when C. G. Neefe succeeded to Van den Eeden's post in 1781, he was soon able to allow the boy to act as his deputy. With his permission Beethoven published in 1783 his earliest extant composition, a set of variations on a march by Dressler. The title-page states that they were written in 1780 "par un jeune amateur Louis van Beethoven âgé de dix ans." Beethoven's father was very clumsy in his unnecessary attempts to make an infant prodigy of his son; for the ante-dating of this composition, implying the correct date of birth, contradicts the post-dating of the date of birth by which he tried to make out that the three sonatas Beethoven wrote in the same year were by a boy of eleven. (Beethoven for a long time believed that he was born in 1772, and the certificate of his baptism hardly convinced him, because he knew that he had an elder brother named Ludwig who died in infancy.) In the same year, 1783, Beethoven was given the post of cembalist in the Bonn theatre, and in 1784 his position of assistant to Neefe became official. In a *catalogue raisonné* of the new archbishop Max Franz's court musicians we find "No. 14, Ludwig Beethoven" described "as of good capacity, still young, of good, quiet behaviour and poor," while his father (No. 8) "has a completely worn-out voice, has long been in service, is very poor, of fairly good behaviour, and married."

In the spring of 1787 Beethoven paid a short visit to Vienna, where he astonished Mozart by his extemporizations and had a few lessons from him. How he was enabled to afford this visit is not clear. After three months the illness of his mother, to whom he was devoted, brought him back. She died in July, leaving a baby girl, one year old, who died in November. For five more years Beethoven remained at Bonn supporting his family, of which he had been since the age of fifteen practically the head, as his father's bad habits steadily increased until in 1789 Ludwig was officially entrusted with his father's salary. He had already made several lifelong friends at Bonn, of whom the chief were Count Waldstein and Stephan Breuning; and his prospects brightened as the archbishop-elect, in imitation of his brother the emperor Joseph II., enlarged the scale of his artistic munificence. By 1792 the archbishop-elect's attention was thoroughly aroused to Beethoven's power, and he provided for Beethoven's second visit to Vienna. The introductions he and Count Waldstein gave to Beethoven, the prefix "van" in Beethoven's name (which looked well though it was not really a title of nobility), and above all the unequalled impressiveness of his playing and extemporization, quickly secured his footing with the exceptionally intelligent and musical aristocracy of Vienna, who to the end of his life treated him with genuine affection and respect, bearing with all the roughness of his manners and temper, not as with the eccentricities of a fashionable genius, but as with signs of the sufferings of a passionate and noble nature.

Beethoven's life, though outwardly uneventful, was one of the most pathetic of tragedies. His character has had the same fascination for his biographers as it had for his friends, and there is probably hardly any great man in history of whom more is known and of whom so much of what is known is interesting. Yet it is all too much a matter of detail and anecdote to admit of chronological summarizing here, and for the disentangling of its actual incidents we must refer the reader to Sir George Grove's long and graphic article, "Beethoven," in the *Dictionary of Music and Musicians*, and to the monumental biography of Thayer, who devoted his whole life to collecting materials. These two biographical works, read in the spirit in which their

authors conceived them, will reveal, beneath a mass of distressing, grotesque and sometimes sordid detail, a nobility of character and unswerving devotion to the highest moral ideas throughout every distress and temptation to which a passionate and totally unpractical temper and the growing shadow of a terrible misfortune could expose a man.

The man is surpassed only by his works, for in them he had that mastery which was denied to him in what he himself calls his attempt to "grapple with fate." Such of his difficulties as lay in his own character already showed themselves in his studies with Haydn. Haydn, who seems to have heard of him on his first visit to Vienna in 1787, passed through Bonn in July 1792, and was so much struck by Beethoven that it was very likely at his instigation that the archbishop sent Beethoven to Vienna to study under him. But Beethoven did not get on well with him, and found him perfunctory in correcting his exercises. Haydn appreciated neither his manners nor the audacity of his free compositions, and abandoned whatever intentions he may have had of taking Beethoven with him to England in 1794. Beethoven could do without sympathy, but a grounding in strict counterpoint he felt to be a dire necessity, so he continued his studies with Albrechtsberger, a mere grammarian who had the poorest opinion of him, but who could, at all events, be depended on to attend to his work. Almost every comment has been made upon the relations between Haydn and Beethoven, except the perfectly obvious one that Mozart died at the age of thirty-six, just at the time Beethoven came to Vienna, and that Haydn, as is perfectly well known, was profoundly shocked by the untimely loss of the greatest musician he had ever known. At such a time the undeniable clumsiness of Beethoven's efforts at academic exercises would combine with his general tactlessness to confirm Haydn in the belief that the sun had set for ever in the musical world, and would incline him to view with disfavour those bold features of style and form which the whole of his own artistic development should naturally have predisposed him to welcome. It is at least significant that those early works of Beethoven in which Mozart's influence is most evident, such as the Septet, aroused Haydn's open admiration, whereas he hardly approved of the compositions like the sonatas, *op. 2* (dedicated to him), in which his own influence is stronger. Neither he nor Beethoven was skilful in expressing himself except in music, and it is impossible to tell what Haydn meant, or what Beethoven thought he meant, in advising him not to publish the last and finest of the three trios, *op. 1*. But even if he did not mean that it was too daring for the public, it can hardly be expected that he never contrasted the meteoric career of Mozart, who after a miraculous boyhood had produced at the age of twenty-five some of the greatest music Haydn had ever seen, with the slow and painful development of his uncouth pupil, who at the same age had hardly a dozen presentable works to his credit. It is not clear that Haydn ever came to understand Beethoven, and many years passed before Beethoven realized the greatness of the master whose teaching had so disappointed him.

From the time Beethoven settled permanently in Vienna, which he was soon induced to do by the kindness of his aristocratic friends, the only noteworthy external features of his career are the productions of his compositions. In spite of the usual hostile criticism for obscurity, exaggeration and unpopularity, his reputation became world-wide and by degrees actually popular; nor did it ever decline, for as his later works became notorious for their extravagance and unintelligibility his earlier works became better understood. He was no man of business, but, in a thoroughly unpractical way, he was suspicious and exacting in money matters, which in his later years frequently turned up in his conversation as a grievance, and at times, especially during the depreciation of the Austrian currency between 1808 and 1815, were a real anxiety to him. Nevertheless, with a little more skill his external prosperity would have been great. He was always a personage of importance, as is testified by more than one amusing anecdote, like those of his walks with Goethe and his half-ironical comments on the hats which flew off more for him than for Goethe; and in 1815 it seemed as if the

summit of his fame was reached when his 7th symphony was performed, together with a hastily-written cantata, *Der glorreiche Augenblick* and the blazing piece of descriptive fireworks entitled *Wellingtons Sieg oder die Schlacht bei Vittoria*, once popular in England as the *Battle Symphony*. The occasion for this performance was the congress of Vienna; and the government placed the two halls of the Redouten-Saal at his disposal for two nights, while he himself was allowed to invite all the sovereigns of Europe. In the same year he received the freedom of the city, an honour much valued by him. After that time his immediate popularity, as far as new works were concerned, became less eminent, as that of his more easy-going contemporaries began to increase. Yet there was, not only in the emotional power of his earlier works, but also in the known cause of his increasing inability to appear in public, something that awakened the best popular sensibilities; and when his two greatest and most difficult works, the 9th symphony and parts of the *Missa Solemnis*, were produced at a memorable concert in 1824, the storm of applause was overwhelming, and the composer, who was on the platform in order to give the time to the conductor, had to be turned round by one of the singers in order to see it.

Signs of deafness had given him grave anxiety as early as 1798. For a long time he successfully concealed it from all but his most intimate friends, while he consulted physicians and quacks with eagerness; but neither quackery nor the best skill of his time availed him, and it has been pointed out that the root of the evil lay deeper than could have been supposed during his lifetime. Although his constitution was magnificently strong and his health was preserved by his passion for outdoor life, a post-mortem examination revealed a very complicated state of disorder, evidently dating almost from childhood (if not inherited) and aggravated by lack of care and good food. The touching document addressed to his brothers in 1802, and known as his "will," should be read in its entirety, as given by Thayer (iv. 4). No verbal quotation short of the whole will do justice to the overpowering outburst which runs almost in one long unpunctuated sentence through the whole tragedy of Beethoven's life, as he knew it then and foresaw it. He reproaches men for their injustice in thinking and calling him pugnacious, stubborn and misanthropical when they do not know that for six years he has suffered from an incurable condition, aggravated by incompetent doctors. He dwells upon his delight in human society, from which he has had so early to isolate himself, but the thought of which now fills him with dread as it makes him realize his loss, not only in music but in all finer interchange of ideas, and terrifies him lest the cause of his distress should appear. He declares that, when those near him had heard a flute or a singing shepherd while he heard nothing, he was only prevented from taking his life by the thought of his art, but it seemed impossible for him to leave the world until he had brought out all that he felt to be in his power. He requests that after his death his present doctor, if surviving, shall be asked to describe his illness and to append it to this document in order that at least then the world may be as far as possible reconciled with him. He leaves his brothers his property, such as it is, and in terms not less touching, if more conventional than the rest of the document, he declares that his experience shows that only virtue has preserved his life and his courage through all his misery.

And, indeed, his art and his courage rose far above any level attainable by those artists who are slaves to the "personal note," for his chief occupation at the time of this document was his 2nd symphony, the most brilliant and triumphant piece that had ever been written up to that time. On a smaller scale, in which mastery was the more easily attainable as experiment was more readily tested, Beethoven was sooner able to strike a tragic note, and hence the process of growth in his style is more readily traceable in the pianoforte works than in the larger compositions which naturally represent a series of crowning results. Only in his last period does the pianoforte cease to be Beethoven's normal means of expression. Accordingly, if in the discussion of Beethoven's works, with which we close this

article, we dwell rather more on the pianoforte sonatas than on his greater works, it is not only because they are more easily referred to by the general reader, but because they are actually a key to his intellectual development, such as is afforded neither by his life nor by the great works which are themselves the crowning mystery and wonder of musical art.

Deafness causes inconvenience in conversation long before it is noticeable in music, and in 1806 Beethoven could still conduct his opera *Fidelio* and be much annoyed at the inattention to his nuances; and his last appearance as a player was not until 1814, when he made a great impression with his B flat trio, *op. 97*. At the end of November 1822 an attempt to conduct proved disastrous. The touching incident in 1824 has been described, but up to the last Beethoven seems to have found or imagined that car-trumpets (of which a collection is now preserved at Bonn) were of use to him in playing to himself, though his friends were often pained when the pianoforte was badly out of tune, and were overcome when Beethoven in soft passages did not make the notes sound at all. The instrument sent him by Broadwood in 1817-1818 gave him great pleasure and he answered it with a characteristically cordial and quaint letter in the best of bad French. His fame in England was often a source of great comfort to him, especially in his last illness, when the London Philharmonic Society, for which the 9th symphony was written and a 10th symphony projected, sent him £100 in advance of the proceeds of a benefit concert which he had begged them to give, being in very straitened circumstances, as he would make no use of the money he had deposited in the bank for his nephew.

This nephew was the cause of most of his anxiety and distress in the last twelve years of his life. His brother, Kaspar Karl, had often given him trouble; for example, by obtaining and publishing some of Beethoven's early indiscretions, such as the trio-variations, *op. 44*, the sonatas, *op. 49*, and other trifles, of which the late *opus* number is thus explained. In 1815, after Beethoven had quarrelled with his oldest friend, Stephan Breuning, for warning him against trusting his brother in money matters, Kaspar died, leaving a widow of whom Beethoven strongly disapproved, and a son, nine years old, for the guardianship of whom Beethoven fought the widow through all the law courts. The boy turned out utterly unworthy of his uncle's persistent devotion, and gave him every cause for anxiety. He failed in all his examinations, including an attempt to learn some trade in the polytechnic school, whereupon he fell into the hands of the police for attempting suicide, and, after being expelled from Vienna, joined the army. Beethoven's utterly simple nature could neither educate nor understand a human being who was not possessed by the wish to do his best. His nature was passionately affectionate, and he had suffered all his life from the want of a natural outlet for it. He had often been deeply in love and made no secret of it; but Robert Browning had not a more intense dislike of "the artistic temperament" in morals, and though Beethoven's attachments were almost all hopelessly above him in rank, there is not one that was not honourable and respected by society as showing the truthfulness and self-control of a great man. Beethoven's orthodoxy in such matters has provoked the smiles of Philistines, especially when it showed itself in his objections to Mozart's *Don Giovanni*, and his grounds for selecting the subject of *Fidelio* for his own opera. The last thing that Philistines will ever understand is that genius is far too independent of convention to abuse it; and Beethoven's life, with all its mistakes, its grotesqueness and its pathos, is as far beyond the shafts of Philistine wit as his art.

At the beginning of 1827 Beethoven had projects for a 10th symphony, music to Goethe's *Faust*, and (under the stimulus of his newly acquired collection of Handel's works) any amount of choral music, compared to which all his previous compositions would have seemed but a prelude. But he was in bad health; his brother Johann, with whom he had been staying, had not allowed him a fire in his bedroom, and had sent him back to Vienna in an open chaise in vile weather; and the chill which resulted ended in a fatal illness. Within a week of his death

Beethoven was still full of his projects. Three days before the end he added a codicil to his will, and saw Schubert, whose music had aroused his keen interest, but was not able to speak to him, though he afterwards spoke of the Philharmonic Society and the English, almost his last words being "God bless them." On the 26th of March 1827, during a fierce thunderstorm, he died.

Beethoven's Music.—The division of Beethoven's work into three styles has become proverbial, and is based on obvious facts. The styles, however, are not rigidly separated, either in themselves or in chronology. Nor can the popular description of Beethoven's first manner as "Mozartesque" be accepted as doing justice to a style which differs more radically from Mozart's than Mozart's differs from Haydn's. The style of Beethoven's third period is no longer regarded as "showing an obscurity traceable to his deafness," but we have, perhaps, only recently outgrown the belief that his later treatment of form is revolutionary. The peculiar interest and difficulty in tracing Beethoven's artistic development is that the changes in the materials and range of his art were as great as those in the form, so that he appears in the light of a pioneer, while the art with which he started was nevertheless already a perfectly mature and highly organized thing. And he is perhaps unique among artists in this, that his power of constructing perfect works of art never deserted him while he revolutionized his means of expression. No doubt this is in a measure true of all the greatest artists, but it is seldom obvious. In mature art vital differences in works of similar form are generally more likely to be overlooked than to force themselves on the critic's attention. And when they become so great as to make a new epoch it is generally at the cost of a period of experiment too heterogeneous and insecure for works of art to attain great permanent value. But in Beethoven's case, as we have said, the process of development is so smooth that it is impossible to separate the periods clearly, although the ground covered is, as regards emotional range, at least as great as that between Bach and Mozart. No artist has ever left more authoritative documentary evidence as to the steps of his development than Beethoven. In boyhood he seems to have acquired the habit of noting down all his musical ideas exactly as they first struck him. It is easy to see why in later years he referred to this as a "bad habit," for it must often take longer to jot down a crude idea than to reject it; and by the time the habit was formed Beethoven's powers of self-criticism were unparalleled, and he must often have felt hampered by the habit of writing down what he knew to be too crude to be even an aid to memory. Such first intuitions, if not written down, would no doubt be forgotten; but the poetic mood, the *Stimmung*, they attempt to indicate, would remain until a better expression was forthcoming. Beethoven had acquired the habit of recording them, and thereby he has, perhaps, misled some critics into over-emphasizing the contrast between his "tentative" self-critical methods and the quasi-impromptu outpourings of Mozart. This contrast is probably not very radical; indeed, we may doubt whether in every thoughtful mind any apparently sudden inspiration is not preceded by some anticipatory mood in which the idea was sought and its first faint indications tested and rejected so instantaneously as to leave no impression on the memory.

The number and triviality of Beethoven's preliminary sketches should not, then, be taken as evidence of a timid or vacillating spirit. But if we regard his sketches as his diary their significance becomes inestimable. They cover every period of Beethoven's career, and represent every stage of nearly all his important works, as well as of innumerable trifles, including ideas that did not survive to be worked out. And the type of self-criticism is the same from beginning to end. There is no tendency in the middle or last period, any more than in the first, to "subordinate form to expression," nor do the sketches of the first period show any lack of attention to elements that seem more characteristic of the third. The difference between Beethoven's three styles appears first in its full proportions when we realize this complete continuity of his method and art. We have ventured to cast doubts upon the Mozartesque character of his early

style, because that is chiefly a question of perspective. While he was handling a range of ideas not, in a modern view, glaringly different from Mozart's, he had no reason to use a glaringly different language. His contemporaries, however, found it more difficult to see the resemblance; and, though their criticism was often violently hostile, they saw with prejudice a daring originality which we may as well learn to appreciate with study. Beethoven himself in later years partly affected and partly felt a lack of sympathy with his own early style. But he had other things to do than to criticize it. Modern prejudice has not his excuse, and the neglect of Beethoven's early works is no less than the neglect of the key to the understanding of his later. It is also the neglect of a mass of mature art that already places Beethoven on the same plane as Mozart, and contains perhaps the only traces in all his work of a real struggle between the forces of progress and those of construction. We will therefore give special attention to this subject here.

The truth is that there are several styles in Beethoven's first period, in the centre of which, "proving all things," is the true and mature Beethoven, however wider may be the scope of his later maturity. And he did not, as is often alleged, fail to show early promise. The pianoforte quartets he wrote at the age of fifteen are, no doubt, clumsy and childish in execution to a degree that contrasts remarkably with the works of Mozart's, Mendelssohn's or Schubert's boyhood; yet they contain material actually used in the sonatas, *op. 2*, No. 1, and *op. 2*, No. 3. And the passage in *op. 2*, No. 3, is that immediately after the first subject, where, as Beethoven then states it, it embodies one of his most epoch-making discoveries, namely, the art of organizing a long series of apparently free modulations by means of a systematic progression in the bass. In the childish quartet the principle is only dimly felt, but it is nevertheless there as a subconscious source of inspiration; and it afterwards gives inevitable dramatic truth to such passages as the climax of the development in the sonata, *op. 57* (commonly called *Appassionata*), and throughout the chaos of the mysterious introduction to the C major string-quartet, *op. 59*, No. 3, prepares us for the world of loveliness that arises from it.

Although with Beethoven the desire to express new thoughts was thus invariably both stimulated and satisfied by the discovery of the necessary new means of expression, he felt deeply the danger of spoiling great ideas by inadequate execution; and his first work in a new form or medium is, even if as late as the Mass in C, *op. 80*, almost always unambitious. His teachers had found him sceptical of authority, and never convinced of the practical convenience of a rule until he had too successfully courted disaster. But he appreciated the experience, though he may have found it expensive, and traces of crudeness in such early works as he did not disown are as rare as plagiarisms. The first three pianoforte sonatas, *op. 2*, show the different elements in Beethoven's early style as clearly as possible. Sir Hubert Parry has aptly compared the opening of the sonata, *op. 2*, No. 1, with that of the finale of Mozart's G minor symphony, to show how much closer Beethoven's texture is. The slow movement well illustrates the rare cases in which Beethoven imitates Mozart to the detriment of his own proper richness of tone and thought, while the finale in its central episode brings a misapplied and somewhat diffuse structure in Mozart's style into direct conflict with themes as "Beethovenish" in their terseness as in their sombre passion. The second sonata is flawless in execution, and entirely beyond the range of Haydn and Mozart in harmonic and dramatic thought, except in the finale. And it is just in the adoption of the luxurious Mozartesque rondo form as the crown of this work that Beethoven shows his true independence. He adopts the form, not because it is Mozart's, but because it is right and because he can master it. The opening of the second subject in the first movement is a wonderful application of the harmonic principle already mentioned in connexion with the early piano quartets. In all music nothing equally dramatic can be found before the D minor sonata, *op. 31*, No. 2, which is rightly regarded as marking the beginning of Beethoven's second period. The slow movement,

like those of *op. 7* and a few other early works, shows a thrilling solemnity that immediately proves the identity of the pupil of Haydn with the creator of the 9th symphony. The little *scherzo* no less clearly foreshadows the new era in music by the fact that in so small and light a movement a modulation from A to G sharp minor can occur too naturally to excite surprise. If the later work of Beethoven were unknown there would be very little evidence that this sonata was by a young man, except, perhaps, in the remarkable abruptness of style in the first movement, an abruptness which is characteristic, not of immaturity, but of art in which problems are successfully solved for the first time. This abruptness is, however, in a few of Beethoven's early works carried appreciably too far. In the sonata in C minor, *op. 10, No. 1*, for example, the more vigorous parts of the first movement lose in breadth from it, while the finale is almost stunted.

But Beethoven was not content to express his individuality only in an abrupt epigrammatic style. From the outset breadth was also his aim, and while he occasionally attempted to attain a greater breadth than his resources would properly allow (as in the first movement of the sonata, *op. 2, No. 3*, and that of the violoncello sonata, *op. 5, No. 1*, in both of which cases a kind of extempore outburst in the coda conceals the collapse of his peroration), there are many early works in which he shows neither abruptness of style nor any tendency to confine himself within the limits of previous art. The C minor trio, *op. 1, No. 3*, is not more remarkable for the boldness of thought that made Haydn doubtful as to the advisability of publishing it, than for the perfect smoothness and spaciousness of its style. These qualities Beethoven at first naturally found easier to retain with less dramatic material, as in the other trios in the same *opus*, but the C minor trio does not stand alone. It represents, perhaps, the most numerous, as certainly the noblest, class of Beethoven's early works. Certainly the smallest class is that in which there is unmistakable imitation of Mozart, and it is significant that almost all examples of this class are works for wind instruments, where the technical limitations narrowly determine the style and discourage the composer from taking things seriously. Such works are the beautiful and popular septet, the quintet for pianoforte and wind instruments (modelled superficially, yet closely and with a kind of modest ambition, on Mozart's wonderful work for the same combination) and, on a somewhat higher level, the trio for pianoforte, clarinet and violoncello, *op. 11*.

It is futile to discuss the point at which Beethoven's second manner may be said to begin, but he has himself given us excellent evidence as to when and how his first manner (as far as that is a single thing) became impossible to him. Through quite a large number of works, beginning perhaps with the great string quintet, *op. 29*, new types of harmonic and emotional expression had been assimilated into a style at least intelligible from Mozart's point of view. Indeed, Beethoven's favourite way of enlarging his range of expression often seems to consist in allowing the Titanic force of his new inventions and the formal beauty of the old art to indicate by their contrast a new world grander and lovelier than either. Sometimes, as in the C major quintet, the new elements are too perfectly assimilated for the contrast to appear. The range of key and depth of thought is beyond that of Beethoven's first manner, but the smoothness is that of Mozart. In the three pianoforte sonatas, *op. 31*, the struggle of the transition is as manifest as its accomplishment is triumphant. The first movement of the first sonata (in G major) deals with widely separated keys on new principles. These are embodied in a style which for abruptness and jocular paradox is hardly surpassed by Beethoven's most nervous early works. The exceptionally ornate and dilatory slow movement reads almost like a protest; while the finale begins as if to show that humour should be beautiful, and ends by making fun of the beauty. The second sonata (in D minor) is the greatest work Beethoven had as yet written. Its first movement, already cited above in connexion with the dramatic sequences in *op. 2, No. 2*, is, like that of the *Sonata Appassionata*, a *locus classicus* for such

powerful means of expression. And it is worth noting that the only sketch known of this movement is a sketch in which nothing but its sequential plan is indicated. In the third sonata Beethoven enjoys on a higher plane an experience he had often indulged in before, the attainment of smoothness and breadth by means of a delicately humorous calm which gives scope to the finer subtleties of his new thoughts.

Beethoven himself wrote to his publisher that these three sonatas represented a new phase in his style; but when we realize his artistic conscientiousness it is not surprising that they should be contemporary with larger works like the 2nd symphony, which are far more characteristic of his first manner. His whole development is entirely ruled by his determination to let nothing pass until it has been completely mastered, and long before this his sketch-books show that he had many ambitious ideas for a 1st symphony, and that it was a deliberate process that made his ambitions dwindle into something that could be safely realized in the masterly little comedy with which he began his orchestral career. The easy breadth and power of the 2nd symphony represents an amply sufficient advance, and leaves his forces free to develop in less expensive forms those vast energies for which afterwards the orchestra and the string-quartet were to become the natural field.

In the "Waldstein" sonata, *op. 53*, we see Beethoven's second manner literally displacing his first; that is to say, we reach a state of things at which the two can no longer form an artistic contrast. The work, as we know it, is not only perfect, but has all the qualities of art in which the newest elements have long been familiar. The opening is on the same harmonic train of thought as that of the sonata, *op. 31, No. 1*, but there is no longer the slightest need for a paradoxical or jocular manner. On the contrary, the harmonies are held together by an orderly sequence in the bass, and the onrush is that of some calm diurnal energy of nature. The short introduction to the finale is harmonically and emotionally the most profound thing in the sonata, while the finale itself uses every new resource in the triumphant attainment of a leisure more splendid than any conceivable in the most spacious of Mozart's rondos. Yet it is well known that Beethoven originally intended the beautiful *andante* in F, afterwards published separately, to be the slow movement of this sonata. That *andante* is, like the finale, a spacious and gorguous rondo, which probably Beethoven himself could not have written at an earlier period. The modulation to D flat in its principal theme, and that to G flat near the end, are its chief harmonic effects and stand out in beautiful relief within its limits. After the first movement of the Waldstein sonata they would be flat and colourless. The sketch-books show that Beethoven, when he first planned the sonata, was by no means inattentive to the balance of harmonic colour in the whole scheme, but that at first he did not realize how far that scheme was going to carry him. He originally thought of the slow movement as in E major, a remote key to which, however, he soon assigned the more intimate position of complementary key in the first movement. He then worked at the slow movement in F with such zest that he did not discover until the whole sonata was finished that he had raised the first and last movements to an altogether higher plane of thought, though the redundancy of the two rondos in juxtaposition and the unusual length of the sonata were so obvious that his friends ventured to point them out. Beethoven's revision of his earliest works is now known to have been extensive and drastic; but this is the first instance, and *Fidelio* and the quartet in B flat, *op. 131*, are the only other instances, of any later work needing important alteration after it was completely executed. From this point up to *op. 101* we may study Beethoven's second manner entirely free from any survivals of his first, even as a legitimate contrast; though it is as impossible to fix a point before which his third manner cannot be traced as it is to ignore the premonitions of his second manner in his early works. The distinguishing features in Beethoven's second style are the result of a condition of art in which enormous new possibilities have become so well known that there is no need for stating them abruptly, paradoxically or

emphatically, but also no need for working them out to remote conclusions. Hence these works have become for most people the best-known and best-loved type of classical music. In their perfect fusion of untranslatable dramatic emotion with every beauty of musical design and tone they have never been equalled, nor is it probable that any other art can show a wider range of thought embodied in a more perfect form. In music itself there is nothing else of so wide a range without grave artistic defects from which Beethoven is entirely free. Wagnerian opera aims at an ideal as truly artistic, and in so far of wider range than Beethoven's that it passes beyond the bounds of pure music altogether. Within those bounds Beethoven remained, and even the apparent exceptions (such as *Fidelio* and his two great examples of "programme music," the *Pastoral Symphony* and the sonata, *Les Adieux*) only show how universal his conception of pure music is. Extraneous ideas had here struck him as magnificent material for instrumental music, and he never troubled to argue whether instrumental music is the better or worse for expressing extraneous ideas. To describe the works of Beethoven's second period here would be to describe a library of well-known classics, and we must refer the reader for further details to the articles on SONATA FORMS, CONTRAPUNTAL FORMS, HARMONY AND INSTRUMENTATION. It remains for us to attempt to indicate the essential features of his third style, and to conclude with a survey of his influence on the history of music.

Beethoven's third style arose imperceptibly from his second. His deafness had very little to do with it, for all his epoch-making discoveries in orchestral effect date from the time when he was already far too much inconvenienced to test them in a way which would satisfy any one who depended more upon his ear than upon his imagination. It is indeed highly probable that there are no important features in Beethoven's latest style that may not be paralleled by the tendencies of all great artists who have handled their material until it contains nothing that has not been long familiar with them. Such tendencies lead to an extreme simplicity of form, underlying an elaboration of detail which may at first seem bewildering until we realize that it is purely the working out to its logical conclusions of some idea as simple and natural as the form itself. The form, however, will be not merely simple, but individual. Different works will show such striking external differences of form that a criticism which applies merely *a priori* or historic standards will be tempted by the fallacy that there is less form in a number of such markedly different works than in a number of works that have one scheme in common. All this is eminently the case with Beethoven's last works. The extreme simplicity of the themes of the first two movements of the quartet in B flat, *op. 131*, and the tremendous complexity of the texture into which they are woven, at first impress us as something mysterious and intangible rather than astonishing. The boldness with which the slow introduction is blended in broad statement and counter-statement with the *allegro*, is directly impressive, as is also the entry of the second subject with its dark harmony and tone, but the work needs long familiarity before its vast mass of thought reveals itself to us in its true lucidity. Such works are "dark with excessive bright." When we enter into them they are transparent as far as our vision extends, and their darkness is that of a depth that shines as we penetrate it. In all probability only a veil of familiarity prevents our finding the same kind of difficulty in Beethoven's earlier works. What is undoubtedly newest in the last works is the enormous development of those polyphonic elements which are always essential to the life of a composition, but which have very different functions and degrees of prominence in different forms and stages of the art. Polyphony inevitably draws attention to detail, and thus Beethoven in his middle period found its more obvious manifestations but little conducive to the breadth of designs which were not as yet sufficiently familiar to take any but the foremost place. Hence, among other interesting features of that second period, his marked preference for themes founded on rhythmic figures of one note, e.g. the famous "four taps" in the C minor symphony; an identical rhythm in a melodious theme of very different character in the

G major concerto; a similar figure in the *Sonata Appassionata*; the first theme of the *scherzo* of the F major quartet, *op. 59*, No. 1, and the drum-beats in the violin concerto. Such rhythms give thematic life to an inner part without causing it to assume such melodic interest as might distract the attention from the flow of the surface. But in proportion as polyphony loses its danger so does the prominence of such rhythmic figures decrease, until in Beethoven's last works they are no more noticeable than other kinds of simplicity. The impression of crowded detail is naturally more prominent the smaller the means with which Beethoven works and the less outwardly dramatic his thought. Thus those most gigantic of all musical designs, the 9th symphony, and the Mass in D, are, but for the mechanical difficulties of the choral writing, almost like works of the second period as far as direct impressiveness is concerned; and in the same way the enormous pianoforte sonata, *op. 106*, is in its first three movements easier to follow than the extremely terse and subtle works on a smaller scale that preceded it (sonata in A major, 101, and the two sonatas for violoncello, *op. 102*).

His enormous development of polyphonic interest soon led Beethoven to employ the fugue, not only, as in previous works, by way of episodic contrast to passages and designs in which the form and not the texture is the main object of interest, but as the culminating expression of a condition or art in which the unity of form and texture is so perfect that the mind is free to concentrate itself on the texture alone. This union was not effected without a struggle, the traces of which present a close parallel to that abrupt emphasis which we noticed in some of Beethoven's early works. In his fugue-writing the notion that the chief interest lies in the texture is as yet so difficult to hold together with the perception that these fugues are based on a modern firmness and range of form, that the texture is forced upon the listener's attention by a continual series of ruthlessly logical bold strokes of harmony. From this and from the notorious violence of Beethoven's choral writing, and also from his well-known technical struggles in his years of pupillage, the easy inference has been drawn that Beethoven never was a great master of counterpoint, an inference that is absolutely irreconcilable with such plain facts as, to take but one early example, the brilliant piece of triple counterpoint in the *Andante* of the string quartet in C minor, *op. 18*, No. 4, and the complete absence of anything like crudeness in his handling of harmonies, basses or inner parts at any period of his career. Beethoven may have mastered some things with difficulty, but he mastered nothing incompletely; and where he is not orthodox it is safest to conclude that orthodoxy is wrong. Had he lived for another ten years he would certainly have produced an immense amount of choral work, and with it many other great instrumental works in which this last remaining element of conflict between texture and form would have dwindled away. But while this would doubtless result in such work being easier to follow and might even have given us a version of the great fugue, *op. 133* (discarded from the string-quartet, *op. 131*), that did not surpass the bounds of practical performance, it would yet be no sound criterion by which to stigmatize as an immaturity the roughness of the polyphonic works that we know. That roughness is, like the abrupt epigrammatic manner of some of his early works, the necessary condition in which such material realizes mature expression. Without it that material could receive but the academic handling of a dead language. And by it was created that permanent reconciliation of polyphony and form from which has arisen almost all that is true in "Romantic" music, all that is peculiar to the thematic technique of Wagnerian opera, and all the perfect smoothness of Brahms's polyphony.

The incalculable depth of thought and closeness of texture in Beethoven's later works are, of course, the embodiment of a no less incalculable emotional power. If we at times feel that the last quartets are more introspective than dramatic, that is only because Beethoven's dramatic sense is higher than we can realize. The subject is too large and too subtle for dogmatism to be profitable; and we cannot in Beethoven's case, as we can in Bach's, cite a complete series of illustrations of his musical

ideas from his treatment in choral music of words which themselves interpret the intention of the composer. There is so little but the music itself by which one can express Beethoven's thought, that the utmost we can do here is to refer the reader, as before, to the articles on SONATA FORMS, HARMONY, INSTRUMENTATION, OPERA AND MUSIC, where he will find further attempts to indicate in what sense pure music can be described as dramatic and expressive of emotion.

As our range of investigation widens, and thoroughness of analysis and study increases, so we shall surely find in ourselves an ever-deepening conviction that Beethoven, whether in range, depth and truth of thought, perfect sense of beauty, or absolute conscientiousness of execution, is the greatest musician, perhaps the greatest artist, that ever lived. There is no means of measuring Beethoven's influence upon subsequent music. Every composer of every school claims it. The immense changes he brought about in the range of music have their most obvious effect in the possibilities of emotional expression; and so any outbreak of vulgarity or sentimentality can with impunity claim descent from Beethoven, though its ancestry may be no higher than Meyerbeer. Again, we have already referred to that confusion of thought which regards a series of works markedly different in form as containing less form than any number of works cast in one mould. Hence the works of Beethoven's third period have been cited in defence of more than one "revolution," attempted in a form which never existed in any true classic, for the purpose of setting up something the revolutionist has not yet succeeded in inventing. To measure Beethoven's influence is like measuring Shakespeare's. It is an influence either too vaguely universal to name or too profoundly artistic to analyse. Perhaps the truest account of it would be that which ignored its presence in the works of ill-balanced artists, or even in the works of those who profited merely by an increase of technical and harmonic resource which, though effected by Beethoven, would, after the French Revolution and the Napoleonic wars, almost certainly have to some extent arisen from sheer necessity of finding expression for the new experience of humanity, if Beethoven had never existed. Setting aside, then, all instances of mere domination, and of a permanently established new world of musical thought, and omitting Schubert and Weber as contemporaries, the one attracted and the other partly repelled, we may, perhaps, take three later composers, Schumann, Wagner and Brahms, as the leading examples of the way in which Beethoven's influence is definitely traceable as a creative force. The depth and solemnity of Beethoven's melody and later polyphonic richness is a leading source of Schumann's inspiration, though Schumann's artistic schemes exclude any high degree of formal organization on a large scale. Beethoven's late polyphony is carried on by Brahms to the point at which perfect smoothness of style is once more possible, and there is no aspect of his form which Brahms neglects or fails to realize with that complete originality which has nothing to fear from its ancestry. Wagner does not handle the same art-forms; his task is different, but Beethoven was the inspiring source, not only of his purely musical sense, but also of his whole sense of dramatic contrast and fitness. When he had shaken off the influence of Meyerbeer, which has so often been confused with that of Beethoven, there remained to him, pre-eminently in his music and more imperfectly realized in his drama, a power of combining contrasted emotions such as is the privilege of only the very greatest dramatic artists. Bach and Beethoven are the sources of the polyphonic means of expression by which he attains this. Beethoven alone is the extraneous source of his knowledge that it was possible. And it is as certain as anything in the history of art that there will never be a time when Beethoven's work does not occupy the central place in a sound musical mind.

ANNOTATED LIST OF BEETHOVEN'S WORKS

Up to 1823 we give in most cases the dates of publication, the date of composition being generally from one to three years earlier. Beethoven seldom had less than a dozen projects in hand at once, and their immediate chronology is inextricable; whereas publication generally means final revision. This list is purposely incomplete

in order that unimportant works may not distract attention, even when they are late and on a large scale.

- Sonata = Pianoforte sonata.
Violin or violoncello sonata = for pianoforte, V. or Vc.
Pianoforte trio = Pfte., V., Vc.
Pianoforte quartet = Pfte., V., viola and Vc.
String trio = V., Va., Vc.
String quartet = V., Va., Vc. and Vc.
Pianoforte or violin concerto = Concerto with orchestra.
1785. 3 pftc. quartets, of which the third contains important material for the sonatas, op. 2, Nos. 1 and 3.
(Thayer's attribution of the masterly bagatelles, op. 33, published 1803, to this period can only be rationalized by some similar rough first idea.)
1790. 24 variations on an air by Righini (published 1801). A very remarkable work, anticipating Schumann's *Pavillons in its humorous close*. It was Beethoven's chief early *tour-de-force* in pianoforte playing.
1795. 3 pftc. trios, op. 1 (E♭, G, C minor).
1796. 3 pftc. sonatas, op. 2 (F minor, A and C, dedicated to Haydn).
1797. String trio, op. 3, 2 violoncello sonatas, op. 5, F and G m., sonata, op. 7, E♭.
1798. 3 string trios, op. 9; G, D, C m.i., 3 sonatas, op. 10 (C m. F, D). Trio for pftc., clarinet and violoncello in B♭, op. 11.
1799. 3 violin sonatas (D, A, E♭), op. 12. Pfte. sonata (*Pastorale* not Beethoven's title) C m., op. 13, 2 pftc. sonatas, op. 14, E, G (the first arranged by the composer as a string quartet in F).
1801. Pianoforte concertos, op. 15 in C, op. 19 in B♭ (the latter composed first). Quintet for pianoforte and wind instruments, op. 16 (also arranged, with new details, as quartet for pianoforte and strings), composed 1797. 6 string quartets, 21 (F, G, D, C m., A, B♭). 1st symphony (C), op. 21. 2 violin sonatas, A m., op. 23; F m., op. 24 (made into two *opus*-numbers by an accident in the *format* of the volumes).
1802. Pianoforte score of the *Prometheus* ballet, op. 24 (ousted by the F m. violin sonata, and reissued as op. 43). Sonata in B♭, op. 22. Sonata in A♭, op. 26 (with the funeral march), 2 sonatas, *Il rustico* (*fantasia* ?), op. 27, E♭, C#m. Sonata in D, op. 28 (*Pastorale* not Beethoven's title). String quintet in C, op. 29.
1803. 3 violin sonatas, op. 30 (A, C m., G), 3 sonatas, op. 31, G, D m., E♭ (the last appearing in 1804).
Variations, op. 34. 15 variations and fugue on theme from *Prometheus*, op. 35.
1804. 2nd symphony (D), op. 36 (1802). 3rd pftc. concerto (C m.), op. 37 (1800).
1805. The *Kreutzer* sonata, op. 47, for pftc. and violin (A) (finale at first intended for op. 30, No. 1).
"Waldstein" sonata for pftc., op. 53 (C). First version of opera *Leonore* in three acts with overture ("No. 2").
1806. Sonata in F, op. 54. *Eroica Symphony*, No. 3, op. 55 (E♭), written in 1804 in honour of Napoleon Bonaparte. It was just finished when news arrived that Napoleon had made himself emperor, and Beethoven was with difficulty restrained from destroying the score. It is still the longest extant perfect design in instrumental music. The finale glorifies the material (and much of the form) of the variations, op. 35. The *Scherzo* is the first full-sized example of Beethoven's special type.
Leonore reproduced in two acts with overture No. 3, 32 variations in C m. (no *opus*-number, but a very important work on the lines of a modernized *chaconne*).
1807. Triple concerto (pftc., V. and Vc.), op. 56, chiefly interesting as a study for the true concerto-form which had given Beethoven difficulty. Sonata, op. 57 (F m., *Appassionata* not Beethoven's title). New overture, *Leonore*, "No. 1," composed for projected performance of the opera at Prague (posthumously published as op. 138).
1808. 4th pftc. concerto, op. 58 (G). 3 string quartets, op. 59, F, E m., C (dedicated to Count Kasoumovsky, in compliment to whom Russian tunes appear in the finale of No. 1 and the *Scherzo* of No. 2). Overture to *Coriolanus*, op. 62.
1809. 4th symphony, op. 60 (B♭). Violin concerto (D), op. 61 (also arranged by the composer for pianoforte). 5th symphony, op. 67 (C m.) (1806), the first in which trombones appear. 6th symphony (*Pastorale*), op. 68; violoncello sonata, op. 69 (A). 2 pianoforte trios, op. 70 (D, E♭).
1810. Pianoforte score of *Leonore* (2nd version) published. String quartet, op. 74 (E♭), called "Harp" because of *pizzicato* passages in first movement). *Fantasia*, op. 77, interesting as consisting of a long and capricious series of dramatic beginnings and breakings off of themes, as if in search for a firm idea, which is at last found and developed as a set of variations. This scheme thus foreshadows the choral finale of the 9th symphony even more significantly than the Choral *Fantasia*.
Sonata, op. 78, F# (extremely terse and subtle, and a great favourite with Beethoven, who preferred it to the C#m.).

1811. 5th pftc. concerto, *op. 73*, Eb (*The Emperor* not Beethoven's title). Fantasia for pftc., orchestra and chorus, *op. 80*. Sonata, *op. 81a* (*Les Adieux, l'absence, et le retour*), first movement written when the archduke Rudolph had to leave Vienna (4th May 1809), and the rest on his return on the 30th of January 1810. It was an anxious time both for Beethoven and his excellent royal friend, for whom he had great affection. (Battle of Wagram, 6th July 1809.) We may here note that *op. 81b* is an unimportant and very early sextet. The overture to *Egmont*, *op. 84*; *Christus am Oelberge* (the Mount of Olives), *op. 85*, oratorio (probably composed between 1800 and its first performance in 1803).
1812. The rest of the *Egmont* music, *op. 84*. 1st mass, *op. 87* (C) (first performance, 1807).
1814. Final version of *Leonore*, performed as *Fidelio* with great alterations, skilful revision of the libretto, very important new material in the music and a new overture.
1815. Sonata, *op. 90* (E m.).
1816. 7th symphony, *op. 92* (A); 8th symphony, *op. 93* (F) (Beethoven was planning a group of three of which the last was to be in D m., which we shall find significant). String quartet, *op. 95* (F m.). Violin sonata, *op. 96* (G). Piano-forte trio, *op. 97* (Bb); *Liederheis*, *op. 98*.
1817. Sonata, *op. 101* (the first; indistinguishable in Beethoven's "third manner"). 2 violoncello sonatas, *op. 102* (C, D, the second containing Beethoven's first modern instrumental strict fuge).
1819. Arrangement for string quintet, *op. 104*, of C m. trio, *op. 1*, No. 3 (a wonderful study in transition comparable only to Bach's arrangements and very unlike Beethoven's former essays of the kind). Sonata, *op. 106* (B), the largest and most symphonic pianoforte work extant, surpassed in length only by Bach's *Goldberg* variations and Beethoven's 33 variations on Diabelli's waltz.
1821. 25 Scotch songs accompanied by pftc., V. and Vc., *op. 108* (the first set of a large and much neglected collection, mostly posthumous, many of great interest and beauty and very Beethovenian, which has shocked persons who expect sympathetic insight into folk-music to prevail over Beethoven's artistic impulse). Sonata, *op. 109* (E).
1822. Sonata, *op. 110* (Ab). Overture, *Die Weihe des Hauses*, *op. 124* (C), a magnificent essay in orchestral free fuge, published 1825.
1823. Sonata, *op. 111* (C m., the last pianoforte sonata). 33 variations on a waltz by Diabelli, who sent his waltz round to fifty-one musicians in Austria asking each to contribute a variation; the whole to be published for the benefit of the widows and orphans left by the war. Beethoven answered with the greatest set ever written, and it was published in a separate volume. Among the other fifty composers were Schubert and an infant prodigy of eleven, Franz Liszt!
1825. The mass in D (*Missa Solemnis*), *op. 123*, begun in 1818 for the installation of the archduke Rudolph as archbishop of Olmütz, was not finished until 1826, two years after the installation.
- The 9th symphony, *op. 125* D m. (see note on 7th and 8th symphonies); sketches begun 1817; project of setting Schiller's *Freude* already in Beethoven's mind before he left Bonn.
- 6 bagatelles, *op. 126*, Beethoven's last pianoforte work of a very remarkable and unaccountably neglected group of carefully contrasted lyrical pieces.
1824. String quartet, *op. 127* (Eb, published 1826).
1825. String quartet, *op. 130* (Bb), with finale, *op. 133* (grand fugue); string quartet, *op. 132* (A m., with slow movement in Lydian mode, a *Heiliger Dankgesang* on recovery from illness. Theme of finale first thought of as for instrumental finale to 9th symphony).
1826. String quartet, *op. 131* (Cb, m.). String quartet, *op. 135* (F). New finale to *op. 130*, Beethoven's last composition.

AUTHORITIES.—A. W. Thayer, *Beethoven's Leben* (1866-7, T.); L. Nohl, *Life of Beethoven* (Eng. trans., 1884), and *Letters* (Eng. trans., 1866); Sir G. Grove, *Beethoven and his Symphonies* (1896), and in *Grove's Dictionary of Music*.

BEETLE (O. Eng. *bityl*; connected with "bite"), a name commonly applied to those insects which possess horny wing-cases; it is used to denote the cockroaches (*g.v.*) (black beetles), as well as the true beetles or *Coleoptera* (*g.v.*), the two belonging to different orders of *Insecta*.

The adjective "beetle-browed," and similarly "beetling" (of a cliff), are derived from the name of the insect. From another word (O. Eng. *betel*, connected with "beat") comes "beetle" in the sense of a mallet, and the "beetling-machine," which subjects fabrics to a hammering process.

BEETS, NIKOLAAS (1814-1903), Dutch poet, was born at Haarlem on the 13th of September 1814; constant references in his poems and sketches show how deeply the beauty of that town and its neighbourhood impressed his imagination. He studied theology in Leiden, but gave himself early to the cultivation of poetry. In his youth Beets was entirely carried away on the tide of Byronism which was then sweeping over Europe, and his early works—*Jose* (1834), *Kuser* (1835) and *Guy de Vlaming* (1837)—are gloomy romances of the most impassioned type. But at the very same time he was beginning in prose the composite work of humour and observation which has made him famous, and which certainly had nothing that was in the least Byronic about it. This was the celebrated *Camera Obscura* (1839), the most successful imaginative work which any Dutchman of the 19th century produced. This work, published under the pseudonym of "Hildebrand," goes back in its earliest inception to the year 1835, when Beets was only twenty-one. It consists of complete short stories, descriptive sketches, studies of peasant life—all instinct with humour and pathos, and written in a style of great charm; it has been reprinted in countless editions. Beets became a professor at the university of Leiden, and the pastor of a congregation in that city. In middle life he published further collections of verse—*Cornflowers* (1853) and *New Poems* (1857)—in which the romantic melancholy was found to have disappeared, and to have left in its place a gentle sentiment and a depth of religious feeling. In 1873-1875 Beets collected his works in three volumes. In April 1883 the honorary degree of LL.D. Edin. was conferred upon him. He died at Utrecht on the 13th of March 1903.

BEFANA (Ital., corrupted from *Epifania*, Epiphany), the Italian female counterpart of Santa Claus, the Christmas benefactor (St Nicholas). On Epiphany, or Twelfth Night, she plays the fairy godmother to the children, filling their stockings with presents. Tradition relates that she was too busy with house duties to come to the window to see the Three Wise Men of the East pass on their journey to pay adoration to the Saviour, excusing herself on the ground that she could see them on their return. They went back another way, and Befana is alleged to have been punished by being obliged to look for them for ever. Her legends seem to be rather mixed, for in spite of her Santa Claus character, her name is used by Italian mothers as a bogey to frighten the babies. It was the custom to carry her effigy through Italian towns on the eve of the Epiphany.

BEFFROY DE REIGNY, LOUIS ABEL (1757-1811), French dramatist and man of letters, was born at Laon on the 6th of November 1757. Under the name of "Cousin Jacques" he founded a periodical called *Les Lunes* (1785-1787). *The Courier des planètes ou Correspondance du Cousin Jacques avec le firmament* (1788-1792) followed. *Nicodème dans la lune, ou la révolution pacifique* (1790) a three-act farce, is said to have had more than four hundred representations. In spite of his protests against the evils of the Revolution he escaped interference through the influence of his brother, Louis Étienne Beffroy, who was a member of the Convention. Of *La Petite Nanette* (1795) and several other operas he wrote both the words and the music. His *Dictionnaire néologique* (3 vols., 1795-1800) of the chief actors and events in the Revolution was interdicted by the police and remained incomplete. Beffroy spent his last years in retirement, dying in Paris on the 17th of December 1811.

BEGAS, KARL (1794-1854), German historical painter, was born at Heinsberg near Aix-la-Chapelle. His father, a retired judge, destined him for the legal profession, but the boy's tastes pointed definitely in another direction. Even at school he was remarked for his wonderful skill in drawing and painting, and in 1812 he was permitted to visit Paris in order to perfect himself in his art. He studied for eighteen months in the atelier of Gros and then began to work independently. In 1814 his copy of the Madonna della Sedia was bought by the king of Prussia, who was attracted by the young artist and did much to advance him. He was engaged to paint several large Biblical pictures, and in 1825, after his return from Italy, continued to produce paintings which were placed in the churches of Berlin and

Potsdam. Some of these were historical pieces, but the majority were representations of Scriptural incidents. Begas was also celebrated as a portrait-painter, and supplied to the royal gallery a long series of portraits of eminent Prussian men of letters. At his death he held the post of court painter at Berlin. His son OSKAR (1828–1883) was also a painter and professor of painting at Berlin. REINHOLD, the sculptor, is noticed below.

BEGAS, REINHOLD (1831–), German sculptor, younger son of Karl Begas, the painter, was born at Berlin on the 15th of July 1831. He received his early education (1846–1851) in the ateliers of C. D. Rauch and L. Wichmann. During a period of study in Italy, from 1856 to 1858, he was influenced by Böcklin and Lenbach in the direction of a naturalistic style in sculpture. This tendency was marked in the group "Borussia," executed for the façade of the exchange in Berlin, which first brought him into general notice. In 1861 he was appointed professor at the art school at Weimar, but retained the appointment only a few months. That he was chosen, after competition, to execute the statue of Schiller for the Gendarmen Markt in Berlin, was a high tribute to the fame he had already acquired; and the result, one of the finest statues in the German metropolis, entirely justified his selection. Since the year 1870, Begas has entirely dominated the plastic art in Prussia, but especially in Berlin. Among his chief works during this period are the colossal statue of Borussia for the Hall of Glory; the Neptune fountain in bronze on the Schlossplatz; the statue of Alexander von Humboldt, all in Berlin; the sarcophagus of the emperor Frederick III. in the mausoleum of the Friedenskirche at Potsdam; and, lastly, the national monument to the emperor William (see BERLIN), the statue of Bismarck before the Reichstag building, and several of the statues in the Siegesallee. He was also entrusted with the execution of the sarcophagus of the empress Frederick.

See A. G. Meyer, "Reinhold Begas" in *Künstler-Monographien*, ed. H. Knackfuss, Heft xx. (Bielefeld, 1897; new ed., 1901).

BEGGAR, one who begs, particularly one who gains his living by asking the charitable contributions of others. The word, with the verbal form "to beg," in Middle English *beggen*, is of obscure history. The words appear first in English in the 13th century, and were early connected with "bag," with reference to the receptacle for alms carried by the beggars. The most probable derivation of the word, and that now generally accepted, is that it is a corruption of the name of the lay communities known as Beguines and Beghards, which, shortly after their establishment, followed the friars in the practice of mendicancy (see BEGUINES). It has been suggested, however, that the origin of "beg" and "beggars" is to be found in a rare Old English word, *bedecian*, of the same meaning, which is apparently connected with the Gothic *bidjan*, cf. German *bitten*; but between the occurrence of *bedecian* at the end of the 9th century and the appearance of "beggar" and "beg" in the 13th, there is a blank, and no explanation can be given of the great change in form. For the English law relating to begging and its history, see CHARITY, POOR LAW and VAGRANCY.

BEGGAR-MY-NEIGHBOUR, a simple card-game. An ordinary pack is divided equally between two players, and the cards are held with the backs upwards. The first player lays down his top card face up, and the opponent plays his top card on it, and this goes on alternately as long as no court-card appears; but if either player turns up a court-card, his opponent has to play four ordinary cards to an ace, three to a king, two to a queen, one to a knave, and when he has done so the other player takes all the cards on the table and places them under his pack; if, however, in the course of this playing to a court-card, another court-card turns up, the adversary has in turn to play to this, and as long as neither has played a full number of ordinary cards to any court-card the trick continues. The player who gets all the cards into his hand is the winner.

BEGONIA (named from M. Begon, a French patron of botany), a large genus (natural order, Begoniaceae) of succulent herbs or undershrubs, with about three hundred and fifty species in tropical moist climates, especially South America and India. About one hundred and fifty species are known in cultivation,

and innumerable varieties and hybrid forms. Many are tuberous. The flowers are usually showy and large, white, rose, scarlet or yellow in colour; they are unisexual, the male containing numerous stamens, the female having a large inferior ovary and two to four branched or twisted stigmas. The fruit is a winged capsule containing numerous minute seeds. The leaves, which are often large and variegated, are unequal-sided.

Cuttings from flowering begonias root freely in sandy soil, if placed in heat at any season when moderately firm; as soon as rooted, they should be potted singly into 3-in. pots, in sandy loam mixed with leaf-mould and sand. They should be stopped to keep them bushy, placed in a light situation, and thinly shaded in the middle of very bright days. In a few weeks they will require another shift. They should not be overpotted, but instead assisted by manure water. The pots should be placed in a light pit near the roof glass. The summer-flowering kinds will soon begin blooming, but the autumn and winter flowering sorts should be kept growing on in a temperature of from 55° to 60° by night, with a few degrees more in the day. The tuberous-rooted sorts require to be kept at rest in winter, in a medium temperature, almost but not quite dry. In February they should be potted in a compost of sandy loam and leaf-mould, and placed in a temperate pit until May or June, when they may be moved to the greenhouse for flowering. If they afterwards get at all pot-bound, weak manure should be applied. After blooming, the supply of water must be again slackened; in winter the plants should be stored in a dry place secure from frost; they are increased by late summer and autumn cuttings, after being partially cut down.

BEGUINES (Fr. *béguine*, Med. Lat. *beguina*, *begina*, *beghina*), at the present time the name of the members of certain lay sisterhoods established in the Netherlands and Germany, the enclosed district within which they live being known as a beguinae (Lat. *beguinicum*). The equivalent male communities, called also Beguines (Fr. *béguins*, Lat. *beguini*), but more usually Beghards (Lat. *baghardi*, *beggardii*, *begehardi*, &c., O. Fr. *bégard-i*, Flem. *beggardt*), have long ceased to exist. The origin of the names Beguine and Beghard has been the subject of much controversy. In the 15th century a legend arose that both name and organization were traceable to St Begga, daughter of Pippin of Landen, who consequently in 1630 was chosen by the Beguines as the patron saint of their association. In 1630 a professor of Louvain, Erycius Puteanus (van Putte), published a treatise, *De Begginarum apud Belgas instituto et nomine suffragium*, in which he produced three documents purporting to date from the 11th and 12th centuries, which seemed conclusively to prove that the Beguines existed long before Lambert le Bègue. For two centuries these were accepted as genuine and are admitted as such even in the monumental work of Mosheim. In 1843, however, they were conclusively proved by the German scholar Hallmann, from internal evidence, to be forgeries of the 14th and 15th centuries. It is now universally admitted that both the institution and the name of the Beguines are derived from Lambert le Bègue, who died about the year 1187. The confusion caused by the spurious documents of Puteanus, however, led, even when the legend of St Begga was rejected, to other suggestions for the derivation of the name, e.g. from an imaginary old Saxon word *beggen*, "to beg" or "pray," an explanation adopted even by Mosheim, or from *bègue*, "stammering," a French word of unknown origin, which only brings us back to Lambert again, whose name of Le Bègue, as the chronicler Aegidius, a monk of Orval (Aureae Vallis), tells us, simply means "the stammerer," *quia balbus erat* (*Gesta pontificum Leodiensium*, c. A.D. 1251). Doubtless this coincidence gave a ready handle to the scoffing wits of the time, and among the numerous popular names given to the Beghards—*bons garçons*, *boni pueri*, *boni valetii* and the like—we find also that of Lollards (from Flemish *lollen*, "to stammer").

About the year 1170 Lambert le Bègue, a priest of Liège, who had devoted his fortune to founding the hospital and church of St Christopher for the widows and children of crusaders, conceived the idea of establishing an association of women, who,

without taking the monastic vows, should devote themselves to a life of religion. The effect of his preaching was immense, and large numbers of women, many of them left desolate by the loss of their husbands on crusade, came under the influence of a movement which was attended with all the manifestations of what is now called a "revival." About the year 1180 Lambert gathered some of these women, who had been ironically styled "Begunes" by his opponents, into a semi-conventual community, which he established in a quarter of the city belonging to him around his church of St. Christopher. The district was surrounded by a wall within which the Begunes lived in separate small houses, subject to no rule save the obligation of good works, and of chastity so long as they remained members of the community. After Lambert's death (c. 1187?) the movement rapidly spread, first in the Netherlands and afterwards in France—where it was encouraged by the saintly Louis IX.—Germany, Switzerland and the countries beyond. Everywhere the community was modelled on the type established at Liège. It constituted a little city within the city, with separate houses, and usually a church, hospital and guest-house, the whole being under the government of a mistress (*magistra*). Women of all classes were admitted; and, though there was no rule of poverty, many wealthy women devoted their riches to the common cause. The Begunes did not beg; and, when the endowments of the community were not sufficient, the poorer members had to support themselves by manual work, sick-nursing and the like.

The Begune communities were fruitful soil for the missionary enterprise of the friars, and in the course of the 13th century the communities in France, Germany and upper Italy had fallen under the influence of the Dominicans and Franciscans to such an extent that in the Latin-speaking countries the tertiaries of these orders were commonly called *beguini* and *beguinae*. The very looseness of their organization, indeed, made it inevitable that the Begune associations should follow very diverse developments. Some of them retained their original character; others fell completely under the dominion of the friars, and were ultimately converted into houses of Dominican, Franciscan or Augustinian tertiaries; others again fell under the influence of the mystic movements of the 13th century, turned in increasing numbers from work to mendicancy (as being nearer the Christ-life), practised the most cruel self-tortures, and lapsed into extravagant heresies that called down upon them the condemnation of popes and councils! All this tended to lower the reputation of the Begunes. During the 14th century, indeed, numerous new beguinages were established; but ladies of rank and wealth ceased to enter them, and they tended to become more and more mere almshouses for poor women. By the 15th century in many cases they had utterly sunk in reputation, their obligation to nurse the sick was quite neglected, and they had, rightly or wrongly, acquired the reputation of being mere nests of beggars and women of ill fame. At the Reformation the communities were suppressed in Protestant countries, but in some Catholic countries they still survive. The beguinages found here and there in Germany are now simply almshouses for poor spinners, those in Holland (e.g. at Amsterdam and Breda) and Belgium preserve more faithfully the characteristics of earlier days. The beguinage of St. Elizabeth at Ghent has some thousand sisters, and occupies quite a distinct quarter of the city, being surrounded by a wall and moat. The Begunes wear the old Flemish head-dress and a dark costume, and are conspicuous for their kindness among the poor and their sick nursing.

It is uncertain whether the parallel communities of men originated also with Lambert le Bègue. The first records are of communities at Louvain in 1220 and at Antwerp in 1228. The history of the male communities is to a certain extent parallel with the female, but they were never so numerous and their degeneration was far more rapid. The earliest Flemish Beghard communities were associations mainly of artisans who earned

their living by weaving and the like, and appear to have been in intimate connexion with the craft-gilds; but under the influence of the mendicant movement of the 13th century these tended to break up, and, though certain of the male beguinages survived or were incorporated as tertiaries in the orders of friars, the name of Beghard became associated with groups of wandering mendicants who made religion a cloak for living on charity; *bèguiner* becoming in the French language of the time synonymous with "to beg," and *beghard* with "beggar," a word which, according to the latest authorities, was probably imported into England in the 13th century from this source (see BEGGAR). More serious still, from the point of view of the Church, was the association of these wandering mendicants with the mystic heresies of the Fraticelli, the Apostolici and the pantheistic Brethren of the Free Spirit. The situation was embittered by the hatred of the secular clergy for the friars, with whom the Begunes were associated. Restrictions were placed upon them by the synod of Fritzlar (1269), by that of Mainz (1281) and Eichstätt (1281), and by the synod of Béziers (1299) they were absolutely forbidden. They were again condemned by a synod held at Cologne in 1306; and at the synod of Trier in 1310 a decree was passed against those "who under a pretext of feigned religion call themselves Beghards . . . and, hating manual labour, go about begging, holding conventicles and posing among simple people as interpreters of the Scriptures." Matters came to a climax at the council of Vienne in 1311 under Pope Clement V., where the "sect of Begunes and Beghards" were accused of being the main instruments of the spread of heresy, and decrees were passed suppressing their organization and demanding their severe punishment. The decrees were put into execution by Pope John XXII., and a persecution raged in which, though the pope expressly protected the female Begune communities of the Netherlands, there was little discrimination between the orthodox and unorthodox Begunes. This led to the utmost confusion, the laity in many cases taking the part of the Begune communities, and the Church being thus brought into conflict with the secular authorities. In these circumstances the persecution died down; it was, however, again resumed between 1366 and 1378 by Popes Urban V. and Gregory XI., and the Begunes were not formally reinstated until the pontificate of Eugenius IV. (1431-1447). The male communities did not survive the 14th century, even in the Netherlands, where they had maintained their original character least impaired.

See J. L. von Mosheim, *De beghardis et beguinabus commentarius* (Leipzig, 1790); F. Hallmann, *Die Geschichte des Ursprungs der belgischen Beguinen* (Berlin, 1843); J. C. L. Gieseler, *Eccles. Hist.* (vol. iii, Eng. trans., Edinburgh, 1853), with useful excerpts from documents; Du Cange, *Glossarium*; Herzog-Hauck, *Realencyclopädie* (3rd ed., 1897) s. "Beginen," by Herman Haupt, where numerous further authorities are cited. (W. A. P.)

BEHAIM (or **BEHEM**), **MARTIN** (1456?-1507), a navigator and geographer of great pretensions, was born at Nuremberg, according to one tradition, about 1436; according to Ghillany, as late as 1450. He was drawn to Portugal by participation in Flanders trade, and acquired a scientific reputation at the court of John II. As a pupil, real or supposed, of the astronomer "Regiomontanus" (i.e. Johann Müller of Königsberg in Franconia) he became (c. 1480) a member of a council appointed by King John for the furtherance of navigation. His alleged introduction of the cross-staff into Portugal (an invention described by the Spanish Jew, Levi ben Gerson, in the 14th century) is a matter of controversy; his improvements in the astrolabe were perhaps limited to the introduction of handy brass instruments in place of cumbersome wooden ones; it seems likely that he helped to prepare better navigation tables than had yet been known in the Peninsula. In 1484-1485 he claimed to have accompanied Diogo Cão in his second expedition to West Africa, really undertaken in 1485-86, reaching Cabo Negro in 15°40' S. and Cabo Ledo still farther on. It is now disputed whether Behaim's pretensions here deserve any belief; and it is suggested that instead of sharing in this great voyage of discovery, the Nuremberger only sailed to the nearer coasts of Guinea, perhaps as far as the Bight of Benin, and possibly with José Visinho the

¹In the year 1287 the council of Liège decreed that "all Beguineae desiring to enjoy the Beguine privileges shall enter a Beguineage, and we order that all who remain outside the Beguineage shall wear a dress to distinguish them from the Beguineae."

astronomer and with João Afonso d'Aveiro, in 1484-86. Martin's later history, as traditionally recorded, was as follows. On his return from his West African exploration to Lisbon he was knighted by King John, who afterwards employed him in various capacities; but, from the time of his marriage in 1486, he usually resided at Fayal in the Azores, where his father-in-law, Jobst van Huert, was governor of a Flemish colony. On a visit to his native city in 1492, he constructed his famous terrestrial globe, still preserved in Nuremberg, and often reproduced, in which the influence of Ptolemy is strongly apparent, but wherein some attempt is also made to incorporate the discoveries of the later middle ages (Marco Polo, &c.). The antiquity of this globe and the year of its execution, on the eve of the discovery of America, are noteworthy; but as a scientific work it is unimportant, ranking far below the *portolani* charts of the 14th century. Its West Africa is marvellously incorrect; the Cape Verde archipelago lies hundreds of miles out of its proper place; and the Atlantic is filled with fabulous islands. Blunders of 16° are found in the localization of places the author claims to have visited: contemporary maps, at least in regard to continental features, seldom went wrong beyond 1°. It is generally agreed that Behaim had no share in Transatlantic discovery; and though Columbus and he were apparently in Portugal at the same time, no connexion between the two has been established. He died at Lisbon in 1507.

See C. G. von Murr, *Diplomatische Geschichte des berühmten Ritters Behaim* (1778); A. von Humboldt, *Kritische Untersuchungen* (1836); F. W. Ghilany, *Geschichte des Seefahrers Martin Behaim* (1853); O. Peschel, *Geschichte der Erdkunde*, 214-215, 226, 251, and *Zeitalter der Entdeckungen*, esp. p. 90; Breusing, *Zur Geschichte der Geographie* (1869); Eugen Gelcich in the *Mittheilungen* of the Vienna Geographical Society, vol. xxxvi. pp. 100, &c.; E. G. Ravenstein, *Martin de Bohemia* (Lisbon, 1900), *Martin Behaim, His Life and Voyages* (London, 1909), and *Voyages of Diogo Cão and Bartholomew Dias, 1482-1488*, in *Geographical Journal*, Dec. 1900; see also *Geog. Journal*, Aug. 1893, p. 175. Nov. 1901, p. 509; Jules Mees in *Bull. Soc. Geog.*, Antwerp, 1902, pp. 182-204; A. Ferreira de Serpa in *Bull. Soc. Geog.*, Lisbon, 1904, pp. 297-307.

BEHAR, or BIHAR, a town of British India, in the Patna district of Bengal, which gives its name to an old province, situated on the right bank of the river Panchana. Pop. (1901) 45,003. There are still some manufactures of silk and muslin, but trade has deserted Behar in favour of Patna and other places more favourably situated on the river Ganges and the railway, while the indigo industry has been ruined by the synthetic products of the German chemist, and the English colony of indigo planters has been scattered abroad.

The old province, stretching widely across the valley of the Ganges from the frontier of Nepal to the hills of Chota Nagpur, corresponds to the two administrative divisions of Patna and Bhagalpur, with a total area of 44,107 sq. m. and a population of 24,241,305. It is the most densely populated tract in India, and therefore always liable to famine; but it is now well protected almost everywhere by railways. It is a country of large landholders and formerly of indigo planters. The vernacular language is not Bengali, but a dialect of Hindu; and the people likewise resemble those of Upper India. The general aspect of the country is flat, except in the district of Monghyr, where detached hills occur, and in the south-east of the province, where the Rajmahal and Santal ranges abut upon the plains.

Behar abounds in great rivers, such as the Ganges, with its tributaries, the Ghagra, Gandak, Kusi, Mahananda and Sone. The Ganges enters the province near the town of Buxar, flows eastward and, passing the towns of Dinajpur, Patna, Monghyr and Colong, leaves the province at Rajmahal. It divides the province into two almost equal portions; north of the river lie the districts of Saran, Champaran, Tirhoot, Purnea, and part of Monghyr and Bhagalpur, and south of it are Shahabad, Patna, Gaya, the Santal parganas, and the rest of Monghyr and Bhagalpur. The Ganges and its northern tributaries are navigable by country boats of large burden all the year round. The cultivation of opium is a government monopoly, and no person is allowed to grow the poppy except on account of government. The Behar Opium Agency has its headquarters at the town of Patna.

Annual engagements are entered into by the cultivators, under a system of pecuniary advances, to sow a certain quantity of land with poppy, and the whole produce in the form of opium is delivered to government at a fixed rate.

Saltpetre is largely refined in Tirhoot, Saran and Champaran, and is exported both by rail and river to Calcutta. The manufactures of less importance are tussore-silk, paper, blankets, brass utensils, firearms, carpets, coarse cutlery and hardware, leather, ornaments of gold and silver, &c. Of minerals—lead, silver and copper exist in the Bhagalpur division, but the mines are not worked. One coal-mine is worked in the parganas. Before the construction of railways in India, the Ganges and the Grand Trunk road afforded the sole means of communication from Calcutta to the North-Western Provinces. But now the railroad is the great highway which connects Upper India with Lower Bengal. The East Indian railway runs throughout the length of the province. The climate of Behar is very hot from the middle of March to the end of June, when the rains set in, which continue till the end of September. The cold season, from October to the first half of March, is the pleasantest time of the year.

History.—The province of Behar corresponds to the ancient kingdom of Magadha, which comprised the country now included in the districts of Patna, Gaya and Shahabad, south of the Ganges. The origin of this kingdom, famous alike in the political and religious history of India, is lost in the mists of antiquity; and though the Brahmanical *Puranas* give lists of its rulers extending back to remote ages before the Christian era, the first authentic dynasty is that of the Saisunaga, founded by Sisinuga (c. 600 B.C.), whose capital was at Rajagaha (Rajgir) in the hills near Gaya; and the first king of this dynasty of whom anything is known was Bimbisara (c. 528 B.C.), who by conquests and matrimonial alliances laid the foundations of the greatness of the kingdom. It was in the reign of Bimbisara that Vardhamana Mahavira, the founder of Jainism, and Gautama, the founder of Buddhism, preached in Magadha, and Buddhist missionaries issued thence to the conversion of China, Ceylon, Tibet and Tatar. Even to this day Behar, where there are extensive remains of Buddhist buildings, remains a sacred spot in the eyes of the Chinese and other Buddhist nations.

Bimbisara was murdered by his son Ajatasatru, who succeeded him, and whose bloodthirsty policy reduced the whole country between the Himalayas and the Ganges under the suzerainty of Magadha. According to tradition, it was his grandson, Udaya, who founded the city of Pataliputra (Patna) on the Ganges, which under the Maurya dynasty became the capital not only of Magadha but of India. The remaining history of the dynasty is obscure; according to Mr Vincent Smith, its last representative was Mahanandin (417 B.C.), after whose death the throne was usurped, under obscure circumstances, by Mahapadma Nanda, a man of low caste (*Early Hist. of India*, p. 36). It was a son of this usurper who was reigning at the time of the invasion of Alexander the Great; and the conqueror, when his advance was arrested at the Hyphasis (326 B.C.), meditating an attack on Pataliputra (the Palimbothra of the Greeks), was informed that the king of Magadha could oppose him with a force of 20,000 cavalry, 200,000 infantry, 2000 chariots, and 3000 or 4000 elephants. The Nanda dynasty seems to have survived only for two generations, when (321 B.C.) Chandragupta Maurya, the founder of the great Maurya dynasty, seized the throne. This dynasty, of which the history belongs to that of India (*q.v.*), occupied the throne for 137 years. After the death of the great Buddhist king, Asoka (c. 231), the Maurya empire began to break up, and it was finally destroyed about fifty years later when Pushyamitra Sunga murdered the Maurya king Brihadratha and founded the Sunga dynasty. Descendants of Asoka continued, however, to subsist in Magadha as subordinate rajas for many centuries; and as late as the 8th century A.D. petty Maurya dynasties are mentioned as ruling in Konkan. The reign of Pushyamitra, who held his own against Menander and succeeded in establishing his claim to be lord paramount of northern India, is mainly remarkable as marking the beginning

of the Brahmanical reaction and the decline of Buddhism; according to certain Buddhist writers the king, besides reviving Hindu rites, indulged in a savage persecution of the monks. The Sunga dynasty, which lasted 112 years, was succeeded by the Kanva dynasty, which after 45 years was overthrown (c. 27 B.C.) by the Andhras or Satavahanas. In A.D. 236 the Andhras were overthrown, and, after a confused and obscure period of about a century, Chandragupta I. established his power at Pataliputra (A.D. 320) and founded the famous Gupta empire (see GUPTA), which survived till it was overthrown by the Ephthalites (q.v.), or White Huns, at the close of the 5th century. In Magadha itself the Guptas continued to rule as tributary princes for some centuries longer. About the middle of the 8th century Magadha was conquered by Gopala, who had made himself master in Bengal, and founded the imperial dynasty known as the Palas of Bengal. They were zealous Buddhists, and under their rule Magadha became once more an active centre of Buddhist influence. Gopala himself built a great monastery at Udandapura, or Otantapuri, which has been identified by Sir Alexander Cunningham with the city of Behar, where the later Pala kings established their capital. Under Mahipala (c. 1026), the ninth of his line, and his successor Nayapala, missionaries from Magadha succeeded in firmly re-establishing Buddhism in Tibet.

In the 11th century the Pala empire, which, according to the Tibetan historian Taranath, extended in the 9th century from the Bay of Bengal to Delhi and Jalandhar (Jullundur) in the north and the Vindhyan range in the south, was partly dismembered by the rise of the "Sena" dynasty in Bengal; and at the close of the 12th century both Palas and Senas were swept away by the Mahomedan conquerors, the city of Behar itself being captured by the Turki fee-lance Mahomed-i-Bakhtyar Khilji in 1103, by surprise, with a party of 200 horsemen. "It was discovered," says a contemporary Arab historian, "that the whole of that fortress and city was a college, and in the Hindi tongue they call a college Bihar." Most of the monks were massacred in the first heat of the assault; those who survived fled to Tibet, Nepal and the south. Buddhism in Magadha never recovered from this blow; it lingered in obscurity for a while and then vanished.

Behar now came under the rule of the Mahomedan governors of Bengal. About 1330 the southern part was annexed to Delhi, while north Behar remained for some time longer subject to Bengal. In 1397 the whole of Behar became part of the kingdom of Jaunpur; but a hundred years later it was annexed by the Delhi emperors, by whom—save for a short period—it continued to be held. The capital of the province was established under the Moguls at the city of Behar, which gave its name to the province. From the middle of the 14th to the middle of the 16th century a large part of Behar was ruled by a line of Brahman tributary kings; and in the 15th century another Hindu dynasty ruled in Champaran and Gorakhpur. Behar came into the possession of the East India Company with the acquisition of the Dibrāni in 1765, when the province was united with Bengal. In 1857 two zemindārs, Umar Singh and Kumār Singh, rebelled against the British government, and for some months held the ruinous fort of Rohtās against the British.

See *Imperial Gazetteer of India* (Oxford, 1908), s.v. "Bihar" and "Bengal"; V. A. Smith, *Early History of India* (2nd ed., Oxford, 1908).

BEHĀ UD-DĪN [ABŪ-L-MAḤASIN YŪSUF IBN RAḤĪF IBN SHADDĀD BEHĀ UD DĪN] (1145-1234), Arabian writer and statesman, was born in Mosul and early became famous for his knowledge of the Koran and of jurisprudence. Before the age of thirty he became teacher in the great college at Bagdad known as the Niẓāmiyya, and soon after became professor at Mosul. In 1187, after making the pilgrimage to Mecca, he visited Damascus. Saladin, who was at the time besieging Kaukab (a few miles south of Tiberias), sent for him and became his friend. Behā ud-Dīn observed that the whole soul of the monarch was engrossed by the war which he was then engaged in waging against the enemies of the faith, and saw that the only mode of acquiring his favour

was by urging him to its vigorous prosecution. With this view he composed a treatise on *The Laws and Discipline of Sacred War*, which he presented to Saladin, who received it with peculiar favour. From this time he remained constantly attached to the person of the sultan, and was employed on various embassies and in departments of the civil government. He was appointed judge of the army and judge of Jerusalem. After Saladin's death Behā ud-Dīn remained the friend of his son Malik uz-Zāhir, who appointed him judge of Aleppo. Here he employed some of his wealth in the foundation of colleges. When Malik uz-Zāhir died, his son Malik ul-'Aziz was a minor, and Behā ud-Dīn had the chief power in the regency. This power he used largely for the patronage of learning. After the abdication of Malik ul-'Aziz, he fell from favour and lived in retirement until his death in 1234. Behā ud-Dīn's chief work is his *Life of Saladin* (published at Leiden with Latin translation by A. Schultens in 1732 and 1755). An English translation was published by the Palestine Pilgrims' Text Society, London, 1897.

For list of other extant works see C. Brockelmann, *Geschichte der arabischen Literatur* (Weimar, 1898), vol. i. pp. 316 f. (G. W. T.)

BEHĀ UD-DĪN ZUHĀIR (ABŪ-L-FAḌL ZUHĀIR IDN MAḤMŪD AL-MUHALLĀBĪ) (1186-1258), Arabian poet, was born at or near Mecca, and became celebrated as the best writer of prose and verse and the best calligraphist of his time. He entered the service of Malik uz-Sālih Najm ud-Dīn in Mesopotamia, and was with him at Damascus until he was betrayed and imprisoned. Behā ud-Dīn then retired to Nabūṣ (Shechem) where he remained until Najm ud-Dīn escaped and obtained possession of Egypt, whither he accompanied him in 1240. There he remained as the sultan's confidential secretary until his death, due to an epidemic, in 1258. His poetry consists mostly of panegyric and brilliant occasional verse distinguished for its elegance. It has been published with English metrical translation by E. H. Palmer (2 vols., Cambridge, 1877).

His life was written by his contemporary Ibn Khallikān (see M.G. de Slane's trans. of his *Biographical Dictionary*, vol. i. pp. 542-545). (G. W. T.)

BEHBĀHAN, a walled town of Persia in the province of Fars, pleasantly situated in the midst of a highly cultivated plain, 128 m. W.N.W. of Shiraz and 3 m. from the left bank of the river Tab, here called Kurdistān river. It is the capital of the Kuhgilu-Behbahan sub-province of Fars and has a population of about 10,000. The walls are about 3 m. in circumference and a Narinj Kalah (citadel) stands in the south-east corner. At a short distance north-west of the city are the ruins of Arrajan, the old capital of the province.

BEHEADING, a mode of executing capital punishment (q.v.). It was in use among the Greeks and Romans, and the former, as Xenophon says at the end of the second book of the *Anabasis*, regarded it as a most honourable form of death. So did the Romans, by whom it was known as *decollatio* or *capitis amputatio*. The head was laid on a block placed in a pit dug for the purpose, —in the case of a military offender, outside the intrenchments, in civil cases outside the city walls, near the *porta decumana*. Before execution the criminal was tied to a stake and whipped with rods. In earlier years an axe was used; afterwards a sword, which was considered a more honourable instrument of death, and was used in the case of citizens (*Dig.* 48, 19, 28). It was with a sword that Cicero's head was struck off by a common soldier. The beheading of John the Baptist proves that the tetrarch Herod had adopted from his suzerain the Roman mode of execution. Suetonius (*Calig.* c. 32) states that Caligula kept a soldier, an artist in beheading, who in his presence decapitated prisoners fetched indiscriminately for that purpose from the gaols.

Beheading is said to have been introduced into England from Normandy by William the Conqueror. The first person to suffer was Waltheof, earl of Northumberland, in 1076. An ancient MS. relating to the earls of Chester states that the sergeants or bailiffs of the earls had power to behead any malefactor or thief, and gives an account of the presenting of several heads of felons

at the castle of Chester by the earl's serjeant. It appears that the custom also attached to the barony of Malpas. In a roll of 3 Edward II., beheading is called the "custom of Cheshire" (Lysons' *Cheshire*, p. 299, from Harl. MS. 2009 fol. 34b). The liberty of Hardwick, in Yorkshire, was granted the privilege of beheading thieves. (See GULLOTINE.)

But with the exceptions above stated beheading was usually reserved as the mode of executing offenders of high rank. From the 15th century onward the victims of the axe include some of the highest personages in the kingdom: Archbishop Scrope (1405); duke of Buckingham (1483); Catherine Howard (1542); earl of Surrey (1547); duke of Somerset (1552); duke of Northumberland (1553); Lady Jane Grey (1554); Lord Guildford Dudley (1554); Mary queen of Scots (1587); earl of Essex (1601); Sir Walter Raleigh (1618); earl of Strafford (1641); Charles I. (1649); Lord William Russell (1683); duke of Monmouth (1685); earl of Derwentwater (1716); earl of Kenmore (1716); earl of Kilmarnock and Lord Balmerino (1746); and the list closes with Simon, Lord Lovat, who (9th of April 1747) was the last person beheaded in England. The execution of Anne Boleyn was carried out not with the axe, but with a sword, and by a French headsman specially brought over from Calais. In 1644 Archbishop Laud was condemned to be hanged, and the only favour granted him, and that reluctantly, was that his sentence should be changed to beheading. In the case of the 4th Earl Ferrers (1760) his petition to be beheaded was refused and he was hanged.

Executions by beheading usually took place on Tower Hill, London, where the scaffold stood permanently during the 15th and 16th centuries. In the case of certain state prisoners, e.g. Anne Boleyn and Lady Jane Grey, the sentence was carried out within the Tower on the green by St Peter's chapel.

Beheading was only a part of the common-law method of punishing male traitors, which was ferocious in the extreme. According to Walcot's case (1696), 1 *Eng. Rep.* 89, the proper sentence was "quod . . . ibidem super bigam (herdillum) ponatur et abinde usque ad furcas de [Tyburn] trahatur, et ibidem per collum suspendatur et vivus ad terram prosteratur et quod secreta membra ejus amputentur, et interiora sua intra venterum suum capiantur et in ignem ponantur et ibidem *ipso vivente* comburantur, et quod caput ejus amputetur, quodque corpus ejus in quatuor partes dividatur et illo ponantur ubi dominus rex eas assignare voluit." There is a tradition that Harrison the regicide after being disembowelled rose and boxed the ears of the executioner.

In Townley's case (18 Howell, *State Trials*, 350, 351) there is a ghastly account of the mode of executing the sentence; and in that case the executioner cut the traitor's throat. In the case of the Cato Street conspiracy (1820, 33 Howell, *State Trials*, 1566), after the traitors had been hanged as directed by the act of 1814, their heads were cut off by a man in a mask whose dexterity led to the belief that he was a surgeon.

Female traitors were until 1790 liable to be drawn to execution and burnt alive. In that year hanging was substituted for burning.

In 1814 so much of the sentence as related to disembowelling and burning the bowels was abolished and the king was empowered by royal warrant to substitute decapitation for hanging, which was made by that act the ordinary mode of executing traitors. But it was not till 1870 that the portions of the sentence as to drawing and quartering were abolished (Forfeiture Act 1870).

The more barbarous features of the execution were remitted in the case of traitors of high rank, and the offender was simply decapitated.

The block usually employed is believed to have been a low one such as would be used for beheading a corpse. C. H. Firth and S. R. Gardiner incline to the view that such a block was the one used at Charles I.'s execution. The more general custom, however, seems to have been to have a high block over which the victim knelt. Such is the form of that preserved in the armoury of the Tower of London. This is undoubtedly the block upon which Lord Lovat suffered, but, in spite of several

axe-cuts on it, probably not one in early use. The axe which stands beside it was used to behead him and the other Jacobite lords, but no certainty exists as to its having been previously employed. On the ground floor of the King's House, at the Tower, is preserved the processional axe which figured in the journeys of state prisoners to and from their trials, the edge turned from them as they went, but almost invariably turned towards them as they returned to the Tower. The axe's head is peculiar in form, 1 ft. 8 in. high by 10 in. wide, and is fastened into a wooden handle $\frac{3}{4}$ ft. 4 in. long. The handle is ornamented by four rows of burnished brass nails.

In Scotland they did not behead with the axe, nor with the sword, as under the Roman law, and formerly in Holland and France, but with the maiden (*g.a.*).

Capital punishment is executed by beheading in France, and in Belgium by means of the guillotine.

In Germany the instrument used varies in different states: in the old provinces of Prussia the axe, in Saxony and Rhenish Prussia the guillotine. Until 1851 executions were public. They now take place within a prison in the presence of certain specified officials.

Beheading is also the mode of executing capital punishment in Denmark and Sweden. The axe is used. In Sweden the execution takes place on the order of the king within a prison in the presence of certain specified officials and, if desired, of twelve representatives of the commune within which the prison is situate (Code 1864, s. 2, Royal Ordinance 1877).

In the Chinese empire decapitation is the usual mode of execution. By an imperial edict (24th of April 1905) certain attendant barbarities have been suppressed: viz. slicing, cutting up the body, and exhibiting the head to public view (32 *Clunet*, 1175).

BEHEMOTH (the intensive plural of the Hebrew *b'hemah*, a beast), the animal mentioned in the book of Job (ch. xl. 15), probably the hippopotamus, which in ancient times was found in Egypt below the cataracts of Syene. The word may be used in Job as typical of the primeval king of land animals, as levithan of the water animals. The modern use expresses the idea of a very large and strong animal.

BEHISTUN, or **BISUTUN**, now pronounced *Bisutun*, a little village at the foot of a precipitous rock, 1700 ft. high, in the centre of the Zagros range in Persia on the right bank of the Samas-Ab, the principal tributary of the Kerka (Choaspes). The original form of the name, Bagistana, "place of the gods" or "of God" has been preserved by the Greek authors Stephanus of Byzantium, and Diodorus (ii. 13), the latter of whom says that the place was sacred to Zeus, *i.e.* Ahuramazda (Ormuzd). At its foot passes the great road which leads from Babylonia (Bagdad) to the highlands of Media (Ecbatana, Hamadan). On the steep face of the rock, some 500 ft. above the plain, Darius I., king of Persia, had engraved a great cuneiform inscription (11 or 12 ft. high), which recounts the way in which, after the death of Cambyses, he killed the usurper Gaumata (in Justin Gometes, the pseudo-Smerdis), defeated the numerous rebels, and restored the kingdom of the Achaemenidae. Above the inscription the picture of the king himself is graven, with a bow in his hand, putting his left foot on the body of Gaumata. Nine rebel chiefs are led before him, their hands bound behind them, and a rope round their necks; the ninth is Skunka, the chief of the Scythians (Sacae) whom he defeated. Behind the king stand his bow-bearer and his lance-bearer; in the air appears the figure of the great god Ahuramazda, whose protection led him to victory.¹ The inscriptions are composed in the three languages which are written with cuneiform signs, and were used in all official inscriptions of the Achaemenian kings: the chief place

¹ A passage in the inscription runs:—"Thus saith Darius the king: That which I have done I have done altogether by the grace of Ahuramazda. Ahuramazda, and the other gods that be, brought aid to me. For this reason did Ahuramazda, and the other gods that be, bring aid to me, because I was not hostile, nor a liar, nor a wrongdoer, neither I nor my family, but according to Rectitude (*arštam*) have I ruled." (A. V. Williams Jackson, *Persia, Past and Present*.)

is of course given to the Persian language (in four columns); the three Susian (Elamitic) columns lie to the left, and the Babylonian text is on a slanting boulder above them; a part of the Babylonian has been destroyed by a torrent, which has made its way over it. In former times the second language has often been called Scythian, Turanian or Median; but we now know from numerous inscriptions of Susa that it is the language of Elam which was spoken in Susa, the capital of the Persian empire.

In 1835 the difficult and almost inaccessible cliff was first climbed by Sir Henry Rawlinson, who copied and deciphered the inscriptions (1835-1845), and thus completed the reading of the old cuneiform text and laid the foundation of the science of Assyriology. Diodorus ii. 13 (cf. xvii. 110), probably following a later author who wrote the history of Alexander's campaigns, mentions the sculptures and inscriptions, but attributes them to Semiramis. At the foot of the rock are the remains of some other sculptures (quite destroyed), the fragments of a Greek inscription of the Parthian prince Gotarzes (A.D. 40; text in Dittenberger, *Orientalis graeci inscr. selectae*, no. 431), and of an Arabic inscription.

See Sir Henry Rawlinson in the *Journ. R. Geog. Soc.* ix., 1839; *J. R. Asiatic Soc.* x. 1866, xv., 1863, xv., 1865; *Archaeologia*, xxvii., 1852; Sir R. Ker Porter, *Travels*, ii. 149 ff.; Flacind and Coste, *Voyage en Perse*, i. pl. 16; and the modern editions of the inscriptions, the best of which, up to the end of the 19th century, were: Weissbach and Bang, *Die altpersischen Keilschriften* (1893); Weissbach, *Die Achaemenideninschriften zweiter Art* (1890); Bezold, *Die (babylonischen) Achaemenideninschriften* (1882). A description of the locality, with comments on the present state of the inscriptions and doubtful passages of the Persian text, was given by Dr A. V. Williams Jackson in the *Journal of the American Oriental Society*, xvii., 1903, and in his *Persia, Past and Present* (1906). Dr Jackson in 1903 climbed to the ledge of the rock and was able to collate the lower part of the four large Persian columns; he thus convinced himself that Poy's conjecture of *aršām* ("righteousness") for Rawlinson's *aršām* or *aršām* was correct. A later investigation was carried out in 1904 on the instructions of the British Museum Trustees by Messrs. L. W. King and R. C. Thompson, who published their results in 1907 under the title, *The Inscription of Darius the Great at Behistūn*, including a full illustrated account of the sculptures and the inscription, and a complete collation of the text. (ED. M.)

BEHN, APHRA (otherwise AFRA, APHARA or AYFARA) (1640-1689), British dramatist and novelist, was baptized at Wye, Kent, in 1640. Her father, John Johnson, was a barber. While still a child she was taken out to Surinam, then an English possession, from which she returned to England in 1658, when it was handed over to the Dutch. In Surinam Aphra learned the history, and acquired a personal knowledge of the African prince Oroonoko and his beloved Imoinda, whose adventures she has related in her novel, *Oroonoko*. On her return she married Mr Behn, a London merchant of Dutch extraction. The wit and abilities of Mrs Behn brought her into high estimation at court, and—her husband having died by this time—Charles II. employed her on secret service in the Netherlands during the Dutch war. At Antwerp she successfully accomplished the objects of her mission; and in the latter end of 1666 she wormed out of one Van der Aalbert the design formed by De Ruyter, in conjunction with the DeWitts, of sailing up the Thames and burning the English ships in their harbours. This she communicated to the English court, but although the event proved her intelligence to have been well founded, it was at the time disregarded. Disgusted with political service, she returned to England, and from this period she appears to have supported herself by her writings. Among her numerous plays are *The Forced Marriage*, or *the Jealous Bridegroom* (1671); *The Amorous Prince* (1671); *The Town Fop* (1677); and *The Rover*, or *the Banished Cavalier* (in two parts, 1677 and 1681); and *The Roundheads* (1682). The coarseness that disfigures her plays was the fault of her time; she possessed great ingenuity, and showed an admirable comprehension of stage business, while her wit and vivacity were un-failing. Of her short tales, or novelettes, the best is the story of *Oroonoko*, which was made the basis of Thomas Southerne's popular tragedy. Mrs Behn died on the 16th of April 1689, and was buried in the cloisters of Westminster Abbey.

See *Plays written by the Late Ingenious Mrs Behn* (1702; reprinted, 1871); also "Aphra Behn's Gedichte und Prosaerwerke," by P. Siegel in *Anglia* (Halle, vol. xxv., 1902, pp. 86-128, 329-385); and A. C. Swinburne's essay on "Social Verse" in *Studies in Prose and Poetry* (1894).

BEHR, WILLIAM JOSEPH (1775-1851), German publicist and writer, was born at Salzhelm on the 26th of August 1775. He studied law at Würzburg and Göttingen, became professor of public law in the university of Würzburg in 1799, and in 1819 was sent as a deputy to the *Landtag* of Bavaria. Having associated himself with the party of reform, he was regarded with suspicion by the Bavarian king Maximilian I. and the court party, although favoured for a time by Maximilian's son, the future King Louis I. In 1821 he was compelled to give up his professorship, but he continued to agitate for reform, and in 1831 the king refused to recognize his election to the *Landtag*. A speech delivered by Behr in 1832 was regarded as seditious, and he was arrested. In spite of his assertion of loyalty to the principle of monarchy he was detained in custody, and in 1836 was found guilty of seeking to injure the king. He then admitted his offence; but he was not released from prison until 1839, and the next nine years of his life were passed under police supervision at Passau and Regensburg. In 1848 he obtained a free pardon and a sum of money as compensation, and was sent to the German national assembly which met at Frankfurt in May of that year. He passed his remaining days at Bamberg, where he died on the 1st of August 1851. Behr's chief writings are: *Darstellung der Bedürfnisse, Wünsche und Hoffnungen deutscher Nation* (Aschaffenburg, 1816); *Die Verfassung und Verwaltung des Staates* (Nuremberg, 1811-1812); *Von den rechtlichen Grenzen der Einwirkung des Deutschen Bundes auf die verfassung, Gesetzgebung, und Rechtspflege seiner Gliederstaaten* (Stuttgart, 1820).

BEIRA, a seaport of Portuguese East Africa, at the mouth of the Pungwe river, in 19° 50' S., 34° 50' E., 488 m. N. of Delagoa Bay, in communication by railway with Cape Town via Umtali, Salisbury and Bulawayo. Pop. about 4000, of whom a third are Europeans, and some 300 Indians. The town is built on a tongue of sand extending into the river, and is comparatively healthy. The sea front is protected by a masonry wall, and there are over 13,000 ft. of wharfage. Vessels drawing 24 ft. can enter the port at high tide. Between the customs house and the railway terminus is the mouth of a small river, the Chiveve, crossed by a steel bridge, the centre span revolving and giving two passages each of 40 ft. The town is without any architectural pretensions, but possesses fine public gardens. It is the headquarters of the Companhia de Moçambique, which administers the Beira district under charter from the Portuguese crown. The business community is largely British.

Beira occupies the site of a forgotten Arab settlement. The present port sprang into being as the result of a clause in the Anglo-Portuguese agreement of 1891 providing for the construction of a railway between Rhodesia and the navigable waters of the Pungwe. The railway at first began at Fontesville, about 50 m. by river above Beira, but was subsequently brought down to Beira. The completion in 1902 of the line connecting Salisbury with Cape Town adversely affected the port of Beira, the long railway route from the Cape being increasingly employed by travellers to and from Mashonaland. Moreover, the high freights on goods by the Beira route enabled Port Elizabeth to compete successfully for the trade of Rhodesia. In October 1905 a considerable reduction was made in railway rates and in port dues and customs, with the object of re-attracting to the port the transit trade of the interior, and in 1907 a branch of the Rhodesian customs was opened in the town. In that year goods valued at £647,000 passed through the port to Rhodesia. Efforts were also made to develop the agricultural and mineral resources of the Beira district itself. The principal exports are rubber, sugar, ground-nuts and oil seeds, beeswax, chromite (from Rhodesia), and gold (from Manica). The imports are chiefly rice (from India) and cotton goods for local use, and food stuffs, machinery, hardware and manufactured goods for Rhodesia. For the three years, 1905-1907, the average annual value of the

imports and exports, excluding the transit trade with Rhodesia, was, imports £200,000, exports £90,000. Direct steamship communication with Europe is maintained by German and British lines.

See PORTUGUESE EAST AFRICA; also the reports issued yearly by the British Foreign Office on the trade of Beira.

BEIRA, an ancient principality and province of northern and central Portugal; bounded on the N. by Entre Minho e Douro and by Traz os Montes, E. by the Spanish provinces of Leon and Estremadura, S. by Alemtejo and (Portuguese Estremadura, and W. by the Atlantic Ocean. Pop. (1900) 1,515,834; area, 9208 sq. m. Beira is administratively divided into the districts of Aveiro, Coimbra, Vizeu, Guarda and Castello Branco, while it is popularly regarded as consisting of the three sections—Beira Alta or Upper Beira (Vizeu), north and west of the Serra da Estrela; Beira Baixa or Lower Beira (Guarda and Castello Branco), south and east of that range; and Beira Mar or Maritime Beira (Aveiro and Coimbra), coinciding with the former coastal province of Douro. The coast line, about 72 m. long, is uniformly flat, with long stretches of sandy pine forest, heath or marshland bordered by a wide and fertile plain. Its most conspicuous features are the lagoon of Aveiro (*g.a.*) and the bold headland of Cape Mondego; in the south Aveiro, Murtoza, Ovar and Figueira da Foz are small seaports. Except along the coast, the surface is for the most part mountainous,—the highest point in the Serra da Estrela, which extends from north-east to south-west through the centre of the province, being 6532 ft. The northern and south-eastern frontiers are respectively marked by the two great rivers Douro and Tagus, which rise in Spain and flow to the Atlantic. The Agueda and Côa, tributaries of the Douro, drain the eastern plateaus of Beira; the Vouga rises in the Serra da Lapa, and forms the lagoon of Aveiro at its mouth; the Mondego springs from the Serra da Estrela, passes through Coimbra, and enters the sea at Figueira da Foz; and the *Zezere*, a tributary of the Tagus, rises north-north-east of Covilhã and flows south-west and south.

Beira has a warm and equable climate, except in the mountains, where the snowfall is often heavy. The soil, except in the valleys, is dry and rocky, and large stretches are covered with heath. The principal agricultural products are maize, wheat, garden vegetables and fruit. The olive is largely cultivated, the oil forming one of the chief articles of export; good wine is also produced. In the flat country between Coimbra and Aveiro the marshy land is laid out in rice-fields or in pastures for herds of cattle and horses. Sheep farming is an important industry in the highlands of Upper Beira; while near Lamego swine are reared in considerable numbers, and furnish the well-known Lisbon hams. Iron, lead, copper, coal and marble are worked to a small extent, and millstones are quarried in some places. Salt is obtained in considerable quantities from the lagoons along the coast. There are few manufactures except the production of woollen cloth, which occupies a large part of the population in the district of Castello Branco. Three important lines of railway, the Salamanca-Oporto, Salamanca-Lisbon and Lisbon-Oporto, traverse parts of Beira; the two last named are also connected by the Guarda-Figueira da Foz railway, which has a short branch line going northwards to Vizeu. The chief towns, Aveiro (pop. 1900, 9979), Castello Branco (7288), Coimbra (18,144), Covilhã (15,469), Figueira da Foz (6221), Ovar (6124), Ilhavo (12,617), Lamego (9471), Murtoza (9737), Guarda (10,462) and Vizeu (8057), with the frontier fortress of Almeida (2330), are described in separate articles. There is a striking difference of character between the inhabitants of the highlands, who are grave and reserved, hardy and industrious, and those of the lowlands, who are more sociable and courteous, but less energetic. The heir-apparent to the throne of Portugal has the title of prince of Beira.

BEIRUT or **BEIRUT**. (1) A vilayet of Syria, constituted as recently as 1888, which stretches along the sea-coast from Jebel el-Akra, south of the Orontes, to the Nahr Zerka, south of Mount Carmel, and towards the south extends from the Mediterranean to the Jordan. It includes five *sanjaks*, Latakia,

Tripoli, Beirut, Acre and Buka'a. (2) The chief town of the vilayet (anc. *Berytus*), the most important seaport town in Syria, situated on the south side of St George's Bay, on rising ground at the foot of Lebanon. Pop. 120,000 (Moslems, 36,000; Christians, 77,000; Jews, 2500; Druses, 400; foreigners, 4100). Berytus, whether it is to be identified with Hebrew *Berothai* or not (2 Sam. viii. 8; Ezek. xlvii. 16), was one of the most ancient settlements on the Phœnician coast; but nothing more than the name is known of it till B.C. 140, when the town was taken and destroyed by Tryphon in his contest with Antiochus VII. for the throne of the Seleucids. It duly passed under Rome, was much favoured by the Herods and became a *colonia*. It was famous for its schools, especially that of law, from the 4th century A.D. onwards. Justinian recognized it as one of the three official law schools of the empire (A.D. 533), but within a few years, as the result of a disastrous earthquake (551), the students were transferred to Sidon. In the following century it passed to the Arabs (635), and was not again a Christian city till 1111, when Baldwin captured it. Saladin retook it in 1187, and thenceforward, for six centuries and a half, whoever its nominal lords may have been, Saracen, Crusader, Mameluke or (from the 16th century) Turk, the Druse emirs of Lebanon dominated it (see DRUSES). One of these, Fakr ed-Din Maan II., fortified it early in the 17th century; but the Turks asserted themselves in 1763 and occupied the place. During the succeeding epoch of rebellion at Acre under Jezzar and Abdullah pashas, Beirut declined to a small town of about 10,000 souls, in dispute between the Druses, the Turks and the pashas,—a state of things which lasted till Ibrahim Pasha captured Acre in 1832. When the powers moved against the Egyptians in 1840, Beirut had recently been occupied in force by Ibrahim as a menace to the Druses; but he was easily driven out after a destructive bombardment by Admiral Sir Robert Stopford (1768-1847). Since the pacification of the Lebanon after the massacre of the Christians in 1860 (for later history, see LEBANON), Beirut has greatly increased in extent, and has become the centre of the transit trade for all southern Syria. In 1804 a harbour, constructed by a French company, was opened, but the insecurity of the outer roadstead militates against its success. Nevertheless trade is on the increase. In 1895 a French company completed a railway across the Lebanon to Damascus, and connected it with Mezerib in the Hauran, whence now starts the line to the Hejaz. Since 1907 it has also had railway communication with Aleppo; and a narrow-gauge line runs up the coast to Tripoli. The steepness of the Lebanon railway, and the break of gauge at Rayak, the junction for Aleppo, have prevented the diversion of much of the trade of North Syria to Beirut. The town has been supplied with water, since 1875, by an English company, and with gas, since 1888, by a French company. There are many American and European institutions in the city: the American Presbyterian mission, with a girls' school and a printing office, which published the Arabic translation of the Bible, and now issues a weekly paper and standard works in Arabic; the Syrian Protestant college with its theological seminary, medical faculty, training college and astronomical observatory; the Scottish mission, and St George's institute for Moslem and Druse girls; the British Syrian mission schools; the German hospital, orphanage and boarding school; the French hospital and schools, and the Jesuit "Université de St Joseph" with a printing office. In summer most of the richer residents reside on the Lebanon, and in winter the governor of the Lebanon and many Lebanon notables inhabit houses in Beirut. The town has many fine houses, but the streets are unpaved and the bazaars mean. The Moslem inhabitants, being in a minority, have often shown themselves fanatical and turbulent. There are several fairly good hotels for tourists. (C. W. W.; D. G. H.)

BEIT, ALFRED (1853-1906), British South African financier, was the son of a well-to-do merchant of Hamburg, Germany, and in 1875, after a commercial education at home, was sent out to Kimberley, South Africa, to investigate the diamond prospects. He had relatives, the Lipperts, out there in business, and in conjunction with Mr (afterwards Sir) Julius Wernher

(b. 1850) he rapidly acquired a leading position on the diamond fields, and became closely allied with the ideals of Cecil Rhodes (q.v.). In 1880 Rhodes and Beit effected the amalgamation of various interests in the De Beers Consolidated Mines Limited. It was largely owing to the capital and enterprise of Beit that the deep-level mining in the Witwatersrand district of the Transvaal was started, and he had a large share in the principal company, the Rand Mines Limited. The firm of Wernher, Beit & Co. gradually transferred the centre of their financial operations to London, where they became the leading house in the dealings in South African mines. The rapid progress made in developing the diamond and gold output made Beit a man of enormous wealth, and he utilized it lavishly in pursuit of Rhodes's South African policy. He was one of the original directors of the British South Africa company, and was included with Rhodes in the censure passed by the House of Commons Commission of Inquiry on the Jameson Raid (1896). He was subsequently one of Rhodes's trustees. Personally of a modest, gentle, generous and retiring disposition, and strongly imbued with Rhodes's ideas of British imperialism, he was one of the South African millionaires of German birth against whom the anti-imperialist section in England were never tired of employing their sarcastic invective. But though shrinking from ostentation in any form, his purse was continually opened for public objects, notably his support of the Imperial Light Horse and Imperial Yeomanry in the South African War of 1899-1902, and his endowment of the professorship of colonial history at Oxford (1905). He gave £100,000 to establish a university in his native city of Hamburg and £200,000 for a university in Johannesburg. He built a fine house in Park Lane, London, but was never prominent in social life. He died, unmarried, on the 16th of July 1906.

BEJA (or Bija), the name under which is comprised a widespread family of tribes, usually classed as Hamitic. They may, however, represent very early Semitic immigrants (see HAMITIC RACES). When first recorded the Beja occupied the whole region between the Nile and the Red Sea from the border of Upper Egypt to the foot of the Abyssinian plateau. They were known to the ancient Egyptians, upon whose monuments they are represented. They are the Blemmyes of Strabo (xvii. 53), and have also been identified with the Macrobii of Herodotus, "tallest and finest of men" (iii. 17). It has been suggested, though on insufficient grounds, that the Beja, rather than the Abyssinians, are the "Ethiophians" of Herodotus, the civilized people who built the city of Meroë and its pyramids. During the Roman period the Beja were much what they are to-day, nomadic and aggressive, and were constantly at war. In 216 A.H. (A.D. 832) the Moslem governor of Assuan made a treaty with the Beja chief, by which the latter undertook to guard the road to Aidhab and pay an annual tribute of one hundred camels. This is the earliest record of a government engagement with the northern section of the Beja, now the Abāhda. Ibn Batuta, early in the 14th century, mentions a king of Beja, El Hadrabi, who received two-thirds of the revenue of Aidhab, the other third going to the king of Egypt. The Beja territory contained gold and emerald mines. The tribesmen were the usual escort for pilgrims to Mecca from Kus to Aidhab. According to Leo Africanus, at the close of the 14th or very early in the 15th century their rich town of Zibid (Aidhab?) on the Red Sea was destroyed. This seems to have broken up the tribal cohesion. Leo Africanus describes the Beja as "most base, miserable and living only on milk and camels' flesh." In the middle ages the Beja, partially at any rate, were Christians. The kingdom of Meroë was succeeded by that of "Aloa," the capital of which, Soba, was on the Blue Nile, about 13 m. above Khartum. The country was conquered by the Fanj (q.v.), a negroid people who subsequently became Mahomedan and compelled the Beja to adopt that religion. Until the invasion of the Egyptians, under Ismail, son of Mehemet Ali (1820), the Fanj remained in possession.

All the Beja are now Mahomedans, but generally only so in name, though some of the tribes enthusiastically fought for Mahdiism (1883-99). As a race the Beja are remarkable for

physical beauty, with a colour more red than black, and of a distinctly Caucasian type of face. The chiefs are, as a rule, of much fairer complexion than the tribesmen. In spite of their claim to Arab origin, the tribes have preserved many negro customs in the matter of costume and scarring the body. Their hair-dressing is very characteristic. The hair, worn thick as a protection against the sun, is parted in a circle round the head on a level with the eyes, above which the hair, saturated with mutton fat or butter, is trained straight up like a mop, with separate tufts at sides and back. Most of the tribes are nomadic shepherds, driving their cattle from pasture to pasture; some few are occupied in agriculture.

They are polygynous, but, unlike the Arabs, great independence is granted their women. Among most of the Beja peoples the wife can return to her mother's tent whenever she likes, and after a birth of a child she can repudiate the husband, who must make a present to be re-accepted. Cases are said to have occurred where the woman has thus obtained all her husband's possessions. The whole social position of the Beja women points, indeed, to an earlier matriarchal system. Among some of the tribes the custom of the "fourth day free" is observed, by which the women are only considered married for so many days a week, forming what liaisons they please on the odd day. The chief Beja tribes are the Abābda, Bishārin, Hadendoa, Beni-Amer, Amarar, Shukuria, Hallenga and Hamran.

BEJA (probably the ancient *Pax Julia*), the capital of an administrative district formerly included in the province of Alemtejo, Portugal; situated 95 m. S.S.E. of Lisbon by the Lisbon-Faro railway, and at the head of a branch line to Pias e Orada (3855), 26 m. E. Pop. (1900) 8885. Beja is an episcopal city, built on an isolated hill, and partly enclosed by walls of Roman origin; on the south it has a fine Roman gateway. Its cathedral is modern, but the citadel, with its beautiful Gothic tower of white marble, was founded by King Diniz (1279-1325). The city is surrounded by far-reaching plains, known as the Campo de Beja, and devoted partly to the cultivation of grain and fruit, partly to the breeding of cattle and pigs; copper, iron and manganese are also mined to a small extent, and Beja is the central market for all these products. Cloth, pottery and olive oil are manufactured in the city.

The administrative district of Beja, the largest and most thinly-populated district in Portugal, coincides with the southern part of Alemtejo (q.v.); pop. (1900) 163,612; area, 3958 sq. m.; 41·3 inhabitants per sq. m.

BEJAN (Fr. *béjaune*, from *bec jaune*, "yellow beak," in allusion to unfledged birds; the equivalent to Ger. *Gelbschnabel*, Fr. *blanc-bec*, a greenhorn), a term for freshmen, or undergraduates of the first year, in the Scottish universities. The phrase was introduced from the French universities, where the levying of *bejannium* "footing-money" had been prohibited by the statutes of the university of Orleans in 1365 and by those of Toulouse in 1401. In 1493 the election of an *Abbas Béjanorum* (Abbot of the Freshmen) was forbidden in the university of Paris. In the German and Austrian universities the freshman was called *beanus*. In Germany the freshman was anciently called a *Pennal* (from Med. Lat. *pennale*, a box for pens), in allusion to the fact that the newly-arrived student had to carry such for the older pupils. Afterwards *Fuchs* (fox) was substituted for *Pennal*, and then *Goldfuchs*, because he is supposed still to have a few gold coins from home.

BÉJART, the name of several French actors, children of Marie Hervé and Joseph Béjart (d. 1643), the holder of a small government post. The family—there were eleven children—was very poor and lived in the Marais, then the theatrical quarter of Paris. One of the sons, JOSEPH BÉJART (c. 1617-1650), was a strolling player and later a member of Molière's first company (l'Illustre Théâtre), accompanied him in his theatrical wanderings, and was with him when he returned permanently to Paris, dying soon after. He created the parts of Lélé in *L'Étourdie*, and Eraste in *Le Dépit amoureux*. His brother LOUIS BÉJART (c. 1630-1678) was also in Molière's company during the last years of its travels. He created many parts in his

brother-in-law's plays—Valère in *Le Dépit amoureux*, Dubois in *Le Misanthrope*, Alcantor in *Le Mariage forcé*, and Don Luis in *Le Festin de Pierre*—and was an actor of varied talents. In consequence of a wound received when interfering in a street brawl, he became lame and retired with a pension—the first ever granted by the company to a comedian—in 1670.

The more famous members of the family were two sisters.

MADELEINE BÉJART (1618-1672) was at the head of the travelling company to which her sister Geneviève (1631-1675)—who played as Mlle Hervé—and her brothers belonged, before they joined Molière in forming l'illustre Théâtre (1643). With Molière she remained until her death on the 17th of February 1672. She had had an illegitimate daughter (1638) by an Italian count, and her conduct on her early travels had not been exemplary, but whatever her private relations with Molière may have been, however acrimonious and violent her temper, she and her family remained faithful to his fortunes. She was a tall, handsome blonde, and an excellent actress, particularly in soubrette parts, a number of which Molière wrote for her. Among her creations were Marotte in *Les Précieuses ridicules*, Lisette in *L'École des maris*, Dorine in *Tartuffe*.

Her sister, ARMANDE GRÉSINDE CLAIRE ÉLIZABETH BÉJART (1645-1700), seems first to have joined the company at Lyons in 1653. Molière directed her education and she grew up under his eye. In 1662, he being then forty and she seventeen, they were married. Neither was happy; the wife was a flirt, the husband jealous. On the strength of a scurrilous anonymous pamphlet, *La Fameuse Comédienne, ou histoire de la Guubrin* (1688), her character has been held perhaps unduly low. She was certainly guilty of indifference and ingratitude, possibly of infidelity; they separated after the birth of a daughter in 1665 and met only at the theatre until 1671. But the charm and grace which fascinated others, Molière too could not resist, and they were reconciled. Her portrait is given in a well-known scene (Act iii, sc. 9) in *Le Bourgeois gentilhomme*. Mme Molière's first appearance on the stage was in 1663, as Élise in the *Critique de l'École des femmes*. She was out of the cast for a short time in 1664, when she bore Molière a son—Louis XIV. and Henrietta of England standing sponsors. But in the spring, beginning with the fêtes given at Versailles by the king to Anne of Austria and Maria Theresa, she started her long list of important rôles. She was at her best as Celimène—really her own highly-finished portrait—in *Le Misanthrope*, and hardly less admirable as Angélique in *Le Malade imaginaire*. She was the Elmire at the first performance of *Tartuffe*, and the Lucile of *Le Bourgeois gentilhomme*. All these parts were written by her husband to display her talents to the best advantage and she made the most of her opportunities. The death of Molière, the secession of Baron and several other actors, the rivalry of the Hôtel de Bourgogne and the development of the Palais Royal, by royal patent, into the home of French opera, brought matters to a crisis with the *comédiens du roi*. Well advised by La Grange (Charles Varlet, 1639-1692), Armande leased the Théâtre Guénégaud, and by royal ordinance the residue of her company were combined with the players from the Théâtre du Marais, the fortunes of which were at low ebb. The combination, known as the *troupe du roi*, at first was unfortunate, but in 1679 they secured Mlle du Champmeslé, later absorbed the company of the Hôtel de Bourgogne, and in 1680 the Comédie Française was born. Mme Molière in 1677 had married Eustache François Guérin (1636-1728), an actor, and by him she had one son (1678-1708). She continued her successes at the theatre until she retired in 1694, and she died on the 30th of November 1700.

BEK, ANTONY (d. 1311), bishop of Durham, belonged to a Lincolnshire family, and, having entered the church, received several benefices and soon attracted the attention of Edward I., who secured his election as bishop of Durham in 1283. When, after the death of King Alexander III. in 1285, Edward interfered in the affairs of Scotland, he employed Bek on this business, and in 1294 he sent him on a diplomatic errand to the German king, Adolph of Nassau. Taking part in Edward's campaigns in Scotland, the bishop received the surrender of John de Baliol at

Brechin in 1296, and led one division of the English army at the battle of Falkirk in 1298. Soon after his return to England he became involved in a quarrel with Richard de Hoton, prior of Durham. Deposed and excommunicated by Bek, the prior secured the king's support; but the bishop, against whom other complaints were preferred, refused to give way, and by his obstinacy incurred the lasting enmity of Edward. In 1302, in obedience to the command of Pope Boniface VIII., he visited Rome on this matter, and during his absence the king seized and administered his lands, which, however, he recovered when he returned and submitted to Edward. He continued, however, to pursue Richard with unrelenting hostility, and was in his turn seriously harassed by the king. Having been restored to the royal favour by Edward II. who made him lord of the Isle of Man, the bishop died at Eltham on the 3rd of March 1311. A man of great courage and energy, chaste and generous, Bek was remarkable for his haughtiness and ostentation. Both as a bishop and as a private individual he was very wealthy, and his household and retinue were among the most magnificent in the land. He was a soldier and a hunter rather than a bishop, and built castles at Eltham and elsewhere.

Bek's elder brother, THOMAS BEK (d. 1293), bishop of St David's, was a trusted servant of Edward I. He obtained many important and wealthy ecclesiastical positions, was made treasurer of England in 1279, and became bishop of St David's in 1280. He was a benefactor to his diocese and died on the 12th of May 1293.

Another THOMAS BEK (1282-1347), who was bishop of Lincoln from 1341 until his death on the 2nd of February 1347, was a member of the same family.

ANTONY BEK must not be confused with his kinsman and namesake, ANTONY BEK (1279-1343), who was chancellor and dean of Lincoln cathedral, and became bishop of Norwich after a disputed election in 1337. He was a quarrelsome man, and after a stormy episcopate, died on the 19th of December 1343.

See Robert of Graystones, *Historia de statu ecclesie Dunelmensis*, edited by J. Raine in his *Historie Dunelmensis scriptores* (London, 1830); W. Hutchinson, *History of Durham* (Newcastle, 1785-79); J. L. Low, *Diocesan History of Durham* (London, 1887); and M. Creighton in the *Dictionary of National Biography*, vol. iv. (London, 1885).

BEKE, CHARLES TILSTONE (1800-1874), English traveller, geographer and Biblical critic, was born in Stepney, Middlesex, on the 10th of October 1800. His father was a merchant in London, and Beke engaged for a few years in mercantile pursuits. He afterwards studied law at Lincoln's Inn, and for a time practised at the bar, but finally devoted himself to the study of historical, geographical and ethnographical subjects. The first-fruits of his researches appeared in his work entitled *Origines Biblicae, or Researches in Primal History*, published in 1834. An attempt to reconstruct the early history of the human race from geological data, it raised a storm of opposition on the part of defenders of the traditional readings of the book of Genesis; but in recognition of the value of the work the university of Tübingen conferred upon him the degree of Ph.D. For about two years (1837-1838) Beke held the post of acting British consul in Saxony. From that time till his death his attention was largely given to geographical studies, chiefly of the Nile valley. Aided by private friends, he visited Abyssinia in connexion with the mission to Shoa sent by the Indian government under the leadership of Major (afterwards Sir) William Cornwallis Harris, and explored Gojam and more southern regions up to that time unknown to Europeans. Among other achievements, Beke was the first to determine, with any approach to scientific accuracy, the course of the Abai (Blue Nile). The valuable results of this journey, which occupied him from 1840 to 1843, he gave to the world in a number of papers in scientific publications, chiefly in the *Journal of the Royal Geographical Society*. On his return to London, Beke re-engaged in commerce, but devoted all his leisure to geographical and kindred studies. In 1848 he planned an expedition from the mainland opposite Zanzibar to discover the sources of the Nile. A start was made, but the expedition accomplished little. Beke's belief that the

White Nile was the main stream was, however, shown to be accurate by subsequent exploration. In 1856 he endeavoured, unsuccessfully, to establish commercial relations with Abyssinia through Massawa. In 1861-1862 he and his wife travelled in Syria and Palestine, and went to Egypt with the object of promoting trade with Central Africa and the growth of cotton in the Sudan. In 1865 he again went to Abyssinia, for the purpose of obtaining from King Theodore the release of the British captives. On learning that the captives had been released, Beke turned back, but Theodore afterwards re-arrested the party. To the military expedition sent to effect their release Beke furnished much valuable information, and his various services to the government and to geographical research were acknowledged by the award of £500 in 1868 by the secretary for India, and by the grant of a civil list pension of £100 in 1870. In his seventy-fourth year he undertook a journey to Egypt for the purpose of determining the real position of Mount Sinai. He conceived that it was on the eastern side of the Gulf of Akaba, and his journey convinced him that his view was right. It has not, however, commended itself to general acceptance. Beke died at Bromley, in Kent, on the 31st of July 1874.

Beke's writings are very numerous. Among the more important, besides those already named, are: *An Essay on the Nile and its Tributaries* (1847), *The Sources of the Nile* (1860), and *The British Captives in Abyssinia* (1865). He was a fellow of the Royal Geographical Society, and for his contributions to the knowledge of Abyssinia received its gold medal, and also that of the Geographical Society of France. As a result of a controversy over the statements of another Abyssinian explorer, Antoine Abbadie, Beke returned the medal awarded him by the French Society.

See *Summary of the late Dr Beke's published works and . . . public services*, by his widow (Tunbridge Wells, 1876).

BÉKÉCSABA, a market-town of Hungary, 123 m. S.E. of Budapest by rail. Pop. (1900) 37,108, mostly Slovaks and Lutherans, who form the largest Lutheran community in Hungary. The town is situated near the White Körös, with which it is connected by a canal, and is an important railway-junction in central Hungary. Békécsaba possesses several large milling establishments, while the weaving of hemp and the production of hemp-linen is largely pursued as a home industry. The town carries on an active trade in cereals, wines and cattle.

BEKKER, AUGUST IMMANUEL (1785-1871), German philologist and critic, was born on the 21st of May 1785. He completed his classical education at the university of Halle under F. A. Wolf, who considered him as his most promising pupil. In 1810 he was appointed professor of philosophy in the university of Berlin. For several years, between 1810 and 1821, he travelled in France, Italy, England and parts of Germany, examining classical manuscripts and gathering materials for his great editorial labours. He died at Berlin on the 7th of June 1871. Some detached fruits of his researches were given in the *Ancient Graeca*, 1814-1821; but the full result of his unwearied industry and ability is to be found in the enormous array of classical authors edited by him. Anything like a complete list of his works would occupy too much space, but it may be said that his industry extended to nearly the whole of Greek literature with the exception of the tragedians and lyric poets. His best known editions are: Plato (1816-1823), Oratores Attici (1823-1824), Aristotle (1831-1836), Aristophanes (1829), and twenty-five volumes of the *Corpus Scriptorum Historiae Byzantinae*. The only Latin authors edited by him were Livy (1829-1830) and Tacitus (1831). Bekker confined himself entirely to textual recension and criticism, in which he relied solely upon the MSS., and contributed little to the extension of general scholarship.

See Sauppe, *Zur Erinnerung an Meineke und Bekker* (1872); Haupt, "Gedächtnisrede auf Meineke und Bekker," in his *Opuscula*, iii.; E. I. Bekker, "Zur Erinnerung an meinen Vater," in the *Preussisches Jahrbuch*, xxix.

BEKKER, BALTHASAR (1634-1698), Dutch divine, was born in Friesland in 1634, and educated at Groningen, under Jacob Alting, and at Francker. He was pastor at Francker, and from

1679, at Amsterdam. An enthusiastic disciple of Descartes, he wrote several works in philosophy and theology, which by their freedom of thought aroused considerable hostility. His best known work was *Die Betooverde Wereld* (1691), or *The World Bewitched* (1695; one volume of an English translation from a French copy), in which he examined critically the phenomena generally ascribed to spiritual agency, and attacked the belief in sorcery and "possession" by the devil, whose very existence he questioned. The book is interesting as an early study in comparative religion, but its publication in 1692 led to Bekker's deposition from the ministry. He died at Amsterdam.

BEKKER (or **WOLFF**), **ELIZABETH** (1738-1804), Dutch novelist, was married to Adrian Wolff, a Reformed clergyman, but is always known under her maiden name. After the death of her husband in 1777, she resided for some time in France, with her close friend, Agatha Deken. She was exposed to some of the dangers of the French Revolution, and, it is said, escaped the guillotine only by her great presence of mind. In 1795 she returned to Holland, and resided at the Hague till her death. Her novels were written in conjunction with Agatha Deken, and it is somewhat difficult to determine the exact qualities contributed by each. *The Historie van William Levend* (1785), *Historie van Sara Burgerhart* (1790), *Abraham Blankhart* (1787), *Cornelie Wildschut* (1793-1796), were extremely popular.

BEL, the name of a chief deity in Babylonian religion, the counterpart of the Phoenician Baal (*q.v.*) ideographically written as En-lil. Since Bel signifies the "lord" or "master" *par excellence*, it is, therefore, a title rather than a genuine name, and must have been given to a deity who had acquired a position at the head of a pantheon. The real name is accordingly to be sought in En-lil, of which the first element again has the force of "lord" and the second presumably "might," "power," and the like, though this cannot be regarded as certain. En-lil is associated with the ancient city of Nippur, and since En-lil with the determinative for "land" or "district" is a common method of writing the name of the city, it follows, apart from other evidence, that En-lil was originally the patron deity of Nippur. At a very early period—prior to 3000 B.C.—Nippur had become the centre of a political district of considerable extent, and it is to this early period that the designation of En-lil as Bel or "the lord" reverts. Inscriptions found at Nippur, where extensive excavations were carried on during 1888-1900 by Messrs Peters and Haynes, under the auspices of the University of Pennsylvania, show that Bel of Nippur was in fact regarded as the head of an extensive pantheon. Among the titles accorded to him are "king of lands," "king of heaven and earth" and "father of the gods." His chief temple at Nippur was known as E-Kur, signifying "mountain house," and such was the sanctity acquired by this edifice that Babylonian and Assyrian rulers, down to the latest days, vied with one another in embellishing and restoring Bel's seat of worship, and the name itself became the designation of a temple in general. Grouped around the main sanctuary there arose temples and chapels to the gods and goddesses who formed his court, so that E-Kur became the name for an entire sacred precinct in the city of Nippur. The name "mountain house" suggests a lofty structure and was perhaps the designation originally of the staged tower at Nippur, built in imitation of a mountain, with the sacred shrine of the god on the top. The tower, however, also had its special designation of "Im-Khar-sag," the elements of which, signifying "storm" and "mountain," confirm the conclusion drawn from other evidence that En-lil was originally a storm-god having his seat on the top of a mountain. Since the Euphrates valley has no mountains, En-lil would appear to be a god whose worship was carried into Babylonia by a wave of migration from a mountainous country—in all probability from Elam to the east.

When, with the political rise of Babylon as the centre of a great empire, Nippur yielded its prerogatives to the city over which Marduk presided, the attributes and the titles of En-lil were transferred to Marduk, who becomes the "lord" or Bel of later days. The older Bel did not, however, entirely lose his standing. Nippur continued to be a sacred city after it ceased

to have any considerable political importance, while in addition the rise of the doctrine of a triad of gods symbolizing the three divisions—heavens, earth and water—assured to Bel, to whom the earth was assigned as his province, his place in the religious system. The disassociation from his local origin involved in this doctrine of the triad gave to Bel a rank independent of political changes, and we, accordingly, find Bel as a factor in the religion of Babylonia and Assyria to the latest days. It was no doubt owing to his position as the second figure of the triad that enabled him to survive the political eclipse of Nippur and made his sanctuary a place of pilgrimage to which Assyrian kings down to the days of Assur-bani-pal paid their homage equally with Babylonian rulers.

See also BELIT and BAAL. For the apocryphal book of the Bible, *Bel and the Dragon*, see DANIEL: *Additions to Daniel*. (M. J. A.)

BELA III. (d. 1196), king of Hungary, was the second son of King Géza II. Educated at the Byzantine court, where he had been compelled to seek refuge, he was fortunate enough to win the friendship of the brilliant emperor Manuel who, before the birth of his own son Alexius, intended to make Bela his successor and betrothed him to his daughter. Subsequently, however, he married the handsome and promising youth to Agnes of Châtillon, duchess of Antioch, and in 1173 placed him, by force of arms, on the Hungarian throne, first expelling Bela's younger brother Géza, who was supported by the Catholic party. Initiated from childhood in all the arts of diplomacy at what was then the focus of civilization, and as much a warrior by nature as his imperial kinsman Manuel, Bela showed himself from the first fully equal to all the difficulties of his peculiar position. He began by adopting Catholicism and boldly seeking the assistance of Rome. He then made what had hitherto been an elective a hereditary throne by crowning his infant son Emerich his successor. In the beginning of his reign he adopted a prudent policy of amity with his two most powerful neighbours, the emperors of the East and West, but the death of Manuel in 1180 gave Hungary once more a free hand in the affairs of the Balkan Peninsula, her natural sphere of influence. The attempt to recover Dalmatia, which involved Bela in two bloody wars with Venice (1181-88 and 1190-91), was only partially successful. But he assisted the Rascians or Serbs (see HUNGARY: *History*) to throw off the Greek yoke and establish a native dynasty, and attempted to make Galicia an appanage of his younger son Andrew. It was in Bela's reign that the emperor Frederick I., in the spring of 1189, traversed Hungary with 100,000 crusaders, on which occasion the country was so well policed that no harm was done to it and the inhabitants profited largely from their commerce with the German host. In his last years Bela assisted the Greek emperor Isaac II. Angelus against the Bulgarians. His first wife bore Bela two sons, Emerich and Andrew. On her death he married Margaret of France, sister of King Philip Augustus. Bela was in every sense of the word a great statesman, and his court was accounted one of the most brilliant in Europe.

For an account of his internal reforms see HUNGARY. Though the poet Ede Szilgietzi has immortalized his memory in the play *Bela III.*, we have no historical monograph of him, but in Ignaz Ácsády, *History of the Hungarian Realm* (Hung.), i. 2 (Budapest, 1903), there is an excellent account of his reign. (R. N. B.)

BELA IV. (1206-1270), king of Hungary, was the son of Andrew II., whom he succeeded in 1235. During his father's lifetime he had greatly distinguished himself by his administration of Transylvania, then a wilderness, which, with incredible patience and energy, he colonized and christianized. He repaired as far as possible the ruinous effects of his father's wastefulness, but on his accession found everything in the utmost confusion, "the great lords," to cite the old chronicler Rogerius (c. 1223-1266), "having so greatly enriched themselves that the king was brought to naught." The whole land was full of violence, the very bishops storming rich monasteries at the head of armed retainers. Bela resolutely put down all disorder. He increased the dignity of the crown by introducing a stricter court etiquette, and its wealth by recovering those of the royal domains which the magnates had appropriated during the troubles of the last reign. The pope, naturally on the side of order, staunchly

supported this regenerator of the realm, and in his own brother Coloman, who administered the district of the Drave, Bela also found a loyal and intelligent co-operator. He also largely employed Jews and Ishmaelites,¹ the financial specialists of the day, whom he rewarded with lands and titles. The salient event of Bela's reign was the terrible Tatar invasion which reduced three-quarters of Hungary to ashes. The terror of their name had long preceded them, and Bela, in 1235 or 1236, sent the Dominican monk Julian, by way of Constantinople, to Russia, to collect information about them from the "ancient Magyars" settled there, possibly the Volgan Bulgarians. He returned to Hungary with the tidings that the Tatars contemplated the immediate conquest of Europe. Bela did his utmost to place his kingdom in a state of defence, and appealed betimes to the pope, the duke of Austria and the emperor for assistance; but in February and March 1241 the Tatars burst through the Carpathian passes; in April Bela himself, after a gallant stand, was routed on the banks of the Sajó and fled to the islands of Dalmatia; and for the next twelve months the kingdom of Hungary was merely a geographical expression. The last twenty-eight years of Bela's reign were mainly devoted to the reconstruction of his realm, which he accomplished with a single-minded thoroughness which has covered his name with glory. (See HUNGARY: *History*.)

Perhaps the most difficult part of his task was the recovery of the western portions of the kingdom (which had suffered least) from the hands of Frederick of Austria, who had seized them as the price of assistance which had been promised but never given. First Bela solicited the aid of the pope, but was compelled finally to resort to arms, and crossing the Leitha on the 15th of June 1246, routed Frederick, who was seriously wounded and trampled to death by his own horsemen. With him was extinguished the male line of the house of Babenberg. In the south Bela was less successful. In 1243 he was obliged to cede to Venice, Zara, a perpetual apple of discord between the two states; but he kept his hold upon Spalato and his other Dalmatian possessions, and his wise policy of religious tolerance in Bosnia enabled Hungary to rule that province peaceably for many years. The new Servian kingdom of the Nemanides, on the other hand, gave him much trouble and was the occasion of many bloody wars. In 1261 the Tatars under Nogai Khan invaded Hungary for the second time, but were defeated by Bela and lost 50,000 men. Bela reached the apogee of his political greatness in 1264 when, shortly after his crushing defeat of the Servian king, Stephen Urosh, he entertained at his court, at Kalocsa, the ambassadors of the newly restored Greek emperor, of the kings of France, Bulgaria and Bohemia and three Tatar *mirzas*. For a time Bela was equally fortunate in the north-west, where the ambitious and enterprising Přemyslidae had erected a new Bohemian empire which absorbed the territories of the old Babenbergers and was very menacing to Hungary. With Ottakar II. in particular, Bela was almost constantly at war for the possession of Styria, which ultimately fell to the Bohemians. The last years of Bela's life were embittered by the ingratitude of his son Stephen, who rebelled continuously against his father and ultimately compelled him to divide the kingdom with him, the younger prince setting up a capital of his own at Sárospatak, and following a foreign policy directly contrary to that of his father. Bela died on the 3rd of May 1270 in his sixty-fourth year. With the people at large he was popular to the last; his services to his country had been inestimable. He married, while still crown-prince, Maria, daughter of the Nicean emperor, Theodore Lascaris, whom his own father brought home with him from his crusade. She bore him, besides his two sons Stephen and Bela, seven daughters, of whom St Margaret was the most famous.

No special monograph for the whole reign exists. For the Tatar invasion see the contemporary Rogerius, *Epistolae super destructione Regni Hungaricæ per Tartaros facta* (Budapest, 1885). A vivid but somewhat chauvinistic history of Bela's reign will be found in Ácsády's *History of the Hungarian Realm* (Hung.), i. 2 (Budapest, 1903). (R. N. B.)

¹ Mahomedan itinerant chapmen, from the Volga.

BELA, **LAS BELA**, or **LUS BEYLA**, situated in $26^{\circ} 27' 30''$ N. lat. and $66^{\circ} 45' 0''$ E. long., 350 ft. above sea level, capital of the small independent state of Las Bela to the south of Kalat (Baluchistan), ruled by the Jam (or Cham), who occupies the position of a protected chief under the British Raj. To the east lies Sind, and to the west Makrān, and from time immemorial the great trading route between Sind and Persia has passed through Las Bela. The area of Las Bela is 6357 sq. m., and its population in 1901 was 56,100, of which 54,040 were Mussulmans. The low-lying, alluvial, hot and malarial plains of Las Bela, occupying about 6000 sq. m. on the north-east corner of the Arabian Sea, are highly irrigated and fertile—two rivers from the north, the Purālī and the Kud, uniting to provide a plentiful water supply. The bay of Sonmiani once extended over most of these plains, where the Purālī delta is now growing with measurable strides. The hill ranges to the east, parting the plains from Sind (generally known locally as the Mor and the Kirthar), between which lies the long narrow line of the Hab valley, strike nearly north and south, diminishing in height as they approach the sea and allowing of a route skirting the coast between Karachi and Bela. To the west they are broken into an infinity of minor ridges massing themselves in parallel formation with a strike which curves from south to west till they form the coast barrier of Makrān. The Persian route from India, curving somewhat to the north, traverses this waste of barren ridges almost at right angles, but on dropping into the Kolwah valley its difficulty ceases. It then becomes an open road to Kej and Persia, with an easy gradient. This was undoubtedly one of the greatest trade routes of the medieval days of Arab ascendancy in Sind, and it is to this route that Bela owes a place in history which its modern appearance and dimensions hardly seem to justify. Bela is itself rather prettily situated on a rocky site above the banks of the Purālī. About four miles to the south are the well-kept gardens which surround the tomb of Sir Robert Sandeman; which is probably destined to become a "ziarat," or place of pilgrimage, of even greater sanctity than that of General Jacob at Jacobabad. The population of the town numbers about 5000. The Jam's retinue consists of about 300 infantry, 50 cavalry, and 4 guns. Liability to assist on active service is the only acknowledgment of the suzerainty which is paid by the Jam to the Khan of Kalat. The Jam, Mir Kamal Khan, succeeded his father, Sir Mir Khan, in 1895, and was formally invested with powers in 1902.

From very early times this remote corner of Baluchistan has held a distinct place in history. There are traces of ancient Arab (possibly Hiyaritic) occupation to be found in certain stone ruins at Gondakeha on the Kud river, 10 m. to the north-west of Bela, whilst the Greek name "Arabis" for the Purālī is itself indicative of an early prehistoric connexion with races of Asiatic Ethiopians referred to by Herodotus. On the coast, near the village of Sonmiani (a station of the Indo-Persian telegraph line) may be traced the indentation which once formed the bay of Morontobara, noted in the voyage of Nearchus; and it was on the borders of Makrān that the Turanian town of Rhambakia was situated, which was once the centre of the trade in "bdellium." In the 7th century A.D. Las Bela was governed by a Buddhist priest, at which time all the province of Gandava was Buddhist, and Sind was ruled by the Brahman, Chach. Buddhist caves are to be found excavated in the conglomerate cliffs near Gondakeha, at a place called Gondrāni, or Shahr-i-Rogan. With the influx of Arabs into Makrān, Bela, under the name of Armel (or Armabel), rose to importance as a link in the great chain of trading towns between Persia and Sind; and then there existed in the delta such places as Yuzli (near the modern Uthal) and Kambali (which may possibly be recognized in the ruins at Khairokot), and many smaller towns, each of which possessed its citadel, its caravansera and bazaar, which are not only recorded but actually mapped by one of the medieval Arab geographers, Ibn Haukal. It is probable that Karā Pir, 1½ m. to the east of the modern city, represents the site of the Armabel which was destroyed by Mahommed Kasim in his victorious march to Sind in 710. There is another old site 5 m. to the west of the modern town. The ruins at

Karā Pir, like those of Tijarra Pir and Khairokot, contain Arab pottery, seals, and other medieval relics. The Lumris, or Lasis, who originate the name Las as a prefix to that of Bela, are the dominant tribe in the province. They are comparatively recent arrivals who displaced the earlier Tajik and Brahui occupants. It is probable that this influx of Rajput population was coincident with the displacement of the Arab dynasties in Sind by the Mahommedan Rajputs in the 11th century A.D. Some authorities connect the Lumris with the Sumras.

There are no published accounts of Bela, excepting those of the Indian government reports and gazetteers. This article is compiled from unpublished notes by the author and by Mr Wainwright, of the Indian Survey department. (T. H. H.)

BELA, a town of British India, administrative headquarters of the Partabgarh district of the United Provinces, with a railway station 80 m. from Benares. Pop. (1901) 8041. It adjoins the village of Partabgarh proper, and the civil station sometimes known as Andrewganj. Bela, which was founded in 1802 as a cantonment, became a district headquarters after the mutiny. It has trade in agricultural produce. There is a well-known hospital for women here.

BELAY (from the same O. Eng. origin as "lay"; cf. Dutch *beleggen*), a nautical term for making ropes fast round a pin. In earlier days the word was synonymous with "waylay" or "surround."

BELCHER, SIR EDWARD (1799-1877), British naval officer, entered the navy in 1812. In 1825 he accompanied Frederick William Beechey's expedition to the Pacific and Bering Strait, as a surveyor. He subsequently commanded a surveying ship on the north and west coasts of Africa and in the British seas, and in 1836 took up the work which Beechey left unfinished on the Pacific coast of South America. This was on board the "Sulphur," which was ordered to return to England in 1839 by the Trans-Pacific route. Belcher made various observations at a number of islands which he visited, was delayed by being despatched to take part in the war in China in 1840-1841, and reached home only in 1842. In 1843 he was knighted, and was now engaged in the "Samarang," in surveying work in the East Indies, the Philippines, &c., until 1847. In 1852 he was given command of the government Arctic expedition in search of Sir John Franklin. This was unsuccessful; Belcher's inability to render himself popular with his subordinates was peculiarly unfortunate in an Arctic voyage, and he was not wholly suited to command vessels among ice. This was his last active service, but he became K.C.B. in 1867 and an admiral in 1872. He published a *Treatise on Nautical Surveying* (1835), *Narrative of a Voyage round the World performed in H.M.S. "Sulphur," 1836-1842* (1843), *Narrative of the Voyage of H.M.S. "Samarang" during 1843-1846* (1848); the *Zoology of the Voyage* was separately dealt with by some of his colleagues, (1850), and *The Last of the Arctic Voyages* (1855); besides minor works, including a novel, *Horatio Howard Brenton* (1856), a story of the navy. He died in London on the 18th of March 1877.

BELDAM (like "belsie," grandfather, from the Fr. *bel*, good, expressing relationship; cf. the Fr. *belle-mère*, mother-in-law, and *dame*, in Eng. form "dam," mother), strictly a grandmother or remote ancestress, and so an old woman; generally used contemptuously as meaning an old hag.

BELESME, ROBERT OF (fl. 1100), earl of Shrewsbury. From his mother Mabel Talvas he inherited the fief of Belesme, and from his father, the Conqueror's companion, that of Shrewsbury. Both were march-fiefs, the one guarding Normandy from Maine, and the other England from the Welsh; consequently their lord was peculiarly powerful and independent. Robert is the typical feudal noble of the time, circumspect and politic, persuasive and eloquent, impetuous and daring in battle, and an able military engineer; in person, tall and strong; greedy for land, an oppressor of the weak, a systematic rebel and traitor, and savagely cruel. He first appears as a supporter of Robert's rebellion against the Conqueror (1077); then as an accomplice in the English conspiracy of 1088 against Rufus. Later he served Rufus in Normandy, and was allowed to succeed his brother Hugh

in the earldom of Shrewsbury (1098). But at the height of his power, he revolted against Henry I. (1102). He was banished and deprived of his English estate; for sometime after he remained at large in Normandy, defying the authority of Robert and Henry alike. He betrayed Robert's cause at Tinchebrai; but in 1112 was imprisoned for life by Henry I.

See E. A. Freeman's *William Rufus and his Norman Conquest*, vol. iv.; and J. M. Lappenberg's *History of England under the Norman Kings*, trans. B. Thorpe (1857).

BELFAST, a city, county and parliamentary borough, the capital of the province of Ulster, and county town of county Antrim, Ireland. Pop. (1901) 349,180. It is a seaport of the first rank, situated at the entrance of the river Lagan into Belfast Lough, 11½ m. north of Dublin by rail, on the north-east coast of the island. It is an important railway centre, with terminal stations of the Great Northern, Northern Counties (Midland of England), and Belfast & County Down railways, and has regular passenger communication by sea with Liverpool, Fleetwood, Heysham, Glasgow, and other ports of Great Britain. It is built on alluvial deposit and reclaimed land, mostly not exceeding 6 ft. above high water mark, and was thus for a long period subject to inundation and epidemics, and only careful drainage rendered the site healthy. The appearance of the city plainly demonstrates the modern growth of its importance, and evidence is not wanting that for a considerable period architectural improvement was unable to keep pace with commercial development. Many squalid districts, however, have been improved away to make room for new thoroughfares and handsome buildings. One thoroughfare thus constructed at the close of the 19th century is the finest in Belfast—Royal Avenue. It contains, among several notable buildings, the post office, and the free public library, opened in 1888 and comprising a collection of over 40,000 volumes, as well as an art gallery and a museum of antiquities especially rich in remains of the Neolithic period. The architect was Mr W. H. Lynn. The magnificent city hall, from designs of Mr (afterwards Sir) Brumwell Thomas, was opened in 1906. The principal streets, such as York Street, Donegall Street, North Street, High Street, are traversed by tramways. Four bridges cross the Lagan; the Queen's Bridge (1844, widened in 1886) is the finest, while the Albert Bridge (1886) replaces a former one which collapsed. Other principal public buildings, nearly all to be included in modern schemes of development, are the city hall, occupying the site of the old Linen Hall, in Donegall Square, estimated to cost £300,000; the commercial buildings (1820) in Waring Street, the custom-house and inland revenue office on Donegall Quay, the architect of which, as of the court house, was Sir Charles Lanyon, and some of the numerous banks, especially the Ulster Bank. The Campbell College in the suburb of Belmont was founded in 1892 in accordance with the will of Mr W. J. Campbell, a Belfast merchant, who left £200,000 for the building and endowment of a public school. Other educational establishments are Queen's University, replacing the old Queen's College (1849) under the Irish Universities Act 1908; the Presbyterian and the Methodist Colleges, occupying neighbouring sites close to the extensive botanical gardens, the Royal Academical Institution, and the Municipal Technical Institute. In 1897 the sum of £100,000 was subscribed by citizens to found a hospital (1903) to commemorate the Diamond Jubilee of Queen Victoria, and named after her. It took the place of an institution which, under various names, had existed since 1797. Public monuments are few, but include a statue of Queen Victoria (1903) and a South African War memorial (1905) in front of the city hall; the Albert Memorial (1870), in the form of a clock-tower, in Queen Street; a monument to the same prince in High Street; and a statue in Wellington Place to Dr Henry Cooke, a prominent Presbyterian minister who died in 1868. The corporation controls the gas and electric and similar undertakings. The water supply, under the control of the City and District Water Commissioners (incorporated 1840), has its sources in the Mourne Mountains, Co. Down, 40 m. distant, with a service reservoir at Knockbreckan; also in the hilly district near Carrickfergus. There are several

public parks, of which the principal are the Ormeau Park (1870), the Victoria, Alexandra, and Falls Road parks. There is a Theatre Royal in Arthur Square. There are also several excellent clubs and societies, social, political, scientific, and sporting; including among the last the famous Royal Ulster Yacht Club.

In 1890 was laid the foundation stone of the Protestant cathedral in Donegall Street, designed by Sir Thomas Drew and Mr W. H. Lynn to seat 3000 worshippers, occupying the site of the old St Anne's parish church, part of the fabric of which the new building incorporates. The diocese is that of Down, Connor, and Dromore. The first portion (the nave) was consecrated on the 2nd of June 1904. The plan is a Latin cross, the west front rising to a height of 105 ft., while the central tower is 175 ft. The pulpit was formerly used in the nave of Westminster Abbey, being presented to Belfast cathedral by the dean and chapter of that foundation.

Most of the older churches are classical in design, and the most notable are St George's, in High Street, and the Memorial church of Dr Cooke in May Street. For the more modern churches the Gothic style has frequently been used. Amongst these are St James, Antrim Road; St Peter's Roman Catholic chapel, with its Florentine spire; Presbyterian churches in Fitzroy Avenue, and Elmwood Avenue, and the Methodist chapel, Carlisle Circus. The Presbyterians and Protestant Episcopalians each outnumber the Roman Catholics in Belfast, and these three are the chief religious divisions.

Environns.—The country surrounding Belfast is agreeable and picturesque, whether along the shores of the Lough or towards the girdle of hills to the west; and is well wooded and studded with country seats and villas. In the immediate vicinity of the city are several points of historic interest and natural beauty. The Cave Hill, though exceeded in height by Mount Divis, Squire's Hill, and other summits, is of greatest interest for its caves, in the chalk, from which early weapons and other objects have been recovered. The battle in 1408, which was fought along the base of the cliffs here between the Savages of the Ards and the Irish, is described in Sir Samuel Ferguson's "Hibernian Nights Entertainment." Here also are McArt's Fort and other earthworks, and from here the importance of the physical position of Belfast may be appreciated to the full. At Newtonbreda, overlooking the Lagan, was the palace of Con O'Neill, whose sept was exterminated by Deputy Mountjoy in the reign of Queen Elizabeth. Belfast Lough is of great though quiet beauty; and the city itself is seen at its best from its seaward approach, with its girdle of hills in the background. On the shores of the lough several villages have grown into residential towns for the wealthier classes, whose work lies in the city. Of these Whitehouse and White Abbey are the principal on the western shore, and on the eastern, Holywood, which ranks practically as a suburb of Belfast, and, at the entrance to the lough, Bangor.

Harbour and Trade.—The harbour and docks of Belfast are managed by a board of harbour commissioners, elected by the ratayers and the shipowners. The outer harbour is one of the safest in the kingdom. By the Belfast Harbour Acts the commissioners were empowered to borrow more than £2,500,000 in order to carry out several new works and improvements in the port. Under the powers of these acts a new channel, called the Victoria Channel, several miles in length, was cut about 1840 leading in a direct line from the quays to the sea. This channel affords 20 ft. of water at low tide, and 28 ft. at full tide, the width of the channel being 300 ft. The Alexandra Dock, which is 852 ft. long and 31 ft. deep, was opened in 1889, and the extensive improvements (including the York Dock, where vessels carrying 10,000 tons can discharge in four to six days) have been effected from time to time, making the harbour one of the most commodious in the United Kingdom. The provision of a new graving dock adjoining the Alexandra was delayed in October 1905 by a subsidence of the ground during its construction. Parliamentary powers were obtained to construct a graving dock capable of accommodating the largest class of warships. The growth and development of the shipbuilding industry has been

immense, the firm of Harland & Wolff being amongst the first in the trade, and some of the largest vessels in the world come from their yards. The vast increase of the foreign trade of Belfast marks its development, like Liverpool, as a great distributing port. The chief exports are linen, whisky, aerated waters, iron ore and cattle.

Belfast is the centre of the Irish linen industry, machinery for which was introduced by T. & A. Mulholland in 1830, a rapid extension of the industry at once resulting. It is also the headquarters and business centre for the entire flax-spinning and weaving industry of the country. Distilling is extensively carried on. Several firms are engaged in the manufacture of mineral waters, for which the water of the Cromac Springs is peculiarly adapted. Belfast also has some of the largest tobacco works and rope works in the world.

Administration.—In conformity with the passing of the Municipal Corporations Act of 1840 the constitution of the corporation was made to consist of ten aldermen and thirty councillors, under the style and title of "The Mayor, Aldermen, and Burgesses of the Borough of Belfast." In 1858 the rank of a city was conferred by royal charter upon Belfast, with the incidental rank, liberties, privileges, and immunities. In 1892 Queen Victoria conferred upon the mayor of the city the title of lord mayor, and upon the corporation the name and description of "The Lord Mayor, Aldermen, and Citizens of the city of Belfast." By the passing of the Belfast Corporation Act of 1896, the boundary of the city was extended, and the corporation made to consist of fifteen aldermen and forty-five councillors, and the number of wards was increased from five to fifteen. By virtue of the Local Government (Ireland) Act 1808, Belfast became a county borough on the 1st of April 1809. By the Local Government (Ireland) Act 1898, Belfast became for assize purposes "the county of the city of Belfast," with a high sheriff. It is divided into four parliamentary divisions north, south, east and west, each returning one member. The total area is 16,594 acres.

History.—The etymology of the name (for which several derivations have been proposed) and the origin of the town are equally uncertain, and there is not a single monument of antiquarian interest upon which to found a conjecture. About 1177 a castle is said to have been built by John de Courcy, to be destroyed by Edward Bruce in 1316. It may be noted here that Belfast Castle was finally burnt in 1708; but a modern mansion, on Cave Hill, outside the city, bears that name. About the beginning of the 16th century, Belfast is described as a town and fortress, but it was in reality a mere fishing village in the hands of the house of O'Neill. In the course of the wars of Gerald Fitzgerald, 8th earl of Kildare, Belfast was twice attacked by him, in 1503 and 1512. The O'Neills, always opposed to the English, had forfeited every baronial right; but in 1552 Hugh O'Neill of Clandeboyne promised allegiance to the reigning monarch, and obtained the castle of Carrickfergus, the town and fortress of Belfast, and all the surrounding lands. Belfast was then restored from the half ruined state into which it had fallen, and the castle was garrisoned. The turbulent successors of O'Neill having been routed by the English, the town and fortress were obtained by grant dated the 16th of November 1571 by Sir Thomas Smith, a favourite of Queen Elizabeth, but were afterwards forfeited by him to the lord deputy Sir Arthur Chichester, who, in 1612, was created Baron Chichester of Belfast. At this time the town consisted of about 120 houses, mostly built of mud and covered with thatch, while the castle, a two-storeyed building, was roofed with shingles. A charter was now granted to the town by James I. (April 27, 1613) constituting it a corporation with a chief magistrate and 12 burgesses and commonalty, with the right of sending two members to parliament. In 1632 Thomas Wentworth, Earl Strafford, was appointed first lord deputy of Ireland, and Belfast soon shared largely in the benefits of his enlightened policy, receiving, among other favours, certain fiscal rights which his lordship had purchased from the corporation of Carrickfergus. Two years after the rebellion of 1641 a rampart was raised round the town, pierced by four gates on the land side. In 1662, as appears by a map

still extant, there were 150 houses within the wall, forming five streets and as many lanes; and the upland districts around were one dense forest of giant oaks and sycamores, yielding an unfailling supply of timber to the woodmen of Carrickfergus.

Throughout the succeeding fifty years the progress of Belfast surpassed that of most other towns in Ireland. Its merchants in 1686 owned forty ships, of a total carrying power of 3300 tons, and the customs collected were close upon £20,000. The old charter was annulled by James II. and a new one issued in 1688, but the old was restored in 1690 by William III. When the king arrived at Belfast in that year there were only two places of worship in the town, the old corporation church in the High Street, and the Presbyterian meeting-house in Rosemary Lane, the Roman Catholics not being permitted to build their chapels within the walls of corporate towns.

At the beginning of the 18th century Belfast had become known as a place of considerable trade, and was then thought a handsome, thriving and well-peopled town, with many new houses and good shops. During the civil commotions which so long afflicted the country, it suffered less than most other places; and it soon afterwards attained the rank of the richest commercial town in the north of Ireland. James Blau and Co. introduced letterpress printing in 1696, and in 1704 issued the first copy of the Bible produced in the island. In September 1737, Henry and Robert Joy started the *Belfast News Letter*. Twenty years afterwards the town contained 1800 houses and 8549 inhabitants, 556 of whom were members of the Church of Rome. It was not, however, till 1789 that Belfast obtained the regular communication, which towns of less importance already enjoyed, with Dublin by stage coach, a fact which is to be explained by the badness of the roads and the steepness of the hills between Newry and Belfast.

The increased freedom of trade with which Ireland was favoured, the introduction of the cotton manufacture by Robert Joy and Thomas M'Cabe in 1777, the establishment in 1791 of shipbuilding on an extensive scale by William Ritchie, an energetic Scotsman, combined with the rope and canvas manufacture already existing, supplied the inhabitants with employments and increased the demand for skilled labour. The population now made rapid strides as well by ordinary extension as by immigration from the rural districts. Owing to the close proximity of powerful opposed religious sects, the modern history of the city is not without its record of riot and bloodshed, as in 1880 and 1886, and in August 1907 serious rioting followed upon a strike of carters; but the prosperity of the city has been happily unaffected.

See George Benn, *History of Belfast* (Belfast, 1877); Robert M. Young, *Historical Notices of Old Belfast* (Belfast, 1896).

BELFAST, a city, port of entry, and the county-seat of Waldo county, Maine, U.S.A., on Belfast Bay (an arm of the Penobscot), and about 32 m. south-south-west of Bangor. Pop. (1890) 5294; (1910) 4618. It is served by the Belfast branch of the Maine Central railway (connecting with the main line at Burnham Junction, 33 m. distant), and by the coasting steamers (from Boston) of the Eastern Steamship Co. The city, a summer resort, lies on an undulating hillside, which rises from the water's edge to a height of more than 150 ft., and commands extensive views of the picturesque islands, headlands, and mountains of the Maine coast. It has a public library. Among the industries of Belfast are trade with the surrounding country, the manufacture of shoes, leather boards, axes, and sashes, doors and blinds, and the building and repairing of boats. Its exports in 1908 were valued at \$285,913 and its imports at \$10,313. Belfast was first settled (by Scottish-Irish) in 1766, and in 1773 was incorporated as a town under its present name (from Belfast, Ireland). The town was almost completely destroyed by the British in 1779, but its rebuilding was begun in the next year. It was held by a British force for five days in September 1814. Belfast was chartered as a city in 1850.

BELFORT, TERRITORY OF, administrative division of eastern France, formed from the southern portion of the department of Haut-Rhin, the rest of which was ceded to Germany by the

of Frankfort (1871). It is bounded on the N.E. and E. by German Alsace, on the S.E. and S. by Switzerland, on the S.W. by the department of Doubs, on the W. by that of Haute-Saône, on the N. by that of Vosges. Pop. (1906), 95,421.

With an area of only 235 sq. m., it is, next to that of Seine, the smallest department of France. The northern part is occupied by the southern offshoots of the Vosges, the southern part by the northern outposts of the Jura. Between these two highlands stretches the Trouée (depression) de Belfort, 18½ m. broad, joining the basins of the Rhine and the Rhone, traversed by the canal from the Rhone to the Rhine and by several railways. A part of the natural highway open from Frankfort to the Mediterranean, the Trouée has from earliest times provided the route for the migration from north to south, and is still of great commercial and strategical value. The northern part, occupied by the Vosges, rises to 4126 ft. in the Ballon d'Alsace, the northern termination and the culminating point of the department; to 3773 ft. in the Planche des Belles-Filles; to 3579 ft. in the Signal des Plaines; to 3534 ft. in the Bärenkopf; and to numerous other lesser heights. South of the Trouée de Belfort, there rise near Delle limestone hills, in part wooded, on the frontiers of France, Alsace, and Switzerland, attaining 1680 ft. in the Forêt de Florimont. The territory between Lachapelle-sous-Rougemont (in the north-east), Belfort and Delle does not rise above 1300 ft. The line of lowest altitude follows the river St Nicolas and the Rhone-Rhine canal. The chief rivers are the Savoureuse, 24 m. long, running straight south from the Ballon d'Alsace, and emptying into the Allaine; the Allaine, from Switzerland, entering the territory a little to the south of Delle, and leaving it a little to the west of Morvillars; the St Nicolas, 24 m. long, from the Bärenkopf, running southwards and then south-west into the Allaine. The climate to the north of the town of Belfort is marked by long and rigorous winters, sudden changes of temperature, and an annual rainfall of 31 in. to 39 in., retained by an impervious subsoil; farther south it is milder and more equable with a rainfall of 23 in. to 31 in., quickly absorbed by the soil or evaporated by the sun. About one-third of the total area is arable land; wheat, oats and rye are the chief cereals; potatoes come next in importance. Forest covers another third of the surface; the chief trees are firs, pines, oak and beech; cherries are largely grown for the distillation of kirsch. Pasture and forage crops cover the remaining third of the Territory; only horned cattle are raised to any extent. There is an unworked concession of copper, silver and lead at Giromagny; and there are also quarries of stone. The Territory is an active industrial region. The two main branches of manufacture are the spinning and weaving of cotton and wool, and the production of iron and iron-goods (wire, railings, nails, files, &c.) and machinery. Belfort has important locomotive and engineering works. Hoisery is manufactured at Delle, watches, clocks, agricultural machinery, petrol motors, ironware and electrical apparatus at the flourishing centre of Beaucourt, and there are numerous saw-mills, tile and brick works and breweries. Imports consist of raw materials for the industries, dyestuffs, coal, wine, &c., and the exports of manufactured goods.

Belfort is the capital of the Territory, which comprises one arrondissement, 6 cantons and 106 communes, and falls within the circumscriptions of the archbishopric, the court of appeal and the académie (educational division) of Besançon. It forms the 7th subdivision of the VII. army corps. Both the Eastern and the Paris-Lyon-Méditerranée railways traverse the Territory, and the canal from the Rhone to the Rhine accompanies the river St Nicolas for about 6 m.

BELFORT, a town of eastern France, capital of the Territory of Belfort, 275 m. E.S.E. of Paris, on the main line of the Eastern railway. Pop. (1906), town, 27,805; commune, 34,040. It is situated among wooded hills on the Savoureuse at the intersection of the roads and railway lines from Paris to Basel and from Lyons to Mülhausen and Strassburg, by which it maintains considerable trade with Germany and Switzerland. The town is divided by the Savoureuse into a new quarter, in which is the

railway station on the right bank, and the old fortified quarter, with the castle, the public buildings and monuments, on the left bank. The church of St Denis, a building in the classical style, erected from 1727 to 1750, and the hôtel de ville (1721-1724) both stand in the Place d'Armes opposite the castle. The two chief monuments commemorate the defence of Belfort in the war of 1870-1871. "The Lion of Belfort," a colossal figure 78 ft. long and 52 ft. high, the work of F. A. Bartholdi, stands in front of the castle; and in the Place d'Armes is the bronze group "Quand Mème" by Antonin Mercié, in memory of Thiers and of Colonel Pierre Marie Aristide Denfert-Rochereau (1823-1878), commandant of the place during the siege. Other objects of interest are the Tour de la Miotte, of unknown origin and date, which stands on the hill of La Miotte to the N.E. of Belfort, and the Port de Brisach, a gateway built by Vauban in 1687. Belfort is the seat of a prefect; its public institutions include tribunals of first instance and of commerce, a chamber of commerce, a lycée, a training-college and a branch of the Bank of France. The construction of locomotives and machinery, carried on by the Société Alsacienne, wire-drawing, and the spinning and weaving of cotton are included among its industries, which together with the population increased greatly owing to the Alscian immigration after 1871. Its trade is in the wines of Alsace, brandy and cereals. The town derives its chief importance from its value as a military position.

After the war of 1870-1871, Belfort, which after a diplomatic struggle remained in French hands, became a frontier fortress of the greatest value, and the old works which underwent the siege of 1870-1871 (see below) were promptly increased and re-modelled. In front of the Perches redoubts, the Bosmont, whence the Prussian engineers began their attack, is now heavily fortified with continuous lines called the *Organisation défensive de Bosmont*. The old Bellevue redoubt (now Fort Denfert-Rochereau) is covered by a new work situated likewise on the ground occupied by the siege trenches in the war. Pérouse, hastily entrenched in 1870, now possesses a permanent fort. The old entrenched camp enclosed by the castle, Fort La Miotte, and Fort Justice, is still maintained, and part even of the enceinte built by Vauban is used for defensive purposes. Outside this improved inner line, which includes the whole area of the attack and defence of 1870, lies a complete circle of detached forts and batteries of modern construction. To the north, Forts Salbert and Roppe form the salients of a long defensive line on high ground, at the centre of which, where the Savoureuse river divides it, a new work was added later. Two works near Giromagny, about 8 m. from Belfort itself, connect the fortress with the right of the defensive line of the Moselle (Fort Ballon d'Alsace). In the eastern sector of the defences (from Roppe to the Savoureuse below Belfort) the forts are about 3 m. from the centre, the works near the Belfort-Mülhausen railway being somewhat more advanced, and in the western (from Salbert to Fort Bois d'Oyé on the lower Savoureuse) they are advanced to about the same distance. The fort of Mont Vaudois, the westernmost, overlooks Héricourt and the battlefield of the Lisaine: farther to the south Montbiériard is also fortified. The perimeter of the Belfort defences is nearly 25 m.

History.—Gallo-Roman remains have been discovered in the vicinity of Belfort, but the place is first heard of in the early part of the 13th century, when it was in the possession of the counts of Montbiériard. From them it passed by marriage to the counts of Ferrette and afterwards to the archdukes of Austria. By the treaty of Westphalia (1648) the town was ceded to Louis XIV. who gave it to Cardinal Mazarin.

In the Thirty Years' War Belfort was twice besieged, 1633 and 1634, and in 1655 there was a battle here between the duke of Lorraine and the allied French and Swedes under Marshal de la Force. The fortifications of Vauban were begun in 1686. Belfort was besieged in 1814 by the troops of the allies and in 1815 by the Austrians.

The most famous episode of the town's history is its gallant and successful defence in the war of 1870-1871.

The events which led up to the siege are described under

FRANCO-GERMAN WAR. Even before the investment Belfort was cut off from the interior of France, and the German corps of von Werder was, throughout the siege, between the fortress and the forces which might attempt its relief. The siege corps was commanded by General von Tresckow and numbered at first 10,000 men with twenty-four field guns—a force which appeared adequate for the reduction of the antiquated works of Vauban. Colonel Denfert-Rochereau was, however, a scientific engineer of advanced ideas as well as a veteran soldier of the Crimea and Algeria, and he had been stationed at Belfort for six years. He was therefore eminently fitted for the command of the fortress. He had as a nucleus but few regular troops, but the energy of the military and civil authorities enabled his force to be augmented by national guards, &c., to 17,600 men. The artillery was very numerous, but skilled gunners were not available in any great strength and ammunition was scarce. Perhaps the most favourable circumstance from a technical point of view was the bomb-proof accommodation of the enceinte.

The old fortress consisted of the town enceinte, the castle (situated on high ground and fortified by several concentric envelopes), and the entrenched camp, a hollow enclosed by continuous lines, the salients of which were the castle, Fort La Justice and Fort La Miotte. These were planned in the days of short-range guns, and were therefore in 1870 open to an overwhelming bombardment by the rifled cannon of the attack. Denfert-Rochereau, however, understood better than other engineers of the day the power of modern artillery, and his plan was to utilize the old works as a keep and an artillery position. The Perches ridge, whence the town and suburbs could be bombarded, he fortified with all possible speed. On the right bank of the Savoureuse he constructed two new forts, Bellevue in the south-west and Des Barres to the west, and, further, he prepared the suburb on this side for a hand-to-hand defence. His general plan was to maintain as advanced a line as possible, to manoeuvre against the investing troops, and to support his own by the long range fire of his rifled guns. With this object he fortified the outlying villages, and when the Germans (chiefly Landwehr) began the investment on the 3rd of November 1870, they encountered everywhere a most strenuous resistance. Throughout the month the garrison made repeated sorties, and the Germans were on several occasions forced by the long range fire of the fortress to evacuate villages which they had taken. Under these circumstances, and also because of their numerical weakness and the rigour of the weather, the Germans advanced but slowly. On the 2nd of December, when at last von Tresckow broke ground for the construction of his batteries, the French still held Danjoutin, Bosmont, Pérouse and the adjacent woods, and, to the northward (on this side the siege was not pressed) La Forge. Thus the first attack of the siege artillery was confined to the western side of the river between Essert and Bavilliers. From this position the bombardment opened on the 3rd of December. Some damage was done to the houses of Belfort, but the garrison was not intimidated, and their artillery replied with such spirit that after some days the German commander gave up the bombardment. On this occasion the distant forts La Miotte and La Justice fired with effect at a range of 4700 yds., affording a conspicuous illustration of the changed conditions of siege-craft. The German batteries, as more guns arrived, were extended from left to right, and on the 13th of December the Bosmont was captured, ground being also gained in front of Bellevue. The difficulties under which the siege corps laboured were very great, and it was not until the 7th of January 1871 that the rightmost battery opened fire. The formal siege of the Perches redoubts had now been decided upon, and as an essential preliminary to further operations, Danjoutin, now isolated, was stormed by the Landwehr on the night of the 7th-8th January. In the meanwhile typhus and smallpox had broken out amongst the French, many of the national guards were impatient of ground and weather, made steady progress towards the Perches. A week after the fall of Danjoutin the victory of von Werder and

the XIV. army corps at the Lisaine, in which a part of the siege corps bore a share, put an end to the attempt to relieve Belfort, and the siege corps was promptly increased to a strength of 17,600 infantry, 4700 artillery and 1100 engineers, with thirty-four field-guns besides the guns and howitzers of the siege train. The investment was now more strictly maintained even on the north side. On the night of the 20th of January the French lines about Pérouse were carried by assault, and, both flanks

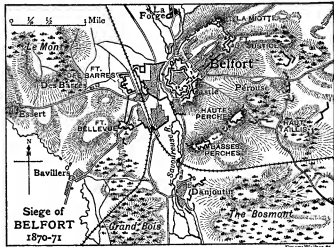

being now cleared, the formal siege of the Perches forts was opened, the first parallel extending from Danjoutin to Haut Taillis. In the early morning of the 27th a determined but premature attempt was made to storm the Perches redoubts, which cost the besiegers nearly 500 men. After this failure Tresckow once more resorted to the regular method of siege approaches, and on the 2nd of February the second parallel was thrown up. La Justice was now bombarded by two new batteries near Pérouse, the Perches were of course subjected to an "artillery attack," and henceforward the besiegers fired 1500 shells a day into the works of the French. But the besiegers were still weak in numbers and their labours were very exhausting. Bellevue and Des Barres became very active in hindering the advance of the siege works, and the German battalions were so far depleted by losses and sickness that they could often muster but 300 men for duty. Still, the guns of the attack were now steadily gaining the upper hand, and at last on the 8th of February the Germans entered the two Perches redoubts. This success, and the arrival of German reinforcements, decided the siege. The Perches ridge was crowned with a parallel and numerous batteries, which in the end mounted ninety-seven guns. The attack on the castle now opened, but operations were soon afterwards suspended by the news that Belfort was now included in the general armistice (February 15th). A little later Denfert-Rochereau received a direct order from his own government to surrender the fortress, and the garrison, being granted free withdrawal, marched out with its arms and trains. "The town had suffered terribly . . . nearly all the buildings were damaged . . . the guns in the upper batteries could only be reached by ladders. The garrison, of its original strength of 17,700 officers and men, had lost 4750, besides 336 citizens. The place was no longer tenable" (Moltke, *Franco-German War*). Nevertheless, "the defence was by no means at its last stage" at the time of the formal surrender (British *Text-Book of Fortification*, 1803). The total loss of the besiegers was about 2000 men.

See J. Liblin, *Belfort et son territoire* (Mülhausen, 1887).

BELFRY (Mid. Eng. *berfrey*, through Med. Lat. *berfredus*, from Teut. *bergrîd* or *bercric*, which, according to the *New Eng. Dict.*, is a combination of *bergen*, to protect, and *frida*, safety or peace; the word thus meaning a shelter; the change from *r* to *l*.—cf. *almery* for *armarium*,—wrongly associated the origin of the word with "bell," and aided the restriction in meaning), a word in medieval siege-craft for a movable

wooden tower of several stages, protected with raw hides, used for purposes of attack; also a watch-tower, particularly one with an alarm bell; hence any detached tower or campanile containing bells, as at Evesham, but more generally the ringing room or loft of the tower of a church (see TOWER).

BELGAE, a Celtic people first mentioned by Caesar, who states that they formed the third part of Gaul, and were separated from the Celtae by the Sequana (Seine) and Matrona (Marne). On the east and north their boundary was the lower Rhine, on the west the ocean. Whether Caesar means to include the Leuci, Treviri and Mediomatrici among the Belgian tribes is uncertain. According to the statement of the deputation from the Remi to Caesar (*Bell. Gall. ii. 4*), the Belgae were a people of German origin, who had crossed the Rhine in early times and driven out the Galli. But Caesar's own statement (*B.G. i. 1*) that the Belgae differed from the Celtae in language, institutions and laws, is too sweeping (see Strabo *iv. p. 176*), at least as regards language, for many words and names are common to both. In any case, only the eastern districts would have been affected by invaders from over the Rhine, the chief seat of the Belgae proper being in the west, the country occupied by the Bellovaci, Ambiani and Atrebatres, to which it is probable (although the reading is uncertain) that Caesar gives the distinctive name Belgium (corresponding to the old provinces of Picardy and Artois). The question is fully discussed by T. R. Holmes (*Caesar's Conquest of Gaul, 1899*), who comes to the conclusion that "when the Roman delegates told Caesar that the Belgae were descended from the Germans, they probably only meant that the ancestors of the Belgic conquerors had formerly dwelt in Germany, and this is equally true of the ancestors of the Gauls who gave their name to the Celtae; but, on the other hand, it is quite possible that in the veins of some of the Belgae flowed the blood of genuine German forefathers." W. Ridgeway (*Early Age of Greece, 1901*) considers that the Belgic tribes were Cimbri, "who had moved directly across the Rhine into north-eastern Gaul." No definite number of Belgian tribes is given by Caesar; according to Strabo (*iv. p. 196*) they were fifteen in all. The Belgae had also made their way over to Britain in Caesar's time (*B.G. ii. 4, v. 12*), and settled in some of the southern counties (Wilts, Hants and Somerset). Among their towns were *Magnus Portus* (Portsmouth) and *Venta Belgarum* (Winchester).

In 57 B.C., after the defeat of Ariovistus, the Belgae formed a coalition against Caesar, and in 52 took part in the general rising under Vercingetorix. After their final subjugation, Caesar combined the territory of the Belgae, Celtae and Aquitani into a single province (Gallia Comata). Augustus, however, finding it too unwieldy, again divided it into three provinces, one of which was Belgica, bounded on the west by the Seine and the Arar (Saône); on the north by the North Sea; on the east by the Rhine from its mouth to the Lacus Brigantinus (Lake Constance). Its southernmost district embraced the west of Switzerland. The capital and residence of the governor of the province was Durocororum Remorum (Reims). Under Diocletian, Belgica Prima (capital, Augusta Treverorum, Trier) and Secunda (capital, Reims) formed part of the "diocese" of Gaul.

See A. G. B. Schayes, *La Belgique et les Pays-Bas avant et pendant la domination romaine* (2nd ed., Brussels, 1877); H. G. Moke, *La Belgique ancienne* (Ghent, 1855); A. Desjardins, *Géographie historique de la Gaule*, ii. (1878); T. R. Holmes, *Caesar's Conquest of Gaul* (1899); M. Ihm in Pauly-Wissowa's *Realencyclopädie*, iii. pt. 1 (1897); J. Jung, "Geographie von Italien und dem Orbis romanus" (2nd ed., 1897), in I. Müller's *Handbuch der klassischen Altertumswissenschaft*.

BELGARD, a town of Germany, in the Prussian province of Pomerania, at the junction of the rivers Leitznitz and Persante, 22 m. S.E. of Kolberg by rail. Pop. (1900) 8047. Its industries consist of iron founding and cloth weaving, and there are considerable horse and cattle markets.

BELGAUM, a town and district of British India, in the southern division of Bombay. The town is situated nearly 2500 ft. above sea-level; it has a station on the Southern Mahratta railway, 245 m. S. of Poona. It has an ancient fortress, dating apparently from 1519, covering about 100 acres, and surrounded

by a ditch; within it are two interesting Jain temples. Belgaum contains a cantonment which is the headquarters of a brigade in the 6th division of the western army corps. It is also a considerable centre of trade and of cotton weaving. There are cotton mills. Pop. (1901) 36,878.

The district of Belgaum has an area of 4649 sq. m. To the north and east the country is open and well cultivated, but to the south it is intersected by spurs of the Sahyadri range, thickly covered in some places with forest. In 1901 the population was 993,976, showing a decrease of 2% compared with an increase of 17% in the preceding decade. The principal crops are millet, rice, wheat, other food-grains, pulse, oil-seeds, cotton, sugarcane, spices and tobacco. There are considerable manufactures of cotton-cloth. The town of Gokak is known for its dyes, its paper and its wooden and earthenware toys. The West Deccan line of the Southern Mahratta railway runs through the district from north to south. Two high schools at Belgaum town are maintained by government and by the London Mission. The Kurirs, a wandering and thieving tribe, the Kainais, professional burglars, and the Baruds, cattle-stealers and highwaymen, are notorious among the criminal classes.

History.—The ancient name of the town of Belgaum was Venugrama, which is said to be derived from the bamboos that are characteristic of its neighbourhood. The most ancient place in the district is Halsi; and this, according to inscriptions on copper plates discovered in its neighbourhood, was once the capital of a dynasty of nine Kadamba kings. It appears that from the middle of the 6th century A.D. to about 760 the country was held by the Chalukyas, who were succeeded by the Rashtrakutas. After the break-up of the Rashtrakuta power a portion of it survived in the Rattas (875-1250), who from 1210 onward made Venugrama their capital. Inscriptions give evidence of a long struggle between the Rattas and the Kadambas of Goa, who succeeded in the latter years of the 12th century in acquiring and holding part of the district. By 1208, however, the Kadambas had been overthrown by the Rattas, who in their turn succumbed to the Yadavas of Devagiri in 1250. After the overthrow of the Yadavas by the Delhi emperor (1320), Belgaum was for a short time under the rule of the latter; but only a few years later the part south of the Ghatpraha was subject to the Hindu rajahs of Vijayanagar. In 1347 the northern part was conquered by the Bahmani dynasty, which in 1473 took the town of Belgaum and conquered the southern part also. When Aurungzeb overthrew the Bijapur sultans in 1686, Belgaum passed to the Moguls. In 1776 the country was overrun by Hyder Ali, but was retaken by the Peshwa with British assistance. In 1818 it was handed over to the East India Company and was made part of the district of Dharwar. In 1836 this was divided into two parts, the southern district continuing to be known as Dharwar, the northern as Belgaum.

See *Imp. Gazetteer of India* (Oxford, ed. 1908), 5.2.

BELGIAN CONGO, a Belgian colony in Equatorial Africa occupying the greater part of the basin of the Congo river. Formerly the Independent State of the Congo, it was annexed to Belgium in 1908. (See CONGO FREE STATE.)

BELGIUM (Fr. *Belgique*; Flem. *Belgie*), an independent, constitutional and neutral state occupying an important position in north-west Europe. It was formerly part of the Low Countries or Netherlands (*q.v.*). Although the name Belgium only came into general use with the foundation of the modern kingdom in 1830, its derivation from ancient times is clear and incontrovertible. Beginning with the Belgae and the Gallia Belgica of the Romans, the use of the adjective to distinguish the inhabitants of the south Netherlands can be traced through all stages of subsequent history. During the Crusades, and in the middle ages, the term *Belgicae principes* is of frequent occurrence, and when in 1790 the Walloons rose against Austria during what was called the Brabant revolution, their leaders proposed to give the country the name of Belgique. Again in 1814, on the expulsion of the French, when there was much talk of founding an independent state, the same name was suggested for it. It was not till sixteen years later, on the collapse of the united kingdom of

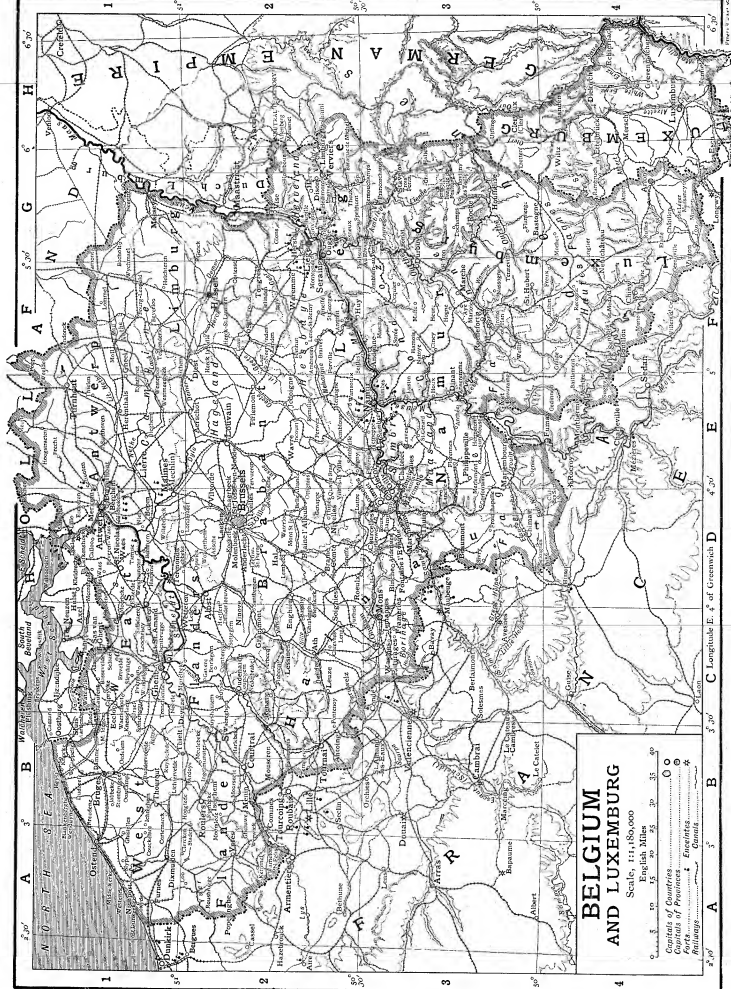

**BELGIUM
AND LUXEMBURG**

Scale: 1:1,800,000
English Miles

Capitals of Countries **O**
 Capitals of Provinces **o**
 Ports **⊙**
 Enclosures *****
 Railways **—+—**
 Canals **—#—**

the Netherlands, that the occasion presented itself for giving effect to this proposal. For the explanation of the English form of the name it may be mentioned that Belgium was a canton of what had been the Nervian country in the time of the Roman occupation.

Topography, &c.—Belgium lies between $49^{\circ} 30'$ and $51^{\circ} 30' N.$, and $2^{\circ} 32'$ and $6^{\circ} 7' E.$, and on the land side is bounded by Holland on the N. and N.E., by Prussia and the grand duchy of Luxemburg on the E. and S.E., and by France on the S. Its land frontiers measure 793 m., divided as follows:—with Holland 269 m., with Prussia 60 m., with the grand duchy 80 m. and with France 384 m. In addition it has a sea-coast of 42 m. The western portion of Belgium, consisting of the two Flanders, Antwerp and parts of Brabant and Hainaut, is flat, being little above the level of the sea; and indeed at one point near Furnes it is 7 ft. below it. The same description applies more or less to the north-east, but in the south of Hainaut and the greater part of Brabant the general level of the country is about 300 ft. above the sea, with altitudes rising to more than 600 ft. South of the Meuse, and in the district distinguished by the appellation "Between Sambre and Meuse," the level is still greater, and the whole of the province of Luxemburg is above 500 ft., with altitudes up to 1650 ft. In the south-eastern part of the province of Liège there are several points exceeding 2000 ft. The highest of these is the Baraque de Michel close to the Prussian frontier, with an altitude of 2190 ft. The Baraque de Fraiture, north-east of La Roche, is over 2000 ft. While the greater part of western and northern Belgium is devoid of the picturesque, the Ardennes and the Fagnes districts of "Between Sambre and Meuse" and Liège contain much pleasant and some romantic scenery. The principal charm of this region is derived from its fine and extensive woods, of which that called St Hubert is the best known. There are no lakes in Belgium, but otherwise it is exceedingly well watered, being traversed by the Meuse for the greater part of its course, as well as by the Scheldt and the Sambre. The numerous affluents of these rivers, such as the Lys, Dyle, Dender, Ourthe, Amblève, Vesdre, Lesse and Semois, provide a system of waterways almost unique in Europe. The canals of Belgium are scarcely less numerous or important than those of Holland, especially in Flanders, where they give a distinctive character to the country. But the most striking feature in Belgium, where so much is modern, utilitarian and ugly, is found in the older cities with their relics of medieval greatness, and their recrd of ancient fame. These, in their order of interest, are Bruges, Antwerp, Louvain, Brussels, Ghent, Ypres, Courtrai, Tournai, Furnes, Oudenarde and Liège. It is to them rather than to the sylvan scenes of the Ardennes that travellers and tourists flock.

The climate may be described as temperate and approximating to that of southern England, but it is somewhat hotter in summer and a little colder in winter. In the Ardennes, owing to the greater elevation, the winters are more severe.

Geology.—Belgium lies upon the northern side of an ancient mountain chain which has long been worn down to a low level and the remnants of which rise to the surface in the Ardennes, and extend eastward into Germany, forming the Eifel and Westwald, the Hunsrück and the Taunus. Westward the chain lies buried beneath the Mesozoic and Tertiary beds of Belgium and the north of France, but it reappears in the west of England and Ireland. It is the "Hercynian chain" of Marcel Bertrand, and is composed entirely of Palaeozoic rocks. Upon its northern margin lie the nearly undisturbed Cretaceous and Tertiary beds which cover the greater part of Belgium. The latest beds which are involved in the folds of this mountain range belong to the Coal Measures, and the final elevation must have taken place towards the close of the Carboniferous period. The fact that in Belgium Jurassic beds are found upon the southern and not upon the northern margin indicates that in this region the chain was still a ridge in Jurassic times. In the Ardennes the rocks which constitute the ancient mountain chain belong chiefly to the Devonian System, but Cambrian beds rise through the Devonian strata, forming the masses of Rocroi,

Stavelot, &c., which appear to have been islands in the Devonian sea. The Ordovician and Silurian are absent here, and the Devonian rests unconformably upon the Cambrian; but along the northern margin of the Palaeozoic area, Ordovician and Silurian rocks appear, and beds of similar age are also exposed farther north where the rivers have cut through the overlying Tertiary deposits. Carboniferous beds occur in the north of the Palaeozoic area. Near Dinant they are folded amongst the Devonian beds, but the most important band runs along the northern border of the Ardennes. In this band lie the coalfields of Liège, and of Mons and Charleroi. It is a long and narrow trough, which is separated from the older rocks of the Ardennes by a great reversed fault, the *faïlle du midi*. In the southern half of the trough the folding of the Coal Measures is intense; in the northern half it is much less violent. The structure is complicated by a thrust-plane which brings a mass of older beds upon the Coal Measures in the middle of the trough. Except along the southern border of the Ardennes, and at one or two points in the middle of the Palaeozoic massif, Triassic and Jurassic beds are unknown in Belgium, and the Palaeozoic rocks are directly and unconformably overlaid by Cretaceous and Tertiary deposits. The Cretaceous beds are not extensive, but the Wealden deposits of Bernissart, with their numerous remains of Iguanodon, and the chalk of the district about the Dutch frontier near Maastricht, with its very late Cretaceous fauna, are of special interest.

Exclusive of the Ardennes the greater part of Belgium is covered by Tertiary deposits. The Eocene, consisting chiefly of sands and marls, occupies the whole of the west of the country. The Oligocene forms a band stretching from Antwerp to Maastricht, and this is followed towards the north by a discontinuous strip of Miocene and a fairly extensive area of Pliocene. The Tertiary deposits are similar in general character to those of the north of France and the south of England. Coal and iron are by far the most important mineral productions of Belgium. Zinc, lead and copper are also extensively worked in the Palaeozoic rocks of the Ardennes.

Area and Population.—The area comprises 2,945,503 hectares, or about 11,373 English sq. m., and the total population in December 1904 was 7,074,910, giving an average of 600 per sq. m.

The Nine Provinces.	Area in English sq. m.	Population at end of 1904.	Population per sq. m. 1904.
Antwerp . . .	1093	888,980	813.3
Brabant . . .	1268	1,366,389	1077.59
Flanders E. . .	1158	1,078,507	931.35
Flanders W. . .	1249	845,732	677.8
Hainaut . . .	1437	1,192,967	830.18
Liège . . .	1117	863,254	772.8
Limburg . . .	931	255,359	274.28
Luxemburg . . .	1706	225,963	132.45
Namur . . .	1414	357,759	253
Total . . .	11,373	7,074,910	622

The population was made up of 3,514,491 males and 3,560,419 females. The rate at which the population has increased is shown as follows:—From 1880 to 1890 the increase was at the rate annually of 54,931, from 1890 to 1900 at the rate of 62,421, and for the five years from 1900 to 1904 at the rate of 66,200. In 1831 the population of Belgium was 3,785,814, so that in 75 years it had not quite doubled. The following table gives the total births and deaths in certain years since 1880:—

Year.	Total births.	Total deaths.	Excess of births.
1880 . . .	171,864	123,323	48,541
1895 . . .	183,015	125,148	57,867
1900 . . .	193,789	129,046	64,743
1904 . . .	191,721	119,506	72,215

These figures show that the births were 23,674 more in 1904 than in 1880, while the deaths were nearly 4000 fewer, with a population that had increased from $3\frac{1}{2}$ to 7 millions. Of 191,721 births in 1904, 12,887 or 6.7% were illegitimate. Statistics of

recent years show a slight increase in legitimate and a slight decrease in illegitimate births.

The emigration of Belgians from their country is small and reveals little variation. In 1900, 13,492 emigrated, and in 1904 the total rose only to 14,752. Of Belgians living abroad it is estimated that 400,000 reside in France, 15,000 in Holland, 12,000 in Germany and 4600 in Great Britain. The number of Belgians in the Congo State in 1904 was 1505. The number of foreigners resident in Belgium in 1900 with their nationalities were Germans, 42,079; English, 5096; French, 85,735; Dutch, 54,491; Luxemburgers, 9762; and all other nationalities, 14,411.

With regard to the languages spoken by the people of Belgium the following comparative table gives the return for the three censuses of 1880, 1890 and 1900:—

	1880.	1890.	1900.
French only	2,230,316	2,485,072	2,574,805
Flemish only	2,485,384	2,744,271	2,822,005
German only	39,550	32,206	28,314
French and Flemish	423,752	700,997	801,587
French and German	35,250	58,590	66,447
Flemish and German	2,956	7,028	7,238
The three languages	13,331	13,185	42,889

Constitution and Government.—The Belgian constitution, drafted by the national assembly in 1830-1831 after the provisional government had announced that "the Belgian provinces detached by force from Holland shall form an independent state," was published on the 7th of February 1831, and the modifications introduced into it subsequently, apart from the composition of the electorate, have been few and unimportant. The constitution originally contained one hundred and thirty-nine articles, and decreed in the first place that the government was to be "a constitutional, representative and hereditary monarchy." Having decided in favour of a monarchy, the provisional government first offered the throne to the duc de Nemours, son of Louis-Philippe, but this offer was promptly withdrawn on the discovery that Europe would not endorse it. It was then offered to Prince Leopold of Saxe-Coburg, widower of the princess Charlotte of England, and accepted by him. The prince was proclaimed on the 4th of June 1831 as Leopold I., king of the Belgians, and on the 21st of July 1831 he was solemnly inaugurated in Brussels. The succession is vested in the heirs male of Leopold I., and should they ever make complete default the throne will be declared vacant, and a national assembly composed of the two chambers elected in double strength will make a fresh nomination. In 1894 a new article numbered 61 was inserted in the constitution providing that "in default of male heirs the king can nominate his successor with the assent of the two chambers, and if no such nomination has been made the throne shall be vacant," when the original procedure of the constitution would be followed. The Belgian national assembly assumed that its constitution would extend over the whole of the Belgic or south Netherlands, but the powers decreed otherwise. The limits of Belgium are fixed by the London protocol of the 15th of October 1831—also called the twenty-four articles—which cut off what is now termed the grand duchy of Luxembourg, and also a good portion of the duchy of Limburg. These losses of territory held by a brother people are still felt as a grievance by many Belgians. The Belgian constitution stipulates for "freedom of conscience, of education, of the press and also of the right of meeting," but the sovereign must be a member of the Church of Rome. The government was to consist of the king, the senate and the chamber of representatives. The functions of the king are those that appertain everywhere to the sovereign of a constitutional state. He is the head of the army and has the exclusive right of dissolving the chambers as preliminary to an appeal to the country.

The senate is composed of seventy-six elected members and twenty-six members nominated by the provincial councils. A senator sits for eight years unless a dissolution is ordered, and no one is eligible until he is forty years of age. Half the

seventy-six elected senators retire for re-election every four years. There is no payment or other privilege, except a pass on the state railways, attached to the rank of senator. The chamber of representatives contained one hundred and fifty-two members until 1890, when the number was increased to one hundred and sixty-six. Deputies are elected for four years, but half the house is re-elected every two years. A deputy must be twenty-five years of age, and the members of both houses must be of Belgian nationality, born or naturalized. A deputy receives an annual honorarium of 4000 francs and a railway pass. Down to 1893 the electorate was exceedingly small. Property and other qualifications kept the voting power in the hands of a limited class. This may be judged from the fact that in the year named there were only 137,772 voters out of a population of 6½ millions. In April 1894 the new electoral law altered the whole system. The property qualification was removed and every Belgian was given one vote on attaining twenty-five years of age and after one year's residence in his commune. At the same time the principle of multiple votes for certain qualifications was introduced. The Belgian citizen on reaching the age of thirty-five, providing he is married or is a widower with legitimate offspring and pays five francs of direct taxes, gets a second vote. Two extra votes are given for qualifications of property, official status or university diplomas. The maximum voting power of any individual is three votes. In 1904 there were 1,581,640 voters, possessing 2,467,065 votes. This system of plural voting has proved a success. It does not, however, satisfy the Socialists, whose formula is one man, one vote. The final change in the system of parliamentary elections was made in 1890-1900, when proportional representation was introduced. Proportional representation aims at the protection of minorities, and its working out is a little intricate, or at all events difficult to describe. The following has been accepted as a clear definition of what proportional representation is:—"Each electoral district has the number of its members apportioned in accordance with the total strength of each party or political programme in that district. As a rule there are only the three chief parties, viz. Catholic, Liberal and Socialist, but the presence of Catholic-Democrats or some other new faction may increase the total to four or even five. The number of seats to be filled is divided by the number of parties or candidates, and then they are distributed in the proportion of the total followers or voters of each. The smallest minority is thus sure of one seat." An illustration may make this clearer. In an electoral district with 32,000 votes which returns eight deputies, four parties send up candidates, let us say, eight Catholics, eight Liberals, eight Socialists and one Catholic-Democrat. The result of the voting is, 16,000 Catholic votes, 9000 Liberal, 4500 Socialist, and 2500 Catholic-Democrat. The seats would, therefore, be apportioned as follows: four Catholic, two Liberal, one Socialist and one Catholic-Democrat.

The king has one right which other constitutional rulers do not possess. He can initiate proposals for new laws (*projets de loi*). He is also charged with the executive power which he delegates to a cabinet composed of ministers chosen from the party representing the majority in the chamber. Down to 1884 the Liberal party had held power with very few intervals since 1840. The Catholic party succeeded to office in 1884. The ministers represent departments for finance, foreign affairs, colonies, justice, the interior, science and arts, war, railways, posts and telegraphs, agriculture, public works, and industry and labour. The minister for war is generally a soldier, the others are civilians. Ministers may be members of either chamber and enjoy the privilege of being allowed to speak in both. Sometimes one minister will hold several portfolios at the same time, but such cases are rare.

The kingdom is divided into nine provinces which are subdivided into 342 cantons and 2623 communes. The provinces are governed by a governor nominated by the king, the canton is a judicial division for marking the limit of the jurisdiction of each *juge de paix*, and the commune is the administrative unit,

possessing self-government in all local matters. For each commune of 5000 inhabitants or over, a burgomaster is appointed by the communal council which is chosen by the electors of the commune. As three years' residence is required these electors are fewer in number than those for the legislature. In 1902 there were 1,146,482 voters with 2,007,704 votes, the principles of multiple votes, with, however, a maximum of four votes and proportional representation, being in force for communal as for legislative elections.

Religion.—The constitution provides for absolute liberty of conscience and there is no state religion, but the people are almost to a man Roman Catholics. It is computed that there are 10,000 Protestants (half English) and 5000 Jews, and that all the rest are Catholics. The government in 1904 voted nearly 7,000,000 francs in aid of the religious establishments of, and the benevolent institutions kept up by, the Roman Church. The grant to other cults amounted to 118,000 francs, but small as this sum may appear it is in due proportion to the relative numbers of each creed. The hierarchy of the Church of Rome in Belgium is composed of the archbishop of Malines, and the bishops of Liège, Ghent, Bruges, Tournai and Namur. The archbishop receives £800, and the bishops £600 apiece from the state yearly. The pay of the village *curé* averages £80 a year and a house. Besides the regular clergy there are the members of the numerous monastic and conventual houses established in Belgium. They are engaged principally in educational and eleemosynary work, and the development in such institutions is considerable.

Education.—Education, though not obligatory, is free for those who cannot pay for it. In the primary schools instruction in reading, writing, arithmetic, history and geography is obligatory. In 1904 there were 7092 primary schools with 859,436 pupils of both sexes. Of these 807,383 did not pay. Primary education is supposed to continue till the age of fourteen, but in practice it stops at twelve for all who do not intend to pass through the middle schools, which is essential for all persons seeking state employment of any kind. The middle schools have one privilege. They can give a certificate qualifying scholars for a mastership in the primary schools, which are under the full control of the communes. These appointments are always bestowed on local favorites. The pay of a schoolmaster in a small commune is only £48, and in a large town £96, with a maximum ranging from £80 to £152 after twenty-four years' service. It is therefore clear that no very high qualifications could be expected from such a staff. The control of the state comes in to the extent of providing district inspectors who visit the schools once a year, and hold a meeting of the teachers in their district once a quarter. In each province there is a chief inspector who is bound to visit each school once in two years, and reports direct to the minister of public instruction. With regard to the middle schools, the government has reserved the right to appoint the teaching staff, and to prescribe the books that are to be used. The results of the middle schools are fairly satisfactory. Still better are the *Athénées Royaux*, twenty in number, which are quite independent of the commune and subject to official control under the superior direction of the king. Mathematics and classics are taught in them and the masters are allowed to take boarders. The expenditure of the state on education amounts to about a million sterling. In 1860 the grants were only for little over one-eighth of the total in 1903. In 1900 31.04% of the total population was illiterate. Considerable progress in the education of the people is made visible by a comparison of the figures of three decennial censuses. In 1880 the illiterate were 42.25% and in 1890 37.63, so that there was a further marked improvement by 1900. Among the provinces Wallon Belgium is better instructed than Flemish, Luxemburg coming first, followed by Namur, Liège and Brabant in their order.

Higher instruction is given at the universities and in the schools attached thereto. Those at Ghent and Liège are state universities; the two others at Brussels and Louvain are free.

At Louvain alone is there a faculty of theology. The number of students inscribed for the academical year 1904-1905 at each university was Ghent 890, Liège 1983, Brussels 1082, and Louvain 2134, or a grand total of 6098. Liège is specially famed for the technical schools attached to it. There are also a large number of state-aided schools for special purposes; (1) for military instruction, there are the *École Militaire* at Brussels, the school of cadets at Namur, and army schools at different stations, e.g. Bouillon, &c. For officers in the army, there are the *École de Guerre* or staff college at Brussels with an average attendance of twenty, a riding school at Ypres where a course is obligatory for the cavalry and horse artillery, and for soldiers in the army there are regimental schools and evening classes for illiterate soldiers. (2) For education in the arts, there is the Royal Academy of Fine Arts at Antwerp, and besides this famous school of painting there are eighty-four academies for teaching drawing throughout the kingdom. In music, there are royal conservatoires at Brussels, Antwerp, Ghent, and Liège. Besides these there are sixty-nine minor conservatoires. (3) For commercial and professional education, there are 181 schools. The Commercial Institute of Antwerp deserves special notice as an excellent school for clerks. (4) Among special schools may be named the three schools of navigation at Antwerp, Ostend and Nieuport. Since the wreck of the training-ship "Comte de Smet de Naeyer" in 1906, it has been decided that a stationary training-ship shall be placed in the Scheldt like the "Worcester" on the Thames. Among the numerous learned societies may be mentioned the Belgian Royal Academy founded in 1769 and revived in 1818. For the encouragement of research and literary style the government awards periodical prizes which are very keenly contested.

Justice.—The administration of justice is very fully organized, and in the Code Belge, which was carefully compiled between 1831 and 1836 from the old laws of the nine provinces leavened by the Code Napoléon and modern exigencies, the Belgians claim that they possess an almost perfect statute-book. The courts of law in their order are *Cour de Cassation*, *Cour d'Appel*, *Cour de Première Instance*, and the *Juge de Paix* courts, one for each of the 342 cantons. The *Cour de Cassation* has a peculiar judicial sphere. It works automatically, examining every judgment to see if it is in strict accord with the code, and where it is not the decision or verdict is simply annulled. There is only one judge in this court, but he has the assistance of a large staff of revisers. The *Cour de Cassation* never tries a case itself except when a minister of state is the accused. The president of this tribunal is the highest legal functionary in Belgium. There are three courts of appeal, viz. at Brussels, Ghent and Liège. At Brussels there are four separate chambers or tribunals in the appeal court. Judges of appeal are appointed by the king for life from lists of eligible barristers prepared by the senate and the courts. Judges can only be removed by the unanimous vote of their brother judges. There are twenty-six courts of first instance distributed among the principal towns of the kingdom, and in Antwerp, Ghent and Liège there are besides special tribunals for the settlement of commercial cases. Of course there is the right of appeal from the decisions of these tribunals as well as of the regular courts. Finally the 342 *Juge de Paix* courts the tribunals British county courts. Criminal cases are tried by (1) the *Tribunaux de Police*, (2) *Tribunaux Correctionnels*, (3) and the *Cours d'Assises*. The last are held as the length of the calendar requires. Capital punishment is retained on the statute, but is never enforced, the prisoner on whom sentence of death is passed in due form in open court being relegated to imprisonment for life in solitary confinement and perpetual silence. The chief prisons are at Louvain, Ghent and St Gilles (Brussels), and the last named serves as a house of detention. At Merxplas, near the Dutch frontier, is the agricultural criminal colony at which an average number of two thousand prisoners are kept employed in comparative liberty within the radius of the convict settlement.

Pauperism.—For the relief of pauperism there are a limited number of houses of mendicity, in which inmates are received,

and houses of refuge for night shelter. At the *beguinages* of Ghent and Bruges women and girls able to contribute a specified sum towards their support are given a home.

National Finance.—The budget is submitted to the chambers by the minister of finance and passed by them. The revenue and expenditure were in the years stated as follows:—

Year.	Revenue.	Expenditure.
1880	394,215,932 francs	382,908,429 francs
1895	395,730,445 "	410,383,402 "
1903	632,416,810 "	627,975,568 "

The revenue is made up from taxes, including customs, tolls, including returns from railway traffic, &c., and the balance comes from various revenues, return of capital, loans, &c. The following are the principal items of expenditure (1903):—

Service of debt	143,065,352 francs
Sovereign, senate, chamber, &c.	5,289,087 "
Departments, foreign office	3,751,636 "
" agriculture	12,253,957 "
" railways	165,086,019 "
" finance	34,479,674 "
" industry	19,905,589 "
" war	63,972,473 "
" public instruction	31,799,105 "
" justice	27,168,032 "
Minor items	4,179,046 "
Total	510,949,970 "

The difference is made up of "special expenditure." The total debt in English money may be put at 126 millions sterling, which requires for interest, sinking fund and service about 5½ millions sterling annually. The rate of interest on all the loans extant is 3%, except on one loan of 219,959,632 francs, which pays only 2½%.

Army and National Defence.—The army is divided into the regular army, the gendarmerie, and the *garde civique*. The Belgian regular army is thus composed: infantry, one regiment of carabiniers, one of grenadiers, three of *chasseurs à pied*, and fourteen of the line, all these regiments having 3 or 4 active and 3 or 4 reserve battalions apiece; cavalry, two regiments of guides, two of *chasseurs à cheval*, and four of lancers, all light cavalry; artillery, four horse, thirty field, and seventy siege batteries on active service; engineers, 140 officers and 2000 men. The train or commissariat has only 30 officers and 600 men on the permanent establishment. Belgium retains the older form of conscription, and has not adopted the system of "universal service." The annual levy is small and substitution is permitted. In 1904 the number inscribed for service was 64,042. Of these only 12,525 were enrolled in the army, and of that number 1421 were volunteers, who took an engagement on receipt of a premium. The effective strength of the army in 1904 with the colours was 3406 officers and 40,382 men. To this total has to be added the men on the active list, but either absent on leave or allowed to return to civil life, numbering 70,043. It is assumed that on mobilization these men are immediately available. The reserve consists of 181 officers and 58,014 men, so that the total strength of the Belgian army is 3587 officers and 168,439 men. The field force in war is organized in four infantry and two cavalry divisions, the total strength being about 100,000. The peace effective has not varied much since 1870, but the total paper strength is 75,000 more than in that year. In the years 1900-1904 it increased by 8000 men. The gendarmerie is a mounted force composed of men picked for their physique and divided into three divisions. It numbers 67 officers and 3079 men, but has no reserve. It is in every sense a *corps d'élite*, and may be classed as first-rate heavy cavalry. The total strength of the *garde civique* in 1905 was 35,102, to which have to be added 8532 volunteers belonging to the corps of older formation, service in which counts on a par with the *garde civique*. Some of the latter regiments, especially the artillery, would rank with British volunteers, but the mass of the *garde civique* does not pretend to possess military value. It is a defence against sedition and socialism. The defence of

Belgium depends on five fortified positions. The fortified position and camp of Antwerp represents the true base of the national defence. Its detached forts shelter the city from bombardment, and so long as sea communication is open with England, Antwerp would be practically impregnable. The fortified with twelve forts and Namur with nine forts are the *lieux de pont* protecting the two most important passages of the Meuse. The forts are constructed in concrete with armoured cupolas. Termonde on the Scheldt and Diest on the Dender are retained as nominally fortified positions, but neither could resist a regular bombardment for more than a few hours, as their casemates are not bomb-proof.

The training camp of the Belgian army is at Beverloo in the province of Limburg, and at Braschaet not far from Antwerp are ranges for artillery as well as rifle practice. The Belgian officer is technically as well trained and educated as any in Europe, but he lacks practical experience in military service.

Mines and Industry.—The principal mineral produced in Belgium is coal. This is found in the Borinage district near Mons and in the neighbourhood of Liège, but the working of an entirely new coal-field, which promises to attain vast dimensions, was commenced in 1906 in the Campine district of the province of Limburg. The coal mines of Belgium give employment to nearly 150,000 persons, and for some years the average output has exceeded 22,000,000 tons. Other minerals are iron, manganese, lead and zinc. The iron mines produce much less than formerly, and the want of iron is a grave defect in Belgian prosperity, as about £5,000,000 sterling worth of iron has to be imported annually, chiefly from French Lorraine. The chief metal industry of the country is represented by the iron and steel works of Charleroi and Liège. Belgium is particularly rich in quarries of marble, granite and slate. Ghent is the capital of the textile industry, and all the towns of Flanders are actively engaged in producing woollen and cotton materials and in lace manufacture. The bulk of the population is, however, engaged in agriculture, and the extent of land under cultivation of all kinds is about 6½ million acres.

Commerce.—The trade returns for 1904 were as follows:—

Imports—		
General Commerce	(included in General Commerce)	4,426,400,000 francs
Special Commerce		2,782,200,000 "
Exports—		
General Commerce	(included in General Commerce)	3,849,100,000 "
Special Commerce		2,183,300,000 "

The general commerce includes goods in transit across Belgium, the special commerce takes into account only the produce and the consumption of Belgium itself. The trade of Belgium has more than trebled as regards both imports and exports since 1870. The following table shows the amount of exports and imports between Belgium and the more important foreign states:—

	Imports.	Exports.
France	465,684,000 francs	346,670,000 francs
Germany	351,025,000 "	505,473,000 "
England	335,404,000 "	392,324,000 "
Holland	240,873,000 "	268,781,000 "
United States	222,301,000 "	86,324,000 "
Russia	212,119,000 "	26,671,000 "
Argentina	198,913,000 "	41,508,000 "
British India	141,669,000 "	25,860,000 "
Rumania	102,174,000 "	3,949,000 "
Australia	58,190,000 "	12,087,000 "
Congo State	53,100,000 "	14,049,000 "
China	8,770,000 "	25,546,000 "

In the relative magnitude of the annual value of its commerce, excluding that in transit, Belgium stands sixth among the nations of the world, following Great Britain, the United States, Germany, France and Holland. The principal imports are food supplies and raw material such as cotton, wool, silk, flax, hemp and jute. Among minerals, iron ore, sulphur, copper, coal, tin, lead and diamonds are the most imported. The exports of greatest value

are textiles, lace, coal, coke, briquettes, glass, machinery, railway material and fire arms.

Shipping and Navigation.—Belgium has no state navy, although various proposals have been made from time to time to establish an armed flotilla in connexion with the defence of Antwerp. The state, however, possesses a certain number of steamers. In 1904 they numbered sixty-five of 99,893 tons. These steamers are chiefly employed on the passenger route between Ostend and Dover. The total number of vessels entering the only two ports of Belgium which carry on ocean commerce, namely Antwerp and Ostend, in 1904 was 7650 of a tonnage of 10,330,127. Among inland ports that of Ghent is the most important, 1127 ships of a tonnage of 786,362 having entered the port in 1904. The corresponding figures for ships sailing from the two ports first named were in the same year 7642 and tonnage 10,298,405. The figures from Ghent were 1128 and 877,173 tons. Whereas the lines of steamers from Ostend are chiefly with Dover and London, those from Antwerp proceed to all parts of the world. A steam service was established in 1906 from Hull to Bruges by Zeebrugge and the ship canal.

Internal Communications.—The internal communications of Belgium of every kind are excellent. The roads outside the province of Luxembourg and Namur are generally paved. In the provinces named, or in other words, in the region south of the Meuse, the roads are macadamized. The total length of roads is about 6000 m. When Belgium became a separate state in 1830 they were less than one-third of this total. There are about 2000 m. of railways, of which upwards of 2500 m. are state railways. It is of interest to note that the state railways derived a revenue of 249,355 francs (or nearly 10,000,000) from the penny tickets for the admission of non-travellers to railway stations. Besides the main railways there are numerous light railways (*chemins de fer vicinaux*), of a total length approaching 2500 m. There are also electric and steam tramways in all the principal cities. The total of navigable waterways is given as 1360 m. Posts, telegraphs and telephones are exclusively under state management and form a government department.

Banks and Money.—The principal banking institution is the Banque Nationale which issues the bank-notes in current use. In 1904 the average value of notes in circulation was 64,598,100 francs. The rate of discount was 3% throughout the whole of the year.

The mintage of Belgian money is carried out by a *directeur de la fabrication* who is nominated by and responsible to the government. The gold coins are for 10 and 20 francs, silver for half francs, francs, 2 francs and 5 francs. Nickel money is for 5, 10 and 20 centimes, and the copper coinage has been withdrawn from circulation.

AUTHORITIES.—*Annuaire statistique de la Belgique* (1905); *Belgiens* and *Godenne*, *La Constitution belge* (Brussels, 1880); *La Belgique illustrée* (Bruss., s. 1878-1882); *Les Pandectes belges* (Brussels, 1898); *Annales du parlement belge* for each year; *Belgian Life in Town and Country*, "Our Neighbours" Series (London, 1904). For geology see C. Dewalque, *Prodrôme d'une description géologique de la Belgique* (Brussels, 1880); M. Mourlon, *Géologie de la Belgique* (Brussels, 1880-1881); F. L. Cornet and A. Briart, "Sur le relief du sol en Belgique après les temps paléozoïques," *Ann. Soc. Géol. Belg.*, vol. iv., 1877, pp. 71-115, pls. v.-xi. (See also other papers by the same authors in the same journal); J. Gosselet, *L'Ardenne* (Paris, 1888); M. Bertrand, "Études sur le bassin houiller du nord et sur le Boulonnais," *Ann. des mines*, ser. ix. vol. vi. (Mém.), pp. 569-635, 1894; C. Malaise, "État géol. de nos connaissances sur le silurien de la Belgique," *Ann. Soc. Géol. Belg.*, vol. xxv., 1900-1901, pp. 179-221; H. Forir, "Bibliographie des étages lakéniens, lédien, weméliens, asschién, tongrien, rupélien et boldérien et des dépôts tertiaires de la haute et moyenne Belgique," *ibid.*, pp. 223 seq.

(D. C. B.)

HISTORY¹

The political severance of the northern and southern Netherlands may be conveniently dated from the opening of the year 1579. By the signing of the league of Arras (5th of January) the Walloon "Malcontents" declared their adherence to the cause of Catholicism and their loyalty to the Spanish king, and broke away definitely from the northern provinces, who bound

¹ See for earlier history NETHERLANDS, FLANDERS, BRABANT, LIÈGE, &c.

themselves by the union of Utrecht (20th of January) to defend their rights and liberties, political and religious, against all foreign potentates. Brabant and Flanders were still indeed under

the control of the prince of Orange; and through his influence accepted in 1582 the duke of Anjou as their sovereign. The French prince was actually inaugurated duke of Brabant at Antwerp (February 1582) and count of Flanders at Bruges (July), but his misconduct speedily led to his withdrawal from the Netherlands, and even before the assassination of Orange (July 1584) the authority of Philip had been practically restored throughout the two provinces. This had been achieved by the military skill and statesmanlike abilities of Alexander Farnese, prince of Parma, appointed governor-general on the death of Don John of Austria, on the 1st of October 1578. Farnese first won by promises and blandishments the confidence of the Walloons, always jealous of the predominance of the "Flemish" provinces, and then proceeded to make himself master of Brabant and Flanders by force of arms. In succession Ypres, Mechlin, Ghent, Brussels, and finally Antwerp (17th of August 1585) fell into his hands. Philip had in the southern Netherlands attained his object, and Belgium was henceforth Catholic and Spanish, but at the expense of its progress and prosperity. Thousands of its inhabitants, and those the most enterprising and intelligent, fled from the Inquisition, and made their homes in the Dutch republic or in England. All commerce and industry was at a standstill; grass grew in the streets of Bruges and Ghent; and the trade of Antwerp was transferred to Amsterdam. On Parma's death (3rd of December 1592) the archduke Ernest of Austria was appointed governor-general, but he died after a short tenure of office (20th of February 1595) and was at the beginning of 1596 succeeded by his younger brother the cardinal archduke Albert. Philip was now nearing his end, and in 1598 he gave his eldest daughter Isabel in marriage to her cousin the archduke Albert, and erected the Netherlands into a sovereign state under their joint rule. The advent of the new sovereigns, officially known as "the archdukes," though greeted with enthusiasm in the Belgic provinces, was looked upon with suspicion by the Dutch, who were as firmly resolved as ever to uphold their independence. The chief military event of the early years of their reign was the battle of Nieuport (2nd of July 1600), in which Maurice of Nassau defeated the archduke Albert, and the siege of Ostend, which after a three years' heroic defence was surrendered (20th of September 1604) to the archduke's general, Spinola. The Dutch, however, being masters of the sea, kept the coast closely blockaded, and through sheer exhaustion the king of Spain and the archdukes were compelled to agree to a truce for twelve years (9th of April 1609) with the United Provinces "in the capacity of free states over which Albert and Isabel made no pretensions."

During the period of the truce the archdukes, who were wise and statesmanlike rulers, did their utmost to restore prosperity to their country and to improve its internal condition. Unfortunately they were childless, and the instrument of cession of 1598 provided that in case they should die without issue, the Netherlands should revert to the crown of Spain. This reversion actually took place. Albert died in 1621, just before the renewal of the war with the Dutch, and Isabel in 1633. The Belgic provinces therefore passed under the rule of Philip IV., and were henceforth known as the Spanish Netherlands.

This connexion with the declining fortunes of Spain was disastrous to the well-being of the Belgian people, for during many years a close alliance bound together France and the United Provinces, and the Southern Netherlands were exposed to attack from both sides, and constantly suffered from the ravages of hostile armies. The cardinal archduke Ferdinand, governor-general from 1634-1641, was a capable ruler, and by his military skill prevented in a succession

of the twelve years' truce.

sea, kept the coast closely blockaded, and through sheer exhaustion the king of Spain and the archdukes were compelled to agree to a truce for twelve years (9th of April 1609) with the United Provinces "in the capacity of free states over which Albert and Isabel made no pretensions."

During the period of the truce the archdukes, who were wise and statesmanlike rulers, did their utmost to restore prosperity to their country and to improve its internal condition. Unfortunately they were childless, and the instrument of cession of 1598 provided that in case they should die without issue, the Netherlands should revert to the crown of Spain. This reversion actually took place. Albert died in 1621, just before the renewal of the war with the Dutch, and Isabel in 1633. The Belgic provinces therefore passed under the rule of Philip IV., and were henceforth known as the Spanish Netherlands.

This connexion with the declining fortunes of Spain was disastrous to the well-being of the Belgian people, for during many years a close alliance bound together France and the United Provinces, and the Southern Netherlands were exposed to attack from both sides, and constantly suffered from the ravages of hostile armies. The cardinal archduke Ferdinand, governor-general from 1634-1641, was a capable ruler, and by his military skill prevented in a succession

of the twelve years' truce.

sea, kept the coast closely blockaded, and through sheer exhaustion the king of Spain and the archdukes were compelled to agree to a truce for twelve years (9th of April 1609) with the United Provinces "in the capacity of free states over which Albert and Isabel made no pretensions."

During the period of the truce the archdukes, who were wise and statesmanlike rulers, did their utmost to restore prosperity to their country and to improve its internal condition. Unfortunately they were childless, and the instrument of cession of 1598 provided that in case they should die without issue, the Netherlands should revert to the crown of Spain. This reversion actually took place. Albert died in 1621, just before the renewal of the war with the Dutch, and Isabel in 1633. The Belgic provinces therefore passed under the rule of Philip IV., and were henceforth known as the Spanish Netherlands.

Peace of Münster.

of campaigns the forces of the enemy from overrunning the country. On the 30th of January 1648, Spain concluded a separate peace at Münster with the Dutch, by which Philip IV.

finally renounced all his claims and rights over the United Provinces, and made many concessions to them. Among these was the closing of the Scheldt to all ships, a clause which was ruinous to the commerce of the Belgian provinces, by cutting them off from their only access to the ocean. Thus they remained for a long course of years without a sea-port, and in the many wars that broke out between Spain and France were constantly exposed, as an outlying Spanish dependency, to the first attack, and peace when it came was usually purchased at the cost of some part of Belgian territory. By the treaty of the Pyrenees (1659) Artois

(except St Omer and Aire) and a number of towns in Flanders, Hainaut, and Luxemburg were ceded to France. Subsequent French conquests, confirmed by the peace of Aix-la-Chapelle (1668), took away Lille, Douai, Charleroi, Oudenarde, Coutrai and Tournai.

These were, indeed, partly restored to Belgium by the peace of Nijmegen (1679); but on the other hand it lost Valenciennes, Newport, St Omer, Ypres and Charlemont, which were only in part recovered by the peace of Ryswick (1697).

The internal history of the Belgian provinces has little to record during this long period in which the ambition of Louis XIV. to possess himself of the Netherlands, in right of his wife the infanta Maria Theresa (see SPANISH SUCCESSION), led to a series of invasions and desolating wars. The French king managed to incorporate a large slice of territory upon his northern frontier, but his main object was baffled by the steady resistance and able statesmanship of William III. of England and Holland. Meanwhile from 1662 onwards brighter prospects were opened out to the unfortunate Belgians by the nomination by the Spanish king of Maximilian Emanuel, elector of Bavaria, to governor-general with well-nigh sovereign powers. The elector had himself a claim to the inheritance as the husband of an Austrian archduchess, whose mother, the infanta Margaret, was the younger sister of the French queen. Maximilian Emanuel was an able man, who did his utmost to improve the condition of the country.

He attempted to promote trade and restore prosperity to the impoverished land by the introduction of new customs laws and other measures, and particularly by the construction of canals to counteract the damage done to Belgian commerce by the closing of the Scheldt.

The position of the elector was greatly strengthened by the partition treaty of the 19th of August 1698. Under this instrument the signatory powers—England, France and Holland—agreed that on the demise of Charles II. the crown prince of Bavaria under his father's guardianship should be sovereign of Spain, Belgium and Spanish America. Charles II. himself

shortly afterwards by will appointed the Bavarian prince heir to all his dominions. The death of the infant heir a few months later (6th of February 1699)

unfortunately destroyed any prospects of a peaceable settlement of the Spanish Succession. Charles II. was persuaded to name as his sole successor, Philip duke of Anjou, the second son of the dauphin, and on his death (on the 1st November 1700) Louis XIV. took immediate steps to support his grandson's claims, in spite of his formal renunciation of such claims under the treaty of the Pyrenees. England and Holland were determined to prevent, however, at all costs the acquisition of Belgium by a French prince, and a coalition, known as the Grand Alliance, was formed between these two powers and the empire to uphold the claims of the archduke Charles, second son of the emperor.

One of the first steps of Louis was to take possession of the Netherlands. The hereditary feud between the houses of Austria and Bavaria induced the elector to take the side of France, and he was nominated by Philip V. vicar-general of the Netherlands. The unhappy Belgian provinces were again doomed for a number of years to be the battle-ground of the contending forces, and it was on

Belgic soil that Marlborough won the great victories of Ramillies (1706) and Oudenarde (1708), by which he was enabled to drive the French armies out of the Netherlands and to carry the war into French territory. At the general peace concluded at Utrecht (11th of April 1713) the long connexion between Belgium and Spain was severed, and this portion of the Burgundian inheritance of Charles V. placed under the sovereignty of the Habsburg claimant, who had, by the death of his brother, become the emperor Charles VI. The Belgian provinces now came for a full century to be known as the Austrian Netherlands. Yet such was the dread of France and the enfeebled state of the country that Holland retained the privilege, which had been conceded to her during the war, of garrisoning the principal fortresses or Barrier towns, on the French frontier, and her right to close the navigation on the Scheldt was again ratified by a European treaty. The beginnings of Austrian sovereignty were marked by many collisions between the representatives of the new rulers and the States General, and provincial "states."

Despite their troubled history and long subjection, the Belgic provinces still retained to an unusual degree their local liberties and privileges, and more especially the right of not being taxed, except by the express consent of the states. The marquis de Prié, who (as deputy for Prince Eugene) was the imperial governor from 1719 to 1726, encountered on the part of local authorities and town guilds vigorous resistance to his attempt to rule the Netherlands as an Austrian dependency, and he was driven to take strong measures to assert his authority. He selected as his victim a powerful popular leader at Brussels, Francis Anneessen, syndic of the gild of St Nicholas, who was beheaded on the 10th of September 1719. His name is remembered in Belgian annals as a patriot martyr to the cause of liberty. The administration of de Prié was not, however, without its redeeming features. He endeavoured to create at Ostend a seaport, capable in some measure to take the place of Antwerp, and in 1722 a Chartered Company of Ostend was erected for the purpose of trading in the East and West Indies (see OSTEND). The determined hostility of the Dutch rendered the promising scheme futile, and after a precarious struggle for existence, Charles VI., in order to gain the assent of the United Provinces and Great Britain to the Pragmatic Sanction (*q.v.*), suppressed the Company in 1731.

For sixteen years (1725-1741) the archduchess Mary Elizabeth, sister of the emperor, filled the post of governor-general. Her rule was marked by the restoration of the old form of administration under the three councils, and was a period of general tranquillity. She died (1741) in the Netherlands, and the empress-queen, Maria Theresa, who had succeeded under the Pragmatic Sanction to the Burgundian domains of her father about a year before, appointed her brother-in-law, Charles of Lorraine, to be governor-general in her aunt's place, and he retained that post, to the great advantage of Belgium, for nearly forty years. He was deservedly known as the "Good Governor."

The first years of his administration were stormy. During the Austrian War of Succession the country was conquered by the French, and for two years Marshal Saxe bore the title of governor-general, but it was restored to Austria by the peace of Aix-la-Chapelle (1748). Belgium was undisturbed by the Seven Years' War (1756-1763), and during the long peace which followed enjoyed considerable prosperity. Charles of Lorraine thoroughly identified himself with the best interests of the country, and was the champion of its liberties, and though he had at times to make a stand against the imperialistic tendencies of the chancellor Kaunitz, he was able to rely on the steady support of the empress, who appreciated the wise and liberal policy of her brother-in-law. Although the Scheldt was still closed, Charles endeavoured by a large extension of the canal system to facilitate commercial intercourse, he encouraged agriculture, and was successful in restoring the prosperity of the country. He also did much for the advancement of learning, founding, among other institutions,

the Marquis de Prié in Belgium.

Execution of Francis Anneessen.

Chartered Company of Ostend.

Archduchess Mary Elizabeth.

Charles of Lorraine.

Peace of Utrecht.

The Austrian Netherlands.

Efforts of the elector of Bavaria to promote trade.

Successive cession of Belgian territory to France.

Ruinous consequences of the closing of the Scheldt.

Marlborough's successes.

the Academy of Science, and he consistently restrained the undue intervention of the church in secular affairs, and placed restrictions upon the accumulation of property in the hands of religious bodies.

The death of Charles of Lorraine preceded only by a few months that of Maria Theresa, whose son Joseph II, not only appointed his sister, the archduchess Maria Christine, **Reforming zeal of Joseph II.** governor-general, but visited Belgium in person and showed a great and active interest in its affairs.

Here as elsewhere in his dominions his intentions were excellent, but his reforming zeal outran discretion, and his hasty and self-opinionated interferences with treaty rights and traditional privileges ended in provoking opposition and disaster. Finding the United Provinces hampered by a war with England, he seized the opportunity to try to get rid of the impediments placed upon Belgian development by the Barrier and other treaties with Holland. He was able to compel the Dutch to withdraw their garrisons from the Barrier towns, but was wholly unsuccessful in his high-handed attempt to free the navigation of the Scheldt. These efforts to coerce the Dutch, though marred by partial failure, were, however, calculated to win for Joseph II. popularity with his Belgian subjects; but it was far otherwise with his policy of internal reform. He offended the states by seeking to sweep away many of their inherited privileges and to change the time-honoured, if somewhat obsolete, system of civil government. He further excited the religious feelings of the people against him, by his edict of Tolerance (1780), and his later attempts at the reform of clerical abuses, which were pronounced to be an infraction of the Joyous Entry (see JOYEUSE ENTRÉE). Fierce opposition was aroused. Numbers of malcontents left the country and organized themselves as a military force in Holland. As the discontent became more general, the insurgents returned, took several forts, defeated the Austrians at Turnhout, and overran the country.

The Brabantian revolt. On the 11th of December 1789, the people of Brussels rose against the Austrian garrison, and compelled it to capitulate, and, on the 27th, the states of Brabant declared their independence. The other provinces followed and, on the 11th of January 1790, the whole formed themselves into an independent state, under the name of the "Belgian United States." A few weeks later, on the 20th of February, Joseph II. died, his end hastened by chagrin at the utter failure of his well-meant efforts, and was succeeded by Leopold II.

The new emperor at once took steps to re-assert, if possible, his authority in Belgium without having recourse to armed **Leopold II. pacifies the country.** force. He offered the states, if the people would return to their allegiance, the restoration of their ancient constitution and a general amnesty. This, however, did not suit the views of the popular party, who, under the leadership of an advocate named Van der Noot, had possession of the reins of power, and were upheld by their success. The terms offered in an imperial proclamation were rejected, and preparations were made to resist coercion by the *levée en masse* of a national army. When, however, in November 1790, a powerful Austrian force entered the country, there was practically little opposition to its advance. The popular leaders fled, the form of government, as it existed at the end of the reign of Maria Theresa, and an amnesty for past offences was proclaimed; a superficial pacification of the revolted provinces was effected, and Austrian rule re-established. It was destined to be short-lived. In 1792 the armies of revolutionary France assailed Austria at her weakest point by an invasion of Belgium. The battle of Jemappes (7th of November) made the French **Conquest of Belgium by the French.** masters of the southern portion of the Austrian Netherlands; the battle of Fleurus (26th of June 1794) put an end to the rule of the Habsburgs over the Belgic provinces. The treaty of Campo Formio (1797) and the subsequent treaty of Lunéville (1801) confirmed the conquerors in the possession of the country, and Belgium became an integral part of France, being governed on the same footing, receiving the *Code Napoléon*, and sharing in the fortunes of the Republic and the Empire. After the fall of Napoleon and the

conclusion of the first peace of Paris (30th of May 1814) Belgium was indeed for some months placed under the administration of an Austrian governor-general, but it was shortly afterwards united with Holland to form the kingdom of the Netherlands. The sovereignty of the newly formed state was given to the prince of Orange, who mounted the throne (23rd of March 1815) under the title of William I. The congress of Vienna (31st of May 1815) determined the relations and fixed the boundaries of the kingdom; and the new constitution was promulgated on the 24th of August following, the king taking the oath at Brussels on the 27th of September.

From this date until the Belgian revolt of 1830, the history of Holland and Belgium is that of two portions of one political entity, but in the relations of those two portions were to be found from the very outset fundamental causes tending to disagreement and separation. The Dutch and Belgian provinces of the Netherlands had for one hundred and thirty years passed through totally different experiences, and had drifted farther and farther apart from one another in character, in habits, in ideas and above all in religion. In the south the policy of Alva and Philip II. had been wholly successful, and the Belgian people, Flemings and Walloons alike, were perhaps more devoted to the Catholic faith than any other in Europe. On the other hand the incorporation of the country for two decades in the French republic and empire had left deep traces on a considerable section of the population, the French language was commonly spoken and was exclusively used in the law courts and in all public proceedings, and French political theories had made many converts. The Fundamental Law promulgated by William I. aroused strong opposition among both the Catholic and Liberal parties in Belgium. The large powers granted to the king under the new constitution displeased the Liberals, who saw in its provision only a disguised form of personal government. The principle of liberty of worship and of the press, which it laid down, was so offensive to the Catholics that the bishops condemned it publicly, and in the Doctrinal Judgment actually forbade their flocks to take the oath. The "close and complete union," which was stipulated under the treaty of 1814, began under unfavourable auspices. Nevertheless the difficulties might have been smoothed away in the course of time, had the Belgians felt that the Dutch were treating them in a fair and conciliatory spirit. This, despite the undoubtedly good intentions of the king, was far from being the case. Belgium was regarded too much in the light of an annexed territory, handed over to Holland as compensation for the losses sustained by the Dutch in the revolutionary and Napoleonic wars. The idea that Holland was the predominant partner in the kingdom of the Netherlands was firmly rooted in the north and naturally provoked in the south the feeling that Belgium was being exploited for the benefit of the Dutch. The grievances of the Belgians were indeed very substantial. The seat of government was in Holland, the king was a Dutchman by birth and training, and a Calvinistic protestant by religion. Though the population of Belgium was 3,400,000 and that of Holland only a little more than 2,000,000 the two countries had equal representation in the second chamber of the states-general. Practically in all important legislative measures affecting the interests of the two countries the Dutch government were able to command a small but permanent majority. The use of the term "the Dutch Government" is strictly accurate, for the great majority of the public offices were filled by northerners. In 1830, of the seven members of the ministry only one was a Belgian; in the home department out of 117 officials 11 only were Belgians; in the ministry of war 3 were Belgians out of 102; of the officers of the army 288 out of 1067. All the public establishments, the Bank, the military schools, were Dutch. That such was the case must not be entirely charged to partiality, still less to deliberate unfairness on the part of William I. The conduct of the king proves that he had a most sincere regard for the welfare of his

Union of Holland and Belgium under William I.

1814-1830.

Causes of disagreement between Holland and Belgium.

Attitude of the king.

Belgian subjects, and in his choice of measures and men his aim was to secure the prosperity of his new kingdom by a policy of unification. This was the object he had in view in his attempt to make Dutch, except in the Walloon districts, the official language for all public and judicial acts, and a knowledge of Dutch a necessary qualification for every person entering the public service. That the fierce opposition which this attempt

aroused in the Flemish-speaking provinces was ill-considered and unwise, is shown by the fact that in recent years there has been a patriotic movement in these same provinces which has been successful in forcing the Belgian government to adopt Flemish (*i.e.* Dutch) as well as French for official usage. This Flemish movement is all in favour of establishing close relations with the sister people of the north. Moreover it cannot be gainsaid that Belgium during her union with Holland enjoyed a degree of prosperity that was quite remarkable. The mineral wealth of the country was largely developed, the iron manufactures of Liège made rapid advance, the woollen manufactures of Verviers received a similar impulse, and many large establishments were formed at Ghent and other places, where cotton goods were produced which rivalled those of England and surpassed those of France. The extensive colonial and foreign trade of the Dutch furnished them with markets, while the opening of the navigation of the Scheldt raised Antwerp once more to a place of high commercial importance. The government also did much in the way of improving the internal communications of the country, in repairing the roads and canals, in forming new ones, in deepening and widening rivers, and the like. Nor was the social and intellectual improvement of the people by any means neglected. A new university was formed at Liège, normal schools for the instruction of teachers were instituted, and numerous elementary schools and schools for higher instruction were established over the country. These measures for the furthering of education among the people on the part of a government mainly composed of Protestants were received with suspicion and disfavour by the priests, and still more the attempts subsequently made to regulate the education of the priests themselves. The establishment under the auspices of the king in 1825 of the Philosophical College at Louvain, and the requirement that every priest before ordination should spend two years in study there, gave great offence to the clerical party, and some of the bishops were prosecuted for the violence of their denunciations at this intrusion of the secular arm into the religious domain. With the view of terminating these differences the king in 1827 entered into a *concordat* with the pope, and an agreement was reached with regard to nominations to bishoprics, clerical education and other questions, which should have satisfied all reasonable men. But in 1828 the two extreme parties, the Catholic Ultramontanes and the revolutionary Liberals, in their common hatred to the Dutch régime, formed an alliance, the *union*, for the overthrow of the government. Petitions were sent in setting forth the Belgian grievances, demanding a separate administration for Belgium and a full concession of the liberties guaranteed by the constitution.

Matters were in this state when the news of the success of the July revolution of 1830 at Paris reached Brussels, at this time a city of refuge for the intriguing and discontented of almost every country of Europe. The first outbreak took place on the 25th of August, the anniversary of the king's accession. An opera called *La Muette*, which abounds in appeals to liberty, was played, and the audience were so excited that they rushed out into the street crying, "Imitons les Parisiens!" A mob speedily gathered together, who proceeded to destroy or damage a number of public buildings and the private residences of unpopular officials. The troops were few in number and offered no opposition to the mob, but a burgher guard was enrolled among the influential and middle-class citizens for the protection of life and property. The intelligence of these events in the capital soon spread through the provinces; and in most of the large towns similar scenes were enacted, beginning with plunderings and outrages, followed

by the institution of burgher guards for the maintenance of peace. The leading men of Brussels were most anxious not to push matters to extremities. They demanded the dismissal of the specially obnoxious minister, Van Maanen, and a separate administration for Belgium. The government, however, could not make up their minds what course to pursue, and by allowing things to drift ended by converting a popular riot into a national revolt. The heir apparent, the prince of Orange (see WILLIAM II. of the Netherlands), was sent on a peaceful mission to Brussels, but furnished with such limited powers, as under the circumstances were utterly inadequate. He did his best to get at the real facts, and after a number of conferences with the leaders became so convinced that nothing but a separate administration of the two countries would restore tranquillity that he promised to use his influence with his father to bring about that object—on receiving assurances that the personal union under the house of Orange would be maintained. The king summoned an extraordinary session of the states-general, which met at the Hague on the 13th of September and was opened by a speech from the throne, which was firm and temperate, but by no means definite. The proceedings were dilatory, and the attitude of the Dutch deputies exceedingly exasperating. The result was that the moderate party in Belgium quickly lost their influence, and those in favour of violent measures prevailed. Meanwhile although the states were still sitting at the Hague, an army of 14,000 troops under the command of Prince Frederick, second son of the king, was gradually approaching Brussels. It was hoped that the inhabitants would welcome the prince and that a display of armed force would speedily restore order. After much unnecessary delay, at a time when prompt action was required, the prince on the 23rd of September entered Brussels and, with little opposition, occupied the upper or court portion of it, but when they attempted to advance into the lower town the troops found the streets barricaded and defended by citizens in arms. Desultory fighting between the soldiers and the insurgents continued for three days until, finding that he was making no headway, the prince ordered a retreat. The news spread like wildfire through the country, and the principal towns declared for separation. A provisional government was formed at Brussels, which declared Belgium to be an independent state, and summoned a national congress to establish a system of government. King William now did his utmost to avoid a rupture, and sent the prince of Orange to Antwerp to promise that Belgium should have a separate administration; but it was too late. Antwerp was the only important place that remained in the hands of the Dutch, and the army on retreating from Brussels had fallen back on this town. At the end of October an insurgent army had arrived before the gates, which were opened by the populace to receive them, and the troops, under General Chassé, retired within the citadel. The general ordered a bombardment of the town for two days, destroying a number of houses and large quantities of merchandise. This act served still further to inflame the minds of the Belgians against the Dutch.

A convention of the representatives of the five great powers met in London in the beginning of November, at the request of the king of the Netherlands, and both sides were brought to consent to a cessation of hostilities. On the 10th of November the National Congress, consisting of 200 deputies, met at Brussels and came to three important decisions: (1) the independence of the country—carried unanimously; (2) a constitutional hereditary monarchy—174 votes against 13; (3) the perpetual exclusion of the Orange-Nassau family—161 votes against 28. On the 20th of December the conference of London proclaimed the dissolution of the kingdom of the Netherlands, but claimed the right of regulating the conditions under which it should take place. On the 28th of January 1831, the congress proceeded to the election of a king, and out of a number of candidates the choice fell on the duke of Nemours, second son of Louis Philippe, but he declined the office. The congress then elected Baron Surlet de Chokier to the temporary post of regent, and proceeded to

Meeting of the National Congress.

Brussels outbreak of 1830.

draw up a constitution on the British parliamentary pattern. The constitution expressly declared that the king has no powers except those formally assigned to him. Ministers were to be appointed by him, but be responsible to the chambers. The legislature was composed of two chambers—the senate and the chamber of deputies. Both chambers were elected by the same voters, but senators required a property qualification,—the payment of at least 2000 florins in taxes. Senators and deputies received salaries. The franchise was for that time a low one—every one who paid at least 20 florins in taxes had a vote. The choice of a king was more difficult than that of drawing up a constitution. It was desirable that the new sovereign should be able to count upon the friendly support of the great powers, and yet not be actually a member of their reigning dynasties. It was from fear of arousing the susceptibilities of neighbouring states, especially Great Britain, that Louis Philippe had refused to sanction the election of his son. It was for this reason that the name of Leopold of Saxe-Coburg, the widower of Princess Charlotte of England, had not been placed among the candidates in January. Overtures were, however, made to him, as soon as it was understood that, as the result of private negotiations at the London conference, the selection of this prince would be favourably received both by Great Britain and France. Leopold

*Leopold I.,
king of the
Belgians.*

signified his readiness to accept the crown after having first ascertained that he would have the support of the great powers in bringing about a satisfactory settlement with Holland on those points which he considered essential to the security and welfare of the new kingdom. The election took place on the 4th of June, when 152 votes out of 196, four being absent, determined that Leopold should be proclaimed king of the Belgians, under the express condition that he "would accept the constitution and swear to maintain the national independence and territorial integrity." Leopold made his public entry into Brussels, on the 21st, and subsequently visited other parts of the kingdom, and was everywhere received with demonstrations of loyalty and respect.

At this juncture news suddenly arrived that the Dutch were preparing to invade the country with a large army. It comprised 45,000 infantry and 6000 cavalry with 72 pieces of artillery, while Leopold could scarcely bring forward 25,000 men to oppose it. On the 2nd of August the whole of the Dutch army had crossed the frontier; Leopold collected his forces, such as they were, near Louvain in order to cover his capital. The two armies met on the 9th of August. The undisciplined Belgians, despite the personal efforts of their king, were speedily routed, and Leopold and his staff narrowly escaped capture. He, however, made good his retreat to the capital, and, on the advance of a French army, the prince of Orange did not deem it prudent to push on farther. A convention was concluded between him and the French general, in consequence of which he returned to Holland and the French likewise recrossed the frontier. Leopold now proceeded with vigour to strengthen his position and to restore order and confidence. French officers were selected for the training and disciplining of the army, the civil list was arranged with economy and order, and reforms were introduced into the public service and system of administration. He kept on the best of terms, though a Protestant, with the Roman Catholic clergy and nobility, and his subsequent marriage with the daughter of the French king (9th of August 1832), and the contract that the children of the marriage should be brought up in the Roman Catholic faith, did much to inspire confidence in his good intentions.

Meanwhile the conference in London had drawn up the project of a treaty for the separation of Holland and Belgium, which was declared "to be final and irrevocable." The conditions were far less favourable to Belgium than had been hoped, and it was not without much heart-burning and considerable opposition, that the senate and chamber of deputies gave their assent to them. The treaty, which contained 24 articles, was signed on the 15th of November 1831. By these articles the grand-duchy

*The treaty
of separa-
tion.*

of Luxemburg was divided, but the king of Holland retained possession of the fortress of Luxemburg, and also received a portion of Limburg to compensate him for the part of Luxemburg assigned to Belgium. The district of Maestricht was likewise partitioned, but the fortress remained Dutch. The Scheldt was declared open to the commerce of both countries. The national debt was divided. The powers recognized the independence of Belgium, "as a neutral state."

This agreement was ratified by the Belgian and French sovereigns on the 20th and 24th of November, by the British on the 6th of December, but the Austrian and Prussian and Russian governments, whose sympathies were with the "legitimate" King William rather than with a prince who owed his crown to a revolution, did not give their ratification till some five months later. Even then King William remained obdurate, refused to sign and continued to keep possession of Antwerp. After fruitless efforts on the part of the great powers to obtain his acquiescence, France and Great Britain resolved to have recourse to force. On the 5th of November their combined fleets sailed for the coast of Holland, and, on the 18th, a French army of 60,000 men, under the command of Marshal Gérard, crossed the Belgian frontier to besiege Antwerp. The Dutch garrison capitulated on the 23rd of December, and on the 31st the town was handed over to the Belgians, and the French troops withdrew across the frontier. The Dutch, however, still held two forts, which enabled them to command the navigation of the Scheldt, and these they stubbornly refused to yield. Belgium therefore kept possession of Limburg and Luxemburg, except the fortress of Luxemburg, which as a fortress of the German confederation was, under the terms of the treaty of Vienna, garrisoned by Prussian troops. These territories were treated in every way as a part of Belgium, and sent representatives to the chambers. Great indignation was therefore felt at the idea of giving them up, when Holland (14th of March 1838) signified its readiness to accept the conditions of the treaty.

*The
French
besiege
Antwerp*

*The Lux-
emburg
question.*

The chambers argued that Belgium had been induced to agree to the twenty-four articles in 1832 in the hope of thereby at once terminating all harassing disputes, but as Holland refused then to accept them, the conditions were no longer binding and the circumstances were now quite changed. They urged that Luxemburg in fact formed an integral part of Belgium and that the people were totally opposed to a union with Holland. They offered to pay for the territory in dispute, but the treaty gave them no right of purchase, and the proposal was not entertained. Addresses were unanimously voted urging the king to resist separation, great excitement was aroused throughout the country and preparations were made for war. But the firmness of the allied powers and their determination to uphold the conditions of the treaty compelled the king most reluctantly to submit to the inevitable. The treaty was signed in London on the 10th of April 1839. It saddled Belgium with a portion of Holland's debt, and a severe financial crisis followed.

*Final
settlement
between
Holland
and
Belgium.*

The Belgian revolution owed its success to the union of the Catholic and Liberal parties; and the king had been very careful to maintain the alliance between them. This continued to be the character of the government till 1840, but by degrees it had been growing more and more conservative, and was giving rise to dissatisfaction. A ministry was formed on more liberal principles, but it clashed with the Catholic aristocracy, who had the majority in the senate. A neutral ministry under M. Charles Nothomb was then formed. In 1842 it carried a new law of primary instruction, which aroused the dislike of the anti-clerical Liberals. The Nothomb ministry retired in 1845. In March 1846 the king formed a purely Catholic ministry, but it was fiercely attacked by the Liberals, who had for several years been steadily organizing. A congress was summoned to meet at Brussels (14th of June 1846) composed of delegates from the different Liberal associations throughout the country. Three hundred and twenty delegates met and drew up an Act of Federation and a programme of

*Struggle
between
the
Catholics
and
Liberals.*

reforms. The election of 1847 gave a majority to the Liberals and a purely Liberal ministry was formed, and from this date onwards it has been the constitutional practice in Belgium to choose a homogeneous ministry from the party which possesses a working majority in the chamber. In 1848 a new electoral law was passed, which lowered the franchise to 20 florins' worth of property and doubled the number of electors. Hence it came to pass that Belgium passed safely through the crisis of the French revolution of 1848. The extreme democratic and socialist party made with French aid some spasmodic efforts to stir up a revolutionary movement, but they met with no popular sympathy; the throne of Leopold stood firmly based upon the trust and respect of the Belgian nation for the wisdom and moderation of their king.

The attention of the government was now largely directed to the stimulating of private industry and the carrying out of public works of great practical utility, such as the extension of railways and the opening up of other internal means of communication. Commercial treaties were also entered into with various countries with the view of providing additional outlets for industrial products. The king also sought as much as possible to remove from the domain of politics every irritating question, believing that a union of the different parties was most for the advantage of the state. In 1850 the question of middle-class education was settled. In 1852 the Liberal cabinet was overthrown and a ministry of conciliation was formed. A bill was passed authorizing the army to be raised to 100,000 men including reserve. The elections of 1854 modified the parliamentary situation by increasing the strength of the Conservatives; the ministry resigned and a new one was formed, under Pierre de Decker, of moderate Catholics and Progressives. In 1857 the government of M. de Decker brought in a bill to establish "the liberty of charity," but in reality to place the administration of charities in the hands of the priesthood. This led to a violent agitation throughout the kingdom and the military had to be called out. Eventually the bill was withdrawn, the ministers resigned and a Liberal ministry was formed under M. Charles Rogier. In 1860 the communal *octrois* or duties on articles of food brought into the towns was abolished; in 1863 the navigation of the Scheldt was made free, and a treaty of commerce established with England. The elections of July 1864 gave a majority to the Liberals, and M. Rogier continued in office.

On the 10th of December 1865, King Leopold died, after a reign of thirty-four years. He was greatly beloved by his people, and to him Belgium owed much, for in difficult circumstances and critical times he had managed its affairs with great tact and judgment. He was succeeded by his eldest son Leopold II., who was immediately proclaimed king and took the oath to the constitution on the 17th of December. On the outbreak of war between France and Germany in 1870, Belgium saw the difficulty and danger of her position, and lost no time in providing for contingencies. A large war credit was voted, the strength of the army was raised and strong bodies of troops were moved to the frontier. The feeling of danger to Belgium also caused great excitement in England. The British government declared its intention to maintain the integrity of Belgium in accordance with the treaty of 1839, and it induced the two belligerent powers to agree not to violate the neutrality of Belgian territory. A considerable portion of the French army routed at Sedan did indeed seek refuge across the frontier; but they laid down their arms according to convention, and were duly "interned."

In 1870 the Liberal party, which had been in power for thirteen years, was overthrown by a union of the Catholics with a number of Liberal dissentients to whom the policy of the government had given offence, and a Catholic cabinet, at the head of which was Baron Jules Joseph d'Anethan, took office. At the election of August 1870, the Catholics obtained a majority in both chambers. They increased their power considerably by reducing the voting qualification for electors to provincial councils to 20 frs., and to communal councils to 10 frs., and also by recognizing the importance of what was styled "the

Flemish Movement." Hitherto French had been the official language of the states. The use of Flemish in public documents, in judicial procedure and in official correspondence was hereafter required in the Flemish provinces, and Belgium became officially bi-lingual. It was, as has been already pointed out, a reversion to the policy of the Dutch king, which in 1830 had been so strongly denounced by the leaders of the Belgian revolution, and its object was the same, i.e. to prevent *frenchification* of a population that was Teutonic by race and speech. In 1871 M. Malou had become the head of a cabinet of moderate Catholics, and he retained office till 1878. This was the period of the struggle between the pope and the Italian government, and the German *Kulturkampf*. The Belgian Ultramontanes agitated strongly in favour of the re-establishment of the temporal power and against the policy of Bismarck. Though discountenanced by the ministry, the violence of the Ultra-clubbists compassed its downfall. They passed a law adopting the ballot in 1877, but at the election of the following year a Liberal majority was returned.

The new cabinet, under M. Frère-Orban, devoted itself solely to the settlement of the educational system. Hitherto since 1842 in all primary schools instruction by the clergy in the Catholic faith was obligatory, children belonging to other persuasions being dispensed from attendance. In 1879 a bill was passed for the secularization of primary education; but an attempt was made to conciliate the clergy by Art. 4, which enacted—"religious instruction is relegated to the care of families and the clergy of the various creeds. A place in the school may be put at their disposal where the children may receive religious instruction," at hours other than those set apart for regular education. The bill likewise provided for a rigorous inspection of the communal schools. The passing of this law was met by the clergy by uncompromising resistance. The bishops ordered that absolution be refused to teachers in the schools "sans Dieu," and to the parents who sent their children to them, and urged the establishment of private Catholic schools. All over Belgium the agitation spread, and the clergy, who were practically independent of state control, gained the victory. In November 1879 it was calculated that there were but 240,000 scholars in the secularized schools against 370,000 in the Catholic schools. In Flanders over 80% of the children attended the Catholic schools. The government appealed to the pope, but the Holy See declined to take any action, and so great was the embitterment that the Belgian minister at the Vatican and the papal nuncio at Brussels were recalled, and in 1880 the clergy refused to associate themselves with the fêtes of the national jubilee. In order to emerge victorious in such a struggle the Liberal party had need of all their strength, but a split took place between the sections known as the *doctrinaires* and the *progressists*, on the question of an extension of the franchise, and at the election of 1884 the Catholics carried all before them at the polls. From 1884 up to the present time the clerical party have maintained their supremacy.

A Catholic administration under M. Malou at once took in hand the schools question. A law was passed, despite violent protests from the Liberals, which enacted that the communes might maintain the private Catholic schools established since 1870 and suppress unsectarian schools at their pleasure. They might retain at least one unsectarian or adopt one Catholic school, where 25 heads of families demanded it. The state subsidized all the communal schools, Catholic and unsectarian alike. Under this law in all districts under clerical control the unsectarian schools were abolished. In October 1884, M. Beernaert replaced M. Malou as prime minister, and retained that post for the following ten years. He had in 1886 a troublesome and dangerous situation to deal with. Socialism had become a political force in the land. Socialism of a German type had taken deep root among the working men of the Flemish towns, especially at Ghent and Brussels; socialism of a French revolutionary type among the Walloon miners and factory hands. On the 18th of March 1886, a socialist rising suddenly burst out at Liège, on the occasion of the

The
Flemish
Move-
ment.

School
law of
1879.

Accession
of Leopold
II.

Socialist
outbreak
in 1886.

anniversary of the Paris Commune, and rapidly spread in other industrial centres of the Walloon districts. Thousands of workmen went on strike, demanding better wages and the suffrage. The ministry acted promptly and with vigour, the outbreak was suppressed by the employment of the military and order was restored. But as soon as this was accomplished the government opened a comprehensive enquiry into the causes of dissatisfaction,

Agitation for a revision of the constitution.

which served as the basis of numerous social laws, and led eventually to the establishment of universal suffrage and the substitution in Belgium of a democratic for a middle-class régime. It was not effected till several years had been spent in long parliamentary discussions, by demonstrations on the part of the supporters of franchise revision and by strikes of a political tendency. At last the senate and chamber declared, May 1892, that the time for a revision of certain articles of the constitution had come. As prescribed by the constitution, a dissolution took place and two new chambers were elected. The Catholics had a majority in both, but not enough to enable them to dispense with the assistance of the Liberals, the constitution requiring for every revision a two-thirds majority. The bills proposed for extending the franchise were all rejected (April 11th and 12th). Thereupon the council of the Labour party proclaimed a general strike. Fifty thousand workmen struck, in Brussels there were violent demonstrations, and the agitation assumed generally a dangerous aspect. Both the government and the opposition in the chambers saw that delay was impossible, and that revision must be carried out. Agreement was reached by the acceptance of a compromise proposed by M. Albert Nysens, Catholic deputy and professor of penal procedure and commercial law at the university of Louvain, and on the 18th of April the chamber adopted an electoral system until then unknown—*le suffrage universel plural*. The citizen in order to possess a vote for the election of representatives to the chambers was to be of a *minimum* age of twenty-five years, and of thirty years for the election of senators and provincial and communal councillors. For the four categories of elections a supplementary vote was given to (a) citizens who having attained the age of thirty-five years, and being married or widowers with children, paid at least 5 f. income tax, and (b) to citizens of the age of twenty-five years possessing real estate to the value of 2000 f. or Belgian state securities yielding an income of at least 100 f. Two supplementary votes were bestowed upon citizens having certain educational certificates, or discharging functions or following professions implying their possession. This elaborate system was only carried into law after considerable and violent opposition in the sessions of 1894 and 1895. It was chiefly the work of the ministry of M. de Burlet, who succeeded to the place of M. Beernaert in March 1894.

The Nysens compromise.

The composition of the elected bodies for the years 1894-1895 was:—for the chamber of representatives 1,354,891 electors with 2,085,605 votes, for the senate and provincial councils 1,148,433 electors with 1,856,838 votes. The result of the first election in October 1894 was to give the Catholic party an overwhelming majority. The old Liberal party almost disappeared, while the Walloon provinces returned a number of Socialists. In February 1896 M. de Burlet, being in bad health, transferred the direction of the government to M. Smet de Naeyer. The election of 1894 had given the Liberals a much smaller number of seats than they ought to have had according to the number of votes they polled, and a cry arose for the establishment of proportional representation. Both sides felt that reform was again necessary, but the Catholic majority disagreed among themselves as to the form it should take. In 1899 M. Smet de Naeyer gave place as head of the ministry to M. van den Peereboom. But the proposals of the latter met with organized obstruction on the part of the Socialist deputies, and after a few months' tenure of office he gave way to M. Smet de Naeyer once more. The new cabinet at once (August 1899) introduced a bill giving complete proportional representation in parliamentary elections to all the arrondissements, and it

was passed despite the defection of a number of Catholic deputies led by M. Woeste. The election in May 1900 resulted in the return of a substantial (though reduced) Catholic majority in both chambers.

During this period of Catholic ascendancy social legislation was not neglected. Among the enactments the following are the most important:—the institution of industrial and labour councils, composed of employers and employes, and of a superior council, formed of officials, workmen and employers (1887); laws assisting the erection of workmen's dwellings and supervising the labour of women and children (1889); laws for ameliorating the system of Friendly Societies (1890); laws regulating workshops (1896); conferring corporate rights on trades' unions (1898); guaranteeing the security and health of working men during hours of labour (1899). In 1900 laws were passed regulating the contract of labour, placing the workman on a footing of perfect equality with his employer, assuring the married woman free control of her savings, and organizing a system of old-age pensions. Primary education was dealt with in 1895 by a law, which made religious instruction obligatory, and extended state support to all schools that satisfied certain conditions. In 1899 there were in Belgium 6674 subsidized schools, having 775,000 scholars out of a total of 950,000 children of school age. Only 68,000 did not receive religious instruction. The Catholic party also strove to mitigate the principle of obligatory military service by encouraging the system of volunteering and by a reduction of the time of active service and of the number with the colours.

In 1905 the 75th anniversary of Belgian independence was celebrated, and there was a great manifestation of loyalty to King Leopold II. for the wisdom and prudence shown by him during his long reign. Owing to dissensions among the Catholic and Conservative party on the subject of military service and the fortification of Antwerp, their majority in the chamber in 1904 fell from 26 to 20, that in the senate from 16 to 12. The partial election in 1906 reduced the majority in the chamber to 12, while the partial election in 1908 brought the majority down to 8. The Smet de Naeyer ministry which had held office since 1900 was defeated in April 1907 in a debate on the mining law over the proposal concerning the length of the working day. A new cabinet was formed on the 2nd of May following under the presidency of M. de Trooz, who had been minister of the interior under M. Smet de Naeyer, and who retained that portfolio in conjunction with the premiership. M. de Trooz died on the 31st of December 1907, and was succeeded by M. Schollaert, president of the chamber. The count of Flanders, brother of the king, died on the 17th of November 1905, leaving his son Albert heir to the throne.

The Congo question had meanwhile become an acute one in Belgium. The personal interest taken by Leopold II. in the exploration and commercial development of the equatorial regions of Africa had led, in the creation of the Congo Free State, to results which had originally not been anticipated. The *Comité des Études du Haut Congo*, formed in 1878 at the instance of the king and mainly financed by him had developed into the International Association of the Congo, of which a Belgian officer, Colonel M. Strauch, was president. Through the efforts in Africa of H. M. Stanley a rudimentary state was created, and through the efforts of King Leopold in Europe the International Association was recognized during 1884-1885 by the powers as an independent state. Declarations to this effect were exchanged between the Belgian government and the Association on the 23rd of February 1885. In April of the same year the Belgian chambers authorized the king to be the chief of the state founded by the Association, which had already taken the name of *État Indépendant du Congo*. The union between Belgium and the new state was declared to be purely personal, but its European headquarters were in Brussels, its officials, in the course of time, became almost exclusively Belgian, and financially and commercially the connexion between the two countries became increasingly close.

Social legislation.

Politics in 1905.

Belgium and the Congo.

Proportional representation.

In 1889 King Leopold announced that he had by his will bequeathed the Congo state to Belgium, and in 1890 the Belgian government, in return for financial help, acquired the right of annexing the country under certain conditions. At later dates definite proposals for immediate annexation were considered but not adopted, the king showing a strong disinclination to cede the state, while among the mass of the Belgians the disinclination to annex was equally strong. It was not until terrible reports as to the misgovernment of the Congo created a strong agitation for reform in Great Britain, America and other countries responsible for having aided in the creation of the state, that public opinion in Belgium seriously concerned itself with the subject. The result was that in November 1907 a new treaty of cession was presented to the Belgian chambers, while in March 1908 an additional act modified one of the most objectionable features of the treaty—a clause by which the king retained control of the revenue of a vast territory within the Congo which he had declared to be his private property. A colonial law, also submitted to the chambers, secured for Belgium in case of annexation complete parliamentary control over the Congo state, and the bill for annexation was finally passed in September 1908.

BIBLIOGRAPHY.—Th. Juste, *Histoire de la Belgique* (2 vols., 1853); *La Révolution belge de 1830* (2 vols., 1872); *Congrès national de Belgique* (2 vols., 1880); *Mémoires de Leopold I.* (2 vols., 1868); De Gerlache, *Histoire du royaume des Pays-Bas* (3 vols., 1859); D. C. Boulger, *The History of Belgium*, part I. (1900); C. White, *The Belgian Revolution of 1830* (2 vols., 1835); Moke and Hubert, *Histoire de Belgique (jusqu'à 1885)* (1892); L. Hymans, *Histoire parlementaire de la Belgique (1830-1899)*; *Cinquante ans de liberté* (4 vols., 1881); J. J. Thonissen, *La Belgique sous le règne de Leopold I^{er}* (4 vols., 1855-1858); De Laveleye, *Le Parti clérical en Belgique* (1874); Vanderweide and Destree, *Le Socialisme belge* (1898); C. Woeste, *Vingt ans de polémique* (1890); Hamelius, *Le Mouvement flamand* (1894). (G. E.)

LITERATURE

Belgian literature, taken in the widest sense of the term, falls into three groups, consisting of works written respectively in Flemish, Walloon and French. The earlier Flemish authors are treated under DUTCH LITERATURE; the revival of Flemish Literature (*q.v.*) since the separation of Belgium from the Netherlands in 1830, and Walloon Literature (*q.v.*), are each separately noticed. The earlier French writers born on what is now Belgian territory—e.g. Adenès le Rois, Jean Froissart, Jean Lemaire des Belges and others—are included in the general history of French Literature (*q.v.*). It remains to consider the literature written by Belgians in French during the 19th century, and its rapid development since the revolution of 1831.

Belgian writers were commonly charged with provincialism, but the prejudice against them has been destroyed by the brilliant writers of 1870-1880. It was also asserted that Belgian French literature lacked a national basis, and was merely a reflection of Parisian models. The most important section of it, however, has a distinctive quality of its own. Many of its most distinguished exponents are Flemings by birth, and their writings reflect the characteristic Flemish scenery; they have the sensuousness, the colour and the realism of Flemish art; and on the other hand the tendency to mysticism, to abstraction, is far removed from the lucidity and definiteness associated with French literature properly so-called. This profoundly national character disengaged itself gradually, and has been more strikingly evident since 1870. The earlier writers of the century were content to follow French tradition.

The events of 1830-1831 gave a great stimulus to Belgian letters, but the country possessed writers of considerable merit before that date. Adolphe Mathieu (1802-1876) belongs to the earlier half of the century, although the tenth and last volume of his *Œuvres en vers* was only printed in 1870. His later works show the influence of the Romantic revival. Auguste Clavereau (1787-1864), a mediocre poet, an imitator of the French and Dutch, produced some successful comedies, but he ceased to write plays before 1830. Edouard Smits (1780-1852) showed romantic tendencies in his tragedies of *Marie de Bourgogne* (1823), *Elfrida* (1825), and *Jeanne de Flandre* (1828). The first of these

had a great success, partly no doubt because of its patriotic subject. For four years before 1830 André van Hasselt (*q.v.*) had been publishing his verses in the *Sentinelle des Pays-Bas*, and from 1820 onwards he was an ardent romanticist. A burst of literary and artistic activity followed the Revolution; and van Hasselt's house became a centre of poets, artists and musicians of the romantic school. The best work of the Belgian romanticists is in the rich and picturesque prose of the 16th century romance of Charles de Coster (see DE COSTER), and in the melancholy and semi-philosophical writings of the moralist Octave Pirmez (*q.v.*). The *Poésies* (1841) and the *Chansons* (1866) of Antoine Clesse (1816-1889), have been compared with the work of Béranger; and the Catholic party found a champion against the liberals and revolutionists in the satirical poet, Benoît Quinet (b. 1810). Among the famous dramatic pieces of this epoch was the *André Chénier* (1843) of Édouard Wacken (1810-1861), who was a lyric rather than a dramatic poet; also the comedies of Louis Labarre (1810-1892) and of Henri Delmotte (1822-1884). Charles Potvin (1818-1902), a poet and a dramatist, is best known by a patriotic *Histoire des lettres en Belgique*, forming vol. iv. of the Belgian compilation, *Cinquante ans de liberté* (1882), and by his essays in literary history. Eugène van Bemmel (1824-1880) established an excellent historical tradition in his *Histoire de la Belgique* (1880), reproducing exactly the original authorities, and also edited a Belgian Encyclopaedia (1873-1875), the *Patria Belgica*. Baron E. C. de Gerlache (1785-1871) wrote the history of the Netherlands from the ultraromantic standpoint. The romanticists were attacked in an amusing satire, *Les Voyages et aventures de M. Alfred Nicolas* (1835), by François Congodagnage (1797-1877), who was a nationalist in the narrowest sense, and regarded the movement as an indefensible invasion of foreign ideas. The best of the novelists of this period, excluding Charles de Coster, was perhaps Estelle Ruelens (*née Crèvecoeur*; 1821-1878); she wrote under the pseudonym of "Caroline Gravière." Her tales were collected by the bibliophile "P. L. Jacob" (Paris, 1873-1874).

The whole of this literature derived more or less from foreign sources, and, with the exception of Charles de Coster and Octave Pirmez, produced no striking figures. De Coster died in 1879, and Pirmez in 1883, and the new movement in Belgian literature dates from the banquet given in the latter year to Camille Lemonnier (*q.v.*) whose powerful personality did much to turn "Young Belgium" into a national channel. Lemonnier himself cannot be exclusively claimed by any of the conflicting schools of young writers. He was by turns naturalist, lyricist and symbolist; and it has been claimed that the germs of all the later developments in Belgian letters may be traced in his work. The quinquennial prize of literature had been refused to his *Un mâle*, and the younger generation of artists and men of letters gave him a banquet which was recognized as a protest against the official literature, represented by Louis Hymans (1829-1884), Gustave Frédéric (b. 1834), the literary critic of *L'Indépendance belge*, and others. The centres around which the young writers were grouped were two reviews, *L'Art moderne* and *La Jeune Belgique*. *L'Art moderne* was founded in 1882 by Edmond Picard, who had as his chief supporters Victor Arnould and Octave Maus. The first editor of *La Jeune Belgique* was M. Warlomont (1866-1889), known under the pen-name of "Max Waller." This review, which owed much of its success to Waller's energy, defended the intense preoccupation of the new writers with questions of style, and became the depository of the Parnassian tradition in Belgium. It had among its early contributors Georges Eekhoud, Albert Giraud, Iwan Gilkin and Georges Rodenbach. Edmond Picard (b. 1836) was one of the foremost in the battle. He was well known as an advocate in Brussels, and made a considerable contribution to jurisprudence as the chief writer of the *Pandectes belges* (1886-1890). His *Pro arte* (1886) was a kind of literary code for the young Belgian writers. His novels, of which *La Forge Roussel* (1881) is a good example, were succeeded in 1902-1903 by two plays, *Séricho* and *Fatigue de vivre*.

Georges Eekhoud, born at Antwerp on the 27th of May 1854, was in some ways the most passionately Flemish of the whole

group. He described the life of the peasants of his native Flanders with a bold realism, making himself the apologist of the vagabond and the outcast in a series of tragic stories:—*Kees Doornik* (1883), *Kermesses* (1883), *Nouvelles Kermesses* (1887), *Le Cycle patibulaire* (1892), *Mes Communions* (1895), *Escal Vigor* (1899) and *La Fanéuse d'amour* (1900), &c. *Nouvelle Carthage* (1888) deals with modern Antwerp. In 1892 he produced a striking book on English literature entitled *Au siècle de Shakespeare*, and has written French versions of Beaumont and Fletcher's *Philaster* (1895) and of Marlow's *Edward II.* (1896).

The earlier work of "Young Belgium" in poetry was experimental in character, and was marked by extravagances of style and a general exuberance which provoked much hostile criticism. The young writers of 1870 to 1880 had not long to wait, however, for recognition both at home and in Paris, where many of them found hospitality in the pages of the *Mercure de France* from 1890 onwards. They divided their allegiance between the leaders of the French Parnassus and the Symbolists.

The most powerful of the Belgian poets, Émile Verhaeren (q.v.), is the most daring in his technical methods of expressing bizarre sensation, and has been called the "poet of paroxysm." His reputation extends far beyond the limits of his own country.

Many of the Belgian poets adhere to the classical form. Albert Giraud (born at Louvain in 1860) was faithful to the Parnassian tradition in his *Pierrot lunaire* (1884), *Pierrot narcissé* (1892) and *Hors du siècle* (1886). In the earlier works of Iwan Gilkin (born at Brussels in 1858) the influence of Charles Baudelaire is predominant. He wrote *Damnation de l'artiste* (1890), *Ténèbres* (1892), *Stances dorées* (1893), *La Nuit* (1897) and *Prométhée* (1899). The poems of Valère Gille (born at Brussels in 1867), whose *Cithare* was crowned by the French Academy in 1898, belong to the same group. Émile van Arenbergh (born at Louvain in 1854) is the author of some exquisite sonnets. Fernand Severin (b. 1867) in his *Poèmes ingénus* (1900) aims at simplicity of form, and seems to have learnt the art of his musical verse direct from Racine. With Severin is closely associated Georges Marlow (b. 1872), author of *L'Âme en exil* (1895).

Georges Rodenbach (1855-1898) spent most of his life in Paris and was an intimate of Edmond de Goncourt. He produced some Parisian and purely imitative work; but the best part of his production is the outcome of a passionate idealism of the quiet Flemish towns in which he had passed his childhood and early youth. In his best known work, *Bruges la Morte* (1892), he explains that in his aim is to evoke the town as a living being, associated with the moods of the spirit, counselling, dissuading from and prompting action.

The most famous of all modern Belgian writers, Maurice Maeterlinck (q.v.), made his début in a Parisian journal, the *Pleiade*, in 1886. He succeeded more nearly than any of his predecessors in expressing or suggesting ideas and emotions which might have been supposed to be capable of translation only in terms of music. "The unconscious self, or rather the sub-conscious self," says Émile Verhaeren, "is recognized in the verse and prose of Maeterlinck its language or rather its stammering attempt at language." Maeterlinck was a native of Ghent, and the first poems of two of his fellow-townsmen also appeared in the *Pleiade*. These were Grégoire le Roy (b. 1862), author of *La Chanson d'un soir* (1886), and *Mon Cœur pleure d'autrefois* (1886); and Charles van Lerberghe (b. 1861), author of a play, *Les Fleuraers* (1890) and a collection of *Poèmes* (1897).

Max Elskamp (born at Antwerp in 1862) is the author of some volumes of religious poetry—*Dominical* (1892), *Salutations, dont d'angéliques* (1893), *En symbole vers l'apostolat* (1895)—for which he has devised as background an imaginary city. Eugène Demolder (b. 1862) also created a mythical city as a setting for his prose *contes* in the *Légende d'Yperdamme* (1897).

Belgian literary activity extends also to historical research. Baron Kervyn de Lettenhove (1817-1891) wrote a *Histoire de Flandre* (7 vols., 1847-1855), and a number of monographs on separate points in Flemish and English history. Though an

accurate historian, he allowed himself to be prejudiced by his extreme Catholic views. He was a vehement defender of Mary Stuart. Louis Gachard (1800-1885) wrote many valuable works on 16th century history; Mgr. Namèche (1810-1893) completed the 29th volume of his *Cours d'histoire nationale* before his death; Charles Piot (b. 1812) edited the correspondence of Cardinal de Granvelle; Alphonse Wauters (1818-1898), archivist of Brussels, published many archaeological works; and Charles Rahlenbeck (1823-1903) wrote enthusiastically of the history of Protestantism in Belgium. One of the most masterly writers of French in Belgium was the economist Émile de Laveleye (q.v.). In aesthetics should be noted the historian of music, François Joseph Fétis (1784-1871); F. A. Gevaert (1828-1908), author of *Histoire et théorie de la musique d'antiquité* (2 vols., 1875-1881); and Victor Mahillon (b. 1841) for his work in acoustics and his descriptive catalogue (1893-1900) of the museum of musical instruments belonging to the Brussels conservatoire. In psychology Joseph Delbœuf (1831-1896) enjoyed a great reputation outside Belgium; Elisée Reclus (b. 1830), though a Frenchman by birth, completed his *Géographie universelle* (1875-1894) in exile at Brussels; and Ernest Nys has written many standard works on international law. In the history of literature an important work is compiled by Ferdinand van der Haeghen and others in the *Bibliotheca Belgica* (1880, &c.), comprising a description of all the books printed in the Netherlands in the 15th and 16th centuries. The vicomte de Spoelberch de Lovenjoul (1836-1907) was well known in France as the author of *Sainte-Beuve inconnu* (1901), *La Genèse d'un roman de Balzac* (1901), *Une Page perdue de H. de Balzac* (1903), and of numerous bibliographical works.

See F. V. Goethals, *Histoire des lettres, des sciences et des arts en Belgique* (4 vols., 1840-1844); Fr. Masoin, *Histoire de la littérature française en Belgique de 1815 à 1830* (1903); F. Nautet, *Histoire des lettres belges d'expression française* (3 vols., 1892 & seq.), written from the point of view of young Belgium, and by no means impartial; A. de Koninck, *Bibliographie nationale* brought down to 1880; and *Bibliographie nationale de Belgique* (1866, &c.) in progress; see also articles by Émile Verhaeren in the *Revue des revues* (15th June 1896), by Albert Mocket in the *Revue encyclopédique* (24th July 1897); a collection of criticisms chiefly on Belgian writers by Eugène Gilbert, *France et Belgique; études littéraires* (1905); Frédéric Faber, *Histoire du théâtre français en Belgique* (5 vols., 1878-1880). An excellent anthology of Belgian poets was published by K. Pol de Mont with the title of *Modernités* (1898). (E. G.)

BELGRADE (Serbian, *Biograd* or *Beograd*, i.e. "White Castle"), the capital of Servia. Pop. (1900) 69,097. Belgrade occupies a triangular ridge or foreland, washed on the north-west by the Save, and on the north-east by the Danube; these rivers flowing respectively from the south-west and north-west. The sides of the triangle slope down abruptly towards the west, more gradually towards the east; at the base stands the cone of Avala Hill, the last outpost of the Rudnik Mountains, which extend far away to the south; and, at the apex, a cliff of Tertiary chalk, 200 ft. high, overlooks the confluence of the two rivers, the large, flat island of Veliki Voyn and several smaller islets. This cliff is crowned by the walls and towers of the citadel, once white, but now maroon with age, and, though useful as a prison and barracks, no longer of any military value. Behind the citadel, and along its *glacis* on the southern side, are the gardens of Kalemegdan, commanding a famous view across the river; behind Kalemegdan comes Belgrade itself, a city of white houses, among which a few great public buildings, like the high school, national bank, national theatre and the so-called New Palace, stand forth prominently. The town was formerly divided into three parts, namely, the Old town, the Russian town (*Sava-Makhala* or Save district), and the Turkish town (*Dortol*, or Cross-road). A great change, however, took place in the course of the 19th century, and the old divisions are only partially applicable, while there has to be added the Tirazia, an important suburban extension along the line of the aqueduct or *Tirasi*. A few old Turkish houses, built of plaster, with red-tiled roofs, are left among the ill-planned and insanitary districts bordering upon the rivers, but as the royal residence, the seat of government, and the centre of the import trade, Belgrade was, after 1869,

rapidly transformed into a modern European town, with wide streets, electric tramways and electric lighting. Only the multitude of small gardens, planted with limes, acacias and lilacs, and the bright costumes of the Servian or Hungarian peasants, remain to distinguish it from a western capital. For a town of such importance, which is also the seat of the metropolitan of Servia, Belgrade has very few churches, and these are of a somewhat modest type. There were, in 1900, four Servian Orthodox churches, including the cathedral, one Roman Catholic chapel, one Evangelical chapel (German), two synagogues and one mosque. This last is kept up entirely at the expense of the Servian government.

The highest educational establishments are to be found in Belgrade: the *Velika Shkola* (a small university with three faculties), the military academy, the theological seminary, the high school for girls, a commercial academy, and several schools for secondary education on German models. A commercial tribunal, a court of appeal and the court of cassation are also in Belgrade. There is a fine monument to Prince Michael (1860-1868) who succeeded in removing the Turkish garrison from the Belgrade citadel and obtaining other Turkish fortresses in Servia by skilful diplomacy. There are also an interesting national museum, with Roman antiquities and numismatic collections, a national library with a wealth of old Servian MSS. among its 40,000 volumes, and a botanical garden, rich in specimens of the Balkan flora. To promote commerce there are a stock and produce exchange (*Berza*), a national bank, privileged to issue notes, and several other banking establishments. The insurance work is done by foreign companies.

The bulk of the foreign trade of Servia passes through Belgrade, but the industrial output of the city itself is not large, owing to the scarcity both of labour and capital. The principal industries are brewing, iron-founding and the manufacture of cloth, boots, leather, cigarettes, matches, pottery, preserved meat and confectionery. The railway from Budapest to Constantinople crosses the Save by a fine bridge on the south-west, above the landing-place for steamers. Further south is the park of *Topčider*, with an old Turkish kiosk built by Prince Miloš (1818-1839) in the beautifully laid-out grounds. In the adjoining forest of lime-trees, called *Koshutnyak* or the "deer-park," Prince Michael was assassinated in 1868. Just opposite the citadel, in a north-westerly direction, half-an-hour by steamer across the Danube, lies the Hungarian town of Semlin. For administrative purposes, Belgrade forms a separate department of the kingdom.

The first fortification of the rock, at the confluence of the Save and the Danubé, was made by the Celts in the 3rd century B.C. They gave it the name of *Singidunum*, by which Belgrade was known until the 7th century A.D. The Romans took it from the Celts, and replaced their fort by a regular Roman *castrum*, placing in it a strong garrison. Roman bricks, dug up in the fortress, bear the inscription, *Legio IV. Flavia Felix*. From the 4th to the beginning of the 6th century A.D. it often changed its masters (Huns, Sarmatians, Goths, Gepids); then the emperor Justinian brought it once more under Roman rule and fortified and embellished it. Towards the end of the 8th century it was taken by the Franks of Charlemagne. In the 9th century it was captured by the Bulgarians, and held by them until the beginning of the 11th century, when the Byzantine emperor Basil II. reconquered it for the Greek empire. The Hungarians, under king Stephen, took it from the Greeks in 1124. From that time it was constantly changing hands—Greeks, Bulgarians, Hungarians, replacing each other in turn. The city was considered to be the key of Hungary, and its possession was believed to secure possession of Servia, besides giving command of the traffic between the Upper and the Lower Danube. It has, in consequence, seen more battles under its walls than most fortresses in Europe. The Turks used to call it *Darol-i-Jehad*, "the home of wars for faith." During the 14th century it was in the hands of the Servian kings. The Servian prince George Brankovich ceded it to the Hungarians in 1427. The Turkish forces unsuccessfully besieged the city

in 1444 and 1456, on which last occasion a glorious victory was obtained by the Christian garrison, led by the famous John Hunyady and the enthusiastic monk John Capistran. In 1521 Sultan Suleiman took it from the Hungarians, and from that year it remained in Turkish possession until 1688, when the Austrians captured it, only to lose it again in 1690. In 1717 Prince Eugene of Savoy conquered it for Austria, which kept it until 1739, improving the fortifications and giving great impulse to the commercial development of the town. From 1739 to 1789 the Turks were again its masters, when, in that last year, the Austrians under General Laudon carried it by assault, only to lose it again in 1792. In 1807 the Servians, having risen for their independence, forced the Turkish garrison to capitulate, and became masters of Belgrade, which they kept until the end of September 1813, when they abandoned it to the Turks. Up to the year 1862 not only was the fortress of Belgrade garrisoned by Turkish troops, but the Danubian slope of the town was inhabited by Turks, living under a special Turkish administration, while the modern part of the town (the plateau of the ridge and the western slope) was inhabited by Servians living under their own authorities. This dual government was a constant cause of friction between the Servians and the Turks, and on the occasion of one conflict between the two parties the Turkish commander of the fortress bombarded the Servian part of the town (June 1862). The indirect consequence of this incident was that in 1866, on the categorical demand of Prince Michael of Servia, and under the diplomatic pressure of the great powers, the sultan withdrew the Turkish garrison from the citadel and delivered it to the Servians. (C. M.)

BELHAVEN AND STENTON, JOHN HAMILTON, 2ND BARON (1656-1708), was the eldest son of Robert Hamilton, Lord Presmann (d. 1666), and was born on the 5th of July 1656. Having married Margaret, granddaughter of John Hamilton, 1st Baron Belhaven and Stenton, who had been made a peer by Charles I. in 1647, he succeeded to this title in 1679. In 1681 he was imprisoned for opposing the government and for speaking slightly of James, duke of York, afterwards James II., in parliament, and in 1689 he was among those who asked William of Orange to undertake the government of Scotland. Belhaven was at the battle of Killiecrankie; he was a member of the Scottish privy council, and he was a director of the Scottish Trading Company, which was formed in 1605 and was responsible for the Darien expedition. He favoured the agitation for securing greater liberty for his country, an agitation which culminated in the passing of the Act of Security in 1705, and he greatly disliked the union of the parliaments, a speech which he delivered against this proposal in November 1706 attracting much notice and a certain amount of ridicule. Later he was imprisoned, ostensibly for favouring a projected French invasion, and he died in London on the 21st of June 1708. Belhaven is chiefly famous as an orator, and two of his speeches, one of them the famous one of November 1706, were printed by D. Defoe in an appendix to his *History of the Union* (1786).

Belhaven's son, John, who fought on the English side at Sheriffmuir, became the 3rd baron on his father's death. He was drowned in November 1721, whilst proceeding to take up his duties as governor of Barbados, and was succeeded by his son John (d. 1764). After the death of John's brother James in 1777 the title was for a time dormant; then in 1799 the House of Lords declared that William Hamilton (1765-1814), a descendant of John Hamilton, the paternal great-grandfather of the 2nd baron, was entitled to the dignity. William, who became the 7th baron, was succeeded by his son Robert (1793-1868), who was created a peer of the United Kingdom as Baron Hamilton of Wishaw in 1831. He died without issue in December 1868, when the barony of Hamilton became extinct; in 1875 the House of Lords declared that his cousin, James Hamilton (1822-1893) was rightfully Baron Belhaven and Stenton, and the title descended to his kinsman, Alexander Charles (b. 1840), the 10th baron.

BELISARIUS (c. 505-565), one of the most famous generals of the later Roman empire, was born about A.D. 505, in "Germania,"

a district on the borders of Thrace and Macedonia. His name is supposed to be Slavonic. As a youth he served in the body-guard of Justinian, who appointed him commander of the Eastern army. He won a signal victory over the Persians in 530, and successfully conducted a campaign against them, until forced, by the rashness of his soldiers, to join battle and suffer defeat in the following year. Recalled to Constantinople, he married Antonina, a clever, intriguing woman, and a favourite of the empress Theodora. During the sedition of the "green" and "blue" parties of the circus (known as the Nika sedition, 532) he did Justinian good service, effectually crushing the rebels who had proclaimed Hypatius emperor. In 533 the command of the expedition against the Vandal kingdom in Africa, a perilous office, which the rest of the imperial generals shunned, was conferred on Belisarius. With 15,000 mercenaries, whom he had to train into Roman discipline, he took Carthage, defeated Gelimer the Vandal king, and carried him captive, in 534, to grace the first triumph witnessed in Constantinople. In reward for these services Belisarius was invested with the consular dignity, and medals were struck in his honour. At this time the Ostrogothic kingdom, founded in Italy by Theodoric the Great, was shaken by internal dissensions, of which Justinian resolved to avail himself. Accordingly, Belisarius invaded Sicily; and, after storming Naples and defending Rome for a year against almost the entire strength of the Goths in Italy, he concluded the war by the capture of Ravenna, and with it of the Gothic king Vitiges. So conspicuous were Belisarius's heroism and military skill that the Ostrogoths offered to acknowledge him emperor of the West. But his loyalty did not waver; he rejected the proposal and returned to Constantinople in 540. Next year he was sent to check the Persian king Chosroes (Anushirvan); but, thwarted by the turbulence of his troops, he achieved no decisive result. On his return to Constantinople he lived under a cloud for some time, but was pardoned through the influence of Antonina with the empress. The Goths having meanwhile reconquered Italy, Belisarius was despatched with utterly inadequate forces to oppose them. Nevertheless, during five campaigns he held his enemies at bay, until he was removed from the command, and the conclusion of the war was entrusted to the eunuch Narses. Belisarius remained at Constantinople in tranquil retirement until 559, when an incursion of Bulgarian savages spread a panic through the metropolis, and men's eyes were once more turned towards the neglected veteran, who placed himself at the head of a mixed multitude of peasants and soldiers, and repelled the barbarians with his wonted courage and adroitness. But this, like his former victories, stimulated Justinian's envy. The saviour of his country was coldly received and left unrewarded by his suspicious sovereign. Shortly afterwards Belisarius was accused of complicity in a conspiracy against the emperor (562); his fortune was confiscated, and he was confined as a prisoner in his palace. He was liberated and restored to favour in 563, and died in 565.

The fiction of Belisarius wandering as a blind beggar through the streets of Constantinople, which has been adopted by Marmontel in his *Bélisaire*, and by various painters and poets, is first heard of in the 10th century. Gibbon justly calls Belisarius the Africanus of New Rome. He was merciful as a conqueror, stern as a disciplinarian, enterprising and wary as a general; while his courage, loyalty and forbearance seem to have been almost unswerving. He was the idol of his soldiers, a good tactician, but not a great strategist.

AUTHORITIES.—Procopius, *De Belis et Historia Arcana* (best edition by J. Haury, 1905, 1907); see Gibbon, *Decline and Fall* (ed. Bury, vol. 4); T. Hodgkin, *Italy and her Invaders* (vol. 4); J. B. Bury, *Later Roman Empire*, vol. 1; Diehl, *Justinian* (Paris, 1901).

(J. B. H.)

BELIT (signifying the "lady," *par excellence*), in the Babylonian religion the designation of the consort of Bel (*g.v.*). Her real name was Nin-lil, i.e. the "lady of power," if the explanation suggested in *BEL* for the second element is correct. She is also designated as Nin-Khar-sag, "Lady of the mountain," which name stands in some relationship to Im-Khar-sag, "storm mountain"—the name of the staged tower or sacred edifice to

Bel at Nippur. As the consort of En-lil, the goddess Nin-lil or Belit belongs to Nippur and her titles as "ruler of heaven and earth," and "mother of the gods" are all due to her position as the wife of Bel. While recognized by a temple of her own in Nippur and honoured by rulers at various times by having votive offerings made in her honour and fortresses dedicated in her name, she, as all other goddesses in Babylonia and Assyria with a single exception of Ishtar, is overshadowed by her male consort. The title Belit was naturally transferred to the great mother-goddess Ishtar after the decline of the cult at Nippur, and we also find the consort of Marduk, known as Sarpanit, designated as Belit, for the sufficient reason that Marduk, after the rise of the city of Babylon as the seat of his cult, becomes the Bel or "lord" of later days. (M. J. A.)

BELIZE, or BALIZE, the capital and principal seaport of British Honduras, on the Caribbean Sea, in 17° 29' N. and 88° 11' W. Pop. (1904) 9669. Belize occupies both banks of the river Belize, at its mouth. Its houses are generally built of wood, with high roofs and wide verandahs shaded by cocoanut or cabbage palms. The principal buildings are the court house, in the centre of the town, government house, at the southern end, Fort George, towards the north, the British bank of Honduras, the hospital, the Roman Catholic convent, and the Wesleyan church, which is the largest and handsomest of all. Mangrove swamps surround the town and epidemics of cholera, yellow fever and other tropical diseases have been frequent; but the unhealthiness of the climate is mitigated to some extent by the high tides which cover the marshes, and the invigorating breezes which blow in from the sea. Belize is connected by telegraph and telephone with the other chief towns of British Honduras, but there is no railway, and communication even by road is defective. The exports are mahogany, rosewood, cedar, logwood and other cabinet-woods and dye-woods, with cocoanuts, sugar, sarsaparilla, tortoiseshell, deerkins, turtles and fruit, especially bananas. Breadstuffs, cotton fabrics and hardware are imported.

Belize probably derives its name from the French *balise*, "a beacon," as no doubt some signal or light was raised here for the guidance of the buccaners who once infested this region. Local tradition connects the name with that of Wallis or Wallace, a Scottish buccaneer, who, in 1638, settled, with a party of logwood cutters, on St George's Cay, a small island off the town. In the 18th century the names Wallis and Belize were used interchangeably for the town, the river and the whole country. The history of Belize is inextricably bound up with that of the rest of British Honduras (*g.v.*).

BELJAME, ALEXANDRE (1842-1906), French writer, was born at Villiers-le-Bel, Seine-et-Oise, on the 26th of November 1842. He spent part of his childhood in England and was a frequent visitor in London. His lectures on English literature at the Sorbonne, where a chair was created expressly for him, did much to promote the study of English in France. In 1905-1906 he was Clark lecturer on English literature at Trinity College, Cambridge. He died at Domont (Seine-et-Oise) on the 19th of September 1906. His best known book was a mastery study of the conditions of literary life in England in the 18th century illustrated by the lives of Dryden, Addison and Pope. This book, *Le Public et les hommes de lettres en Angleterre au XVIII^e siècle* (1887), was crowned by the French Academy on the appearance of the second edition in 1897. He was a good Shakespearean scholar, and his editions of *Macbeth*, *Othello* and *Julius Caesar* also received an academic prize in 1902.

BELKNAP, JEREMY (1744-1798), American author and clergyman, was born at Boston on the 4th of June 1744, and was educated at Harvard College, where he graduated in 1762. In 1767 he became minister of a Congregational church at Dover, New Hampshire, remaining there until 1787, when he removed to Federal Street church, Boston. He is recognized as the founder of the Massachusetts Historical Society, and in 1792 became an overseer of Harvard. He died at Boston on the 20th of June 1798. Belknap's chief works are: *History of New Hampshire* (1784-1792); *An Historical Account of those*

persons who have been distinguished in America, generally known as *American Biography* (1792-1794); *The Foresters* (1792), &c.

BELKNAP, WILLIAM WORTH (1829-1890), American soldier and politician, was born at Newburgh, N.Y., on the 22nd of September 1829. Entering the Union army in 1861, he took part in the battles of Shiloh, Corinth and Vicksburg, as major of the 15th Iowa volunteers. In the Atlanta campaign under Sherman he gained considerable distinction, rising successively to the rank of brigadier-general in 1864 and major-general in 1865. During the four years that followed he was collector of internal revenue for Iowa, leaving that post in 1869 to become secretary of war. In 1876, in consequence of unproved accusations of corruption, he resigned. He died at Washington, D.C., on the 13th of October 1890.

BELL, ALEXANDER GRAHAM (1847-), American inventor and physicist, son of Alexander Melville Bell, was born in Edinburgh, Scotland, on the 3rd of March 1847. He was educated at the university of Edinburgh and the university of London, and removed with his father to Canada in 1870. In 1872 he became professor of vocal physiology in Boston University. In 1876 he exhibited an apparatus embodying the results of his studies in the transmission of sound by electricity, and this invention, with improvements and modifications, constitutes the modern commercial telephone. He was the inventor also of the photophone, an instrument for transmitting sound by variations in a beam of light, and of phonographic apparatus. Later, he interested himself in the problem of mechanical flight. He published many scientific monographs, including a memoir on the formation of a deaf variety in the human race.

BELL, ALEXANDER MELVILLE (1810-1905), American educationalist, was born at Edinburgh, Scotland, on the 1st of March 1810. He studied under and became the principal assistant of his father, Alexander Bell, an authority on phonetics and defective speech. From 1843 to 1865 he lectured on elocution at the university of Edinburgh, and from 1865 to 1870 at the university of London. In 1868, and again in 1870 and 1871, he lectured in the Lowell Institute course in Boston. In 1870 he became a lecturer on philology at Queen's College, Kingston, Ontario; and in 1881 he removed to Washington, D.C., where he devoted himself to the education of deaf mutes by the "visible speech" method of orthoepy, in which the alphabetical characters of his own invention were graphic diagrams of positions and motions of the organs of speech. He held high rank as an authority on physiological phonetics (*q.v.*) and was the author of numerous works on orthoepy, elocution and education, including *Steno-Phonography* (1852); *Letters and Sounds* (1858); *The Standard Elocutionist* (1860); *Principles of Speech and Dictionary of Sounds* (1863); *Visible Speech: The Science of Universal Alphabets* (1867); *Sounds and their Relations* (1881); *Lectures on Phonetics* (1885); *A Popular Manual of Visible Speech and Vocal Physiology* (1889); *World English: the Universal Language* (1888); *The Science of Speech* (1897); *The Fundamentals of Elocution* (1899).

See John Hitz, *Alexander Melville Bell* (Washington, 1906).

BELL, ANDREW (1753-1832), British divine and educationalist, was born at St Andrews on the 27th of March 1753. He graduated at the university there, and afterwards spent some years as a tutor in Virginia, U.S.A. On his return he took orders, and in 1787 sailed for India, where he held eight army chaplaincies at the same time. In 1789 he became superintendent of the male orphan asylum at Madras, and having been obliged from scarcity of teachers to introduce the system of mutual tuition by the pupils, found the scheme answer so well that he became convinced of its universal applicability. In 1797, after his return to London, he published a small pamphlet explaining his views on education. Little public attention was drawn towards the "monitorial" plan till Joseph Lancaster (*q.v.*), the Quaker, opened a school in Southwark, conducting it in accordance with Bell's principles, and improving on his system. The success of the method, and the strong support given to Lancaster by the whole body of Nonconformists gave immense impetus to the movement. Similar schools were established in great

numbers; and the members of the Church of England, becoming alarmed at the patronage of such schools resting entirely in the hands of dissenters, resolved to set up similar institutions in which their own principles should be inculcated. In 1807 Bell was called from his rectory of Swanage in Dorset to organize a system of schools in accordance with these views, and in 1811 became superintendent of the newly formed "National Society for Promoting the Education of the Poor in the Principles of the Established Church." For his valuable services he was in some degree recompensed by his preference to a prebend of Westminster, and to the mastership of Sherburn hospital, Durham. He tried, but without success, to plant his system in Scotland and on the continent. He died on the 27th of January 1832, at Cheltenham, and was buried in Westminster Abbey. His great fortune was bequeathed almost entirely for educational purposes. Of the £120,000 given in trust to the provost of St Andrews, two city ministers and the professor of Greek in the university, half was devoted to the founding of the important school, called the Madras College, at St Andrews; £10,000 was left to each of the large cities, Edinburgh, Glasgow, Leith, Inverness and Aberdeen, for school purposes; and £10,000 was also given to the Royal Naval School.

Southey's Life of Dr Bell (3 vols.) is very tedious; J. D. Meiklejohn's *An Old Educational Reformer* is concise and accurate.

BELL, SIR CHARLES (1774-1842), Scottish anatomist, was born at Edinburgh in November 1774, the youngest son of the Rev. William Bell, a clergyman of the Episcopal Church of Scotland; among his brothers were the anatomist, John Bell, and the jurist, G. J. Bell. After attending the high school and the university of Edinburgh, he embraced the profession of medicine, and devoted himself chiefly to the study of anatomy, under the direction of his brother John. His first work, entitled *A System of Dissections, explaining the anatomy of the human body, the manner of displaying the parts, and their varieties in disease*, was published in Edinburgh in 1798, while he was still a pupil, and for many years was considered to be a valuable guide to the student of practical anatomy. In 1802 he published a series of engravings of original drawings, showing the anatomy of the brain and nervous system. These drawings, which are remarkable for artistic skill and finish, were taken from dissections made by Bell for the lectures or demonstrations he gave on the nervous system as part of the course of anatomical instruction of his brother. In 1804 he wrote the third volume, containing the anatomy of the nervous system and of the organs of special sense, of *The Anatomy of the Human Body*, by John and Charles Bell. In November of the same year he migrated to London, and from that date, for nearly forty years, he kept up a regular correspondence with his brother George, much of which was published in the *Letters of Sir Charles Bell, &c.*, 1870. The earlier letters of this correspondence show how rapidly he rose to distinction in a field where success was difficult, as it was already occupied by such men as John Abernethy, Sir Astley Cooper and Henry Cline. Before leaving Edinburgh, he had written his work on the *Anatomy of Expression*, which was published in London soon after his arrival and at once attracted attention. His practical knowledge of anatomy and his skill as an artist qualified him in an exceptional manner for such a work. The object of this treatise was to describe the arrangements by which the influence of the mind is propagated to the muscular frame, and to give a rational explanation of the muscular movements which usually accompany the various emotions and passions. One special feature was the importance attributed to the respiratory arrangements as a source of expression, and it was shown how the physician and surgeon might derive information regarding the nature and extent of important diseases by observing the expression of bodily suffering. This work, apart from its value to artists and psychologists, is of interest historically, as there is no doubt the investigations of the author into the nervous supply of the muscles of expression induced him to prosecute inquiries which led to his great discoveries in the physiology of the nervous system.

In 1811 Bell published his *New Idea of the Anatomy of the Brain*,

in which he announced the discovery of the different functions of the nerves corresponding with their relations to different parts of the brain; his latest researches were described in *The Nervous System of the Human Body* (1830), a collection of papers read by him before the Royal Society. He discovered that in the nervous trunks there are special sensory filaments, the office of which is to transmit impressions from the periphery of the body to the sensorium, and special motor filaments which convey motor impressions from the brain or other nerve centre to the muscles. He also showed that some nerves consist entirely of sensory filaments and are therefore sensory nerves, that others are composed of motor filaments and are therefore motor nerves, whilst a third variety contains both kinds of filaments and are therefore to be regarded as sensory-motor. Furthermore, he indicated that the brain and spinal cord may be divided into separate parts, each part having a special function—one part ministering to motion, the other to sensation, and that the origin of the nerves from one or other or both of those sources endows them with the peculiar property of the division whence they spring. He also demonstrated that no motor nerve ever passes through a ganglion. Lastly, he showed, both from theoretical considerations and from the result of actual experiment on the living animal, that the anterior roots of the spinal nerves are motor, while the posterior are sensory. These discoveries as a whole must be regarded as the greatest in physiology since that of the circulation of the blood by William Harvey. They were not only a distinct and definite advance in scientific knowledge, but from them flowed many practical results of much importance in the diagnosis and treatment of disease. It is not surprising that Bell should have viewed his results with exultation. On the 26th of November 1807, he wrote to his brother George:—"I have done a more interesting *nova anatomia cerebri humani* than it is possible to conceive. I lectured it yesterday. I prosecuted it last night till one o'clock; and I am sure it will be well received." On the 31st of the same month he wrote:—"I really think this new anatomy of the brain will strike more than the discovery of the lymphatics being absorbents."

In 1807 he produced a *System of Comparative Surgery*, in which surgery is regarded almost wholly from an anatomical and operative point of view, and there is little or no mention of the use of medicinal substances. It placed him, however, in the highest rank of English writers on surgery. In 1809 he relinquished his professional work in London, and rendered meritorious services to the wounded from Coruña, who were brought to the Haslar hospital at Portsmouth. In 1810 he published a series of *Letters concerning the Diseases of the Urethra*, in which he treated of stricture from an anatomical and pathological point of view. In 1812 he was appointed surgeon to the Middlesex hospital, a post he retained for twenty-four years. He was also professor of anatomy, physiology and surgery to the College of Surgeons of London, and for many years teacher of anatomy in the school which used to exist in Great Windmill Street. In 1815 he went to Brussels to treat the wounded of the battle of Waterloo. In 1816, 1817 and 1818, he published a series of *Quarterly Reports of Cases in Surgery*; in 1821 a volume of coloured plates with descriptive letterpress, entitled *Illustrations of the great operations of Surgery, Trepan, Hernia, Amputation and Lithotomy*, and in 1824 *Observations on Injuries of the Spine and of the Thigh Bone*. On the formation of University College, Gower Street, he was for a short time head of the medical department. In 1832 he wrote a paper for the Royal Society of London on the "Organs of the Human Voice," in which he gave many illustrations of the physiological action of these parts, and in 1833 a Bridgewater treatise, *The Hand: its Mechanism and Vital Endowments as evincing Design*. Along with Lord Brougham he annotated and illustrated an edition of Paley's *Natural Theology*, published in 1836. The Royal Society of London awarded to him in 1829 the first annual medal of that year given by George IV. for discoveries in science; and when William IV. ascended the throne, Charles Bell received the honour of knighthood along with a few other men distinguished in science and literature.

In 1836 the chair of surgery in the university of Edinburgh was offered to him. He was then one of the foremost scientific men in London, and he had a large surgical practice. But his opinion was "London is a place to live in, but not to die in"; and he accepted the appointment. In Edinburgh he did not earn great local professional success; and, it must be confessed, he was not appreciated as he deserved. But honours came thick upon him. On the continent of Europe he was spoken of as greater than Harvey. It is narrated that one day P. J. Roux, a celebrated French physiologist, dismissed his class without a lecture, saying "C'est assez, messieurs, vous avez vu Charles Bell." During his professorship he published the *Institutes of Surgery, arranged in the order of the lectures delivered in the university of Edinburgh* (1838); and in 1841 he wrote a volume of *Practical Essays*, two of which, "On Squinting," and "On the action of purgatives," are of great value. He died at Hallow Park near Worcester on the 28th of April 1842.

BELL, GEORGE JOSEPH (1770-1843), Scottish jurist, was born at Edinburgh on the 20th of March 1770. He was an elder brother of Sir Charles Bell. At the age of eight he entered the high school, but he received no university education further than attending the lectures of A. F. Tytler, Dugald Stewart and Hume. He became a member of the Faculty of Advocates in 1791, and was one of the earliest and most attached friends of Francis Jeffrey. In 1804 he published a *Treatise on the Law of Bankruptcy* in Scotland, which he subsequently enlarged and published in 1826 under the title of *Commentaries on the Law of Scotland and on the principles of Mercantile Jurisprudence*—an institutional work of the very highest excellence, which has had its value acknowledged by such eminent jurists as Joseph Story and James Kent. In 1821 Bell was elected professor of the law of Scotland in the university of Edinburgh; and in 1831 he was appointed to one of the principal clerkships in the supreme court. He was placed at the head of a commission in 1833 to inquire into the Scottish bankruptcy law; and in consequence of the reports of the commissioners, chiefly drawn up by himself, many beneficial alterations were made. He died on the 23rd of September 1843. Bell's smaller treatise, *Principles of the Law of Scotland*, became a standard text-book for law students. The *Illustrations of the Principles* is also a work of high value.

BELL, HENRY (1767-1830), Scottish engineer, was born at Torphichen, Linlithgowshire, in 1767. Having received the ordinary education of a parish school, he was apprenticed to his uncle, a millwright, and, after qualifying himself as a ship-modeller at Bo'ness, went to London, where he found employment under John Rennie, the celebrated engineer. Returning to Scotland in 1790, he first settled as a carpenter at Glasgow and afterwards removed to Helensburgh, on the Firth of Clyde where he pursued his mechanical projects, and also found occasional employment as an engineer. In January 1812 he placed on the Clyde a steamboat (which he named the "Comet") of about 25 tons, propelled by an engine of three horse power, at a speed of 7 m. an hour. Although the honour of priority is admitted to belong to the American engineer Robert Fulton, there appears to be no doubt that Fulton had received very material assistance in the construction of his vessel from Bell and others in Great Britain. A handsome sum was raised for Bell by subscription among the citizens of Glasgow; and he also received from the trustees of the river Clyde a pension of £100 a year. He died at Helensburgh on the 14th of November 1830. A monument to his memory stands on the banks of the Clyde, at Dungleigh, near Bowling.

BELL, HENRY GLASSFORD (1803-1874), a Scottish lawyer and man of letters, was born at Glasgow on the 8th of November 1803. He received his education at the Glasgow high school and at Edinburgh University. He became intimate with "Delta" Moir, James Hogg, John Wilson (Christopher North), and others of the brilliant staff of *Blackwood's Magazine*, to which he was drawn by his political sympathies. In 1828 he became editor of the *Edinburgh Literary Journal*, which was eventually incorporated in the *Edinburgh Weekly Chronicle*. He was admitted

to the bar in 1832. In 1839 he was appointed sheriff-substitute of Lanarkshire, and in 1867 he succeeded Sir Archibald Alison in the post of sheriff-principal of the county, an office which he filled with distinguished success. In 1831 he published *Summer and Winter Hours*, a volume of poems, of which the best known is that on Mary, queen of Scots. He further defended the cause of the unfortunate queen in a prose *Life* (2 vols., 1828-1831). Among his other works may be mentioned a preface which he wrote to Bell and Bains's edition (1865) of the works of Shakespeare, and *Romances and Minor Poems* (1866). He figures in the society of the *Noctes Ambrosianae* as "Tallboys." He died on the 7th of January 1874.

BELL, JACOB (1810-1859), British pharmaceutical chemist, was born in London on the 5th of March 1810. On the completion of his education, he joined his father in business as a chemist in Oxford Street, and at the same time attended the chemistry lectures at the Royal Institution, and those on medicine at King's College. Always keenly alive to the interests of chemists in general, Bell conceived the idea of a society which should at once protect the interests of the trade, and improve its status, and at a public meeting held on the 15th of April 1841, it was resolved to found the Pharmaceutical Society of Great Britain. Bell carried his scheme through in the face of many difficulties, and further advanced the cause of pharmacy by establishing the *Pharmaceutical Journal*, and superintending its publication for eighteen years. The Pharmaceutical Society was incorporated by royal charter in 1843. One of the first abuses to engage the attention of the new body was the practice of pharmacy by unqualified persons, and in 1845 Bell drew up the draft of a bill to deal with the matter, one of the provisions of which was the recognition of the Pharmaceutical Society as the governing body in all questions connected with pharmacy. For some time after this the question of pharmaceutical legislation was widely discussed. In 1850 Bell successfully contested the borough of St Albans in order that he might be able to advocate his proposals for reform more effectually in parliament. In 1851 he brought forward a bill embodying these proposals. It passed its second reading, but was considerably whittled down in committee, and when eventually it became law it only partially represented its sponsor's intentions. Bell was the author of an *Historical Sketch of the Progress of Pharmacy in Great Britain*. He died on the 12th of June 1859.

BELL, JOHN (1691-1780), Scottish traveller, was born at Antermory in Scotland in 1691, and educated for the medical profession, in which he took the degree of M.D. In 1714 he set out for St Petersburg, where, through the introduction of a countryman, he was nominated medical attendant to Valensky, recently appointed to the Persian embassy, with whom he travelled from 1715 to 1718. The next four years he spent in an embassy to China, passing through Siberia and the great Tatar deserts. He had scarcely rested from this last journey when he was summoned to attend Peter the Great in his perilous expedition to Derbend and the Caspian Gates. The narrative of this journey he enriched with interesting particulars of the public and private life of that remarkable prince. In 1738 he was sent by the Russian government on a mission to Constantinople, to which, accompanied by a single attendant who spoke Turkish, he proceeded in the midst of winter and all the horrors of war, returning in May to St Petersburg. It appears that after this he was for several years established as a merchant at Constantinople, where he married in 1746. In the following year he retired to his estate of Antermory, where he spent the remainder of his life. He died in 1780. His travels, published at Glasgow in 1763, were speedily translated into French, and widely circulated in Europe.

BELL, JOHN (1763-1820), Scottish anatomist and surgeon, an elder brother of Sir Charles Bell, was born at Edinburgh on the 12th of May 1763. After completing his professional education at Edinburgh, he carried on from 1790 in Surgeons' Square an anatomical lecture-theatre, where, in spite of much opposition, due partly to the unconservative character of his teaching, he attracted large audiences by his lectures, in which he was for a

time assisted by his younger brother Charles. In 1793-1795 he published *Discourses on the Nature and Cure of Wounds*, and in 1800 he became involved in an unfortunate controversy with James Gregory (1753-1821), the professor of medicine at Edinburgh. Gregory in 1800 attacked the system whereby the fellows of the Royal College of Surgeons of Edinburgh acted in rotation as surgeons at the Royal Infirmary, with the result that the younger fellows were excluded. Bell, who was among the number, composed an *Answer for the Junior Members* (1800), and ten years later published a collection of *Letters on Professional Character and Manners*, which he had addressed to Gregory. After his exclusion from the infirmary he ceased to lecture and devoted himself to study and practice. In 1816 he was injured by a fall from his horse and in the following year went to Italy for the benefit of his health. He died at Rome on the 15th of April 1820. His works also included *Principles of Surgery* (1801), *Anatomy of the Human Body*, which went through several editions and was translated into German, and *Observations on Italy*, published by his widow in 1825.

BELL, JOHN (1797-1866), American political leader, was born near Nashville, Tennessee, on the 15th of February 1797. He graduated at the university of Nashville in 1814, and in 1817 was elected to the state senate, but retiring after one term, he devoted himself for ten years to the study and the practice of the law. From 1827 until 1841 he was a member of the national House of Representatives, of which from June 1834 to March 1835 he was the speaker, and in which he was conspicuous as a debater and a conservative leader. Though he entered political life as a Democrat, he became estranged from his party's leader, President Jackson, also a Tennessean, and after 1835 was one of the leaders of the Whig party in the South. In March 1841 he became the secretary of war in President Harrison's cabinet, but in September, after the death of Harrison and the rupture between the Whig leaders and President Tyler, he resigned this position. From 1847 until 1859 he was a member of the United States Senate, and attracted attention by his ability in debate and his political independence, being one of two Southern senators to vote against the Kansas-Nebraska Bill of 1854 and against the admission of Kansas with the Lecompton or pro-slavery constitution in 1858. Strongly conservative by temperament and devoted to the Union, he ardently desired to prevent the threatened secession of the Southern states in 1860, and was the candidate, for the presidency, of the Constitutional Union Party, often called from the names of its candidates for the presidency and the vice-presidency (Edward Everett) the "Bell and Everett Party," which was made up largely of former Whigs and Southern "Know-Nothings," opposed sectionalism, and strove to prevent the disruption of the union. The party adopted no platform, and discarding all other issues, resolved that "it is both the part of patriotism and of duty to recognize no political principle other than the constitution of the country, the union of the states, and the enforcement of the laws." Bell was defeated, but received a popular vote of 587,830 (mostly cast in the Southern states), and obtained the electoral votes of Virginia, Kentucky and Tennessee—39 altogether, out of a total of 303. Bell tried earnestly to prevent the secession of his own state, but after the issue of President Lincoln's proclamation of the 15th of April 1861 calling on the various states for volunteers, his efforts were unavailing, and when Tennessee joined the Confederacy Bell "went with his state." He took no part in the Civil War, and died on the 10th of September 1866.

BELL, ROBERT (1800-1867), Irish man of letters, was born at Cork on the 16th of January 1800. He was educated at Trinity College, Dublin, where he was one of the founders of the Dublin Historical Society. In 1828 he settled in London, where he edited a weekly paper, the *Atlas*, and until 1841 was engaged in journalism, and afterwards in miscellaneous literary work. He died on the 12th of April 1867. His most important work is his annotated edition of the *English Poets* (24 vols., 1854-1857; new ed., 29 vols., 1866), the works of each poet being prefaced by a memoir. For Lardner's *Cabinet Cyclopaedia* he wrote: *History of Russia* (3 vols., 1836-1838); *Lives of English Poets* (2 vols.,

1830); a continuation, with W. Wallace, of Sir James Mackintosh's *History of England* (vols. iv.-x., 1830-1840); and the fifth volume (1840) of the *Lives of the British Admirals*, begun by R. Southey. He was a director of the Royal Literary Fund, and well known for his open-hearted generosity to fellow men of letters.

BELL, a hollow metallic vessel used for making a more or less loud noise (A.S. *bellan*, to bellow; Mid. Eng. "to bell"; cf. "As loud as bellethe winde in helle," in Chaucer, *House of Fame*, iii. 713). Bells are usually cup-like in shape, and are constructed so as to give one fundamental note when struck. The term does not strictly include gongs, cymbals, metal plates, resonant bars of metal or wood, or tinkling ornaments, such as e.g. the "bells" upon the Jewish high priest's dress (Exodus xxviii. 32); nor is it necessary here to deal with the common useful varieties of sheep or cow bells, or bells on sledges or harness. For house bells see the end of this article. A "diving-bell" (see **DIVERS**) is only so called from the analogy of its shape.

The main interest of bells and bell-ringing has reference to church or tower bells, their history, construction and uses.

Early Bells.—Of bells before the Christian era there is no trustworthy evidence. The instruments which summoned the Romans to public baths or processions, or that which Lucian (A.D. 180) describes as set in motion by a water-clock (*depsydra*) to measure time, were probably cymbals or resonant plates of metal, like the timbrels (*corybantia aera*, Virg. *Aen.* iii. 111) used in the worship of Cybele, or the Egyptian *sistrum*, which seems to have been a sort of rattle. The earliest Latin word for a bell (*campana*) is late Latin of the 4th or 5th century A.D.; and the first application of bells to churches has been ascribed to Paulinus, bishop of Nola in Campania about A.D. 400. There is, however, no confirmation of this story, which may have arisen from the words *campana* and *nola* (a small bell); and in a letter from Paulinus to the emperor Severus, describing very fully the decoration of his church, the bishop makes no mention of bells. It has been maintained with somewhat more reason that Pope Sabinianus (604) first used church bells; but it seems clear that they were introduced into France as early as 550. In the 7th century Bede mentions a bell brought from Italy by Benedict Biscop for his abbey at Wearmouth, and speaks of the sound of a bell being well known at Whitby Abbey at the time of St Hilda's death (680). St Dunstan hung many in the 10th century; and in the 11th they were not uncommon in Switzerland and Germany. It is said that the Greek Christians were unacquainted with bells till the 9th century; but it is known that for political reasons, after the taking of Constantinople by the Turks in 1453, their use was forbidden lest they should provide a popular signal for revolt.

Several old bells are extant in Scotland, Ireland and Wales; the oldest are often quadrangular, made of thin iron plates hammered and riveted together. A well-known specimen is St Patrick's bell preserved at Belfast, called *Clog an eadhachta Phatraic*, "the bell of St Patrick's will." It is 6 in. high, 5 broad, 4 deep, adorned with gems and gold and silver filigree-work; it is inscribed 1091 and 1105, but it is probably alluded to in Ulster annals in 552. (For Scottish bells, see *Illustrated Catalogue of Archaeological Museum*, Edinburgh, for 1856.)

The four-sided bell of the Irish missionary St Gall (646) is preserved at the monastery of St Gall, Switzerland. In these early times bells were usually small; even in the 11th century a bell presented to the church at Orleans weighing 2600 lb was thought large. In the 13th century larger bells were cast. The bell Jacqueline of Paris, cast in 1400, weighed 15,000 lb; another Paris bell of 1472, 25,000 lb; and the famous Amboise bell at Rouen (1501) 36,364 lb.

To these scanty records of the early history of bells may be added the enumeration of different kinds of bells by Hieronymus Magius, in his work *De Tinninabulis*:—1. *Tinninabulum*, a little bell, otherwise called *tinniolium*, for refectory or dormitory, according to Joannes Beletus, but Guillaume Durand names *squilla* for the refectory; 2. *Petasius*, or larger "broad-brimmed hat" bell; 3. *Codon*, orifice of trumpet, a Greek hand-bell; 4. *Nola*, a very

small bell, used in the choir, according to Durand; 5. *Campana*, a large bell, first used in the Latin churches in the steeple (Durand), in the tower (Beletus); 6. *Squilla*, a shrill little bell. We read of *cymbalum* for the cloister (Durand) or *campanella* for the cloister (Beletus); *nolula* or *dupla* in the clock; *signum* in the tower (e.g. in the *Excerptions* of St Egbert, 750); the Portuguese still call a bell *sino*.

Bell-founding.—The earliest bells were probably not cast, but made of plates riveted together, like the bells of St Gall or Belfast above mentioned. The bell-founder's art, originally practised in the monasteries, passed gradually into the hands of a professional class, by whom, in England and the Low Countries especially, were gradually worked out the principles of construction, mixture of metals, lines and proportions, now generally accepted as necessary for a good bell. In England some of the early founders were peripatetic artificers, who travelled about the country, setting up a temporary foundry to cast bells wherever they were wanted. Miles Graye (c. 1650), a celebrated East Anglian founder, carried on his work in this fashion, and in old churchwardens' accounts are sometimes found notices of payment for the casting of bells at places where no regular foundry is known to have existed. The chief centres of the art in medieval times were London, York, Gloucester and Nottingham; and bells by e.g. "John of York" (14th century), Samuel Smith, father and son, of York (1680-1730), Abraham Rudhall and his descendants of Gloucester (1684-1774), Mot (16th century), Lester and Pack (1750), Christopher Hodson of London (who cast "Great Tom" of Oxford, 1681) and Richard Phelps (1716) are still in high repute. The White-chapel Bell Foundry (now Mears and Stainbank), established by Robert Mot in 1570, incorporated the business of the Rudhalls, Lester and Pack, Phelps, Briant and others, and is now one of the leading firms of bell-founders; others being Warner and Sons of Spitalfields and Taylor & Co., Loughborough, the founders of "Great Paul" for St Paul's cathedral (1881). Of Dutch and Flemish founders the firms of van den Gheyn (1550), Hemony (1650), Aerschodt & Waghevcn at Louvain and others have a great reputation in the Low Countries, especially for "carillons," such as those at Antwerp or Bruges, a form of bell-music which has not taken much root in England, despite the advocacy of the Rev. H. R. Haweis, who proclaimed its superiority to English change-ringing.

Bell-metal is a mixture of copper and tin in the proportion of 4 to 1. In Henry III.'s reign it was 2 to 1. In Layard's Nineveh bronze bells, it was 10 to 1. Zinc and lead are used in small bells. The thickness of the bell's edge is about one-tenth of its diameter, and its height is twelve times its thickness.

Bells, like viols, have been made of every conceivable shape within certain limits. The long narrow bell, the quadrangular, and the mitre-shaped in Europe at least indicate antiquity, and the graceful curved-inwardly-midway and full trumpet-mouthed bell indicates an age not earlier than the 16th century.

The bell is first designed on paper according to the scale of measurement. Then the crook is made, which is a kind of double wooden compass, the legs of which are respectively curved to the shape of the inner and outer sides of the bell, a space of the exact form and thickness of the bell being left between them. The compass is pivoted on a stake driven into the bottom of the casting-pit. A stuffing of brickwork is built round the stake, leaving room for a fire to be lighted inside it. The outside of this stuffing is then padded with fine soft clay, well mixed and bound together with calves' hair, and the inner leg of the compass run round it, bringing it to the exact shape of the inside of the bell. Upon this *core*, well smeared with grease, is fashioned the false clay bell, the outside of which is defined by the outer leg of the compass. Inscriptions are now moulded in wax on the outside of the clay-bell; these are carefully smeared with grease, then lightly covered with the finest clay, and then with coarser clay, until a solid *mantle* is thickened over the outside of the clay bell. A fire is now lighted, and the whole baked hard; the grease and wax inscriptions steam out through holes at the top, leaving the sham clay bell baked hard and tolerably loose, between the

cope and the *cope* or *mantle*. The cope is then lifted, the clay bell broken up, the *cope* let down again, enclosing now between itself and the *core* the exact shape of the bell. The metal is then boiled and run molten into the mould. A large bell will take several weeks to cool. When extricated it ought to be scarcely touched and should hardly require tuning. This is called its maiden state, and it used to be so sought after that many bells were left rough and out of tune in order to claim it.

Bell Tones and Tuning.—A good bell, fairly struck, should give out three distinct notes—a “fundamental” note or “tonic”; the octave above, or “nominal”; and the octave below, or “hum-note.” (It also gives out the “third” and “fifth” above the fundamental; but of these it is less necessary to take notice.) Very few bells, however, have any two of these notes, and hardly any all three, in unison—the “hum-notes” being generally a little sharper, and the “fundamentals” a little flatter, than their respective “nominals.” In tuning a “ring” or series of bells, the practice of founders has hitherto been to take one set of notes (in England usually the nominals, on the continent the fundamentals) and put these into tune, leaving the other tones to take care of themselves. But in different circumstances different tones assert themselves. Thus, when bells are struck at considerable intervals, the fundamental notes being fuller and more persistent are more prominent; but when struck in rapid succession (as in English change-ringing or with the higher bells of a Belgian “carillon,” which take the “air”) the higher tone of the “nominal” is more perceptible. The inharmonious character of many Belgian carillons, and of certain Belgian and French rings in England, is ascribed by Canon A. B. Simpson (in his pamphlet, *Why Bells sound out of Tune*, 1897) to neglect of the “nominals,” the fundamentals only being tuned to each other. To tune a series of bells properly, the fundamental tone of each bell must be brought into true octave with its nominal, and the whole series of bells, thus rectified, put into tune with each other. The “hum-note” of each, which is the tone of the whole mass of metal, should also be in tune with the others. If flatter than the nominal, it cannot be sharpened; but if sharper (as is more usual), it may be flattened by thinning the metal near the crown of the bell. The great bell (“Great Paul”) cast by Messrs Taylor for St Paul’s cathedral, London, has all its tones in true harmony, except that the tone next above the fundamental (E_b) is a “fourth” (A_b) instead of a “third” (G or G_b). The great bell cast by the same founders for Beverley Minster is in perfect tune; and with the improved machinery now in use, there is no reason why this should not henceforth be the case with all church bells.

The quality of a bell depends not only on the casting and the fineness and mixture of metals, but upon the due proportion of metal to the calibre of the bell. The larger the bell the lower the tone; but if we try to make a large E bell with metal only enough for a smaller F bell, the E bell will be puny and poor. It has been calculated that for a peal of bells to give the pure chord of the ground tone or key-note, third, fifth and octave, the diameters are required to be as thirty, twenty-four, twenty, fifteen, and the weights as eighty, forty-one, twenty-four and ten.

History and Uses of Bells.—The history of bells is full of romantic interest. In civilized times they have been intimately associated, not only with all kinds of religious and social uses, but with almost every important historical event. Their influence upon architecture is not less remarkable, for to them indirectly we probably owe most of the famous towers in the world. Church towers at first, perhaps, scarcely rose above the roof, being intended as lanterns for the admission of light, and addition to their height was in all likelihood suggested by the more common use of bells.

Bells early summoned soldiers to arms, as well as Christians to church. They sounded the alarm in fire or tumult; and the rights of the burghers in their bells were jealously guarded. Thus the chief bell in the cathedral often belonged to the town, not to the cathedral chapter. The curfew, the Carolus and St Mary’s bell in the Antwerp tower all belong to the town; the

rest are the property of the chapter. He who commanded the bell commanded the town; for by that sound, at a moment’s notice, he could rally and concentrate his adherents. Hence a conqueror commonly acknowledged the political importance of bells by melting them down; and the cannon of the conquered was in turn melted up to supply the garrison with bells to be used in the suppression of revolts. Many a bloody chapter in history has been rung in and out by bells.

On the third day of Easter 1282, at the ringing of the Sicilian vespers (which have given their name to the affair), 8000 French were massacred in cold blood by John of Procida, who had thus planned to free Sicily from Charles of Anjou. On the 24th of August, St Bartholomew’s day, 1571, bells ushered in the massacre of the Huguenots in France, to the number, it is said, of 100,000. Bells have rung alike over slaughtered and ransomed cities; and far and wide throughout Europe in the hour of victory or irreparable loss. At the news of Nelson’s triumph and death at Trafalgar, the bells of Chester rang a merry peal alternated with one deep toll, and similar incidents could be multiplied.

There are many old customs connected with the use of church bells, some of which have died out, while others remain here and there. The best known and perhaps oldest of these is the “Curfew” (*couvre-feu*), first enforced (though not perhaps introduced) by William the Conqueror in England as a signal for all lights and fires to be extinguished at 8 P.M.—probably to prevent nocturnal gatherings of disaffected subjects. In many towns it survived into the 19th century as a signal for closing shops at 8 or 9; and it is still kept up in various places as an old custom; thus at Oxford the familiar boom of “Tom’s” 101 strokes is still the signal for closing college gates at 9. The largest and heaviest bells were used for the Curfew, to carry the sound as far as possible, as it did to Milton’s ear, suggesting the descriptive lines in *Il Penseroso* (74-75):—

“ Oft, on a plot of rising ground,
I hear the far-off curfew sound
Over some wide-watered shore,
Swinging slew with sullen roar.”

Gray’s allusion in the *Elegy* is well known; as also are those of Shakespeare to the elves “that rejoice to hear the solemn curfew” (*Tempest*), or the fiend that “begins at curfew and walks till the first cock” (*King Lear*); or Milton’s in *Comus* to the ghost “that breaks his magic chains at curfew time.”

Among secular uses connected with church bells are the “Mote” or “Common” bell, summoning to municipal or other meetings, as e.g. the 7th at St Mary’s, Stamford, tolled for quarter sessions, or the bell at St Mary’s, Oxford, for meetings of Convocation. In some places one of the bells is known as the “Vestry Bell.” The “Pancake Bell,” still rung here and there on Shrove Tuesday, was originally a summons to confession before Lent; the “Harvest Bell” and “Seeding Bell” called labourers to their work; while the “Gleaning Bell” fixed the hours for beginning or leaving off gleaning, so that everyone might start fair and have an even chance. The “Oven Bell” gave notice when the lord of the manor’s oven was ready for his tenants to bake their bread; the “Market Bell” was a signal for selling to begin; and in some country districts a church bell is still rung at dinner time. The general diffusion of clocks and watches has rendered bells less necessary for marking the events of daily life; and most of these old customs have either disappeared or are fast disappearing. At Strassburg a large bell of eight tons weight, known as the “Holy Ghost Bell,” is only rung when two fires are seen in the town at once; a “storm-bell” warns travellers in the plain of storms approaching from the mountains, and the “Thor Glocke” (gate bell) gives the signal for opening or shutting the city gates. On the European continent, especially in countries which, like Belgium and Holland, were distracted by constant war, bells acquired great public importance. They were formally baptized with religious ceremonies (as also in England in pre-Reformation days), the notabilities of a town or church standing as sponsors; and they

were very generally supposed to have the power of scaring away evil spirits.

Other old customs are naturally connected with the ecclesiastical uses of bells. The "Passing Bell," rung for the dying, is now generally rung after death; the ancient mode of indicating the sex of the deceased, viz. two pulls for a woman and three for a man being still very common, with many varying customs as regards the interval after death or the bell to be used, e.g. smaller bells for children and females, and larger ones for aged men; the tenor bell being sometimes reserved for the death of the incumbent, or of a bishop or member of the royal family. "Burial Peals," once common at or after funerals to scare away the evil spirits from the soul of the departed, though discouraged by bishops as early as the 14th century, were kept alive by popular superstition, and only finally checked in Puritan times; but they have been revived, since the spread of change-ringing, in the "muffled peals" now frequently rung as a mark of respect to deceased persons of public or local importance, or the short "touches" on hand-bells sometimes rung at the grave by the comrades of a deceased ringer. The "Sermon-Bell," rung in pre-Reformation times to give notice that a sermon was to be preached (cf. Shakespeare, *Henry IV.*, Pt. II. iv. 2. 4-7), survives in some places in a custom of ringing the tenor bell before a service with a sermon; and a similar custom before a celebration of the Holy Communion preserves the memory of the "Sacrament Bell." The ancient "Sanctus" or "Sance" bell, hung on the rood-screen or in a small bell cot on the chancel gable, and sounded three times when the priest said the *Tersanctus* (Holy, Holy, Holy) in the office of mass, was specially obnoxious to Puritan zeal, and few of them survived the Reformation. An early morning bell, rung in many places for no apparent reason, is probably a relic of the *Ave Maria* or *Angelus* bell. The inscription on some old bells, *Lectum fuge, discute somnum* ("Away from bed, shake off sleep"), points to this use, as also does the name "Gabriel" applied to the bell used for ringing the Angelus. In old times bells were generally named at their baptism, after the Virgin Mary or saints, or their donors; thus the bells at Osney Abbey in the 13th century were called Hautclere, Doucement, Austyn, Marie, Gabriel and John; sometimes they were known by mere nicknames, such as "Great (or "Mighty") Tom" at Oxford, or "Big Ben," "Great Paul," &c., in recent times.

Bell Inscriptions.—The names of bells were often stamped upon them in the casting; whence arose inscriptions upon church bells, giving in monkish Latin the name of some saint, a prayer to the Virgin, or for the soul of the donor, or a distich upon the function of the bell itself; e.g.—

"Funera plango, fulgura frango, Sabbata pango,
Excito lentos, dissipio ventos, paco crucentos."

(I mourn for death, I break the lightning, I fix the Sabbath, I rouse the lazy, I scatter the winds, I appease the cruel.)

The character of the lettering and the foundry marks upon old bells, are of great assistance in determining their date. Sometimes a set of bells has each a separate verse, e.g. on a ring of five in Bedfordshire:—

1st. "Hoc signum Petri pulsatum nomine Christi."

(This emblem of Peter is struck in the name of Christ.)

2nd. "Nomen Magdalene campana sonat melode."

(This bell named Magdalen sounds melodiously.)

3rd. "Sit nomen Domini benedictum semper in eum."

(May the name of the Lord always be blessed upon him, i.e. on the bell when struck.)

4th. "Musa Raphaelis sonat auribus Immanuelis."

(The music of Raphael sounds in the ear of Immanuel.)

5th. "Sum Rosa pulsata mundique Maria vocata."

(I, Maria, am struck and called the Rose of the world.)

The names of these five bells were thus:—Peter, Magdalen, (? Jesus, Raphael and Mary.

Other inscriptions take the form of an invocation or prayer for the bell itself, its donor or those who hear it, e.g.—

"Augustine tuam campanam protege sanam."

(Augustine, protect thy bell and keep it sound.)

"Sancte Johannes, ora pro animabus Johannis Pudsey, militis, et Mariae, consortae suae."

(St John, pray for the souls of John Pudsey, knight, and Mary his wife.)

"Protege pura via quos convoco virgo Maria."

(Guard in the way those whom I pure Virgin Mary call.)

The "Mittags Glocke" (mid-day bell) at Strassburg, taken down at the time of the French Revolution, bore the legend:

"Vox ego sum vitae; voco vos; orate venite."

(I am the voice of life: I call you: come and pray.)

A bell in Rouen cathedral, melted down in 1793, was inscribed:

"Je suis George d'Ambois,

Qui trente cinque mille pois;

Mais lui qui me pesera

Trente six mille me trouvera."

(I am George d'Ambois, weighing 35,000 lb; but he who weighs me will find me 36,000.)

A similar inscription is said to have been cast on the largest of the bells placed by Edward III. in a "clocher" or bell hut in the Little Cloisters at Westminster:

"King Edward made mee thirty thousand weight and three,

Take mee down and wey mee and more you shall find mee."

On the "Thor Glocke" at Strassburg above mentioned are the words:—

"Dieses Thor Glocke das erst mal schallt

Als man 1618 sahit

Dass Igte jahr regnet man

Nach doctor Luther Jubal jahr

Das Bös hinaus das Gut hinein

Zu läuten soll igr arbeit seyn."

The reference is to the year 1517, when Luther began his crusade, and the verse may be Englished as follows:—

When first ringeth this Gate Bell

1618 years we tell.

We reckon this a year to be

From Dr Luther's jubilee.

To ring out ill, the good ring in,

Its daily task shall now begin.

Large Bells.—There are a few bells of world-wide renown, and several others more or less celebrated. The great bell at Moscow, "Tsar Kolokol," which, according to the inscription, was cast in 1733, was in the earth 103 years and was raised by the emperor Nicholas in 1836. The present bell seems never to have been actually hung or rung, having been cracked in the furnace; and it now stands on a raised platform in the middle of a square. It is used as a chapel. It weighs about 180 tons, height 19 ft. 3 in., circumference 60 ft. 9 in., thickness 2 ft., weight of broken piece 11 tons. The second Moscow bell, the largest in the world in actual use, weighs 128 tons. In a pagoda in Upper Burma hangs a bell 16 ft. in diameter, weighing about 80 tons. The great bell at Peking weighs 53 tons; Nanking, 22 tons; Olmutz, 17 tons; Vienna (1711), 17 tons; Notre Dame (1680), 17 tons; Erfurt, 13 tons; Great Peter, York Minster, recast in 1845, 12½ tons; Great Paul, at St Paul's cathedral, 16½ tons; Great Tom at Oxford, 7½ tons; Great Tom at Lincoln, 5½ tons. Big Ben of the Westminster Clock Tower weighs 13½ tons; it was cast by George Mears under the direction of the first Lord Grimthorpe (E. Beckett Denison) in 1858. Its four quarters were cast by Warner in 1875, with metal from French cannon captured in 1870-1871, weighs 27½ tons.

These large bells are either not moved at all, or only slightly swung to enable the clapper to touch their side; in some cases they are struck by a hammer or beam from outside. The heaviest ringing peals in England are those at Exeter and St Paul's cathedrals, tenors 72 cwt. and 62 cwt. respectively.

Bell-ringing.—The science and art of bell-ringing, as practised upon church and tower bells, falls under two main heads:—(1) Mechanical ringing, in connexion with the machinery of a clock or "carillon"; (2) Ringing by hand, by means of ropes attached to the fittings of the bells, whereby the bell itself is either moved as it hangs mouth downwards sufficiently for the clapper just to touch its side (called technically "chiming"); or is swung round nearly full circle with its mouth uppermost (technically

"ringing"), in which case the impact of the clapper is much heavier, and the sound produced is consequently louder and more far-reaching. Mechanical ringing is more common on the continent of Europe, especially in Belgium and Flanders; ringing by hand is more common in England, where the development of change-ringing (see below) has brought it into prominence.

(1) Mechanical ringing is effected by a system of wires connected with small hammers striking the bells, usually on their outside, and worked either by connexion with the machinery of a clock, so as to play tunes or artificially arranged chimes at definite intervals; or with a key-board resembling that of an organ. The first of these methods is familiar in the chimes (Cambridge, Westminster, &c.) heard from many towers at the striking of the hours and quarters; or in hymn tunes played at intervals (e.g. of three hours) upon the church bells. The second method is peculiar to the "carillon" (*q.v.*), as found everywhere in Belgium, where with a set of from 20 or 30 to 60 or 70 bells a much wider scope for tunes and harmonies is provided than in English bells, few of which have more than one octave of bells in one key only and none more than 12 bells. The carillons at Louvain and Bruges contain 40 bells, and that of Mechlin 44, while in the tower of Antwerp cathedral there are upwards of 90 bells, for the largest of which, cast in 1507, Charles V. stood sponsor at its consecration.

(2) *Ringling by Hand*.—Church bells may be "chimed" or "rung" (see above). One man can, as a rule, chime three bells, with a rope in each hand and one foot in the loop of another; but by the use of an "Ellacombe" or other chiming apparatus one man can work six, eight or ten bells. Some prefer the quieter sound of chiming as an introduction to divine service, but where a band of ringers is available and change-ringing is practised the bells as a rule are rung. The practice of "clocking" a bell, in which the clapper, by means of a cord attached to it and pulled from below, is allowed to swing against the bell at rest, is often employed to save trouble; but the jar is very likely to crack the bell. In ringing, or in true chiming, the bell is in motion when struck.

For ringing, a bell is pulled up and "set" mouth uppermost. She (to ringers a bell is feminine) is then pulled off, first at "handstroke" (*i.e.* with the hands on the "sally" or tufted portion of the rope, a few feet from its lower end) and then at "back-stroke" in the reverse direction (with the hands nearer the lower end, the rope having at the previous pull coiled round three-quarters of the wheel's circumference), describing at each pull almost a full circle till she comes back to the upright position. At each revolution the swing is chiefly done by the weight of the bell, the ringer giving a pull of just sufficient strength to bring the bell back into the upright position; otherwise its swing would become gradually shorter till it remained at rest mouth downwards.

Change-ringing.—When a given number of bells are rung over and over again in the same order, from the highest note, or "treble," to the lowest, or "tenor"—1, 2, 3, 4, 5, 6, 7—they are said to be rung in "rounds." "Changes" are variations of this order—e.g. 2 1 3 5 4 7 6, 2 3 1 4 5 6 7; and "change-ringing" is the art of ringing bells in "changes," so that a different "change" or rearrangement of order is produced at each pull of the bell-ropes, until, without any repetition of the same change, the bells come back into "rounds." The general principle of all methods of change-ringing is that each bell, after striking in the first place or "lead," works gradually "up" to the last place or "behind," and "down" again to the first, and that no bell ever shifts more than one place in each change. Thus the ringer of any bell knows that whatever his position in one change, his place in the next will be either the same, or the place before or the place after. He does not have to learn by heart the different changes or variations of order; nor need he, unless he is the "conductor," know the exact order of any one change. He has to bear in mind, first, which way his bell is working, viz. whether "up" from first to last place, or "down" from last to first; secondly, in what place his bell is striking; thirdly, what bell or bells are striking immediately before or

after him—this being ascertained chiefly by "rope-sight," *i.e.* the knack, acquired by practice, of seeing which rope is being pulled immediately before and after his own. He must also remember and apply the rules of the particular "method" which is being rung. The following table representing the first twenty changes of a "plain course" of "Grandshire Triples" (for these terms, see below) illustrates the subject-matter of this section:—

1 2 3 4 5 6 7	"Rounds."	7 5 6 1 4 2 3	(10th change.)
2 1 3 5 4 7 6	(1st change.)	5 7 1 6 2 4 3	
2 3 1 4 5 6 7		5 1 7 2 6 4 3	
3 2 4 1 6 5 7		1 5 2 7 3 6 4	
3 4 2 6 1 7 5		1 2 5 3 7 6 4	
4 3 6 2 7 1 5	(5th change.)	2 1 5 7 3 6 4	(15th change.)
4 6 3 7 2 5 1		2 5 1 3 7 6 4	
6 4 7 3 5 2 1		5 2 3 1 4 7 6	
6 7 4 5 3 1 2		5 3 2 4 1 6 7	
7 6 5 4 1 3 2		3 5 4 2 6 1 7	
		3 4 5 6 2 7 1	(20th change.)

It will be observed that at the 1st change the third bell and at the 15th the fifth bell, according to the rule of this "method," strikes a second blow in the third place ("makes third's place"). This stops the regular work of the bells which at the previous change were in the 4th, 5th, 6th and 7th places ("in 4, 5, 6, 7"), causing them to take a step backwards in their course "up" or "down," or as it is technically called, to "dodge." Were it not for this, the bells would come back into "rounds" at the 14th change. It is by the use of "place-making" and "dodging," according to the rules of various "methods," that the required number of changes, upon any number of bells, can be produced. But in order that this may be done, without the bells coming back into "rounds" (as, e.g. in the "plain course" of Grandshire Triples, above given, they will do in seventy changes), further modifications of the "coursing order," called technically "Bobs" and "Singles," must be introduced. In ringing, notice of these alterations as they occur is given by one of the ringers, who acts as "conductor," calling out "Bob" or "Single" at the right moment to warn the ringers of certain bells to make the requisite alteration in the regular work of their bells. (Hence, in ringing language, to "call" a peal or touch = to conduct it.) Particulars of these, as of other details of change-ringing, may be gathered from books dealing with the technique of the art; but they are best mastered in actual practice. The term "single," applied to five-bell ringing meant that, as the first three bells remained unchanged, only a single pair of bells changed places, e.g. 1 5 4 3 2, 1 5 4 2 3. On larger numbers of bells it loses this meaning; but the effect of this "call" is that the "coursing order" of a single pair of bells is inverted. The origin of "Bob" is unknown. As a "call" it was perhaps adopted as a short, sharp sound, easily uttered and easily heard by the ringers. As applied to a "method" or system of ringing it may refer to the evolution of "dodging," e.g. in "Treble Bob" to the zigzag "dodging" path of the treble bell; but none of the old writers attempts to explain it.

The number of possible "changes" on any given series of bells may be ascertained, according to the mathematical formula of "permutations," by multiplying the number of the bells together. Thus on three bells, only 6 changes or variations of order ($1 \times 2 \times 3$) can be produced; on four bells, $1 \times 2 \times 3 \times 4 = 24$; on five, $24 \times 5 = 120$; on six, $120 \times 6 = 720$; on seven, $720 \times 7 = 5040$. A "peal" on any such number of bells is in ordinary language the ringing of all the possible changes. But technically, only the full extent of changes upon seven bells, usually rung with a "tenor behind," is called a "peal"; a shorter performance upon seven or more bells, or the full extent upon less than seven, being, in ringing parlance, a "touch." On six bells the full extent of changes must be repeated continuously seven times ($720 \times 7 = 5040$), and on five bells forty-two times ($120 \times 42 = 5040$) to rank as a "peal." On eight or more bells 5000 changes in round numbers is accepted as the *minimum* standard for a peal; and on such numbers of bells up to twelve (the largest number used in change-ringing), peals are so arranged that the bells come into rounds at, or at some point beyond,

5000 changes. As many as 16,000 changes, occupying from nine to ten hours, have been rung upon church bells. But the great physical strain upon the ringers—to say nothing of the effect upon those who are within hearing—makes such performances exceptional. The word "peal" is often, though incorrectly, used (1) for a set of church bells ("a peal of six," "a peal of eight"), for which the correct term is "a ring" of bells; (2) for any shorter performance than a full peal (e.g. "wedding-peal," "muffled peal," &c.), called in ringing language a "touch." Its use as equivalent for "method," found in old campanological works, is now obsolete.

Change-ringing upon five bells is called "Doubles," upon seven bells "Triples," upon nine "Caters" (Fr. *quatre*), and upon eleven "Cinques," from the fact that at each change two, three, four or five pairs of bells change places with each other. "Doubles" can be and are rung when there are only five bells; but as a rule these "odd-bell" systems are rung with a "tenor behind," i.e. struck at the end of each change; the number of bells in a tower being usually an even number—six, eight, ten or twelve. In "even-bell" systems the tenor is "rung in" or "turned in," i.e. changes with the other bells, and a different terminology is employed; change-ringing on six bells being called "Minor"; on eight bells, "Major"; on ten bells, "Royal"; and on twelve, "Maximus." The principal "methods" of change-ringing, each of which has its special rules, are—(1) "Grandsire"; (2) "Plain Bob"; (3) "Treble Bob"; (4) "Stedman," from the name of its inventor, Fabian Stedman, about 1670. In "Grandsire" the treble and one other bell, in "Plain Bob" the treble alone, has a "plain hunt," i.e. works from the first place, or "lead," to the last place, or "behind," and back again, without any dodging; in "Treble Bob" the treble has a uniform but zigzag course, dodging in each place on its way up and down. This is called a "Treble Bob hunt"; and under these two heads, according to the work of the treble, are classified a variety of "plain methods" and "Treble Bob methods," among the latter being the so-called "Surprise" methods, the most complicated and difficult of all. "Stedman's principle," which is *sui generis*, consists in the three front bells ringing their six possible changes, while the remaining pair or pairs of bells dodge. It is thus an "odd-bell" method adapted to five, seven, nine or eleven bells; as also is "Grandsire," though occasionally rung on even numbers of bells. "Treble Bob" is always, and "Plain Bob" generally, rung on even numbers—six, eight, ten or twelve. In ringing, whenever the treble has a uniform course, unaffected by "Bobs" or "Singles," it serves as a guide to the other changing bells, according to the place in which they meet and cross its path from "behind" to the "lead." The order in which the different dodges occur, and the "course bell," i.e. the bell which he follows from behind to lead, are also useful, and on large numbers of bells indispensable, guides to the ringers.

Quite distinct from the art of change-ringing is the science of "composing," i.e. arranging and uniting by the proper "calls," subject to certain fixed laws and conditions, a number of groups of changes, so that no one change, or series of changes represented in those groups, shall be repeated. A composition, long or short, is said to be "true" if it is free from, "false" if it involves, such repetition; and the body of ascertained laws and conditions governing true composition in any method constitutes the test or "proof" to be applied to a composition in that method to demonstrate its truth or falseness. Many practical ringers know little or nothing of the principles of composition, and are content with performing compositions received from composers, or published in ringing books and periodicals. An elaborate statement of the principles of composition in the "Grandsire" method may be found in an appendix to Snowdon's *Grandsire* (1888), by the Rev. C. D. P. Davies. Those which apply to "Treble Bob" are explained in Snowdon's *Treatise on Treble Bob*, Part I. But, so far as can be ascertained, there is no treatise dealing with the science of composition as a whole; nor is it possible here to attempt a popular exposition of its principles.

One of the objects kept in view by composers is musical

effect. Certain sequences or contrasts of notes strike the ear as more musical than others; and an arrangement which brings up the more musical changes in quicker succession improves the musical effect of the "peal" or "touch." On seven bells all the possible changes must be inserted in a true peal; but on larger numbers of bells, where the choice is from an immense number of possible changes, the composer is free to select those which are most musical. Unless, however, the bells of any given "ring" are in perfect tune and harmony with each other, their musical effect must be impaired, however well they are rung. This gives importance to the science and art of bell-tuning, in which great progress has been made (see above).

The art of scientific change-ringing, peculiar to England, does not seem to have been evolved before the middle of the 17th century. Societies or guilds of ringers, however, existed much earlier. A patent roll of 39 Henry III. (1255) confirms the "Brethren of the Guild of Westminster, who are appointed to ring the great bells there," in the enjoyment of the "privileges and free customs which they have enjoyed from the time of Edward the Confessor." In 1602 (as appears from a MS. in the library of All Souls' College, Oxford) was founded a society called the "Scholars of Cheapside." In 1637 began the "Ancient Society of College Youths," so called from their meeting to practise on the six bells at St Martin's, College Hill, a church destroyed in the Great Fire of London, 1666. At first only "rounds" and "call-changes" were rung, till about 1642, when 120 "Bob Doubles" were achieved; but slow progress was made till 1677, when Fabian Stedman of Cambridge published his *Campanologia*, dedicating it to this society, his method being first rung about this time by some of its members. Before the end of the 17th century was founded the "Society of London Scholars," the name of which was changed in 1746 to "Cumberland Youths" in compliment to the victor of Culloden. These two metropolitan societies still exist, and include in their membership most of the leading change-ringers of England: one of the oldest provincial societies being that of Saffron Walden in Essex, founded in 1623, and still holding an annual ringing festival. In the latter half of the 18th and first half of the 19th century change-ringing, which at first seems to have been an aristocratic pastime, degenerated in social repute. Church bells and their ringers, neglected by church authorities, became associated with the lower and least reputable phases of parochial life; and bellfries were too often an adjunct to the pothouse. In the last half of the 19th century there was a great revival of change-ringing, leading to improvements in bellfries and in ringers, and to their gradual recognition as church workers. Diocesan or county associations for the promotion of change-ringing and of bellfry reform spread knowledge of the art and aroused church officials to greater interest in and care for their bells. A Central Council of Church Bell Ringers, consisting of delegates from these various societies, meets annually in London or at some provincial centre to discuss ringing matters, and to collect and formulate useful knowledge upon practical questions—e.g. the proper care of bells and the means of preventing annoyance from their use in the neighbourhood of houses, rules for the conduct of bellfries, &c. It is now less likely than ever that the Belgian carillons will be preferred in England to the peculiarly English system of ringing bells in peal; by which, whatever its difficulties, the musical sound of bells is most fully brought out, and their scientific construction best stimulated.

AUTHORITIES.—The literature of bell-tore (or campanology) consists chiefly of scattered treatises or pamphlets upon the technique of different methods of change-ringing, or upon the bells of particular counties or districts. The earliest that deal with the science and art of change-ringing are *Campanologia or the Art of Ringing Improved* (1677), and a chapter of "Advice to a Ringer" in the *School of Recreations, or Gentleman's Tutor* (1684), showing that in its early days bell-ringing was a fashionable pastime. Then follow *Campanologia, or the Art of Ringing made Easy* (1766), *Clavis Campanologia, a Key to Ringing* (1788), and *Shipway's Campanologia* (1816). The revival of change-ringing in recent years has produced many manuals: e.g. *Snowdon's Rope-Sight* (explaining the "Plain Bob" method), *Grandsire, Treatise on Treble Bob, Double Norwich Court Bob Major, and Standard Methods* (with a book of diagrams);

trouze on *Change-Ringing: The Duffield Method*, by Sir A. P. Heywood, Bart., its inventor. Somewhat prior to these are various works by the Rev. H. T. Ellacombe, inventor of a chiming apparatus which bears his name, and a pioneer in bellfry reform. Among these are accounts of the church bells of Devon, Somerset and Gloucester, and pamphlets on *Belfries and Ringers, Chiming, &c.*; much of their contents being summarized in *The Ringer's Guide to the Church Bells of Devon*, by C. Pearson (1888). A *Glossary of Technical Terms used in connexion with church bells and change-ringing* was published (1901) under the auspices of the Central Council of Church Bell Ringers. On the history of church bells and customs connected with them much curious information is given in North's *English Bells and Bell Lore* (1888). By the same author are monographs on the church bells of Leicestershire, Northamptonshire, Lincolnshire and Hertfordshire. There are similar works on the church bells of Suffolk and Cambridgeshire, by Dr Raven; of Huntingdonshire, by the Rev. T. M. N. Owen; and on the church bells of Essex, by the Rev. C. Deedes. A compilation and summary of many data of bell-lore will be found in *A Book about Bells*, by the Rev. G. S. Tyack; and in a volume by Dr Raven in the "Antiquary's Books" series (Methuen, 1906), entitled *The Bells of England*, which deals with the antiquarian side of bell-lore. See also *Quarterly Review*, No. LXC (September 1854); *Windsor Magazine* (December 1896); and Lord Rayleigh's paper "On the Tones of Bells" in the *Phil. Mag.* for January 1890; and a series of articles from the *Guardian*, reprinted as a pamphlet under the title, *Church Bells and Bell-ringing*.

(T. L. P.)

House Bells.—Buildings are commonly provided with bells, conveniently arranged so as to enable attendants to be summoned to the different rooms. In the old system, which has been largely superseded by pneumatic and still more by electric bells, the bells themselves are of the ordinary conical shape and are provided with clappers hung loosely inside them. Being supported on springs they continue to swing, and therefore to give out sound as the clapper knocks against the sides, for some time after they have been set in motion by means of the strings or wires by which each is connected to a bell-pull in the rooms. These wires are generally placed out of sight inside the walls, and bell-cranks are employed to take them round corners and to change the direction of motion as required. A lightly poised pendulum is often attached to each bell, to show by its motion when it has been rung. In pneumatic bells the wires are replaced by pipes of narrow bore, and the current of air which is caused to flow along these by the pressing of a push-button actuates a small hammer which impinges rapidly against a bell or gong. An electric bell consists of a small electro-magnet acting on a soft iron armature which is supported in such a way that normally it stands away from the magnet. When the latter is energized by the passage of an electric current, the armature is attracted towards it, and a small hammer attached to it strikes a blow on the bell or gong. This "single stroke" type of bell is largely used in railway signalling instruments. For domestic purposes, however, the bells are arranged so that the hammer strikes a series of strokes, continuing so long as the push-button which closes the electric circuit is pressed. A light spring is provided against which the armature rests when it is not attracted by the electro-magnet, and the current is arranged to pass through this spring and the armature on its way to the magnet. When the armature is attracted by the magnet it breaks contact with this spring, the current is interrupted, and the magnet being no longer energized allows the armature to fall back on the spring and thus restore the circuit. In this way a rapid to and fro motion is imparted to the hammer. The electric current is supplied by a battery, usually either of Leclanché or of dry cells. One bell will serve for all the rooms of a house, an "indicator" being provided to show from which it has been rung. Such indicators are of two main types: the current either sets in motion a pendulum, or causes a disk bearing the name or number of the room concerned to come into view. Each push must have one wire appropriated to itself leading from the battery through the indicator to the bell, but the return wire from the bell to the battery may be common to all the pushes. Bells of this kind cease to ring whenever the electrical continuity of any of these wires is interrupted, but in some cases, as in connexion with burglar-alarms, it is desirable that the bell, once set in action, shall continue to ring even though the wires are cut. For this purpose, in "continuous ringing" bells, the current,

started by the push or alarm apparatus, instead of working the bell, is made to operate a relay-switch and thus to bring into circuit a second battery which continues to ring the bell, no matter what happens to the first circuit. (H. M. K.)

BELLABELLA, the common name (popularized from the Indian corruption of Milbank) for a tribe of Kwakiutl Indians at Milbank, British Columbia, including the subtribes Kokaikait, Oetlik and Oealitik. They were converted to Christianity by Protestant missionaries, and number about 300.

BELLACOLA or **BILQUA**, a tribe of North American Indians of Salishan stock, inhabiting the coast of British Columbia. They number some 300.

BELLADONNA (from the Ital. *bella donna*, "beautiful lady," the berries having been used as a cosmetic), the roots and leaves of *Atropa belladonna*, or deadly nightshade (*g.s.*), widely used in medicine on account of the alkaloids which they contain. Of these the more important are atropine (or atropia), hyoscyamine, hyoscyne and belladonnine; atropine is the most important, occurring as the malate to the extent of about 0.47% in the leaves, and from 0.6 to 0.25% in the roots.

Atropine, $C_{17}H_{23}NO_3$, was discovered in 1833 by P. L. Geiger and Hesse and by Mein in the tissues of *Atropa belladonna*, from which it may be extracted by means of chloroform. By crystallization from alcohol it is obtained as colourless needles, melting at 115° . Hydrolysis with hydrochloric acid or baryta water gives tropic acid and tropine; on the other hand, by boiling equimolecular quantities of these substances with dilute hydrochloric acid, atropine is reformed. Since both these substances have been synthesized (see TROPINE), the artificial formation of atropine is accomplished. Atropine is optically inactive; hyoscyamine, possibly a physical isomer, which yields tropine when heated to 108.6° , is laevorotatory.

Medicine.—The official doses of atropine are from $\frac{1}{100}$ to $\frac{1}{50}$ grain, and the sulphate, which is in general use in medicine, has a similar dose. It is highly important to observe that the official doses of the various pharmacopœias may with safety be greatly exceeded in practice. They are based on the experimental toxic, as distinguished from lethal dose. A toxic dose causes unpleasant symptoms, but in certain cases, such as this, it may require very many times a toxic dose to produce the lethal effect. In other words, whilst one-fiftieth of a grain may cause unpleasant symptoms, it may need more than a grain to kill. So valuable are certain of the properties of atropine that it is often desirable to give doses of one-twentieth or one-tenth of a grain; but these will never be ventured upon by the practitioner who is ignorant of the great interval between the minimum toxic and the minimum lethal dose. It actually needs twenty to thirty grains of atropine to kill a rabbit; the animal is, however, somewhat exceptional in this regard. The most valuable preparations of this potent drug are the *liquor atropinae sulphatis*, which is a 1% solution, and the *lamella*—for insertion within the conjunctival sac—which contains one five-thousandth part of a grain of the alkaloid.

Pharmacology.—When rubbed into the skin with such substances as alcohol or glycerine, which are absorbed, atropine is carried through the epidermis with them, and in this manner—or when simply applied to a raw surface—it paralyzes the terminals of the pain-conducting sensory nerves. It acts similarly, though less markedly, upon the nerves which determine the secretion of the perspiration, and is therefore a local anæsthetic or anodyne and an anhidrotic. Being rapidly absorbed into the blood, it exercises a long and highly important series of actions on nearly every part and function of the nervous system. Perhaps its most remarkable action is that upon the terminals of nearly all the secretory nerves in the body. This causes the entire skin to become dry—as in the case of the local action above mentioned; and it arrests the secretion of saliva and mucus in the mouth and throat, causing these parts to become very dry and to feel very uncomfortable. This latter result is due to paralysis of the *chorda tympani* nerve, which is mainly responsible for the salivary secretion. Certain nerve fibres from the sympathetic nervous system, which can also cause the secretion of a

(specially viscous) saliva, are entirely unaffected by atropine. A curious parallel to this occurs in its action on the eye. There is much uncertainty as to the influence of atropine on the secretions of the stomach, intestines, liver, pancreas and kidneys, and it is not possible to make any definite statement, save that in all probability the activities of the nerves innervating the gland-cells in these organs are reduced, though they are certainly not arrested, as in the other cases. The secretion of mucus by the bronchi and trachea is greatly reduced and their muscular tissue is paralysed—a fact of which much use is made in practical medicine. The secretion of milk, if occurring in the mammary gland, is much diminished or entirely arrested. Given internally, atropine does not exert any appreciable sedative action upon the nerves of pain.

The action of atropine on the motor nerves is equally important. Those that go to the voluntary muscles are depressed only by very large and dangerous doses. The drug appears to have no influence upon the contractile cells that constitute muscle-fibre, any more than it has directly upon the secretory cells that constitute any gland. But moderate doses of atropine markedly paralyse the terminals of the nerves that go to involuntary muscles, whether the action of those nerves be motor or inhibitory. In the intestine, for instance, are layers of muscle-fibre which are constantly being inhibited or kept under check by the splanchnic nerves. These are paralysed by atropine, and intestinal peristalsis is consequently made more active, the muscles being released from nervous control. The motor nerves of the arteries, of the bladder and rectal sphincters, and also of the bronchi, are paralysed by atropine, but the nervous arrangements of those organs are highly complex and until they are further unravelled by physiologists, pharmacology will be unable to give much information which might be of great value in the employment of atropine. The action upon the vaso-motor system is, however, fairly clear. Whether effected entirely by action on the nerve terminals, or by an additional influence upon the vaso-motor centre in the medulla oblongata, atropine certainly causes extreme dilatation of the blood-vessels, so much so that the skin becomes flushed and there may appear, after large doses, an erythematous rash, which must be carefully distinguished, in cases of supposed belladonna poisoning, from that of scarlet fever: more especially as the temperature may be elevated and the pulse is very rapid in both conditions. But whilst the characteristic action of atropine is to dilate the blood-vessels, its first action is to stimulate the vaso-motor centre—thereby causing temporary contraction of the vessels—and to increase the rapidity of the heart's action, so that the blood-pressure rapidly rises. Though transient, this action is so certain, marked and rapid, as to make the subcutaneous injection of atropine invaluable in certain conditions. The respiratory centre is similarly stimulated, so that atropine must be regarded as a temporary but efficient respiratory and cardiac stimulant.

Toxic doses of atropine—and therefore of belladonna—raise the temperature several degrees. The action is probably nervous, but in the present state of our knowledge regarding the control of the temperature by the nervous system, it cannot be further defined. In small therapeutic and in small toxic doses atropine stimulates the motor apparatus of the spinal cord, just as it stimulates the centres in the medulla oblongata. This is indeed, as Sir Thomas Fraser has pointed out, "a strychnine action." In large toxic and in lethal doses the activity of the spinal cord is lowered.

No less important than any of the above is the action of atropine on the cerebrum. This has long been a debated matter, but it may now be stated, with considerable certainty, that the higher centres are inordinately stimulated, a state closely resembling that of delirium tremens being induced. In cases of poisoning the delirium may last for many hours or even days. Thereafter a more or less sleepy state supervenes, but it is not the case that atropine ever causes genuine coma. The stuporose condition is the result of exhaustion after the long period of cerebral excitement. It is to be noted that children, who are particularly susceptible to the influence of certain of the other

potent alkaloids, such as morphine and strychnine, will take relatively large doses of atropine without ill-effect.

The action of atropine on the eye is of high theoretical and practical importance. The drug affects only the involuntary muscles of the eye, just as it affects only the involuntary or non-striated portion of the oesophagus. The result of its instillation into the eye—and the same occurs when the atropine has been absorbed elsewhere—is rapidly to cause wide dilatation of the pupil. This can be experimentally shown—by the method of exclusion—to be caused by a paralysis of the terminals of the third cranial nerve in the *sphincter pupillae* of the iris. The action of atropine in dilating the pupil is also aided by a stimulation of the fibres from the sympathetic nervous system, which innervate the remaining muscle of the iris—the *dilatator pupillae*. As a result of the extreme pupillary dilatation, the tension of the eyeball is greatly raised. The sight of many an eye has been destroyed by the use of atropine—in ignorance of this action on the intra-ocular tension—in cases of incipient glaucoma. The use of atropine is absolutely contra-indicated in any case where the intra-ocular tension already is, or threatens to become, unduly high. This warning applies notably to those—usually women—who are accustomed indiscriminately to use belladonna or atropine in order to give greater brilliancy to their eyes. The fourth ocular result of administering atropine is the production of a slight but definite degree of local anaesthesia of the eyeball. It follows from the above that a patient who is definitely under the influence of atropine will display rapid pulse, dilated pupils, a dry skin and a sense of discomfort, due to dryness of the mouth and throat.

Therapeutics.—The external uses of the drug are mainly analgesic. The liniment or plaster of belladonna will relieve many forms of local pain. Generally speaking, it may be laid down that atropine is more likely than iodine to relieve a pain of quite superficial origin; and conversely. Totally to be reprobated is the use, in order to relieve pain, of belladonna or any other application which affects the skin, in cases where the surgeon may later be required to operate. In such cases, it is necessary to use such anodyne measures as will not interfere with the subsequent demands that may be made of the skin, *i.e.* that it be aseptic and in a condition so sound that it is able to undertake the process of healing itself after the operation has been performed. Atropine is universally and constantly used in ophthalmic practice in order to dilate the pupil for examination of the retina by the ophthalmoscope, or in cases where the inflamed iris threatens to form adhesions to neighbouring parts. The drug is often replaced in ophthalmology by homatropine—an alkaloid prepared from tropine—which acts similarly to atropine but has the advantage of allowing the ocular changes to pass away in a much shorter time. The anhidrotic action of atropine is largely employed in controlling the night-sweats so characteristic of pulmonary tuberculosis, small doses of the solution of the sulphate being given at night.

The uses of atropine in cardiac affections are still obscure and dubious. It can only be laid down that the drug is a valuable though temporary stimulant in emergencies, and that its use as a plaster or internally often relieves cardiac pain. Recollection of the extraordinary complexity of the problems which are involved in the whole question of pain of cardiac origin will emphasize the extreme vagueness of the above assertion. Professor Schäfer recommended the use of atropine prior to the administration of a general anaesthetic, in cases where the action of the vagus nerve upon the heart is to be dreaded; and there is little doubt of the value of this precaution, which has no attendant disadvantages, in all such cases. Atropine is often of value as an antidote, as in poisoning by pilocarpine, muscarine (mushroom poisoning), prussic acid, &c.

Omitting numerous minor applications of this drug, we may pass to two therapeutic uses which are of unquestionable utility. In cases of whooping-cough or any other condition in which there is spasmodic action of the muscular fibre in the bronchi—a definition which includes nearly every form of asthma and many cases of bronchitis—atropine is an almost invaluable

drug. Not only does it relieve the spasm, but it lessens the amount of secretion—often dangerously excessive—which is often associated with it. The relief of symptoms in whooping-cough is sharply to be distinguished from any influence on the course of the disease, since the drug does not abbreviate its duration by a single day. In treating an actual and present attack of asthma, it is advisable to give the standardized tincture of belladonna—unless expense is no consideration, in which case atropine may itself be used—in doses of twenty minims every quarter of an hour as long as no evil effects appear. Relief is thereby constantly obtained. Smaller doses of the drug should be given three times a day between the attacks.

The nocturnal enuresis or urinary incontinence of children and of adults is frequently relieved by this drug. The excellent toleration of atropine displayed by children must be remembered, and if its use is "pushed" a cure may almost always be expected.

Toxicology.—The symptoms of poisoning by belladonna or atropine are dealt with above. The essential point here to be added is that death takes place from combined cardiac and respiratory failure. This fact is, of course, the key to treatment. This consists in the use of emetics or the stomach-pump, with lime-water, which decomposes the alkaloid. These measures are, however, usually rendered nugatory by the very rapid absorption of the alkaloid. Death is to be averted by such measures as will keep the heart and lungs in action until the drug has been excreted by the kidneys. Inject stimulants subcutaneously; give coffee—hot and strong—by the mouth and rectum, or use large doses of caffeine citrate; and employ artificial respiration. Do not employ such physiological antagonists as pilocarpine or morphine, for the lethal actions of all these drugs exhibit not mutual antagonism but coincidence.

BELLAGIO, a town of Lombardy, Italy, in the province of Como, about 15 m. N.N.E. by steamer from the town of Como, situated on the promontory which divides the two southern arms of the Lake of Como. Pop. (1901) 3536. It is chiefly remarkable for the beauty of its scenery, and is a very favourite resort in the spring and autumn. Some of the gardens of its villas are remarkably fine. The manufacture of silks and carving in olive wood are carried on.

BELLAIRE, a city of Belmont county, Ohio, U.S.A., on the Ohio river, 5 m. S. of Wheeling, West Virginia. Pop. (1890) 9934; (1900) 9912 (1150 foreign-born); (1910) 12,946. It is served by the Baltimore & Ohio, the Pennsylvania, and the Ohio River & Western railways. Bellaire is the shipping centre of the Belmont county coalfield which in 1907 produced 19.3% of the total output of coal for the state. Iron, limestone and fire-clay are found in the vicinity; among the manufactures are iron and steel, glass, galvanized and enamelled ware, agricultural implements and stoves. The value of the city's factory products increased from \$8,837,646 in 1900 to \$10,712,438 in 1905, or 21.2%. Bellaire was settled about 1795, was laid out in 1836, was incorporated as a village in 1858, and was chartered as a city in 1874.

BELLAMY, EDWARD (1850–1898), American author and social reformer, was born at Chicopee Falls, Massachusetts, on the 25th of March 1850. He studied for a time at Union College, Schenectady, New York, and in Germany; was admitted to the bar in 1871; but soon engaged in newspaper work, first as an associate editor of the *Springfield Union*, Mass., and then as an editorial writer for the *New York Evening Post*. After publishing three novelettes (*Six to One*, *Dr Heidenhoff's Process* and *Miss Ludington's Sister*), pleasantly written and showing some inventiveness in situation, but attracting no special notice, in 1888 he caught the public attention with *Looking Backward, 2000–1887*, in which he set forth ideas of co-operative or semi-socialistic life in village or city communities. The book was widely circulated in America and Europe, and was translated into several foreign languages. It was at first judged merely as a romance, but was soon accepted as a statement of the deliberate wishes and methods of its author, who devoted the remainder of his life as editor, author, lecturer and politician, to the pro-

motion of the communistic theories of *Looking Backward*, which he called "nationalism"; a Nationalist party (the main points of whose immediate programme, according to Bellamy, were embodied in the platform of the People's party of 1892) was organized, but obtained no political hold. In 1897 Bellamy published *Equality*, a sequel to *Looking Backward*. He died at Chicopee Falls on the 22nd of May 1898.

BELLAMY, GEORGE ANNE (1727–1788), English actress, born at Fingal, Ireland, by her own account, on the 23rd of April 1733, but more probably in 1727, was the illegitimate daughter of Lord Tyrawley, British ambassador at Lisbon. Her mother married there a Captain Bellamy, and the child received the name George Anne, by mistake for Georgiana. Lord Tyrawley acknowledged the child, had her educated in a convent in Boulogne, and through him she came to know a number of notable people in London. On his appointment as ambassador to Russia, she went to live with her mother in London, made the acquaintance of Mrs Woffington and Garrick, and adopted the theatrical profession. Her first engagement was at Covent Garden as Monimia in the *Orphan* in 1744. Owing to her personal charms and the social patronage extended to her, her success was immediate, and till 1770 she acted in London, Edinburgh and Dublin, in all the principal tragic rôles. She played Juliet to Garrick's Romeo at Drury Lane at the time that Spranger Barry (*q.v.*) was giving the rival performances at Covent Garden, and was considered the better of the Juliets. Her last years were unhappy, and passed in poverty and ill-health. She died on the 16th of February 1788.

Her *Apology* (6 vols., 1785) gives an account of her long career and of her private life, the extravagance and licence of which were notorious.

BELLAMY, JOSEPH (1710–1790), American theologian, was born in Cheshire, Connecticut, on the 20th of February 1719. He graduated from Yale in 1735, studied theology for a time under Jonathan Edwards, was licensed to preach when scarcely eighteen years old, and from 1740 until his death, on the 6th of March 1790, was pastor of the Congregational church at Bethlehem, Connecticut. The publication of his best-known work, *True Religion Delineated* (1750), won for him a high reputation as a theologian, and the book was several times reprinted both in England and in America. Despite the fact that with the exception of the period of the "Great Awakening" (1740–1742), when he preached as an itinerant in several neighbouring colonies, his active labours were confined to his own parish, his influence on the religious thought of his time in America was probably surpassed only by that of his old friend and teacher Jonathan Edwards. This influence was due not only to his publications, but also to the "school" or classes for the training of clergymen which he conducted for many years at his home and from which went forth scores of preachers to every part of New England and the middle colonies (states). Bellamy's "system" of divinity was in general similar to that of Edwards. During the War of Independence he was loyal to the American cause. The university of Aberdeen conferred upon him the honorary degree of D.D. in 1768. He was a powerful and dramatic preacher. His published works, in addition to that above mentioned, include *The Wisdom of God in the Permission of Sin* (1758), his most characteristic work; *Theron, Paulinus and Aspasio; or Letters and Dialogues upon the Nature of Love to God, Faith in Christ, and Assurance of a Title to Eternal Life* (1759); *The Nature and Glory of the Gospel* (1762); *A Blow at the Root of Antinomianism* (1763); *There is but One Covenant* (1769); *Four Dialogues on the Half-Way Covenant* (1769); and *A Careful and Strict Examination of the External Covenant* (1769).

His collected *Works* were published in 3 vols. (New York, 1811–1812), and were republished with a *Memoir* by Rev. Tryon Edwards (2 vols., Boston, 1850).

BELLARMINE (Ital. *Bellarmino*), **ROBERTO FRANCESCO ROMOLO** (1542–1621), Italian cardinal and theologian, was born at Monte Pulciano, in Tuscany, on the 4th of October 1542. He was destined by his father to a political career, but feeling a call to the priesthood he entered the Society of Jesus in 1560

After spending three years at Rome, he was sent to the Jesuit settlement at Mondovi in Piedmont, where he studied and at the same time taught Greek, and, though not yet in orders, gained some reputation as a preacher. In 1567 and 1568 he was at Padua, studying theology under a master who belonged to the school of St Thomas Aquinas. In 1569 he was sent by the general of his order to Louvain, and in 1570, after being ordained priest, began to lecture on theology at the university. His seven years' residence in the Low Countries brought him into close relations with modes of thought differing essentially from his own; and, though he was neither by temperament nor training inclined to be affected by the prevailing Augustinian doctrines of grace and free-will, the controversy into which he fell on these questions compelled him to define his theological principles more clearly. On his return to Rome in 1576 he was chosen by Gregory XIII. to lecture on controversial theology in the newly-founded Roman College. The result of these labours appeared some years afterwards in the far-famed *Disputationes de Controversiis Christianae Fidei adversus hujus temporis Haereticos* (3 vols., 1581, 1582, 1593). These volumes, which called forth a multitude of answers on the Protestant side, exhaust the controversy as it was carried on in those days, and contain a lucid and uncompromising statement of Roman Catholic doctrine. For many years afterwards, Bellarmine was held by Protestant advocates as the champion of the papacy, and a vindication of Protestantism generally took the form of an answer to his works. In 1589 he was selected by Sixtus V. to accompany, in the capacity of theologian, the papal legation sent to France soon after the murder of Henry III. He was created cardinal in 1599 by Clement VIII., and two years later was made archbishop of Capua. His efforts on behalf of the clergy were untiring, and his ideal of the bishop's office may be read in his address to his nephew, Angelo della Ciaia, who had been raised to the episcopate (*Admonitio ad episcopum Theanensem, nepotem suum*, Rome, 1612). Being detained in Rome by the desire of the newly-elected pope, Paul V., he resigned his archbishopric in 1605. He supported the church in its conflicts with the civil powers in Venice, France and England, and sharply criticized James I. for the severe legislation against the Roman Catholics that followed the discovery of the Gunpowder Plot. When health failed him, he retired to Monte Pulciano, where from 1607 to 1611 he acted as bishop. In 1610 he published his *De Potestate summi Pontificis in rebus temporalibus* directed against the posthumous work of William Barclay of Aberdeen, which denied the temporal power of the pope. Bellarmine trod here on difficult ground, for, although maintaining that the pope had the indirect right to depose unworthy rulers, he gave offence to Paul V. in not asserting more strongly the direct papal claim, whilst many French theologians, and especially Bossuet, condemned him for his defence of ultramontaniam. As a *consultor* of the Sacred Office, Bellarmine took a prominent part in the first examination of Galileo's writings. His conduct in this matter has been constantly misrepresented. He had followed with interest Galileo's scientific discoveries and a respectful admiration grew up between them. Bellarmine did not proscribe the Copernican system, as has been maintained by Reusch (*Der Process Galilei's und die Jesuiten*, Bonn, 1879, p. 125); all he claimed was that it should be presented as an hypothesis until it should receive scientific demonstration. When Galileo visited Rome in December 1615 he was warmly received by Bellarmine, and the high regard in which he was held is clearly testified in Bellarmine's letters and in Galileo's dedication to the cardinal of his discourse on "flying bodies." The last years of Bellarmine's life were mainly devoted to the composition of devotional works and to securing the papal approbation of the new order of the Visitation, founded by his friend St Francis de Sales, and the beatification of St Philip Neri. He died in Rome on the 17th of September 1621. Bellarmine, whose life was a model of Christian virtue, is the greatest of modern Roman Catholic controversialists, but the value of his theological works is seriously impaired by a very defective exegesis and a too frequent use of "forced" conclusions.

His devotional treatises were very popular among English Roman Catholics in the penal days.

BIBLIOGRAPHY.—Of the older editions of Bellarmine's complete works the best is that in 7 vols. published at Cologne (1617-1620); modern editions appeared in 8 vols. at Naples (1856-1862, reprinted 1872), and in 12 vols. at Paris (1870-1874). For complete bibliography of all works of Bellarmine, of translations and controversial writings against him, see C. Sommervogel, *Bibliothèque de la Compagnie de Jésus* (Brussels and Paris, 1890 et seq.), vol. i. cols. 1151-1254; *id.*, *Addenda*, pp. x-xi, vol. viii., cols. 1797-1807. The main source for the life of Bellarmine is his Latin *Autobiography* (Rome, 1675; Louvain, 1753), which was reprinted with original text and German translation in the work of Dollinger and Reusch entitled *Die Selbstbiographie des Cardinals Bellarmine* (Bonn, 1887). The *Epistolae Familiaris*, a very incomplete collection of letters, was published by J. Fulgatti (Rome, 1650), who is also the author of *Vita del cardinale Bellarmine della Compagnia di Gesù* (Rome, 1624). Cf. D. Bartoli, *Della vita di Roberto cardinal Bellarmine* (Rome, 1678), and M. Cervin, *Imago virtutum Roberti card. Bellarmini Politani* (Siena, 1622). All these are panegyrics of small historical value. The best modern studies are J. B. Couderc's *Le Vénéérable Cardinal Bellarmine* (2 vols., Paris, 1893), and X. le Bachez's article in A. Vacant's *Dict. de théol. cat.* cols. 560-599, with exhaustive bibliography.

BELLARY, or BALLARI, a city and district of British India, in the Madras presidency. The city is 305 m. by rail from Madras. Pop. (1901) 58,247. The fort rises from a huge mass of granite rock, which with a circumference of nearly 2 m., juts up abruptly to a height of 450 ft. above the plain. The length of this rock from north-east to south-west is about 1150 ft. To the E. and S. lies an irregular heap of boulders, but to the W. is an unbroken precipice, and the N. is walled by bare rugged ridges. It is defended by two distinct lines of works. The upper fort is a quadrangular building on the summit, with only one approach, and was deemed impregnable by the Mysore princes. But as it has no accommodation for a garrison, it is now only occupied by a small guard of British troops in charge of prisoners. The ex-nawab of Kurnool was confined in it for forty years for the murder of his wife. It contains several cisterns, excavated in the rock. Outside the turreted rampart are a ditch and covered way. The lower fort lies at the eastern base of the rock and measures about half a mile in diameter. It contains the barracks and the commissariat stores, the Protestant church, orphanage, Masonic lodge, post-office and numerous private dwellings. The fort of Bellary was originally built by Hanumapa, in the 16th century. It was first dependent on the kingdom of Vijayanagar, afterwards on Bijapur, and subsequently subject to the nizam and Hyder Ali. The latter erected the present fortifications according to tradition with the assistance of a French engineer in his service, whom he afterwards handed for not building the fort on a higher rock adjacent to it. Bellary is an important cantonment and the headquarters of a military division. There is a considerable trade in cotton, in connexion with which there are large steam presses, and some manufacture of cotton cloth. There is a cotton spinning mill. In 1901 Bellary was chosen as one of the places of detention in India for Boer prisoners of war.

The district of BELLARY has an area of 5714 sq. m. It consists chiefly of an extensive plateau between the Eastern and Western Ghats, of a height varying from 800 to 1000 ft. above the sea. The most elevated tracts are on the west, where the surface rises towards the culminating range of hills, and on the south, where it rises to the elevated tableland of Mysore. Towards the centre the almost treeless plain presents a monotonous aspect, broken only by a few rocky elevations that rise abruptly from the black soil. The hill ranges in Bellary are those of Sandur and Kampli to the west, the Lanka Malla to the east and the Copper Mountain (3148 ft.) to the south-west. The district is watered by five rivers: the Tungabhadra, formed by the junction of two streams, Tunga and Bhadra, the Haggari, Hindri, Chitravati and Pennar, the last considered sacred by the natives. None of the rivers is navigable and all are fordable during the dry season. The climate of Bellary is characterized by extreme dryness, due to the passing of the air over a great extent of heated plains, and it has a smaller rainfall than any other district in south India. The average daily variation of the thermometer is from 67° to 83° F. The

prevailing diseases are cholera, fever, small-pox, ophthalmia, dysentery and those of the skin among the lower classes. Bellary is subject to disastrous storms and hurricanes, and to famines arising from a series of bad seasons. There were memorable famines in 1751, 1793, 1803, 1833, 1854, 1866, 1877 and 1896.

In 1901 the population was 947,214, showing an increase of 8% in the decade. The principal crops are millet, other food-grains, pulse, oil-seeds and cotton. There are considerable manufactures of cotton and woollen goods, and cotton is largely exported. The district is traversed by the Madras and Southern Mahratta railways, meeting on the eastern border at Guntakal junction, where another line branches off to Bezwada.

Little is known of the early history of the district. It contains the ruined capital of the ancient Hindu kingdom of Vijayanagar, and on the overthrow of that state by the Mahomedans, in 1564, the tract now forming the district of Bellary was split up into a number of military holdings, held by chiefs called poligars. In 1635 the Carnatic was annexed to the Bijapur dominions, from which again it was wrested in 1680 by Sivaji, the founder of the Mahratta power. It was then included in the dominions of Nizam-ul-mulk, the nominal viceroy of the great Mogul in the Deccan, from whom again it was subsequently conquered by Hyder Ali of Mysore. At the close of the war with Tipoo Sultan in 1792, these territories fell to the share of the nizam of Hyderabad, by whom they were ceded to the British in 1800, in return for protection by a force of British troops to be stationed at his capital. In 1808 the "Ceded Districts," as they were called, were split into two districts, Cuddapah and Bellary. In 1882 the district of Anantapur, which had hitherto formed part of Bellary, was formed into a separate collectorate.

See *Bellary Gazetteer*, 1904.

BELL-COT, **BELL-GABLE**, or **BELL-TURRET**, the place where one or more bells are hung in chapels or small churches which have no towers. Bell-cots are sometimes double, as at Northborough and Coxwell; a very common form in France and Switzerland admits of three bells. In these countries also they are frequently of wood and attached to the ridge. In later times bell-turrets were much ornamented; on the continent of Europe they run up into a sort of small, slender spire, called *flèche* in France, and *guglio* in Italy. A bell-cot, gable or turret often holds the "Sanctus-bell," rung at the saying of the "Sanctus" at the beginning of the canon of the Mass, and at the consecration and elevation of the Elements in the Roman Church. This differs but little from the common bell-cot, except that it is generally on the top of the arch dividing the nave from the chancel. At Clevee, however, the bell seems to have been placed in a cot outside the wall. Sanctus-bells have also been placed over the gables of porches.

BELLEAU, REMY (c. 1527-1577), French poet, and member of the Pléiade (see DAURAT), was born at Nogent-le-Rotrou about 1527. He studied with Ronsard and others under Jean Daurat at the Collège de Coqueret. He was attached to René de Lorraine, marquis d'Elbeuf, in the expedition against Naples in 1557, where he did good military service. On his return he was made tutor to the young Charles, marquis d'Elbeuf, who, under Belleau's training became a great patron of the muses. Belleau was an enthusiast for the new learning and joined the group of young poets with ardour. In 1556 he published the first translation of Anacreon which had appeared in French. In the next year he published his first collection of poems, the *Petites inventions*, in which he describes stones, insects and flowers. The *Amours et nouveaux échanges des pierres précieuses* . . . (1576) contains perhaps his most characteristic work. Its title is quoted in the lines of Ronsard's epitaph on his tomb:—

"*Luy mesme a basti son tombeau
Dedans ses Pierres Précieuses.*"

He wrote commentaries to Ronsard's *Amours* in 1560, notes which evinced delicate taste and prodigious learning. Like Ronsard and Joachim Du Bellay, he was extremely deaf. His days passed peacefully in the midst of his books and friends, and he died on the 6th of March 1577. He was buried in the nave of the Grands Augustins at Paris, and was borne to the tomb on

the pious shoulders of four poets, Ronsard, J. A. de Baif, Philippe Desportes and Amadis Jamyn. His most considerable work is *La Bergerie* (1565-1572), a pastoral in prose and verse, written in imitation of Sannazaro. The lines on April in the *Bergerie* are well known to all readers of French poetry. Belleau was the French Herrick, full of picturesqueness, warmth and colour. His skies drop flowers and all his air is perfumed, and this voluptuous sweetness degenerates sometimes into licence. Extremely popular in his own age, he shared the fate of his friends, and was undeservedly forgotten in the next. Regnier said: "Belleau ne parle pas comme on parle à la ville"; and his lyrical beauty was lost on the trim 17th century. His complete works were collected in 1578, and contain, besides the works already mentioned, a comedy entitled *La Reconnuë*, in short rhymed lines, which is not without humour and life, and a comic masterpiece, a macaronic poem on the religious wars, *Dictamen metrificum de bello huguenotico et reitororum piglamine ad sodales* (Paris, no date).

The *Œuvres complètes* (3 vols., 1867) of Remy Belleau were edited by A. Gouverneur; and his *Œuvres poétiques* (2 vols., 1879) by M. Ch. Marty-Laveaux in his *Pléiade française*; see also C. A. Sainte-Beuve, *Tableau historique et critique de la poésie française au XVI^e siècle* (ed. 1876), i. pp. 155-160, and ii. pp. 296 seq.

BELLECOUR (1725-1778), French actor, whose real name was JEAN CLAUDE GILLES COLTON, was born on the 16th of January 1725, the son of a portrait-painter. He showed decided artistic talent, but soon deserted the brush for the stage under the name of Bellecour. After playing in the provinces he was called to the Comédie Française, but his *début*, on the 21st of December 1750, as Achilles in *Iphigénie* was not a great success. He soon turned to more congenial comedy rôles, which for thirty years he filled with great credit. He was a very natural player, and his willingness to give others on the stage an opportunity to show their talents made him extremely popular. He wrote a successful play, *Faussez apparences* (1761), and was very useful to the Comédie Française in editing and adapting the plays of others. He died on the 19th of November 1778.

His wife, ROSE PERRINE LE ROY DE LA CORBINAYE, was born at Lamballe on the 20th of December 1730, the daughter of an artillery officer. Under the stage name of Beaumencard she made her first Paris appearance in 1743 as Gogo in Favart's *Le Coq du village*. After a year at the Opéra Comique she played in several companies, including that of Marshal Saxe, who is said to have been not insensible to her charms. In 1749 she made her *début* at the Comédie Française as Dorine in *Tartuffe*, and her success was immediate. She retired in 1756, but after an absence of five years, during which she married, she reappeared as Madame Bellecour, and continued her successes in soubrette parts in the plays of Molière and de Regnard. She retired finally at the age of sixty, but troublous times had put an end to the pension which she received from Louis XVI. and from the theatre, and she died in abject poverty on the 5th of August 1799. There is a charming portrait of her owned by the Théâtre Français.

BELLEFONTAINE, a city and the county-seat of Logan county, Ohio, U.S.A., about 45 m. N.W. of Columbus. Pop. (1890) 4245; (1900) 6649 (267 foreign-born); (1910) 8238. It is served by the Cleveland, Cincinnati, Chicago & St Louis (which has large shops here) and the Ohio Central railways; also by the Dayton, Springfield & Urbana electric railway. It is built on the south-west slope of a hill having an elevation of about 1500 ft. above sea-level and at the foot of which are several springs of clear water which suggested the city's name. Among the city's manufactures are iron bridges, carriage-bodies, flour and cement. The municipality owns and operates its water-works system and its gas and electric-lighting plants. Bellefontaine was first settled about 1818, was laid out as a town and made the county-seat in 1820 and was incorporated in 1835.

BELLEGARDE, the name of an important French family. Roger de Saint-Lary, baron of Bellegarde, served with distinction in the wars against the French Protestants. He showed much devotion to Henry III., who loaded him with favours and made him marshal of France. He eventually fell into disgrace,

¹ *Retires*, German soldiers of fortune.

however, and died by poisoning in 1579. His nephew, Roger de Saint-Lary de Termes, a favourite with Henry III., Henry IV. and Louis XIII., was royal master of the horse and governor of Burgundy. His estate of Seurre in Burgundy was created a duchy in the peerage of France (*duché-pairie*) in his favour under the name of Bellegarde, in 1619. In 1645 the title of this duchy was transferred to the estate of Choisy-aux-Loges in Gâtinais, and was borne later by the family of Pardaillan de Gondrin, heirs of the house of Saint-Lary-Bellegarde. When Seurre passed into the possession of the princes of Condé they in the same way acquired the title of dukes of Bellegarde. (M. P. *)

BELLEGARDE, HEINRICH JOSEPH JOHANNES, COUNT VON (1756-1845), Austrian soldier and statesman, was born at Dresden on the 20th of August 1756, and for a short time served in the Saxon army. Transferring his services to Austria in 1771 he distinguished himself greatly as colonel of dragoons in the Turkish War of 1788-1789, and served as a major-general in the Netherlands campaigns of 1793-1794. In the campaign of 1796 in Germany, as a lieutenant field marshal, he served on the staff of the archduke Charles, whom he accompanied to Italy in the following year. He was also employed in the congress of Rastatt. In 1799 he commanded a corps in eastern Switzerland, connecting the armies of the archduke and Suvarov, and finally joined the latter in north Italy. He conducted the siege of the citadel of Alessandria, and was present at the decisive battle of Novi. He served again in the latter part of the Marengo campaign of 1800 in the rank of general of cavalry. In 1805, when the archduke Charles left to take command in Italy, Bellegarde became president *ad interim* of the council of war. He was, however, soon employed in the field, and at the sanguinary battle of Caldiero he commanded the Austrian right. In the war of 1809 he commanded the extreme right wing of the main army (see NAPOLEONIC CAMPAIGNS). Cut off from Charles as the result of the battle of Eckmühl, he retreated into Bohemia, but managed to rejoin before the great battles near Vienna (Aspern and Wagram). From 1809 to 1813 Bellegarde, now field marshal, was governor-general of Galicia, but was often called to preside over the meetings of the Aulic Council, especially in 1810 in connexion with the reorganization of the Austrian army. In 1813, 1814 and 1815 he led the Austrian armies in Italy. His successes in these campaigns were diplomatic as well as military, and he ended them by crushing the last attempt of Murat in 1815. From 1816 to 1825 (when he had to retire owing to failing eyesight) he held various distinguished civil and military posts. He died in 1845.

See Smola, *Das Leben des F. M. von Bellegarde* (Vienna, 1847).

BELLE-ÎLE-EN-MER, an island off the W. coast of France, forming a canton of the department of Morbihan, 8 m. S. by W. of the peninsula of Quiberon. Pop. (1906) 9703. Area, 33 sq. m. The island is divided into the four communes of Le Palais, Bangor, Sauzon and Locmaria. It forms a treeless plateau with an average height of 130 ft. above sea-level, largely covered with moors and bordered by a rugged and broken coast. The climate is mild, the fig-tree and myrtle growing in sheltered spots and the soil, where cultivated, is productive. The inhabitants are principally engaged in agriculture and the fisheries, and in the preservation of sardines, anchovies, &c. The breed of draught horses in the island is highly prized. The chief town, Le Palais (pop. 2637), has an old citadel and fortifications, and possesses a port which is accessible to vessels drawing 13 ft. of water. Belle-Île must have been inhabited from a very early period, as it possesses several stone monuments of the class usually called Druidic.

The Roman name of the island seems to have been *Vindilis*, which in the middle ages became corrupted to Guedel. In 1572 the monks of the abbey of Ste Croix at Quimperlé ceded the island to the Retz family, in whose favour it was raised to a marquise in the following year. It subsequently came into the hands of the family of Fouquet, and was ceded by the latter to the crown in 1718. It was held by English troops from 1761 to 1763 when the French got it in exchange for Nova Scotia. A few of the inhabitants of the latter territory migrated to

Belle-Île, which is partly peopled by their descendants. In the state prison of Nouvelle Force at Le Palais political prisoners have at various times been confined.

BELLE-ISLE, CHARLES LOUIS AUGUSTE FOUQUET, COMTE, and later DUC, DE (1684-1761), French soldier and statesman, was the grandson of Nicholas Fouquet, superintendent of finances under Louis XIV., and was born at Villefranche de Rouergue. Although his family was in disgrace, he entered the army at an early age and was made proprietary colonel of a dragoon regiment in 1708. He rose during the War of the Spanish Succession to the rank of brigadier, and in March 1718 to that of *maréchal de camp*. In the Spanish War of 1718-1719 he was present at the capture of Fontarabia in 1718 and at that of St Sebastian in 1719. When the duke of Bourbon became prime minister, Belle-Isle was imprisoned in the Bastille, and then relegated to his estates, but with the advent of Cardinal Fleury to power he regained some measure of favour and was made a lieutenant-general. In the War of the Polish Succession he commanded a corps under the orders of Marshal Berwick, captured Trier and Trarbach and took part in the siege of Philippsburg (1734). When peace was made in 1736 the king, in recognition both of his military services and of the part he had taken in the negotiations for the cession of Lorraine, gave him the government of the three important fortresses of Metz, Toul and Verdun—an office which he kept till his death. His military and political reputation was now at its height, and he was one of the principal advisers of the government in military and diplomatic affairs. In 1741 he was sent to Germany as French plenipotentiary to carry out, in the interests of France, a grand scheme of political reorganization in the moribund empire, and especially to obtain the election of Charles, elector of Bavaria, as emperor. His diplomacy was thus the mainspring of the War of the Austrian Succession (*q.v.*), and his military command in south Germany was full of incidents and vicissitudes. He had been named marshal of France in 1741, and received a large army, with which it is said that he promised to make peace in three months under the walls of Vienna. The truth of this story is open to question, for no one knew better than Belle-Isle the limitations imposed upon commanders by the military and political circumstances of the times. These circumstances in fact rendered his efforts, both as a general and as a statesman, unavailing, and the one redeeming feature in the general failure was his heroic retreat from Prague. In ten days he led 14,000 men into and across the Bohemian Forest, suffering great privations and harassed by the enemy, but never allowing himself to be cut off, and his subordinate Chevert defended Prague so well that the Austrians were glad to allow him to rejoin his chief. The campaign, however, had discredited Belle-Isle; he was ridiculed at Paris by the wits and the populace, even Fleury is said to have turned against him, and, to complete his misfortunes, he was taken prisoner by the English in going from Cassel to Berlin through Hanover. He remained a year in England, in spite of the demands of Louis XV. and of the emperor Charles VII. During the campaign of 1746 he was in command of the "Army of Piedmont" on the Alpine frontier, and although he began his work with a demoralized and inferior army, he managed not only to repel the invasion of the Spanish and Italian forces but also to carry the war back into the plain of Lombardy. At the peace, having thus retrieved his military reputation, he was created duke and peer of France (1748). In 1757 his credit at court was considerable, and the king named him secretary for war. During his three years' ministry he undertook many reforms, such as the development of the military school for officers, and the suppression of the proprietary colonies of nobles who were too young to command; and he instituted the Order of Merit. But the Seven Years' War was by that time in progress and his efforts had no immediate effect. He died at Versailles on the 26th of January 1761. Belle-Isle interested himself in literature; was elected a member of the French Academy in 1740, and founded the Academy of Metz in 1760. The dukedom ended with his death, his only son having been killed in 1758 at the battle of Crefeld.

His brother, LOUIS CHARLES ARMAND FOUQUET, known as the Chevalier de Belle-Isle (1693-1746), was also a soldier and a diplomatist. He served as a junior officer in the War of the Spanish Succession and as brigadier in the campaign of 1734 on the Rhine and Moselle, where he won the grade of *marchal de camp*. He was employed under his brother in political missions in Bavaria and in Swabia in 1741-1742, became a lieutenant-general, fought in Bohemia, Bavaria and the Rhine countries in 1742-1743, and was arrested and sent to England with the marshal in 1744. On his release he was given a command in the Army of Piedmont. He fell a victim to his romantic bravery at the action of Exilles (Col de l'Assiette) on the 19th of July 1746.

See Jean de Maugre, *Oraison funèbre du marchal de Belleisle* (Montrejeu, 1762); R. P. de Neuville, *Mémoires du marchal duc de Belleisle* (Paris, 1761); D. C. (Chevrier), *La Vie politique et militaire du marchal duc de Belleisle* (London, 1760), and *Testament politique du marchal duc de Belleisle* (Hague, 1762); *Le Codicille et l'esprit ou commentaire des maximes du marchal duc de Belleisle* (Amsterdam, 1761); F. M. Chavert, *Notice sur le marchal de Belleisle* (Metz, 1856); L. Leclerc, *Éloge du marchal de Belleisle* (Metz, 1852); E. Michel, *Éloge du marchal de Belleisle* (Paris, 1852); and Jobez, *La France sous Louis XV* (6 vols., Paris, 1868-1874).

BELLE ISLE, STRAIT OF, the more northern of the two channels connecting the Gulf of St Lawrence with the Atlantic Ocean. It separates northern Newfoundland from Labrador, and extends N.E. and S.W. for 35 m., with a breadth of 10 to 15 m. It derives its name from a precipitous granite island, 700 ft. in height, at its Atlantic entrance. On this light-house are maintained by the government of Canada and constant communication with the mainland is kept up by wireless telegraphy. The strait is in the most direct route from Europe to the St Lawrence, but is open only from June till the end of November, and even during this period navigation is often rendered dangerous by floating ice and fogs. Through it Jacques Cartier sailed in 1534. The southern or Cabot Strait, between Cape Ray in Newfoundland and Cape North in Cape Breton, was discovered later, and the expansion below Belle Isle was long known as *La Grande Baie*. Cabot Strait is open all the year, save for occasional inconvenience from drift ice.

BELLENDEN (BALLANTYNE or BANNATYNE), JOHN (fl. 1533-1587), Scottish writer, was born about the end of the 15th century, in the south-east of Scotland, perhaps in East Lothian. He appears to have been educated, first at the university of St Andrews and then at that of Paris, where he took the degree of doctor. From his own statement, in one of his poems, we learn that he had been in the service of James V. from the king's earliest years, and that the post he held was clerk of accounts. At the request of James he undertook translations of Boece's *Historia Scotorum*, which had appeared at Paris in 1527, and the first five books of Livy. As a reward for his versions, which he finished in 1533, he was appointed archdeacon of Moray and a canon of Ross. He was a strenuous opponent of the Reformation and was compelled to go into exile. He is said by some authorities to have died at Rome in 1550; by others to have been still living in 1587. His translation of Boece, entitled *The History and Chronicles of Scotland*, is a remarkable specimen of Scottish prose, distinguished by its freedom and vigour of expression. It was published in 1536; and was reprinted in 2 vols., edited by Maitland, in 1821. The translation of Livy was not printed till 1822 (also in 2 vols.). Two MSS. of the latter are extant, one, the older, in the Advocates' library, Edinburgh (which was the basis of the normalized text of 1822), the other (c. 1550) in the possession of Mr Ogilvie Forbes of Boyndie. An edition of the work was edited for the Scottish Text Society by Mr W. A. Craigie (2 vols. 1901, 1903). The second volume of this edition contains also a complete reprint of the portions of the holograph first draft which were discovered in the British Museum in 1902. Two poems by Bellenden—*The Proheme to the Cosmographie* and the *Proheme of the History*—appeared in the 1536 edition of the *History of Scotland*. Others, bearing his name in the well-known Bannatyne MS. collection, made by his namesake George Bannatyne (q.v.), may or may not

be his. Sir David Lyndsay, in his prologue to the *Papyngo*, speaks vaguely of:

"Ane cunnyng Clark quhik writhth craftleie
Ane plant of poetis callit Ballendyne,
Quhose ornat workis my wit can nocht defyne."

The chief sources of information regarding Bellenden's life are the *Accounts of the Lord High Treasurer of Scotland*, his own works and the ecclesiastical records.

BELLENDEN, WILLIAM, Scottish classical scholar. Hardly anything is known of him. He lived in the reign of James I. (VI. of Scotland), who appointed him *magister libellorum supplicum* or master of requests. King James is also said to have provided Bellenden with the means of living independently at Paris, where he became professor at the university, and advocate in the parliament. The date of his birth cannot be fixed, and it can only be said that he died later than 1625. The first of the works by which he is known was published anonymously in 1608, with the title *Ciceronis Princeps*, a laborious compilation of all Cicero's remarks on the origin and principles of regal government, digested and systematically arranged. In 1612 there appeared a similar work, devoted to the consideration of consular authority and the Roman senate, *Ciceronis Consul, Senator, Senatusque Romanus*. His third work, *De Statu Prisci Orbis*, 1615, is a good outline of general history. All three works were combined in a single large volume, entitled *De Statu Libri Tres*, 1615, which was first brought into due notice by Dr Samuel Parr, who, in 1787, published an edition with a preface, famous for the elegance of its Latinity, in which he eulogized Burke, Fox and Lord North as the "three English luminaries." The greatest of Bellenden's works is the extensive treatise *De Tribus Luminibus Romanorum*, printed and published posthumously at Paris in 1633. The book is unfinished, and treats only of the first luminary, Cicero; the others intended were apparently Seneca and Pliny. It contains a most elaborate history of Rome and its institutions, drawn from Cicero, and thus forms a storehouse of all the historical notices contained in that voluminous author. It is said that nearly all the copies were lost on the passage to England. One of the few that survived was placed in the university library at Cambridge, and freely drawn upon by Conyers Middleton, the librarian, in his *History of the Life of Cicero*. Both Joseph Warton and Dr Parr accused Middleton of deliberate plagiarism, which was the more likely to have escaped detection owing to the small number of existing copies of Bellenden's work.

BELLEROPHON, or BELLEROPHONTES, in Greek legend, son of Glaucus or Poseidon, grandson of Sisyphus and local hero of Corinth. Having slain by accident the Corinthian hero Bellerus (or, according to others, his own brother) he fled to Tiryns, where his kinsman Proetus, king of Argos, received him hospitably and purged him of his guilt. But Antea (or Sthenoboca), wife of Proetus, became enamoured of Bellerophon, and when he refused her advances, charged him with an attempt upon her virtue. Proetus thereupon sent him to Iobates, his wife's father, king of Lycia, with a letter or sealed tablet, in which were instructions, apparently given by means of signs, to take the life of the bearer. Arriving in Lycia, he was received as a guest and entertained for nine days. On the tenth, being asked the object of his visit, he handed the letter to the king, whose first plan for complying with it was to send him to slay the Chimæra, a monster which was devastating the country. Bellerophon, mounted on Pegasus (q.v.), kept up in the air out of the way of the Chimæra, but yet near enough to kill it with his spear, or, as he is at other times represented, with his sword or with a bow. He was next ordered out against the Solyimi, a hostile tribe, and afterwards against the Amazons, from both of which expeditions he not only returned victorious, but also on his way back slew an ambush of chosen warriors whom Iobates had placed to intercept him. His divine origin was now proved; the king gave him his daughter in marriage; and the Lycians presented him with a large and fertile estate on which he lived (Apollodorus, ii. 3; Homer, *Iliad*, vi. 155). Bellerophon is said to have returned to Tiryns and avenged himself on Antea; he persuaded her to fly with him on his winged horse, and then flung her into

the sea near the island of Melos (Schol. Aristoph., *Pax*, 140). His ambitious attempt to ascend to the heavens on Pegasus brought upon him the wrath of the gods. His son was smitten by Ares in battle; his daughter Laodameia was slain by Artemis; he himself, flung from his horse, lamed or blinded, became a wanderer over the face of the earth until his death (Pindar, *Isthmia*, vi. [vii.], 44; Horace, *Odes*, iv. 11, 26). Bellerophon was honoured as a hero at Corinth and in Lycia. His story formed the subject of the *Iobates* of Sophocles, and of the *Bellerophon* and *Sthenobea* of Euripides. It has been suggested that Perseus, the local hero of Argos, and Bellerophon were originally one and the same, the difference in their exploits being the result of the rivalry of Argos and Corinth. Both are connected with the sun-god Helios and with the sea-god Poseidon, the symbol of the union being the winged horse Pegasus. Bellerophon has been explained as a hero of the storm, of which his conflict with the Chimaera is symbolical. The most frequent representations of Bellerophon in ancient art are (1) slaying the Chimaera, (2) departing from Argos with the letter, (3) leading Pegasus to drink. Among the first is to be noted a terra-cotta relief from Melos in the British Museum, where also, on a vase of black ware, it is what seems to be a representation of his escape from Sthenobea.

See H. A. Fischer, *Bellerophon* (1851); R. Engelmann, *Annali* of the Archaeological Institute at Rome (1874); O. Treuber, *Geschichte der Lykier* (1887); articles in Pauly-Wissowa's *Real-Encyclopädie*, W. H. Roscher's *Lexikon der Mythologie*, Darnberg and Sägler's *Dictionnaire des antiquités*; L. Preller, *Griechische Mythologie*.

BELLES-LETTRES (Fr. for "fine literature"), a term used to designate the more artistic and imaginative forms of literature, as poetry or romance, as opposed to more pedestrian and exact studies. The term appears to have been first used in English by Swift (1710).

BELLEVILLE, a city and port of entry of Ontario, Canada, and capital of Hastings county, 106 m. E.N.E. of Toronto, on Bay of Quinté and the Grand Trunk railway. Pop. (1901) 9,117. Communication is maintained with Lake Ontario and St. Lawrence ports by several lines of steamers. It is the commercial centre of a fine agricultural district, and has a large export trade in cheese and farm produce. The principal industries are planing mills and cement works, cheese factories and distilleries. There are several educational institutions, including a business college, a convent, and a government institute for the deaf and dumb. Albert College, under the control of the Methodist church, was formerly a university, but now confines itself to secondary education.

BELLEVILLE, a city and the county-seat of St. Clair county, Illinois, U.S.A., in the S.W. part of the state 14 m. S.E. of St. Louis, Missouri. Pop. (1890) 15,361; (1900) 17,484, of whom 2750 were foreign-born; (1910) 21,122. Belleville is served by the Illinois Central, the Louisville & Nashville, and the Southern railways, also by extensive interurban electric systems; and a belt line to O'Fallon, Illinois, connects Belleville with the Baltimore & Ohio South Western railway. A large element of the population is of German descent or German birth, and two newspapers are published in German, besides three dailies, three weeklies and a semi-weekly in English. Among the industrial establishments of the city are stove and range factories, flour mills, rolling mills, distilleries, breweries, shoe factories, copper refining works, nail and tack factories, glass works and agricultural implement factories. The value of the city's factory products increased from \$2,873,334 in 1900 to \$4,356,615 in 1905 or 51.6%. Belleville is in a rich agricultural region, and in the vicinity there are valuable coal mines, the first of which was sunk in 1852; from this dates the industrial development of the city. Belleville was first settled in 1813, was incorporated as a city in 1850, and was re-incorporated in 1876.

BELLEVY, a town of eastern France, capital of an arrondissement in the department of Ain, 52 m. S.E. of Bourg by the Paris-Lyon railway. Pop. (1906), town, 3709; commune, 5707. It is situated on vine-covered hills at the southern

extremity of the Jura, 3 m. from the right bank of the Rhone. Apart from the cathedral of St. Jean, which, with the exception of the choir of 1413, is a modern building, there is little of architectural interest in the town. Belley is the seat of a bishopric and a prefect, and has a tribunal of first instance. The manufacture of morocco leather goods and the quarrying of the lithographic stone of the vicinity are carried on, and there is trade in cattle, grain, wine, truffles and dressed pork. Belley is of Roman origin, and in the 5th century became an episcopal see. It was the capital of the province of Bugy, which was a dependency of Savoy till 1601, when it was ceded to France. In 1385 the town was almost entirely destroyed by an act of incendiarism, but was subsequently rebuilt by the dukes of Savoy, who surrounded it with ramparts of which little is left.

BELLI, GIUSEPPE GIOACHINO (1791-1863), Italian poet, was born at Rome, and after a period of literary employment in poor circumstances was enabled by marriage with a lady of means to follow his own special bent. He is remembered for his vivid popular poetry in the Roman dialect, a number of satirical sonnets which in their own way are unique.

See Morandi's edition, *I sonetti romaneschi* (1886-1898).

BELLIGERENCY, the state of carrying on war (Lat. *bellum*, war, and *gerere*, to wage) in accordance with the law of nations. Insurgents are not as such excluded from recognition as belligerents, and, even where not recognized as belligerents by the government against which they have rebelled, they may be so recognized by a neutral state, as in the case of the American Civil War, when the Southern states were recognized as belligerents by Great Britain, though regarded as rebels by the Northern states. The recognition by a neutral state of belligerency does not, however, imply recognition of independent political existence. The regulations annexed to the Hague Convention, relating to the laws and customs of war (20th of July 1899), contain a section entitled "Belligerents" which is divided into three chapters, dealing respectively with (i.) The Qualifications of Belligerents; (ii.) Prisoners of War; (iii.) The Sick and Wounded. To entitle troops to the special privileges attaching to belligerency, chapter i. provides that all regular, militia or volunteer forces shall alike be commanded by persons responsible for the acts of their men, that all such shall carry distinctive emblems, recognizable at a distance, that arms shall be carried openly and operations conducted in accordance with the usages of war observed among civilized mankind. It provides, nevertheless, for the emergency of the population of a territory, which has not already been occupied by the invader, spontaneously taking up arms to resist the invading forces, without having had time to comply with the above requirements; they, too, are to be treated as belligerents "if they respect the laws and customs of war." In naval war, privateering having been finally abolished as among the parties to it by the declaration of Paris, a privateer is not entitled, as between such parties, to the rights of belligerency. As between states, one of whom is not a party to the Declaration, the right to grant letters of marque would remain intact for both parties, and the privateer, as between them, would be a belligerent; as regards neutrals, the situation would be complicated (see PRIVATEER). On prisoners of war and sick and wounded, see WAR. (T. BA.)

BELLINGHAM, SIR EDWARD (d. 1549), lord deputy of Ireland, was a son of Edward Bellingham of Erringham, Sussex, his mother being a member of the Shelley family. As a soldier he fought in France and elsewhere, then became an English member of parliament and a member of the privy council, and in 1547 took part in some military operations in Ireland. In May 1548 he was sent to that country as lord deputy. Ireland was then in a very disturbed condition, but the new governor crushed a rebellion of the O'Connors in Leinster, freed the Pale from rebels, built forts, and made the English power respected in Munster and Connaught. Bellingham, however, was a headstrong man and was constantly quarrelling with his council; but one of his opponents admitted that he was "the best man of

war that ever he had seen in Ireland." His short but successful term of office was ended by his recall in 1549.

See R. Bagwell, *Ireland Under the Tudors*, vol. i. (1885).

BELLINGHAM, a city of Whatcom county, Washington, U.S.A., on the E. side of Bellingham Bay, 96 m. N. of Seattle. Pop. (1900) 11,062; (1905, state est.) 26,000; (1910, U.S. census) 24,208. Area about 23 sq. m. It is served by the Great Northern, the Northern Pacific, the Canadian Pacific, and the Bellingham Bay & British Columbia railways—being a terminus of the last named, which operates only 62 m. of line and connects with the Mt. Baker goldfields and the Nooksack valley farm and orchard region. A suburban electric line was projected in 1907. About 2½ m. south-east of the city is the main body of Lake Whatcom, 13 m. long, 1½ m. wide, and 318 ft. higher than the city and the source of its water-supply, a gravity system which cost \$1,000,000, being owned by the city. Bellingham has two Carnegie libraries. Among the principal buildings are the county court-house, the city hall, the Young Men's Christian Association building, and Beck's theatre, with a seating capacity of 2200. The largest of the state's normal colleges is situated here; in 1907 it had a faculty of 25 and 350 students; there are two high schools, two business colleges, and one industrial school also in the city. The excellent harbour, and the fact that Bellingham is nearer to the great markets of Alaska than any other city in the states, make the port an important shipping centre. In the value of manufactured product the city was fourth in the state in 1905 (being passed only by Tacoma, Seattle and Spokane), with a value of \$3,293,988; according to a census taken by the local chamber of commerce the value of the product in 1906 was \$7,751,464. The principal industrial establishments are shingle (especially cedar) and saw-mills, salmon canneries and factories for the manufacture of tin cans, and machinery used in the canning of salmon. Motive and electric lighting power is brought 52 m. from the falls of the north fork of the Nooksack river, where there is a power plant which furnishes 3500 horsepower. There are deposits of clay and limestone in the surrounding country, and cement is manufactured in the vicinity of the city. The blue-grey Chuckanut sandstone is quarried on the shore of Chuckanut Bay, south of Bellingham; and a coarse, dark-brown sandstone is quarried on Sucia Island, west of the city. There are quarries also on Waldron Island. Bellingham was formed in 1903 by the consolidation of the cities of New Whatcom (pop. in 1900, 6834) and Fairhaven (pop. in 1900, 4228), and was chartered as a city of the first class in 1904; it is named from Bellingham Bay, which Vancouver is supposed to have named, in 1792, in honour of Sir Henry Bellingham.

BELLINI, the name of a family of craftsmen in Venice, three members of which fill a great place in the history of the Venetian school of painting in the 15th century and the first years of the 16th.

I. JACOPO BELLINI (c. 1400–1470–71) was the son of a tinsmith or pewterer, Nicoletto Bellini, by his wife Franceschina. When the accomplished Umbrian master Gentile da Fabriano came to practise at Venice, where art was backward, several young men of the city took service under him as pupils. Among these were Giovanni and Antonio di Murano and Jacopo Bellini. Gentile da Fabriano left Venice for Florence in 1422, and the two brothers of Murano stayed at home and presently founded a school of their own (see VIVARENTI). But Jacopo Bellini followed his teacher to Florence, where the vast progress lately made, alike in truth to natural fact and in sense of classic grace and style, by masters like Donatello and Ghiberti, Masaccio and Paolo Uccello, offered him better instruction than he could obtain even from his Umbrian teacher. But his position as assistant to Gentile brought him into trouble. As a stranger coming to practise in Florence, Gentile was jealously looked on. One day some young Florentines threw stones into his shop, and the Venetian pupil ran out and drove them off with his fists. Thinking this might be turned against him, he went and took service on board the galleys of the Florentine state; but returning after a year, found he had in his absence been condemned and fined for

assault. He was arrested and imprisoned, but the matter was soon compromised, Jacopo submitting to a public act of penance and his adversary renouncing further proceedings. Whether Jacopo accompanied his master to Rome in 1426 we cannot tell; but by 1429 we find him settled at Venice and married to a wife from Pesaro named Anna (family name uncertain), who in that year made a will in favour of her first child then expected. She survived, however, and bore her husband two sons, Gentile and Giovanni (though some evidences have been thought to point rather to Giovanni having been his son by another mother), and a daughter Nicolosia. In 1436 Jacopo was at Verona, painting a Crucifixion in fresco for the chapel of S. Nicholas in the cathedral (destroyed by order of the archbishop in 1750, but the composition, a vast one of many figures, has been preserved in an old engraving). Documents ranging from 1437 to 1465 show him to have been a member of the Scuola or mutual aid society of St John the Evangelist at Venice, for which he painted at an uncertain date a series of eighteen subjects of the Life of the Virgin, fully described by Ridolfi but now destroyed or dispersed. In 1439 we find him buying a panel of tarsia work at the sale of the effects of the deceased painter Jacobello del Fiore, and in 1440 entering into a business partnership with another painter of the city called Donato. About this time he must have paid a visit to the court of Ferrara, where there prevailed a spirit of free culture and humanism most congenial to his tastes. Pisanello, the first great naturalist artist of north Italy, whose influence on Jacopo at the outset of his career had been only second to that of Gentile da Fabriano, had been some time engaged on a portrait of Leonello d'Este, the elder son of the reigning marquis Niccolò III. Jacopo (according to an almost contemporary sonneteer) competed with a rival portrait, which was declared by the father to be the better of the two. In the next year, the last of the marquis Niccolò's life, we find him making the successful painter a present of two bushels of wheat. The relations thus begun with the house of Este seem to have been kept up, and among Jacopo's extant drawings are several that seem to belong to the scheme of a monument erected to the memory of the marquis Niccolò ten years later. He was also esteemed and employed by Sigismondo Malatesta at the court of Rimini. In 1443 Jacopo took as an articulated pupil a nephew whom he had brought up from charity; in 1452 he painted a banner for the Scuola of St Mary of Charity at Venice, and the next year received a grant from the confraternity for the marriage of his daughter Nicolosia with Andrea Mantegna, a marriage which had the effect of transferring the gifted young Paduan master definitively from the following of Squarcione to that of Bellini. In 1456 he painted a figure of Lorenzo Giustiniani, first patriarch of Venice, for his monument in San Pietro de Castello, and in 1457, with a son for salaried assistant, three figures of saints in the great hall of the patriarch. For some time about these years Jacopo and his family would seem to have resided at, or at least to have paid frequent visits to Padua, where he is reported to have carried out works now lost, including an altar-piece painted with the assistance of his sons in 1459–1460 for the Gattamelata chapel in the Santo, and several portraits which are described by 16th-century witnesses but have disappeared. At Venice he painted a Calvary for the Scuola of St Mark (1466). His activity can be traced in documents down to August 1470, but in November 1471 his wife Anna describes herself as his relict, so that he must have died some time in the interval.

The above are all the facts concerning the life of Jacopo Bellini which can be gathered from printed and documentary records. The materials which have reached posterity for a critical judgment on his work consist of four or five pictures only, together with two important and invaluable books of drawings. These prove him to have been a worthy third, following the Umbrian Gentile da Fabriano and the Veronese Pisanello, in that trio of remarkable artists who in the first half of the 15th century carried towards maturity the art of painting in Venice and the neighbouring cities. Of his pictures, an important signed example is a life-size Christ Crucified in the archbishop's

palace at Verona. The rest are almost all Madonnas: two signed, one in the Tadini gallery at Lovere, another in the Venice academy; a third, unsigned and long ascribed in error to Gentile da Fabriano, in the Louvre, with the portrait of Sigismondo Malatesta as donor; a fourth, richest of all in colour and ornamental detail, recently acquired from private hands for the Uffizi at Florence. Plausibly, though less certainly, ascribed to him are a fifth Madonna at Bergamo, a warrior-saint on horseback (San Crisogono) in the church of San Trovaso at Venice, a Crucifixion in the Museo Correr, and an Adoration of the Magi in private possession at Ferrara. Against this scanty tale of paintings we have to set an abundance of drawings and studies preserved in two precious albums in the British Museum and the Louvre. The former, which is the earlier in date, belonged to the painter's elder son Gentile and was by him bequeathed to his brother Giovanni. It consists of ninety-nine paper pages, all drawn on both back and front with a lead point, an instrument unusual at this date. Two or three of the drawings have been worked over in pen; of the remainder many have become dim from time and rubbing. The album at the Louvre, discovered in 1883 in the loft of a country-house in Guienne, is equally rich and better preserved, the drawings being all highly finished in pen, probably over effaced preliminary sketches in chalk or lead. The range of subjects is much the same in both collections, and in both extremely varied, proving Jacopo to have been a craftsman of many-sided curiosity and invention. He passes indiscriminately from such usual Scripture scenes as the Adoration of the Magi, the Agony in the Garden, and the Crucifixion, to designs from classic fable, copies from ancient bas-reliefs, stories of the saints, especially St Christopher and St George, the latter many times repeated (he was the patron saint of the house of Este), fanciful allegories of which the meaning has now become obscure, scenes of daily life, studies for monuments, and studies of animals, especially of eagles (the emblem of the house of Este), horses and lions. He loves to marshal his figures in vast open spaces, whether of architecture or mountainous landscape. In designing such spaces and in peopling them with figures of relatively small scale, we see him eagerly and continually putting to the test the principles of the new science of perspective. His castellated and pinnacled architecture, in a mixed medieval and classical spirit, is elaborately thought out, and scarcely less so his groups and ranges of barren hills, broken in clefts or ascending in spiral terraces. With a predilection for tall and slender proportions, he draws the human figure with a flowing generalized grace and no small freedom of movement; but he does not approach either in mastery of line or in vehemence of action a Florentine draughtsman such as Antonio Pollaiuolo. Jacopo's influence on the development of Venetian art was very great, not only directly through his two sons and his son-in-law Mantegna, but through other and independent contemporary workshops of the city, in none of which did it remain unfelt.

II. GENTILE BELLINI (1420-1430-1507), the elder son of Jacopo, first appears independently as the painter of a Madonna, much in his father's manner, dated 1460, and now in the Berlin museum. We have seen how in the previous year he and his brother assisted their father in the execution of an altar-piece for the Santo at Padua. In July 1466 we find him contracting with the officers of the Scuola of St Mark as an independent artist to decorate the doors of their organ. These paintings still exist in a blackened condition. They represent four saints, colossal in size, and designed with much of the harsh and searching austerity which characterized the Paduan school under Squarcione. In December of the same year Gentile bound himself to execute for the great hall of the same company two subjects of the Exodus, to be done better than, or at least as well as, his father's work in the same place. These paintings have perished. For the next eight years the history of Gentile's life and work remains obscure. But he must have risen steadily in the esteem of his fellow-citizens, since in 1474 we find him commissioned by the senate to restore, renew, and when necessary replace, the series of paintings, the work of an earlier generation of artists, which were perishing from damp on the walls of the Hall of the

Great Council in the ducal palace. This was evidently intended to be a permanent employment, and in payment the painter was to receive the reversion of a broker's stall in the Fondaco dei Tedeschi; a lucrative form of sinecure frequently allotted to artists engaged for tasks of long duration. In continuation of this work Gentile undertook a series of independent paintings on subjects of Venetian history for the same hall, but had apparently only finished one, representing the delivery of the consecrated candle by the pope to the doge, when his labours were interrupted by a mission to the East. The sultan Mahommed II. had despatched a friendly embassy to Venice, inviting the doge to visit him at Constantinople and at the same time requesting the despatch of an excellent painter to work at his court. The former part of the sultan's proposal the senate declined, with the latter they complied; and Gentile Bellini with two assistants was selected for the mission, his brother Giovanni being at the same time appointed to fill his place on the works for the Hall of the Great Council. Gentile gave great satisfaction to the sultan, and returned after about a year with a knighthood, some fine clothes, a gold chain and a pension. The surviving fruits of his labours at Constantinople consist of a large painting representing the reception of an ambassador in that city, now in the Louvre; a highly finished portrait of the sultan himself, now one of the treasures, despite its damaged condition, of the collection of the late Sir Henry Layard; an exquisitely wrought small portrait in water-colour of a scribe, found in 1905 by a private collector in the bazaar at Constantinople and now in the collection of Mrs Gardner at Boston; and two pen-and-ink drawings of Turkish types, now in the British Museum. Early copies of two or three other similar drawings are preserved in the Städel Institute at Frankfurt; such copies may have been made for the use of Gentile's Umbrian contemporary, Pinturicchio, who introduced figures borrowed from them into some of his decorative frescoes in the Appartamento Borgia at Rome.

A place had been left open for Gentile to continue working beside his brother Giovanni (with whom he lived always on terms of the closest amity) in the ducal palace; and soon after 1480 he began to carry out his share in the great series of frescoes, unfortunately destroyed by fire in 1577, illustrating the part played by Venice in the struggles between the papacy and the emperor Barbarossa. These works were executed not on the wall itself but on canvas (the climate of Venice having so many times proved fatal to wall paintings), and probably in oil, a method which all the artists of Venice, following the example set by Antonello da Messina, had by this time learnt or were learning to practise. The subjects allotted to Gentile, in addition to the above-mentioned presentation of the consecrated candle, were as follows: the departure of the Venetian ambassadors to the court of Barbarossa, Barbarossa receiving the ambassadors, the pope inciting the doge and senate to war, the pope bestowing a sword and his blessing on the doge and his army (a drawing in the British Museum purports to be the artist's original sketch for this composition), and according to some authorities also the gift of the symbolic ring by the pope to the victorious doge on his return. These works received the highest praise both from contemporary and from later Venetian critics, but no fragment of them survived the fire of 1577. Their character can to some extent be judged by a certain number of kindred historical and processional works by the same hand which have been preserved. Of such the Academy at Venice has three which were painted between 1490 and 1500 for the Scuola of St John the Evangelist, and represent certain events connected with a famous relic belonging to the Scuola, namely, a supposed fragment of the true cross. All have been much injured and re-painted; nevertheless one at least, showing the procession of the relic through St Mark's Place and the thanksgiving of a father who owed to it the miraculous cure of his son, still gives a good idea of the painter's powers and style. Great accuracy and firmness of individual portraiture, a strong gift, derived no doubt from his father's example, for grouping and marshalling a crowd of personages in spaces of fine architectural perspective, the

severity and dryness of the Paduan manner much mitigated by the dawning splendour of true Venetian colour—these are the qualities that no injury has been able to deface. They are again manifest in an interesting Adoration of the Magi in the Layard collection; and reappear still more forcibly in the last work undertaken by the artist, the great picture now at the Brera in Milan of St Mark preaching at Alexandria; this was commissioned by the Scuola of St Mark in March 1505, and left by the artist in his will, dated 18th of February 1507, to be finished by his brother Giovanni. Of single portraits by this artist, who was almost as famous for them as for processional groups, there survive one of a doge at the Museo Corner in Venice, one of Catarina Comaro at Budapest, one of a mathematician at the National Gallery, another of a monk in the same gallery, signed wrongly to all appearance with the name of Giovanni Bellini, besides one or two others in private hands. The features of Gentile himself are known from a portrait medallion by Camello, and can be recognized in two extant drawings, one at Berlin supposed to be by the painter's own hand, and another, much larger and more finished, at Christ Church, Oxford, which is variously attributed to Bonsignori and A. Vivarini.

III. GIOVANNI BELLINI (1430-1431-1516) is generally assumed to have been the second son of Jacopo by his wife Anna; though the fact that she does not mention him in her will with her other sons has thrown some slight doubt upon the matter. At any rate he was brought up in his father's house, and always lived and worked in the closest fraternal relation with Gentile. Up till the age of nearly thirty we find documentary evidence of the two sons having served as their father's assistants in works both at Venice and Padua. In Giovanni's earliest independent works we find him more strongly influenced by the harsh and searching manner of the Paduan school, and especially of his own brother-in-law Mantegna, than by the more graceful and facile style of Jacopo. This influence seems to have lasted at full strength until after the departure of his brother-in-law Mantegna for the court of Mantua in 1460. The earliest of Giovanni's independent works no doubt date from before this period. Three of these exist at the Correr museum in Venice: a Crucifixion, a Transfiguration, and a Dead Christ supported by Angels. Two Madonnas of the same or even earlier date are in private collections in America, a third in that of Signor Frizzoni at Milan; while two beautiful works in the National Gallery of London seem to bring the period to a close. One of these is of a rare subject, the Blood of the Redeemer; the other is the fine picture of Christ's Agony in the Garden, formerly in the Northbrook collection. The last-named piece was evidently executed in friendly rivalry with Mantegna, whose version of the subject hangs near by; the main idea of the composition in both cases being taken from a drawing by Jacopo Bellini in the British Museum sketch-book. In all these pictures Giovanni combines with the Paduan severity of drawing and complex rigidity of drapery a depth of religious feeling and human pathos which is his own. They are all executed in the old *tempera* method; and in the last named the tragedy of the scene is softened by a new and beautiful effect of romantic sunrise colour. In a somewhat changed and more personal manner, with less harshness of contour and a broader treatment of forms and draperies, but not less force of religious feeling, are the two pictures of the Dead Christ supported by Angels, in these days one of the master's most frequent themes, at Rimini and at Berlin. Chronologically to be placed with these are two Madonnas, one at the church of the Madonna del Orto at Venice and one in the Lochis collection at Bergamo; devout intensity of feeling and rich solemnity of colour being in the case of all these early Madonnas combined with a singularly direct rendering of the natural movements and attitudes of children.

The above-named works, all still executed in *tempera*, are no doubt earlier than the date of Giovanni's first appointment to work along with his brother and other artists in the Scuola di San Marco, where among other subjects he was commissioned in 1470 to paint a Deluge with Noah's Ark. None of the master's works of this kind, whether painted for the various schools or

confraternities or for the ducal palace, have survived. To the decade following 1470 must probably be assigned a Transfiguration now in the Naples museum, repeating with greatly ripened powers and in a much serener spirit the subject of his early effort at Venice; and also the great altar-piece of the Coronation of the Virgin at Pesaro, which would seem to be his earliest effort in a form of art previously almost monopolized in Venice by the rival school of the Vivarini. Probably not much later was the still more famous altar-piece painted in *tempera* for a chapel in the church of S. Giovanni e Paolo, where it perished along with Titian's Peter Martyr and Tintoretto's Crucifixion in the disastrous fire of 1867. After 1479-1480 very much of Giovanni's time and energy must have been taken up by his duties as conservator of the paintings in the great hall of the ducal palace, in payment for which he was awarded, first the reversion of a broker's place in the *Fondaco dei Tedeschi*, and afterwards, as a substitute, a fixed annual pension of eighty ducats. Besides repairing and renewing the works of his predecessors he was commissioned to paint a number of new subjects, six or seven in all, in further illustration of the part played by Venice in the wars of Barbarossa and the pope. These works, executed with much interruption and delay, were the object of universal admiration while they lasted, but not a trace of them survived the fire of 1577; neither have any other examples of his historical and processional compositions come down, enabling us to compare his manner in such subjects with that of his brother Gentile. Of the other, the religious class of his work, including both altar-pieces with many figures and simple Madonnas, a considerable number have fortunately been preserved. They show him gradually throwing off the last restraints of the 15th-century manner; gradually acquiring a complete mastery of the new oil medium introduced in Venice by Antonello da Messina about 1473, and mastering with its help all, or nearly all, the secrets of the perfect fusion of colours and atmospheric gradation of tones. The old intensity of pathetic and devout feeling gradually fades away and gives place to a noble, if more worldly, serenity and charm. The enthroned Virgin and Child become tranquil and commanding in their sweetness; the personages of the attendant saints gain in power, presence and individuality; enchanting groups of singing and viol-playing angels symbolize and complete the harmony of the scene. The full splendour of Venetian colour invests alike the figures, their architectural framework, the landscape and the sky. The altar-piece of the Friar at Venice, the altar-piece of San Giobbe, now at the academy, the Virgin between SS. Paul and George, also at the academy, and the altar-piece with the kneeling doge Barbarigo at Murano, are among the most conspicuous examples. Simple Madonnas of the same period (about 1485-1490) are in the Venice academy, in the National Gallery, at Turin and at Bergamo. An interval of some years, no doubt chiefly occupied with work in the Hall of the Great Council, seems to separate the last-named altar-pieces from that of the church of San Zaccaria at Venice, which is perhaps the most beautiful and imposing of all, and is dated 1505, the year following that of Giorgione's Madonna at Castelfranco. Another great altar-piece with saints, that of the church of San Francesco de la Vigna at Venice, belongs to 1507; that of La Corona at Vicenza, a Baptism of Christ in a landscape, to 1510; to 1513 that of San Giovanni Crisostomo at Venice, where the aged saint Jerome, seated on a hill, is raised high against a resplendent sunset background, with SS. Christopher and Augustine standing facing each other below him, in front. Of Giovanni's activity in the interval between the altar-pieces of San Giobbe and of Murano and that of San Zaccaria, there are a few minor evidences left, though the great mass of its results perished with the fire of the ducal palace in 1577. The examples that remain consist of one very interesting and beautiful allegorical picture in the Uffizi at Florence, the subject of which had remained a riddle until it was recently identified as an illustration of a French medieval allegory, the *Pèlerinage de l'âme* by Guillaume de Guilleville; with a set of five other allegories or moral emblems, on a smaller scale and very romantically treated, in the academy at Venice. To these should probably be added, as painted

towards the year 1505, the portrait of the doge Loredano in the National Gallery, the only portrait by the master which has been preserved, and in its own manner one of the most masterly in the whole range of painting.

The last ten or twelve years of the master's life saw him beset with more commissions than he could well complete. Already in the years 1501-1504 the marchioness Isabella Gonzaga of Mantua had had great difficulty in obtaining delivery from him of a picture of the "Madonna and Saints" (now lost) for which part payment had been made in advance. In 1505 she endeavoured through Cardinal Bembo to obtain from him another picture, this time of a secular or mythological character. What the subject of this piece was, or whether it was actually delivered, we do not know. Albrecht Dürer, visiting Venice for a second time in 1506, reports of Giovanni Bellini as still the best painter in the city, and as full of all courtesy and generosity towards foreign brethren of the brush. In 1507 Gentile Bellini died, and Giovanni completed the picture of the "Preaching of St Mark" which he had left unfinished; a task on the fulfilment of which the bequest by the elder brother to the younger of their father's sketch-book had been made conditional. In 1513 Giovanni's position as sole master (since the death of his brother and of Alvise Vivarini) in charge of the paintings in the Hall of the Great Council was threatened by an application on the part of his own former pupil, Titian, for a joint-share in the same undertaking, to be paid for on the same terms. Titian's application was first granted, then after a year rescinded, and then after another year or two granted again; and the aged master must not doubt have undergone some annoyance from his sometime pupil's proceedings. In 1514 Giovanni undertook to paint a Bacchanal for the duke Alfonso of Ferrara, but died in 1516, leaving it to be finished by his pupils; this picture is now at Alnwick.

Both in the artistic and in the worldly sense, the career of Giovanni Bellini was upon the whole the most serenely and unbrokenly prosperous, from youth to extreme old age, which fell to the lot of any artist of the early Renaissance. He lived to see his own school far outshine that of his rivals, the Vivarini of Murano; he embodied, with ever growing and maturing power, all the devotional gravity and much also of the worldly splendour of the Venice of his time; and he saw his influence propagated by a host of pupils, two of whom at least, Giorgione and Titian, surpassed their master. Giorgione he outlived by five years; Titian, as we have seen, challenged an equal place beside his teacher. Among the best known of his other pupils were, in his earlier time, Andrea Previtali, Cima da Conegliano, Marco Basaiti, Niccolò Rondinelli, Piermaria Pennacchi, Martino da Udine, Girolamo Mocetto; in later time, Pierfrancesco Bissolo, Vincenzo Catena, Lorenzo Lotto and Sebastian del Piombo.

BIBLIOGRAPHY.—Vasari, ed. Milanesi, vol. iii.; Ridolfi, *Le Maraviglie*, &c., vol. i.; Francesco Sansovino, *Venezia Descritta*; Morelli, *Notizia*, &c., di un Anonimo; Zanetti, *Pittura Veneziana*; F. Aglietti, *Elogio Storico di Jacopo e Giovanni Bellini*; G. Bernasconi, *Cenni intorno la vita e le opere di Jacopo Bellini*; Moschini, *Giovanni Bellini e pittori contemporanei*; E. Galichon in *Gazette des beaux-arts* (1866); Crowe and Cavalcaselle, *History of Painting in North Italy*, vol. i.; Hubert Janitschek, "Giovanni Bellini" in *Dohme's Kunst und Künstler*; Julius Meyer in Meyer's *Allgemeines Künstler-Lexikon*, vol. iii. (1885); Pompeo Molmenti, "I pittori Bellini" in *Studi e ricerche di Storia d'Arte*; P. Paoletti, *Raccolta di documenti inediti*, fasc. 1.; Vasari, *Vite di Gentile da Fabriano e Vittor Pisanello*, ed. Venturi; Corrado Ricci in *Rassegna d'Arte* (1901, 1903), and *Rivista d'Arte* (1906); Roger Fry, *Giovanni Bellini* in "The Artists' Library"; Everett Meynell, *Giovanni Bellini* in Newnes's "Art Library" (useful for a nearly complete set of reproductions of the known paintings); Corrado Ricci, *Jacopo Bellini e i suoi Libri di Disegni*; Victor Goloubeff, *Les Dessins de Jacopo Bellini* (the two works last cited reproduce in full, that of M. Goloubeff by far the most skillfully, the contents of both the Paris and the London sketch-books). (S. C.)

BELLINI, LORENZO (1643-1704), Italian physician and anatomist, was born at Florence on the 3rd of September 1643. At the age of twenty, when he had already begun his researches on the structure of the kidneys and had described the ducts known by his name (*Exercitatio anatomica de structura et usu*

renum, 1662), he was chosen professor of theoretical medicine at Pisa, but soon after was transferred to the chair of anatomy. After spending thirty years at Pisa, he was invited to Florence and appointed physician to the grand duke Cosimo III., and was also made senior consulting physician to Pope Clement XI. He died at Florence on the 8th of January 1704. His works were published in a collected form at Venice in 1708.

BELLINI, VINCENZO (1801-1853), operatic composer of the Italian school, was born at Catania in Sicily, on the 1st of November 1801. He was descended from a family of musicians, both his father and grandfather having been composers of some reputation. After having received his preparatory musical education at home, he entered the conservatoire of Naples, where he studied singing and composition under Tritto and Zingarelli. He soon began to write pieces for various instruments, as well as a cantata and several masses and other sacred compositions. His first opera, *Adelson e Salvini*, was performed in 1825 at a small theatre in Naples; his second dramatic work, *Bianca e Fernando*, was produced next year at the San Carlo theatre of the same city, and made his name known in Italy. His next work, *Il Pirata* (1827), was written for the Scala in Milan, to words by Felice Romano, with whom Bellini formed a union of friendship to be severed only by his death. The splendid rendering of the music by Tamburini, Rubini and other great Italian singers contributed greatly to the success of the work, which at once established the European reputation of its composer. In almost every year of the short remainder of his life he produced a new operatic work, which was received with rapture by the audiences of France, Italy, Germany and England. The names and dates of four of Bellini's operas familiar to most lovers of Italian music are: *I Montecchi e Capuleti* (1830), in which the part of Romeo became a favourite with all the great contraltos; *La Sonnambula* (1831); *Norma*, Bellini's best and most popular creation (1831); and *I Puritani* (1835), written for the Italian opera in Paris, and to some extent under the influence of French music. In 1833 Bellini had left his country to accompany to England the singer Pasta, who had created the part of his *Sonnambula*. In 1834 he accepted an invitation to write an opera for the national grand opera in Paris. While he was carefully studying the French language and the cadence of French verse for the purpose, he was seized with a sudden illness and died at his villa in Puteaux near Paris on the 24th of September 1835. His operatic creations are throughout replete with a spirit of gentle melancholy, frequently monotonous and almost always undramatic, but at the same time irresistibly sweet. To this spirit, combined with a rich flow of *cantilena*, Bellini's operas owe their popularity. "I will never forget," wrote Wagner, "the impression made upon me by an opera of Bellini at a period when I was completely exhausted with the ever-lasting abstract complication used in our orchestras, when a simple and noble melody was revealed anew to me."

See also G. Labat, *Bellini* (Bordeaux, 1865); A. Pougin, *Bellini, sa vie et ses œuvres* (Paris, 1868).

BELLINZONA (Ger. *Bellens*), the political capital of the Swiss canton of Tessin or Ticino. It is 105 m. from Lucerne by the St Gotthard railway, 19 m. from Lugano and 14 m. from Locarno at the head of the Lago Maggiore, these two towns having been till 1881 capitals of the canton jointly with Bellinzona. The old town is built on some hills, on the left bank of the Tessin or Ticino river, and a little below the junction of the main Ticino valley (the Val Leventina) with that of Mesocco. It thus blocked the road from Germany to Italy, while a great wall was built from the town to the river bank. Bellinzona still possesses three picturesque castles (restored in modern times), dating in their present form from the 15th century. They belonged for several centuries to the three Swiss cantons which were masters of the town. The most westerly, Castello Grande or of San Michele, belonged to Uri; the central castle, that of Montebello, was the property of Schwyz; while the most easterly castle, that of Sasso Corbaro, was in the hands of Unterwalden. The 13th-century church of San Biagio (Blaise) has a remarkable 14th-century fresco, while the collegiate church of

San Stefano dates from the 16th century. In 1900 the population of Bellinzona was 4949, practically all Romanists and Italian-speaking.

Possibly Bellinzona is of Roman origin, but it is first mentioned in 590. It played a considerable part in the early history of Lombardy, being a key to several Alpine passes. In the 8th century it belonged to the bishop of Como, while in the 13th and 14th centuries it was tossed to and fro between the cities of Milan and Como. In 1402 it was taken from Milan by Albert von Sax, lord of the Val Mesocco, who in 1419 sold it to Uri and Obwalden, which, however, lost it to Milan in 1422 after the battle of Arbedo. In 1499 (like the rest of the Milanese) it was occupied by the French, but in 1500 it was taken by Uri. In 1503 the French king ceded it to Uri, Schwyz and Unterwalden, which henceforth ruled it very harshly through their bailiffs till 1798. At that date it became the capital of the canton Bellinzona of the Helvetic republic, but in 1803 it was united to the newly-formed canton of Tessin. (W. A. B. C.)

BELLMAN, KARL MIKAEL (1740-1795), Swedish poet, son of a civil servant, was born at Stockholm on the 4th of February 1740. When quite a child he developed an extraordinary gift of improvising verse, during the delirium of a severe illness, weaving wild thoughts together lyrically and singing airs of his own composition. When he was nineteen he became clerk in a bank and afterwards in the customs, but his habits were irregular and he was frequently in great distress, particularly after the death of his patron, Gustavus III. As early as 1757 he published *Evangeliska Dödstanor*, meditations on the Passion from the German of David von Schweidnitz, and during the next few years wrote, besides other translations, a great quantity of poems, imitative for the most part of Dalin. In 1760 appeared his first characteristic work, *Månan* (The Moon), a satirical poem, which was revised and edited by Dalin. But the great work of his life occupied him from 1765 to 1780, and consists of the collections of dithyrambic odes known as *Fredmans Epistlar* (1790) and *Fredmans Sångar* (1791). Fredman and his friends were well-known characters in the Stockholm pot-houses, where Bellman had studied them from the life. No poetry can possibly smell less of the lamp than Bellman's. He was accustomed, when in the presence of none but confidential friends, to announce that the god was about to visit him. He would shut his eyes, take his zither, and begin apparently to improvise the music and the words of a long Bacchic ode in praise of love or wine. Most of his melodies are taken direct, or with slight adaptations, from old Swedish ballads, and still retain their popularity. *Fredman's Epistles* bear the clear impress of individual genius; his torrents of rhymes are not without their method; wild as they seem, they all conform to the rules of style, and among those that have been preserved there are few that are not perfect in form. A great Swedish critic has remarked that the voluptuous joviality and the humour of Bellman is, after all, only "sorrow clad in rose-colour," and this underlying pathos gives his poems their undying charm. His later works, *Bacchi Tempel* (The Temple of Bacchus) (1783), eight numbers of a journal called *Hvad behagast?* (What you Will) (1781), in 1780 a religious anthology entitled in a later edition (1787) *Zions Högtid* (Zion's Holiday), and a translation of Gellert's *Fables*, are comparatively unimportant. He died on the 11th of February 1795. Much of Bellman's work was only printed after his death, *Bihang till Fredmans Epistlar* (Nyköping, 1800), *Fredmans Handskrifter* (Upsala, 1813), *Skaldestycken* ("Poems," Stockholm, 1814) being among the most important of these posthumous works. A colossal bronze bust of the poet by Byström (erected by the Swedish Academy in 1829) adorns the public gardens of Stockholm, and a statue by Alfred Nyström is in the Hasselbacken, Stockholm. Bellman had a grand manner, a fine voice and great gifts of mimicry, and was a favourite companion of King Gustavus III.

The best edition of his works was published at Stockholm, edited by J. G. Carlén, with biographical notes, illustrations and music (5 vols., 1856-1861); see also monographs on Bellman by Nils Erdmann (Stockholm, 1895) and by F. Niedner (Berlin, 1905).

BELLO, ANDRÉS (1781-1865), South American poet and scholar, was born at Caracas (Venezuela) on the 29th of November 1781, and in early youth held a minor post in the civil administration. He joined the colonial revolutionary party, and in 1810 was sent on a political mission to London, where he resided for nineteen years, acting as secretary to the legations of Chile, Colombia and Venezuela, studying in the British Museum, supplementing his small salary by giving private lessons in Spanish, by journalistic work and by copying Jeremy Bentham's almost indecipherable manuscripts. In 1829 he accepted a post in the Chilean treasury, settled at Santiago and took a prominent part in founding the national university (1843), of which he became rector. He was nominated senator, and died at Santiago de Chile on the 15th of October 1865. Bello was mainly responsible for the civil code promulgated on the 14th of December 1855. His prose works deal with such various subjects as law, philosophy, literary criticism and philology; of these the most important is his *Gramática castellana* (1847), the leading authority on the subject. But his position in literature proper is secured by his *Silvas Americanas*, a poem written during his residence in England, which conveys with extraordinary force the majestic impression of the South American landscape.

Bello's complete works were issued in fifteen volumes by the Chilean government (Santiago de Chile, 1881-1893); he is the subject of an excellent biography (Santiago de Chile, 1882) by Miguel Luis Amunátegui. (J. F. K.)

BELLO-HORIZONTE, or MINAS, a city of Brazil, capital of the state of Minas Graes since 1898, about 50 m. N.W. of Ouro Preto, connected with the Central of Brazil railway by a branch line 9 m. in length. Pop. (estimated) in 1906, 25,000 to 30,000. The city was built by the state on an open plateau, and provided with all necessary public buildings, gas, water and tramway services before the seat of government was transferred from Ouro Preto. The cost of transfer was about £1,000,000. The city has grown rapidly, and is considered one of the most attractive state capitals of Brazil.

BELLONA (originally **DUELLONA**), in Roman mythology, the goddess of war (*bellum*, i.e. *duellum*), corresponding to the Greek Enyo. By later mythologists she is called sometimes the sister, daughter or wife of Mars, sometimes his charioteer or nurse. Her worship appears to have been promoted in Rome chiefly by the family of the Claudii, whose Sabine origin, together with their use of the name of "Nero," has suggested an identification of Bellona with the Sabine war goddess Nerio, herself identified, like Bellona, with Virtus. Her temple at Rome, dedicated by Appius Claudius Caecus (266 b.c.) during a battle with the Samnites and Etruscans (Ovid, *Fasti* vi. 201), stood in the Campus Martius, near the Flaminian Circus, and outside the gates of the city. It was there that the senate met to discuss a general's claim to a triumph, and to receive ambassadors from foreign states. In front of it was the *columna bellica*, where the ceremony of declaring war by the *fetialis* was performed. From this native Italian goddess is to be distinguished the Asiatic Bellona, whose worship was introduced into Rome from Comana, in Cappadocia, apparently by Sulla, to whom she had appeared, urging him to march to Rome and bathe in the blood of his enemies (Plutarch, *Sulla*, 9). For her a new temple was built, and a college of priests (*Bellonarii*) instituted to conduct her fanatical rites, the prominent feature of which was to lacerate themselves and sprinkle the blood on the spectators (Tibullus i. 6. 45-50). To make the scene more grim they wore black dresses (Tertullian, *De Pallio*) from head to foot. The festival of Bellona, which originally took place on the 3rd of June, was altered to the 24th of March, after the confusion of the Roman Bellona with her Asiatic namesake.

See Tiesler, *De Bellonae Cultu* (1842).

BELLOT, JOSEPH RENÉ (1826-1853), French Arctic explorer, was born at Rochefort on the 18th of March 1826, the son of a farmer. With the aid of the authorities of his native town he was enabled at the age of fifteen to enter the naval school, in which he studied two years and earned a high reputation. He

then took part in the Anglo-French expedition of 1845 to Madagascar, and received the cross of the Legion of Honour for distinguished conduct. He afterwards took part in another Anglo-French expedition, that of Parana, which opened the river La Plata to commerce. In 1851 he joined the Arctic expedition under the command of Captain Kennedy in search of Sir John Franklin, and discovered the strait between Boothia Felix and Somerset Land which bears his name. Early in 1852 he was promoted lieutenant, and in the same year accompanied the Franklin search expedition under Captain Ingfield. As on the previous occasion, his intelligence, devotion to duty and courage won him the esteem and admiration of all with whom he was associated. While making a perilous journey with two comrades for the purpose of communicating with Sir Edward Belcher, he suddenly disappeared in an opening between the broken masses of ice (August 1853). A pension was granted to his family by the emperor Napoleon III., and an obelisk was erected to his memory in front of Greenwich hospital.

BELLOWS, ALBERT F. (1829-1883), American landscape-painter, was born at Milford, Massachusetts, on the 20th of November 1829. He first studied architecture, then turned to painting, and worked in Paris and in the Royal Academy at Antwerp. He painted much in England; was a member of the National Academy of Design, and of the American Water Color Society, New York; and an honorary member of the Royal Belgian Society of Water-Colourists. His earlier work was *genre*, in oils; after 1865 he used water-colours more and more exclusively and painted landscapes. Among his water-colours are "Afternoon in Surrey" (1868); "Sunday in Devonshire" (1876), exhibited at the Philadelphia Exposition; "New England Village School" (1878); and "The Parsonage" (1879). He died in Auburndale, Massachusetts, on the 24th of November 1883.

BELLOWS, HENRY WHITNEY (1814-1882), American clergyman, was born in Boston, Massachusetts, on the 11th of June 1814. He graduated at Harvard College in 1832, and at the Harvard Divinity School in 1837, held a brief pastorate (1837-1838) at Mobile, Alabama, and in 1839 became pastor of the First Congregational (Unitarian) church in New York City (afterwards All Souls church), in charge of which he remained until his death. Here Bellows acquired a high reputation as a pulpit orator and lyceum lecturer, and was a recognized leader in the Unitarian Church in America. For many years after 1846 he edited *The Christian Inquirer*, a Unitarian weekly paper, and he was also for some time an editor of *The Christian Examiner*. In 1857 he delivered a series of lectures in the Lowell Institute course, on "The Treatment of Social Diseases." At the outbreak of the Civil War he planned the United States Sanitary Commission, of which he was the first and only president (1861 to 1878). He was the first president of the first Civil Service Reform Association organized in the United States (1877), was an organizer of the Union League Club and of the Century Association in New York City, and planned with his parishioner and friend, Peter Cooper, the establishment of Cooper Union. In 1865 he proposed and organized the national conference of Unitarian and other Christian churches, and from 1865 to 1880 was chairman of its council. He died in New York City on the 30th of January 1882. A bronze memorial tablet by Augustus Saint Gaudens was unveiled in All Souls church in 1886. His published writings include *Restatements of Christian Doctrine in Twenty-Five Sermons* (1860); *Unconditioned Loyalty* (1863), a strong pro-Union sermon, which was widely circulated during the Civil War; *The Old World in its New Face: Impressions of Europe in 1867-1868* (2 vols., 1868-1869); *Historical Sketch of the Union League Club* (1879); and *Twenty-Four Sermons in All Souls Church, New York, 1865-1881* (1886).

See Russell N. Bellows, *Henry Whitney Bellows* (Keene, N.H., 1897), a biographical sketch reprinted from P. B. Peck's *Bellows Family Genealogy*; John White Chadwick, *Henry W. Bellows: His Life and Character* (New York, 1882), a memorial address; and Charles J. Stillé, *History of the United States Sanitary Commission* (Philadelphia, 1866).

BELLOWS and **BLOWING MACHINES**, appliances used for producing currents of air, or for moving volumes of air from one

place to another. Formerly all such artificially-produced currents of air were used to assist the combustion of fires and furnaces, but now this purpose only forms a part of the uses to which they are put. Blowing appliances, among which are included bellows, rotary fans, blowing engines, rotary blowers and steam-jet blowers, are now also employed for forcing pure air into buildings and mines for purposes of ventilation, for withdrawing vitiated air for the same reason, and for supplying the air or other gas which is required in some chemical processes. Appliances of this kind differ from *air compressors* in that they are primarily intended for the transfer of quantities of air at low pressures, very little above that of the atmosphere, whereas the latter are used for supplying air which has previously been raised to a pressure which may be many times that of the atmosphere (see **POWER TRANSMISSION: Pneumatic**).

Among the earliest contrivances employed for producing the movement of air under a small pressure were those used in Egypt during the Greek occupation. These depended upon the heating of the air, which, being raised in pressure and bulk, was made to force water out of closed vessels, the water being afterwards employed for moving some kind of mechanism. In the process of iron smelting there is still used in some parts of India an artificial blast, produced by a simple form of bellows made from the skins of goats; bellows of this kind probably represent one of the earliest contrivances used for producing currents of air.

The bellows' now in use consists, in its simplest form, of two flat boards, of rectangular, circular or pear shape, connected round their edges by a wide band of leather so as to include an air chamber, which can be increased or diminished in volume by separating the boards or bringing them nearer together. The leather is kept from collapsing, on the separation of the boards, by several rings of wire which act like the ribs of animals. The lower board has a hole in the centre, covered inside by a leather flap or valve which can only open inwards; there is also an open outlet, generally in the form of a pipe or nozzle, whose aperture is much smaller than that of the valve. When the upper board is raised air rushes into the cavity through the valve to fill up the partial vacuum produced; on again depressing the upper board the valve is closed by the air attempting to rush out again, and this air is discharged through the open nozzle with a velocity depending on the pressure exerted.

The current of air produced is evidently not continuous but intermittent or in puffs, because an interval is needed to refill the cavity after each discharge. In order to remedy this drawback the *double bellows* are used. To understand their action it is only necessary to conceive an additional board with valve, like the lower board of the single bellows, attached in the same way by leather below this lower board. Thus there are three boards, forming two cavities, the two lower boards being fitted with air-valves. The lowest board is held down by a weight and another weight rests on the top board. In working these double bellows the lowest board is raised, and drives the air from the lower cavity into the upper. On lowering the bottom board again a fresh supply of air is drawn in through the bottom valve, to be again discharged when the board is raised. As the air passes from the lower to the upper cavity it is prevented from returning by the valve in the middle board, and in this way a quantity of air is sent into the upper cavity each time the lowest board is raised. The weight on the top board provides the necessary pressure for the blast, and at the same time causes the current of air delivered to be fairly continuous. When the air is being forced into the upper cavity the weight is being

1 The Old English word for this appliance was *blistbaelig*, i.e. "blow-bag," cf. German *Blasebalg*. By the 11th century the first part of the word apparently dropped out of use, and *baelig*, *byelig*, *bag*, is found in early glossaries as the equivalent of the Latin *foliis*. *Baelig* became in Middle English *bely*, i.e. "belly," a sack or bag, and so the general word for the lower part of the trunk in man and animals, the stomach, and another form, probably northern in origin, *belly*, *belva*, became the regular word for the appliance, the plural "bellows" being still used till the 16th century, when "bellows" appears, and the word in the singular ceases to be used. The verb "to bellow" of the roar of a bull, or the low of a cow, is from Old English *bellan*, to bell, roar.

raised, and, during the interval when the lowest board is descending, the weight is slowly forcing the top board down and thus keeping up the flow of air.

Hand-bellows for domestic use are generally shaped like a pear, with the hinge at the narrow end. The same shape was adopted for the older forms of smiths' bellows, with the difference that two bellows were used superposed, in a manner similar to that just described, so as to provide for a continuous blast. In the later form of smiths' bellows the same principle is employed, but the boards are made circular in shape and are always maintained roughly parallel to one another. These are shown on figs. 1 and 2. Here A is the blast pipe, B the movable lowest board,

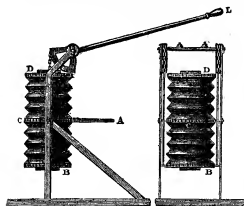

Figs. 1 and 2.—Common Smiths' Bellows.

C the fixed middle board, close to which the pipe A is inserted, and D is the movable uppermost board pressed upon by the weight shown. The board B is raised by means of a hand lever L, through either a chain or a connecting rod, and lowered by a weight. The size of the weight on D depends on the air pressure required. For instance, if a blast pressure of half a pound per square inch is wanted and the boards are 18 in. in diameter, and therefore have an area of 254 sq. in., on each of the 254 sq. in. there is to be a pressure of half a pound, so that the weight to balance this must be half multiplied by 254, or 127 lb. The diameter of the air-pipe can be varied to suit the required conditions. Instead of bellows with flexible sides, a sliding arrangement is sometimes used; this consists of what are really two boxes fitting into one another with the open sides both facing inwards, as if one were acting as a lid to the other. By having a valve and outlet pipe fitted as in the bellows and sliding them alternately apart and together, an intermittent blast is produced. The chief defect of this arrangement is the leakage of air caused by the difficulty in making the joint a sufficiently good fit to be air-tight.

Blowing Engines.—Where larger quantities of air at higher pressures than can conveniently be supplied by bellows are required, as for blast furnaces and the Bessemer process of steel-making, what are termed "blowing engines" are used. The mode of action of a blowing engine is simple. When a piston, accurately fitting a cylinder which has one end closed, is forcibly moved towards the other end, a partial vacuum is formed between the piston and the blank end, and if this space be allowed to communicate with the outer atmosphere air will flow in to fill the vacuum. When the piston has completed its movement or "stroke," the cylinder will have been filled with air. On the return of the piston, if the valve through which the air entered is now closed and a second one communicating with a chamber or pipe is opened, the air in the cylinder is expelled through this second valve. The action is similar to that of the bellows, but is carried out in a machine which is much better able to resist higher pressures and which is more convenient for dealing with large quantities of air. The valves through which the atmosphere or "free" air is admitted are called "admission" or "suction" valves, and those through which the air is driven from the cylinder are the "discharge" or "delivery" valves. Formerly one side only of the blowing piston was used, the engine working "single-acting"; but now both sides of the piston are utilized, so that when it is moving in either direction suction will be taking place on one side and delivery on the other. All processes in connexion with which

blowing engines are used require the air to be above the pressure of the outer atmosphere. This means that the discharge valves do not open quite at the beginning of the delivery stroke, but remain closed until the air in the cylinder has been reduced in volume and so increased in pressure to that of the air in the discharge chamber.

The power used to actuate these blowing-engines is in most cases steam, the steam cylinder being placed in line or "tandem" with the air cylinder, so that the steam piston rod is continuous with or directly joined to the piston rod of the air cylinder. This plan is always adopted where the cylinders are placed horizontally, and often in the case of vertical engines. The engines are generally built in pairs, with two blowing cylinders and one high-pressure and one low-pressure steam cylinder, the piston rods terminating in connecting rods which are attached to the pins of the two cranks on the shaft. In the centre of this shaft, midway between the two engines, there is usually placed a heavy flywheel which helps to maintain a uniform speed of turning. Some of the largest blowing engines built in Great Britain are arranged as beam engines; that is to say, there is a heavy rocking beam of cast iron which in its middle position is horizontal. One end of this beam is linked by a short connecting rod to the end of the piston rod of the blowing cylinder, while the other end is similarly linked to the top of the steam piston rod, so that as the steam piston comes up the air piston goes down and *vice versa*. At the steam end of the beam a third connecting rod works the crank of a flywheel shaft.

About the end of the 19th century an important development took place which consisted in using the waste gas from blast furnaces to form with air an explosive mixture, and employing this mixture to drive the piston of the actuating cylinder in precisely the same manner as the explosive mixture of coal gas and air is used in a gas engine. Since the majority of blowing engines are used for providing the air required in iron blast furnaces, considerable saving should be effected in this way, because the gas which escapes from the top of the furnace is a waste product and costs nothing to produce.

The general action of a blowing engine may be illustrated by the sectional view shown on fig. 3, which represents the

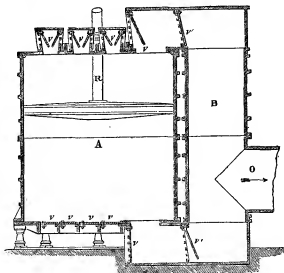

Fig. 3.—Section of Cylinder of Early Blowing Engine (1851).

internal view of one of the blowing cylinders of the engines erected at the Downliss Ironworks as far back as 1851. Many of the details are now obsolete, but the general scheme is the same as in all blowing engines. Here A is the air cylinder; in this is a piston whose rod is marked R; this piston is usually made air-tight by some form of packing fitted into the groove which runs round its edge. In this particular case the cylinder is placed vertically and its piston rod is actuated from the end of a rocking beam. The top and bottom ends are closed by covers and in these

are a number of openings controlled by valves opening inwards so that air can flow freely in but cannot return. The piston is shown moving downwards. Air is now being drawn into the space above the piston through the valves *v* at the top, and the air in the space *A* below the piston, drawn in during the previous up-stroke, is being expelled through the valve *v'* into the discharge chamber *B*, thence passing to the outlet pipe *O*. The action is reversed on the up-stroke. Thus it will be seen that air is being delivered both during the up-stroke and the down-stroke, and therefore flows almost continuously to the furnaces. There must, however, be momentary pauses at the ends of the strokes when the direction of movement is changed, and as the piston, though worked from an evenly rotating crank shaft, moves more quickly at the middle and slows down to no speed at the ends of its travel, there must be a considerable variation in the speed of

and *C*, the low-pressure one, are placed in tandem with the air cylinders *B*, *B*, whose pistons they actuate. In these blowing cylinders the inlet valves in the bottom are circular disk valves of leather, eighteen in number; the inlet valves *T* on the top of the cylinder are arranged in ten rectangular boxes, having openings in their vertical sides, inside which are hung leather flap valves. The outlet valves *O* are ten in number at each end of the cylinders, and are hung against flat gratings which are arranged round the circumference. The blast is delivered into a wrought iron casing *M* which surrounds the cylinder. The combined area of the inlet valves is 860 sq. in., or one-sixth the area of the piston. The speed is twenty-four revolutions per minute and the air delivered at this speed is 15,722 cubic ft. per minute, the horse-power in the air cylinders being 258. The circulating pump *E*, air pump *F*, and feed pumps *G*, *G*, are worked off the cross-hang on the low-pressure side.

A more modern form of blowing engine erected at the Dowlais works about the end of the 19th century, may be taken as typical of the present design of vertical blowing engine in use in Great Britain. The two air cylinders are placed below and in tandem with the steam cylinders as in the last case. The piston rods also terminate in connecting rods working on to the crank shaft. The air cylinders are each 88 in. in diameter, and the high and low pressure cylinders of the compound steam engine are 30 in. and 64 in. respectively, while the common stroke of all four is 60 in. The pressure of the air delivered varies from 4½ to 10 lb per sq. in. and the quantity per minute is 25,000 cub. ft. Each engine develops about 1200 horse-power. It is to be noted that flap valves such as those used in the 1851 Dowlais engine have in most cases given place to a larger number of circular steel disk valves, held to their seats by springs.

In a large blowing engine built in 1905 by Messrs Davy Bros. of Sheffield for the North-Eastern Steel Company at Middlesbrough (see *Engineering*, January 6, 1905) the same arrangement was adopted as in that just described. The two air cylinders are each 90 in. diameter and have a stroke of 72 in. The capacity of this engine is 52,000 cub. ft. of air per minute, delivered at a pressure of from 12½ to 15 lb per sq. in. when running at a speed of thirty-three revolutions per minute. The air valves consist of a large number of steel disks resting on circular seatings and held down by springs, which for the delivery valves are so adjusted in strength that they lift and release the air when the desired working pressure has been reached. It is worthy of note that in this engine no attempt is made to make the air pistons air-tight in the usual way by having packing rings set in grooves round the edge, but the piston is made deeper than usual and turned so as to be a very good fit in the cylinder and one or two small grooves are cut round the edge to hold the lubricant.

To illustrate a blowing engine driven by a gas engine supplied with blast furnace gas, fig. 5 gives a diagrammatic view of the blowing cylinder of an engine built by Messrs Richardson, Westgarth & Co. of Middlesbrough about 1905. The gas cylinder is not shown. It will be seen that the air cylinder is horizontal, and it is arranged to work in tandem with the gas motor cylinder. The chief point of interest is to be found in the arrangement of the details of the air cylinder. Its diameter is 86½ in. and the length of piston stroke 55 in. As to the arrangement of the valves, if the piston be moving in the direction shown, on the left side of the piston at *A* air is being discharged, and follows the course indicated by the arrows, so as first to pass into the annular chamber which forms a continuation of the

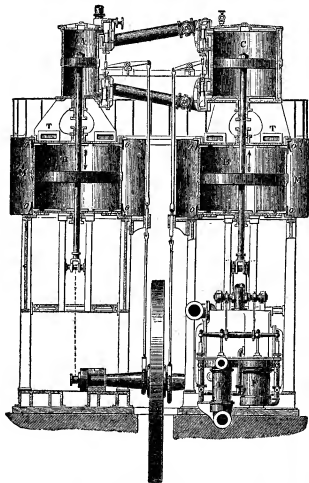

FIG. 4.—Vertical Section of Lackenby Blowing Engines (1871).

delivery of the air. The air is therefore led from *O* into a large storage chamber or reservoir, whence it is again taken to the furnace; if this reservoir is made sufficiently large the elasticity of the air in it will serve to compensate for the irregularities, and a nearly uniform stream of air will flow from it. The valves used in this case and in most of the older blowing engines consist of rectangular metal plates hinged at one of the longer edges; these plates are faced with leather or indiarubber so as to allow them to come to rest quietly and without clatter and at the same time to make them air-tight. It will be seen that some of these valves hang vertically and others lie flat on the bottom of the cover. The Dowlais cylinder is very large, having a diameter of 12 ft. and a piston stroke of 12 ft., giving a discharge of 44,000 cub. ft. of air per minute, at a pressure of 4½ lb to the square inch.

A later design of blowing engine, built in 1871 for the Lackenby iron-works, Middlesbrough, is shown in section in fig. 4, and is of a type which is still the most common, especially in the north of England. Here *A*, the high-pressure steam cylinder,

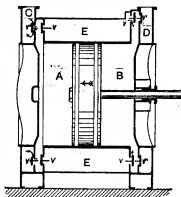

FIG. 5.—Richardson, Westgarth & Co.'s Blowing Engine.

space A, and thence, through the spring-controlled steel disk valves v' , into the discharge chamber C, which ultimately leads to the blast pipe. It will be seen that the valves v on the other side of the annular chamber are closed. At the same time a partial vacuum is being formed in the space B, to be filled by the inflow of air through the valves v which are now open, the corresponding discharge valves v' being closed. These valves on the inside and outside of the annular spaces referred to are arranged so as to form a circle round the ends of the barrel of the cylinder. The free air, instead of being drawn into the valves v direct from the air of the engine house, is taken from an enclosed annular chamber E, which may be in communication with the clean, cool air outside. It will be seen that the piston is made deep so as to allow for a long bearing surface in the cylinder. Two metal packing rings are provided to render the piston airtight. The horse-power of this engine, which is designed on the Cockerell system, is 750.

Air valves of other types than those which have been mentioned have been tried, such as sliding grid valves, rotatory slide valves and piston valves, but it has been found that either flap or disk lift valves are more satisfactory for air on account of the grit which is liable to get between slide valves and their seatings. In some of the blowing engines made by Messrs Fraser & Chalmers (see *Engineer*, June 15, 1906), sheets of flexible bronze act as flap valves both for admission and delivery, the part which actually closes the opening being thickened for strength.

The pressure of the air supplied by blowing engines depends upon the purposes for which it is to be used. In charcoal furnaces the pressure is very low, being less than 1 lb per sq. in.; for blast furnaces using coal an average value of 4 lb is common; for American blast furnaces using coke or anthracite coal the pressure is as high as 10 lb; while for the air required in the Bessemer process of steel-making pressures up to 25 or 30 lb per sq. in. are not uncommon. According to British practice one large blowing engine is used to supply several blast furnaces, while in America a number of smaller ones is used, one for each furnace.

Rotary blowers occupy a position midway between blowing engines and fan blowers, being used for purposes requiring the delivery of large volumes of air at pressures lower than those of blowing engines, but higher than those of fan blowers. The blowing engine draws in, compresses and delivers its air by the direct action of air-tight pistons; the same effect is aimed at in a rotary blower with the difference that the piston revolves instead of moving up and down a cylinder.

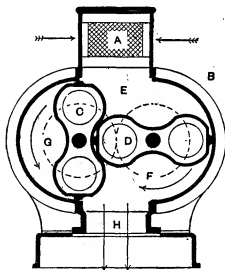

FIG. 6.—Thwaites' Improved Roots' Blower.

Two of the best-known machines of this kind are Roots' and Baker's, both American devices. The mode of action of Roots' blower, as made by Messrs Thwaites Bros. of Bradford, will be clear from the section shown on fig. 6. The moving parts work in a closed casing B, which consists of half-cylindrical curved plates placed a little more than their own radius apart, the ends being enclosed by two plates. Within the casing, and barely touching the curved part of the casing and each other, revolve two parts C, D, called "revolvers," the speed of rotation of which is the same, but the direction opposite. They are compelled to keep their proper relative positions by a pair of equal spur wheels

fixed on the ends of the shafts on which they run. The free air enters the casing through a wire screen at A and passes into the space E.

As the space E increases in volume owing to the movement of the revolvers, air is drawn in; it is then imprisoned between D and the casing, as shown at G, and is carried round until it is free to enter F, from which it is in turn expelled by the lessening of this space as the lower ends of the revolvers come together. In this way a series of volumes of air is drawn in through A, to be afterwards expelled from H in an almost perfectly continuous stream, this result being brought about by the relative variation in volume of the spaces E, F and G. In their most improved form the revolvers are made hollow, of cast iron, and accurately machined to a form such that they always keep close to one another and to the end casing without actually touching, there being never more space for the escape of air than $\frac{1}{2}$ nd of an inch. Machines after this design are made from the smallest size, delivering 25 cub. ft., to the largest, with a capacity of 25,000 cub. ft. per minute working up to a pressure of 3 lb per sq. in. It is not found economical to attempt to work at higher pressures, as the leakage between the revolvers and the casing becomes too great; where a higher pressure is desired two or more blowers can be worked in series, the air being raised in pressure by steps. A blower using 1 H.P. will deliver 350 cub. ft. of air per minute and one using 2½ H.P. will deliver 800 cub. ft., at a pressure suitable for smiths' fires. At the higher pressure required for cupola work—somewhere about $\frac{1}{2}$ lb per sq. in.—6½ H.P. will deliver 1300, and 123 H.P. 25,000 cub. ft. per minute. In the Baker blower three revolvers are used—a large one which acts as the rotating piston and two smaller ones forming air locks or valves.

Rotary Fans.—Now that power for driving them is so generally available, rotary blowing fans have for many purposes taken the place of bellows. They are used for blowing smiths' fires, for supplying the blast for iron melting cupolas and furnaces and the forced draught for boiler fires, and for any other purpose requiring a strong blast of air. Their construction will be clear from the two views (figs. 7 and 8) of the form made by Messrs Günther of Oldham, Lancashire. The fan consists of a circular casing A having the general appearance of a snail shell. Within this casing revolves a series of vanes B—in this case five—curved as shown, and attached together so as to form a wheel whose centre is a boss or hub. This boss is fixed to a shaft or spindle which revolves in bearings supported on brackets outside the casing. As the shaft is rotated, the vanes B are compelled to revolve in the direction indicated by the arrow on fig. 7, and their rotation causes the air within the casing to rotate also. Thus a centrifugal action is set up by which there is a diminution of pressure at the centre of the fan and an increase against the outer casing. In consequence air is sucked in, as shown by the arrows on fig. 8, through the openings C, C, at the centre of the casing around the spindle. At the same time the air which has been forced towards the outside of the casing and given a rotary motion is expelled from the opening at D (fig. 8). All blowing fans work on the same principle, though differences in detail are adopted by different makers to meet the variety of conditions under which they are to be used. Where the fan is to be employed for producing a delivery or blast of air the opening D is connected to an air pipe which serves to transmit the current of air, and C is left open to the atmosphere; when, however, the main object is suction, as in the case where the fan is used for ventilation, the aperture C is connected through a suction pipe with the space to be exhausted, D being usually left open. Günther fans range in size from those which have a diameter of fan disk of 8 in. and make 5500 revolutions per minute, to those which have a diameter of 50 in. and run at from 950 to 1200 revolutions per minute. For exhausting the fans are run less quickly than for blowing, the speed for a fan of 10 in. diameter being 4800 revolutions for blowing and 3300–4000 for exhausting, while the 50-in. fan only runs at 550–700 when exhausting. These two exhausting fans remove 400–500 and 12,000–15,000 cub. ft. of air per minute respectively.

The useful effect of rotary fans, that is to say the proportion of the total power used to drive the fan which is actually utilized in producing the current of air, is very low for the smaller sizes, but may rise to 30-70% in sizes above 5 ft. in diameter. It has its maximum value for any given fan at a certain definite speed. Fans are most suitable in cases where it is required to move or

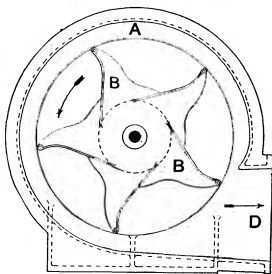

FIG. 7.—Günther's Blowing Fan.

deliver comparatively large volumes of air at pressures which are little above that of the atmosphere. Where the pressure of the current produced exceeds a quarter of a pound on the square inch the waste of work becomes so great as to preclude their use. The fan is not the most economical form of blower, but it is simple and inexpensive, both in first cost and in maintenance. The largest fans are used for ventilating purposes, chiefly in mines, their diameters rising to 40 or even 50 ft. The useful effect of some of these larger fans, as obtained from experiments, is as

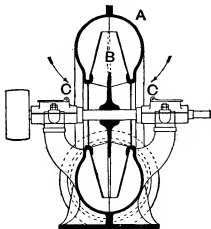

FIG. 8.—Günther's Blowing Fan.

high as 75%. In the case of the Capell fan, which differs from other forms in that it has two series of blades, inner and outer, separated by a curved blank piece between the inner wings, dipping into the fan inlet, and the outer wings, very high efficiencies have been obtained, being as great as 90% in some cases. Capell fans are used for ventilating mines, buildings, and ships, and for providing induced currents for use in boiler furnaces. In the larger fans the casing, instead of having a curved section, is more often built of sheet steel and is given a rectangular section at right angles to the periphery. The Sirocco blowing fan, of Messrs Davidson of Belfast, has a larger number of blades,

which are relatively narrow as measured radially, but wide axially. It can be made much smaller in diameter than fans of the older designs for the same output of air—a great advantage for use in ships or in buildings where space is limited—and its useful effect is also said to be superior. (See also *HYDRAULICS*, § 213.)

Helical or screw blowers, often called "air propellers," are used where relatively large volumes of air have to be moved against hardly any perceptible difference in pressure, chiefly for purposes of ventilation and drying. Most often the propeller is used to move air from one room or chamber to another adjoining, and is placed in a light circular iron frame which is fixed in a hole in the wall through which the air is to be passed. The propeller itself consists of a series of vanes or wings arranged helically on a revolving shaft which is fixed in the centre of the opening. The centre line of the shaft is perpendicular to the plane of the opening so that when the vanes revolve the air is drawn towards and through the opening and is propelled away from it as it passes through. The action is similar to that of a steamship screw propeller, air taking the place of water. Such blowers are often driven by small electric motors working directly on the end of the shaft. For moving large volumes of air against little pressure and suction they are very suitable, being simpler than fans, cheaper both in first cost and maintenance for the same volume of air delivered, and less likely to fail or get out of order. To obtain the best effect for the power used a certain maximum speed of rotation must not be exceeded; at higher speeds a great deal of the power is wasted. For example, a propeller with a vane diameter of 2½ ft. was found to deliver a volume of air approximately proportional to the speed up to about 700 revolutions per minute, when 8000 cub. ft. per minute were passed through the machine; but doubling this speed to 1400 revolutions per minute only increased delivery by 1000 cub. ft. to 9000. At the lower of these speeds the horse-power absorbed was 0.6 and at the higher one 1.6.

Other Appliances for producing Currents of Air.—In its primitive form the "trompe" or water-blowing engine adopted in Savoy, Carniola, and some parts of America, consists of a long vertical wooden pipe terminating at its lower end in an air chest. Water is allowed to enter the top of the pipe through a conical plug and, falling down in streamlets, carries with it air which is drawn in through sloping holes near the top of the pipe. In this way a quantity of air is delivered into the chamber, its pressure depending on the height through which the water falls. This simple arrangement has been developed for use in compressing large volumes of air at high pressures to be used for driving compressed air machinery. It is chiefly used in America, and provides a simple and cheap means of obtaining compressed air where there is an abundant natural supply of water falling through a considerable height. The pressure obtained in the air vessel is somewhat less than half a pound per square inch for every foot of fall.

Natural sources of water are also used for compressing and discharging air by letting the water under its natural pressure enter and leave closed vessels, so alternately discharging and drawing in new supplies of air. Here the action is the same as in a blowing engine, the water taking the place of the piston. This method was first thoroughly developed in connexion with the Mt. Cenis tunnel works, and its use has since been extended.

In the jet blower (fig. 9) a jet of steam is used to induce a

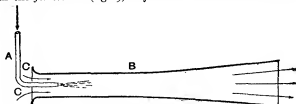

FIG. 9.—Steam-jet Blower.

current of air. Into one end of a trumpet-shaped pipe B projects a steam pipe A. This steam pipe terminates in a small opening, say, one-eighth of an inch, through which the steam is allowed to

flow freely. The effect is to cause a movement of the air in the pipe, with the result that a fresh supply is drawn in through the annular opening at C, C, and a continuous stream of air passes along the pipe. This is the form of blower made by Messrs Meldrum Bros. of Manchester, and is largely used for delivering air under the fire bars of boiler and other furnaces. In some cases the jets of steam are allowed to enter a boiler furnace above the fire, thus inducing a current of air which helps the chimney draught and is often used to do away with the production of smoke; they are also used for producing currents of air for purposes other than those of boiler fires, and are very convenient where considerable quantities of air are wanted at very low pressures and where the presence of the moisture of the steam does not matter.

Sometimes jets of high-pressure air flowing at great velocities are used to induce more slowly-moving currents of larger volumes of air at low pressures. (W. C. P.)

BELLOY, DORMONT DE, the name assumed by **PIERRE LAURENT BURETTE** (1727-1775), French dramatist, was born at Saint-Flour, in Auvergne, on the 17th of November 1727. He was educated by his uncle, a distinguished advocate in Paris, for the bar. To escape from a profession he disliked he joined a troupe of comedians playing in the courts of the northern sovereigns. In 1758 the performance of his *Titus*, which had already been produced in St Petersburg, was postponed through his uncle's exertions; and when it did appear, a hostile cabal procured its failure, and it was not until after his guardian's death that De Belloy returned to Paris with *Zelmire* (1762), a fantastic drama which met with great success. This was followed in 1765 by the patriotic play, *Le Siège de Calais*. The moment was opportune. The humiliations undergone by France in the Seven Years' War assured a good reception for a play in which the devotion of Frenchmen redeemed disaster. The popular enthusiasm was unaffected by the judgment of calmer critics such as Diderot and Voltaire, who pointed out that the glorification of France was not best effected by a picture of defeat. De Belloy was admitted to the Academy in 1772. His attempt to introduce national subjects into French drama deserves honour, but it must be confessed that his resources proved unequal to the task. *The Siège de Calais* was followed by *Gaston et Bayard* (1771), *Pedro le cruel* (1772) and *Gabrielle de Vergy* (1777). None of these attained the success of the earlier play, and De Belloy's death, which took place on the 5th of March 1775, is said to have been hastened by disappointment.

BELL or INCHCAPE ROCK, a sandstone reef in the North Sea, 11 m. S.E. of Arbroath, belonging to Forfarshire, Scotland. It measures 2000 ft. in length, is under water at high tide, but at low tide is exposed for a few feet, the sea for a distance of 100 yds. around being then only three fathoms deep. Lying in the fairway of vessels making or leaving the Tay and Forth, besides ports farther north, it was a constant menace to navigation. In the great gale of 1799 seventy sail, including the "York," 74 guns, were wrecked off the reef, and this disaster compelled the authorities to take steps to protect shipping. Next year Robert Stevenson modelled a tower and reported that its erection was feasible, but it was only in 1806 that parliamentary powers were obtained, and operations began in August 1807. Though John Rennie had meanwhile been associated with Stevenson as consulting engineer, the structure in design and details is wholly Stevenson's work. The tower is 100 ft. high; its diameter at the base is 42 ft., decreasing to 15 ft. at the top. It is solid for 30 ft. at which height the doorway is placed. The interior is divided into six storeys. After five years the building was finished at a cost of £61,300. Since the lighting no wrecks have occurred on the reef. A bust of Stevenson by Samuel Joseph (d. 1850) was placed in the tower.

According to tradition an abbot of Aberbrothock (Arbroath) had ordered a bell—whence the name of the rock—to be fastened to the reef in such a way that it should respond to the movements of the waves, and thus always ring out a warning to mariners. This signal was wantonly destroyed by a pirate, whose ship was afterwards wrecked at this very spot, the rover and his men

being drowned. Southey made the incident the subject of his ballad of "The Inchcape Rock."

BELLUNO (anc. *Bellunum*), a city and episcopal see of Venetia, Italy, the capital of the province of Belluno, N. of Treviso, 54 m. by rail and 28 m. direct. Pop. (1901) town, 6898; commune, 19,050. It is situated in the valley of the Piave, at its confluence with the Ardo, 1285 ft. above sea-level, among the lower Venetian Alps. It was a Roman *municipium*. In the middle ages it went through various vicissitudes; it fell under the dominion of Venice in 1511, and remained Venetian until 1797. Its buildings present Venetian characteristics; it has some good palaces, notably the fine early Lombard Renaissance Palazzo dei Rettori, now the seat of the prefecture. The cathedral, erected after 1517 by Tullio Lombardo, was much damaged by the earthquake of 1873, which destroyed a considerable portion of the town, though the campanile, 217 ft. high, erected in 1732-1743, stood firm. The façade was never finished. Important remains of prehistoric settlements have been found in the vicinity; cf. G. Girardini in *Notizie degli Scavi*, 1883, 27, on the necropolis of Caverzano. (T. As.)

BELMONT, AUGUST (1816-1890), American banker and financier, was born at Alzci, Rhenish Prussia, on the 8th of December 1816. He entered the banking house of the Rothschilds at Frankfurt at the age of fourteen, acted as their agent for a time at Naples, and in 1837 settled in New York as their American representative. He became an American citizen, and married a daughter of Commodore Matthew C. Perry. He was the consul-general of Austria at New York from 1844 to 1850, when he resigned in protest against Austria's treatment of Hungary. In 1853-1855 he was chargé d'affaires for the United States at the Hague, and from 1855 to 1858 was the American minister resident there. In 1860 he was a delegate to the Democratic National Convention at Charleston, South Carolina, actively supporting Stephen A. Douglas for the presidential nomination, and afterwards joining those who withdrew to the convention at Baltimore, Maryland, where he was chosen chairman of the National Democratic Committee. He energetically supported the Union cause during the Civil War, and exerted a strong influence in favour of the North upon the merchants and financiers of England and France. He remained at the head of the Democratic organization until 1872. He died in New York on the 24th of November 1890.

His son, **PERRY BELMONT** (1851-), was born in New York on the 28th of December 1851, graduated at Harvard in 1872 and at the Columbia Law School in 1876, and practised law in New York for five years. He was a Democratic member of Congress from 1881 to 1889, serving in 1885-1887 as chairman of the committee on foreign affairs. In 1889 he was United States minister to Spain.

Another son, **AUGUST BELMONT** (1853-), was born in New York on the 18th of February 1853 and graduated at Harvard in 1875. He succeeded his father as head of the banking house and was prominent in railway finance, and in financing and building the New York subway. In 1904 he was one of the principal supporters of Alton B. Parker for the Democratic presidential nomination, and served as chairman of the finance committee of the Democratic National Committee.

A volume entitled *Letters, Speeches and Addresses of August Belmont* (the elder) was published at New York in 1890.

BELOIT, a city of Rock county, Wisconsin, U.S.A., situated on the S. boundary of the state, on Rock river, about 91 m. N.W. of Chicago and about 85 m. S.W. of Milwaukee. Pop. (1890) 6315; (1900) 10,436, of whom 1268 were foreign-born; (1910) 15,125. It is served by the Chicago & North-Western, and the Chicago, Milwaukee & St Paul railways, and by an inter-urban electric railway to Janesville, Wisconsin and Rockford, Illinois. Beloit is attractively situated on high bluffs on both sides of the river. The city is the seat of Beloit College, a co-educational, non-sectarian institution, founded under the auspices of the Congregational and Presbyterian churches in 1847, and having, in 1907-1908, 36 instructors and 430 students. It has classical, philosophical (1874) and scientific (1892) courses;

women were first admitted in 1895. The Greek department of the college has supervised since 1895 the public presentation nearly every year of an English version of a Greek play. The river furnishes good water-power, and among the manufactures are wood-working machinery, ploughs, steam pumps, windmills, gas engines, paper-mill machinery, cutlery, flour, ladies' shoes, cyclometers and paper; the total value of the factory product in 1905 was \$4,485,224, 60·2% more than in 1900. Beloit, founded by New Englanders in 1838, was chartered as a city in 1856.

BELOMANCY (from Gr. βέλως, a dart, and μαντεία, prophecy or divination), a form of divination (*q.v.*) by means of arrows, practised by the Babylonians, Scythians and other ancient peoples. Nebuchadrezzar (Ezek. xli. 21) resorted to this practice "when he stood in the parting of the way . . . to use divination: he made his arrows bright."

BELON, PIERRE (1517-1564), French naturalist, was born about 1517 near Le Mans (Sarthe). He studied medicine at Paris, where he took the degree of doctor, and then became a pupil of the botanist Valerius Cordus (1515-1544) at Wittenberg, with whom he travelled in Germany. On his return to France he was taken under the patronage of Cardinal de Tournon, who furnished him with means for undertaking an extensive scientific journey. Starting in 1546, he travelled through Greece, Asia Minor, Egypt, Arabia and Palestine, and returned in 1549. A full account of his travels, with illustrations, was published in 1553. Belon, who was highly favoured both by Henry II. and by Charles IX., was assassinated at Paris one evening in April 1564, when coming through the Bois de Boulogne. Besides the narrative of his travels he wrote several scientific works of considerable value, particularly the *Histoire naturelle des estranges poissons* (1551), *De aquatilibus* (1553), and *L'Histoire de la nature des oyseaux* (1555), which entitle him to be regarded as one of the first workers in the science of comparative anatomy.

BELPER, a market-town in the mid-parliamentary division of Derbyshire, England, on the river Derwent, 7 m. N. of Derby on the Midland railway. Pop. of urban district (1901), 10,934. The chapel of St John is said to have been founded by Edmund Crouchback, second son of Henry III., about the middle of the 13th century. There is an Anglican convent of the Sisters of St Lawrence, with orphanage and school. For a considerable period one of the most flourishing towns in the county, Belper owed its prosperity to the establishment of cotton works in 1776 by Messrs Strutt, the title of Baron Belper (c. 1856), in the Strutt family, being taken from the town. Belper also manufactures linen, hosiery, silk and earthenware; and after the decline of nail-making, once an important industry, engineering works and iron foundries were opened. The Derwent provides water-power for the cotton-mills. John of Gaunt is said to have been a great benefactor to Belper, and the foundations of a massive building have been believed to mark the site of his residence. A chapel which he founded is incorporated with a modern schoolhouse. The scenery in the neighbourhood of Belper, especially to the west, is beautiful; but there are collieries, lead-mines and quarries in the vicinity of the town.

Belper (Beaurepaire) until 1846 formed part of the parish of Duffield, granted by William I. to Henry de Ferrers, earl of Derby. There is no distinct mention of Belper till 1206, when the manor was held by Edmund Crouchback, earl of Lancaster, who is said to have enclosed a park and built a hunting seat, to which, from its situation, he gave the name Beaurepaire. The manor thus became parcel of the duchy of Lancaster and is said to have been the residence of John of Gaunt. It afterwards passed with Duffield to the Jodrell family. In a great storm in 1545, 40 houses were destroyed, and the place was scourged by the plague in 1609.

See C. Willott, *Historical Records of Belper*.

BELSHAM, THOMAS (1750-1820), English Unitarian minister, was born at Bedford on the 26th of April 1750. He was educated at the dissenting academy at Daventry, where for seven years he acted as assistant tutor. After three years spent in a charge at Worcester, he returned as head of the Daventry academy, a post which he continued to hold till 1780, when, having adopted

Unitarian principles, he resigned. With Joseph Priestly for colleague, he superintended during its brief existence a new college at Hackney, and was, on Priestly's departure in 1794, also called to the charge of the Gravel Pit congregation. In 1805 he accepted a call to the Essex Street chapel, where in gradually failing health he remained till his death in 1829. Belsham's first work of importance, *Review of Mr Wilberforce's Treatise entitled Practical View* (1798), was written after his conversion to Unitarianism. His most popular work was the *Evidences of Christianity*; the most important was his translation and exposition of the Epistles of St Paul (1822). He was also the author of a work on philosophy, *Elements of the Philosophy of the Human Mind* (1801), which is entirely based on Hartley's psychology. Belsham is one of the most vigorous and able writers of his church, and the *Quarterly Review* and *Gentleman's Magazine* of the early years of the 19th century abound in evidences that his abilities were recognized by his opponents.

BELSHAZZAR (6th century B.C.), Babylonian general. Until the decipherment of the cuneiform inscriptions, he was known only from the book of Daniel (v. 2, 11, 13, 18) and its reproduction in Josephus, where he is represented as the son of Nebuchadrezzar and the last king of Babylon. As his name did not appear in the list of the successors of Nebuchadrezzar handed down by the Greek writers, various suggestions were put forward as to his identity. Niebuhr identified him with Evil-Merodach, Ewald with Nabonidos, others again with Nerigissor. The identification with Nabonidos, the last Babylonian king according to the native historian Berossus, goes back to Josephus. The decipherment of the cuneiform texts put an end to all such speculations. In 1854 Sir H. C. Rawlinson discovered the name of Bel-sarrazur—"O Bel, defend the king"—in an inscription belonging to the first year of Nabonidos which had been discovered in the ruins of the temple of the Moon-god at Muqayyar or Ur. Here Nabonidos calls him his "first-born son," and prays that "he may not give way to sin," but that "the fear of the great divinity" of the Moon-god may "dwell in his heart." In the contracts and similar documents there are frequent references to Belshazzar, who is sometimes entitled simply "the son of the king."

He was never king himself, nor was he son of Nebuchadrezzar. Indeed his father Nabonidos (Nabunaid), the son of Nabubalsadu-iqbi, was not related to the family of Nebuchadrezzar and owed his accession to the throne to a palace revolution. Belshazzar, however, seems to have had more political and military energy than his father, whose tastes were antiquarian and religious; he took command of the army, living with it in the camp near Sippara, and whatever measures of defence were organized against the invasion of Cyrus appear to have been due to him. Hence Jewish tradition substituted him for his less-known father, and rightly concluded that his death marked the fall of the Babylonian monarchy. We learn from the Babylonian Chronicle that from the 7th year of Nabonidos (548 B.C.) onwards "the son of the king" was with the army in Akkad, that is in the close neighbourhood of Sippara. This, as Dr Th. G. Pinches has pointed out, doubtless accounts for the numerous gifts bestowed by him on the temple of the Sun-god at Sippara. So late as the 5th of Ab in the 17th year of Nabonidos—that is to say, about three weeks after the forces of Cyrus had entered Babylon and only three months before his death—we find him paying 47 shekels of silver to the temple on behalf of his sister, this being the amount of "tithe" due from her at the time. At an earlier period there is frequent mention of his trading transactions which were carried out through his house-steward or agent. Thus in 545 B.C. he lent 20 manehs of silver to a private individual, a Persian by race, on the security of the property of the latter, and a year later his house-steward negotiated a loan of 16 shekels, taking as security the produce of a field of corn.

The legends of Belshazzar's feast and of the siege and capture of Babylon by Cyrus which have come down to us from the book of Daniel and the *Cyropædia* of Xenophon have been shown by the contemporaneous inscriptions to have been a projection

backwards of the re-conquest of the city by Darius Hystaspis. The actual facts were very different. Cyrus had invaded Babylonia from two directions, he himself marching towards the confluence of the Tigris and Diyaleh, while Gobryas, the satrap of Kurdistan, led another body of troops along the course of the Adhem. The portion of the Babylonian army to which the protection of the eastern frontier had been entrusted was defeated at Opis on the banks of the Nizallat, and the invaders poured across the Tigris into Babylonia. On the 14th of Tammuz (June), 538 B.C., Nabonidos fled from Sippara, where he had taken his son's place in the camp, and the city surrendered at once to the enemy. Meanwhile Gobryas had been despatched to Babylon, which opened its gates to the invader on the 16th of the month "without combat or battle," and a few days later Nabonidos was dragged from his hiding-place and made a prisoner. According to Berossus he was subsequently appointed governor of Karmania by his conqueror. Belshazzar, however, still held out, and it was probably on this account that Cyrus himself did not arrive at Babylon until nearly four months later, on the 3rd of Marchesvan. On the 11th of that month Gobryas was despatched to put an end to the last semblance of resistance in the country "and the son (?) of the king died." In accordance with the conciliatory policy of Cyrus, a general mourning was proclaimed on account of his death, and this lasted for six days, from the 27th of Adar to the 3rd of Nisan. Unfortunately the character representing the word "son" is indistinct on the tablet which contains the annals of Nabonidos, so that the reading is not absolutely certain. The only other reading possible, however, is "and the king died," and this reading is excluded partly by the fact that Nabonidos afterwards became a Persian satrap, partly by the silence which would otherwise be maintained by the "Annals" in regard to the fate of Belshazzar. Considering how important Belshazzar was politically, and what a prominent place he occupied in the history of the period, such a silence would be hard to explain. His death subsequently to the surrender of Babylon and the capture of Nabonidos, and with it the last native effort to resist the invader, would account for the position he assumed in later tradition and the substitution of his name for that of the actual king.

See Th. G. Pinches, *P.S.B.A.*, May 1884; H. Winckler, *Zeitschrift für Assyriologie*, ii. 2, 3 (1887); *Records of the Past*, new series, i. pp. 22-31 (1888); A. H. Sayce, *The Higher Criticism*, pp. 497-537 (1893). (A. H. S.)

BELT, THOMAS (1832-1878), English geologist and naturalist, was born at Newcastle-on-Tyne in 1832, and educated in that city. As a youth he became actively interested in natural history through the Tyneside Naturalists' Field Club. In 1852 he went to Australia and for about eight years worked at the gold-diggings, where he acquired a practical knowledge of ore-deposits. In 1860 he proceeded to Nova Scotia to take charge of some gold-mines, and there met with a serious injury, which led to his return to England. In 1861 he issued a separate work entitled *Mineral Veins: an Enquiry into their Origin, founded on a Study of the Auriferous Quartz Veins of Australia*. Later on he was engaged for about three years at Dolgelly, another though small gold-mining region, and here he carefully investigated the rocks and fossils of the Lingula Flags, his observations being published in an important and now classic memoir in the *Geological Magazine* for 1867. In the following year he was appointed to take charge of some mines in Nicaragua, where he passed four active and adventurous years—the results being given in his *Naturalist in Nicaragua* (1874), a work of high merit. In this volume the author expressed his views on the former presence of glaciers in that country. In subsequent papers he dealt boldly and suggestively with the phenomena of the Glacial period in Britain and in various parts of the world. After many further expeditions to Russia, Siberia and Colorado, he died at Denver on the 21st of September 1878.

BELT (a word common to Teutonic languages, the Old German form being *balc*, from which the Lat. *balteus* probably derived), a flat strap of leather or other material used as a girdle (*q.v.*), especially the *cinctura gladii* or sword-belt, the chief "ornament

of investiture" of an earl or knight; in machinery, a flexible strap passing round from one drum, pulley or wheel to another, for the purpose of power-transmission (*q.v.*). The word is applied to any broad stripe, to the belts of the planet Jupiter, to the armour-belt at the water-line of a warship, or to a tract of country, narrow in proportion to its length, with special distinguishing characteristics, such as the earthquake-belt across a continent.

BELTANE, BELTENE, BELTINE, or BEAL-TENE (Scottish Gaelic *bealltain*), the Celtic name for May-day, on which also was held a festival called by the same name, originally common to all the Celtic peoples, of which traces still linger in Ireland, the Highlands of Scotland and Brittany. This festival, the most important ceremony of which in later centuries was the lighting of the bonfires known as "beltane fires," is believed to represent the Druidical worship of the sun-god. The fuel was piled on a hill-top, and at the fire the beltane cake was cooked. This was divided into pieces corresponding to the number of those present, and one piece was blackened with charcoal. For these pieces lots were drawn, and he who had the misfortune to get the black bit became *caiteach bealtine* (the beltane carline)—a term of great reproach. He was pelted with egg-shells, and afterwards for some weeks was spoken of as dead. In the north-east of Scotland beltane fires were still kindled in the latter half of the 18th century. There were many superstitions connecting them with the belief in witchcraft. According to Cormac, archbishop of Cashel about the year 908, who furnishes in his glossary the earliest notice of beltane, it was customary to light two fires close together, and between these both men and cattle were driven, under the belief that health was thereby promoted and disease warded off. (See *Transactions of the Irish Academy*, xiv. pp. 100, 122, 123.) The Highlanders have a proverb, "he is between two beltane fires." The Strathspey Highlanders used to make a hoop of rowan wood through which on beltane day they drove the sheep and lambs both at dawn and sunset.

As to the derivation of the word beltane there is considerable obscurity. Following Cormac, it has been usual to regard it as representing a combination of the name of the god Bel or Baal or Bil with the Celtic *teine*, fire. And on this etymology theories have been erected of the connexion of the Semitic Baal with Celtic mythology, and the identification of the beltane fires with the worship of this deity. This etymology is now repudiated by scientific philologists, and the *New English Dictionary* accepts Dr Whitley Stokes's view that beltane in its Gaelic form can have no connexion with *teine*, fire. Beltane, as the 1st of May, was in ancient Scotland one of the four quarter days, the others being Hallowmas, Candlemas, and Lammas.

For a full description of the beltane celebration in the Highlands of Scotland during the 18th century, see John Ramsay, *Scotland and Scotsmen in the 18th Century*, from MSS. edited by A. Allardyce (1888); and see further J. Robertson in Sinclair's *Statistical Account of Scotland*, xi. 620; Thomas Pennant, *Tour in Scotland* (1769-1770); W. Gregor, "Notes on Beltane Cakes," *Folklore*, vi. (1895), p. 2; and "Notes on the Folklore of the North-East of Scotland," p. 167 (*Folklore*, Sc. vii. 1881); A. Bertrand, *La Religion des Gaulois* (1897); Jamieson, *Scottish Dictionary* (1808). Cormac's *Glossary* has been edited by O'Donovan and Stokes (1862).

BELUGA (*Delphinapterus leucas*), also called the "white whale," a cetacean of the family *Delphinidae*, characterized by its rounded head and uniformly light colour. A native of the Arctic seas, it extends in the western Atlantic as far south as the river St Lawrence, which it ascends for a considerable distance. In colour it is almost pure white; the maximum length is about twelve feet; and the back-fin is replaced by a low ridge. Examples have been taken on the British coasts; and individuals have been kept for some time in captivity in America and in London. See CETACEA.

BELVEDERE, or BELVIDERE (Ital. for "fair-view"), an architectural structure built in the upper part of a building or in any elevated position so as to command a fine view. The belvedere assumes various forms, such as an angle turret, a cupola, a loggia or open gallery. The name is also applied to the whole building, as the Belvedere gallery in the Vatican at Rome. For Apollo Belvedere see GREEK ART, Plate II. fig. 55.

BELVIDERE, a city and the county-seat of Boone county, Illinois, U.S.A., in the N. part of the state, on the Kishwaukee river, about 78 m. N.W. of Chicago. Pop. (1890) 3867; (1900) 6937 (1018 foreign-born); (1910) 7253. It is served by the Chicago & North-Western railway, and by an extensive interurban electric system. Among its manufactures are sewing machines, boilers, automobiles, bicycles, roller-skates, pianos, gloves and mittens, corsets, flour and dairy products, Borden's condensed milk factory being located there. Belvidere was settled in 1836, was incorporated in 1852 and was re-incorporated in 1881.

BELZONI, GIOVANNI BATTISTA (1778-1823), Italian explorer of Egyptian antiquities, was born at Padua, in 1778. His family was from Rome, and in that city he spent his youth. He intended taking monastic orders, but in 1798 the occupation of the city by the French troops drove him from Rome and shamed his proposed career. He went back to Padua, where he studied hydraulics, removed in 1800 to Holland, and in 1803 went to England, where he married an Englishwoman. He was 6 ft. 7 in. in height, broad in proportion, and his wife was of equally generous build. They were for some time compelled to find subsistence by exhibitions of feats of strength and agility at fairs and on the streets of London. Through the kindness of Henry Salt, the traveller and antiquarian, who was ever afterwards his patron, he was engaged at Astley's amphitheatre, and his circumstances soon began to improve. In 1812 he left England, and after travelling in Spain and Portugal reached Egypt in 1815, where Salt was then British consul-general. Belzoni was desirous of laying before Mehemet Ali a hydraulic machine of his own invention for raising the waters of the Nile. Though the experiment with this engine was successful, the design was abandoned by the pasha, and Belzoni resolved to continue his travels. On the recommendation of the orientalist, J. L. Burckhardt, he was sent at Salt's charges to Thebes, whence he removed with great skill the colossal bust of Rameses II., commonly called Young Memnon, which he shipped for England, where it is in the British Museum. He also pushed his investigations into the great temple of Edfu, visited Elephantine and Philae, cleared the great temple at Abu Simbel of sand (1817), made excavations at Karnak, and opened up the sepulchre of Seti I. ("Belzoni's Tomb"). He was the first to penetrate into the second pyramid of Giza, and the first European in modern times to visit the oasis of Baharia, which he supposed to be that of Siwa. He also identified the ruins of Berenice on the Red Sea. In 1819 he returned to England, and published in the following year an account of his travels and discoveries entitled *Narrative of the Operations and Recent Discoveries within the Pyramids, Temples, Tombs and Excavations in Egypt and Nubia, &c.* He also exhibited during 1820-1821 facsimiles of the tomb of Seti I. The exhibition was held at the Egyptian Hall, Piccadilly, London. In 1822 Belzoni showed his model in Paris. In 1823 he set out for West Africa, intending to penetrate to Timbuktu. Having been refused permission to pass through Morocco, he chose the Guinea Coast route. He reached Benin, but was seized with dysentery at a village called Gwato, and died there on the 3rd of December 1823. In 1829 his widow published his drawings of the royal tombs at Thebes.

BEM, JOSEF (1795-1850), Polish soldier, was born at Tarnow in Galicia, and was educated at the military school at Warsaw, where he especially distinguished himself in mathematics. Joining a Polish artillery regiment in the French service, he took part in the Russian campaign of 1812, and subsequently so brilliantly distinguished himself in the defence of Danzig (January-November 1813) that he won the cross of the Legion of Honour. On returning to Poland he was for a time in the Russian service, but lost his post, and his liberty as well for some time, for his outspokenness. In 1825 he migrated to Lemberg, where he taught the physical sciences. He was about to write a treatise on the steam-engine, when the Polish War of Independence summoned him back to Warsaw in November 1830. It was his skill as an artillery officer which won for the Polish general Skrynecki the battle of Igany (March 8, 1831), and he distin-

guished himself at the indecisive battle of Ostrolenka (May 26). He took part in the desperate defence of Warsaw against Prince Paskievich (September 6-7, 1831). Then Bem escaped to Paris, where he supported himself by teaching mathematics. In 1833 he went to Portugal to assist the liberal Dom Pedro against the reactionary Dom Miguel, but abandoned the idea when it was found that a Polish legion could not be formed. A wider field for his activity presented itself in 1848. First he attempted to hold Vienna against the imperial troops, and, after the capitulation, hastened to Pressburg to offer his services to Kossuth, first defending himself, in a long memorial, from the accusations of treachery to the Polish cause and of aristocratic tendencies which the more fanatical section of the Polish emigrant Radicals repeatedly brought against him. He was entrusted with the defence of Transylvania at the end of 1848, and in 1849, as the general of the Szeklers (*g.v.*), he performed miracles with his little army, notably at the bridge of Piski (February 9), where, after fighting all day, he drove back an immense force of pursuers. After recovering Transylvania he was sent to drive the Austrian general Puchner out of the Banat of Temesvár. Bem defeated him at Orsova (May 16), but the Russian invasion recalled him to Transylvania. From the 12th to 22nd of July he was fighting continually, but finally, on the 31st of July, his army was annihilated by overwhelming numbers near Segesvár (Schässburg), Bem only escaping by feigning death. Yet he fought a fresh action at Gross-Scheueren on the 6th of August, and continued to bring off the fragments of his host to Temesvár, to aid the hardly-pressed Dembinski. Bem was in command and was seriously wounded in the last pitched battle of the war, fought there on the 9th of August. On the collapse of the rebellion he fled to Turkey, adopted Mahomedanism, and under the name of Murad Pasha served as governor of Aleppo, at which place, at the risk of his life, he saved the Christian population from being massacred by the Moslems. Here he died on the 16th of September 1850. The tiny, withered, sickly body of Bem was animated by a heroic temper. Few men have been so courageous, and his influence was magnetic. Even the rough Szeklers, though they did not understand the language of their "little father," regarded him with superstitious reverence. A statue to his honour has been erected at Maros-Vásárhely, but he lives still more enduringly in the immortal verses of the patriot poet Sandor Petöfi, who fell in the fatal action of the 31st of July at Segesvár. As a soldier Bem was remarkable for his excellent handling of artillery and the rapidity of his marches.

See Johann Cetz, *Memoiren über Bem's Feldzug* (Hamburg, 1850); Kálmán Deresényi, *General Bem's Winter Campaign in Transylvania, 1848-1849* (Hung.), (Budapest, 1896). (R. N. B.)

BEMA (Gr. *βῆμα*.), in ecclesiastical architecture, the semi-circular recess or exedra, in the basilica, where the judges sat, and where in after times the altar was placed. It generally is roofed with a half dome. The seats, *θρόνοι*, of the priests were against the wall, looking into the body of the church, that of the bishop being in the centre. The bema is generally ascended by steps, and railed off. In Greece the bema was the general name of any raised platform. Thus the word was applied to the tribunal from which orators addressed assemblies of the citizens at Athens. That in the Pnyx, 17 ft. in height. Again in the Athenian law court counsel addressed the court from such a platform: it is not known whether each had a separate bema or whether there was only one to which each counsel (? and the witnesses) in turn ascended (cf. W. Wyse in his edition of Isaeus, p. 440). Another bema was the platform on which stood the urns for the reception of the bronze disks (*ψήφοι*) by means of which at the end of the 4th century the judges recorded their decisions.

BEMBERG, HERMAN (1861-), French musical composer, was born of French parents at Buenos Aires, and studied at the Paris Conservatoire, under Massenet, whose influence, with that of Gounod, is strongly marked in his music. As a composer he is known by numerous songs and pieces for the piano, as well as by his cantata *La Mort de Jeanne d'Arc* (1886), comic opera *Le Boiser*

de Suzzani (1888) and grand opera *Elaine* (produced at Covent Garden in 1892). Among his songs the dramatic recitative *Balade du Désespéré* is well known.

BEMBO, PIETRO (1470-1547), Italian cardinal and scholar, was born at Venice on the 20th of May 1470. While still a boy he accompanied his father to Florence, and there acquired a love for that Tuscan form of speech which he afterwards cultivated in preference to the dialect of his native city. Having completed his studies, which included two years' devotion to Greek under Lascaris at Messina, he chose the ecclesiastical profession. After a considerable time spent in various cities and courts of Italy, where his learning already made him welcome, he accompanied Giulio de' Medici to Rome, where he was soon after appointed secretary to Leo X. On the pontiff's death he retired, with impaired health, to Padua, and there lived for a number of years engaged in literary labours and amusements. In 1529 he accepted the office of historiographer to his native city, and shortly afterwards was appointed librarian of St Mark's. The offer of a cardinal's hat by Pope Paul III. took him in 1530 again to Rome, where he renounced the study of classical literature and devoted himself to theology and classical history, receiving before long the reward of his conversion in the shape of the bishoprics of Gubbio and Bergamo. He died on the 18th of January 1547. Bembo, as a writer, is the *beau idéal* of a purist. The exact imitation of the style of the genuine classics was the highest perfection at which he aimed. This at once prevented the graces of spontaneity and secured the beauties of artistic elaboration. One cannot fail to be struck with the Ciceronian cadence that guides the movement even of his Italian writings.

His works (collected edition, Venice, 1729) include a *History of Venice* (1551) from 1487 to 1513, dialogues, poems, and what we would now call essays. Perhaps the most famous are a little treatise on Italian prose, and a dialogue entitled *Gli Asolani*, in which Platonic affection is explained and recommended in a rather long-winded fashion, to the amusement of the reader who remembers the relations of the beautiful Morosina with the author. The edition of Petrarch's *Italian Poems*, published by Aldus in 1501, and the *Tersarion*, which issued from the same press in 1502, were edited by Bembo, who was on intimate terms with the great typographer. See *Opere di P. Bembo* (Venice, 1729); Casa, *Vita di Bembo*, in 2 vol. of his works.

BEMBRIDGE BEDS, in geology, strata forming part of the fluvio-marine series of deposits of Oligocene age, in the Isle of Wight and Hampshire, England. They lie between the Hamstead beds above and the Osborne beds below. The Bembridge marls, freshwater, estuarine and marine clays and marls (70-120 ft.) rest upon the Bembridge limestone, a freshwater pool deposit (15-25 ft.), with large land snails (*Amphidromus* and *Helices*), freshwater snails (*Planorbis*, *Limnaea*), and the fruits of *Chara*. The marls contain, besides the freshwater *Limnaea* and *Unio*, such forms as *Meretrix*, *Ostrea* and *Melanoopsis*. A thin calcareous sandy layer in this division has yielded the remains of many insects and fossil leaves.

See "Geology of the Isle of Wight," *Mem. Geol. Survey*, 2nd ed. 1889.

BEMIS, EDWARD WEBSTER (1860-), American economist, was born at Springfield, Massachusetts, on the 7th of April 1860. He was educated at Amherst and Johns Hopkins University. He held the professorship of history and political economy in Vanderbilt University from 1887 to 1892, was associate professor of political economy in the university of Chicago from 1892 to 1895, and assistant statistician to the Illinois bureau of labour statistics, 1896. In 1901 he became superintendent of the Cleveland water works. He wrote much on municipal government, his more important works being some chapters in *History of Co-operation in the United States* (1888); *Municipal Ownership of Gas in the U.S.* (1891); *Municipal Monopolies* (1899).

BÉMONT, CHARLES (1848-), French scholar, was born at Paris on the 16th of November 1848. In 1884 he graduated with two theses, *Simon de Montfort* and *La Condamnation de Jean Sansterre* (*Revue historique*, 1886). His *Les Chartes des libertés anglaises* (1892) has an introduction upon the history of Magna Carta, &c., and his *History of Europe from 395 to 1270*, in

collaboration with G. Monod, was translated into English. He was also responsible for the continuation of the *Gascon Rolls*, the publication of which had been begun by Francisque Michel in 1885 (supplement to vol. i., 1896; vol. ii., for the years 1273-1290, 1900; vol. iii., for the years 1290-1307, 1906). He received the honorary degree of Litt. Doc. at Oxford in 1909.

BEN (from Old Eng. *bennan*, within), in the Scottish phrase "a but and a ben," the inner room of a house in which there is only one outer door, so that the entrance to the inner room is through the outer, the but (Old Eng. *butan*, without). Hence "a but and a ben" meant originally a living room and sleeping room, and so a dwelling or a cottage.

BENARES, the Holy City of the Hindus, which gives its name to a district and division in the United Provinces of India. It is one of the most ancient cities in the world. The derivation of its ancient name *Varanasi* is not known, nor is that of its alternative name *Kasi*, which is still in common use among Hindus, and is popularly explained to mean "bright." The original site of the city is supposed to have been at Sarnath, 3½ m. north of the present city, where ruins of brick and stone buildings, with three lofty *stupas* still standing, cover an area about half a mile long by a quarter broad. Sakya Muni, the Buddha, came here from Gaya in the 6th century B.C. (from which time some of the remains may date), in order to establish his religion, which shows that the place was even then a great centre. Hsüan Tsang, the celebrated Chinese pilgrim, visited Benares in the 7th century A.D. and described it as containing 300 Buddhist monasteries, with about 3000 monks, and about 100 temples of Hindu gods. Hinduism has now supplanted Buddhism, and the Brahman fills the place of the monk. The modern temples number upwards of 1500. Even after the lapse of so great a time the city is still in its glory, and as seen from the river it presents a scene of great picturesqueness and grandeur. The Ganges here forms a fine sweep of about 4 m. in length, the city being situated on the outside of the curve, on the northern bank of the river, which is higher than the other. Being thus elevated, and extending along the river for some 4 m., the city forms a magnificent panorama of buildings in many varieties of oriental architecture. The minarets of the mosque of Aurangzeb rise above all. The bank of the river is entirely lined with stone, and there are many very fine ghats or landing-places built by pious devotees, and highly ornamented. These are generally crowded with bathers and worshippers, who come to wash away their sins in the sacred river Ganges. Near the Manikarnika ghat is the well held to have been dug by Vishnu and filled with his sweat; great numbers of pilgrims bathe in its venerated water. Shrines and temples line the bank of the river. But in spite of its fine appearance from the river, the architecture of Benares is not distinguished, nor are its buildings of high antiquity. Among the most conspicuous of these are the mosque of Aurangzeb, built as an intentional insult in the middle of the Hindu quarter; the Bisheshwar or Golden Temple, important less through architectural beauty than through its rank as the holiest spot in the holy city; and the Durga temple, which, like most of the other principal temples, is a Maharratta building of the 17th century. The temples are mostly small and are placed in the angles of the streets, under the shadow of the lofty houses. Their forms are not ungraceful, and many of them are covered over with beautiful and elaborate carvings of flowers, animals and palm branches. The observatory of Raja Jai Singh is a notable building of the year 1693. The internal streets of the town are so winding and narrow that there is not room for a carriage to pass, and it is difficult to penetrate them even on horseback. The level of the roadway is considerably lower than the ground-floors of the houses, which have generally arched rooms in front, with little shops behind them; and above these are richly embellished with verandahs, galleries, projecting oriel windows, and very broad overhanging eaves supported by carved brackets. The houses are built of *chanar* stone, and are lofty, none being less than two storeys high, most of them three, and several of five or six storeys. The Hindus are fond of painting the outside of their houses a deep red colour, and of covering

the most conspicuous parts with pictures of flowers, men, women, bulls, elephants and gods and goddesses in all the many forms known in Hindu mythology.

Benares is bounded by a road which, though 50 m. in circuit, is never distant from the city more than five kos ($7\frac{1}{2}$ m.); hence its name, Panch-kos road. All who die within this boundary, be they Brahman or low caste, Moslem or Christian, are sure of admittance into Siva's heaven. To tread the Panch-kos road is one of the great ambitions of a Hindu's life. Even if he be an inhabitant of the sacred city he must traverse it once in a year to free himself from the impurities and sins contracted within the holy precincts. Thousands from all parts of India make the pilgrimage every year. Benares, having from time immemorial been a holy city, contains a vast number of Brahmans, who either subsist by charitable contributions, or are supported by endowments in the numerous religious institutions of the city. Hindu religious mendicants, with every conceivable bodily deformity, line the principal streets on both sides. Some have their legs or arms distorted by long continuance in one position; others have kept their hands clenched until the finger nails have pierced entirely through their hands. But besides an immense resort to Benares of poor pilgrims from every part of India, as well as from Tibet and Burma, numbers of rich Hindus in the decline of life go there for religious salvation. These devotees lavish large sums in indiscriminate charity, and it is the hope of sharing in such pious distributions that brings together the concourse of religious mendicants from all quarters of the country.

The city of Benares had a population in 1901 of 209,331. The European quarter lies to the west of the native town, on both sides of the river Barna. Here is the cantonment of Sikraul, no longer of much military importance, and the suburb of Sigra, the seat of the chief missionary institutions. The principal modern buildings are the Mint, the Prince of Wales' hospital (commemorating the visit of King Edward VII. to the city in 1876) and the town hall. The Benares college, including a first-grade and a Sanskrit college, was opened in 1701, but its fine buildings date from 1852. The Central Hindu College was opened in 1898. Benares conducts a flourishing trade by rail and river with the surrounding country. It is the junction between the Oudh & Rohilkhand and East Indian railways, the Ganges being crossed by a steel girder bridge of seven spans, each 350 ft. long. The chief manufactures are silk brocades, gold and silver thread, gold filigree work, German-silver work, embossed brass vessels and lacquered toys; but the brasswork for which Benares used to be famous has greatly degenerated.

The Hindu kingdom of Benares is said to have been founded by one Kas Raja about 1200 B.C. Subsequently it became part of the kingdom of Kanauj, which in A.D. 1193 was conquered by Mahmood of Ghor. On the downfall of the Pathan dynasty of Delhi, about A.D. 1599, it was incorporated with the Mogul empire. On the dismemberment of the Delhi empire, it was seized by Safdar Jang, the nawab wazir of Oudh, by whose grandson it was ceded to the East India Company by the treaty of 1775. The subsequent history of Benares contains two important events, the rebellion of Chait Singh in 1781, occasioned by the demands of Warren Hastings for money and troops to carry on the Maharratta War, and the Mutiny of 1857, when the energy and coolness of the European officials, chiefly of General Neill, carried the district successfully through the storm.

The DISTRICT OF BENARES extends over both sides of the Ganges and has an area of 1008 sq. m. The surface of the country is remarkably level, with numerous deep ravines in the calcareous conglomerate. The soil is a clayey or a sandy loam, and very fertile except in the Usar tracts, where there is a saline efflorescence. The principal rivers are the Ganges, Karamnasa, Gumti and Barna. The principal crops are barley, rice, wheat, other food-grains, pulse, sugar-cane and opium. The main line of the East Indian railway runs through the southern portion of the district, with a branch to Benares city; the Oudh & Rohilkhand railway through the northern portion, starting from the city; and a branch of the Bengal & North-Western railway

also terminates at Benares. The climate of Benares is cool in winter but very warm in the hot season. The population in 1901 was 282,084, showing a decrease of 4% in the decade due to the effects of famine.

The DIVISION OF BENARES has an area of 10,431 sq. m., and comprises the districts of Benares, Mirzapur, Jaunpur, Ghazipur and Ballia. In 1901 the population was 5,069,020, showing a decrease of 6% in the decade.

See E. B. Havell, *Benares* (1906); M. A. Sherring, *The Sacred City of the Hindus* (1868).

BENBOW, JOHN (1653-1702), English admiral, the son of a tanner in Shrewsbury, was born in 1653. He went to sea when very young, and served in the navy as master's mate and master, from 1678 to 1681. When trading to the Mediterranean in 1686 in a ship of his own he beat off a Sall pirate. On the accession of William III. he re-entered the navy as a lieutenant and was rapidly promoted. It is probable that he enjoyed the protection of Arthur Herbert, earl of Torrington, under whom he had already served in the Mediterranean. After taking part in the bombardment of St Malo (1693), and superintending the blockade of Dunkirk (1696), he sailed in 1698 for the West Indies, where he compelled the Spaniards to restore two vessels belonging to the Scottish colonists at Darien (see PATERSON, WILLIAM) which they had seized. On his return he was appointed vice-admiral, and was frequently consulted by the king. In 1701 he was sent again to the West Indies as commander-in-chief. On the 10th of August 1702, when cruising with a squadron of seven ships, he sighted, and chased, four French vessels commanded by M. du Casse near Santa Marta. The engagement is the most disgraceful episode in English naval history. Benbow's captains were mutinous, and he was left unsupported in his flagship the "Breda." His right leg was shattered by a chain-shot, despite which he remained on the quarter-deck till morning, when the flagrant disobedience of the captains under him, and the disabled condition of his ship, forced him reluctantly to abandon the chase. After his return to Jamaica, where his subordinates were tried by court-martial, he died of his wounds on the 4th of November 1702. A great deal of legendary matter has collected round his name, and his life is really obscure.

See Yonge's *Hist. of the British Navy*, vol. i.; Campbell's *British Admirals*, vol. iii.; also Owen and Blakeway's *History of Shrewsbury*.

BENCE-JONES, HENRY (1814-1873), English physician and chemist, was born at Thorington Hall, Suffolk, in 1814, the son of an officer in the dragoon guards. He was educated at Harrow and Trinity College, Cambridge. Subsequently he studied medicine at St George's hospital, and chemistry at University College, London. In 1841 he went to Giessen in Germany to work at chemistry with Liebig. Besides becoming a fellow, and afterwards senior censor, of the Royal College of Physicians, and a fellow of the Royal Society, he held the post of secretary to the Royal Institution for many years. In 1846 he was elected physician to St George's hospital. He died in London on the 20th of April 1873. Dr Bence-Jones was a recognized authority on diseases of the stomach and kidneys. He wrote, in addition to several scientific books and a number of papers in scientific periodicals, *The Life and Letters of Faraday* (1870).

BENCH (an O.E. and Eng. form of a word common to Teutonic languages, cf. Ger. *Bank*, Dan. *baenk* and the Eng. doublet "bank"), a long narrow wooden seat for several persons, with or without a back. While the chair was yet a seat of state or dignity the bench was ordinarily used by the commonalty. It is still extensively employed for other than domestic purposes, as in schools, churches and places of amusement. Bench or Banc, in law, originally was the seat occupied by judges in court; hence the term is used of a tribunal of justice itself, as the King's Bench, the Common Bench, and is now applied to judges or magistrates collectively as the "judicial bench," "bench of magistrates." The word is also applied to any seat where a number of people sit in an official capacity, or as equivalent to the dignity itself, as "the civic bench," the "bench of aldermen," the "episcopal bench," the "front bench," i.e. that reserved for the leaders of either party in the British House of Commons. King's Bench

(*q.v.*) was one of the three superior courts of common law at Westminster, the others being the common pleas and the exchequer. Under the Judicature Act 1873, the court of king's bench became the king's bench division of the High Court of Justice. The court of common pleas was sometimes called the common bench.

Sittings in banc were formerly the sittings of one of the superior courts of Westminster for the hearing of motions, special cases, &c., as opposed to the *nisi prius* sittings for trial of facts, where usually only a single judge presided. By the Judicature Act 1873 the business of courts sitting in banc was transferred to divisional courts.

BENCH-MARK, a surveyor's mark cut in stone or some durable material, to indicate a point in a line of levels for the determination of altitudes over a given district. The name is taken from the "angle-iron" which is inserted in the horizontal incision as a "bench" or support for the levelling staff. The mark of the "broad-arrow" is generally incised with the bench-mark so that the horizontal bar passes through its apex.

BENCH TABLE (Fr. *banc*; Ital. *scdile*; Ger. *Bank*), the stone seat which runs round the walls of large churches, and sometimes round the piers; it very generally is placed in the piers.

BEND. (1) (From Old Eng. *bendan*), a bending or curvature, as in "the bend of a river," or technically the ribs or "wales" of a ship. (2) (From Old Eng. *bindan*, to bind), a nautical term for a knot, the "cable bend," the "fisherman's bend." (3) (From the Old Fr. *bende*, a ribbon), a term of heraldry, signifying a diagonal band or stripe across a shield from the dexter chief to the sinister base; also in tanning, the half of a hide from which the thinner parts have been trimmed away, "bend-leather" being the thickest and best sole-leather.

BENDA, the name of a family of German musicians, of whom the most important is Georg (d. 1795), who was a pupil of his elder brother Franz (1709-1786), *concertmeister* in Berlin. Georg Benda was a famous clavier player and oboist, but his chief interest for modern musical history lies in his melodramas. Being a far more solid musician than Rousseau he earns the title of the musical pioneer of that art-form (*i.e.* the accompaniment of spoken words by illustrative music) in a sense which cannot be claimed for Rousseau's earlier *Pygmalion*. Benda's first melodrama, *Ariadne auf Naxos*, was written in 1774 after his return from a visit to Italy. He was a voluminous composer, whose works (instrumental and dramatic) were enthusiastically taken up by the aristocracy in the time of Mozart. Mozart's imagination was much fired by Benda's new vehicle for dramatic expression, and in 1778 he wrote to his father with the greatest enthusiasm about a project for composing a duodrama on the model of Benda's *Ariadne auf Naxos* and *Medea*, both of which he considered excellent and always carried about with him. He concluded at the time that that was the way the problems of operatic recitative should be solved, or rather shelved, but the only specimen he has himself produced is the wonderful melodrama in his unfinished operetta, *Zaide*, written in 1780.

BENDER (more correctly **BENDERY**), a town of Russia, in the government of Bessarabia, on the right bank of the Dniester, 37 m. by rail S.E. of Kishinev. It possesses a tobacco factory, candle-works and brick-kilns, and is an important river port, vessels discharging here their cargoes of corn, wine, wool, cattle, flour and tallow, to be conveyed by land to Odessa and to Yassy in Rumania. Timber also is floated down the Dniester. The citadel was dismantled in 1807. The town had in 1867 a population of 24,443, and in 1900 of 33,741, the greater proportion being Jews. As early as the 12th century the Genoese had a settlement on the site of Bender. In 1709 Charles XII., after the defeat of Poltava, collected his forces here in a camp which they called New Stockholm, and continued there till 1713. Bender was taken by the Russians in 1770, in 1780 and in 1806, but it was not held permanently by Russia till 1812.

BENDIGO (formerly **SANDBURST**), a city of Bendigo county, Victoria, Australia, 101 m. by rail N.N.W. of Melbourne. Pop. (1901) 31,020. It is the centre of a large gold-field consisting

of quartz ranges, with some alluvial deposits, and many of the mines are deep-level workings. The discovery of alluvial gold in 1851 brought many immigrants to the district; but the opening up of the quartz reefs in 1872 was the principal factor in the importance of Bendigo. It became a municipality in 1855 and a city in 1871. It is the seat of Anglican and Roman Catholic bishops. Besides mining, the local industries are the manufacture of Epsom pottery, bricks and tiles, iron-founding, stone-cutting, brewing, tanning and coach-building. The surrounding district produces quantities of wheat and fruits for export, and much excellent wine is made.

BENDL, KAREL or **KARL** (1838-1897), Bohemian composer, was born on the 16th of April 1838 at Prague. He studied at the organ school, and in 1858 had already composed a number of small choral works. In 1861 his *Polstuje holubice* won a prize and at once became a favourite with the local choral societies. In 1864 Bendl went to Brussels, where for a short time he held the post of second conductor of the opera. After visiting Amsterdam and Paris he returned to Prague. Here in 1865 he was appointed conductor of the choral society known as *Hlahoe*, and he held the post until 1879, when Baron Dervies engaged his services for his private band. Bendl's first opera *Lejla* was successfully produced in 1868. It was followed by *Bretislav a Jitka* (1870), *Stary Zenich*, a comic opera (1883), *Karel Skreta* (1883), *Dite Tabora*, a prize opera (1892), and *Malki Mila* (1891). Other operas by Bendl are *Indicka princezna*, *Cernohori*, a prize opera, and the two operas *Carovny Kvet* and *Gina*. His ballad *Svanda dudak* acquired much popularity; he published a mass in D minor for male voices and another mass for a mixed choir; two songs to *Ave Maria*; a violin sonata and a string quartet in F; and a quantity of songs and choruses, many of which have come to be regarded as national possessions of Bohemia. Bendl died on the 20th of September 1897 at Prague.

BENEDEK, LUDWIG, RITTER VON (1804-1881), Austrian general, was born at Ödenburg in Hungary on the 14th of July 1804, his father being a doctor. He received his commission in the Austrian army as ensign in 1822, becoming lieutenant in 1825, first lieutenant in 1831 and captain in 1835. He was employed for a considerable time in the general staff, and had risen to the rank of colonel, when he won his first laurels in the suppression of the rising of 1846 in Galicia (see *AUSTRIA: History*). In this campaign his bold leadership in the field and his capacity for organization were so far conspicuous that he was made a *Ritter* (knight) of the Leopold order by his sovereign, and a freeman (*Ehrenbürger*) by the city of Lemberg. In 1847 he commanded a regiment in Italy, and on the outbreak of war with Sardinia he was placed in command of a mixed brigade, at the head of which he displayed against regular troops the same qualities of unhesitating bravery and resolution which had given him the victory in many actions with the Galician rebels. His conduct at Curtatone won for him the commandership of the Leopold order, and shortly afterwards the knighthood of the Maria Theresa order. At the action of Mortara his tactical skill and bravery were again conspicuous, and Radetzky particularly distinguished him in despatches. The archduke Albert, with whom he served, is said to have given him the sword of his father, the great archduke Charles. He was promoted major-general soon afterwards over the heads of several colonels senior to him, and was sent as a brigade commander to Hungary. Again he was distinguished as a fighting general at Raab, Komorn, Szegedin and many other actions, and was three times wounded. Benedek then received the cross for military merit, and soon afterwards was posted to the staff of the army in Italy. In 1852 he was made lieutenant field marshal, and in 1857 commander successively of the II., the IV., and the VIII. corps, and also a *Geheimrath*. In the political crisis of 1854 he had command of a corps in the army of observation under Hess on the Turkish frontier. In the war of 1859 in Italy, Benedek commanded the VIII. corps, and at the battle of Solferino was in command of the right of the Austrian position. That portion of the struggle which was fought out between Benedek and the Piedmontese army is sometimes called

the battle of San Martino. Benedek, with magnificent gallantry, held his own all day, and in the end covered the retreat of the rest of the Austrian army to the Mincio. His reward was the commandship of the order of Maria Theresa, and Vienna and many other cities followed the example of Lemberg in 1846. His reputation was now at its highest, and his great popularity was enhanced, in the prevailing discontent with the reactionary and clerical government of previous years, by the fact that he was a Protestant and not of noble birth. He was promoted *Feldzeugmeister* and in 1860 appointed quartermaster-general to the army, and soon afterwards governor-general and commander-in-chief in Hungary, in succession to the archduke Albert. In 1861 he was made commander-in-chief in Venetia and the adjoining provinces of the empire, and in the following year he received the grand cross of the Leopold order. In 1864 he resigned the quartermaster-generalship and devoted himself exclusively to the command of the army in Italy. In 1861 he had been made a life-member of the house of peers. In 1866 war with Prussia and with Italy became imminent. Benedek was appointed to command the Army of the North against the Prussians, the control of affairs in Italy being taken over by the archduke Albert. For the story of the campaign of Königgrätz, in which the Austrians under Benedek's command were decisively defeated, see SEVEN WEEKS' WAR. Benedek took over his new command as a stranger to the country and to the troops. Only the personal command of the emperor and the requests of the archduke Albert prevailed upon him to "sacrifice his honour," as he himself said, in a task for which he felt himself ill prepared. When he took the field his despondency was increased by the passive obstruction which he met with amongst his own officers, many of whom resented being placed under a man of the middle class instead of the archduke Albert, and by the general state of unpreparedness which he found existing at the front. Further, his own staff was self-willed to the verge of disloyalty, and his assistants, Lieutenant Field Marshal von Henikstein, and Major-General Krismanic in particular, endeavoured to control Benedek's operations in the spirit of the 18th-century strategists. Under these circumstances, and against the superior numbers, moral and armament of the Prussians, the Austrians were foredoomed to defeat. A series of partial actions convinced Benedek that success was unattainable, and he telegraphed to the emperor advising him to make peace; the emperor refused on the ground that no decisive battle had been fought; Benedek, thereupon, instead of retreating across the Elbe, determined to bring on a decisive engagement, and took up a position with the whole of his forces near Königgrätz with the Elbe in his rear. Here he was completely defeated by the Prussians on the 3rd of July, but they could not prevent him from making good his retreat over the river in magnificent order on the evening of the battle. He conducted the operations of his army in retreat up to the great concentration at Vienna under the archduke Albert, and was then suspended from his command and a court-martial ordered; the emperor, however, in December determined that the inquiry should be stopped. Benedek from this time lived in absolute retirement, and having given his word of honour to the archduke Albert that he would not attempt to rehabilitate himself before the world, he published no defence of his conduct, and even destroyed his papers relating to the campaign of 1866. This attitude of self-sacrificing loyalty he maintained even when on the 8th of November 1866 the official *Wiener Zeitung* published an article in which he was made responsible for all the disasters of the war. The history of the campaign from the Austrian point of view as at present known leaves much unexplained, and the published material is primarily of a controversial character. The official *Österreichs Kämpfe* speaks of the unfortunate general in the following terms: "A career full of achievements, distinction and fame deserved a less tragic close. A dispassionate judgment will not forget the ever fortunate and successful deeds which he accomplished earlier in the service of the emperor, and will ensure for him, in spite of his last heavy misfortune (*Last*), an honourable memory." Praise of his earlier career could not well be denied, and the official history is careful not to extend its eulogy to cover

the events of 1866; the recognition in these words cannot therefore be set against the general opinion of subsequent critics that Benedek was the victim of political necessities, perhaps of court intrigues. For the rest of his life Benedek lived at Graz, where he died on the 27th of April 1881.

See H. Friedjung, *Benedeks nachgelassene Papiere* (Leipzig, 1901, 3rd and enlarged ed., 1904), and *Der Kampf um die Vorherrschaft in Deutschland 1859-1866* (Stuttgart, 1897, 6th ed., 1904); v. Schlichting, *Moltke und Benedek* (Berlin, 1900), also therewith A. Krauss, *Moltke, Benedek und Napoleon* (Vienna, 1901); and a *roman à clé* by Graf von Salburg, entitled *Königs Glaube* (Dresden, 1906). The brief memoir in *Allgemeine Deutsche Biographie* represents the court view of Benedek's case.

BENEDETTI, VINCENT, COUNT (1817-1900), French diplomatist, was born at Bastia, in the island of Corsica, on the 29th of April 1817. In the year 1840 he entered the service of the French foreign office, and was appointed to a post under the marquis de la Valette, who was consul-general at Cairo. He spent eight years in Egypt, being appointed consul in 1845; in 1848 he was made consul at Palermo, and in 1851 he accompanied the marquis, who had been appointed ambassador at Constantinople, as first secretary. For fifteen months during the progress of the Crimean War he acted as chargé d'affaires. In the second volume of his essays he gives some recollections of his experiences in the East, including an account of Mehemet Ali, and a (not very friendly) sketch of Lord Stratford de Redcliffe. In 1855, after refusing the post of minister at Teheran, he was employed in the foreign office at Paris, and acted as secretary to the congress at Paris (1855-1856). During the next few years he was chiefly occupied with Italian affairs, in which he was much interested, and Cavour said of him he was an Italian at heart. He was chosen in 1861 to be the first envoy of France to the king of Italy, but he resigned his post next year on the retirement of E. A. Thouvenel, who had been his patron, when the anti-Italian party began to gain the ascendancy at Paris. In 1864 he was appointed ambassador at the court of Prussia.

Benedetti remained in Berlin till the outbreak of war in 1870, and during these years he played an important part in the diplomatic history of Europe. His position was a difficult one, for Napoleon did not keep him fully informed as to the course of French policy. In 1866, during the critical weeks which followed the attempt of Napoleon to intervene between Prussia and Austria, he accompanied the Prussian headquarters in the advance on Vienna, and during a visit to Vienna he helped to arrange the preliminaries of the armistice signed at Nikolsburg. It was after this that he was instructed to present to Bismarck French demands for "compensation," and in August, after his return to Berlin, as a result of his discussions with Bismarck a draft treaty was drawn up, in which Prussia promised France her support in the annexation of Belgium. This treaty was never concluded, but the draft, which was in Benedetti's handwriting, was kept by Bismarck and, in 1870, a few days after the outbreak of the war, was published by him in *The Times*. During 1867 Benedetti was much occupied with the affair of Luxemburg. In July 1870, when the candidature of the prince of Hohenzollern for the throne of Spain became known, Benedetti was instructed by the duc de Gramont to present to the king of Prussia, who was then at Ems, the French demands, that the king should order the prince to withdraw, and afterwards that the king should promise that the candidature would never be renewed. This last demand Benedetti submitted to the king in an informal meeting on the promenade at Ems, and the misleading reports of the conversation which were circulated were the immediate cause of the war which followed, for the Germans were led to believe that Benedetti had insulted the king, and the French that the king had insulted the ambassador. Benedetti was severely attacked in his own country for his conduct as ambassador, and the duc de Gramont attempted to throw upon him the blame for the failures of French diplomacy. He answered the charges brought against him in a book, *Ma Mission en Prusse* (Paris, 1871), which still remains one of the most valuable authorities for the study of Bismarck's diplomacy. In this Benedetti successfully defends himself, and shows that he had kept his government well informed; he had

even warned them a year before as to the proposed Hohenzollern candidature. Even if he had been outwitted by Bismarck in the matter of the treaty of 1866, the policy of the treaty was not his, but was that of E. Drouyn de Lhuys. The idea of the annexation of part of Belgium to France had been suggested to him first by Bismarck; and the use to which Bismarck put the draft was not one which he could be expected to anticipate, for he had carried on the negotiations in good faith. After the fall of the Empire he retired to Corsica. He lived to see his defence confirmed by later publications, which threw more light on the secret history of the times. He published in 1895 a volume of *Essais diplomatiques*, containing a full account of his mission to Ems, written in 1873; and in 1897 a second series dealing with the Eastern question. He died on the 28th of March 1900, while on a visit to Paris. He received the title of count from Napoleon.

See Rothan, *La Politique Française en 1866* (Paris, 1879); and *L'Affaire de Luxembourg* (Paris, 1881); Sorel, *Histoire diplomatique* (Paris, 1885); Sybel, *Die Begründung des deutschen Reiches* (Munich, 1889), &c. (J. W. H. E.)

BENEDICT (BENEDICTUS), the name taken by fourteen of the popes.

BENEDICT I. was pope from 573 to 578. He succeeded John III., and occupied the papal chair during the incursions of the Lombards, and during the series of plagues and famines which followed these invasions.

BENEDICT II. was pope from 684 to 685. He succeeded Leo II., but although chosen in 683 he was not ordained till 684, because the leave of the emperor Constantine was not obtained until some months after the election.

BENEDICT III. was pope from 855 to 858. He was chosen by the clergy and people of Rome, but the election was not confirmed by the emperor, Louis II., who appointed an anti-pope, Anastasius (the librarian). But the candidature of this person, who had been deposed from the presbyterate under Leo IV., was indefensible. The imperial government at length recognized Benedict and discontinued its opposition, with the result that he was at last successful. The mythical pope Joan is usually placed between Benedict and his predecessor, Leo IV.

BENEDICT IV. was pope from 900 to 903.

BENEDICT V. was pope from 964 to 965. He was elected by the Romans on the death of John XII. The emperor Otto I. did not approve of the choice, and carried off the pope to Hamburg, where he died.

BENEDICT VI. was pope from 972 to 974. He was chosen with great ceremony and installed pope under the protection of the emperor, Otto the Great. On the death of the emperor the turbulent citizens of Rome renewed their outrages, and the pope himself was strangled by order of Crescentius, the son of the notorious Theodora, who replaced him by a deacon called Franco. This Franco took the name of Boniface VII.

BENEDICT VII. was pope from 974 to 983. He was elected through the intervention of a representative of the emperor, Count Sicco, who drove out the intruder Franco (afterwards Pope Boniface VII.). Benedict governed Rome quietly for nearly nine years, a somewhat rare thing in those days.

BENEDICT VIII., pope from 1012 to 1024, was called originally Theophylactus. He was a member of the family of the count of Tusculum, and was opposed by an anti-pope, Gregory, but defeated him with the aid of King Henry II. of Saxony, whom he crowned emperor in 1014. In his pontificate the Saracens began to attack the southern coasts of Europe, and effected a settlement in Sardinia. The Normans also then began to settle in Italy. In Italy Benedict supported the policy of the emperor, Henry II., and at the council of Pavia (1022) exerted himself in favour of ecclesiastical discipline, then in a state of great decadence.

BENEDICT IX., pope from 1033 to 1056, son of Alberic, count of Tusculum, and nephew of Benedict VIII., was also called Theophylactus. He was installed pope at the age of twelve through the influence of his father. The disorders of his conduct, though tolerated by the emperors, Conrad II. and Henry III., who were then morally responsible for the pontificate, at length disgusted the Romans, who drove him out in 1044 and appointed

Silvester III. his successor. Silvester remained in the papal chair but a few weeks, as the people of Tusculum quickly recovered their influence and reinstated their pope. Benedict, however, was obliged to bow before the execration of the Romans. He sold his rights to his godfather, the priest Johannes Gratianus, who was installed under the name of Gregory VI. (1045). The following year Henry III. obtained at the council of Sutri the deposition of the three competing popes, and replaced them by Suidger, bishop of Bamberg, who took the name of Clement II. But before the close of 1047 Clement II. died, probably from poison administered by Benedict, who was reinstated for the third time. At last, on the 17th of July 1048, the marquis of Tuscany drove him from Rome, where he was never seen again. He lived several years after his expulsion and appears to have died impenitent.

BENEDICT X. (Johannes "Mincius," i.e. the lout or dolt, bishop of Velletri) was pope from 1058 to 1059. He was elected on the death of Stephen IX. through the influence of the Roman barons, who, however, had pledged themselves to take no action without Hildebrand, who was then absent from Rome. Hildebrand did not recognize him, and put forward an opposition pope in the person of Gerard, bishop of Florence (pope as Nicholas II.), whom he supported against the Roman aristocracy. With the help of the Normans, Hildebrand seized the castle of Galeria, where Benedict had taken refuge, and degraded him to the rank of a simple priest. (L. D.)*

BENEDICT XI. (Niccolo Boccasini), pope from 1303 to 1304, the son of a notary, was born in 1240 at Treviso. Entering the Dominican order in 1254, he became lector, prior of the convent, provincial of his order in Lombardy, and in 1296 its general. In 1298 he was created cardinal priest of Santa Sabina, and in 1300 cardinal bishop of Ostia and Velletri. In 1302 he was papal legate in Hungary. On the 22nd of October 1303 he was unanimously elected pope. He did much to conciliate the enemies made by his predecessor Boniface VIII., notably France, the Colonnas and King Frederick II. of Sicily; nevertheless on the 7th of June 1304 he excommunicated William of Nogaret and all the Italians who had captured Boniface in Anagni. Benedict died at Perugia on the 7th of July 1304; as he was really poisoned, as report had it, suspicion would fall primarily on Nogaret. His successor Clement V. transferred the papal residence to Avignon. Among Benedict's works are commentaries on part of the Psalms and on the Gospel of Matthew. His beatification took place in 1733.

See C. Grandjean, "Registres de Benoît XI." (Paris, 1883 ff.), *Bibliothèque des Écoles françaises d'Athènes et de Rome*.

BENEDICT XII. (Jacques Fournier), pope from 1334 to 1342, the son of a miller, was born at Saverdun on the Arriège. Entering the Cistercian cloister Bolbonne, and graduating doctor of theology at Paris, he became in 1311 abbot of Fontfroide, in 1317 bishop of Pamiers and in 1326 of Mirepoix. Created cardinal priest of Santa Prisca in 1327 by his uncle John XXII. He was elected his successor on the 20th of December 1334. Benedict made appointments carefully, reformed monastic orders and consistently opposed nepotism. Unable to remove his capital to Rome or to Bologna, he began to erect a great palace at Avignon. In 1336 he decided against a pet notion of John XXII. by saying that souls of saints may attain the fullness of the beatific vision *before* the last judgment. In 1339 he entered upon fruitless negotiations looking toward the reunion of the Greek and Roman churches. French influence made futile his attempt to come to an understanding with the emperor Louis the Bavarian. He died on the 25th of April 1342.

See the source publications of G. Daumet (*Lettres closes, patentes et curiales*, . . . Paris, 1899 ff.), and J.-M. Vidal (*Lettres communes*, . . . Paris, 1903 ff.). (W. W. R.)*

BENEDICT XIII. (Pedro de Luna), (c. 1328-1422 or 1423), anti-pope, belonged to one of the most noble families in Aragon. His high birth, his legal learning—he was for a long time professor of canon law at Montpellier—and the irreproachable purity of his life, recommended him to Pope Gregory XI., who created him cardinal in 1375. He was almost the only one who succeeded

in making a firm stand in the tumultuous conclave of 1378; but the deliberation with which he made up his mind as to the validity of the election of Urban VI. was equalled, when he took the side of Clement VII., by the ardour and resourcefulness which he displayed in defending the cause of the pope of Avignon; it was mainly to him that the latter owed his recognition by Castile, Aragon and Navarre. When elected pope, or rather anti-pope, by the cardinals of Avignon, on the 28th of September 1394, it was he who by his astuteness, his resolution, and, it may be added, by his unwavering faith in the justice of his cause, was to succeed in prolonging the lamentable schism of the West for thirty years. The hopes he had aroused that, by a voluntary abdication, he would restore unity to the church, were vain; though called upon by the princes of France to carry out his plan, abandoned by his cardinals, besieged and finally kept under close observation in the palace of the popes (1398-1403), he stood firm, and tired out the fury of his opponents. Escaping from Avignon, he again won obedience in France, and his one thought was how to triumph over his Italian rival, if necessary, by force. He yielded, however, to the instances of the government of Charles VI., and pretending that he wished to have an interview with Gregory XII., with a view to their simultaneous abdication, he advanced to Savona, and then to Porto Venere. The failure of these negotiations, for which he was only in part responsible, led to the universal movement of indignation and impatience, which ended, in France, in the declaration of neutrality (1408), and at Pisa, in the decree of deposition against the two pontiffs (1409). Benedict XIII., who had on his part tried to call together a council at Perpignan, was by this time recognized hardly anywhere but in his native land, in Scotland, and in the estates of the countship of Armagnac. He remained none the less full of energy and of illusions, repulsed the overtures of Sigismund, king of the Romans, who had come to Perpignan to persuade him to abdicate, and, abandoned by nearly all his adherents, he took refuge in the impregnable castle of Peniscola, on a rock dominating the Mediterranean (1415). The council of Constance then deposed him, as a perjurer, an incurable schismatic and a heretic (26th July 1417). After struggling with the popes of Rome, Urban VI., Boniface IX., Innocent VII. and Gregory XII., and against the popes of Pisa, Alexander V. and John XXIII., Pedro de Luna, clinging more than ever to that apostolic seat which he still professed not to desire, again took up the struggle against Martin V., although the latter was recognized throughout almost all Christendom, and, before his death (20th November 1422, or 23rd May 1423), he nominated four new cardinals in order to carry the schism on even after him.

See Fr. Ehrle, *Archiv für Lit. und Kirchengesch.* vols. v., vi., vii., viii., N. Valois, *La France et le grand schisme d'occident* (4 vols., Paris, 1896-1902); Fr. Ehrle, "Martin de Alparits chronica actuatorum temporibus domini Benedicti XIII." (*Quellen und Forschungen aus dem Geb. der Gesch., Görres-Gesellschaft, Paderborn, 1906*). (N. V.)

BENEDICT XIII. (Piero Francesco Orsini), pope from 1724 to 1730, at first styled Benedict XIV., was born on the 2nd of February 1649, of the ducal family of Orsini-Gravina. In 1667 he became a Dominican (as Vincentius Maria), studied theology and philosophy, was made a cardinal in 1672 and archbishop of Benevento in 1686. Elected pope on the 20th of May 1724, he attempted to reform clerical morals; but neither the decrees of the Latin council (1725) nor his personal precepts had much effect. He confirmed the bull *Unigenitus*; but, despite the Jesuits, allowed the Dominicans to preach the Augustinian doctrine of grace. State affairs he left entirely to the unpopular Cardinal Nicolo Coscia. He died on the 21st of February 1730. His works were published in 3 vols. at Ravenna in 1728.

BENEDICT XIV. (Prospero Lorenzo Lambertini), pope from 1740 to 1758, was born at Bologna on the 31st of March 1675. At the age of thirteen he entered the Collegium Clementinum at Rome. He served the Curia in many and important capacities, yet devoted his leisure time to theological and canonistic study. Benedict XIII. made him archbishop of Theodisia in *paribus*, then of Ancona (1727), and the next year created him cardinal priest. In 1731 Clement XII. translated him to his native city

of Bologna, where as archbishop he was both efficient and popular. He published valuable works, notably *De serorum Dei beatificatione et canonisatione*, *De sacrificio missae*, as well as a treatise on the feasts of Christ and the Virgin and of some saints honoured in Bologna. In a conclave which had lasted for months he was elected on the 17th of August 1740 the successor of Clement XII. Benedict XIV. was not merely earnest and conscientious, but of incisive intellect, and unfailingly cheerful and witty. In several respects he bettered the economic conditions of the papal states, but was disinclined to undertake the needed thorough-going reform of its administration. In foreign politics he made important concessions to Portugal, Naples, Sardinia, Spain, and was the first pope expressly to recognize the king of Prussia as such. In 1741 he issued the bull *Immensa pastorum principis*, demanding more humane treatment for the Indians of Brazil and Paraguay, and in the bulls *Ex quo singulari* (1742) and *Omnium sollicitudini* (1744) he rebuked the missionary methods of the Jesuits in accommodating their message to the heathen usages of the Chinese and of the natives of Malabar. In accord with the spirit of the age he reduced the number of holy days in several Catholic countries. To the end of his life he kept up his studies and his intercourse with other scholars, and founded several learned societies. His masterpiece, *Libri octo de synodo dioecessana*, begun in Bologna, appeared during his pontificate. He died on the 3rd of May 1758.

His works, published in twelve quarto volumes at Rome (1747-1751), appeared in more nearly complete editions at Venice in 1767 and at Prato, 1839-1846; also *Briefe Benedict's XIV.*, ed. F. X. Kraus (2nd ed., Freiburg, 1888); *Benedicti XIV. Pape opera inedita*, ed. F. Heiner (Freiburg, 1904). See Herzog-Hauck, *Real-encyclopädie*, ii. 572 ff.; Wetzler and Welter, *Kirchenlexikon*, ii. 317 ff. (W. W. R. *)

BENEDICT OF ALIGNAN (d. 1268), Benedictine abbot of Notre Dame de la Grasse (1224) and bishop of Marselles (1220), twice visited the Holy Land (1239 and 1260), where he helped the Templars build the great castle of Safet. He founded a short-lived order, the Brothers of the Virgin, suppressed by the Council of Lyons (1274), and died a Franciscan. His writings include a letter to Innocent IV. and *De destructione Castri Saphet* (Baluze, *Miscellanea*, ii.).

BENEDICT OF NURSIA, SAINT (c. 480-c. 544), the patriarch of Western monks. Our only authority for the facts of St Benedict's life is bk. ii of St Gregory's *Dialogues*. St Gregory declares that he obtained his information from four of St Benedict's disciples, whom he names; and there can be no serious reason for doubting that it is possible to reconstruct the outlines of St Benedict's career (see Hodgkin, *Italy and her Invaders*, iv. 412). A precise chronology and a pedigree have been supplied for Benedict, according to which he was born in 480, of the great family of the Anicii; but all we know is what St Gregory tells us, that he was born of good family in Nursia, near Spoleto in Umbria. His birth must have occurred within a few years of the date assigned; the only fixed chronological point is a visit of the Gothic king Totila to him in 543, when Benedict was already established at Monte Cassino and advanced in years (*Diad.* ii. 14, 15). He was sent by his parents to frequent the Roman schools, but shocked by the prevailing licentiousness he fled away. It has been usual to represent him as a mere boy at this time, but of late years various considerations have been pointed out which make it more likely that he was a young man. He went to the mountainous districts of the Abruzzi, and at last came to the ruins of Nero's palace and the artificial lake at Subiaco, 40 m. from Rome. Among the rocks on the side of the valley opposite the palace he found a cave in which he took up his abode, unknown to all except one friend, Romanus, a monk of a neighbouring monastery, who clothed him in the monastic habit and secretly supplied him with food. No one who has seen the spot will doubt that the *Sacro Speco* is indeed the cave wherein Benedict spent the three years of opening manhood in solitary prayer, contemplation and austerity. After this period of formation his fame began to spread abroad, and the monks of a neighbouring monastery induced him to become their abbot; but their lives were irregular and dissolute, and on his trying to

put down abuses they attempted to poison him. He returned to his cave, but disciples flocked to him, and in time he formed twelve monasteries in the neighbourhood, placing twelve monks in each, and himself retaining a general control over all. In time patricians and senators from Rome entrusted their young sons to his care, to be brought up as monks; in this manner came to him his two best-known disciples, Maurus and Placidius. Driven from Subiaco by the jealousy and molestations of a neighbouring priest, but leaving behind him communities in his twelve monasteries, he himself, accompanied by a small band of disciples, journeyed south until he came to Cassino, a town halfway between Rome and Naples. Climbing the high mountain that overhangs the town, he established on the summit the monastery with which his name has ever since been associated, and which for centuries was a chief centre of religious life for western Europe. He destroyed the remnants of paganism that lingered on here, and by his preaching gained the rustic population to Christianity. Few other facts of his career are known: there is record of his founding a monastery at Terracina; his death must have occurred soon after Totila's visit in 543.

Rule of St Benedict.—In order to understand St Benedict's character and spirit, and to discover the secret of the success of his institute, it is necessary, as St Gregory says, to turn to his Rule. St Gregory's characterization of the Rule as "conspicuous for its discretion" touches the most essential quality. The relation of St Benedict's Rule to earlier monastic rules, and of his institute to the prevailing monachism of his day, is explained in the article MONASTICISM. Here it is enough to say that nowadays it is commonly recognized by students that the manner of life instituted by St Benedict was not intended to be, and as a matter of fact was not, one of any great austerity, when judged by the standard of his own day (see E. C. Butler, *Lausiac History of Palladius*, part 1, pp. 251-256). His monks were allowed proper clothes, sufficient food, ample sleep. The only bodily austerities were the abstinence from flesh meat and the unbroken fast till mid-day or even 3 P.M., but neither would appear so onerous in Italy even now, as to us in northern climes. Midnight office was no part of St Benedict's Rule: the time for rising for the night office varied from 1.30 to 3.0, according to the season, and the monks had had unbroken sleep for 7½ or even 8 hours, except in the hot weather, when in compensation they were allowed the traditional Italian summer siesta after the mid-day meal. The canonical office was chanted throughout, but the directly religious duties of the day can hardly have taken more than 4 or 5 hours—perhaps 8 on Sundays. The remaining hours of the day were divided between work and reading, in the proportion (on the average of the whole year) of about 6 and 4 hours respectively. The "reading" in St Benedict's time was probably confined to the Bible and the Fathers. The "work" contemplated by St Benedict was ordinarily field work, as was natural in view of the conditions of the time and best suited to the majority of the monks; but the principle laid down is that the monks should do whatever work is most useful. There were from the beginning young boys in the monastery, who were educated by the monks according to the ideas of the time. We have seen St Benedict evangelizing the pagan population round Monte Cassino; and a considerable time each day is assigned to the reading of the Fathers. Thus the germs of all the chief works carried on by his monks in later ages were to be found in his own monastery.

The Rule consists of a prologue and 73 chapters. Though it has resisted all attempts to reduce it to an ordered scheme, and probably was not written on any set plan, still it is possible roughly to indicate its contents: after the prologue and introductory chapter setting forth St Benedict's intention, follow instructions to the abbot on the manner in which he should govern his monastery (2, 3); next comes the ascetical portion of the Rule, on the chief monastic virtues (4-7); then the regulations for the celebration of the canonical office, which St Benedict calls "the Work of God" or "the divine work," his monks' first duty, "of which nothing is to take precedence" (8-20); faults and punishments (23-30); the cellarer and property of the monastery

(31, 32); community of goods (33, 34); various officials and daily life (21, 22, 35-57); reception of monks (58-61); miscellaneous (62-73).

The most remarkable chapters, in which St Benedict's wisdom stands out most conspicuously, are those on the abbot (2, 3, 27, 64). The abbot is to govern the monastery with full and unquestioned patriarchal authority; on important matters he must consult the whole community and hear what each one, even the youngest, thinks; on matters of less weight he should consult a few of the elder monks; but in either case the decision rests entirely with him, and all are to acquiesce. He must, however, bear in mind that he will have to render an account of all his decisions and to answer for the souls of all his monks before the judgment seat of God. Moreover, he has to govern in accordance with the Rule, and must endeavour, while enforcing discipline and implanting virtues, not to sadden or "overdrive" his monks, or give them cause for "just murmuring." In these chapters pre-eminently appears that element of "discretion," as St Gregory calls it, or humanism as it would now be termed, which without doubt has been a chief cause of the success of the Rule. There is as yet no satisfactory text of the Rule, either critical or manual; the best manual text is Schmidt's *editio minor* (Regensburg, 1892). Of the many commentaries the most valuable are those of Paulus Diaconus (the earliest, c. 800), of Calmet and of Martène (Migne, *Patrol. Lat.* lxxvi.).

AUTHORITIES.—An old English translation of St Gregory's *Dialogues* is reprinted in the Quarterly Series (Burns & Oates). On St Benedict's life and Rule see Montalembert, *Monks of the West*, bk. iv.; Abbate L. Tosti, *S. Benedetto* (translated 1896); also indexes to standard general histories of the period; Thomas Hodgkin's *Italy and Her Invaders* and Gregorovius' *History of the City of Rome* may be specially mentioned. But by far the best summaries in English are those contained in the relevant portions of F. H. Dudden's *Gregory the Great* (1905), i. 107-115, ii. 160-169; on the recent criticism of the text and contents of the Rule, see Otto Zöckler, *Ashese und Mönchtum* (1897), 355-371; and E. C. Butler, articles in *Downside Review*, December 1899, and *Journal of Theological Studies*, April 1902. (E. C. B.)

BENEDICT, SIR JULIUS (1804-1885), musical composer, was born in Stuttgart on the 27th of November 1804. He was the son of a Jewish banker, and learnt composition from Hummel at Weimar and Weber at Dresden; with the latter he enjoyed for three years an intimacy like that of a son, and it was Weber who introduced him in Vienna to Beethoven on the 5th of October 1823. In the same year he was appointed Kapellmeister of the Kärnthnertheater at Vienna, and two years later (in 1825) he became Kapellmeister of the San Carlo theatre at Naples. Here his first opera, *Giocinto ed Ernesto*, was brought out in 1829, and another, written for his native city, *I Portoghesi in Goa*, was given there in 1830; neither of these was a great success, and in 1834 he went to Paris, leaving it in 1835 at the suggestion of Malibran for London, where he spent the remainder of his life. In 1836 he was given the conductorship of an operatic enterprise at the Lyceum Theatre, and brought out a short opera, *Un anno ed un giorno*, previously given in Naples. In 1838 he became conductor of the English opera at Drury Lane during the period of Balfe's great popularity; his own operas produced there were *The Gipsy's Warning* (1838), *The Bride of Venice* (1843), and *The Crusaders* (1846). In 1848 he conducted Mendelssohn's *Elijah* at Exeter Hall, for the first appearance of Jenny Lind in oratorio, and in 1850 he went to America as the accompanist on that singer's tour. On his return in 1852 he became musical conductor under Mapleson's management at Her Majesty's theatre (and afterwards at Drury Lane), and in the same year conductor of the Harmonic Union. Benedict wrote recitatives for the production of an Italian version of Weber's *Oberon* in 1860. In the same year was produced his beautiful cantata *Undine* at the Norwich festival, in which Clara Novello appeared in public for the last time. His best-known opera, *The Lily of Killarney*, written on the subject of Dion Boucault's play *Colleen Bawn* to a libretto by Oxenford, was produced at Covent Garden in 1862. His operetta, *The Bride of Song*, was brought out there in 1864. *St Cecilia*, an oratorio, was performed at the Norwich festival in 1886; *St Peter* at the Birmingham

festival of 1870; *Graziella*, a cantata, was given at the Birmingham festival of 1882, and in August 1883 was produced in operatic form at the Crystal Palace. Here also a symphony by him was given in 1873. Benedict conducted every Norwich festival from 1845 to 1878 inclusive, and the Liverpool Philharmonic Society's concerts from 1876 to 1880. He was the regular accompanist at the Monday Popular Concerts in London from their start, and with few exceptions acted as conductor of these concerts. He contributed an interesting life of Weber to the series of biographies of "Great Musicians." In 1871 he was knighted, and in 1874 was made knight commander of the orders of Franz Joseph (Austria) and Frederick (Württemberg). He died in London on the 5th of June 1885.

BENEDICT BISCOP (628?–690), also known as BISCOP BADUCING, English churchman, was born of a good Northumbrian family and was for a time a thegn of King Oswiu. He then went abroad and after a second journey to Rome (he made five altogether) lived as a monk at Lerins (665–667). It was under his conduct that Theodore of Tarsus came from Rome to Canterbury in 660, and in the same year Benedict was appointed abbot of St Peter's, Canterbury. Five years later he built the monastery of St Peter at Wearmouth, on land granted him by Ecgfrith of Northumbria, and endowed it with an excellent library. A papal letter in 678 exempted the monastery from external control, and in 682 Benedict erected a sister foundation (St Paul) at Jarrow. He died on the 12th of January 690, leaving a high reputation for piety and culture. Saxon architecture owes nearly everything to his initiative, and Bede was one of his pupils.

BENEDICTINE, a liqueur manufactured at Fécamp, France. The composition is a trade secret, but, according to König, the following are among the substances used in the manufacture of imitations of the genuine article: fresh lemon peel, cardamoms, hyssop tops, angelica, peppermint, thyme, cinnamon, nutmegs, cloves and arnica flowers. (See FÉCAMP.)

BENEDICTINES, or BLACK MONKS, monks living according to the Rule of St Benedict (*q.v.*) of Nursia. Subiaco in the Abruzzi was the cradle of the Benedictines, and in that neighbourhood St Benedict established twelve monasteries. Afterwards giving up the direction of these, he migrated to Monte Cassino and there established the monastery which became the centre whence his Rule and institute spread. From Monte Cassino he founded a monastery at Terracina. These fourteen are the only monasteries of which we have any knowledge as being founded before St Benedict's death; for the mission of St Placidus to Sicily must certainly be regarded as mere romance, nor does there seem to be any solid reason for viewing more favourably the mission of St Maurus to Gaul. There is some ground for believing that it was the third abbot of Monte Cassino who began to spread a knowledge of the Rule beyond the circle of St Benedict's own foundations. About 580–590 Monte Cassino was sacked by the Lombards, and the community came to Rome and was established in a monastery attached to the Lateran Basilica, in the centre of the ecclesiastical world. It is now commonly recognized by scholars that when Gregory the Great became a monk and turned his palace on the Caelian Hill into a monastery, the monastic life there carried out was fundamentally based on the Benedictine Rule (see F. H. Dudden, *Gregory the Great*, i. 108). From this monastery went forth St Augustine and his companions on their mission to England in 596, carrying their monachism with them; thus England was the first country out of Italy in which Benedictine life was firmly planted. In the course of the 7th century Benedictine life was gradually introduced in Gaul, and in the 8th it was carried into the Germanic lands from England. It is doubtful whether in Spain there were Benedictine monasteries, properly so called, until a later period. In many parts the Benedictine Rule met the much stricter Irish Rule of Columbanus, introduced by the Irish missionaries on the continent, and after brief periods, first of conflict and then of fusion, it gradually absorbed and supplanted it; thus during the 8th century it became, out of Ireland and other purely Celtic lands, the only rule and form of monastic

life throughout western Europe,—so completely that Charlemagne once asked if there ever had been any other monastic rule.

What may be called the inner side of Benedictine life and history is treated in the article MONASTICISM; here it is possible to deal only with the broad facts of the external history. The chief external works achieved for western Europe by the Benedictines during the early middle ages may be summed up under the following heads.

1. *The Conversion of the Teutonic Races.*—The tendency of modern historical scholarship justifies the maintenance of the tradition that St Augustine and his forty companions were the first great Benedictine apostles and missionaries. Through their efforts Christianity was firmly planted in various parts of England; and after the conversion of the country it was English Benedictines—Wilfrid, Willibrord, Swithbert, Willehad—who evangelized Friesland and Holland; and another, Winfrid or Boniface, who, with his fellow-monks Willibald and others, evangelized the greater part of central Germany and founded and organized the German church. It was Anskar, a monk of Corbie, who first preached to the Scandinavians, and other Benedictines were apostles to Poles, Prussians and other Slavonic peoples. The conversion of the Teutonic races may properly be called the work of the Benedictines.

2. *The Civilization of north-western Europe.*—As the result of their missionary enterprises the Benedictines penetrated into all these lands and established monasteries, so that by the 10th or 11th century Benedictine houses existed in great numbers throughout the whole of Latin Christendom except Ireland. These monasteries became centres of civilizing influences by the method of presenting object-lessons in organized work, in agriculture, in farming, in the arts and trades, and also in well-ordered life. The unconscious method by which such great results were brought about has been well described by J. S. Brewer (*Preface to Works of Giraldu Cambrensis, Rolls Series, iv.*) and F. A. Gasquet.

3. *Education.*—Boys were educated in Benedictine houses from the beginning, but at first they were destined to be monks. The monasteries, however, played a great part in the educational side of the Carolingian revival; and certainly from that date schools for boys destined to live and work in the world were commonly attached to Benedictine monasteries. From that day to this education has been among the recognized and principal works of Benedictines.

4. *Letters and Learning.*—This side of Benedictine life is most typically represented by the Venerable Bede, the gentle and learned scholar of the early middle ages. In those times the monasteries were the only places of security and rest in western Europe, the only places where letters could in any measure be cultivated. It was in the monasteries that the writings of Latin antiquity, both classical and ecclesiastical, were transcribed and preserved.

In a gigantic system embracing hundreds of monasteries and thousands of monks, and spread over all the countries of western Europe, without any organic bond between the different houses, and exposed to all the vicissitudes of the wars and conquests of those wild times, to say that the monks often fell short of the ideal of their state, and sometimes short of the Christian, and even the moral standard, is but to say that monks are men. Failures there have been many, and scandals not a few in Benedictine history; but it may be said with truth that there does not appear to have been ever a period of widespread or universal corruption, however much at times and in places primitive love may have waxed cold. And when such declensions occurred, they soon called forth efforts at reform and revival; indeed these constantly recurring reform-movements are one of the most striking features of Benedictine history, and the great proof of the vitality of the institute throughout the ages.

The first of these movements arose during the Carolingian revival (*c.* 800), and is associated with the name of Benedict of Aniane. Under the auspices of Charlemagne and Louis the Pious he initiated a scheme for federating into one great order, with

himself as abbot general, all the monasteries of Charles's empire, and for enforcing throughout a rigid uniformity in observance. For this purpose a synod of abbots was assembled at Aix-la-Chapelle in 817, and a series of 80 *Capitula* passed, regulating the life of the monasteries. The scheme as a whole was short-lived and did not survive its originator; but the *Capitula* were commonly recognized as supplying a useful and much-needed supplement to St Benedict's Rule on points not sufficiently provided for therein. Accordingly these *Capitula* exercised a wide influence among Benedictines even outside the empire. And Benedict of Aniane's ideas of organization found embodiment a century later in the order of Cluny (910), which for a time overshadowed the great body of mere Benedictines (see CLUNY). Here it will suffice to say that the most distinctive features of the Cluny system were (1) a notable increase and prolongation of the church services, which came to take up the greater part of the working day; (2) a strongly centralized government, whereby the houses of the order in their hundreds were strictly subject to the abbot of Cluny.

Though forming a distinct and separate organism Cluny claimed to be, and was recognized as, a body of Benedictine houses; but from that time onwards arose a number of independent bodies, or "orders," which took the Benedictine Rule as the basis of their life. The most important of these were: in the 11th and 12th centuries, the orders of Camaldulians, Vallombrosians, Fontevrault and the Cistercians, and in the 13th and 14th the Silvestrines, Celestines and Olivetans (see separate articles). The general tendency of these Benedictine offshoots was in the direction of greater austerity of life than was practised by the Black Monks or contemplated by St Benedict's Rule—some of them were semi-eremitical; the most important by far were the Cistercians, whose ground-idea was to reproduce exactly the life of St Benedict's own monastery. These various orders were also organized and governed according to the system of centralized authority devised by St Pachomius (see MONASTICISM) and brought into vogue by Cluny in the West. What has here to be traced is the history of the great body of Benedictine monasteries that held aloof from these separatist movements.

For the first four or five centuries of Benedictine history there was no organic bond between any of the monasteries; each house formed an independent autonomous family, managing its own affairs and subject to no external authority or control except that of the bishop of the diocese. But the influence of Cluny, even on monasteries that did not enter into its organism, was enormous; many adopted Cluny customs and practices and moulded their life and spirit after the model it set; and many such monasteries became in turn centres of revival and reform in many lands, so that during the 10th and 11th centuries arose free unions of monasteries based on a common observance derived from a central abbey. Fleury and Hirsau are well-known examples. Basing themselves on St Gregory's counsel to St Augustine, Dunstan, Æthelwold and Oswald adopted from the observance of foreign monasteries, and notably Fleury and Ghent, what was suitable for the restoration of English monachism, and so produced the *Concordia Regularis*, interesting as the first serious attempt to bring about uniformity of observance among the monasteries of an entire nation. In the course of the 12th century sporadic and limited unions of Black Monk monasteries arose in different parts. But notwithstanding all these movements, the majority of the great Black Monk abbeys continued to the end of the 12th century in their primeval isolation. But in the year 1215, at the fourth Lateran council, were made regulations destined profoundly to modify Benedictine polity and history. It was decreed that the Benedictine houses of each ecclesiastical province should henceforth be federated for the purposes of mutual help and the maintenance of discipline, and that for these ends the abbots should every third year meet in a provincial chapter (or synod), in order to pass laws binding on all and to appoint visitors who, in addition to the bishops, should canonically visit the monasteries and report on their condition in spirituals and temporal to the ensuing chapter. The English monks took the lead in carrying out this legislation, and in 1218 the first chapter of the province of Canterbury was held at Oxford, and up to the dissolution under

Henry VIII. the triennial chapters took place with wonderful regularity. Fitful attempts were made elsewhere to carry out the decrees, and in 1336 Benedict XII. by the bull *Benedictina* tried to give further development to the system and to secure its general observance. The organization of the Benedictine houses into provinces or chapters under this legislation interfered in the least possible degree with the Benedictine tradition of mutual independence of the houses; the provinces were loose federations of autonomous houses, the legislative power of the chapter and the canonical visitations being the only forms of external interference. The English Benedictines never advanced farther along the path of centralization; up to their destruction this polity remained in operation among them, and proved itself by its results to be well adapted to the conditions of the Benedictine Rule and life.

In other lands things did not on the whole go so well, and many causes at work during the later middle ages tended to bring about relaxation in the Benedictine houses; above all the vicious system of commendatory abbots, rife everywhere except in England. And so in the period of the reforming councils of Constance and Basel the state of the religious orders was seriously taken in hand, and in response to the public demand for reforming the Church "in head and members," reform movements were set on foot, as among others, so among the Benedictines of various parts of Europe. These movements issued in the congregational system which is the present polity among Benedictines. In the German lands, where the most typical congregation was the Bursfeld Union (1446), which finally embraced over 100 monasteries throughout Germany, the system was kept on the lines of the Lateran decree and the bull *Benedictina*, and received only some further developments in the direction of greater organization; but in Italy the congregation of S. Justina at Padua (1421), afterwards called the Cassinese, departed altogether from the old lines, setting up a highly centralized government, after the model of the Italian republics, whereby the autonomy of the monasteries was destroyed, and they were subjected to the authority of a central governing board. With various modifications or restrictions this latter system was imported into all the Latin lands, into Spain and Portugal, and thence into Brazil, and into Lorraine and France, where the celebrated congregation of St Maur (see MAURISTS) was formed early in the 17th century. During this century the Benedictine houses in many parts of Catholic Europe united themselves into congregations, usually characterized by an austerity that was due to the Tridentine reform movement.

In England the Benedictines had, from every point of view, flourished exceedingly. At the time of the Dissolution there were nearly 300 Black Benedictine houses, great and small, men and women, including most of the chief religious houses of the land (for lists see tables and maps in Gasquet's *English Monastic Life*, and *Catholic Dictionary*, art. "Benedictines"). It is now hardly necessary to say that the grave charges brought against the monks are no longer credited by serious historians (Gasquet, *Henry VIII. and the Monasteries*; J. Gairdner, *Prefaces to the relevant volumes of Calendars of State Papers of Henry VIII.*). In Mary's reign some of the surviving monks were brought together, and Westminster Abbey was restored. Of the monks professed there during this momentary revival, one, Sigebert Buckley, lived on into the reign of James I.; and being the only survivor of the Benedictines of England, he in 1607 invested with the English habit and affiliated to Westminster Abbey and to the English congregation two English priests, already Benedictines in the Italian congregation. By this act the old English Benedictine line was perpetuated; and in 1619 a number of English monks professed in Spain were aggregated by pontifical act to these representatives of the old English Benedictines, and thus was constituted the present English Benedictine congregation. Three or four monasteries of the revived English Benedictines were established on the continent at the beginning of the 17th century, and remained there till driven back to England by the French Revolution.

The Reformation and the religious wars spread havoc among the Benedictines in many parts of northern Europe; and as a consequence, in part of the rule of Joseph II. of Austria, in part of the French Revolution, nearly every Benedictine monastery in Europe was suppressed—it is said that in the early years of the 19th century scarcely thirty in all survived. But the latter half of the century witnessed a series of remarkable revivals, and first in Bavaria, under the influence of Louis I. The French congregation (which does not enjoy continuity with the Maurists) was inaugurated by Dom Guéranger in 1833, and the German congregation of Beuron in 1863. Two vigorous congregations have arisen in the United States. These are all new creations since 1830. In Italy, Spain, Portugal and Brazil only a few monasteries survive the various revolutions, and in a crippled state; but signs are not wanting of renewed life: St Benedict's own monasteries of Subiaco and Monte Cassino are relatively flourishing. In Austria, Hungary and Switzerland there are some thirty great abbeys, most of which have had a continued existence since the middle ages. The English congregation is composed of three large abbeys (Downside, Ampleforth and Woolhampton), a cathedral priory (Hereford) and a nunnery (Stanbrook Abbey, Worcester): there are besides in England three or four abbeys belonging to foreign congregations, and several nunneries subject to the bishops. Each congregation has its president, who is merely a president, with limited powers, and not a general superior like the Provincials of other orders; so that the primitive Benedictine principle of each monastery being self-contained and autonomous is preserved. Similarly each congregation is independent and self-governing, there being no superior-general or central authority, as in other orders. Leo XIII. established an international Benedictine College in Rome for theological studies, and conferred on its abbot the title of "Abbot Primate," with precedence among Black Monk abbots. He is only *primus inter pares*, and exercises no kind of superiority over the other abbots or congregations. Thus the Benedictine polity may be described as a number of autonomous federations of autonomous monasteries. The individual monks, too, belong not to the order or the congregation, but each to the monastery in which he became a monk. The chief external work of the Benedictines at the present day is secondary education; there are 114 secondary schools or *gymnasias* attached to the abbeys, wherein the monks teach over 12,000 boys; and many of the nunneries have girls' schools. In certain countries (among them England) where there is a dearth of secular priests, Benedictines undertake parochial work.

The statistics of the order (1905) show that of Black Benedictines there are over 4000 choir-monks and nearly 2000 lay brothers—figures that have more than doubled since 1880. If the Cistercians and lesser offshoots of the order be added, the sum total of choir-monks and lay brothers exceeds 11,000.

In conclusion a word must be said on the Benedictine nuns. From the beginning the number of women living the Benedictine life has not fallen far short of that of the men. St Gregory describes St Benedict's sister Scholastica as a nun (*sanctimonialis*), and she is looked upon as the foundress of Benedictine nuns. As the institute spread to other lands nunneries arose on all sides, and nowhere were the Benedictine nuns more numerous or more remarkable than in England, from Saxon times to the Reformation. A strong type of womanhood is revealed in the correspondence of St Boniface with various Saxon Benedictine nuns, some in England and some who accompanied him to the continent and there established great convents. In the early times the Benedictine nuns were not strictly enclosed, and could, when occasion called for it, freely go out of their convent walls to perform any special work: on the other hand, they did not resemble the modern active congregations of women, whose ordinary work lies outside the convent. It has to be said that in the course of the middle ages, especially the later middle ages, grave disorders arose in many convents; and this doubtless led, in the reform movements initiated by the councils of Constance and Basel, and later of Trent, to the

introduction of strict enclosure in Benedictine convents, which now is the almost universal practice. At the present day there are of Black Benedictine nuns 262 convents with 7000 nuns, the large majority being directly subject to the diocesan bishops; if the Cistercians and others be included, there are 387 convents with nearly 11,000 nuns. In England there are a dozen Benedictine nunneries.

AUTHORITIES—The chief general authority for Benedictine history up to the middle of the 12th century is Mabillon's *Annales*, in 6 vols. folio; for the later period no such general work exists, but the various countries, congregations or even abbeys have to be taken separately. Montalembert's *Monks of the West* gives the early history very fully; the later history, to the beginning of the 18th century, may be found in Helyot, *Hist. des ordres religieux*, v. and vi. (1792). A useful sketch, with references to the best literature, is in Max Heimbucher, *Orden und Kongregationen* (1896), i. §§ 17-28; see also the article "Benedictinerorden" in Wetzler u. Welter, *Kirchenlexicon* (2nd ed.), and "Benedikt von Nursia und der Benedictinerorden" in Herzog-Hauck, *Realencyklopädie* (3rd ed.). For England see Ethelred Taunton, *English Black Monks* (1897); and for the modern history (19th century) the series entitled "Succisa Virescit" in the *Downside Review*, 1880 onwards, by J. G. Dolan. On the inner spirit and working of the institute see F. A. Gasquet, *Sketch of Monastic Constitutional History* (being the preface to the 2nd ed., 1895, of the trans. of Montalembert) and *English Monastic Life* (1904); and Newman's two essays on the Benedictines, among the *Historical Sketches*. On Benedictine nuns much will be found in the above-mentioned authorities, and also in Lina Eckenstein, *Women in Monasticism* (1896). On Benedictines and the Arts see F. H. Kraus, *Geschichte der christlichen Kunst* (Freiburg-i-B., 1896-1897). (E. C. B.)

BENEDICTION (Lat. *benedictio*, from *beneficere*, to bless), generally, the utterance of a blessing or of a devout wish for the prosperity and happiness of a person or enterprise. In the usage of the Catholic Church, both East and West, though the benediction as defined above has its place as between one Christian and another, it has also a special place in the sacramental system in virtue of the special powers of blessing vested in the priesthood. Sacramental benedictions are not indeed sacraments—means of grace ordained by Christ himself,—but sacramentals (*sacramenta minor*) ordained by the authority of the Church and exercised by the priests, as the plenipotentiaries of God, in virtue of the powers conferred on them at their ordination; "that whatever they bless may be blessed, and whatever they consecrate may be consecrated." The power to bless in this ecclesiastical sense is reserved to priests alone; the blessing of the paschal candle on Holy Saturday by the deacon being the one exception that proves the rule, for he uses for the purpose grains of incense previously blessed by the priest at the altar. But though by some the benediction has thus been brought into connexion with the supreme means of grace, the sacrifice of the Mass, the blessing does not in itself confer grace and does not act on its recipients *ex opere operato*. It must not be supposed, however, that the Catholic idea of a sacerdotal blessing has anything of the vague character associated with a benediction by Protestants. Both by Catholics and by Protestants blessings may be applied to things inanimate as well as animate; but while in the reformed Churches this involves no more than an appeal to God for a special blessing, or a solemn "setting apart" of persons or objects for sacred purposes, in the Catholic idea it implies a special power, conferred by God, of the priests over the invisible forces of evil. It thus stands in the closest relation to the rite of exorcism, of which it is the complement.

According to Catholic doctrine, the Fall involved the subtraction, not only of man, but of all things animate and inanimate, to the influence of evil spirits; in support of which St Paul's epistles to the Romans (viii.) and to Timothy (1 Tim. iv. 4-5) are quoted. This belief is, of course, not specifically Christian; it has been held at all times and everywhere by men of the most various races and creeds; and, if there be any validity in the contention that that is true which has been held *semper, ubique, et ab omnibus*, no fact is better established. In general it may be said, then, that whereas exorcism is practised in order to cast out devils already in possession, benediction is the formula by which they are prevented from entering in. Protestants have condemned these formulae as so much magic, and in this

modern science tends to agree with them; but to orthodox Protestants at least Catholics have a perfect right to reply that, in taking this line, they are but repeating the accusation brought by the Pharisees against Christ, viz. that he cast out devils "by Beelzebub, prince of the devils."

Though, however, the discomiture of malignant spirits still plays an important part in the Catholic doctrine of benedictions, this has on the whole tended to become subordinated to other benefits. This is but natural; for, though the progress of knowledge has not disproved the existence of devils, it has greatly limited the supposed range of their activities. According to Father Patrick Morrisroe, dean and professor of liturgy at Maynooth, the efficacy of benedictions is fourfold: (1) the excitation of pious emotions and affections of the heart, and by their means the remission of venial sins and of the temporal punishments due for these; (2) freedom from the power of evil spirits; (3) preservation and restoration of bodily health; (4) various other benefits, temporal and spiritual. Benedictions, moreover, are twofold: (a) invocative, i.e. those invoking the divine benignity for persons and things without changing their condition, e.g. children or food; (b) constitutive, i.e. those which give to persons or things an indelible religious character, i.e. monks and nuns, or the furniture of the altar. The second of these brings the act of benediction into contact with the principle of consecration (*q.v.*); for by the formal blessing by the duly constituted authority persons, places and things are consecrated, i.e. reserved to sacred uses and preserved from the contaminating influence of evil spirits. Thus graveyards are consecrated, i.e. solemnly blessed in order that the powers of evil may not disturb the bodies of the faithful departed; thus, too, the blessing of bells gives them a special power against evil demons.

Though the giving of blessings as a sacerdotal function is proper to the whole order of priests, particular benedictions have, by ecclesiastical authority, been reserved for the bishops, who may, however, delegate some of them; i.e. the benediction of abbots, of priests at their ordination, of virgins taking the veil, of churches, cemeteries, oratories, and of all articles for use in connexion with the altar (chalices, patens, vestments, &c.), of military colours, of soldiers and of their arms. The holy oil is also blessed by bishops in the Roman Catholic Church; in the Greek Church, on the other hand, the oil for the chrism at baptism is blessed by the priest. To the pope alone is reserved the blessing of the pallium, the golden rose, the "Agnus-Dei" and royal swords; he alone, too, can issue blessings that involve some days' indulgence. The ceremonies prescribed for the various benedictions are set forth in the *Rituale Romanum* (tit. viii.). In general it is laid down (cap. i.) that the priest, in benedictions outside the Mass, shall be vested in surplice and stole, and shall give the blessing standing and bare-headed. Certain prayers are said before each benediction, after which he sprinkles the person or thing to be blessed with holy water and, where prescribed, censens them. He is attended by a minister with a vase of holy water, an *aspergillum* and a copy of the *Rituale* or missal. In all benedictions the sign of the cross is made. In the blessing of the holy water (cap. ii.), the essential instrument of all benedictions, the object is clearly to establish its potency against evil spirits. First the "creature of salt" is exorcized, "that . . . thou mayest be to all who take thee health of body and soul; that wherever thou art sprinkled every phantasy and wickedness and wife of diabolic deceit may flee and leave that place, and every unclean spirit"; a prayer to God for the blessing of the salt follows; then the "creature of water" is exorcized, "that thou mayest become exorcized water for the purpose of putting to flight every power of the enemy, that thou mayest avail to uproot and expel this enemy with all his apostate angels, by the virtue of the same our Lord Jesus Christ, &c.;" and again a prayer to God follows that the water may "become a creature in the service of His mysteries, for the driving out of demons, &c.;" In the formulae of blessings that follow, the special efficacy against devils is implied by the aspersion with holy water; the benedictions themselves are usually merely invocative of the divine protection or assistance, though, e.g., in the form for

blessing sick animals the priest prays that "all diabolic power in them may be destroyed, and that they may be ill no longer." It is to be remarked that the "laying on of hands," which in the Old and the New Testament alike is the usual "form" of blessing, is not used in liturgical benedictions, the priest being directed merely to extend his right hand towards the person to be blessed. The appendix *de Benedictionibus* to the *Rituale Romanum* contains formulae, often of much simple beauty, for blessing all manner of persons and things, from the congregation as a whole and sick men and women, to railways, ships, blast-furnaces, lime-kilns, articles of food, medicine and medical bandages and all manner of domestic animals.

The *Benediction of the Blessed Sacrament*, commonly called simply "Benediction" (Fr. *salut*, Ger. *Segen*), is one of the most popular of the services of the Roman Catholic Church. It is usually held in the afternoon or evening, sometimes at the conclusion of Vespers, Compline or the Stations of the Cross, and consists in the singing of certain hymns and canticles, more particularly the *O salutaris hostia* and the *Tantum ergo*, before the host, which is exposed on the altar in a monstrance and surrounded by not less than ten lighted candles. Often litanies and hymns to the Virgin are added. At the conclusion the priest, his shoulders wrapped in the humeral veil, takes the monstrance and with it makes the sign of the cross over the kneeling congregation, whence the name Benediction. The service, the details of which vary in different countries, is of comparatively modern origin. Father Thurston traces it to a combination in the 16th and 17th centuries of customs that had their origin in the 13th, i.e. certain guild services in honour of the Blessed Virgin, and the growing habit, resulting naturally from the doctrine of transubstantiation, of ascribing a supreme virtue to the act of looking on the Holy Sacrament.

In the reformed Churches the word "benediction" is technically confined to the blessing with which the priest or minister dismisses the congregation at the close of the service.

See the article "Benediktionen," by E. C. Achelis in Herzog-Hauck, *Realencyclopädie* (Leipzig, 1897); *The Catholic Encyclopedia* (London and New York, 1908) s. "Blessing," by P. Morrisroe, and "Benediction of the Blessed Sacrament," by Herbert Thurston, S.J.; in all of which further authorities are cited.

BENEDICTUS, the hymn of Zacharias (Luke i. 68 sqq.), so called from the opening word of the Latin version. The hymn has been used in Christian worship since at least the 9th century, and was adopted into the Anglican Order of Morning Prayer from the Roman service of matin-lauds. In the Prayer-Book of 1549 there was no alternative to the *Benedictus*; it was to be used "throughout the whole year." In 1552 the *Jubilate* was inserted without any restriction as to how often it should take the place of the *Benedictus*. Such restriction is clearly implied in the words "except when that (Benedictus) shall happen to be read in the chapter for the day, or for the Gospel on Saint John Baptist's day," which were inserted in 1662. The rubric of 1532 had this curious wording: "And after the Second Lesson shall be used and said, Benedictus in English, as followeth."

The name is also given to a part of the Roman Catholic mass service beginning *Benedictus qui venit*.

BENEDICTUS ABBAS (d. 1194), abbot of Peterborough, whose name is accidentally connected with the *Gesta Henrici Regis Secundi*, one of the most valuable of English 12th-century chronicles. He first makes his appearance in 1174, as the chancellor of Archbishop Richard, the successor of Becket in the primacy. In 1175 Benedictus became prior of Holy Trinity, Canterbury; in 1177 he received from Henry II. the abbacy of Peterborough, which he held until his death. As abbot he distinguished himself by his activity in building, in administering the finances of his house and in collecting a library. He is described in the *Chronicon Petroburgense* as "blessed both in name and deed." He belonged to the circle of Becket's admirers, and wrote two works dealing with the martyrdom and the miracles of his hero. Fragments of the former work have come down to us in the compilation known as the *Quadriologus*, which is printed in the fourth volume of J. C. Robertson's *Materials for the History*

of *Thomas Becket* (Rolls series); the miracles are extant in their entirety, and are printed in the second volume of the same collection. Benedictus has been credited with the authorship of the *Gesta Henrici* on the ground that his name appears in the title of the oldest manuscript. We have, however, conclusive evidence that Benedictus merely caused this work to be transcribed for the Peterborough library. It is only through the force of custom that the work is still occasionally cited under the name of Benedictus. The question of authorship has been discussed by Sir T. D. Hardy, Bishop Stubbs and Professor Liebermann; but the results of the discussion are negative. Stubbs conjecturally identified the first part of the *Gesta* (1170–1177) with the *Liber Tricolumnis*, a register of contemporary events kept by Richard Fitz Neal (q.v.), the treasurer of Henry II. and author of the *Dialogus de Scaccario*; the latter part (1177–1192) was by the same authority ascribed to Roger of Hoveden, who makes large use of the *Gesta* in his own chronicle, copying them with few alterations beyond the addition of some documents. This theory, so far as concerns the *Liber Tricolumnis*, is rejected by Liebermann and the most recent editors of the *Dialogus* (A. Hughes, C. G. Crump and C. Johnson, Oxford, 1902). We can only say that the *Gesta* are the work of a well-informed contemporary who appears to have been closely connected with the court and is inclined on all occasions to take the side of Henry II. The author confines himself to the external history of events, and his tone is strictly impersonal. He incorporates some official documents, and in many places obviously derives his information from others which he does not quote. There is a break in his work at the year 1177, where the earliest manuscript ends; but the reasons which have been given to prove that the authorship changes at this point are inconclusive. The work begins at Christmas 1169, and concludes in 1192; it is thus in form a fragment, covering portions of the reign of Henry II. and Richard I.

See W. Stubbs' *Gesta regis Henrici Secundi Benedicti abbatis* (2 vols., Rolls series, 1867), and particularly the preface to the first volume; F. Liebermann in *Einführung in den Dialogus de Scaccario* (Göttingen, 1875); in *Ostenglische Geschichtsquellen* (Hanover, 1892); and in Perz's *Monumenta Germaniae Historica, Scriptores*, vol. xxvii. pp. 82, 83; also the introduction to the *Dialogus de Scaccario* in the Oxford edition of 1902. (H. W. C. D.)

BENEDIX, JULIUS RODERICH (1811–1873), German dramatist and librettist, was born at Leipzig on the 21st of January 1811, and was educated at the Thomasschule at Leipzig. He joined the stage in 1831, his first engagement being with the travelling company of H. E. Bethmann in Dessau, Cöthen, Bernburg and Meiningen. Subsequently he was tenor in several theatres in Westphalia and on the Rhine, and became manager of the theatre at Wesel, where he produced a comedy, *Das bemooste Haupt* (1841), which met with great success. After an engagement in Cologne, he managed the new theatre at Elberfeld (1844–1845) and in 1849 was appointed teacher on the staff of the Rhensish school of music in Cologne. In 1855 he was appointed intendant of the municipal theatre in Frankfurt-on-Main, but retired in 1861, and died in Leipzig on the 26th of September 1873. Benedict's comedies, the scenes of which are mostly laid in upper middle-class life, still enjoy some popularity; the best-known are: *Dr Wespe*; *Die Hochzeitsreise*; *Der Vetter*; *Das Gefängnis*; *Das Lügen*; *Ein Lustspiel*; *Der Störenfried*; *Die Dienstboten*; *Aschenbrödel*; *Die zärtlichen Verwandten*. The chief characteristics of his farces are a clear plot and bright, easy and natural dialogue. Among his more serious works are: *Bilder aus dem Schauspielereleben* (Leipzig, 1847); *Der mündliche Vortrag* (Leipzig, 1859–1860); *Das Wesen des deutschen Rhythmus* (Leipzig, 1862) and, posthumously, *Die Shakespeareomanie* (1873), in which he attacks the extreme adoration of the British poet.

Benedix's *Gesammelte dramatische Werke* appeared in 27 vols. (Leipzig, 1846–1875); a selection under the title *Volkstheater* in 20 vols. (Leipzig, 1882); and a collection of smaller comedies, as *Haustheater* in 2 vols. (10th ed., Leipzig, 1891); see Benedict's autobiography in the *Gartenlaube* for 1871.

BENEFICE (Lat. *beneficium*, benefit), a term first applied under the Roman empire to portions of land, the usufruct of which was granted by the emperors to their soldiers or others

for life, as a reward or *beneficium* for past services, and as a retainer for future services. A list of all such *beneficia* was recorded in the *Book of Benefices* (*Liber Beneficiorum*), which was kept by the principal registrar of benefices (*Primiscrinus Beneficiorum*). In imitation of the practice observed under the Roman empire, the term came to be applied under the feudal system to portions of land granted by a lord to his vassal for the maintenance of the latter on condition of his rendering military service; and such grants were originally for life only, and the land reverted to the lord on the death of the vassal. In a similar manner grants of land, or of the profits of land, appear to have been made by the bishops to their clergy for life, on the ground of some extraordinary merit on the part of the grantee. The validity of such grants was first formally recognized by the council of Orleans, A.D. 511, which forbade, however, under any circumstances, the alienation from the bishoprics of any lands so granted. The next following council of Orleans, 533, broke in upon this principle, by declaring that a bishop could not reclaim from his clergy any grants made to them by his predecessor, excepting in cases of misconduct. This innovation on the ancient practice was confirmed by the subsequent council of Lyons, 566, and from this period these grants ceased to be regarded as personal, and their substance became annexed to the churches,—in other words, they were henceforth enjoyed *jure tituli*, and no longer *jure personali*. How and when the term *beneficia* came to be applied to these episcopal grants is uncertain, but they are designated by that term in a canon of the council of Mainz, 813.

The term *benefice*, according to the canon law, implies always an ecclesiastical office, *propter quod beneficium datur*, but it does not always imply a cure of souls. It has been defined to be the right which a clerk has to enjoy certain ecclesiastical revenues on condition of discharging certain services prescribed by the canons, or by usage, or by the conditions under which his office has been founded. These services might be those of a secular priest with cure of souls, or they might be those of a regular priest, a member of a religious order, without cure of souls; but in every case a benefice implied three things: (1) An obligation to discharge the duties of an office, which is altogether spiritual; (2) The right to enjoy the fruits attached to that office, which is the benefice itself; (3) The fruits themselves, which are the temporalities. By keeping these distinctions in view, the right of patronage in the case of secular benefices becomes intelligible, being in fact the right, which was originally vested in the donor of the temporalities, to present to the bishop a clerk to be admitted, if found fit by the bishop, to the office to which those temporalities are annexed. Nomination or presentation on the part of the patron of the benefice is thus the first requisite in order that a clerk should become legally entitled to a benefice. The next requisite is that he should be admitted by the bishop as a fit person for the spiritual office to which the benefice is annexed, and the bishop is the judge of the sufficiency of the clerk to be so admitted. By the early constitutions of the Church of England a bishop was allowed a space of two months to inquire and inform himself of the sufficiency of every presentee, but by the ninety-fifth of the canons of 1604, that interval has been abridged to twenty-eight days, within which the bishop must admit or reject the clerk. If the bishop rejects the clerk within that time he is liable to a *duplex querela* in the ecclesiastical courts, or to a *quare impedit* in the common law courts, and the bishop must then certify the reasons of his refusal. In cases where the patron is himself a clerk in orders, and wishes to be admitted to the benefice, he must proceed by way of petition instead of by deed of presentation, reciting that the benefice is in his own patronage, and petitioning the bishop to examine him and admit him. Upon the bishop having satisfied himself of the sufficiency of the clerk, he proceeds to institute him to the spiritual office to which the benefice is annexed, but before such institution can take place, the clerk is required to make a declaration of assent to the Thirty-nine Articles of Religion and to the Book of Common Prayer according to a form prescribed in the Clerical Subscription Act 1865, to make a declaration against

simony in accordance with that act, and to take and subscribe the oath of allegiance according to the form in the Promissory Oaths Act 1868. The bishop, by the act of institution, commits to the clerk the cure of souls attached to the office to which the benefice is annexed. In cases where the bishop himself is patron of the benefice, no presentation or petition is required to be tendered by the clerk, but the bishop having satisfied himself of the sufficiency of the clerk, collates him to the benefice and office. It is not necessary that the bishop himself should personally institute or collate a clerk; he may issue a fiat to his vicar-general, or to a special commissary for that purpose. After the bishop or his commissary has instituted the presentee, he issues a mandate under seal, addressed to the archdeacon or some other neighbouring clergyman, authorizing him to induct the clerk into his benefice,—in other words, to put him into legal possession of the temporalities, which is done by some outward form, and for the most part by delivery of the bell-ropes to the clerk, who thereupon tolls the bell. This form of induction is required to give the clerk a legal title to his *beneficium*, although his admission to the office by institution is sufficient to vacate any other benefice which he may already possess.

By a decree of the Lateran council of 1215, which was enforced in England, no clerk can hold two benefices with cure of souls, and if a beneficed clerk shall take a second benefice with cure of souls, he vacates *ipso facto* his first benefice. Dispensations, however, could be easily obtained from Rome, before the reformation of the Church of England, to enable a clerk to hold several ecclesiastical dignities or benefices at the same time, and by the Peterpence, Dispensations, &c. Act 1534, the power to grant such dispensations, which had been exercised previously by the court of Rome, was transferred to the archbishop of Canterbury, certain ecclesiastical persons having been declared by a previous statute (1529) to be entitled to such dispensations. The system of pluralities carried with it, as a necessary consequence, systematic non-residence on the part of many incumbents, and delegation of their spiritual duties in respect of their cures of souls to assistant curates. The evils attendant on this system were found to be so great that the Pluralities Act 1838 was passed to abridge the holding of benefices in plurality, and it was enacted that no person should hold under any circumstances more than two benefices, and this privilege was made subject to the restriction that his benefices were within ten statute miles of each other. By the Pluralities Act 1850, the restriction was further narrowed, so that no spiritual person could hold two benefices except the churches of such benefices were within three miles of each other by the nearest road, and the annual value of one of such benefices did not exceed £100. By this statute the term benefice is defined to mean benefice with cure of souls and no other, and therein to comprehend all parishes, perpetual curacies, donatives, endowed public chapels, parochial chapelries and chapelries or districts belonging or reputed to belong, or annexed or reputed to be annexed, to any church or chapel. The Pluralities Acts Amendment Act 1885, however, enacted that, by dispensation from the archbishop, two benefices could be held together, the churches of which are within four miles of each other, and the annual value of one of which does not exceed £200.

All benefices except those under the clear annual value of £50 pay their first fruits (one year's profits) and tenths (of yearly profits) to Queen Anne's Bounty for the augmentation of the maintenance of the poorer clergy. Their profits during vacation belong to the next incumbent. The rent charge attached to a benefice is relieved from payment of one-half of the agricultural rates assessed thereon. Benefices may be exchanged by agreement between incumbents with the consent of the ordinary, and they may, with the consent of the patron and ordinary, be united or dissolved after being united. They may also be charged with the repayment of money laid out for their permanent advantage, and be augmented wholly by the medium of Queen Anne's Bounty.

A benefice is avoided or vacated—(1) by death; (2) by resignation, if the bishop is willing to accept the resignation: by the In-

cumbents' Resignation Act 1871, Amendment Act 1887, any clergyman who has been an incumbent of one benefice continuously for seven years, and is incapacitated by permanent mental or bodily infirmities from fulfilling his duties, may, if the bishop thinks fit, have a commission appointed to consider the fitness of his resigning; and if the commission report in favour of his resigning, he may, with the consent of the patron (or, if that is refused, with the consent of the archbishop) resign the cure of souls into the bishop's hands, and have assigned to him, out of the benefice, a retiring-pension not exceeding one-third of its annual value, which is recoverable as a debt from his successor; (3) by cession, upon the clerk being instituted to another benefice or some other preferment incompatible with it; (4) by deprivation and sentence of an ecclesiastical court; under the Clergy Discipline Act 1892, an incumbent who has been convicted of offences against the law of bastardy, or against whom judgment has been given in a divorce or matrimonial cause, is deprived, and on being found guilty in the consistory court of immorality or ecclesiastical offences (not in respect of doctrine or ritual), he may be deprived or suspended or declared incapable of preferment; (5) by act of law in consequence of simony; (6) by default of the clerk in neglecting to read publicly in the church the Book of Common Prayer, and to declare his assent thereto within two months after his induction, pursuant to an act of 1662.

See also ADVOWSON; GLEBE; INCUMBENT; VICAR; also PHILLIMORE, *Eccles. Law*; CRIPPS, *Love of Church and Clergy*.

BENEFICIARY (from Lat. *beneficium*, a benefit), in law, one who holds a benefice; one who is beneficially entitled to, or interested in, property, *i.e.* entitled to it for his own benefit, and not merely holding it for others, as does an executor or trustee. In this latter sense it is nearly equivalent to *cestui que trust*, a term which it is gradually superseding in modern law.

BENEKE, FRIEDRICH EDUARD (1798-1854), German psychologist, was born at Berlin on the 17th of February 1798, studied at the universities of Halle and Berlin, and served as a volunteer in the war of 1815. After studying theology under Schleiermacher and De Wette, he turned to pure philosophy, studying particularly English writers and the German modifiers of Kantianism, such as Jacobi, Fries and Schopenhauer. In 1820 he published his *Erkenntnistheorie, his Erfahrungsetheorie als Grundlage alles Wissens*, and his inaugural dissertation *De Veris Philosophiæ Initiiis*. His marked opposition to the philosophy of Hegel, then dominant in Berlin, was shown more clearly in the short tract, *Neue Grundlegung zur Metaphysik* (1822), intended to be the programme for his lectures as privat-docent, and in the able treatise, *Grundlegung zur Physik der Sitten* (1822), written in direct antagonism to Kant's *Metaphysic of Ethics*, to deduce ethical principles from a basis of empirical feeling. In 1822 his lectures were prohibited at Berlin, according to his own belief through the influence of Hegel with the Prussian authorities, who also prevented him from obtaining a chair from the Saxon government. He retired to Göttingen, lectured there for some years, and was then allowed to return to Berlin. In 1832 he received an appointment as *professor extraordinarius* in the university, which he continued to hold till his death. On the 1st of March 1854 he disappeared, and more than two years later his remains were found in the canal near Charlottenburg. There was some suspicion that he had committed suicide in a fit of mental depression.

The distinctive peculiarity of Beneke's system consists, first, in the firmness with which he maintained that in empirical psychology is to be found the basis of all philosophy; and secondly, in his rigid treatment of mental phenomena by the genetic method. According to him, the perfected mind is a development from simple elements, and the first problem of psychology is the determination of these elements and of the processes by which the development takes place. In his *Neue Psychologie* (essays iii., viii. and ix.), he defined his position with regard to his predecessors and contemporaries, and both there and in the introduction to his *Lehrbuch* signaled as the two great stages in the progress of psychology the negation of innate ideas by Locke, and of faculties, in the ordinary acceptance of the

term, by Herbart. The next step was his own; he insisted that psychology must be treated as one of the natural sciences. As is the case with them, its content is given by experience alone, and differs from theirs only in being the object of the internal as opposed to the external sense. But by this Beneke in no wise meant a psychology founded on physiology. These two sciences, in his opinion, had quite distinct provinces and gave no mutual assistance. Just as little help is to be expected from the science of the body as from mathematics and metaphysics, both of which had been pressed by Herbart into the service of psychology. The true method of study is that applied with so much success in the physical sciences—critical examination of the given experience, and reference of it to ultimate causes, which may not be themselves perceived, but are nevertheless hypotheses necessary to account for the facts. (See on method, *Neue Psych.*, essay i.)

Starting from the two assumptions that there is nothing, or at least no formed product, innate in the mind, and that definite faculties do not originally exist, and from the fact that our minds nevertheless actually have a definite content and definite modes of action, Beneke proceeds to state somewhat dogmatically his scientifically verifiable hypotheses as to the primitive condition of the soul and the laws according to which it develops. Originally the soul is possessed of or is an immense variety of powers, faculties or forces, connected with Herbart's apperception, but which are not to be metaphysically justifiable, differing from one another only in tenuity, vivacity, receptivity and grouping. These primitive immaterial forces, so closely united as to form but one being (essence), acquire definiteness or form through the action upon them of stimuli or excitants from the outer world. This action of external impressions which are appropriated by the internal powers is the first fundamental process in the genesis of the completed mind. If the union of impression and faculty be sufficiently strong, consciousness (not self-consciousness) arises, and definite sensations and perceptions begin to be formed. These primitive sensations, however, are not to be identified with the sensations of the special senses, for each of these senses is a system of many powers which have grown into a definite unity, have been educated by experience. From ordinary experience it must be concluded that a second fundamental process is incessantly going on, viz. the formation of new powers, which takes place principally during sleep. The third and most important process results from the fact that the combination between stimulus and power may be weak or strong; if weak, then the two elements are said to be movable, and they may flow over from one to another of the already formed faculties. A newly formed faculty does not cease to exist on the removal of its stimulus; in virtue of its fundamental property, *tenacity*, it sinks back as a trace (*Spur*) into unconsciousness, whence it may be recalled by the application to it of another stimulus, or by the attraction towards it of some of the movable elements or newly-formed original powers. These traces and the flowing over of the movable elements are the most important conceptions in Beneke's psychology; by means of them he gives a rationale of reproduction and association, and strives to show that all the formed faculties are simply developments from traces of earlier processes, namely, similar forms, according to the degree of their similarity, attract one another or tend to form closer combinations.

All psychological phenomena are explicable by the relation of impression and power, and by the flow of movable elements; the whole process of mental development is nothing but the result of the action and interaction of the above simple laws. In general this growth may be said to take the direction of rendering more and more definite by repetition and attraction of like to like the originally indefinite activities of the primary faculties. Thus the intensity of the special senses are gradually formed from the primary sensitive feelings (*sinnliche Empfindungen*); concepts are formed from intuitions of individuals by the attraction of the common elements, and the consequent flow towards them of movable forms. Judgment is the springing into consciousness of a concept alongside of an intuition, or of a higher concept alongside of a lower. Reasoning is merely a more complex judgment. Nor are there special faculties of judging or reasoning. The understanding is simply the mass of concepts lying in the background of unconsciousness, ready to be called up and to flow with force towards anything closely connected with them. Even memory is not a special faculty; it is simply the fundamental property of tenacity possessed by the original faculties. The very distinction between the great classes, Knowledge, Feeling and Will, may be referred to elementary differences in the original relations of faculty and impression.

This is the groundwork of Beneke's philosophy. It should be carefully compared with the association psychology of modern British thinkers, most of whose results and processes will be found there worked into a comprehensive system (see ASSOCIATION OF IDEAS). In logic, metaphysics, ethics Beneke's speculations are naturally dependent on his psychology.

The special value of Beneke's works, as has been already said, consists in the many specimens of acute psychological analysis

scattered throughout them. As a complete explanation of psychical facts, the theory seems defective. The original hypotheses, peculiar to Beneke, on which the whole depends, are hastily assumed and rest on a clumsy mechanical metaphor. As is the case with all empirical theories of mental development, the higher categories or notions, which are apparently shown to result from the simple elements, are really presupposed at every step. Particularly unsatisfactory is the account of consciousness, which is said to arise from the union of impression and faculty. The necessity of consciousness for any mental action whatsoever is apparently granted, but the conditions involved in it are never discussed or mentioned. The same defect appears in the account of ethical judgment; no amount of empirical fact can ever yield the notion of absolute duty. His results have found acceptance mainly with practical teachers. Undoubtedly his minute analysis of temperament and careful exposition of the means whereby the young, unformed mind may be trained are of infinite value; but the truth of many of his doctrines on this points leads no support to the fundamental hypotheses, from which, indeed, they might be almost entirely severed.

Beneke was a most prolific writer, and besides the works mentioned above, published large treatises in the several departments of philosophy, both pure and as applied to education and ordinary life. A complete list of his writings will be found in the appendix to Dressler's edition of the *Lehrbuch der Psychologie als Naturwissenschaft* (1861). The chief are:—*Psychologische Skizzen* (1825, 1827); *Lehrbuch der Psychologie* (1832); *Metaphysik und Religionsphilosophie* (1840); *Die neue Psychologie* (1845); *Pragmatische Psychologie oder Seelenlehre in der Anwendung auf das Leben* (1832).

Among German writers, who, though not professed followers of Beneke, have been largely influenced by him, may be mentioned Ueberweg and Karl Forlage (1806-1881). In England, perhaps, the only writer who shows traces of acquaintance with his works is J. D. Morell (*Intro. to Mental Philosophy*). The most eminent members of the school are J. G. Dressler (whose *Beneke oder Seelenlehre als Naturwissenschaft* is an admirable exposition), Fried. Dittes and G. Rauc. The compendium by the last-named author passed through four editions in Germany, and has been translated into French, Flemish and English. The English translation, *Elements of Psychology* (1871), gives a lucid and succinct view of the whole system.

Among more recent works on Beneke are O. E. Hummel, *Die Unterrichtslehre Beneke's* (Leipzig, 1885); on his ethical theory, C. H. Th. Kühn, *Die Sittenlehre F. E. Beneke's* (1892); Joh. Friedrich, *F. E. Beneke* (Wiesbaden, 1898, with biography and list of works); Otto Gramzow, *F. E. Beneke's Leben und Philos.* (Bern, 1899, with full bibliography); on his theory of knowledge, H. Renner, *Beneke's Erkenntnistheorie* (Halle, 1902); on his metaphysics, *Die Metaphysik Beneke's*, by W. Gundlach (Berlin, 1903); Brandt, *Beneke, der Main und His Philosophy* (New York, 1895); Falckenberg, *Hist. der Phil.* (Eng. trans., 1895); and H. Höfding, *Hist. of Mod. Phil.* vol. ii. (Eng. trans., 1900).

BENETT, ETHELDRED (1776-1845), one of the earliest of English women geologists, the second daughter of Thomas Bennett, of Pyt House near Tisbury, was born in 1776. Later she resided at Norton House, near Warminster, in Wiltshire, and for more than a quarter of a century devoted herself to collecting and studying the fossils of her native county. She contributed "A Catalogue of the Organic Remains of the County of Wilts" to Sir R. C. Hoare's *County History*, and a limited number of copies of this work were printed as a separate volume (1831) and privately distributed. She died on the 11th of January 1845.

BENEVENTO, a town and archiepiscopal see of Campania, Italy, capital of the province of Benevento, 60 m. by rail and 32 m. direct N.E. of Naples, situated on a hill 400 ft. above sea-level at the confluence of the Calore and Sabbato. Pop. (1901) town, 17,227; commune, 24,137. It occupies the site of the ancient Beneventum, originally Malaventum or Maluentum, supposed in the imperial period to have been founded by Diomedes. It was the chief town of the Samnites, who took refuge here after their defeat by the Romans in 314 B.C. It appears not to have fallen into the hands of the latter until Pyrrhus's absence in Sicily, but served them as a base of operations in the last campaign against him in 275 B.C. A Latin colony was planted there in 268 B.C., and it was then that the name was changed for the sake of the omen, and probably then that the Via Appia was extended from Capua to Beneventum. It remained in the hands of the Romans during both the Punic and the Social Wars, and was a fortress of importance to them. The position is strong, being protected by the two rivers mentioned, and the medieval fortifications, which are nearly 2 m. in length, probably follow the ancient line, which was razed to the ground by Totila in

A.D. 542. After the Social War it became a *municipium* and under Augustus a colony. Being a meeting point of six main roads,¹ it was much visited by travellers. Its importance is vouched for by the many remains of antiquity which it possesses, of which the most famous is the triumphal arch erected in honour of Trajan by the senate and people of Rome in A.D. 114, with important reliefs relating to its history (E. Petersen in *Römische Mitteilungen*, 1892, 241; A. von Domaszewski in *Jahreshefte des Österreich. archäologischen Instituts*, ii., 1899, 173). There are also considerable remains of the ancient theatre, a large *cryptoporticus* 107 ft. long known as the ruins of Santi Quaranta, and probably an emporium (according to Meomartini, the portion preserved is only a fraction of the whole, which once measured 1791 ft. in length) and an ancient brick arch (called the Arco del Sacramento), while below the town is the Ponte Lebroso, a bridge of the Via Appia over the Sabbato, and along the road to Avellino are remains of *thermae*. Many inscriptions and ancient fragments may be seen built into the houses; in front of the Madonna delle Grazie is a bull in red Egyptian granite, and in the Piazza Papiniano the fragments of two Egyptian obelisks erected in A.D. 88 in front of the temple of Isis in honour of Domitian. In 1903 the foundations of this temple were discovered close to the Arch of Trajan, and many fragments of fine sculptures in both the Egyptian and the Greco-Roman style belonging to it were found. They had apparently been used as the foundation of a portion of the city wall, reconstructed in A.D. 663 under the fear of an attack by Constans, the Byzantine emperor, the temple having been destroyed under the influence of the bishop, St. Barbatius, to provide the necessary material (A. Meomartini, O. Marucchi and L. Savignoni in *Notizie degli Scavi*, 1904, 107 sqq.). Not long after it had been sacked by Totila Benevento became the seat of a powerful Lombard duchy and continued to be independent until 1053, when the emperor Henry III. ceded it to Leo IX. in exchange for the bishopric of Bamberg; and it continued to be a papal possession until 1806, when Napoleon granted it to Talleyrand with the title of prince. In 1815 it returned to the papacy, but was united to Italy in 1860. Manfred lost his life in 1266 in battle with Charles of Anjou not far from the town. Much damage has been done by earthquakes from time to time. The church of S. Sofia, a circular edifice of about 760, now modernized, the roof of which is supported by six ancient columns, is a relic of the Lombard period; it has a fine cloister of the 12th century constructed in part of fragments of earlier buildings; while the cathedral with its fine arcaded façade and incomplete square campanile (begun in 1279) dates from the 9th century and was rebuilt in 1114. The bronze doors, adorned with bas-reliefs, are good; they may belong to the beginning of the 13th century. The interior is in the form of a basilica, the double aisles being borne by ancient columns, and contains *ambones* and a candelabrum of 1311, the former resting on columns supported by lions, and decorated with reliefs and coloured marble mosaic. The castle at the highest point of the town was erected in the 14th century.

Benevento is a station on the railway from Naples to Foggia, and has branch lines to Campobasso and to Avellino.

See A. Meomartini, *Monumenti e opere d'Arte di Benevento* (Benevento, 1899); T. Ashby, *Mélanges de l'école française*, 1903, 416. (T. As.)

BENEVOLENCE (Lat. *bene*, well, and *volens*, wishing), a term for an act of kindness, or a gift of money, or goods, but used in a special sense to indicate sums of money, disguised as gifts, which were extorted by various English kings from their subjects, without consent of parliament. Among the numerous methods which have been adopted by sovereigns everywhere to obtain support from their people, that of demanding gifts has frequently found a place, and consequently it is the word and not the method which is peculiar to English history. Edward I. and Richard II.

¹ These were (1) the prolongation of the Via Appia from Capua, (2) its continuation to Tarentum and Brundisium, of which there were two different lines between Beneventum and Aquilonia at different dates (see APPIA, VIA), (3) the Via Traiana to Brundisium by Herdoniae, (4) the road to Telesia and Aesernia, (5) the road to Aesernia by Bovianum, (6) the road to Abellinum and Salernum.

had obtained funds by resorting to forced loans, a practice which was probably not unusual in earlier times. Edward IV., however, discarded even the pretence of repayment, and in 1473 the word *benevolence* was first used with reference to a royal demand for a gift. Edward was very successful in these efforts, and as they only concerned a limited number of persons he did not incur serious unpopularity. But when Richard III. sought to emulate his brother's example, protests were made which led to the passing of an act of parliament in 1484 abolishing benevolences as "new and unlawful inventions." About the same time the Chronicle of Croyland referred to a benevolence as a "nova et inaudita impositio muneris ut per benevolentium quilibet daret id quod vellet, immo verius quod nollet." In spite of this act Richard demanded a further benevolence; but it was Henry VII. who made the most extensive use of this system. In 1491 he sent out commissioners to obtain gifts of money, and in 1496 an act of parliament enforced payment of the sums promised on this occasion under penalty of imprisonment. Henry's chancellor, Cardinal Morton, archbishop of Canterbury, was the traditional author of a method of raising money by benevolences known as "Morton's Fork." If a man lived economically, it was reasoned he was saving money and could afford a present for the king. If, on the contrary, he lived sumptuously, he was evidently wealthy and could likewise afford a gift. Henry VII. obtained considerable sums of money in this manner; and in 1545 Henry VIII. demanded a "loving contribution" from all who possessed lands worth not less than forty shillings a year, or chattels to the value of £15; and those who refused to make payment were summoned before the privy council and punished. Elizabeth took loans which were often repaid; and in 1614 James I. ordered the sheriffs and magistrates in each county and borough to collect a general benevolence from all persons of ability, and with some difficulty about £40,000 was collected. Four counties had, however, distinguished themselves by protests against this demand, and the act of Richard III. had been cited by various objectors. Representatives from the four counties were accordingly called before the privy council, where Sir Edward Coke defended the action of the king, quoted the Tudor precedents and urged that the act of 1484 was to prevent exactions, not voluntary gifts such as James had requested. Subsequently Oliver St. John was fined and imprisoned for making a violent protest against the benevolence, and on the occasion of his trial Sir Francis Bacon defended the request for money as voluntary. In 1615 an attempt to exact a benevolence in Ireland failed, and in 1620 it was decided to demand one for the defence of the Palatinate. Circular letters were sent out, punishments were inflicted, but many excuses were made and only about £34,000 was contributed. In 1621 a further attempt was made, judges of assize and others were ordered to press for contributions, and wealthy men were called before the privy council and asked to name a sum at which to be rated. About £88,000 was thus raised, and in 1622 William Fiennes, 1st Viscount Saye and Sele, was imprisoned for six months for protesting. This was the last time benevolences were actually collected, although in 1622 and 1625 it was proposed to raise money in this manner. In 1633 Charles I. consented to collect a benevolence for the recovery of the Palatinate for Charles Louis, the son of his sister Elizabeth, but no further steps were taken to carry out the project.

See W. Stubbs, *Constitutional History of England*, vol. iii. (Oxford, 1895); H. Hallam, *Constitutional History of England*, vol. i. (London, 1855); T. P. Taswell-Langmead, *English Constitutional History* (London, 1896); S. R. Gardiner, *History of England, passim* (London, 1893).

BENFEY, THEODOR (1809–1881), German philologist, son of a Jewish trader at Nörten, near Göttingen, was born on the 28th of January 1809. Although originally designed for the medical profession, his taste for philology was awakened by a careful instruction in Hebrew which he received from his father. After brilliant studies at Göttingen he spent a year at Munich, where he was greatly impressed by the lectures of Schelling and Thiersch, and afterwards settled as a teacher in Frankfurt. His pursuits were at first chiefly classical, and his attention was diverted to Sanskrit by an accidental wager that he would learn enough of

the language in a few weeks to be able to review a new book upon it. This feat he accomplished, and rivalled in later years when he learned Russian in order to translate V. P. Vasiliev's work on Buddhism. For the time, however, his labours were chiefly in classical and Semitic philology. At Göttingen, whither he had returned as privat-docent, he wrote a little work on the names of the Hebrew months, proving that they were derived from the Persian, prepared the great article on India in Ersch and Grüber's *Encyclopædia*, and published from 1839 to 1842 the *Lexicon of Greek Roots* which gained him the Volney prize of the Institute of France. From this time his attention was principally given to Sanskrit. He published in 1848 his edition of the *Sāma-veda*; in 1852-1854 his *Manual of Sanskrit*, comprising a grammar and chrestomathy; in 1858 his practical Sanskrit grammar, afterwards translated into English; and in 1859 his edition of the *Pantscha Tantra*, with an extensive dissertation on the fables and mythologies of primitive nations. All these works had been produced under the pressure of poverty, the government, whether from parsimony or from prejudice against a Jew, refusing to make any substantial addition to his small salary as extra-professor at the university. At length, in 1862, the growing appreciation of foreign scholars shamed it into making him an ordinary professor, and in 1866 Benfey published the laborious work by which he is on the whole best known, his great *Sanskrit-English Dictionary*. In 1869 he wrote a history of German philological research, especially Oriental, during the 19th century. In 1878 his jubilee as doctor was celebrated by the publication of a volume of philological essays dedicated to him and written by the first scholars in Germany. He had designed to close his literary labours by a grammar of Vedic Sanskrit, and was actively preparing it when he was interrupted by illness, which terminated in his death at Göttingen on the 26th of June 1881.

A collection of his various writings was published in 1890, prefaced by a memoir by his son.

BENGAL, a province of British India, bounded on the E. by the province of Eastern Bengal and Assam, the boundary line being the Madhumati river and the Ganges; on the S. by the Bay of Bengal and Madras; on the W. by the Central Provinces and United Provinces; and on the N. by Nepal and Sikkim. It has an area of 141,580 sq. m. and a population of 54,096,806. It consists of the provinces of Behar, Orissa and Chota Nagpur, and the western portion of the Ganges valley, but without the provinces of Northern and Eastern Bengal; and is divided into the six British divisions of the presidency, Bhagalpur, Patna, Burdwan, Chota Nagpur and Orissa, and various native states. The province was reconstituted in 1905, when the Chittagong, Dacca and Rajshahi divisions, the district of Malda and the state of Hill Tippera were transferred from Bengal to a new province, Eastern Bengal and Assam; the five Hindi-speaking states of Chota Nagpur, namely Chang Bhakar, Korea, Sirguya, Udaipur and Jashpur, were transferred from Bengal to the Central Provinces; and Sambalpur and the five Oriya states of Bamra, Rairakhol, Sonpur, Patna and Kalahandi were transferred from the Central Provinces to Bengal. The province of Bengal, therefore, now consists of the thirty-three British districts of Burdwan, Birbhum, Bankura, Midnapore, Hugli, Howrah, Twenty-four Parganas, Calcutta, Nadia, Murshidabad, Jessore, Khulna, Patna, Gaya, Shahabad, Saran, Champaran, Muzaffarpur, Darbhanga, Monghyr, Bhagalpur, Purnea, Santal Parganas, Cuttack, Balasore, Angul and Khondmals, Puri, Hazaribagh, Ranchi, Palamau, Manbhum, Singhbhum and Sambalpur, and the native states of Sikkim and the tributary states of Orissa and Chota Nagpur.

The name Bengal is derived from Sanskrit geography, and applies strictly to the country stretching southwards from Bhagalpur to the sea. The ancient Banga formed one of the five outlying kingdoms of Aryan India, and was practically coterminous with the delta of Bengal. It derived its name, according to the etymology of the Pundits, from a prince of the Mahabharata, to whose portion it fell on the primitive partition of the country among the Lunar race of Delhi. But a city called

Bangala, near Chittagong, which, although now washed away, is supposed to have existed in the Mahomedan period, appears to have given the name to the European world. The word Bangala was first used by the Mussulmans; and under their rule, like the Banga of old Sanskrit times, it applied specifically to the Gangetic delta, although the later conquests to the east of the Brahmaputra were eventually included within it. In their distribution of the country for fiscal purposes, it formed the central province of a governorship, with Behar on the north-west, and Orissa on the south-west, jointly ruled by one deputy of the Delhi emperor. Under the English the name has at different periods borne very different significations. Francis Fernandez applies it to the country from the extreme east of Chittagong to Point Palmyras in Orissa, with a coast line which Purchas estimates at 600 m., running inland for the same distance and watered by the Ganges. This territory would include the Mahomedan province of Bengal, with parts of Behar and Orissa. The loose idea thus derived from old voyagers became stereotyped in the archives of the East India Company. All its north-eastern factories, from Balasore, on the Orissa coast, to Patna, in the heart of Behar, belonged to the "Bengal Establishment," and as British conquests crept higher up the rivers, the term came to be applied to the whole of northern India. The presidency of Bengal, in contradistinction to those of Madras and Bombay, eventually included all the British territories north of the Central Provinces, from the mouths of the Ganges and Brahmaputra to the Himalayas and the Punjab. In 1831 the North-Western Provinces were created, which are now included with Oudh in the United Provinces; and the whole of northern India is now divided into the four lieutenant-governorships of the Punjab, the United Provinces, Bengal, and Eastern Bengal and Assam, and the North-West Frontier Province under a commissioner.

Physical Geography.—Three sub-provinces of the present lieutenant-governorship of Bengal—namely, Bengal proper, Behar and Orissa—consist of great river valleys; the fourth, Chota Nagpur, is a mountainous region which separates them from the central India plateau. Orissa embraces the rich deltas of the Mahanadi and the neighbouring rivers, bounded by the Bay of Bengal on the S.E., and walled in on the N.W. by tributary hill states. Proceeding west, the sub-province of Bengal proper stretches to the banks of the Ganges and inland from the seaboard to the Himalayas. Its southern portion is formed by the delta of the Ganges; its northern consists of the Ganges valley. Behar lies on the north-west of Bengal proper, and comprises the higher valley of the Ganges from the spot where it issues from the United Provinces. Between Behar and Orissa lies the province of Chota Nagpur, of which a portion was given in 1905 to the Central Provinces. The valley of the Ganges, which is now divided between Bengal and Eastern Bengal and Assam, is one of the most fertile and densely-populated tracts of country in the world. It teems with every product of nature. Tea, indigo, turmeric, lac, waving white fields of the opium-poppy, wheat and innumerable grains and pulses, pepper, ginger, betel-nut, quinine and many costly spices and drugs, oil-seeds of sorts, cotton, the silk mulberry, inexhaustible crops of jute and other fibres; timber, from the feathery bamboo and coroneted palm to the iron-hearted *slit* tree—in short, every vegetable product which feeds and clothes a people, and enables it to trade with foreign nations, abounds. Nor is the country destitute of mineral wealth. The districts near the sea consist entirely of alluvial formations; and, indeed, it is stated that no substance so coarse as gravel occurs throughout the delta, or in the heart of the provinces within 400 m. of the river mouths.

The climate varies from the snowy regions of the Himalayas to the tropical vapour-bath of the delta and the burning winds of Behar. The ordinary range of the thermometer *Climate* on the plains is from about 52° F. in the coldest month to 103° in the shade in summer. A temperature below 60° is considered very cold, while with care the temperature of well-built houses rarely exceeds 95° in the hot weather. The rainfall varies from 37 in. in Behar to about 65 in. in the delta.

Lower Bengal exhibits the two typical stages in the life of a great river. In the northern districts the rivers run along the *Rivers.* valleys, receive the drainage from the country on either side, absorb broad tributaries and rush forward with an ever-increasing volume. But near the centre of the provinces the rivers enter upon a new stage of their career. Their main channels bifurcate, and each new stream so created throws off its own set of distributaries to right and left. The country which they thus enclose and intersect forms the delta of Bengal. Originally conquered by the fluvial deposits from the sea, it now stretches out as a vast dead level, in which the rivers find their velocity checked, and their current no longer able to carry along the silt which they have brought down from northern India. The streams, accordingly, deposit their alluvial burden in their channels and upon their banks, so that by degrees their beds rise above the level of the surrounding country. In this way the rivers in the delta slowly build themselves up into canals, which every autumn break through or overflow their margins, and leave their silt upon the adjacent flats. Thousands of square miles in Lower Bengal annually receive a top-dressing of virgin soil from the Himalayas,—a system of natural manuring which renders elaborate tillage a waste of labour, and defies the utmost power of over-cropping to exhaust its fertility. As the rivers creep farther down the delta, they become more and more sluggish, and their bifurcations and interlacings more complicated. The last scene of all is a vast amphibious wilderness of swamp and forest, amid whose solitudes their network of channels insensibly merges into the sea. The rivers, finally checked by the sea, deposit their remaining silt, which emerges as banks or blunted promontories, or, after a year's battling with the tide, adds a few feet or it may be a few inches to the foreshore.

The Ganges gives to the country its peculiar character and aspect. About 200 m. from its mouth it spreads out into numerous branches, forming a large delta, composed, where it borders on the sea, of a labyrinth of creeks and rivers, running through the dense forests of the Sundarbans, and exhibiting during the annual inundation the appearance of an immense sea. At this time the rice fields to the extent of many hundreds of square miles are submerged. The scene presents to a European eye a panorama of singular novelty and interest—rice fields covered with water to a great depth; the ears of grain floating on the surface; the stupendous embankments, which restrain without altogether preventing the excesses of the inundations; and peasants going out to their daily work with their cattle in canoes or on rafts. The navigable streams which fall into the Ganges intersect the country in every direction and afford great facilities for internal communication. In many parts boats can approach by means of lakes, rivulets and water-courses to the door of almost every cottage. The lower region of the Ganges is the richest and most productive portion of Bengal, abounding in valuable produce. The other principal rivers in Bengal are the Sone, Gogra, Gandak, Kusi, Tista; the Hugli, formed by the junction of the Bhagirathi and Jalangi, and farther to the west, the Damodar and Rupnarayan; and in the south-west, the Mahanadi or great river of Orissa. In a level country like Bengal, where the soil is composed of yielding and loose materials, the courses of the rivers are continually shifting from the wearing away of their different banks, or from the water being turned off by obstacles in its course into a different channel. As this channel is gradually widened the old bed of the river is left dry. The new channel into which the river flows is of course so much land lost, while the old bed constitutes an accession to the adjacent estates. Thus, one man's property is diminished, while that of another is enlarged or improved; and a distinct branch of jurisprudence has grown up, the particular province of which is the definition and regulation of the alluvial rights alike of private property and of the state.

Geology.—The greater part of Bengal is occupied by the alluvial deposits of the Ganges, but in the south-west rises the plateau of Chota Nagpur composed chiefly of gneissic rocks. The great thickness of the Gangetic alluvium is shown by a

borehole at Calcutta which was carried to a depth of about 460 ft. below the present level of the sea without entering any marine deposit. Over the surface of the gneissic rocks are scattered numerous basins of Gondwana beds. Some of these are undoubtedly faulted into their present positions, and to this they owe their preservation. In the Rajmahal Hills basaltic lava flows are interbedded with the Gondwana deposits, and in the Karharbari coalfield the Gondwana beds are traversed by dikes of mica-peridotite and basalt, which are supposed to be of the same age as the Rajmahal lavas. The Gondwana series is economically of great importance. It includes numerous seams of coal, many of which are worked on an extensive scale (at Giridih, Raniganj, &c.). The quality of the coal is good, but unfortunately it contains a large amount of ash, the average being as high as 17%.

People.—In the sub-provinces under the lieutenant-governor of Bengal dwell a great congeries of peoples, of widely diverse origin, speaking different languages and representing far separated eras of civilization. The province, in fact, became so unwieldy that this was the chief reason for its partition in 1905. The people exhibit every stage of human progress, and every type of human enlightenment and superstition from the educated classes to primitive hill tribes. On the same bench of a Calcutta college sit youths trained up in the strictest theism, others indoctrinated in the mysteries of the Hindu trinity and pantheon, with representatives of every link in the chain of superstition—from the harmless offering of flowers before the family god to the cruel rites of Kali, whose altars in the most civilized districts of Bengal, as lately as the famine of 1866, were stained with human blood. Indeed, the very word Hindu is one of absolutely indeterminate meaning. The census officers employ it as a convenient generic to include 42 millions of the population of Bengal, comprising elements of transparently distinct ethnical origin, and separated from each other by their language, customs and religious rites. But Hinduism, understood even in this wide sense, represents only one of many creeds and races found within Bengal. The other great historical cultus, which during the last twelve centuries did for the Semitic peoples what Christianity accomplished among the European Aryans, has won to itself one-fifth of the population of Bengal. The Mahomedans number some 9,000,000 in Bengal, but the great bulk of their numbers was transferred to Eastern Bengal and Assam. They consist largely of the original inhabitants of the country, who were proselytized by the successive Pathan and Mogul invasions. In the face of great natural catastrophes, such as river inundations, famines, tidal waves and cyclones of the lower provinces of Bengal, the religious instinct works with a vitality unknown in European countries. Until the British government stepped in with its police and canals and railroads, between the people and what they were accustomed to consider the dealings of Providence, scarcely a year passed without some terrible manifestation of the power and the wrath of God. Maharratta invasions from central India, piratical devastations on the sea-board, banditti who marched about the interior in bodies of 50,000 men, floods which drowned the harvests of whole districts, and droughts in which a third of the population starved to death, kept alive a sense of human powerlessness in the presence of an omnipotent fate. Under the Mahomedans a pestilence turned the capital into a silent wilderness, never again to be re-peopled. Under British rule it is estimated that 10 millions perished within the Lower Provinces alone in the famine of 1769-1770; and the first surveyor-general of Bengal entered on his maps a tract of many hundreds of square miles as bare of villages and "depopulated by the Maghs." But since the advent of British administration the history of Bengal has substantially been a record of prosperity; the teeming population of its river valleys is one of the densest in the world, and the purely agricultural districts of Saran and Muzaffarpur in the Patna division support over 900 persons to the square mile, a number hardly surpassed elsewhere except in urban areas.

Language.—Excluding immigrants the languages spoken by the people of Bengal belong to one or other of four linguistic

families—Aryan, Dravidian, Munda and Tibeto-Burman. Of these the languages of the Aryan family are by far the most important, being spoken by no less than 95% of the population according to the census of 1901. The Aryan languages are spoken in the plains by almost the whole population; the Munda and Dravidian in the Chota Nagpur plateau and adjoining tracts; and the Tibeto-Burman in Darjeeling, Sikkim and Jalpaiguri. The most important Aryan languages are Bengali (*g.v.*), Bihari, Eastern Hindi and Oriya. On the average in the province, before partition, out of every 1000 persons 528 spoke Bengali, 341 Hindi and Bihari, and 79 Oriya. As a rule Bengali is the language of Bengal proper, Hindi of Behar and Chota Nagpur, and Oriya of Orissa.

Agriculture.—The staple crop of the province is rice, to which about 66% of the cropped area is devoted. There are three harvests in the year—the *boro*, or spring rice; *aus*, or autumn rice; and *aman*, or winter rice. Of these the last or winter rice is by far the most extensively cultivated, and forms the great harvest of the year. The *aman* crop is grown on low land. In May, after the first fall of rain, a nursery ground is ploughed three times, and the seed scattered broadcast. When the seedlings make their appearance another field is prepared for transplanting. By this time the rainy season has thoroughly set in, and the field is dammed up so as to retain the water. It is then repeatedly ploughed until the water becomes worked into the soil, and the whole reduced to thick mud. The young rice is then taken from the nursery, and transplanted in rows about 9 in. apart. *Aman* rice is much more extensively cultivated than *aus*, and in favourable years is the most valuable crop, but being sown in low lands is liable to be destroyed by excessive rainfall. Harvest takes place in December or January. *Aus* rice is generally sown on high ground. The field is ploughed when the early rains set in, ten or twelve times over, till the soil is reduced nearly to dust, the seed being sown broadcast in April or May. As soon as the young plants reach 6 in. in height, the land is harrowed for the purpose of thinning the crop and to clear it of weeds. The crop is harvested in August or September. *Boro*, or spring rice, is cultivated on low marshy land, being sown in a nursery in October, transplanted a month later, and harvested in March and April. An indigenous description of rice, called *uri* or *jaradhán*, grows in certain marshy tracts. The grain is very small, and is gathered for consumption only by the poorest. Wheat forms an important food staple in Behar, whence there is a considerable export to Calcutta. Oil-seeds are very largely grown, particularly in Behar. The principal oil-seeds are *sarisha* (mustard), *til* (sesamum) and *tisi* or *masina* (linseed). Jute (*pat* or *kosta*) forms a very important commercial staple of Bengal. The cultivation of this crop has rapidly increased of late years. Its principal seat of cultivation, however, is Eastern Bengal, where the superior varieties are grown. The crop grows on either high or low lands, is sown in April and cut in August. Apart from the quantity exported and the quantity made up by hand, it supports a prosperous mill industry, chiefly in the neighbourhood of Calcutta and Howrah. In 1905 there were thirty-six jute mills in the province and 2½ million acres were cropped. The value of jute and of the goods manufactured from it represents more than a third of the aggregate value of the trade of Calcutta. Indigo used to be an important crop carried on with European capital in Behar, but of late years the industry has almost been destroyed by the invention of artificial indigo. Tea cultivation is the other great industry carried on by European capital, but that is chiefly confined to Assam, the industry in Darjeeling and the Dwaris being on a small scale. Opium is grown in Behar with its head station at Patna. The cultivation of the cinchona plant in Bengal was introduced as an experiment about 1862, and is grown on government plantations in Darjeeling.

Mineral Products.—The chief mineral product in Bengal is coal, which disputes with the gold of Mysore for the place of premier importance in the mining industries of India. The most important mine in point of area, accessibility and output is Raniganj, with an area of 500 sq. m. Another of rising importance is that of Jherria, with an area of 200 sq. m., which is situated only 16 m. to

the west of Raniganj; while Daltonganj also has an area of 200 sq. m. The small coalfield of Karharbari with an area of only 11 sq. m. yields the best coal in Bengal. Besides these four coalfields there are twenty-five others of various sizes, which are only in the initial stages of development.

Commerce.—The sea-borne trade of Bengal is almost entirely concentrated at Calcutta (*g.v.*), which also serves as the chief port for Eastern Bengal and Assam, and for the United Provinces. The principal imports are cotton piece goods, railway materials, metals and machinery, oils, sugar, cotton, twist and salt; and the principal exports are jute, tea, hides, opium, rice, oil-seeds, indigo and lac. The inter-provincial trade is mostly carried on with Eastern Bengal and Assam, the United Provinces and the Central Provinces. From the United Provinces come opium, hides, raw cotton, wheat, shellac and oil-seeds; and from Assam, tea, oil-seeds and jute. The frontier trade of Bengal is registered with Nepal, Sikkim, Tibet and Bhutan, but except with Nepal the amount is insignificant.

Railways.—Bengal is well supplied with railways, which naturally make the seaport of Calcutta as the centre of the system. South of the Ganges, the East Indian follows the river from the North-Western Provinces, with its terminus at Howrah on the Hugli, opposite Calcutta. A chord line passes by the coalfield of Raniganj, which enables this great railway to be worked more economically than any other in India. The Bengal-Nagpur, from the Central Provinces, also has its terminus at Howrah, and the section of this railway through Midnapore carries the East Coast line from Madras. North of the Ganges the Eastern Bengal runs north to Darjeeling, and maintains a service of river steamers on the Brahmaputra. The Bengal Central serves the lower Gangetic delta. Both of these have their termini at Sealdah, an eastern suburb of Calcutta. Northern Behar is traversed by the Bengal & North-Western, with an extension eastwards through Tirhoot to join the Eastern Bengal. In addition there are a few light lines and steam tramways.

Canals and Rivers.—Rivers and other waterways still carry a large part of the traffic of Bengal, especially in the Delta. The government maintains two channels through the sundarbans, known as the Calcutta and Eastern canals, and likewise does its best to keep open the Nadiya rivers, which form the communication between the main stream of the Ganges and the Hugli. There is further a route by water between Calcutta and Midnapore. The most important canals, those in Orissa (see MAHANADI) and on the Son river in southern Behar, have been constructed primarily for irrigation, though they are also used for navigation. Except as a protection against famine, expenditure on irrigation is not remunerative in Bengal, on account of the abundance of rivers, and the general dampness of the climate.

Administration.—The administration of Bengal is conducted by a lieutenant-governor, with a chief secretary, two secretaries and three under-secretaries. There is no executive council, as in Madras and Bombay; but there is a board of revenue, consisting of two members. For legislative purposes the lieutenant-governor has a council of twenty members, of whom not more than ten may be officials. Of the remaining members seven are nominated on the recommendation of the Calcutta corporation, groups of municipalities, groups of district boards, selected public associations and the senate of Calcutta university. The number of divisions or commissionerships is 6, of which Chota Nagpur ranks as "non-regulation." The number of districts is 33.

Army.—In Lord Kitchener's reconstitution of the Indian army in 1904 the old Bengal command was abolished and its place taken by the Eastern army corps, which includes all the troops from Meerut to Assam. The boundaries of the 8th division include those of the former Oudh, Allahabad, Assam and Presidency districts; and the troops now quartered in Bengal only consist of the Presidency brigade with its headquarters at Fort William.

History.—The history of so large a province as Bengal forms an integral part of the general history of India. The northern part, Behar (*g.v.*), constituted the ancient kingdom of Magadha, the nucleus of the imperial power of the successive great dynasties

See Parliamentary Papers relating to the reconstitution of the provinces of Bengal and Assam (Cd. 2658 and Cd. 2746, 1905); Colonel E. T. Dalton, *The Ethnology of Bengal* (1872); Sir W. H. Hunter, *Annals of Rural Bengal* (1868), and *Orissa* (1872); Sir H. H. Risley, *Tribes and Castes of Bengal* (1891); C. E. Buckland, *Bengal under the Lieutenant-Governors* (1901); and Sir James Bourdillon, *The Partition of Bengal* (Society of Arts, 1905).

BENGAL, BAY OF, a portion of the Indian Ocean, resembling a triangle in shape, lying between India and Burma. A zone 50 m. wide extending from the island of Ceylon and the Coromandel coast to the head of the bay, and thence southwards through a strip embracing the Andaman and Nicobar islands, is bounded by the 100 fathom line of sea bottom; some 50 m. beyond this lies the 500-fathom limit. Opposite the mouth of the Ganges, however, the intervals between these depths are very much extended by deltaic influence. The bay receives many large rivers, of which the most important are the Ganges and Brahmaputra on the north, the Irrawaddy on the east, and the Mahanadi, Godavari, Kistna and Cauvery on the west. On the west coast it has no harbours, Madras having a mere open roadstead, but on the east there are many good ports, such as Akyab, Moulmein, Rangoon and Tavoy river. The islands in the bay are very numerous, including the Andaman, Nicobar and Mergui groups. The group of islands, Cheduba and others, in the north-east, off the Burmese coast, are remarkable for a chain of mud volcanoes, which are occasionally active. Thus in December 1906 a new island of mud was thrown up, and measured 307 by 217 yds.

BENGALI, with ORIYA and ASSAMESE, three of the four forms of speech which compose the Eastern Group of the Indo-Aryan Languages (*q.v.*). This group includes all the Aryan languages spoken in India east of the longitude of Benares, and its members are the following:—

	Number of speakers in British India, 1901.
Bengali	44,624,048
Oriya	9,687,429
Assamese	1,350,846
Bihari	34,579,844
Total	90,242,167

Of these Bihari is treated separately. In the present article we shall devote ourselves to the examination of Bengali together with the two other closely connected languages. The reader is throughout assumed to be in possession of the facts described under the heads **INDO-ARYAN LANGUAGES** and **PRAKRIT**.

Bengali is spoken in the province of Bengal proper, *i.e.* in, and on both sides of; the delta of the Ganges, and also in the Eastern **Language**. Bengal portion of the province of Eastern Bengal and Assam. The name "Bengali" is an English word, derived from the English word "Bengal." Natives call the language *Bāṅga-Bhāṣā*, or the language of *Bāṅga*, *i.e.* "Bengal." "Oriyā" is the native name for the language of *Ōdra* or Orissa. Assamese, again an English word, is spoken in the Assam Valley. Its native name is *Asamiyā*, pronounced *Ōhāmiyā*. All these languages have alphabets derived from early forms of the well-known Nagari character of northern India. That of Bengali dates from about the 11th century A.D. It is a cursive script which admits of considerable speed in writing. The Assamese alphabet is the same as that of Bengali, but has one additional character to represent the sound of *w*, which has to be expressed in the former language in a very awkward fashion. In Orissa, till lately, writing was done on a talipot palm-leaf, on which the letters were scratched with an iron stylus. In such circumstances straight lines would tend to split the leaf, and accordingly the alphabet received a peculiar curved appearance typical of it and of one or two other South Indian methods of writing.

The three languages are all the immediate descendants of *Māgadhī Prakrit* (see **PRAKRIT**), the headquarters of which were in south Behar, near the modern city of Patna. From here it spread in three lines—southwards, where it developed into Oriya; south-eastwards into Bengal proper, where it became

Bengali; and eastwards, through Northern Bengal, into Assam, where it became Assamese. It thus appears that the language of Northern Bengal, though usually and conveniently treated as a dialect of Bengali, is not so in reality, but is a connecting link between Assamese and Bihari, the language of Behar. It is noteworthy that Northern Bengali and Assamese often agree in their grammar with Oriya, as against standard Bengali.

Omitting border forms of speech, Bengali, as a vernacular, has two main dialects, a western and an eastern, the former being the standard. The boundary-line between the two may be roughly put at the 80th degree of east longitude. The eastern dialect has many marked peculiarities, amongst which we may mention a tendency to dissipation, the pronunciation of *c* as *ts*, of *ch* as *s*, and of *j* as *z*. In the northern part of the tract a medial *r* is often elided, and in the extreme east there is a broader pronunciation of the vowel *a*, like that in the English word "ball." *k* is sounded like the *ch* in "loch," and both *c* and *ch* are pronounced like *s*. The letter *p* is often sounded like *w*, and *s* like *h*, which again, when initial, is dropped. The distinction between cerebral and dental letters is lost, so that the words *āḥi* and *sāi* are both pronounced 'āt. In the south-east, near Chittagong, corruption has gone even further, and the local dialect, which is practically a new language, is unintelligible to a man from Western Bengal. Throughout the eastern districts there is a strong tendency to epenthesis, *e.g.* *kāli* is pronounced *kāḥi*. A more important dialectic difference in Bengali is that between the literary speech and the vernacular. The literary vocabulary is highly Sanskritized, so much so that it is not understood by any native of Bengal who has not received special instruction in it. Its grammar preserves numerous archaic or pseudo-archaic forms, which are invariably contracted in the colloquial speech of even the most highly educated. For instance, "I do" is expressed in the literary dialect by *kariṭīchi*, but in the vernacular by *kōrci* or *kōcci*. Oriya and Assamese may be said to have no dialects. There are a few local variations, but the standard form of speech, as a whole, is used everywhere in the respective tracts where the languages are spoken.

The three languages, being all children of a common parent, present many similar features. Oriya on the whole preserves the usual accentuation of the Indo-Aryan Languages (*q.v.*), seldom having the stress syllable farther back than the antepenultimate. Bengali, on the other hand, throws the accent as far back as possible, and this produces the contracted forms which we observe in the colloquial language, the first syllable of a word being strongly accented, and the rest being hurried over. Literary Bengali preserves the full form of the word, and in reading aloud this full form is adhered to. Assamese follows Bengali in its accentuation, but the language has never been the toy of euphuism. In its literature colloquial words are employed, and are written as they are pronounced colloquially.

In the following account of the three languages, Bengali, literary and colloquial, will be primarily dealt with, and then the points of difference between it and the other two will be described. Abbreviations used: A. = Assamese, B. = Bengali, O. = Oriya, Pr. = Prakrit, Mg. Pr. = *Māgadhī Prakrit*, Skr. = Sanskrit.

Vocabulary.—As already said, Literary Bengali abounds in *tatsamas*, or words borrowed in modern times from Sanskrit (see **INDO-ARYAN LANGUAGES**), and these have also intruded themselves into the speech of the educated. So much has the false taste for these learned words obtained the mastery that, in the literary language, when a genuine Bengali or *tadbhava* word is used in literature it is frequently not put into writing, but the corresponding learned *tatsama* is written in its place, although the *tadbhava* is read. It is as though a French writer wrote *sicca* when he wished the word *seche* to be pronounced. Similarly, the Bengali word for the goddess of Fortune is *Lakṣmī*, but in books this is always written in the Skr. form *Lakṣmī*, although no Bengali would dream of saying anything but *Lakṣmī*, even when reciting a purple passage *oraisando*. In fact, the vocal organs of most Bengalis are incapable of uttering the sound connoted by the letters *Lakṣmī*. The result is that the spelling of a Bengali word rarely represents its pronunciation. Oriya also borrows freely from Sanskrit, but there is no confusion between *tatsamas* and *tadbhavas*, as in Bengali. Assamese, on the other hand, is remarkably free from these parasites, its vocabulary being mainly *tadbhava*. In Eastern Bengal, where Mussulmans predominate, there is a free use of words borrowed from Arabic and Persian.

of the Mauryas, Andhras and Guptas; and its chief town, Patna, is the ancient Pataliputra (the Palimbothra of the Greeks), once the capital of India. The Delta or southern part of Bengal lay beyond the ancient Sanskrit polity, and was governed by a number of local kings belonging to a pre-Aryan stock. The Chinese travellers, Fa Hien in the 5th century, and Hsüan Tsang in the 7th century, found the Buddhist religion prevailing throughout Bengal, but already in a fierce struggle with Hinduism—a struggle which ended about the 9th or 10th century in the general establishment of the latter faith. Until the end of the 12th century Hindu princes governed in a number of petty principalities, till, in 1199, Mahommed Bakhtiyar Khilji was appointed to lead the first Mussulman invasion into Bengal. The Mahommedan conquest of Behar dates from 1197 A.D., and the new power speedily spread southwards into the delta. From about this date until 1340 Bengal was ruled by governors appointed by the Mahommedan emperors in the north. From 1340 to 1539 its governors asserted a precarious independence, and arrogated the position of sovereigns on their own account. From 1540 to 1576 Bengal passed under the rule of the Pathan or Afghan dynasty, which commonly bears the name of Sher Shah. On the overthrow of this house by the powerful arms of Akbar, Bengal was incorporated into the Mogul empire, and administered by governors appointed by the Delhi emperor, until the treaties of 1765, which placed Bengal, Behar and Orissa under the administration of the East India Company. The Company formed its earliest settlements in Bengal in the first half of the 17th century. These settlements were of a purely commercial character. In 1620 one of the Company's factors dates from Patna; in 1624-1636 the Company established itself, by the favour of the emperor, on the ruins of the ancient Portuguese settlement of Pipplri, in the north of Orissa; in 1640-1642 an English surgeon, Gabriel Boughton, obtained establishments at Balasore, also in Orissa, and at Hugli, some miles above Calcutta. The vexations and extortions to which the Company's early agents were subjected more than once almost induced them to abandon the trade, and in 1677-1678 they threatened to withdraw from Bengal altogether. In 1685, the Bengal factors, driven to extremity by the oppression of the Mogul governors, threw down the gauntlet; and after various successes and hairbreadth escapes, purchased from the grandson of Aurangzeb, in 1696, the villages which have since grown up into Calcutta, the metropolis of India. During the next fifty years the British had a long and hazardous struggle alike with the Mogul governors of the province and the Mahratra armies which invaded it. In 1756 this struggle culminated in the great outrage known as the Black Hole of Calcutta, followed by Clive's battle of Plassey and capture of Calcutta, which avenged it. That battle, and the subsequent years of confused fighting, established British military supremacy in Bengal, and procured the treaties of 1765, by which the provinces of Bengal, Behar and Orissa passed under British administration. To Warren Hastings (1772-1785) belongs the glory of consolidating the British power, and converting a military occupation into a stable civil government. To another member of the civil service, John Shore, afterwards Lord Teignmouth (1786-1793), is due the formation of a regular system of Anglo-Indian legislation. Acting through Lord Cornwallis, then governor-general, he ascertained and defined the rights of the landholders in the soil. These landholders under the native system had started, for the most part, as collectors of the revenues, and gradually acquired certain prescriptive rights as quasi-proprietors of the estates entrusted to them by the government. In 1793 Lord Cornwallis declared their rights perpetual, and made over the land of Bengal to the previous quasi-proprietors or *samindars*, on condition of the payment of a fixed land tax. This piece of legislation is known as the Permanent Settlement of the Land Revenue. But the Cornwallis code, while defining the rights of the proprietors, failed to give adequate recognition to the rights of the under-tenants and cultivators. His Regulations formally reserved the latter class of rights, but did not legally define them, or enable the husbandmen to enforce them in the courts. After

half a century of rural disquiet, the rights of the cultivators were at length carefully formulated by Act X. of 1859. This measure, now known as the land law of Bengal, effected for the rights of the under-holders and cultivators what the Cornwallis code in 1793 had effected for those of the superior landholders. The status of each class of persons interested in the soil, from the government as suzerain, through the *samindars* or superior landholders, the intermediate tenure-holders and the under-tenants, down to the actual cultivator, is now clearly defined. The act dates from the first year after the transfer of India from the company to the crown; for the mutiny burst out in 1857. The transactions of that revolt chiefly took place in northern India, and are narrated in the article INDIAN MUTINY. In Bengal the rising began at Barrackpore, was communicated to Dacca in Eastern Bengal, and for a time raged in Behar, producing the memorable defence of the billiard-room at Arrah by a handful of civilians and Sikhs—one of the most splendid pieces of gallantry in the history of the British arms. Since 1858, when the country passed to the crown, the history of Bengal has been one of steady progress. Five great lines of railway have been constructed. Trade has enormously expanded; new centres of commerce have sprung up in spots which formerly were silent jungles; new staples of trade, such as tea and jute, have rapidly attained importance; and the coalfields and iron ores have opened up prospects of a new and splendid era in the internal development of the country.

During the decade 1891-1901 Bengal was fortunate in escaping to a great extent the two calamities of famine and plague which afflicted central and western India. The drought of 1896-1897 did indeed extend to Bengal, but not to such an extent as to cause actual famine. The distress was most acute in the densely populated districts of northern Behar, and in the remote hills of Chota Nagpur. Plague first appeared at Calcutta in a sporadic form in April 1898, but down to April of the following year the total number of deaths ascribed to plague throughout the province was less than 1000, compared with 191,000 for Bombay. At the beginning of 1900, however, there was a serious recrudescence of plague at Calcutta, and a malignant outbreak in the district of Patna, which caused 1000 deaths a week. In the early months of 1901, plague again appeared in the same regions. The number of deaths in 1904 was 75,436, the highest recorded up to that date.

The earthquake of the 12th of June 1897, which had its centre of disturbance in Assam, was felt throughout eastern and northern Bengal. In all the large towns the masonry buildings were severely damaged or totally wrecked. The permanent way of the railways also suffered. The total number of deaths returned was only 135. Far more destructive to life was the cyclone and storm-wave that broke over Chittagong district on the night of the 24th of October 1897. Apart from damage to shipping and buildings, the low-lying lands along the coast were completely submerged, and in many villages half the inhabitants were drowned. The loss of human lives was reported to be about 14,000, and the number of cattle drowned about 15,000. As usual in such cases, a severe outbreak of cholera followed in the track of the storm-wave. Another natural calamity on a large scale occurred at Darjeeling in October 1899. Torrential rains caused a series of landslips, carrying away houses and breaking up the hill railway.

The most notable event, however, of recent times was the partition of the province, which was decided upon by Lord Curzon, and carried into execution in October 1905. Serious popular agitation followed this step, on the ground (*inter alia*) that the Bengali population, the centre of whose interests and prosperity was Calcutta, would now be divided under two governments, instead of being concentrated and numerically dominant under the one; while the bulk would be in the new division. In 1906-1909 the unrest developed to a considerable extent, requiring special attention from the Indian and home governments; but as part of the general history of India the movement may be best discussed under that heading (see INDIA: History).

Owing to geographical and historical circumstances, Oriya is to some extent infected by Telugu and Marathi idioms, while the Tibeto-Burman dialects and Ahom have left their marks upon Assamese.

Phonetics.—The three forms of speech agree in sounding the vowel *a* like the *ô* in "hot." When writing phonetically, this sound is represented in the present article by *ô*. The pronunciation of this frequently recurring vowel gives a tone to the general sound of the languages which at once strikes a foreigner. In Bg. and A. a final vowel preceded by a single consonant is generally not pronounced. In Bg. this is only true for nouns, a final *a* being freely sounded in adjectives and verbs. In O., on the other hand, a final *a* is always pronounced. The sound of such a final *a* is in all three languages the same as that of the second *o* in "promote"; thus, the Bg. *baca* is pronounced *bôçô*. In Bg. a medial *a* sometimes has the sound of the first *o* in "promote," as, for instance, in the word *bân* (bon), a forest. In A. and Eastern Bg. a medial *a* is often sounded like the *a* in "ball," and is then transliterated *â*. *Â* has preserved as a rule its proper sound of *a* in "father."

The distinction between *i* and *ê* and between *u* and *û* is everywhere lost in pronunciation, although in *tatsama* words the Sanskrit spelling is followed in literature. Thus, in Bg., the Skr. *vyâkta* is pronounced *bêkta*, with the accent on the first syllable. In A. the distinction between these long and short vowels is obliterated more than elsewhere, the reason being, as in Bg., the changes of pronunciation due to the shifting back of the accent. In O., the Skr. vowel *î* is pronounced *ru*. Elsewhere it is *ri*. In O. the vowel *ê* is always long, but in Bg. it may be long or short, and in A. it is always short. The syllable *y* preceded by a consonant has in Bg. the sound of a short *ô*, so that *vyâkta* is pronounced *bêkô* moreover, in the same language the letter *z* is often pronounced like the *z* in the German *Zauber*, a sound here phonetically represented by *â*; thus, *dêkka* is sometimes pronounced *dêkâ*, and sometimes *dâkko* or even *dâkô*. The syllable *yâ*, when following a consonant, also has this *â*-sound, so that the English word "bank" is written *byânk* in Bengali characters. *Ô* in O. is always long. In Bg., when it has not got the accent it is shortened to the sound of the first *o* in "promote," a sound which, as we have seen, is also sometimes taken by a medial *â*. In A. *ô* approaches the sound of *u*, and it actually becomes *u* when followed by *î* in the next syllable. The diphthongs *ai* (in *tatsama*, i.e. the Skr. *ai*) and *ai* (in *vaidharu*) are pronounced like the "oil" in Bg. and O., while in A. they have the sound of *oi* in "going." Similarly, in Bg. and O. the diphthongs *âi* and *au* are sounded like the *au* in the German *Haus*, but in A. like *au* in the French *jaune*, or the second *o* in "promote." In colloquial Bg. the two syllables *âi* often have the sound of *ê*, as in *khâitê* (khêitê), to eat.

In Eastern Bengali *k* has often the sound of *ch* in "loch." In A. the consonants *c* and *ch* are both pronounced like *s*, and *j* and *jh* become *sh* (i.e. the *s* in "pleasure") or (when final) *ç*. The same tendency is observable in Bg., though it is usually considered vulgar. The proper sound of Bengali *ch* is pronounced like the *ç* rule has in the parts of sound of these letters, but towards the south *c* and *ch* become *ts* and *tsh* when not followed by a palatal letter. The letters *ç* and *çh*, when medial, are pronounced as a strongly buried *r*, and are then transliterated *r* and *rç* respectively. In A. and Eastern Bg. there is a strong tendency to pronounce both dentals and cerebrals as semi-cerebrals, as is done by the neighbouring Tibeto-Burmans. In A. *r* and *rç* become *r* and *rç* respectively. In Bg. and A. *g* has universally become *n*, but is properly pronounced in O. *Y* is usually pronounced as *j*, unless it is a merely euphonic bridge to avoid a hiatus between two vowels, as in *kôrô* for *kyôrô*.—In A. the *ra* and *ri* that *j* has the usual *s*-sound. When *y* is the final element of a conjunct consonant, in Bg. (except in the south-east) it is very faintly pronounced. In compensation the preceding member of the conjunct is doubled and the preceding vowel is shortened if possible, thus *vâyâya* becomes *bâkôvô*. In A., while the *y* is usually preserved, and *i* is inserted before the conjunct, so that we have *bâkôyô*. *M* and *r* when similarly situated are altogether elided in Bg., and this is also the case with *v* in A., in which language *m* under these circumstances becomes *v*, thus, *smaraya* becomes Bg. *siôrô*, A. *svôrô*, and *dvârâ* becomes Bg. and A. *dvârâ*. *R* is generally pronounced correctly, except that when a member of a compound *ri* is often not pronounced in colloquial Bg.; thus *karna* (*kôrnô*). In North-eastern Bengali and in A. a medial *r* is commonly dropped; thus, Bg. *karidâm* (*ka'idâm*), A. *kari* (*ka'i*).¹ The vulgar commonly confound *n* and *l*. O. has retained the old cerebral *l* of Pr., which has disappeared in Bg. and A. The semi-vowel *l(w)* becomes *b* in Bg. and O., but retains its proper sound when medial in A. When Bg. wishes to represent a *w*, it has to write *ôyô*; thus, for *châwô* it writes *chôyô*. Similarly *bârô*, twelve, + *yârô*, friendship, when compounded together to mean "a collection of twelve friends" is pronounced *bârôyârô*. Bg. pronounces all vowels as long, and has no *sh* as they write *sh* in the English *sh* in "shin." This was already the case in Mg. Pr. (see PRAKRITI). O., on the contrary, pronounces all three like the dental *s* in "sin," while A. sounds them like a rough *h*, almost like the *ch* in "loch." In Eastern Bg. *s* becomes frantically *h*, and is then often

dropped. The compound *ks* is everywhere treated as if it were *khy*. In colloquial Bg. there is a tendency to dissipation; thus *dêkka* is pronounced *dâkô* and the Pr. *hathô*, a hand, becomes *hât*, not *hâh*. In Eastern Bg. there is a cockney tendency to drop *h*, so that we have 't, a hand, and *kaiâm* for *kahidâm*, I said.

The above remarks show that O. has, on the whole, preserved the original sounds of the various letters better than Bg. or A.

Declension.—The distinction of gender has disappeared from all three languages. Sex is distinguished either by the use of qualifying terms, such as "male" or "female," or by the employment of different words, as in the case of our "bull" and "cow." The plural number is almost always denoted by the addition of some word meaning "many" or "collection" to the singular, although we sometimes find a true plural used in the case of nouns denoting human beings. Case was originally indicated by postpositions (see INDO-ARYAN LANGUAGES), but in many instances these have been joined to the noun, so that they form one word with it. The following is the full declension of the singular of the word *ghôta*, a horse, in the three languages—

	Oriya.	Bengali.	Assamese.
Nom.	ghôrà	ghôrà	ghôrà
Acc.-Dat.	ghôràku	ghôràkê	ghôràk
Instr.	ghôràku	ghôràtê	ghôràt
Abl.	ghôràru	ghôrà-kaitê	ghôrày
Gen.	ghôràra	ghôràr	ghôràr
Loc.	ghôràrê	ghôràtê or ghôrày	ghôràt

In Bg. and A. a noun often takes *ê* (e) in the nominative singular, when it is the subject of a transitive verb; thus Bg. *bêdê* (from *bêd*) *batê*, the Veda says. In Bg. the nominative plural may, in the case of human beings, be formed by adding *â* to the genitive singular; thus, *amârâ*, a son; gen. sing., *sambârê*; nom. plur., *sambârâ*. The same is the case with the pronouns; thus *amârâ*, of me; *amârâ*, we; *tâhâr*, his; *tâhârê*, they. In Bihari (q.v.) the pronouns follow the same rule, and, as is explained under that head, the nominative plural is really an oblique form of the genitive. With this exception, the plural in all our three languages is either the same as the singular, or (when the idea of plurality has to be emphasized) is formed by the addition of nouns of multitude, such as *gâr* in Bg., *mâna* in O., or *bûk* in A.

We shall see that pronominal suffixes are freely used in all three languages in the conjugation of verbs. In the Outer languages of the north-west edge of India (for the details of these, see INDO-ARYAN LANGUAGES) pronominal suffixes are also commonly added to nouns to signify possession. In most of the languages of the Eastern Group such pronominal suffixes added to nouns have fallen into disuse, but in A. they are still commonly employed with nouns of relationship; thus, *bâp*, a father; *bôpâi*, my father; *bâper*, your father; *bâpek*, his father. Their retention in A. is no doubt due to the example of the neighbouring Tibeto-Burman languages, in which such pronominal prefixes are a common feature.

In all three languages the adjective does not change for gender, for number or for case.

The personal pronouns have at the present day lost their old nominatives, and have new nominatives formed from the oblique base. In the first and second persons the singulars have fallen into disuse in polite conversation, and the plurals are used honorifically for the singular, as in the case of the English "you" for "thou." For the plural, new plurals are formed from the new singular (old plural) bases. In A., however, the old singular of the first person is retained, and the old plural plays its proper function. The Bg. pronouns are, *mu* (old), *i*, *ami* (modern), *i*, *tui* (old), thou; *tumi* (modern), thou; *ê*, *tinâ*, he; *ê*, *tui*, this; *ô*, *moni*, that; *jê*, *jini*, who; *kê*, who?; *kê*, what?; *bô*, what (adjective); *kôna*, anyone; *kichu*, anything; *kôna*, any. Most of the forms in the other languages closely follow these. The words in O. for "I" and "thou" are *ambê* and *tumbê* respectively. All these pronouns have plurals and oblique forms with which the case suffixes are added. These must be learnt from the grammars.

Conjugation.—It is in the conjugation of the verb that colloquial Bg. differs most from the literary dialect. There is no distinction in any of the three languages between singular and plural. Most of the old singular forms have survived in a non-honourific sense, but they are rarely employed in polite language except in the third person. The old plural forms are generally employed for the singular also. The usual base for the verb substantive, when employed as an auxiliary, is *ach*, be, derived from the Skr. *reçati*. O., however, forms its part from the base *tha* (Skr. *sthita*), and in South-western Bengal the base *tha*, derived from the same original, is used for both present and past time. Only two of the old Skr.-Pr. tenses have survived in the finite verb, the simple present and the imperative. Thus, Bg. *karî*, I do; *kar*, do thou. The past is formed by adding pronominal suffixes to the old past participle in *î* (Skr. *âita*-, a pleonastic *î*, see PRAKRITI), and the future by adding *â* to the old future participle in *b* (Skr. *bhavîsya*-, Pr. *avîsya*-, Thus, Bg. *karî-âm*, done +by-me, I did; *karî-â*, it-is-to-be-done +by-me, I shall do. In Bg. there are two modern participles, a present (*karî-ê*)

¹ In Mg. Pr. every *r* becomes *l*. For an explanation of the apparent non-observance of this rule in languages of the Eastern Group, see BIHARI.

and a past (*kar-iyā*), and from these there are formed periphrastic tenses by suffixing auxiliary verbs. Thus, *karite-chi* (colloquial, *kārci* or *kōrci*), I am doing; *karite-chilām* (coll., *kōrcilum* or *kōrcilum*), I was doing; *karīya-chi* (coll., *kōrsi*), I have done; *karīya-chilām* (coll., *kōrsilum*), I had done. A past conditional is formed by adding pronominal suffixes to the present participle; thus, *karitām* (coll., *kōrtum* or *kōrtum*), (if) I had done. Similar tenses are formed in O, and A, but the periphrastic tenses are formed with verbal nouns and not with participles. Thus, O, *karu-achā*, A, *kāri-chō*, I am a-doing, I am doing. O and A have each a very complete series of gerunds or verbal nouns which are fully declined. In Bg. only one gerund, that of the genitive, is in common use.

In order to illustrate the conjugation of the verb, we here give that of the root *kar*, do, in its present, past and future tenses.

	Oriyā.	Literary Bengali.	Colloquial Bengali.	Assamese.
I do	<i>karū</i>	<i>kārī</i>	<i>kōri</i>	<i>karō</i>
Thou doest	<i>kara</i>	<i>kāra</i>	<i>kōrō</i>	<i>karā</i>
He (non-honorific) does	<i>karē</i>	<i>karē</i>	<i>kōrē</i>	<i>kare</i>
He (honorific) does	<i>karāni</i>	<i>kāraṇi</i>	<i>kōraṇi</i>	<i>kare</i>
I did	<i>karūā</i>	<i>kārīām</i>	<i>kōrām</i> , <i>kōrūm</i>	<i>karūā</i>
Thou didst	<i>karā</i>	<i>kārī</i>	<i>kōrē</i> , <i>kōrē</i>	<i>karā</i>
He (non-hon.) did	<i>karīā</i>	<i>kārīā</i>	<i>kōrīā</i> , <i>kōrīā</i>	<i>karīā</i>
He (hon.) did	<i>karīē</i>	<i>kārīē</i>	<i>kōrē</i> , <i>kōrē</i>	<i>karīē</i>
I shall do	<i>karībū</i>	<i>kārībū</i>	<i>kōrbū</i>	<i>karīm</i>
Thou wilt do	<i>kariba</i>	<i>kārībē</i>	<i>kōrbē</i>	<i>karībā</i>
He (non-hon.) will do	<i>kariba</i>	<i>kārībē</i>	<i>kōrbē</i>	<i>kariba</i>
He (hon.) will do	<i>karībē</i>	<i>kārībē</i>	<i>kōrbē</i>	<i>karībā</i>

All the three languages have negative forms of the verb substantive, and A. has a complete negative conjugation for all verbs, made by prefixing the negative syllable *na* under certain euphonic rules.

Bengali Literature.—The oldest recognized writer in Bengali is the Vaishnava poet Caṇḍī Dās, who flourished about the end of the 14th or the beginning of the 15th century.

Literature. His language does not differ much from the Bengali of to-day. He founded a school of poets who wrote hymns in honour of Krishna, many of whom, in later times, became connected with the religious revival instituted by Caitanya in the early part of the 16th century. In the 15th century Kāśī Rām translated the *Mahābhārata* and Kṛtībās Ojā the *Rāmāyana* into the vernacular. The principal figure of the 17th century was Mukunda Rām who has left us two really admirable poems entitled *Caṇḍī* and *Srīmanṭa Saudāgar*. Parts of the former have been translated by Professor Cowell into English verse, and both well deserve putting into an English dress. With Bhārat Candra, whose much admired but artificial Bīdyā Sundar appeared in the 18th century, the list of old Bengali authors may be considered as closed. They wrote in genuine nervous Bengali, and the conspicuous success of many of them shows how baseless is the contention of some native writers of the present day that modern literary Bengali needs the help of its huge imported Sanskrit vocabulary to express anything but the simplest ideas. This modern literary Bengali arose early in the 19th century, as a child of the revival of Sanskrit learning in Calcutta, under the influence of the college founded by the English in Fort William. Each decade it has become more and more the slave of Sanskrit. It has had some excellent writers, notably the late Bankim Candra, whose novels have received the honour of being translated into several languages, including English. Even he, however, sometimes laboured under the fetters imposed upon him by a strange vocabulary, and all competent European scholars are agreed that no work of first-class originality has much chance of arising in Bengal till some great genius purges the language of its pseudo-classical element.

Oriyā Literature does not go back beyond the 16th century, though examples of the language are found in inscriptions of the 13th century. Nearly all the works are connected with the history of Krishna, and the translation of the *Bhāgavata Purāna* into Oriyā in the first half of the 16th century still exercises great influence on the masses. Dīna Kṛṣṇa Dās (17th century) was the author of another popular work entitled *Rasa Kāllola*,

or "The Waves of Sentiment," which deals with the early life of Krishna. Every verse in it begins with the letter *kā*. It is not always decent, but it is immensely popular. Upēndra Bhaṅja, Rājā of Gumsur, a petty hill state, is the most famous of Oriyā poets, and was the most prolific. His work is insipid to a European taste, and when not unintelligible is often obscene. Oriyā poetry, from first to last, has been an artificial production, the work of *paṇḍits*, who clung to the rules of Sanskrit rhetoric, and loaded their verses with so many ideas and words borrowed from that language that it is rarely understood, except by the learned. The whole literature is, in fact, overshadowed by the great modern work of Jagannāth (a name of Krishna) at Puri in Orissa.

Assamese Literature.—The Assamese are justly proud of their national literature. It has an independent growth, and its strength lies in history, a branch of letters in which other Indian languages are almost entirely wanting. They have chronicles going back for the past 600 years, and a knowledge of their contents is a necessary part of the education of the upper classes of the country. In poetry, the Vaishnava reformer, Sankar Deb, who flourished some 450 years ago, was a voluminous writer. His best known work is a translation of the *Bhāgavata Purāna*. About the same time Ananta Kandali translated the *Mahābhārata* and the *Rāmāyana* into his native tongue. Medicine was a science much studied, and there are translations of all the principal Sanskrit works on the subject. Forty or fifty dramatic works in the vernacular are known and are still acted. Some of them date back to the time of Sankar Deb.

AUTHORITIES.—There is no work dealing with the three languages as a group. Both the *Comparative Grammars* of Beames and Hoernle (see INDOP-ARYAN LANGUAGES) are silent about Assamese. The fullest details concerning them all will be found in vol. 3 of the *Linguistic Survey of India*, parts i. and ii. (Calcutta, 1903). In this each dialect and subdialect is treated with great minuteness and with copious examples.

The first Bengali grammar and dictionary in a European language was the *Vocabulaire em Idioma Bengalla e Portuguez* of Manoel da Assumpção (Lisbon, 1743). N. B. Halhed wrote the first Bengali grammar in the English language (Hooghly, 1778), but the real father of Bengali philology was the great missionary, William Carey (*Grammar*, Serampore, 1801; *Dictionary*, ib., 1825). W. Yates's *Grammar*, as edited and improved by T. Wenger (Calcutta, 1847) and others, is still on sale. It is entirely confined to the literary Bengali of the *paṇḍits*. Its great rival has been Syāmā Caran Sarāḥ's *Grammar* (Calcutta, 1850), of which there have been numerous reprints. In 1894 J. Beames published his *Grammar* (Oxford), now the standard work on the subject. It is largely based on Syāmā Caran's work, but with much new material, especially that dealing with the colloquial side of the language. G. F. Nicholl's *Grammar* (London, 1885) is an independent study of the language, in which the vernacular works of the best native grammarians have been freely utilized. There is no good Bengali dictionary. G. C. Houghton's *Dictionary* (London, 1833) is perhaps still the best, but J. Mendies' (Calcutta, about 1870) is also well known, and is the parent of countless others which have issued from the Calcutta presses. A *Small Dictionary of Colloquial Bengali Words*, by J. M. C. and G. A. C. (Calcutta, 1904), may also be studied with advantage. Cf. also Syāmā-carān Gāngulī, *Bengali Spoken and Written* (Calcutta, 1906). For Bengali literature, see R. C. Dutt, *The Literature of Bengal* (Calcutta and London, 1895), and Hara Prasad Sāstri, *The Vernacular Literature of Bengal before the Introduction of English Education* (Calcutta, n.d.). The most complete work is *Bangabhāṣā o Sāhiya* by Dinēś Candra Sēn (2nd ed., Calcutta, 1901) in the Bengali language.

For Oriyā there are E. Hallam's (Calcutta, 1874), T. Malby's (Calcutta, 1874) and J. Browne's (London, 1882) *Grammars*. The last two are in the Roman character. They are all mere sketches of the language. Sutton's (Cuttack, 1841) is still the only *Dictionary* which the present writer has found of any practical use. For Oriyā literature, see App. IX. of Hunter's *Orissa* (London, 1872), and Monmohan Chakravarti's "Notes on the Language and Literature of Orissa" in the *Journal of the Asiatic Society of Bengal*, vol. lxvi. (1897), part i. pp. 317 ff., and vol. lxvii. (1898), part i. pp. 332 ff.

The first Assamese *Grammar* was Nathan Brown's (Sibsagar, 1848, 3rd ed., 1893), and it is still the one usually studied. G. F. Beames gives an Assamese grammar as a supplement to his Bengali *Grammar* already quoted. Like that work, it is quite indented, and is not a revised edition of Brown. M. Bronson's *Dictionary* (Sibsagar, 1867) was for long the only vocabulary available, and a very useful and practical work it was. It is now superseded by Hem Candra Barua's *Hema-kosa* (Shillong, 1900). For Assamese literature, see Ananda Rām Dhekālī Phukan's *A Few Remarks on the Assamese*

Language (Sibsagar, 1855), partly reprinted in the *Indian Antiquary*, vol. xxv. (1896), pp. 57 ff.

BENGAZI (anc. *Hesperides-Berenice*), a seaport on the north coast of Africa, capital of the sanjak of Bengazi or Barca, formerly in the vilayet of Tripoli, but, since 1875, dependent directly on the ministry of the interior at Constantinople. It is situated on a narrow strip of land between the Gulf of Sidra and a salt marsh, in 30° 7' N. lat. and 20° 3' E. long. Though for the most part poorly built, it has one or two buildings of some pretension—an ancient castle, a mosque, a Franciscan monastery, government buildings and barracks. Senussi influence is strong and there is a large *zawia* (convent). The harbour is half silted up with sand and the ruins of fortifications, and is accessible only to vessels of light draught. A lighthouse has been erected at the entrance, but reefs render approach difficult, and the outer anchorage is fully exposed to west and north and not good holding. The export trade is largely in barley, shipped to British and other maltsters. The Sudan produce (ivory, ostrich feathers, &c.) formerly brought to Bengazi by caravan, has now been almost wholly diverted to Tripoli, the eastern tracks from Wadai and Borku by way of Kufra to Ajilja having become so unsafe that their natural difficulties are no longer worth braving. Consular vigilance has also killed the once considerable slave trade. Trade in other commodities, however, is on the increase, exports now amounting to nearly half a million sterling and imports to half that figure. The neighbouring coast is frequented by Greek and Italian sponge-fishers, the industry being a valuable one. The province of Bengazi, being still without telegraphs or roads, is one of the most backward in the Ottoman empire.

Founded by the Greeks of Cyrenaica under the name Hesperides, the town received from Ptolemy III. the name of Berenice in compliment to his wife. The ruins of the ancient town, which superseded Cyrene and Barca as chief place in the province after the 3rd century A.D., are now nearly buried in the sand. The modern town lies south-west of the original site. Certain large natural pits which are found in the plain behind, and have luxuriant gardens at the bottom, are supposed to have originated the myth of the Gardens of the Hesperides. Ancient tombs are found, which in 1882 yielded fine Greek vases to G. Dennis, then British vice-consul. The present name is derived from that of a Moslem saint whose tomb, near the sea-coast, is an object of veneration. The population, amounting to about 25,000, is greatly mixed. Levantines, Maltese, Greeks and Jews form the trading community, but since 1895, when a branch of the *Agenzia Italiana Commerciale* was established at Bengazi, Italians have exercised an increasing influence on Cyrenaica commerce. Turks, Arabs and Berbers are the ruling castes, and negroes act as labourers and domestics. Many of these found their way to Crete, and becoming porters, &c. in Canea and Candia, were notorious for turbulence and fanaticism. In 1897 and 1898 the European admirals forcibly deported consignments of the worst characters back to Bengazi. In 1858 and again in 1874 the town was devastated by plague (see also TRIPOLI and CYRENAICA). (D. G. H.)

BENDEL, JOHANN ALBRECHT (1687–1752), Lutheran divine and scholar, was born at Winnenden in Württemberg, on the 24th of June 1687. His father died in 1693, and Bengel was educated by a friend, who became a master in the gymnasium at Stuttgart. In 1703 Bengel left Stuttgart and entered the university of Tübingen, where, in his spare time, he devoted himself specially to the works of Aristotle and Spinoza, and in theology to those of Philipp Spener, Johann Arndt and August Franke. His knowledge of the metaphysics of Spinoza was such that he was selected by one of the professors to prepare materials for a treatise *De Spinosismo*, which was afterwards published. After taking his degree, Bengel devoted himself to theology. Even at this time he had religious doubts; it is interesting in view of his later work that one cause of his perplexities was the difficulty of ascertaining the true reading of certain passages in the Greek New Testament. In 1707 Bengel entered the ministry and was appointed to the parochial charge of Metztingen-

unter-Urach. In the following year he was recalled to Tübingen to undertake the office of *Repetent* or theological tutor. Here he remained till 1713, when he was appointed head of a seminary recently established at Denckendorf as a preparatory school of theology. Before entering on his new duties he travelled through the greater part of Germany, studying the systems of education which were in use, and visiting the seminaries of the Jesuits as well as those of the Lutheran and Reformed churches. Among other places he went to Heidelberg and Halle, and had his attention directed at Heidelberg to the canons of scripture criticism published by Gerhard von Mästricht, and at Halle to C. Vitringa's *Anacrisis ad Apocalypsin*. The influence exerted by these upon his theological studies is manifest in some of his works. For twenty-eight years—from 1713 to 1741—he was master (*Klosterpräceptor*) of the *Klosterschule* at Denckendorf, a seminary for candidates for the ministry established in a former monastery of the canons of the Holy Sepulchre. To these years, the period of his greatest intellectual activity, belong many of his chief works. In 1741 he was appointed prelate (*i.e.* *General Superintendent*) at Herbrechtingen, where he remained till 1749, when he was raised to the dignity of consistorial councillor and prelate of Alpirspach, with a residence in Stuttgart. He now devoted himself to the discharge of his duties as a member of the consistory. A question of considerable difficulty was at that time occupying the attention of the church courts, viz. the manner in which those who separated themselves from the church were to be dealt with, and the amount of toleration which should be accorded to meetings held in private houses for the purpose of religious edification. The civil power (the duke of Württemberg was a Roman Catholic) was disposed to have recourse to measures of repression, while the members of the consistory, recognizing the good effects of such meetings, were inclined to concede considerable liberty. Bengel exerted himself on the side of the members of the consistory. In 1751 the university of Tübingen conferred upon him the degree of doctor of divinity. He died after a short illness, in 1752.

The works on which Bengel's reputation rests as a Biblical scholar and critic are his edition of the Greek New Testament, and his *Gnomon or Exegetic Commentary* on the same.

(A.) His edition of the Greek Testament was published at Tübingen in 1734, and at Stuttgart in the same year, but without the critical apparatus. So early as 1725, in an addition to his edition of Chrysostom's *De Sacerdotio*, he had given an account in his *Prodromus Novi Testamenti Graeci recte casueque adornandi* of the principles on which his intended edition was to be based. In preparation for his work Bengel was able to avail himself of the collations of upwards of twenty MSS., none of them, however, of great importance, twelve of which had been collated by himself. In constituting the text, he imposed upon himself the singular restriction of not inserting any various reading which had already been printed in some preceding edition of the Greek text. From this rule, however, he deviated in the case of the Apocalypse, where, owing to the corrupt state of the text, he felt himself at liberty to introduce certain readings on manuscript authority. In the lower margin of the page he inserted a selection of various readings, the relative importance of which he denoted by the first five letters of the Greek alphabet in the following manner:— α was employed to denote the reading which in his judgment was the true one, although he did not venture to place it in the text; β , a reading better than that in the text; γ , one equal to the textual reading; δ and ϵ , readings inferior to those in the text. R. Etienne's division into verses was retained in the inner margin, but the text was divided into paragraphs. The text was followed by a critical apparatus, the first part of which consisted of an introduction to the criticism of the New Testament, in the thirty-fourth section of which he laid down and explained his celebrated canon, "*Proclivi scripturæ præstat ardua*" ("The difficult reading is to be preferred to that which is easy"), the soundness of which, as a general principle, has been recognized by succeeding critics. The second part of the critical apparatus was devoted to a consideration of the various readings; and here Bengel adopted the plan of stating the evidence both against and in favour of a particular reading, placing before the reader the materials for forming a judgment. Bengel was the first definitely to propound the theory of families or recensions of MSS. His investigations had led him to see that a certain affinity or resemblance existed amongst many of the authorities for the Greek text—MSS., versions, and ecclesiastical writers; that if a peculiar reading, e.g., was found in one of these, it was generally found also in the other members of the same class; and this general relationship seemed to point ultimately to a common origin for all the authorities which presented such peculiarities. Although

Benin river (known also as the Jakri outlet), though linked to the Nigers system by a network of creeks, is an independent stream. It is formed by the junction of two rivers, the Ethiope and the Jamieson, which rise (north of 6° N.) on the western side of the hills which slope east to the Niger river. They unite about 50 m. above the sea. The general course of the Benin is westerly. It enters the Atlantic in about 5° 46' N., 5° 3' E., and at its mouth is 2 m. wide. It is here obstructed by a sand-bar over which there is 12-14 ft. of water at high tide. The river is navigable by small steamers up to Sapele, a town on the south bank immediately below the junction of the head streams. The Ologi and Gwato creeks enter the Benin on the right or north bank, and on the same side (8 m. above the mouth of the river) a channel, the Lagos creek, 170 m. long, branches off to the north-west, affording a waterway to Lagos. From the south or left bank of the Benin the Forcados mouth of the Niger can be reached by the Nana creek.

The Beni are a pure negro tribe, speaking a distinct language, but having many characteristics common to those of the Yorubans and Ewe-speaking tribes. Like the Ashanti and Dahomeys the Beni had a well-organized and powerful government and possessed a culture rare among negro races (see below, *History*).

Benin city is situated in a clearing of the forest, about 25 m. from the river-port of Gwato, on Gwato creek. The principal building is the British residency, which is constructed of brick and timber. A primary school, supported by the native chiefs, was opened in 1901, and a meteorological station was established in 1902. In 1904 the town was placed in telegraphic communication with the rest of the protectorate and with Europe. Of the ancient city, whose buildings excited the admiration of travellers in the 17th and 18th centuries, scarcely a trace remains. The houses are neatly built of clay, coloured with red ochre, and frequently ornamented with rudely carved pillars. The port of Gwato, which lies about 30 m. north-north-east of the mouth of the Benin river, has a special interest as the place where Giovanni Belzoni, the explorer of Egyptian antiquities, died in 1823 when starting on an expedition to Timbuktu. No trace of his grave can now be found. Wari (formerly known also as Owari, Oywhéré, &c.) is a much-frequented port on a branch of the Niger of the same name reached from the Forcados mouth, and is 55 m. south of Benin city.

Since the abolition of the slave trade the chief export of the country is palm-oil. Other trade products were from time to time—with the desire to preserve the isolation and independence of the country—placed under fetich, *i.e.* their export was forbidden, so that in 1897 the only article in which trade was allowed by the king was palm-oil. After the British occupation, an extensive trade developed in oil, kernels, timber, ivory, rubber, &c. In the rubber and timber industries great strides have been made. The chiefs and people have shown considerable aptitude in adapting themselves to the new order of things. Among the articles prized by the Beni is coral, of which the chiefs wear great quantities as ornaments.

History.—Benin was discovered by the Portuguese about the year 1485, and they carried on a brisk trade in slaves, who were taken to Elmina and sold to the natives of the Gold Coast. At that time and for more than two centuries afterwards, Benin seems to have been one of the most powerful states of West Africa. It was known to Europeans in the 17th century as the Great Benin. The towns of Lagos and Badagry were both founded by Benin colonists. Benin city was the seat of a theocracy of priests, in whose hands the oba or king, nominally supreme, appears to have often been a puppet. He was revered by his subjects as a species of divinity, and seldom left the enclosure surrounding the royal palace. The religion and mythology of the Beni, like those of the Yorubas, are based on spirit- and ancestor-worship (see NEGRO AND AFRICA: *Ethnology*); the chief spirit or juju was worshipped with human sacrifices to an appalling extent, the Benin fetich being considered the most powerful in all West Africa. The usual form of sacrifice was crucifixion. Many chiefs, in no way politically dependent on Benin, used to send annual presents to the juju. The Beni

people do not appear to have indulged in wanton cruelty, and it is stated that they usually stupefied the victims before putting them to death. The people were skilled in brass work; their carving and design were alike excellent. Carved ivory objects abound, and there are many evidences of the skill attained by native artists, who perhaps owed something to their contact with the Portuguese. The weaving of cloth was also carried on. The Beni remained politically and socially almost unaffected by European influence until the occupation of their country by the British in 1897, their connexion with the white men having previously been almost confined to matters of trade. The Portuguese withdrew from the coast in the 18th century, but one of the most striking proofs of their commercial influence is the fact that a corrupt Lusitanian dialect was spoken by the older natives up to the last quarter of the 19th century. The first English expedition to Benin was in 1553; after that time a considerable trade grew up between England and that country, ivory, palm-oil and pepper being the chief commodities exported from Benin. The Dutch afterwards established factories and maintained them for a considerable time, chiefly with a view to the slave trade. In 1788 Captain Landolphe founded a factory called Barodo, near the native village of Obobi for the French Compagnie d'Oywhéré; and it lasted till 1792, when it was destroyed by the English. In 1863 Sir Richard Burton, then British consul at Fernando Po, went to Benin to try and put a stop to human sacrifices, an attempt in which he did not succeed. At that time the decline in power of the kingdom of Benin was obvious, and the city was in a decaying condition. In 1885 the coast-line of Benin was placed under British protection, and steps were taken to enter into friendly relations with the king. Consul G. F. N. B. Annesley saw the king in 1890, with the hope of making a treaty, but failed in his object. In March 1892 Captain H. L. Gallwey, British vice-consul, succeeded in concluding a treaty with the king Overami. The treaty, however, proved of no avail, and the king kept as aloof as of old from any outside interference. In January 1897 J. R. Phillips, acting consul-general, and eight Europeans were brutally massacred on the road from Gwato to Benin city, whilst on a mission to the king. Phillips had persisted in starting for Benin despite the repeated request of the king that he should delay his visit until he (the king) had finished the celebration of the annual "customs." Two Europeans, Captain Alan Boisragon and R. F. Locke, alone escaped. A punitive expedition was organized under the command of Admiral Sir Harry Rawson, the success of which was a remarkable example of good organization hastily improvised. The news of the massacre of Phillips's party reached Rear-Admiral Rawson, the commander-in-chief on the Cape station, on the 4th of January 1897. The flagship was at Simons Town. The small craft were dispersed. Two ships at Malta had been ordered to join the Cape command. A transport was chartered in the Thames for the purposes of the expedition. In twenty-nine days a force of 1200 men, coming from three places between 3000 and 4500 m. from the Benin river, was landed, organized, equipped and provided with transport. Five days later the city of Benin was taken, and in twelve days more the men were re-embarked, and the ships coaled and ready for any further service. On the 17th of February Benin was occupied after considerable fighting. The town, which was found to be reeking of human sacrifices, was partly burned, and on the 22nd the expedition started on its return. The king and chiefs responsible for the massacre were placed on their trial by Sir Ralph Moor, high commissioner for Southern Nigeria; the king was deposed and deported to Calabar, and the chiefs, six in all, were executed. The chief offender was not brought to justice until a second punitive expedition in 1899 completed the pacification of the country. After the removal of the king in September 1897 a council of chiefs was appointed. This council carries on the government of the whole Beni country, and is presided over by a British resident.

¹ Mr Annesley (b. 1851), after having served in the Prussian army, and in the Turkish army during the war of 1877, was in the British consular service from 1879 to 1892. In 1888 he became consul to the Congo Free State.

disposed at first to divide the various documents into three classes, he finally adopted a classification into two—the African or older family of documents, and the Asiatic, or more recent class, to which he attached only a subordinate value. The theory was afterwards adopted by J. S. Semler and J. J. Griesbach, and worked up into an elaborate system by the latter critic. Bengel's labours on the text of the Greek Testament were received with great disfavour in many quarters. Like Brian Walton and John Mill before him, he had to encounter the opposition of those who believed that the certainty of the word of God was endangered by the importance attached to the various readings. J. J. Wetstein, on the other hand, accused him of excessive caution in not making freer use of his critical materials. In answer to these strictures, Bengel published a *Defence of the Greek Text of His New Testament*, which he prefixed to his *Harmony of the Four Gospels*, published in 1736, and which contained a sufficient answer to the complaints, especially of Wetstein, which had been made against him from so many different quarters. The text of Bengel long enjoyed a high reputation among scholars, and was frequently reprinted. An enlarged edition of the critical apparatus was published by Philip David Burk in 1763.

(B.) The other great work of Bengel, and that on which his reputation as an exegete is mainly based, is his *Gnomon Novi Testamenti*, or *Exegetical Annotations on the New Testament*, published in 1742. It was the fruit of twenty years' labour, and exhibits with a brevity of expression, which, it has been said, "condenses more matter into a line than can be extracted from pages of other writers," the results of his study. He modestly entitled his work a *Gnomon* or index, his object being rather to guide the reader to ascertain the meaning for himself, than to save him from the trouble of personal investigation. The principles of interpretation on which he proceeded were, to import nothing into Scripture, but to draw out of it everything that it really contained, in conformity with grammatico-historical rules; not to be hampered by dogmatical considerations, and not to be influenced by the symbolical books. Bengel's hope that the *Gnomon* would help to rekindle a fresh interest in the study of the New Testament was fully realized. It has passed through many editions, has been translated into German and into English, and is still one of the books most valued by expositors of the New Testament. John Wesley made great use of it in compiling his *Expository Notes upon the New Testament* (1755).

Besides the two works already described, Bengel was the editor or author of many others, classical, patristic, ecclesiastical and expository. The more important are: *Ordo Temporum*, a treatise on the chronology of Scripture, in which he enters upon speculations regarding the end of the world, and an *Exposition of the Apocalypse* which enjoyed for a time great popularity in Germany, and was translated into several languages.

Autographs.—For full details regarding Bengel the reader is referred to Oskar Wächter's *J. A. Bengels Lebensabriss und to the Memoir of His Life and Writings (J. A. Bengels Leben und Wirken)*, by J. C. F. Burk, translated into English by Rev. R. F. Walker (London, 1837); see also Herzog-Hauck, *Realencyklopädie*, and E. Nestle, *Bengel als Gelehrter* (1893).

BENGUELLA (São Felipe de Benguella), a town of Portuguese West Africa, capital of Benguella district, on a bay of the same name, in 12° 33' S., 13° 25' E. Benguella was founded in 1617 by the Portuguese under Manoel Cerveira Pereira. It was long the centre of an important trade, especially in slaves to Brazil and Cuba, but has now greatly declined. The anchorage, about a mile from the town, in 4 to 6 fathoms, is nothing but an open roadstead. Besides the churches of S. Felipe and S. Antonio, the hospital, and the fortress, there are only a few stone-built houses. The white population numbers about 1 500. A short way beyond Benguella is Bahia Tarta, where salt is manufactured and sulphur excavated.

About 20 m. north of Benguella is Lobito Bay, a natural harbour chosen (1903) as the starting-point of a railway to Katanga. At Lobito steamers can come close inshore and discharge cargo direct. Lobito is connected with Benguella by a railway which passes about midway through Katumbella, a town at the mouth of the river of the same name, and the sea terminus of an ancient route from the heart of Central Africa through Bihe. Old Benguella is a small town about 120 m. north of Lobito Bay.

BENÍ, a river of Bolivia, a tributary of the Madeira, rising in the elevated Cordilleras near the city of La Paz and at first known as the Rio de La Paz, and flowing east, and north-east, to a junction with the Mamoré at 10° 20' S. lat. to form the Madeira. Fully one-half of its length is through the mountainous districts of central Bolivia, where it is fed by a large number of rivers and streams from the snowclad peaks, and may be described as a raging torrent. Below Reyes its course is through the forest-

covered hills and open plains of northern Bolivia, where some of the old Indian missions were located. The lower river is navigable for 217 m. from Reyes to the Esperanza rapids, 18 m. above its confluence with the Mamoré, where a fall of 20 ft. in a distance of 330 yds. obstructs free navigation. Its principal affluent is the Madre de Dios, or Mayu-tata, which rises in the eastern Cordilleras about 35 m. east of Cuzco, and flows in an east and north-east direction through northern Bolivia to a junction with the Bení 120 m. above its mouth. The principal tributaries of the Madre de Dios are the Inambari and Paucartambo, both large rivers, and the Chandlee, Marcapata, and Tambopata. In length and size of its tributaries the Madre de Dios is a more important river than the Bení itself, and is navigable during the wet season to the foot of the Andes, 180 m. from Cuzco.

BENÍ (EL BENÍ), a department of north-eastern Bolivia, bounded N. and E. by Brazil, S. by the departments of Santa Cruz and Cochabamba, and W. by La Paz and the national territory contiguous to Peru and Brazil. Pop. (est., 1900) 32,180, including 6000 wild Indians; area (est., probably too high) 102,111 sq. m. The "Llanos de Mojos," famous for their flourishing Jesuit mission settlements of the 17th and 18th centuries, occupy the eastern part of this department and are still inhabited by an industrious peaceful native population, devoted to cattle raising and primitive methods of agriculture. Cattle and forest products, including rubber and coca, are exported to a limited extent. The capital, Trinidad (pop. 2556), is situated on the Mamoré river in an open fertile country, and was once a flourishing Jesuit mission.

BENI-AMER (AMIR), a tribe of African "Arabs" of Hamitic stock, ethnologically intermediate between Abyssinians and Nubians. They are of the Beja family, and occupy the coast of the Red Sea south of Suakin and portions of the adjacent coast-country of Eritrea, north of Abyssinia. They are of very mixed Beja and Abyssinian blood, and speak a dialect half Beja and half Tigré, locally known as *Hassa*. They marry the women of the Bogos and other mountain tribes; but are too proud to let their daughters marry Abyssinians.

See *Anglo-Egyptian Sudan*, ed. Count Gleichen (London, 1905); A. H. Keane, *Ethnology of Egyptian Sudan* (1884); G. Sergi, *Africa: Antropologia della Stirpe Camitica* (Turin, 1897).

BENI-ISRAEL ("Sons of Israel"), a colony of Jews settled on the Malabar coast in Kolaba district, Bombay presidency, chiefly centring in the native state of Janjira. With the Jews of Cochin, they represent a very ancient Judaic invasion of India, and are to be entirely distinguished from those Jews who have come to India in modern days for purposes of trade. Some authorities believe that the Beni-Israel settled in Kolaba in the 15th century, but they themselves have traditions which indicate a far longer connexion with India (see Jews: § 3).

BENIN, the name of a country, city and river of British West Africa, west of the main channel of the Niger, forming part of the protectorate of Southern Nigeria. The name was formerly applied to the coast from the Volta, in 0° 40' E., to the Rio del Rey, in 8° 40' E., and included the Slave Coast, the whole delta of the Niger and a small portion of the country to the eastward. Some trace of this earlier application remains in the name "Bight of Benin," still given to that part of the sea which washes the Slave Coast, whilst up to 1894 "Benin" was used to designate the French possessions on the coast now included in Dahomey.

In its restricted sense Benin is the country formerly ruled by the king of Benin city. This area, at one time very extensive, gradually contracted as subject tribes and towns acquired independence. It may be described as bounded W. by Lagos, S. by the territory of the Jakri and other tribes of the Niger delta, E. by the Niger river, and N. by Yorubaland. The coast-line held by Benin had passed out of its sovereignty by the middle of the 19th century. In physical characteristics, climate, flora and fauna, Benin in no way differs from the rest of the southern portion of Nigeria (q.v.). The coast is low, intersected by creeks, and forms one huge mangrove swamp; on the rising ground inland are dense forests in which the cotton and mahogany trees are conspicuous.

AUTHORITIES.—H. L. Roth, *Great Benin, its Customs, Art and Horrors* (Halifax, 1903), a comprehensive and profusely illustrated work with an annotated bibliography; C. H. Read and O. M. Dalton, *Antiquities from Benin . . . in the British Museum* (1899); *Pick Rivers, Works of Art from Benin* (1900); R. E. Dennett, *At the Back of the Black Man's Mind* (London, 1906); Sir R. Burton, *Wanderings in West Africa* (London, 1863); H. L. Gallwey, "Journeys in the Benin Country," *Geog. Jour.*, vol. 1, London, 1893; A. Boisragon, *The Benin Massacre* (London, 1897); R. H. Bacon, *Benin, the City of Blood* (London, 1898), by a member of the punitive expedition of 1897; the annual *Reports on Southern Nigeria*, issued by the Colonial Office, London.

BENITOITE, a mineral discovered in 1907 near the headwaters of the San Benito river, San Benito Co., California, and described by Prof. G. D. Louderback. It is a titano-silicate of barium ($\text{BaTiSi}_2\text{O}_8$), crystallizing in the hexagonal system, with a hardness of 6.5, and specific gravity 3.65. It may be colourless or blue, the colour varying sometimes in different parts, and passing to a deep sapphire blue. The blue variety is cut as a gem stone, and often resembles blue sapphire, though its softness distinguishes it from spinel and sapphire. It is a brilliant stone, with high refractive index, and is strongly dichroic, being pale when viewed parallel to the principal axis and dark when viewed transversely.

BENJAMIN, a tribe of Israel, named after the youngest son of Jacob and Rachel. As distinct from the others Benjamin was born not beyond the Jordan but in Palestine, between Bethel and Ephraim. His mother, dying in childbirth, gave him the name Ben-oni, "Son of my sorrow," which was changed by his father to Ben-jamin, meaning probably "Son of the right hand" (*i.e.* "of prosperity," or, perhaps, "son of the south"; Gen. xxxv. 16-18). Of his personal history little is recorded. He was the favourite of his father and brothers (with which contrast the spirit of the stories in Judg. xix.-xxi.), and the reputation of ferocity ascribed to him in the blessing of Jacob ("Benjamin is a wolf that teareth," Gen. xlix. 27) agrees with what is told of the tribe's warriors (see *EHUD, SAUL, JONATHAN*). It is a curious feature that its noted slingers were said to be left-handed (Judg. xx. 16, cf. iii. 15) and even ambidextrous (1 Chron. xii. 2). The late references to this tribe in the Israelite wanderings in the wilderness are of little value. On entering Palestine it is allotted a portion encompassed by the districts of Ephraim, Dan and Judah. In the time of the "judges" the tribe of Benjamin was almost exterminated (see *JUDGES, BOOK OF*), 600 men alone escaping (Judges xix. sqq.). The tribe was built up again by the rape of the maidens of Shiloh at one of their annual festivals (for which cf. Judges ix. 27), but a later narrative gives currency to a tradition that 400 virgins were also brought to Shiloh, the survivors of a massacre of the inhabitants of Jabesh-Gilead. At all events, Benjamin claimed the honour of providing the great king of Israel whose heroic deliverance of Jabesh-Gilead is referred to elsewhere (see *SAUL*), and it is noteworthy that the tribe only now attain historical importance. If the genealogies associated it with Joseph the father of Ephraim and Manasseh, its fortunes were for a time bound up with the northern kingdom (see *DAVID*). Although its territory lies open on the west and east, its physical features unite it to Judah, and what is known of its mixed population¹ makes it difficult to determine how far the youngest of the tribes of Israel enjoyed any independent position previous to the monarchy. Its neutral position between Judah and Ephraim gave it an importance which was religious as well as political. Another the home of Abiathar and Jeremiah, Gibeon the old Canaanite sanctuary, the royal sanctuary at Bethel, its associations with Samuel and the prophetic guilds of the times of Elijah and Elisha, and finally Jerusalem itself, the centre of worship, give "the least of all the tribes" a unique value in the history of Old Testament religion.

See H. W. Hogg, *Ency. Bib.*, col. 534 sqq. (S. A. C.)

BENJAMIN OF TUDELA (in Navarre), a Jewish rabbi of the 12th century. He visited Constantinople, Egypt, Assyria and

¹ Jerusalem and its district was Jebusite until its capture by David (so 2 Sam. v.); for Beeroth and Gibeon, see 2 Sam. iv. 2 seq., xxi. 2, and note the Benjamite and Judahite names which find analogies in the Edomite genealogies. See, on these points, S. A. Cook, *Jew. Quarterly Review* (1906), pp. 528 sqq.

Persia, and penetrated to the frontiers of China. His journeys occupied him for about thirteen years. He was credulous, but his *Itinerary*, or *Massa'oth*, contains some curious notices of the countries he visited and of the condition of the Jews. Thus his work is of much value for the Jewish history of the 12th century. It is from Benjamin that we know that the Jews of Palestine and other parts of the East were noted for the art of dyeing and glass-making.

His *Itinerary* was translated from the Hebrew into Latin by Arias Montanus in 1575, and appeared in a French version by Barletier in 1734. There have been various English translations. One was published by Asher in 1840; another (with critical Hebrew text) by M. N. Adler (*Jewish Quarterly Review*, vols. xvi.-xviii.; also reprinted as a separate volume, 1907).

BENJAMIN, JUDAH PHILIP (1811-1884), Anglo-American lawyer, of Jewish descent, was born a British subject at St Thomas in the West Indies on the 11th of August 1811, and was successively an American lawyer, a leading Confederate politician and a distinguished English barrister. He eventually died in Paris a domiciled Frenchman. After 1818 his parents lived in Charleston, South Carolina, and he went to Yale in 1825 for his education, but left without taking a degree, and entered an attorney's office in New Orleans. He was admitted to the New Orleans bar in 1832. He complied with his friend John Slidell a valuable digest of decisions of the superior courts of New Orleans and Louisiana; and as a partner in the firm of Slidell, Benjamin & Conrad, he enjoyed a good practice. In 1848 he was admitted a councillor of the supreme court, and in 1852 he was elected a senator for Louisiana, and thereafter he took an active part in politics, declining to accept a judgeship of the supreme court. In 1861 he withdrew from the Senate, left Washington and actively espoused the Confederate cause. He joined Jefferson Davis's provisional government as attorney-general, becoming afterwards his secretary for war (1861-1862), and chief secretary of state (1862-1865). Although at times subject to fierce criticism with regard to matters of administration and finance, he was recognized as one of the ablest men on the Confederate side, and he remained with Jefferson Davis to the last, sharing his flight after the surrender at Appomattox, and only leaving him shortly before his capture, because he found himself unable to go farther on horseback. He escaped from the coast of Florida in an open boat, and after many vicissitudes reached England, an exile. In 1866 his remaining property was lost in the banking failure of Overend & Gurney.

In London Benjamin was able to earn a little money by journalism, and on the 13th of January 1866 he entered Lincoln's Inn. He received a hospitable welcome from the legal profession. The influence of English judges who knew his abilities and his circumstances enabled him to be called to the bar on the 6th of June 1866, dispensing with the usual three years as a student, and he acquired his first knowledge of the practice and methods of English courts as the pupil of Mr C. E. (afterwards Baron) Pollock. Pollock fully recognized his abilities and they became and remained firm friends. Benjamin was naturally an apt and useful pupil; for instance, an opinion of Mr Pollock, which for long guided the London police in the exercise of their right to search prisoners, is mentioned by him as having been really composed by Benjamin while he was still his pupil. Benjamin joined the northern circuit, and a large proportion of his early practice came from solicitors at Liverpool who had correspondents in New Orleans. His business gradually increased, and having received a patent of precedence, he was on the 2nd of November 1872 called within the bar as a queen's counsel. In addition to his knowledge of law and of commercial matters he had considerable eloquence, and a power of marshalling facts and arguments that rendered him extremely effective, particularly before juries. He was less successful in addressing juries, and towards the close of his career did not take *Nisi prius* work, but in the court of appeal and House of Lords and before the judicial committee of the privy council he enjoyed a very large practice, making for some time fully £1,500 a year. The question of raising him to the bench was seriously considered by Lord Cairns, who, however, seems to have thought that the ungrudging hospitality and

goodwill with which Benjamin had been received by the English legal profession had gone far enough. Towards the close of his career he was in ill health, and he suffered from the results of a fall from a tramcar. He retired in 1882 to a house in Paris which he had built and where he had been in the habit of passing his vacations with his wife, who was a Frenchwoman. He never returned to practice, but came back to London to be entertained by the bench and bar of England at a banquet in the Inner Temple Hall on the 30th of June 1883. He died at Paris on the 6th of May 1884.

Benjamin was thick-set and stout, with an expression of great shrewdness. An early portrait of him is to be found in Jefferson's *Rise and Fall of the Confederate Government*. His political history may be traced in that work, and in John W. Draper's *American Civil War* and von Holst's *Constitutional History of the United States*. Many allusions to his English career will be found in works describing English lawyers of his period, and there are some interesting reminiscences of him by Baron Pollock in the *Fortnightly Review* for March 1898. His *Treatise on the Law of Sale of Personal Property with References to the American Decisions and to the French Code and Civil Law*—a bulky volume known to practitioners as *Benjamin on Sales*—is the principal text-book on its subject, and a fitting monument of the author's career at the English bar, of his industry and learning. Many of his American speeches have been published.

See *Judah P. Benjamin*, by Pierce Butler (Philadelphia, 1907, with a good bibliography).

BEN LEDI (Gaelic, "the hill of God"), a mountain of Perthshire, Scotland, 2875 ft. high, 5 m. by road N.W. of Callander. It is situated close to some of the most romantic scenery in the Highlands, and is particularly well known through Scott's *Lady of the Lake*. Its name is supposed to point to the time when Beltane rites were observed on its summit. A cairn was built on the top in 1887 to commemorate Queen Victoria's jubilee. On one of the sides of the mountain is a tarn which bears the name of Lochan nan Corp, "the little loch of the dead," from an accident to a funeral party by which 200 lives were lost.

BENLLIURE Y GIL, JOSÉ (1838—), Spanish painter, was born at Valencia, studied painting under Domingo, and showed from the first such marked talent that he was sent to the Spanish school in Rome. He was one of the select circle pensioned by the Spanish government for residence in Italy and executed several state orders for the decoration of public buildings; but he owes his chief fame to his large historical paintings, notably the "Vision in the Coliseum." He became the leader of the Spanish art colony in Rome, where he practised as painter and sculptor.

BEN LOMOND, a mountain in the north-west of Stirlingshire, Scotland. It is situated near the eastern bank of Loch Lomond, about 0 m. from the head and about 15 from the foot. It is 3192 ft. high, and the prevailing rocks are granite, mica schist, diorite, porphyry and quartzite, the last, where it crops out on the surface, gleaming in the distance like snow. Duchray Water, a head-stream of the Forth, rises in the north-east shoulder. The hill, which is covered with grass to the top, is a favourite climb, being ascended from Rowardennan (the easiest) or Inversnaid on the lake, or Aberfoyle 10 m. inland due east. The view from the summit extends northward as far as the Grampians, with occasional glimpses of Ben Nevis; westward to Jura in the Atlantic; south-westward to Arran in the Firth of Clyde; southward to Tinto Hill, the Lowthers and Cairnsmore; and eastward to Edinburgh Castle and Arthur's Seat.

BENLOWES, EDWARD (1603 ?-1676), English poet, son of Andrew Benlowes of Brent Hall, Essex, was born about 1603. He matriculated at St John's College, Cambridge, in 1620, and on leaving the university he made a prolonged tour on the continent of Europe. He was a Roman Catholic in middle life, but became a convert to Protestantism in his later years. He dissipated his fortune by openhanded generosity to his friends and relations, and possibly by serving in the Civil War; so that he was in great poverty at the time of his death, which occurred on the 18th of December 1676. The last eight years of his life

were passed at Oxford. Many of his writings are in Latin. His most important work is *Theophila, or Love's Sacrifice, a Divine Poem* (1652). The poem deals with mystical religion, telling how the soul, represented by Theophila, ascends by humility, zeal and contemplation, and triumphs over the sins of the senses. It is written in a curious stanza of three lines of unequal length rhyming together. Until recent times justice has hardly been done to Benlowes' poetical merits and indisputable piety. Samuel Butler, who satirized him in his "Character of a Small Poet," found abundant matter for ridicule in his eccentricities; and Pope and Warburton noted him as a patron of bad poets.

His *Theophila* was reprinted by S. W. Singer; and in *Minor Poets of the Caroline Period*, vol. i. (1905), Mr. Staughton reprints *Theophila* and two other poems by Benlowes, "The Summary of Wisdom," and "A Poetic Descent upon a Private Music-Meeting."

BEN MACDHUI, more correctly **BEN MUICHDHUI** (Gaelic for "the mountain of the black pig," in allusion to its shape), the second highest mountain (4296 ft.) in Great Britain, one of the Cairngorm group, on the confines of south-western Aberdeenshire and south-western Banffshire, not far from the eastern boundary of Inverness-shire. It is about 11 m. from Castleton of Braemar and about 10 from Aviemore. The ascent is usually made from Castleton of Braemar, by way of the Linn of Dee, Glen Lui and Glen Derry. From the head of Glen Derry, with its blasted trees, the picture of desolation, it becomes more toilsome, but is partly repaid by the view of the remarkable columnar cliffs of Corrie Etchachan. The summit is flat and quite bare of vegetation, but the panorama in every direction is extremely grand. At the foot of a vast gully, 2500 ft. above the sea, lies Loch Avon (or A'an), a narrow lake about 1½ m. long, with water of the deepest blue and a margin of bright yellow sand. At the western end of the lake is the Shelter Stone, an enormous block of granite resting upon two other blocks, which can accommodate a dozen persons. Beautiful rock crystals occur in veins in the corries. The summit of Cairngorm, 3½ m. north of that of Ben Macdhui, may be reached from the latter with scarcely any descent, by following the rugged ridge flanking the western side of Loch Avon. The other great peaks of the group are Braerich (4248 ft.) and Cairntoul (4241 ft.), and 6 m. to the east are the twin masses of Ben a Boud, the northern top of which is 3924 ft. and the southern 3860 ft. high. Ben A'an, an adjoining hill, is 3843 ft. high.

BENNETT, CHARLES EDWIN (1838—), American classical scholar, was born on the 6th of April 1858, in Providence, Rhode Island. He graduated from Brown University in 1878 and also studied at Harvard (1881-1882) and in Germany (1882-1884). He taught in secondary schools in Florida (1878-1879), New York (1879-1881), and Nebraska (1885-1889), and became professor of Latin in the University of Wisconsin in 1889, of classical philology at Brown University in 1891, and of Latin at Cornell University in 1892. His syntactical studies, notably various papers on the subjunctive, are based on a statistical examination of Latin texts and are marked by a fresh system of nomenclature; he ranks as one of the leaders of the "New American School" of syntacticians, who insist on a preliminary re-examination of all available data. Of great importance are his advocacy of "quantitative" reading of Latin verse and his *Critique of Some Recent Subjunctive Theories* in vol. ix. (1898) of *Cornell Studies in Classical Philology*, of which he was an editor. Bennett's *Latin Grammar* (1895) is the first successful attempt in America to adopt the method of the brief, scholarly *Schulgrammatik*. Besides the Latin classics commonly read in secondary courses and other text-books in "Bennett's Latin Series," he edited Tacitus's *Dialogus de Oratoribus* (1894), and Cicero's *De Senectute* (1897) and *De Amicitia* (1897). He wrote, with George P. Bristol, *The Teaching of Greek and Latin in Secondary Schools* (1900), and *The Latin Language* (1907), and with William Alexander Hammond translated *The Characters of Theophrastus* (1902).

BENNETT, JAMES GORDON (1794-1872), American journalist, founder and editor of the *New York Herald*, was born at Newmills in Banffshire, Scotland, in 1794 (not in 1800, as has been stated). He was educated for the Roman Catholic priesthood

in a seminary at Aberdeen, but in the spring of 1819, giving up the career which had been chosen for him, he emigrated to America. Landing at Halifax, Nova Scotia, he earned a poor living there for a short time by giving lessons in French, Spanish and bookkeeping; he passed next to Boston, where starvation threatened him until he got employment in a printing-office; and in 1822 he went to New York. An engagement as translator of Spanish for the *Courier* of Charleston, South Carolina, took him there for a few months in 1823. On his return to New York he projected a school, gave lectures on political economy and did subordinate work for the journals. During the next ten years he was employed on various papers, was the Washington correspondent first of the *New York Enquirer*, and later of the *Courier and Enquirer* in 1827-1832, his letters attracting much attention; he founded the short-lived *Globe* in New York in 1832; and in 1833-1834 was the chief editor and one of the proprietors of the *Pennsylvanian* at Philadelphia. On the 6th of May 1835 he published the first number of a small one-cent paper, bearing the title of *New York Herald*, and issuing from a cellar, in which the proprietor and editor played also the part of salesman. "He started with a disclaimer of all principle, as it is called, all party, all politics"; and to this he consistently adhered. By his industry, sagacity and unscrupulousness, and by the variety of his news, the "spicy" correspondence, and the supply of personal gossip and scandal, he made the paper a great commercial success. He devoted his attention particularly to the gathering of news, and was the first to introduce many of the methods of the modern American reporter. He published on the 13th of June 1835, the first Wall Street financial article to appear in any American newspaper; printed a vivid and detailed account of the great fire of December 1835, in New York; was the first, in 1846, to obtain the report in full by telegraph of a long political speech; and during the Civil War maintained a staff of sixty-three war correspondents. Bennett continued to edit the *Herald* almost till his death, at New York, on the 1st of June 1872.

His son, JAMES GORDON BENNETT (1841-), took over the management of the paper during the last year of its founder's life, and succeeded him in its control. It was he who sent Henry M. Stanley on his mission to find Livingstone in Central Africa, and he fitted out the "Jeannette" Polar Expedition, and in 1883 established (with John W. Mackay) the Commercial Cable Company.

BENNETT, JOHN, one of the finest English madrigalists, whose first set of madrigals appeared in 1599. In 1614 Ravenscroft, in a collection including five of his madrigals, writes a eulogy which reads like an obituary notice. The first set of madrigals was reprinted in 1845 by the Musical Antiquarian Society. Bennett's works consist of this set and several contributions to such collections as the *Triumphs of Oriana*, and to various collections of church music.

BENNETT, JOHN HUGHES (1812-1875), English physician and pathologist, was born in London on the 31st of August 1812. He was educated at Exeter, and being destined for the medical profession was articled to a surgeon in Maidstone. In 1833 he began his studies at Edinburgh, and in 1837 graduated with the highest honours. During the next four years he studied in Paris and Germany, and on his return to Edinburgh in 1841 published a *Treatise on Cod-liver Oil as a Therapeutic Agent*. In the same year he began to lecture as an extra-academical teacher on histology, drawing attention to the importance of the microscope in the investigation of disease; and as physician to the Royal Dispensary he instituted courses of "polyclinical medicine." In 1843 he was appointed professor of the institutes of medicine at Edinburgh, and performed the duties of that chair with great energy till incapacitated by failing health. He resigned in 1874. In August 1875 he was able to be present at the meeting of the British Medical Association in Edinburgh, on which occasion he received the degree of LL.D., but the fatigue he then underwent brought on a relapse, and he was compelled to have the operation of lithotomy performed. He sank rapidly and died on the 25th of September at Norwich. His publications were very numerous

including *Lectures on Clinical Medicine* (1850-1856), which in second and subsequent editions were called *Clinical Lectures on the Principles and Practice of Medicine*, and were translated into various languages, including Russian and Hindu; *Leucocythaemia* (1852), the first recorded cure of which was published by him in 1845; *Outlines of Physiology* (1858), reprinted from the 8th edition of the *Encyclopaedia Britannica*; *Pathology and Treatment of Pulmonary Tuberculosis* (1853); *Textbook of Physiology* (1871-1872).

BENNETT, SIR WILLIAM STERNDALE (1816-1875), English musical composer, the son of Robert Bennett, an organist, was born at Sheffield on the 13th of April 1816. Having lost his father at an early age, he was brought up at Cambridge by his grandfather, from whom he received his first musical education. He entered the choir of King's College chapel in 1824. In 1826 he entered the Royal Academy of Music, and remained a pupil of that institution for the next ten years, studying pianoforte under W. H. Holmes and Cipriani Potter, and composition under Lucas and Dr Crotch. It was during this time that he wrote several of his most appreciated works, in which may be traced influences of the contemporary movement of music in Germany, which country he frequently visited during the years 1836-1842. At one of the Rhenish musical festivals in Düsseldorf he made the personal acquaintance of Mendelssohn, and soon afterwards renewed it at Leipzig, where the talented young Englishman was welcomed by the leading musicians of the rising generation. At one of the celebrated Gewandhaus concerts he played his third pianoforte concerto, which was received enthusiastically. An enthusiastic account of the event was written by Robert Schumann, who pronounced Bennett to be the most "musikalisch" of all Englishmen, and "an angel of a musician" (copying Gregory's pun on *Angli* and *Angel*). But it was Mendelssohn's influence that dominated Bennett's mode of utterance. A good example of this may be studied in Bennett's *Capriccio in D minor*. His great success on the continent established his position on his return to England. In 1834 he was elected organist of St Anne's chapel (now church), Wandsworth. In this year he composed his *Overture to Parisina*, and his Concerto in C minor, modelled on Mozart. An unpublished concerto in F minor, and the overture to the *Naiads*, impressed the firm of Broadwood so favourably in 1836 that they offered the composer a year in Leipzig, where the *Naiads* overture was performed at a Gewandhaus concert on the 13th of February 1837. Bennett visited Leipzig a second time in 1840-1841, when he composed his *Caprice in E* for pianoforte and orchestra and his overture *The Wood Nymphs*. He settled in London, devoting himself chiefly to practical teaching. In 1844 he married Mary Anne, daughter of Captain James Wood, R.N. He was made musical professor at Cambridge in 1856, the year in which he was engaged as permanent conductor of the Philharmonic Society. This latter post he held until 1866, when he became principal of the Royal Academy of Music. Owing to his professional duties his latter years were not fertile, and what he then wrote was scarcely equal to the productions of his youth. The principal charm of Bennett's compositions (not to mention his absolute mastery of the musical form) consists in the tenderness of their conception, rising occasionally to sweetest lyrical intensity. Except the opera, Bennett tried his hand at almost all the different forms of vocal and instrumental writing. As his best works in various branches of art, we may mention, for pianoforte solo, and with accompaniment of the orchestra, his three sketches, *The Lake*, *The Mill-stream* and *The Fountain*, and his 3rd pianoforte concerto; for the orchestra, his *Symphony in G minor*, and his overture *The Naiads*; and for voices, his cantata *The May Queen*, written for the Leeds Festival in 1858. For the jubilee of the Philharmonic Society he wrote the overture *Paradise and the Peri* in 1862. He also wrote a sacred cantata, *The Woman of Samaria*, first performed at the Birmingham Musical Festival in 1867. In 1870 the university of Oxford conferred upon him the honorary degree of D.C.L. A year later he was knighted, and in 1872 he received a public testimonial before a large audience at St James's Hall, the money subscribed being devoted to the foundation of a scholarship

at the Royal Academy of Music. Shortly before his death he produced a sonata called the *Maid of Orleans*, an elaborate piece of programme music based on Schiller's tragedy. He died at his house in St John's Wood, London, on the 15th of February 1875. See the *Life*, by his son (1908).

BEN NEVIS, the highest mountain in the British Isles, in Inverness shire, Scotland. It is 4406 ft. above the level of the sea, and is situated 4½ m. E.S.E. of Fort William, the meridian of 5° W. passing through it. As viewed from Banavie on the Caledonian Canal, it has the appearance of two great masses, one higher than the other, and though its bulk is impressive, its outline is much less striking than that of many other Highland hills. Its summit consists of a plateau 100 acres in area, with a slight slope to the south, terminating on its north-eastern side in a sheer fall of more than 1500 ft. Snow lies in some of the gorges all the year round. The rocks of its lower half are mainly granite and gneiss; its upper half is composed of porphyritic greenstone, and a variety of minerals occur. Its circumference at the base is about 30 m. It may be described as flanked on the west and south by the Glen and Water of Nevis, on the east by the river and Glen of Treig, and on the north by the river and Glen of Spean. From 1881 till 1904 meteorological observations were taken from the summit of Ben Nevis, the observers at first making the ascent daily for the purpose. In 1883, however, an observatory, equipped at a cost of £4000 (raised by public subscription), was opened by Mrs Cameron Campbell of Monzie, who provided the site. The observatory, which was connected by wire with the post office at Fort William, was provisioned by the Scottish Meteorological Society, to whom it belonged. The burden of maintaining it, however, proving too great for the society's means, appeal was made in vain to government for national support, and the station was closed in 1904. The bridle road up the mountain leaves Glen Nevis at Achintee; it has a gradient nowhere exceeding 1 in 5, and the ascent is commonly effected in two to three hours. There is a small hotel on the summit for the convenience of tourists, especially of those anxious to witness sunrise. From the summit every considerable peak in Scotland is visible. Observations conducted during several months have shown that, whilst the mean temperature at Fort William was 57° F., at the summit of Ben Nevis it was 49° F., and that though the rainfall at the fort amounted to 24 in., it was as much as 43 in. on the top of the Ben.

BENNIGSEN, LEVIN AUGUST, COUNT VON (1745-1826), Russian general, of Hanoverian family, was born on the 10th of February 1745 in Brunswick, and served successively as a page at the Hanoverian court and as an officer of foot-guards. He retired from the Hanoverian army in 1764, and in 1773 entered the Russian service as a field officer. He fought against the Turks in 1774 and in 1778, becoming lieutenant-colonel in the latter year. In 1787 his conduct at the storming of Oczakov won him promotion to the rank of brigadier, and he distinguished himself repeatedly in the Polish War of 1793-1794 and in the Persian War of 1796. The part played by Bennigsen in the actual assassination of the tsar Paul I. is not fully known, but he took a most active share in the formation and conduct of the conspiracy. Alexander I. made him governor-general of Lithuania in 1801, and in 1802 a general of cavalry. In 1806 he was in command of one of the Russian armies operating against Napoleon, when he fought the battle of Pultusk and met the emperor in person in the sanguinary battle of Eylau (8th of February 1807). Here he could claim to have inflicted the first reverse suffered by Napoleon, but six months later Bennigsen met with the crushing defeat of Friedland (14th of June 1807) the direct consequence of which was the treaty of Tilsit. Bennigsen now retired for some years, but in the campaign of 1812 he reappeared in the army in various responsible positions. He was present at Borodino, and defeated Murat in the engagement of Tarutino, but on account of a quarrel with Marshal Kutusov, the Russian commander-in-chief, he was compelled to retire from active military employment. After the death of Kutusov he was recalled and placed at the head of an army. Bennigsen led one of the columns which made the decisive attack on the last day of the battle of Leipzig (16th-19th of

October 1813). On the same evening he was made a count by the emperor Alexander I., and he afterwards commanded the forces which operated against Marshal Davout in North Germany. After the general peace he held a command from 1815 to 1818, when he retired from active service and settled on his Hanoverian estate of Banteln near Hildesheim. Count Bennigsen died on the 3rd of December 1826. His son, ALEXANDER LEVIN, count von Bennigsen (1809-1893), was a distinguished Hanoverian statesman.

BENNIGSEN, RUDOLF VON (1824-1902), German politician, was born at Lüneburg on the 10th of July 1824. He was descended from an old Hanoverian family, his father, Karl von Bennigsen, being an officer in the Hanoverian army, who rose to the rank of general and also held diplomatic appointments. Bennigsen, having studied at the university of Göttingen, entered the Hanoverian civil service. In 1855 he was elected a member of the second chamber; and as the government refused to allow him leave of absence from his official duties he resigned his post in the public service. He at once became the recognized leader of the Liberal opposition to the reactionary government, but must be distinguished from Count Bennigsen, a member of the same family, and son of the distinguished Russian general, who was also one of the parliamentary leaders at the time. What gave Bennigsen his importance not only in Hanover, but throughout the whole of Germany, was the foundation of the National Verein, which was due to him, and of which he was president. This society, which arose out of the public excitement created by the war between France and Austria, had for its object the formation of a national party which should strive for the unity and the constitutional liberty of the whole Fatherland. It united the moderate Liberals throughout Germany, and at once became a great political power, notwithstanding all the efforts of the governments, and especially of the king of Hanover to suppress it. In 1866 Bennigsen used all his influence to keep Hanover neutral in the conflict between Prussia and Austria, but in vain. He took no part in the war, but his brother, who was an officer in the Prussian army, was killed in Bohemia. In May of this year he had an important interview with Bismarck, who wished to secure his support for the reform of the confederation, and after the war was over at once accepted the position of a Prussian subject, and took his seat in the diet of the North German Confederation and in the Prussian parliament. He used his influence to procure as much autonomy as possible for the province of Hanover, but was a strong opponent of the Guelph party. He was one of the three Hanoverians, Windthorst and Miquel being the other two, who at once won for the representatives of the conquered province the lead in both the Prussian and German parliaments. The National Verein, its work being done, was now dissolved; but Bennigsen was chiefly instrumental in founding a new political party—the National Liberals,—who, while they supported Bismarck's national policy, hoped to secure the constitutional development of the country. For the next thirty years he was president of the party, and was the most influential of the parliamentary leaders. It was chiefly owing to him that the building up of the internal institutions of the empire was carried on without the open breach between Bismarck and the parliament, which was often imminent. Many amendments suggested by him were introduced in the debates on the constitution; in 1870 he undertook a mission to South Germany to strengthen the national party there, and was consulted by Bismarck while at Versailles. It was he who brought about the compromise on the military bill in 1874. In 1877 he was offered the post of vice-chancellor with a seat in the Prussian ministry, but refused it because Bismarck or the king would not agree to his conditions. From this time his relations with the government were less friendly, and in 1878 he brought about the rejection of the first Socialist Bill. In 1883 he resigned his seat in parliament owing to the reactionary measures of the government, which made it impossible for him to continue his former co-operation with Bismarck, but returned in 1887 to support the coalition of national parties. One of the first acts of the emperor William II. was to appoint him president of the province of Hanover. In 1897 he resigned this post and

retired from public life. He died on the 7th of August 1902.

See biographical notices by A. Kiepert (2nd ed., Hanover, 1902), and E. Schreck (Hanover, 1894).

BENNINGTON, a village and one of the county-seats of Bennington county, Vermont, U.S.A., situated in the S.W. part of the state, about 30 m. E.N.E. of Troy, New York. Pop. (1890) 3971; (1900) 5656 (965 foreign-born); (1910) 6211. The township of the same name, in which it is situated, had in 1910 a population of 8698, living chiefly in the villages of Bennington, North Bennington and Bennington Centre, the last a summer resort. The village of Bennington is served by the Rutland railway, and is connected by electric railway with North Adams and Pittsfield, Mass., and Hoosick Falls, N.Y. It is picturesquely situated at the foot of the Green Mountains, and the summit of the neighbouring Mt. Anthony (2345 ft.) commands a magnificent view. The village has woolen mills, knitting mills, stereotype, box, and collar and cuff factories and machine shops. There are white clay and yellow ochre works in different parts of the township. Bennington is the seat of the Vermont state soldiers' home. The Bennington Battle Monument, a shaft 301 ft. high, is said to be the highest battle monument in the world. It commemorates the success gained on the 16th of August 1777 by a force of nearly 2000 "Green Mountain Boys" and New Hampshire and Massachusetts militia under General John Stark over two detachments of General Burgoyne's army, totalling about 1200 men, under Col. Friedrich Baum and Col. Breyman. These came up one after the other in search of provisions and were practically annihilated, Col. Baum being mortally wounded and 700 men taken prisoners. The scene of the battle is about 5 m. from the village. The victory had an important influence on Burgoyne's campaign (see AMERICAN WAR OF INDEPENDENCE), weakening Burgoyne and encouraging the American militia to take the field against him. Bennington was settled in 1761 and was named in honour of Governor Benning Wentworth of New Hampshire. The township was organized in 1762. It was one of the "New Hampshire Grant" towns, both New York and New Hampshire claiming jurisdiction over it, and, being the home of Ethan Allen and Seth Warner, it became the centre of activities of the "Green Mountain Boys," of whom they were leaders. During the fifteen years in which Vermont was an independent commonwealth, Bennington was the headquarters of the council of safety. In 1828-1829 W. L. Garrison edited here a paper called *The Journal of the Times*. The village of Bennington was incorporated in 1849.

See Merrill and Merrill, *Sketches of Historic Bennington* (Cambridge, Mass., 1898).

BENNO (1010-1106), bishop of Meissen, was the son of Werner, count of Woldenburg, was educated at Goslar, and in 1066 was nominated by the emperor Henry IV. to the see of Meissen. In the troubles between empire and papacy that followed Benno took part against the emperor. In 1085 he was deposed by the synod of Mainz, but after the death of Pope Gregory VII. he submitted, and on the recommendation of the imperialist Pope Clement III. was restored to his see, which he held till his death. He hid himself by his diocese, both by ecclesiastical reforms on the Hildebrandine model and by material developments. He was long revered in his own diocese as a saint before, in 1523, he was canonized by Pope Adrian VI. His canonization drew from Luther a violent brochure "against the new false god and old devil, who is to be lifted up at Meissen."

For bibliography, see Ulysse Chevalier, *Répertoire des sources hist.: Bio-bibliographie*, s.v. "Bennon."

BENOÎT, PETER LEONARD LEOPOLD (1834-1901), Flemish composer, was born on the 17th of August 1834 at Harlebeke in Flanders. His father and a local village organist were his first teachers. In 1851 Benoit entered the Brussels Conservatoire, where he remained till 1855, studying chiefly under F. J. Fétis. During this period he composed music to many melodramas, and to an opera *Le Village dans les montagnes* for the Park theatre, of which in 1856 he became conductor. He won

a government prize and a money grant in 1857 by his cantata *Le Meurtre d'Abel*, and this enabled him to travel through Germany. In course of his journeyings he found time to write a considerable amount of music, as well as an essay *L'École de musique flamande et son avenir*. Fétis loudly praised his *Messe solennelle*, which Benoit produced at Brussels on his return from Germany. In 1861 he visited Paris for the production of his opera *Le Roi des Aulnes* ("Erlkönig"), which, though accepted by the Théâtre Lyrique, was never mounted; while there he conducted at the Bouffes-Parisiens. Again returning home, he astonished a section of the musical world by the production at Antwerp of a sacred tetralogy, consisting of his *Cantate de Noël*, the above-mentioned *Mass*, a *Te Deum* and a *Requiem*, in which were embodied to a large extent his theories of Flemish music. It was in consequence of his passion for the founding of an entirely separate Flemish school that Benoit changed his name from Picrre to Peter. By prodigious efforts he succeeded in gathering round him a small band of enthusiasts, who affected to see with him possibilities in the foundation of a school whose music should differ completely from that of the French and German schools. In its main features this school failed, for its faith was pinned to Benoit's music, which is hardly more Flemish than French or German. Benoit's more important compositions include the Flemish oratorios *De Schelde* and *Lucifer*, the latter of which met with complete failure on its production in London in 1888; the operas *Het Dorp int Gebirge* and *Isa*, the *Drama Christi*; an enormous mass of songs, choruses, small cantatas and motets. Benoit also wrote a great number of essays on musical matters. He died at Antwerp on the 8th of March 1901.

BENOÎT DE SAINTE-MORE, OF SAINTE-MAURE, 12th century French trouvère, is supposed to have been a native of Sainte-Maure in Touraine. Very little is known of his personal history. The *matrre* prefixed to his name implies that he had graduated at the university, but there is nothing to show whether he was a simple *trouvère* by profession or belonged to the clergy. He was a loyal subject of Henry II. of England, to whose court he was attached, and when he speaks of the French, it is as "they." Wace had begun a history of the dukes of Normandy in his *Roman du Rou*. This he brought down to the reign of Henry I., but here Henry II. seems to have withdrawn his patronage, and at the end of his poem Wace refers to a *maistre Beneoit* who had received a similar commission. There is no other contemporary poem extant dealing with the subject except the *Chronique des ducs de Normandie*, and it would seem reasonable to assume the identity of Wace's rival with Benoit de Sainte-More, whose authorship of the chronicle has, nevertheless, been often disputed. But a comparison of the *Roman de Troie*, which is certainly Benoit's work, with the *Chronique*, confirms the supposition that they are by the same author. The poem contains over forty thousand lines, and relates the history of the Norman dukes from Rollo to Henry I., with a preliminary sketch of the Danish invasions and the adventures of Hastings and his companions. It has no claims to be considered an original authority. Benoit drew his information from the *De moribus et actis primorum Normannie ducum* of Dudon de Saint Quentin as far as 1002, following his model very closely. From that time he avails himself of the chronicle of William of Jumieges, also of Ordericus Vitalis and others. The *Chronique* probably dates from about 1172 to 1176. In the *Roman de Troie*, written about 1160, Benoit expressly asserts his authorship. He mentions "Omers" with great respect as *li clers merveilleux*, but his authority for the story is naturally not Homer, of whom he could have no first-hand knowledge. He follows the apocryphal *Historia de excidio Trojæ* of Dares the Phrygian and the *Ephemerides belli Trojani* of Dictys of Crete. The poem runs to about 30,000 lines. The personages of the classical story are converted into heroes of romance. They have their castles and their abbeyes, and act in accordance with feudal custom. The supernatural machinery of Homer is missing both in Benoit's original and his own narrative. The story begins with the capture of the Golden Fleece and comes down to the return of the Greek princes after

the fall of Troy. Benoit diverges very widely from the classical tradition, and M. Léopold Constans sees reason to suppose that the *trouvère* founded his poem on an amplified version of the Dares narrative that has not come down to us. In the *Roman de Troie* first appeared the episode of Troilus and Briseida, that was to be developed later in the *Filostrato* of Boccaccio, which in its turn formed the basis of Chaucer's *Troilus and Criseide*. The Shakespearian play of *Troilus and Cressida* is also indirectly derived from Benoit's story.

On the strength of a certain similarity of treatment Benoit has sometimes been credited with the authorship of the anonymous *Roman d'Énéas* and of the *Roman de Thèbes*, a romance derived indirectly from the *Thebais* of Statius. M. Constans is inclined to negative both these attributions. It is not even certain that the Benoit who chronicled the deeds of the Norman dukes for Henry II. between 1172 and 1176 was the Benoit de Sainte-More of the *Roman de Troie*.

The *Chronique des ducs de Normandie* was edited by Francisque Michel in 1836-1844; the *Roman de Troie* by A. Joly in 1870-1871; the *Énéas*, by J. J. Salverda de Grave in H. Suchier's *Bibliotheca Normannica* in 1891; the *Roman de Thèbes* for the *Société des anciens textes français*, by M. L. Constans in 1890. See E. D. Grand in *La Grande Encyclopédie*; L. Constans in *Petit de Julleville's Hist. de la langue et de la litt. française* (vol. I, pp. 171-225). Since these romances are analysed at length. The prefaces to the editions just mentioned discuss the authorship of the romances.

BENSERADE, ISAAC DE (1613-1691), French poet, was born in Paris, and baptized on the 5th of November 1613. His family appears to have been connected with Richelieu, who bestowed on him a pension of 600 livres. He began his literary career with the tragedy of *Cléopâtre* (1635), which was followed by four other indifferent pieces. On Richelieu's death Benserade lost his pension, but became more and more a favourite at court, especially with Anne of Austria. He provided the words for the court ballets, and was, in 1674, admitted to the Academy, where he wielded an influence quite out of proportion to the merit of his work. In 1676 the failure of his *Métamorphoses d'Ovide* in the form of rondeaux gave a blow to his reputation, but by no means destroyed his vogue with his contemporaries. Benserade would probably be forgotten but for his sonnet on Job (1651). This sonnet, which he sent to a young lady with his paraphrase on Job, having been placed in competition with the *Uranie* of Voiture, a dispute on their relative merits long divided the whole court and the wits into two parties, styled respectively the *Jobelins* and the *Uranists*. The partisans of Benserade were headed by the prince de Conti and Mlle de Scudéry, while Mme de Montausier and J. G. de Balzac took the side of Voiture.

Some years before his death, on the 10th of October 1691, Benserade retired to Chantilly, and devoted himself to a translation of the Psalms, which he nearly completed.

BENSLEY, ROBERT, an 18th-century English actor, of whom Charles Lamb in the *Essays of Elia* speaks with special praise. His early life is obscure, and he is said to have served in America as a lieutenant of marines; but he appeared at Drury Lane in 1765, and at that house and at Covent Garden, and later at the Haymarket, he played important parts up to 1796, when he retired from the stage. He appears then to have been given a small post under the government, a paymastership, which he resigned in 1798. He is stated in various quarters to have died in 1817, but Mr Joseph Knight shows in his article in the *Dict. Nat. Biog.* that this is due to a confusion with another man named William Bensley, who possibly belonged to the family of printers of whom Thomas Bensley (d. 1833) was the chief representative. On the stage he was simply "Mr Bensley," but though he is named William and even Richard in some accounts, Mr Knight shows that his name was certainly Robert. The actual date of his death is unknown, though it was probably later than 1809, when he is said to have inherited a fortune. His great character was Malvolvo, but Charles Lamb's fervent admiration of his acting seems to have outrun the general opinion.

BENSON, EDWARD WHITE (1820-1896), archbishop of Canterbury, was born on the 14th of July 1820, at Birmingham.

He came of a family of Yorkshire dalesmen, his father, whose name was also Edward White Benson, being a manufacturing chemist of some note. He was educated at King Edward VI.'s school, Birmingham, under James Prince Lee, afterwards bishop of Manchester, and amongst his school-fellows were B. F. Westcott and J. B. Lightfoot, both of whom preceded him to Trinity College, Cambridge, where he was elected a sub-sizar in 1848, becoming subsequently sizar and scholar. The death of his widowed mother in 1850 left him almost without resources, with a family of younger brothers and sisters dependent upon him. Relations came to his aid, and presently his anxieties were relieved by Francis Martin, bursar of Trinity, who gave him liberal help. Benson took his degree in 1852 as a senior optime, eighth classic and senior chancellor's medallist, and was elected fellow of Trinity in the following year. He became a master at Rugby, first under E. M. Goulburn, and then (1857) under Frederick Temple, who became his lifelong friend; he was also ordained deacon in 1854 and priest in 1856. From Rugby he went to be first headmaster of Wellington College, which was opened in January 1859; and in the course of the same year he married his cousin, Mary Sidgwick. The school flourished under his management and also developed his administrative abilities, but gradually his thoughts began to turn towards other work. In 1868 he became prebendary of Lincoln and examining chaplain to Bishop Christopher Wordsworth, an office which he also held for a short time in 1870 for Dr Temple, just appointed to the see of Exeter. In 1872 his acceptance of the chancellorship of Lincoln opened a new period of his life. As chancellor, the statutes directed him to study theology, to train others in that study and to oversee the educational work of the diocese. To such work Benson at once devoted himself; and did more perhaps than any other man to reinvigorate cathedral life in England. He started a theological college (the *Scholæ Cancellarii*), founded night schools, delivered courses of lectures on church history, held Bible classes, and was instrumental in founding a society of mission preachers for the diocese, the "Novate Novale." Early in 1877 he was consecrated first bishop of Truro, and threw himself with characteristic vigour into the work of organizing the new diocese. His knowledge, his sympathy, his enthusiasm soon made themselves felt everywhere; the rudericanal conferences of clergy became a real force, and the church in Cornwall was inspired with a vitality that had never been possible when it was part of the unwieldy diocese of Exeter. A chapter was constituted, the bishop being dean; amongst its members was a canon missioner (the first to be appointed in England), and the *Scholæ Cancellarii* were founded after the Lincoln pattern. Moreover, the bishop at once set to work to build a cathedral. The foundation-stone was laid on the 20th of May 1880, and on the 3rd of November 1887 the building, so far as then completed, was consecrated. On the death of Dr Tait, Benson was nominated to the see of Canterbury and was enthroned on the 20th of March 1883. His primacy was one of almost unprecedented activity.

Frequent communications passed between him and the heads of the Eastern Churches. With their approval a bishop was again consecrated, after six years' interval (1881-1887), for the Anglican congregations in Jerusalem and the East; and the features which had made the plan objectionable to many English churchmen were now abolished. In 1886, after much careful investigation, he founded the "Archbishop's Mission to the Assyrian Christians," having for its object the instruction and the strengthening from within of the "Nestorian" churches of the East (see NESTORIANS). An interchange of courtesies with the Metropolitan of Kiev on the occasion of the 900th anniversary of the conversion of Russia (1888), led to further intercourse, which has tended to a friendlier feeling between the English and Russian churches. On the other hand, with the efforts towards a *rapprochement* with the Church of Rome, to which the visit of the French Abbé Portal in 1894 gave some stimulus, the archbishop would have nothing to do.

With the other churches of the Anglican Communion the archbishop's relations were cordial in the extreme and grew

closer as time went on. Particular questions of importance, the Jerusalem bishopric, the healing of the Colenso schism in the diocese of Natal, the organization of native ministries and the like, occupied much of his time; and he did all in his power to foster the growth of local churches. But it was the work at home which occupied most of his energies. That he in no way slighted diocesan work had been shown at Truro. He complained now that the bishops were "bishops of their dioceses but not bishops of England," and did all he could to make the Church a greater religious force in English life. He sat on the ecclesiastical courts commission (1881-1883) and the sweating commission (1888-1890). He brought bills into parliament to reform Church patronage and Church discipline, and worked unremittingly for years in their behalf. The latter became law in 1892, and the former was merged in the Benefices Bill, which passed in 1898, after his death. He wrote and spoke vigorously against Welsh disestablishment (1893); and in the following year, under his guidance, the existing agencies for Church defence were consolidated. He was largely instrumental in the inauguration of the House of Laymen in the province of Canterbury (1886); he made diligent inquiries as to the internal order of the sisterhoods of which he was visitor; from 1884 onwards he gave regular Bible readings for ladies in Lambeth Palace chapel. But the most important ecclesiastical event of his primacy was the judgment in the case of the bishop of Lincoln (see LINCOLN JUDGMENT), in which the law of the prayer-book is investigated, as it had never been before, from the standpoint of the whole history of the English Church. In 1896 the archbishop went to Ireland to see the working of the sister Church. He was received with enthusiasm, but the work which his tour entailed over-fatigued him. On Sunday morning the 11th of October, just after his return, whilst on a visit to Mr Gladstone, he died in Hawarden parish church of heart failure.

Archbishop Benson left numerous writings, including a valuable essay on *The Cathedral* (London, 1878), and various charges and volumes of sermons and addresses. But his two chief works, posthumously published, are his *Cyprian* (London, 1897), a work of great learning, which had occupied him at intervals since early manhood; and *The Apocalypse, an Introductory Study* (London, 1900), interesting and beautiful, but limited by the fact that the method of study is that of a Greek play, not of a Hebrew apocalypse. The archbishop's knowledge of the past was both wide and minute, but it was that of an antiquary rather than of a historian. "I think," writes his son, "he was more interested in modern movements for their resemblance to ancient than vice versa." His sermons are very noble though written in a style which is over-compressed and often obscure. He wrote some good hymns, including "O Throned, O Crowned" and a beautiful version of *Urbs Beata*. His "grandeur in social function" was unequalled and his interests were very wide. But above all else he was a great ecclesiastic. He paid less attention to secular politics than Archbishop Tait; but if a man is to be judged by the effect of his work, it is Benson and not Tait who should be described as a great statesman. His biography, by his son, reveals him as a man of devout and holy life, impulsive indeed and masterful, but one who learned self-restraint by strenuous endeavour.

His eldest son, ARTHUR CHRISTOPHER BENSON (b. 1862), was educated at Eton and King's College, Cambridge. He became fellow of Magdalene College, Cambridge, and was a master at Eton College from 1885 to 1903. His literary capacity was early shown in the remarkable fiction of his *Memoirs of Arthur Hamilton* (1886) under the pseudonym of "Christopher Carr," and his *Poems* (1893) and *Lyrics* (1895) established his reputation as a writer of verse. Among his works are *Fasts Etrennes* (1899); his father's *Life* (1899); *The Schoolmaster* (1902), a commentary on the aims and methods of an assistant schoolmaster in a public school; a study of Archbishop Laud (1887); monographs on D. G. Rossetti (1904), Edward Fitzgerald (1905) and Walter Pater (1906), in the "English Men of Letters" series; *Lord Vyat and other Poems* (1897), *Peace and other Poems* (1905); *The Upton Letters* (1905), *From a College Window*

(1906), *Beside Still Waters* (1907). He also collaborated with Lord Esher in editing the *Correspondence of Queen Victoria* (1907).

The third son, EDWARD FREDERICK BENSON (b. 1867), was educated at Marlborough College and King's College, Cambridge. He worked at Athens for the British Archaeological Society from 1892 to 1895, and subsequently in Egypt for the Hellenic Society. In 1893 his society novel, *Dodo*, brought him to the front among the writers of clever fiction; and this was followed by other novels, notably *The Vintage* (1898) and *The Capsina* (1899).

The fourth son, ROBERT HUGH BENSON (b. 1871), was educated at Eton and Trinity College, Cambridge. After reading with Dean Vaughan at Llandaff he took orders, and in 1898 became a member of the Community of the Resurrection at Mirfield. In 1903 he became a Roman Catholic, was ordained priest at Rome in the following year, and returned to Cambridge as assistant priest of the Roman Catholic church there. Among his numerous publications are *The Light Invisible, By What Authority?*, *The King's Achievement*, *Richard Raynal, Solitary*, *The Queen's Tragedy*, *The Sentimentalists*, *Lord of the World*.

See A. C. Benson, *Life of Archbishop Benson* (2 vols., London, 1899); J. H. Bernard, *Archbishop Benson in Ireland* (1897); Sir L. T. Dibdin in *The Quarterly Review*, October 1897.

BENSON, FRANCIS ROBERT (1858-), English actor, son of William Benson of Alresford, Hants, was born at Tunbridge Wells on the 4th of November 1858. He came of a talented family, his elder brother, W. A. S. Benson (b. 1854), becoming well known in the world of art as one of the pioneers in the revival of English industrial craftsmanship, especially in the field of the metallic arts; and his younger brother, Godfrey Benson, being an active Liberal politician. He was educated at Winchester and New College, Oxford, and at the university was distinguished both as an athlete (winning the Inter-university three miles) and as an amateur actor. In the latter respect he was notable for producing at Oxford the first performance of a Greek play, the *Agamemnon*, in which many Oxford men who afterwards became famous in other fields took part. Mr Benson, on leaving Oxford, took to the professional stage, and made his first appearance at the Lyceum, under Irving, in *Romeo and Juliet*, as Paris, in 1882. In the next year he went into management with a company of his own, taken over from Walter Bentley, and from this time he became gradually more and more prominent, both as an actor of leading parts himself and as the organizer of practically the only modern "stock company" touring through the provinces. In 1886 he married Gertrude Constance Cockburn (Featherstonhaugh), who acted in his company and continued to play leading parts with him. Mr Benson's chief successes were gained out of London for some years, but in 1890 he had a season in London at the Globe and in 1900 at the Lyceum, and in later years he was seen with his *répertoire* at the Coronet. His company included from time to time many actors and actresses who, having been trained under him, became prominent on their own account, and both by his organization of this regular company and by his foundation of a dramatic school of acting in 1901, Mr Benson exercised a most important influence on the contemporary stage. From the first he devoted himself largely to the production of Shakespeare's plays, reviving many which had not been acted for generations, and his services to the cause of Shakespeare can hardly be overestimated. From 1888 onwards he managed the Stratford-on-Avon Shakespearean Festival. His romantic and intellectual powers as an actor, combined with his athletic and picturesque bearing and fine elocution, were conspicuously shown in his own impersonations, most remarkable among which were his Hamlet (in 1900 he produced this play without cuts in London), his Coriolanus, his Richard II., his Lear and his Putschio.

BENSON, FRANK WESTON (1862-), American painter, was born in Salem, Massachusetts, on the 24th of March 1862. He was a pupil of Boulanger and of Lefebvre in Paris; won many distinctions in American exhibitions, and a silver medal at the Paris Exhibition of 1900; and became a member of

the "Ten Americans," and of the National Academy of Design, New York. Besides portraits, he painted landscape and still life; and he was one of the decorators of the Congressional library, Washington, D.C.

BENSON, GEORGE (1699–1762), English dissenting minister, was born at Great Salkeld, in Cumberland, on the 1st of September 1699, of a family which had distinguished itself in church and state. He studied at a school at Whitehaven and later at the university of Glasgow. In 1722, on Calamy's recommendation, he was chosen pastor of a congregation of dissenters at Abingdon, in Berkshire, where he continued till 1729, when, having embraced Arminian views, he became the choice of a congregation in Southwark; and in 1740 he was appointed by the congregation of Crutched Friars colleague to the learned Dr Nathaniel Lardner, whom he succeeded in 1749. His *Defence of the Reasonableness of Prayer* appeared in 1731, and he afterwards published paraphrases and notes on the epistles to the Thessalonians, Timothy, Titus and Philemon, adding dissertations on several important subjects, particularly (as an appendix to 1 Timothy) on inspiration. In 1738 he published his *History of the First Planting of the Christian Religion*, in 3 vols. 4to, a work of great learning and ability. He also wrote the *Reasonableness of the Christian Religion* (1743), the *History of the Life of Jesus Christ*, posthumously published in 1764, a paraphrase and notes on the seven Catholic epistles, and several other works, which gained him great reputation as a scholar and theologian even outside his own communion and his own country. Owing to his undoubted Socinianism his works suffered neglect after his death, which occurred on the 6th of April 1762.

BENT, JAMES THEODORE (1852–1897), English traveller, was the son of James Bent of Baildon House, near Leeds, Yorkshire, where he was born on the 30th of March 1852. He was educated at Repton school and Wadham College, Oxford, where he graduated in 1875. In 1877 he married Mabel, daughter of R. W. Hall-Dare of Newtownbarry, Co. Wexford, and she became his companion in all his travels. He went abroad every year and became thoroughly acquainted with Italy and Greece. In 1879 he published a book on the republic of San Marino, entitled *A Freak of Freedom*, and was made a citizen of San Marino; in the following year appeared *Genoa: How the Republic Rose and Fell*, and in 1881 a *Life of Giuseppe Garibaldi*. He spent considerable time in the Aegean archipelago, of which he wrote in *The Cyclades: or Life among the Insular Greeks* (1885). From this period Bent devoted himself particularly to archaeological research. The years 1885–1888 were given up to investigations in Asia Minor, his discoveries and conclusions being communicated to the *Journal of Hellenic Studies* and other magazines and reviews. In 1889 he undertook excavations in the Bahrein Islands of the Persian Gulf, and found evidence that they had been a primitive home of the Phoenician race. After an expedition in 1890 to Cilicia Trachea, where he obtained a valuable collection of inscriptions, Bent spent a year in South Africa, with the object, by investigation of some of the ruins in Mashonaland, of throwing light on the vexed question of their origin and on the early history of East Africa. He made the first detailed examination of the Great Zimbabwe. Bent described his work in *The Ruined Cities of Mashonaland* (1892). In 1893 he investigated the ruins of Axum and other places in the north of Abyssinia, partially made known before by the researches of Henry Salt and others, and *The Sacred City of the Ethiopians* (1893) gave an account of this expedition. Bent now visited at considerable risk the almost unknown Hadramut country (1893–1894), and during this and later journeys in southern Arabia he studied the ancient history of the country, its physical features and actual condition. On the Dhafar coast in 1894–1895 he visited ruins which he identified with the Abyssopolis of the frankincense merchants. In 1895–1896 he examined part of the African coast of the Red Sea, finding there the ruins of a very ancient gold-mine and traces of what he considered Sabean influence. While on another journey in South Arabia (1896–1897), Bent was seized with malarial fever, and died in London on the 5th of May 1897, a few days after his return. Mrs Bent, who had contributed by her skill as a photo-

grapher and in other ways to the success of her husband's journeys, published in 1900 *Southern Arabia, Soudan and Sakotra*, in which were given the results of their last expedition into that region. The conclusions at which Bent arrived as to the Semitic origin of the ruins in Mashonaland have not been accepted by archaeologists, but the value of his pioneer work is undeniable (see ZIMBABWE).

BENT, 1. (From "to bend"), primarily the result of bending; hence any inclination from the straight, as in curved objects like a hook or a bow; this survives in the modern phrase "to follow one's own bent," i.e. to pursue a certain course in a direction deviating from the normal, as also in such phrases as Chaucer's "Downward on a hill under a bent," indicating a hollow or declivity in the general configuration of the land. From the bending of a bow comes the idea of tension, as in Hamlet, "they fool me to the top of my bent," i.e. to the utmost of my capacity. 2. (From the O. Eng. *beonet*, a coarse, rushy grass growing in wet places; cf. the Ger. *Bins*, a reed), the name ("bent" or "bennet") popularly applied to several kinds of grass and surviving in the form "bent-grass."

BENTHAM, GEORGE (1800–1884), English botanist, was born at Stoke near Portsmouth on the 22nd of September 1800. His father, Sir Samuel Bentham (1757–1831), was the only brother of Jeremy Bentham, the publicist, and of scarcely inferior ability though in a different direction. Devoting himself in early life to the study of naval architecture, Sir Samuel went to Russia to visit the naval establishments in the Baltic and Black Seas. He was induced to enter the service of the empress Catherine II., built a flotilla of gunboats and defeated the Turkish fleet. For this he was made, in addition to other honours, colonel of a cavalry regiment. On the death of the empress he returned to England to be employed by the admiralty, and was sent (1805–1807) again to Russia to superintend the building of some ships for the British navy. He attained the rank, under the admiralty, of inspector-general of naval works. He introduced a multitude of improvements in naval organization, and it was largely through his recommendation that M. I. Brunel's block-making machinery was installed at Portsmouth.

George Bentham had neither a school nor a college education, but early acquired the power of giving sustained and concentrated attention to any subject that occupied him—one essential condition of the success he attained as perhaps the greatest systematic botanist of the 19th century. Another was his remarkable linguistic aptitude. At the age of six to seven he could converse in French, German and Russian, and he learnt Swedish during a short residence in Sweden when little older. At the close of the war with France, the Bentham family made a long tour through that country, staying two years at Montauban, where Bentham studied Hebrew and mathematics in the Protestant Theological School. They eventually settled in the neighbourhood of Montpellier where Sir Samuel purchased a large estate.

The mode in which George Bentham was attracted to the botanical studies which became the occupation of his life is noteworthy; it was through the applicability to them of the logical methods which he had imbibed from his uncle's writings, and not from any special attraction to natural history pursuits. While studying at Angoulême a copy of A. P. de Candolle's *Flore française* fell into his hands and he was struck with the analytical tables for identifying plants. He immediately proceeded to test their use on the first that presented itself. The result was successful and he continued to apply it to every plant he came across. A visit to London in 1823 brought him into contact with the brilliant circle of English botanists. In 1826, at the pressing invitation of his uncle, he agreed to act as his secretary, at the same time entering at Lincoln's Inn and reading for the bar. He was called in due time and in 1832 held his first and last brief. The same year Jeremy Bentham died, leaving his property to his nephew. His father's inheritance had fallen to him the previous year. He was now in a position of modest independence, and able to pursue undistractedly his favourite studies. For a time these were divided between botany,

jurisprudence and logic, in addition to editing his father's professional papers. Bentham's first publication was his *Catalogue des plantes indigènes des Pyrénées et du Bas Languedoc* (Paris, 1826), the result of a careful exploration of the Pyrenees in company with G. A. Walker Arnott (1799-1868), afterwards professor of botany in the university of Glasgow. It is interesting to notice that in it Bentham adopted the principle from which he never deviated, of citing nothing at second-hand. This was followed by articles on various legal subjects: on codification, in which he disagreed with his uncle, on the laws affecting larceny and on the law of real property. But the most remarkable production of this period was the *Outline of a New System of Logic*, with a *Critical Examination of Dr Whately's Elements of Logic* (1827). In this the principle of the quantification of the predicate was first explicitly stated. This Stanley Jevons declared to be "undoubtedly the most fruitful discovery made in abstract logical science since the time of Aristotle." Before sixty copies had been sold the publisher became bankrupt and the stock went for wastepaper. The book passed into oblivion, and it was not till 1873 that Bentham's claims to priority were finally vindicated against those of Sir William Hamilton by Herbert Spencer. In 1836 he published his *Labiatorum genera et species*. In preparing this work he visited, between 1830-1834, every European herbarium, several more than once. The following winter was passed in Vienna, where he produced his *Commentationes de Leguminosarum generibus*, published in the annals of the Vienna Museum. In 1842 he removed to Pontilas in Herefordshire. His chief occupation for some succeeding years was his contributions to the *Prodromus Systematis Naturalis Regni Vegetabilis*, which was being carried on by his friend, A. P. deCandolle. In all these dealt with some 4730 species.

In 1854 he found the maintenance of a herbarium and library too great a tax on his means. He therefore offered them to the government on the understanding that they should form the foundation of such necessary aids to research in the Royal Botanic Gardens at Kew. At the same time he contemplated the abandonment of botanical work. Fortunately, he yielded to the persuasion of Sir William Hooker, John Lindley and other scientific friends. In 1855 he took up his residence in London, and worked at Kew for five days a week, with a brief summer holiday, from this time onwards till the end of his life. As his friend Asa Gray wrote: "With such methodical habits, with freedom from professional or administrative functions, which consume the time of most botanists, with steady devotion to his chosen work, and with nearly all authentic material and needful appliances at hand or within reach, it is not so surprising that he should have undertaken and have so well accomplished such a vast amount of work, and he has the crowning merit and happy fortune of having completed all that he undertook." The government, in 1857, sanctioned a scheme for the preparation of a series of Floras or descriptions in the English language of the indigenous plants of British colonies and possessions. Bentham began with the *Flora Hongkongensis* in 1861, which was the first comprehensive work on any part of the little-known flora of China. This was followed by the *Flora Australiensis*, in seven volumes (1863-1878), the first flora of any large continental area that had ever been finished. His greatest work was the *Genera Plantarum*, begun in 1862, and concluded in 1883 in collaboration with Sir Joseph Hooker, "the greater portion being," as Sir Joseph Hooker tells us, "the product of Bentham's indefatigable industry." As age gradually impaired his bodily powers, he seemed at last only to live for the completion of this monumental work.

When the last revise of the last sheet was returned to the printer, the stimulus was withdrawn, and his powers seemed suddenly to fail him. He began a brief autobiography, but the pen with which he had written his two greatest works broke in his hand in the middle of a page. He accepted the omen, laid aside the unfinished manuscript and patiently awaited the not distant end. He died on the 10th of September 1884, within a fortnight of his 84th birthday.

The scientific world received the *Genera Plantarum* with as

unanimous an assent as was accorded to the *Species Plantarum* of Linnaeus. Bentham possessed, as Professor Daniel Oliver remarked, "an insight of so special a character as to describe the name of genius, into the relative value of characters for practical systematic work, and as a consequence of this, a sure sifting of essentials from non-essentials in each respective grade." His preparation for his crowning work had been practically lifelong. There are few parts of the world upon the botany of which he did not touch. In the sequence and arrangement of the great families of flowering plants, different views from those of Bentham may be adopted. But Bentham paved the way by an intimate and exact statement of the structural facts and their accurate relationship, which is not likely to be improved. In method and style, in descriptive work, Bentham was a supreme master. This, to quote Professor Oliver again, is "manifest not only in its terseness, aptness and precision, but especially in the judicious selection of diagnostic marks, and in the instinctive estimate of probable range in variation, which long experience and innate genius for such work could alone inspire." (W. T. T.-D.)

BENTHAM, JEREMY (1748-1832), English philosopher and jurist, was born on the 15th of February 1748 in Red Lion Street, Houndsditch, London, in which neighbourhood his grandfather and father successively carried on business as attorneys. His father, who was a wealthy man and possessed at any rate a smattering of Greek, Latin and French, was thought to have demeaned himself by marrying the daughter of an Andover tradesman, who afterwards retired to a country house near Reading, where young Jeremy spent many happy days. The boy's talents justified the ambitious hopes which his parents entertained of his future. When three years old he read eagerly such works as Rapin's *History* and began the study of Latin. A year or two later he learnt to play the violin and to speak French. At Westminster school he obtained a reputation for Greek and Latin verse writing; and he was only thirteen when he was matriculated at Queen's College, Oxford, where his most important acquisition seems to have been a thorough acquaintance with Sanderson's logic. He became a B.A. in 1763, and in the same year entered at Lincoln's Inn, and took his seat as a student in the Queen's bench, where he listened with rapture to the judgments of Lord Mansfield. He managed also to hear Blackstone's lectures at Oxford, but says that he immediately detected the fallacies which underlay the rounded periods of the future judge.

Bentham's family connexions would naturally have given him a fair start at the bar, but this was not the career for which he was preparing himself. He spent his time in making chemical experiments and in speculating upon legal abuses, rather than in reading Coke upon Littleton and the Reports. On being called to the bar he "found a cause or two at nurse for him, which he did his best to put to death," to the bitter disappointment of his father, who had confidently looked forward to seeing him upon the woolstack. The first fruits of Bentham's studies, the *Fragment on Government*, appeared in 1776. This masterly attack upon Blackstone's praises of the English constitution was variously attributed to Lord Mansfield, Lord Camden and Lord Ashburton. One important result of its publication was that, in 1781, Lord Shelburne (afterwards first marquess of Lansdowne) called upon its author in his chambers at Lincoln's Inn. Henceforth Bentham was a frequent guest at Bowood, where he saw the best society and where he met Miss Caroline Fox (daughter of the second Lord Holland), to whom he afterwards made a proposal of marriage. In 1785 Bentham started, by way of Italy and Constantinople, on a visit to his brother, Samuel Bentham, a naval engineer, holding the rank of colonel in the Russian service; and it was in Russia that he wrote his *Defence of Usury*. Disappointed after his return to England in 1788 in the hope which he had entertained, through a misapprehension of something said by Lord Lansdowne, of taking a personal part in the legislation of his country, he settled down to the yet higher task of discovering and teaching the principles upon which all sound legislation must proceed. The great work, upon which he had

been engaged for many years, the *Principles of Morals and Legislation*, was published in 1789. His fame spread widely and rapidly. He was made a French citizen in 1792; and his advice was respectfully received in most of the states of Europe and America, with many of the leading men of which he maintained an active correspondence. In 1817 he became a bencher of Lincoln's Inn. His ambition was to be allowed to prepare a code of laws for his own or some foreign country. During nearly a quarter of a century he was engaged in negotiations with the government for the erection of a "Panopticon," for the central inspection of convicts; a plan suggested to him by a building designed by his brother Samuel, for the better supervision of his Russian shipwrights. This scheme, which it was alleged would render transportation unnecessary, was eventually abandoned, and Bentham received in 1813, in pursuance of an act of parliament, £23,000 by way of compensation. It was at a later period of his life that he propounded schemes for cutting canals through the isthmus of Suez and the isthmus of Panama. In 1823 he established the *Westminster Review*. Emboldened perhaps by the windfall of 1813, in the following year took a lease of Ford Abbey, a fine mansion with a deer-park, in Dorsetshire; but in 1818 returned to the house in Queen's Square Place which he had occupied since the death of his father in 1792. It was there that he died on the 6th of June 1832 in his eighty-fifth year. In accordance with his directions, his body was dissected in the presence of his friends, and the skeleton is still preserved in University College, London.

Bentham's life was a happy one of its kind. His constitution, weakly in childhood, strengthened with advancing years so as to allow him to get through an incredible amount of sedentary labour, while he retained to the last the fresh and cheerful temperament of a boy. An ample inherited fortune permitted him to pursue his studies undistracted by the necessity for earning a livelihood, and to maximize the results of his time and labour by the employment of amanuenses and secretaries. He was able to gather around him a group of congenial friends and pupils, such as the Mills, the Austins and Bowring, with whom he could discuss the problems upon which he was engaged, and by whom several of his books were practically rewritten from the mass of rough though orderly memoranda which the master had himself prepared. Thus, for instance, was the *Rationale of Judicial Evidence* written out by J. S. Mill and the *Book of Fallacies* by Bingham. The services which Dumont rendered in recasting as well as translating the works of Bentham were still more important.

The popular notion that Bentham was a morose visionary is far removed from fact. It is true that he looked upon general society as a waste of time and that he disliked poetry as "misrepresentation"; but he intensely enjoyed conversation, gave good dinners and delighted in music, in country sights and in making others happy. These features of Bentham's character are illustrated in the graphic account given by the American minister, Richard Rush, of an evening spent at his London house in the summer of the year 1818. "If Mr Bentham's character is peculiar," he says, "so is his place of residence. It was a kind of blind-alley, the end of which widened into a small, neat courtyard. There by itself stands Mr Bentham's house. Shrubbery graced its area and flowers its window-sills. It was like an oasis in the desert. Its name is the Hermitage. Mr Bentham received me with the simplicity of a philosopher. I should have taken him for seventy or upwards. Everything inside the house was orderly. The furniture seemed to have been unmoved since the days of his fathers, for I learned that it was a patrimony. A parlour, library and dining-room made up the suite of apartments. In each was a piano, the eccentric master of the whole being fond of music as the recreation of his literary hours. It is a unique, romantic-like homestead. Walking with him into the garden, I found it dark with the shade of ancient trees. They formed a barrier against all intrusion. The company was small but choice. Mr Brougham; Sir Samuel Romilly; Mr Mill, author of the well-known work on India; M. Dumont, the learned Genevan, once the associate of

Mirabeau, were all who sat down to table. Mr Bentham did not talk much. He had a benevolence of manner suited to the philanthropy of his mind. He seemed to be thinking only of the convenience and pleasure of his guests, not as a rule of artificial breeding as from Chesterfield or Madame Genlis, but from innate feeling. Bold as are his opinions in his works, here he was wholly unobtrusive of theories that might not have commended the assent of all present. When he did converse it was in simple language, a contrast to his later writings, where an involved style and the use of new or universal words are drawbacks upon the speculations of a genius original and profound, but with the faults of solitude. Yet some of his earlier productions are distinguished by classical terseness."—(*Residence at the Court of London*, p. 286.) Bentham's love of flowers and music, of green foliage and shaded walks, comes clearly out in this pleasant picture of his home life and social surroundings.

Whether or no he can be said to have founded a school, his doctrines have become so far part of the common thought of the time, that there is hardly an educated man who does not accept as too clear for argument truths which were invisible till Bentham pointed them out. His sensitively honourable nature, which in early life had caused him to shrink from asserting his belief in Thirty-nine articles of faith which he had not examined, was shocked by the enormous abuses which confronted him on commencing the study of the law. He rebelled at hearing the system under which they flourished described as the perfection of human reason. But he was no merely destructive critic. He was determined to find a solid foundation for both morality and law, and to raise upon it an edifice, no stone of which should be laid except in accordance with the deductions of the severest logic. This foundation is "the greatest happiness of the greatest number," a formula adopted from Priestly or perhaps first from Beccaria. The phrase may, however, be found in writers of an earlier date than these, e.g. in Hutcheson's *Enquiry*, published in 1725. The pursuit of such happiness is taught by the "utilitarian" philosophy, an expression used by Bentham himself in 1802, and therefore not invented by J. S. Mill, as he supposed, in 1823. In order to ascertain what modes of action are most conducive to the end in view, and what motives are best fitted to produce them, Bentham was led to construct marvellously exhaustive, though somewhat mechanical, tables of motives. With all their elaboration, these tables are, however, defective, as omitting some of the highest and most influential springs of action. But most of Bentham's conclusions may be accepted without any formal profession of the utilitarian theory of morals. They are, indeed, merely the application of a rigorous common sense to the facts of society. That the proximate ends at which Bentham aimed are desirable hardly any one would deny, though the feasibility of the means by which he proposes to attain them may often be questioned, and much of the new nomenclature in which he thought fit to clothe his doctrines may be rejected as unnecessary. To be judged fairly, Bentham must be judged as a teacher of the principles of legislation. With the principles of private morals he really deals only so far as is necessary to enable the reader to appreciate the impulses which have to be controlled by law.

As a teacher of legislation he inquires of all institutions whether their utility justifies their existence. If not, he is prepared to suggest a new form of institution by which the needful service may be rendered. While thus engaged no topic is too large for his mental grasp, none too small for his notice; and, what is still rarer, every topic is seen in its due relation to the rest. English institutions had never before been thus comprehensively and dispassionately surveyed. Such improvements as had been necessitated were mere makeshifts, often made by stealth. The rude symmetry of the feudal system had been long ago destroyed by partial and unskillful adaptations to modern commercial life, effected at various dates and in accordance with various theories. The time had come for deliberate reconstruction, for inquiring whether the existence of many admitted evils was, as it was said to be, unavoidable; for proving that the needs of society may be classified and provided for by contrivances which shall not clash

with one another because all shall be parts of a consistent whole. This task Bentham undertook, and he brought to it a mind absolutely free from professional or class feeling, or any other species of prejudice. He mapped out the whole subject, dividing and subdividing it in accordance with the principle of "dichotomy." Having reached his ultimate subdivisions he subjects each to the most thorough and ingenious discussion. His earlier writings exhibit a lively and easy style, which gives place in his later treatises to sentences which are awkward from their effort after unattainable accuracy, and from the newly-invented technical nomenclature in which they are expressed. Many of Bentham's phrases, such as "international," "utilitarian," "codification," are valuable additions to our language; but the majority of them, especially those of Greek derivation, have taken no root in it. His neology is one among many instances of his contempt for the past and his wish to be clear of all association with it. His was, indeed, a typically logical, as opposed to a historical, mind. For the history of institutions which, thanks largely to the writings of Sir Henry Maine, has become a new and interesting branch of science, Bentham cared nothing. Had he possessed such a knowledge of Roman law as is now not uncommon in England, he must doubtless have taken a different view of many subjects. The logical and historical methods can, however, seldom be combined without confusion; and it is perhaps fortunate that Bentham devoted his long life to showing how much may be done by pursuing the former method exclusively. His writings have been and remain a storehouse of instruction for statesmen, an armoury for legal reformers. "Pillé par tout le monde," as Talleyrand said of him, "il est toujours riche." To trace the results of his teaching in England alone would be to write a history of the legislation of half a century. Upon the whole administrative machinery of government, upon criminal law and upon procedure, both criminal and civil, his influence has been most salutary; and the great legal revolution which in 1873 purported to accomplish the fusion of law and equity is not obscurely traceable to the same source. Those of Bentham's suggestions which have hitherto been carried out have affected the matter or contents of the law. The hopes which have been from time to time entertained, that his suggestions for the improvement of its form and expression were about to receive the attention which they deserved, have hitherto been disappointed. The services rendered by Bentham to the world would not, however, be exhausted even by the practical adoption of every one of his recommendations. There are no limits to the good results of his introduction of a true method of reasoning into the moral and political sciences.

Bentham's *Works*, together with an Introduction by J. Hill Burton, selections from his correspondence and a biography, were published by Dr Bowring, in eleven closely printed volumes (1838-1843). This edition does not include the *Deontology*, which, much rewritten, had been published by Bowring in 1834. Translations of the *Works* or of separate treatises have appeared in most European languages. Large masses of Bentham's MSS., mostly unpublished, are preserved at University College, London (see T. Whittaker's *Report*, 1892, on these MSS., as newly catalogued and reclassified by him in 155 parcels); also in the British Museum (see E. Nys, *Études de droit international et de droit pénal*, 1901, pp. 291-333). See further on his life and writings of Bentham, J. H. Burton, *Benthamiana* (1843); R. von Mohl, *Geschichte und Literatur der Staatswissenschaften*, bk. iii. (1858), pp. 595-635; R. K. Wilson, *History of Modern English Law* (1875), pp. 133-170; J. S. Mill, *Dissertations* (1859), vol. i, pp. 330-392; L. Stephen, *The English Utilitarians* (1900), vol. 1, *A Fragment on Government*, edited by F. C. Montagu (1891); *The Law Quarterly Review* (1895), two articles on Bentham's influence in Spain; A. V. Dicey, *Law and Opinion in England* (1905), pp. 125-209; C. M. Atkinson, *Jeremy Bentham* (1905). (T. E. H.)

BENTINCK, LORD WILLIAM (1774-1830), governor-general of India, was the second son of the 3rd duke of Portland and was born on the 14th of September 1774. He entered the army, rose to the rank of lieutenant-colonel and was present at Marengo. In 1803 he was nominated governor of Madras, where he quarrelled with the chief justice, Sir Henry Gwillim, and several members of his council. The sepoy mutiny at Vellore in 1807 led to his recall. His name was considered at this time for the post of governor-general, but Lord Minto was selected instead;

and it was not until twenty years later that he succeeded Lord Amherst in that office. His governor-generalship (1827-1835) was notable for many reforms, chief among which were the suppression of the Thugs (*q.v.*), the abolition of suttée, and the making of the English language the basis of education in India. It was on this last subject that Lord Macaulay's famous minute was written. Lord William's administration was essentially peaceful, but progressive and successful. He died at Paris on the 17th of June 1830.

See Demetrius C. Boulger, *Lord William Bentinck*, in the "Rulers of India" series (1892).

BENTINCK, LORD WILLIAM GEORGE FREDERICK

CAVENDISH, better known as LORD GEORGE BENTINCK (1802-1848), British politician, was the second surviving son of the fourth duke of Portland, by Henrietta, sister of Viscountess Canning, and was born on the 27th of February 1802. He was educated at home until he obtained his commission as cornet in the 10th hussars at the age of seventeen. He practically retired from the army in 1822 and acted for some time as private secretary to his uncle George Canning. In 1828 he succeeded his uncle Lord William Bentinck as member for Lynn-Regis, and continued to represent that constituency during the remaining twenty years of his life. His failures as a speaker in parliament seem to have discouraged him from the attempt to acquire reputation as a politician, and till within three years of his death he was little known out of the sporting world. As one of the leaders on "the turf," however, he was distinguished by that integrity, judgment and indomitable determination which, when brought to bear upon weightier matters, quickly gave him a position of first-rate importance in the political world. On his first entrance into parliament he belonged to the moderate Whig party, and voted in favour of Catholic emancipation, as also for the Reform Bill, though he opposed some of its principal details. Soon after, however, he joined the ranks of the opposition, with whom he sided up to the important era of 1846. When, in that year, Sir Robert Peel openly declared in favour of free trade, the advocates of the corn-laws, then without a leader, after several ineffectual attempts at organization, discovered that Lord George Bentinck was the only man of position and family (for Disraeli's time was not yet come) around whom the several sections of the opposition could be brought to rally. His sudden elevation took the public by surprise; but he soon gave convincing evidence of powers so formidable that the Protectionist party under his leadership was at once stiffened into real importance. Towards Peel, in particular, his hostility was uncompromising. Believing, as he himself expressed it, that that statesman and his colleagues had "hounded to the death his illustrious relative" Canning, he combined with his political opposition a degree of personal animosity that gave additional force to his invective. On entering on his new position, he at once abandoned his connexion with the turf, disposed of his magnificent stud and devoted his whole energies to the laborious duties of a parliamentary leader. Apart from the question of the corn-laws, however, his politics were decidedly independent. In opposition to the rest of his party, he supported the bill for removing the Jewish disabilities, and was favourable to the scheme for the payment of the Roman Catholic clergy in Ireland by the landowners. The result was that on December 23rd, 1847, he wrote a letter resigning the Protectionist leadership, though he still remained active in politics. But his positive abilities as a constructive statesman were not to be tested, for he died suddenly at Welbeck on the 21st of September 1848. It was to be left to Disraeli to bring the Conservative party into power, with Protection outside its programme.

See *Lord George Bentinck: a Political Biography* (1851), by B. Disraeli (Lord Beaconsfield).

BENTIVOGLIO, GIOVANNI (1443-1508), tyrant of Bologna, descended from a powerful family which exercised great influence in Bologna during the 15th century, was born after the murder of his father, then chief magistrate of the commune. In 1462 Giovanni contrived to make himself master of the city, although it was nominally a fief of the church under a papal legate. He ruled with a stern sway for nearly half a century, but the brilliance of his court, his encouragement of the fine arts and his

decoration of the city with sumptuous edifices, to some extent compensated the Bolognese for the loss of their liberty. Cesare Borgia (*q.v.*) contemplated the subjugation of Bologna in 1500, when he was crushing the various despots of Romagna, but Bentivoglio was saved for the moment by French intervention. In 1502 he took part in the conspiracy against Cesare, but, when the latter obtained French assistance, he abandoned his fellow-conspirators and helped Borgia to overcome them. During the brief pontificate of Pius III., who succeeded Alexander VI. in 1503, Bentivoglio enjoyed a respite, but the new pope, Julius II., was determined to reduce all the former papal states to obedience. Having won Louis XII. of France to his side, he led an army against Bologna, excommunicated Bentivoglio and forced him to abandon the city (November 1506). The deposed tyrant took refuge with the French, whom he trusted more than the pope, and died at Milan in 1508.

BIBLIOGRAPHY.—P. Litta, *Le Famiglie celebri Italiane*, vol. iii. (Milan, 1834); P. Villari, *Macchiavelli* (Eng. trans., London, 1892); M. Creighton, *History of the Papacy* (London, 1897); A. von Reumont, *Geschichte der Stadt Rom*, vol. iii. (Berlin, 1868). (L. V.)*

BENTIVOGLIO, GUIDO (1570–1644), Italian cardinal, statesman and historian, was born at Ferrara in 1570. After studying at Padua, he went to reside at Rome, and was received with great favour by Pope Clement VIII., who made him his private chamberlain. The next pope, Paul V., created him archbishop of Rhodes in 1607, and appointed him as nuncio to Flanders and afterwards to France; on his return to Rome in 1621 he was created cardinal and entrusted by Louis XIII. with the management of French affairs at the papal court. He became the intimate friend of Pope Urban VIII., who appointed him to the suburban see of Palestrina in 1691. An able writer and skilful diplomatist, Bentivoglio was marked out as Urban's successor, but he died suddenly on the 7th of September 1644 at the opening of the conclave. Bentivoglio's principal works are:—*Della Guerra di Fiandria* (best edition, Cologne, 1633–1639), translated into English by Henry, earl of Monmouth (London, 1654); *Relazioni di G. Bentivoglio in tempo delle sue Nunziature di Fiandria e di Francia* (Cologne, 1630); *Lettere diplomatiche di Guido Bentivoglio* (Brussels, 1631, frequently reprinted, best edition by L. Scarabelli, 2 vols., Turin, 1852). The complete edition of his works was published at Venice in 1668 in 4to. A selection of his letters has been adopted as a classic in the Italian schools.

BENTLEY, RICHARD (1662–1742), English scholar and critic, was born at Oulton near Wakefield, Yorkshire, on the 27th of January 1662. His grandfather had suffered in person and estate in the royalist cause, and the family were in consequence reduced circumstances. Bentley's mother, the daughter of a stonemason in Oulton, was a woman of excellent understanding and some education, as she was able to give her son his first lessons in Latin. From the grammar school of Wakefield Richard Bentley passed to St John's College, Cambridge, being admitted subsizar in 1676. He afterwards obtained a scholarship and took the degree of B.A. in 1680 (M.A. 1683). He never succeeded to a fellowship, being appointed by his college, before he was twenty-one, headmaster of Spalding grammar school. In this post he did not remain long, being selected by Dr Edward Stillingfleet, dean of St Paul's, to be domestic tutor to his son. This appointment introduced Bentley at once to the society of the most eminent men of the day, threw open to him the best private library in England, and brought him into familiar intercourse with Dean Stillingfleet, a man of sound understanding, who had not shrunk from exploring some of the more solid and abstruse parts of ancient learning. The six years which he passed in Stillingfleet's family were employed, with the restless energy characteristic of the man, in exhausting the remains of the Greek and Latin writers, and laying up those stores of knowledge upon which he afterwards drew as circumstances required.

In 1680 Stillingfleet became bishop of Worcester, and Bentley's pupil went to reside at Oxford in Wadham College, accompanied by his tutor. Bentley's introductions and his own merits

placed him at once on a footing of intimacy with the most distinguished scholars in the university, Dr John Mill, Humphrey Hody, Edward Bernard. Here he revelled in the MS. treasures of the Bodleian, Corpus and other college libraries. He projected and occupied himself with collections for vast literary schemes. Among these are specially mentioned a *corpus* of the fragments of the Greek poets and an edition of the Greek lexicographers. But his first publication was in connexion with a writer of much inferior note. The Oxford (Sheldonian) press was about to bring out an edition (the *editio princeps*) from the unique MS. in the Bodleian of the Greek *Chronicle* (a universal history down to A.D. 500) of John of Antioch (date uncertain, between 600 and 1000), called John Malalas or "John the Rhetor"; and the editor, Dr John Mill, principal of St Edmund Hall, had requested Bentley to look through the sheets and make any remarks on the text. This originated Bentley's *Epistola ad Millium*, which occupies less than one hundred pages at the end of the Oxford *Malalas* (1691). This short tractate at once placed Bentley at the head of all living English scholars. The ease with which, by a stroke of the pen, he restores passages which had been left in hopeless corruption by the editors of the *Chronicle*, the certainty of the emendation and the command over the relevant material, are in a style totally different from the careful and laborious learning of Hody, Mill or E. Childmead. To the small circle of classical students (lacking the great critical dictionaries of modern times) it was at once apparent that there had arisen in England a critic whose attainments were not to be measured by the ordinary academical standard, but whom these few pages had sufficed to place by the side of the great Grecians of a former age. Unfortunately this mastery over critical science was accompanied by a tone of self-assertion and presumptuous confidence which not only checked admiration, but was calculated to rouse enmity. Dr Monk, indeed, Bentley's biographer, charged him (in his first edition, 1830) with an indecorum of which he was not guilty. "In one place," writes Dr Monk, "he accosts Dr Mill as ω $\tau\omega\alpha\nu\theta\iota\omega$ (Johnny), an indecorum which neither the familiarity of friendship, nor the licence of a dead language, can justify towards the dignified head of a house." But the object of Bentley's apostrophe was not his correspondent Dr Mill, but his author John Malalas, whom in another place he playfully appeals to as "Syrrice." From this publication, however, dates the origin of those mixed feelings of admiration and repugnance which Bentley throughout his career continued to excite among his contemporaries.

In 1690 Bentley had taken deacon's orders in the Church. In 1692 he was nominated first Boyle lecturer, a nomination which was repeated in 1694. He was offered the appointment a third time in 1695 but declined it, being by that time involved in too many other undertakings. In the first series of lectures ("A Confutation of Atheism") he endeavours to present the Newtonian physics in a popular form, and to frame them (especially in opposition to Hobbes) into a proof of the existence of an intelligent Creator. He had some correspondence with Newton, then living in Trinity College, on the subject. The second series, preached in 1694, has not been published and is believed to be lost. Andrew Kippis, the editor of the *Biographia Britannica*, mentions MS. copies of them as in existence. Scarcely was Bentley in priest's orders before he was preferred to a prebendal stall in Worcester cathedral. In 1693 the keepership of the royal library becoming vacant, great efforts were made by his friends to obtain the place for Bentley, but through court interest the post was given to Mr Thynne. An arrangement, however, was made, by which the new librarian resigned in favour of Bentley, on condition that he received an annuity of £130 for life out of the salary, which only amounted to £200. To these preferments were added in 1695 a royal chaplaincy and the living of Hartlebury. In the same year Bentley was elected a fellow of the Royal Society, and in 1696 proceeded to the degree of D.D. The recognition of continental scholars came in the shape of a dedication, by Graevius, prefixed to a dissertation of Albert Rubens, *De Vita Flavii Mallii Theodori*, published at Utrecht in 1694.

While these distinctions were being accumulated upon Bentley, his energy was making itself felt in many and various directions. He had official apartments in St James's Palace, and his first care was the royal library. He made great efforts to retrieve this collection from the dilapidated condition into which it had been allowed to fall. He employed the mediation of the earl of Marlborough to beg the grant of some additional rooms in the palace for the books. The rooms were granted, but Marlborough characteristically kept them for himself. Bentley enforced the law against the publishers, and thus added to the library nearly 1000 volumes which they had neglected to deliver. He was commissioned by the university of Cambridge to obtain Greek and Latin founts for their classical books, and accordingly he had cast in Holland those beautiful types which appear in the Cambridge books of that date. He assisted Evelyn in his *Numismata*. All Bentley's literary appearances at this time were of this accidental character. We do not find him settling down to the steady execution of any of the great projects with which he had started. He designed, indeed, in 1694 an edition of Philostratus, but readily abandoned it to G. Olearius, (Öhlschlager), "to the joy," says F. A. Wolf, "of Olearius and of no one else." He supplied Grævius with collations of Cicero, and Joshua Barnes with a warning as to the spuriousness of the *Epistles of Euripides*, which was thrown away upon that blunderer, who printed the epistles and declared that no one could doubt their genuineness but a man *perfrictæ frontis aut iudicii imminuti*. Bentley supplied to Grævius's *Callimachus* a masterly collection of the fragments with notes, published at Utrecht in 1697.

The *Dissertation on the Epistles of Phalaris*, the work on which Bentley's fame in great part rests, originated in the same casual way. William Wotton, being about to bring out in 1697 a second edition of his book on *Ancient and Modern Learning*, claimed of Bentley the fulfilment of an old promise to write a paper exposing the spuriousness of the *Epistles of Phalaris*. This paper was resented as an insult by the Christ Church editor of Phalaris, Charles Boyle, afterwards earl of Orrery, who in getting the MS. in the royal library collated for his edition (1695) had had a little quarrel with Bentley. Assisted by his college friends, particularly Atterbury, Boyle wrote a reply, "a tissue," says Dr Alexander Dyce (in his edition of Bentley's Works, 1836-1838), "of superficial learning, ingenious sophistry, dexterous malice and happy railery." The reply was hailed by the public as crushing and went immediately into a second edition. It was incumbent on Bentley to rejoin. This he did (1699) in what Porson styles "that immortal dissertation," to which no answer was or could be given, although the truth of its conclusions was not immediately recognized. (See PHALARIS.)

In the year 1700 Bentley received that main preferment which, says De Quincey, "was at once his reward and his scourge for the rest of his life." The six commissioners of ecclesiastical patronage unanimously recommended Bentley to the crown for the mastership of Trinity College, Cambridge. This college, the most splendid foundation in the university of Cambridge, and in the scientific and literary reputation of its fellows the most eminent society in either university, had in 1700 greatly fallen from its high estate. It was not that it was more degraded than the other colleges, but its former lustre made the abuse of endowments in its case more conspicuous. The eclipse had taken place during the reaction which followed 1660, and was owing to causes which were not peculiar to Trinity, but which influenced the nation at large. The names of John Pearson and Isaac Barrow, and, greater than either, that of Newton, adorn the college annals of this period. But these were quite exceptional men. They had not inspired the rank and file of fellows of Trinity with any of their own love for learning or science. Indolent and easy-going clerics, without duties, without a pursuit or any consciousness of the obligation of endowments, they haunted the college for the pleasant life and the good things they found there, creating sinecure offices in each other's favour, jobbing the scholarships and making the audits mutually pleasant. Any excuse served for a banquet at the cost of "the house," and the celibacy imposed by the statutes was made as tolerable as the decorum

of a respectable position permitted. To such a society Bentley came, obnoxious as a St John's man and an intruder, unwelcome as a man of learning whose interests lay outside the walls of the college. Bentley replied to their concealed dislike with open contempt, and proceeded to ride roughshod over their little arrangements. He inaugurated many beneficial reforms in college usages and discipline, executed extensive improvements in the buildings, and generally used his eminent station for the promotion of the interests of learning both in the college and in the university. But this energy was accompanied by a domineering temper, an overweening contempt for the feelings and even for the rights of others, and an unscrupulous use of means when a good end could be obtained. Bentley, at the summit of classical learning, disdained to associate with men whom he regarded as illiterate priests. He treated them with contumely, while he was diverting their income to public purposes. The continued drain upon their purses—on one occasion the whole dividend of the year was absorbed by the rebuilding of the chapel—was the grievance which at last roused the fellows to make a resolute stand. After ten years of stubborn but ineffectual resistance within the college, they had recourse in 1710 to the last remedy—an appeal to the visitor, the bishop of Ely (Dr Moore). Their petition is an ill-drawn invective, full of general complaints and not alleging any special delinquency. Bentley's reply (*The Present State of Trinity College, &c.*, 1710) is in his most crushing style. The fellows amended their petition and put in a fresh charge, in which they articulated fifty-four separate breaches of the statutes as having been committed by the master. Bentley, called upon to answer, demurred to the bishop of Ely's jurisdiction, alleging that the crown was visitor. He backed his application by a dedication of his *Horace* to the lord treasurer (Harley). The crown lawyers decided the point against him; the case was heard (1714) and a sentence of ejection from the mastership ordered to be drawn up, but before it was executed the bishop of Ely died and the process lapsed. The feud, however, still went on in various forms. In 1718 Bentley was deprived by the university of his degrees, as a punishment for failing to appear in the vice-chancellor's court in a civil suit; and it was not till 1724 that the law compelled the university to restore them. In 1733 he was again brought to trial before the bishop of Ely (Dr Grenc) by the fellows of Trinity and was sentenced to deprivation, but the college statutes required the sentence to be exercised by the vice-master (Dr Walker), who was Bentley's friend and refused to act. In vain were attempts made to compel the execution of the sentence, and though the feud was kept up till 1738 or 1740 (about thirty years in all) Bentley remained undisturbed.

During the period of his mastership, with the exception of the first two years, Bentley pursued his studies uninterruptedly, although the results in the shape of published works seem incommensurable. In 1709 he contributed a critical appendix to John Davies's edition of Cicero's *Tusculan Disputations*. In the following year he published his emendations on the *Plutus* and *Nubes* of Aristophanes, and on the fragments of Menander and Philonem. The last came out under the name of "Phileutherus Lipsiensis," which he made use of two years later in his *Remarks on a late Discourse of Freethinking*, a reply to Anthony Collins the deist. For this he received the thanks of the university, in recognition of the service thereby rendered to the church and clergy. His *Horace*, long contemplated and in the end written in very great haste and brought out to propitiate public opinion at a critical period of the Trinity quarrel, appeared in 1711. In the preface he declared his intention of confining his attention to criticism and correction of the text, and ignoring exegesis. Some of his 700 or 800 emendations have been accepted, but the majority of them are now rejected as unnecessary and prosaic, although the learning and ingenuity shown in their support are remarkable. In 1716, in a letter to Dr Wake, archbishop of Canterbury, he announced his design of preparing a critical edition of the New Testament. During the next four years, assisted by J. J. Wetstein, an eminent biblical critic, who claimed to have been the first to suggest the idea to Bentley, he collected materials for the work, and in 1720 published

Proposals for a New Edition of the Greek Testament, with specimens of the manner in which he intended to carry it out. He proposed, by comparing the text of the Vulgate with that of the oldest Greek MSS., to restore the Greek text as received by the church at the time of the council of Nice. A large number of subscribers to the work was obtained, but it was never completed. His *Terence* (1726) is more important than his *Horace*, and it is upon this, next to the *Phalaris*, that his reputation mainly rests. Its chief value consists in the novel treatment of the metrical questions and their bearing on the emendation of the text. To the same year belong the *Fables of Phaedrus* and the *Sententiae of Publius Syrus*. The *Paradise Lost* (1732), undertaken at the suggestion of Queen Caroline, is generally regarded as the most unsatisfactory of all his writings. It is marred by the same rashness in emendation and lack of poetical feeling as his *Horace*; but there is less excuse for him in this case, since the English text could not offer the same field for conjecture. He put forward the idea that Milton employed both an amanuensis and an editor, who were to be held responsible for the clerical errors, alterations and interpolations which Bentley professed to detect. It is uncertain whether this was a device on the part of Bentley to excuse his own numerous corrections, or whether he really believed in the existence of this editor. Of the contemplated edition of Homer nothing was published; all that remains of it consists of some manuscript and marginal notes in the possession of Trinity College. Their chief importance lies in the attempt to restore the metre by the insertion of the lost digamma. Among his minor works may be mentioned: the *Astronomica of Manilius* (1739), for which he had been collecting materials since 1691; a letter on the Sigeian inscription on a marble slab found in the Troad, now in the British Museum; notes on the *Theriacae* of Nicander and on Lucan, published after his death by Cumberland; emendations of Plautus (in his copies of the editions by Pareus, Camerarius and Gronovius, edited by Schröder, 1880, and Sonnenschein, 1883). *Bentley Critica Sacra* (1862), edited by A. A. Ellis, contains the epistle to the Galatians (and excerpts), printed from an interleaved folio copy of the Greek and Latin Vulgate in Trinity College. A collection of his *Opuscula Philologica* was published at Leipzig in 1781. The edition of his works by Dyce (1836-1838) is incomplete.

He had married in 1701 Joanna, daughter of Sir John Bernard of Brampton in Huntingdonshire. Their union lasted forty years. Mrs Bentley died in 1740, leaving a son, Richard, and two daughters, one of whom married in 1728 Mr Denison Cumberland, grandson of Richard Cumberland, bishop of Peterborough. Their son was Richard Cumberland, the dramatist. Surrounded by his grandchildren, Dr Bentley experienced the joint pressure of age and infirmity as lightly as is consistent with the lot of humanity. He continued to amuse himself with reading; and though nearly confined to his arm-chair, was able to enjoy the society of his friends and several rising scholars, J. Markland, John Taylor, his nephews Richard and Thomas Bentley, with whom he discussed classical subjects. He was accustomed to say that he should live to be eighty, adding that a life of that duration was long enough to read everything worth reading. He fulfilled his own prediction, dying of pleurisy on the 14th of July 1742. Though accused by his enemies of being grasping, he left not more than £500 behind him. A few Greek MSS., brought from Mount Athos, he left to the college library; his books and papers to his nephew, Richard Bentley. Richard, who was a fellow of Trinity, at his death in 1786 left the papers to the college library. The books, containing in many cases valuable manuscript notes, were purchased by the British Museum.

Of his personal habits some anecdotes are related by his grandson, Richard Cumberland, in vol. i. of his *Memoirs* (1807). The hat of formidable dimensions, which he always wore during reading to shade his eyes, and his preference of port to claret (which he said "would be port if it could") are traits embodied in Pope's caricature (*Dunciad*, b. 4), which bears in other respects little resemblance to the original. He did not take up the habit

of smoking till he was seventy. He held the archdeaconry of Ely with two livings, but never obtained higher preference in the church. He was offered the (then poor) bishopric of Bristol but refused it, and being asked what preference he would consider worth his acceptance, replied, "That which would leave him no reason to wish for a removal."

Bentley was the first, perhaps the only, Englishman who can be ranked with the great heroes of classical learning, although perhaps not a great classical scholar. Before him there were only John Selden, and, in a more restricted field, Thomas Gataker and Pearson. But Selden, a man of stupendous learning, wanted the freshness of original genius and confident mastery over the whole region of his knowledge. "Bentley inaugurated a new era of the art of criticism. He opened a new path. With him criticism attained its majority. Where scholars had hitherto offered suggestions and conjectures, Bentley, with unlimited control over the whole material of learning, gave decisions" (Mähly). The modern German school of philology does not grudgingly homage to his genius. Bentley, says Bunsen, "was the founder of historical philology." And Jakob Bernays says of his corrections of the *Tristia*, "corruptions which had hitherto defied every attempt even of the mightiest, were removed by a touch of the fingers of this British Samson." The English school of Hellenists, by which the 18th century was distinguished, and which contains the names of R. Dawes, J. Markland, J. Taylor, J. Toup, T. Tyrwhitt, Richard Porson, P. P. Dobree, Thomas Kidd and J. H. Monk, was the creation of Bentley. And even the Dutch school of the same period, though the outcome of a native tradition, was in no small degree stimulated and directed by the example of Bentley, whose letters to the young Hemsterhuis on his edition of Julius Pollux produced so powerful an effect on him, that he became one of Bentley's most devoted admirers.

Bentley was a source of inspiration to a following generation of scholars. Himself, he sprang from the earth without fore-runners, without antecedents. Self-taught, he created his own science. It was his misfortune that there was no contemporary guild of learning in England by which his power could be measured, and his eccentricities checked. In the *Phalaris* controversy his academical adversaries had not sufficient knowledge to know how absolute their defeat was. Garth's couplet—

"So diamonds take a lustre from their foil,
And to a Bentley 'tis we owe a Boyle"—

expressed the belief of the wits or literary world of the time. The attacks upon him by Pope, John Arbuthnot and others are evidence of their inability to appreciate his work. To them, textual criticism seemed mere pedantry and useless labour. It was not only that he had to live with inferiors, and to waste his energy in a struggle forced upon him by the necessities of his official position, but the wholesome stimulus of competition and the encouragement of a sympathetic circle were wanting. In a university where the instruction of youth or the religious controversy of the day were the only known occupations, Bentley was an isolated phenomenon, and we can hardly wonder that he should have flagged in his literary exertions after his appointment to the mastership of Trinity. All his vast acquisitions and all his original views seem to have been obtained before 1700. After this period he acquired little and made only spasmodic efforts—the *Horace*, the *Terence* and the *Milton*. The prolonged mental concentration and mature meditation, which alone can produce a great work, were wanting to him.

F. A. Wolf, *Literarische Analekten*, i. (1816); Monk, *Life of Bentley* (1830); J. Mähly, *Richard Bentley, eine Biographie* (1868); R. C. Jebb, *Bentley* ("English Men of Letters" series, 1882), where a list of authorities bearing on Bentley's life and work is given. For his letters see *Bentley et doctorum virorum ad eum Epistolae* (1807); *The Correspondence of Richard Bentley*, edited by C. Wordsworth (1842). See also J. E. Sandys, *History of Classical Scholarship*, ii. 401-410 (1908); and *The Bibliography of Bentley*, by A. T. Bartholomew and J. W. Clark (Cambridge, 1908).

BENTLEY, RICHARD (1704-1871), British publisher, was born in London in 1704. His father owned the *General Evening Post* in conjunction with John Nichols, to whom Richard Bentley, on leaving St Paul's school, was apprenticed to learn the printing

trade. With his brother SAMUEL (1785-1868), an antiquarian of some repute, he set up a printing establishment, but in 1820 he began business as a publisher in partnership with Henry Colburn in New Burlington Street. Colburn retired in 1832 and Bentley continued business on his own account. In 1837 he began Bentley's *Miscellany*, edited for the first three years of its existence by Charles Dickens, whose *Oliver Twist*, with Cruikshank's illustrations, appeared in its pages. Bentley and his son GEORGE (1828-1895), as Richard Bentley & Son, published works by R. H. Barham, Theodore Hook, Isaac D'Israeli, Judge Haliburton and others; also the "Library of Standard Novels" and the "Favourite Novel Library." In the latter series Mrs Henry Wood's *East Lynne* appeared. In 1866 the firm took over the publication of *Temple Bar*, with which Bentley's *Miscellany* was afterwards incorporated. Richard Bentley died on the 10th of September 1871. His son, George Bentley, and his grandson, Richard Bentley, junior, continued the business until it was absorbed (1898) by Macmillan & Co.

See also *R. Bentley & Son* (Edinburgh, 1886), a history of the firm reprinted from *Le Livre* (October, 1885).

BENTON, THOMAS HART (1782-1858), American statesman, was born at Hillsborough, Orange county, North Carolina, on the 14th of March 1782. His father, an Englishman of refinement and scholarship, died in 1790, leaving the boy under the influence of a very superior mother, from whom he received lessons in book learning, piety and temperance quite unusual in the frontier country. His home studies, facilitated by his father's fine library, were supplemented by a brief stay at the university of North Carolina (Chapel Hill) in 1799. The family removed, probably in this year, to a large tract of land which had been acquired by the father on the outskirts of the Indian country (at Benton Town, now Leipers Fork) near Franklin, Tennessee. The following years, during which Benton was at various times school teacher, farmer, lawyer and politician, were the distinctively formative period of his life. His intense democracy and many features of his boldy cast personality were perfectly representative of the border people among whom he lived; although his education, social standing and force of character placed him above his fellows. In 1809 he served a term as state senator. Between 1815 and 1817 he transferred his interests to St Louis, Missouri, and in 1820 was elected United States senator from the new state. His senatorial career of thirty years (1821-1851) was one of extreme prominence. A friendship early formed in Tennessee for Andrew Jackson was broken in 1813 by an armed fracas between the principals and their friends, but after the presidential election of 1824 Benton became a Jacksonian Democrat and Jackson's close friend, and as such was long the Democratic leader in the Senate, his power being greatest during Jackson's second term. He continued to be the administration's right-hand man under Van Buren, but gradually lost influence under Polk, with whom he finally broke both personally and politically.

The events of Benton's political life are associated primarily with three things: the second United States Bank, westward expansion and slavery. In the long struggles over the bank, the deposits and the "expunging resolution" (i.e. the resolution to expunge from the records of the Senate the vote of censure of President Jackson for his removal of the government deposits from the bank), Benton led the Jackson Democrats. His opposition to a national bank and insistence on the peculiar virtues of "hard money," whence his sobriquet of "Old Bullion," went back to his Tennessee days. In all that concerned the expansion of the country and the fortunes of the West no public man was more consistent or more influential than Benton, and none so clear of vision. Reared on the border, and representing a state long the farthestmost outpost across the Mississippi in the Indian country, he held the ultra-American views of his section as regarded foreign relations generally, and the "manifest destiny" of expansion westward especially. It was quite natural that he should advocate the removal westward of the Indian tribes, should urge the encouragement of trade with Sante Fé (New Mexico), and should oppose the abandonment in the Spanish

treaty of 1819 of American claims to Texas. He once thought the Rocky Mountains the proper western limit of the United States (1824), but this view he soon outgrew. He was the originator of the policy of homestead laws by which the public lands were used to promote the settlement of the west by homeseekers. No other man was so early and so long active for transcontinental railways. But Benton was not a land-grabber, whether in the interest of slavery or of mere jingoism. In the case of Oregon, for instance, he was firmly against joint occupation with Great Britain, but he was always for the boundary of 49° and never joined in the campaign-jingo cry of "Fifty-four Forty or Fight." It was he who chiefly aided Polk in withdrawing from that untenable position. He despised pretexts and intrigues. Both in the case of Oregon and in that of Texas, though one of the earliest and most insistent of those who favoured their acquisition, yet in the face of southern and western sentiment he denounced the sordid and devious intrigues and politics connected with their acquisition, and kept clear of these. For the same reason he opposed the Mexican War, though not its prosecution once begun. In the Texas question slavery was prominent. Toward slavery Benton held a peculiarly creditable attitude. A southerner, he was a slaveholder; but he seems to have gradually learned that slavery was a curse to the South, for in 1844 he declared that he would not introduce it into Texas lands "where it was never known," and in 1849 proclaimed that his personal sentiments were "against the institution of slavery." In the long struggle over slavery in the territories, following 1845, he was for the extreme demands of neither section; not because he was timorous or a compromiser,—no man was less of either,—but because he stood unwaveringly for justice to both sections, never adopting exaggerated views that must or even could be compromised. The truth is that he was always a westerner before he was a southerner and a union man before all things else; he was no whit less national than Webster. Hence his distrust and finally hatred of Calhoun, dating from the nullification episode of 1832-1833. As the South under Calhoun's lead became increasingly sectional and aggressive, Benton increasingly lost sympathy with her. Though he despised political inaction Abolitionists, and hated their propaganda as inimical to the Union, he would not therefore close the national mails to Abolition literature, nor abridge the right of petition. No statesman was more prescient of the disunion tendencies of Calhoun's policies, and as early as 1844 he prophetically denounced the treason to the Union toward which the South was drifting. He would not drift with her for the sake of slavery, and this was his political undoing. In 1851 Missouri rejected him in his sixth candidacy for the Senate, after he had been an autocrat in her politics for thirty years. In 1852 he was elected to the House of Representatives, but his opposition to the repeal of the Missouri Compromise caused his defeat in 1854. An unsuccessful campaign for the governorship of Missouri in 1856 ended his political career. He died at Washington on the 10th of April 1858.

Benton's entire career was eminently creditable, and he is, besides, one of the most picturesque figures in American political history. His political principles—whether as regarded lobbying, congressional jobbing, civil service or great issues of legislation and foreign affairs—were of the highest. He was so independent that he had great dislike for caucuses, and despised party platforms—although he never voted any but the Democratic ticket, even when his son-in-law, J. C. Frémont, was the Republican presidential candidate in 1856; nor would he accept instructions from the Missouri legislature. His career shows no truckling to self-interest, and on large issues he outgrew partisanship. Although palpably inferior to each of his great senatorial colleagues, Webster, Clay and Calhoun, in some gifts, yet if character, qualities and career be taken in the whole he was possibly the most creditable of all. Benton was austere, aggressive and vain; besides, he had a fatal deficiency of humour. Nevertheless he had great influence, which was a deserved tribute to his ability and high character. An indefatigable student, he treated all subjects capably, and especially in questions of his country's

history and the exploration of the West had few equals—in the latter none. He acted always with uncalculating boldness, and defended his acts with extraordinary courage and persistence. Benton wrote a *Thirty Years' View . . . of the American Government* (2 vols., 1854-1856), characteristic of the author's personality; it is of great value for the history of his time. He also compiled an *Abridgment of the Debates of Congress, 1789-1850* (16 vols., 1857-1861), likewise of great usefulness; and published a bitter review of the Dred Scott decision full of extremely valuable historical details—*Historical and Legal Examination of . . . the Dred Scott Case* (1857). All were written in the last eight years of his life and mostly in the last three.

The best biography is that by W. M. Meigs, *Life of Thomas Hart Benton* (Philadelphia and London, 1904). See also Theodore Roosevelt's *Thomas Hart Benton* (Boston, 1887), in the "American Statesmen" series, which admirably brings out Benton's significance as a western man; and Joseph M. Rogers's *Thomas Hart Benton* (Philadelphia, 1905) in the "American Crisis" series.

BENTON HARBOR, a city of Berrien county, Michigan, U.S.A., on the Saint Joseph river, about 1 m. from Lake Michigan (with which it is connected by a ship canal), near the S.W. corner of the state, and 1 m. N.E. of St. Joseph. Pop. (1890) 3692; (1900) 6562, of whom 795 were foreign-born; (1904) 6702; (1910) 9185. It is served by the Père Marquette, the Michigan Central, and the Cleveland, Cincinnati, Chicago & St. Louis railways, by electric railways to St. Joseph and Niles, Mich., and South Bend, Indiana, and for a part of the year by steamboat lines to Chicago and Milwaukee. One mile south-east of the city are a sanitarium and the Eastman mineral springs; within the city also there are springs and bath-houses. Near the city is a communistic religious community, the Israelite House of David, founded in 1903; the members believe that they are a part of the 144,000 elect (Revelation, vii, xiv) ultimately to be redeemed. Benton Harbor has a large trade in fruit (peaches, grapes, pears, cherries, strawberries, raspberries and apples) and other market garden produce raised in the vicinity. The city's manufactures include fruit baskets, preserved fruits, cider, vinegar, pickles, furniture, lumber and stationers' supplies, particularly material for the "loose-leaf ledger" system of accounting. Benton Harbor, which was known as Bronson Harbor until 1865, was incorporated as a village in 1869, was chartered as a city in 1891, and in 1903 received a new charter.

BENUE, a river of West Africa, the largest and most important affluent of the Niger (*q.v.*), which it joins after a course of over 800 m. in a general east to west direction from its source in the mountains of Adamawa. Through the Tuburi marshes there is a water connexion between the Benue (Niger) and Shari (Lake Chad) systems.

BEN VENUE, a mountain in south-west Perthshire, Scotland, 10 m. W. of Callander. Its principal peaks are 2303 and 2386 ft. high, and, owing to its position near the south-eastern shore of Loch Katrine, its imposing contour is one of the most familiar features in the scenery of the Trossachs, the mountain itself figuring prominently in *The Lady of the Lake*. On its northern base, close to the lake, Sir Walter Scott placed the Coir-nan-Uriskin, or "Goblin's Cave." Immediately to the south of the cave is the dell called Beal(ach)-nam-Bo, or "Cattle Pass," through which were driven to the refuge of the Trossachs the herds lifted by the Highland marauders in their excursions to the lands south of Loch Lomond. The pass, though comparatively unvisited, offers the grandest scenery in the district.

BENZALDEHYDE (oil of bitter almonds), C_6H_5CHO , the simplest representative of the aromatic aldehydes. It was first isolated in 1803 and was the subject of an important investigation by J. v. Liebig in 1837 (*Annalen*, 1837, 22, p. 1). It occurs naturally in the form of the glucoside amygdalin ($C_{20}H_{27}NO_{11}$), which is present in bitter almonds, cherries, peaches and the leaves of the cherry laurel; and is obtained from this substance by hydrolysis with dilute acids:

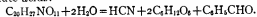

It occurs free in bitter almonds, being formed by an enzyme decomposition of amygdalin (*q.v.*). It may also be prepared by oxidizing benzyl alcohol with concentrated nitric acid; by

distilling a mixture of calcium benzoate and calcium formate; by the condensation of chlor-oxalic ester with benzene in the presence of aluminium chloride, the ester of the ketonic acid formed being then hydrolysed and the resulting acid distilled:

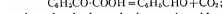
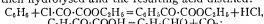

by the action of anhydrous hydrocyanic acid and hydrochloric acid on benzene, an aldimine being formed as an intermediate product:

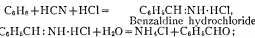

and by the action of chromium oxychloride on toluene dissolved in carbon bisulphide (A. Etard, *Berichte*, 1884, 17, pp. 1462, 1700).

Technically it is prepared from toluene, by converting it into benzyl chloride, which is then heated with lead nitrate:

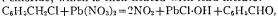

or, by conversion into benzal chloride, which is heated with milk of lime under pressure:

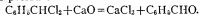

E. Jacobsen has also obtained benzaldehyde by heating benzal chloride with glacial acetic acid:

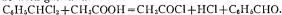

Benzaldehyde is a colourless liquid smelling of bitter almonds. Its specific gravity is 1.0636 ($16^\circ C.$), and it boils at $179.1^\circ C.$ (751 mm). It is only slightly soluble in water, but is readily volatile in steam. It possesses all the characteristic properties of an aldehyde; being readily oxidized to benzoic acid; reducing solutions of silver salts; forming addition products with hydrogen, hydrocyanic acid and sodium bisulphite; and giving an oxime and a hydrazone. On the other hand, it differs from the aliphatic aldehydes in many respects; it does not form an addition product with ammonia but condenses to hydrobenzamide ($C_6H_5CH_2N_2$); on shaking with alcoholic potash it undergoes simultaneous oxidation and reduction, giving benzoic acid and benzyl alcohol (S. Cannizzaro); and on warming with alcoholic potassium cyanide it condenses to benzoin (*q.v.*).

The oxidation of benzaldehyde to benzoic acid when exposed to air is not one of ordinary oxidation, for it has been observed in the case of many compounds that during such oxidation, as much oxygen is rendered "active" as is used up by the substance undergoing oxidation; thus if benzaldehyde is left for some time in contact with air, water and indigoliphonic acid, just as much oxygen is used up in oxidizing the indigo compound as in oxidizing the aldehyde. A. v. Baeyer and V. Villiger (*Berichte*, 1900, 33, pp. 858, 2480) have shown that benzoyl hydrogen peroxide $C_6H_5CO-O-OH$ is formed as an intermediate product and that this oxidizes the indigo compound, being itself reduced to benzoic acid; they have also shown that this peroxide is soluble in benzaldehyde with production of benzoic acid, and it must be assumed that the oxidation of benzaldehyde proceeds as shown in the equations:

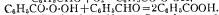

Further see G. Bodländer, *Ahrens Sammlung*, 1899, iii. 470; W. P. Jorissen, *Zeit. für phys. Chem.*, 1897, 22, p. 56; C. Engler and W. Wild, *Berichte*, 1897, 30, p. 1669.

The oxime of benzaldehyde ($C_6H_5CH:N \cdot OH$), formed by the addition of hydroxylamine to the aldehyde, exhibits a characteristic behaviour when hydrochloric acid gas is passed into its ethereal solution, a second modification being produced. The former (known as the α or benz-anti-aldoxime) melts at $34-35^\circ C.$; the latter (β or benz-syn-aldoxime) melts at $130^\circ C.$ and is slowly transformed into the α form. The difference between the two forms has been explained by A. Hantzsch and A. Werner (*Berichte*, 1890, 23, p. 11) by the assumption of the different spatial arrangement of the atoms (see STEREO-ISOMERISM). On account of the readiness with which it condenses with various compounds, benzaldehyde is an important synthetic reagent. With aniline it forms benzylidene aniline $C_6H_5CH=N \cdot C_6H_5$, and with acetone, benzal acetone $C_6H_5CH=C(CH_3)_2$. Heated with anhydrous sodium acetate and acetic anhydride it gives cinnamic acid (*q.v.*); with ethyl bromide and sodium it forms triphenyl-carbinol

(C_6H_5)₂C-OH; with dimethylaniline and anhydrous zinc chloride it forms leuco-malachite green $C_{12}H_{11}CH(C_6H_5)_2N(CH_3)_2$; and with dimethylaniline and concentrated hydrochloric acid it gives dimethylaminobenzhydrol, $C_6H_5CH(OH)C_6H_5N(CH_3)_2$. Heated with sulphur it forms benzoic acid and stilbene:

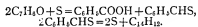

Its addition compound with hydrocyanic acid gives mandelic acid $C_6H_5CH(OH)COOH$ on hydrolysis; when heated with sodium succinate and acetic anhydride, phenyl-iso-crotonic acid $C_6H_5CH : CH - CH_2COOH$ is produced, which on boiling is converted into α -naphthol $C_{10}H_7OH$. It can also be used for the synthesis of pyridine derivatives, since A. Hantzsch has shown that aldehydes condense with aceto-acetic ester and ammonia to produce the homologues of pyridine, thus:

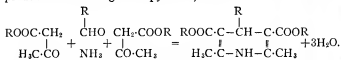

On nitration it yields chiefly meta-nitro-benzaldehyde, crystallizing in needles which melt at 58° C. The ortho-compound may be obtained by oxidizing ortho-nitrocinnamic acid with alkaline potassium permanganate in the presence of benzene; or from ortho-nitrobenzyl chloride by condensing it with aniline, oxidizing the product so obtained to ortho-nitrobenzylidene aniline, and then hydrolysing this compound with an acid (*Farben fabrik d. Meister, Lucius und Brünig*). It crystallizes in yellowish needles, which are volatile in steam and melt at 46° C. It is used in the artificial production of indigo (see *German Patent 19768*).

Para-nitrobenzaldehyde crystallizes in prisms melting at 107° C. and is prepared by the action of chromium oxychloride on para-nitrotoluene, or by oxidizing para-nitrocinnamic acid. By the reduction of ortho-nitrobenzaldehyde with ferrous sulphate and ammonia, ortho-aminobenzaldehyde is obtained. This compound condenses in alkaline solution with compounds containing the grouping— CH_2-CO- to form quinoline (*q.v.*) or its derivatives; thus, with acetaldehyde it forms quinoline, and with acetone, α -methyl quinoline. With urea it gives

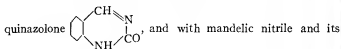

homologues it forms oxazole derivatives (S. S. Minovici, *Berichte*, 1896, 20, p. 2097).

BENZENE, C_6H_6 , a hydrocarbon discovered in 1825 by Faraday in the liquid produced in the compression of the illuminating gas obtained by distilling certain oils and fats. E. Mitscherlich prepared it in 1834 by distilling benzoic acid with lime; and in 1845 Hofmann discovered it in coal-tar. It was named "benzin" or "benzine" by Mitscherlich in 1833, but in the following year Liebig proposed "benzol" (the termination of being suggested by the Lat. *oleum*, oil); the form "benzene" was due to A. W. Hofmann. The word "benzine" is sometimes used in commerce for the coal-tar product, but also for the light petroleum better known as petroleum-benzine; a similar ambiguity is presented by the word "benzoline," which is applied to the same substances as the word "benzine." "Benzene" is the term used by English chemists, "benzol" is used in Germany, and "benzole" in France.

Benzene is manufactured from the low-boiling fractions of the coal-tar distillate (see COAL-TAR). The first successful fractionation of coal-tar naphtha was devised by C. B. Mansfield (1810-1855), who separated a benzol distilling below 100° from a less volatile naphtha by using a simple dephlegmator. At first, the oil was manufactured principally for combustion in the Read-Holliday lamp and for dissolving rubber, but the development of the coal-tar colour industry occasioned a demand for benzols of definite purity. In the earlier stages 30%, 50% and 90% benzols were required, the 30% being mainly used for the

manufacture of "aniline for red," and the 90% for "aniline for blue." (The term "30% benzol" means that 30% by volume distils below 100°.) A purer benzol was subsequently required for the manufacture of aniline black and other dye-stuffs. The process originally suggested by Mansfield is generally followed, the success of the operation being principally conditioned by the efficiency of the dephlegmator, in which various improvements have been made. The light oil fraction of the coal-tar distillate, which comes over below 140° and consists principally of benzene, toluene and the xylenes, yields on fractionation (1) various volatile impurities such as carbon disulphide, (2) the benzene fraction boiling at about 80° C., (3) the toluene fraction boiling at 100°, (4) the xylene fraction boiling at 140°. The fractions are agitated with strong sulphuric acid, and then washed with a caustic soda solution. The washed products are then refractionated. The toluene fraction requires a more thorough washing with sulphuric acid in order to eliminate the thiolenes, which is supplanted much less readily than thiophene.

Benzene is a colourless, limpid, highly refracting liquid, having a pleasing and characteristic odour. It may be solidified to rhombic crystals which melt at 5.4° C. (Mansfield obtained perfectly pure benzene by freezing a carefully fractionated sample.) It boils at 80.4°, and the vapour is highly inflammable, the flame being extremely smoky. Its specific gravity is 0.899 at 0° C. It is very slightly soluble in water, more soluble in alcohol, and completely miscible with ether, acetic acid and carbon disulphide. It is an excellent solvent for gums, resins, fats, &c.; sulphur, phosphorus and iodine also dissolve in it. It sometimes separates with crystals of a solute as "benzene of crystallization," as for example with triphenylmethane, thio-p-tolyl urea, tropine, &c.

Benzene is of exceptional importance commercially on account of the many compounds derivable from it, which are exceedingly valuable in the arts. Chemically it is one of the most interesting substances known, since it is the parent of the enormous number of compounds styled the "aromatic" or "benzenoid" compounds. The constitution of the benzene ring, the isomerism of its derivatives, and their syntheses from aliphatic or open-chain compounds, are treated in the article CHEMISTRY. A summary of its chemical transformations may be given here, and reference should be made to the articles on the separate compounds for further details.

Passed through a red-hot tube, benzene vapour yields hydrogen, diphenyl, diphenylbenzenes and acetylene; the formation of the last compound is an instance of a reversible reaction, since Berthelot found that acetylene passed through a red-hot tube gave some benzene. Benzene is very stable to oxidants, in fact resistance to oxidation is a strong characteristic of the benzene ring. Manganese dioxide and sulphuric acid oxidize it to benzoic and *o*-phthalic acid; potassium chlorate and sulphuric acid breaks the ring; and ozone oxidizes it to the highly explosive white solid named *azo*-benzene, $C_6H_4O_4$. Hydriodic acid reduces it to hexamethyl-oxene (cyclo-hexane or hexa-hydro-benzene); chlorine and bromine form substitution and addition products, but the action is slow unless some carrier such as iodine, molybdenum chloride or ferric chloride for chlorine, and aluminium bromide for bromine, be present. It is readily nitrated to nitrobenzene, two, and even three nitro groups being introduced if some dehydrator such as concentrated sulphuric acid be present. Sulphuric acid gives a benzene sulphonic acid.

BENZIDINE (DIPARA-DIAMINO-DIPHENYL), $NH_2-C_6H_4-C_6H_4-NH_2$, a chemical base which may be prepared by the reduction of the corresponding dinitro-diphenyl, or by the reduction of azo-benzene with tin and hydrochloric acid. In this latter case hydro-azo-benzene $C_6H_5NH-NH-C_6H_5$ is first formed and then undergoes a peculiar re-arrangement into benzidine (see H. Schmidt and G. Schultz, *Annalen*, 1881, 207, p. 320; O. N. Witt and Hans v. Helmont, *Berichte*, 1894, 27, p. 2352; P. Jacobson, *Berichte*, 1892, 25, p. 994). Benzidine crystallizes in plates (from water) which melt at 122° C., and boil above 360° C., and is characterized by the great insolubility of its sulphate. It is a di-acid base and forms salts with the mineral acids. It is readily

brominated and nitrated; when the nitration is carried out in the presence of sulphuric acid, the nitro-groups take up the meta position with regard to the amino-groups. Benzidine finds commercial application since its tetrazo compound couples readily with amino-sulphonic acids, phenol carboxylic acids, and phenol and naphthol-sulphonic acids to produce substantive cotton dyes (see DYING). Among such dyestuffs are chrysanine or flavopurine, obtained from salicylic acid and diazotized benzidine, and congo red obtained from sodium naphthionate and diazotized benzidine. On the constitution of benzidine see G. Schultz (*Annalen*, 1874, 174, p. 227).

The Benzidine and Semidine Change.—Aromatic hydrazo compounds which contain free para positions are readily converted by the action of acids, acid chlorides and anhydrides into diphenyl derivatives; thus, as mentioned above, hydrazo-benzene is converted into benzidine, a small quantity of diphenylin being formed at the same time. The two products are separated by the different solubilities of their sulphates. This reaction is known as the *benzidine transformation*. If, however, one of the para positions in the hydrazo compound is substituted, then either diphenyl derivatives or azo compounds are formed, or what is known as the *semidine change* takes place (P. Jacobson, *Berichte*, 1892, 25, p. 992; 1893, 26, p. 681; 1896, 29, p. 2680; *Annalen*, 1895, 287, p. 97; 1898, 303, p. 290). A para mono substituted hydrazo compound in the presence of a hydrochloric acid solution of stannous chloride gives either a para diphenyl derivative (the substituent group being eliminated), an ortho-semidine, a para-semidine, or a diphenyl base, whilst a decomposition with the formation of amines may also take place. The nature of the substituent exerts a specific influence on the reaction; thus with chlorine or bromine, ortho-semidines and the diphenyl bases are the chief products, the dimethylamino, $-N(CH_3)_2$, and acetamido, $-NHCOCH_3$, groups give the diphenyl base and the para-semidine respectively. With a methyl group, the chief product is an ortho-semidine, whilst with a carboxyl group, the diphenyl derivative is the chief product. The ortho- and para-semidines can be readily distinguished by their behaviour with different reagents; thus with nitrous acid the ortho-semidines give azimido compounds, whilst the para-semidines give complex diazo derivatives; with formic or acetic acids the ortho-semidines give anhydride compounds of a basic character, the para-semidines give acyl products possessing no basic character. The carbon disulphide and salicylic aldehyde products have also been used as means of distinction, as has also the formation of the stilbazonium bases obtained by condensing ortho-semidines with benzil (O. N. Witt, *Berichte*, 1892, 25, p. 1017).

Structurally we have:—

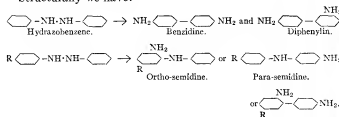

BENZOIC ACID, $C_7H_6O_2$ or C_6H_5COOH , the simplest representative of the aromatic acids. It occurs naturally in some resins, especially in gum benzoin (from *Stryx benzoin*), in dragon's blood, and as a benzyl ester in Peru and Tolu balsams. It can be prepared by the oxidation of toluene, benzyl alcohol, benzaldehyde and cinnamic acid; by the oxidation of benzene with manganese dioxide and concentrated sulphuric acid in the cold (L. Carius, *Ann.* 1868, 148, p. 51); by hydrolysis of benzotriole or of hippuric acid; by the action of carbon dioxide on benzene in the presence of aluminium chloride (C. Friedel and J. M. Crafts, *Ann. chim. phys.* 1888 [6], 14, p. 441); by the action of carbon dioxide on monobromobenzene in the presence of sodium; by condensing benzene and carbonyl chloride in presence of aluminium chloride, the benzoyl chloride formed

being subsequently hydrolysed; and similarly from benzene and chloroformamide:—



the benzamide being then hydrolysed. It may also be prepared by boiling benzyl chloride with dilute nitric acid (G. Lunge, *Berichte*, 1877, 10, p. 1275); by fusing sodium benzene sulphinate with sodium formate: $C_6H_5SO_3Na + HCO_2Na = C_6H_5COONa + NaHSO_3$; by heating calcium phthalate with calcium hydroxide to $330^\circ-350^\circ C$.; by heating benzoic chloride with water in a sealed tube, and from the hippuric acid which is found in the urine of the herbivora. For this purpose the urine is concentrated and the hippuric acid precipitated by the addition of hydrochloric acid; it is then filtered and boiled for some time with concentrated hydrochloric acid, when it is hydrolysed into benzoic and amido-acetic acid. It is made commercially by boiling benzoic chloride (obtained from toluene) with milk of lime, the calcium benzoate so obtained being then decomposed by hydrochloric acid

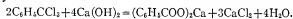

Benzoic acid crystallizes in glistening leaflets (from water) which melt at $121.4^\circ C$. and boil at $249.2^\circ C$. (H. Kopp). Its specific heat is 0.1046. It sublimes readily and is volatile in steam. It is readily soluble in hot water and the ordinary organic solvents, but is only slightly soluble in cold water. When heated with lime, it is decomposed, benzene being formed; if its vapours are passed over heated zinc dust, it is converted into benzaldehyde (A. Baeyer, *Ann.* 1866, 140, p. 296). Distillation of its calcium salt gives benzophenone (*q.v.*) with small quantities of other substances, but if the calcium salt be mixed with calcium formate and the mixture distilled, benzaldehyde is produced. By the action of sodium amalgam on an aqueous solution of the acid, benzyl alcohol, tetrahydrobenzoic acid and hexahydrobenzoic acid are formed. The salts of benzoic acid are known as the benzoates and are mostly soluble in water. They are readily decomposed by mineral acids with the production of benzoic acid, and in addition of ferric chloride to their neutral solutions give a reddish-brown precipitate of ferric benzoate.

Benzoic anhydride, $(C_6H_5CO)_2O$, is prepared by the action of benzoyl chloride on sodium benzoate, or by heating benzoyl chloride with anhydrous oxalic acid (R. Anschutz, *Ann.* 1884, 226, p. 15). It crystallizes in needles, melting at $42^\circ C$., and boiling at $360^\circ C$. It is insoluble in water but readily soluble in alcohol and ether.

Benzoyl chloride, C_6H_5COCl , is formed by distilling a mixture of phosphorus pentachloride and benzoic acid; by the action of chlorine on benzaldehyde, or by passing a stream of hydrochloric acid gas over a mixture of benzoic acid and phosphorus pentoxide heated to $200^\circ C$. (C. Friedel, *Ber.* 1869, 2, p. 80). It is a colourless liquid of very unpleasant smell, which boils at $198^\circ C$., and solidifies in a freezing mixture, the crystals obtained melting at $-1^\circ C$. It shows all the characteristic properties of an acid chloride.

Ethyl benzoate, $C_6H_5COOC_2H_5$, is best prepared by boiling benzoic acid and alcohol with a small quantity of sulphuric acid for some hours (E. Fischer and A. Speier, *Berichte*, 1896, 28, p. 3252). It is a colourless liquid of boiling point $213^\circ C$.

Benzamide, $C_6H_5CONH_2$, is prepared by the action of benzoyl chloride on ammonia or ammonium carbonate, or from ethyl benzoate and ammonia. It crystallizes (from water) in glistening leaflets which melt at $130^\circ C$. and boil at $288^\circ C$. Its silver salt behaves as if it were the salt of an imido benzoic acid, since it yields benzimido ethyl ether $C_6H_5C:(NH)OC_2H_5$ with ethyl iodide (J. Tafel and C. Enoch, *Berichte*, 1890, 23, p. 1550).

Chlor-, brom-, iodo- and fluor-benzoic acids are known and can be obtained by oxidizing the corresponding halogen toluenes, or from the amido acids, or by substitution. Nitration of benzoic acid gives chiefly meta-nitro-benzoic acid. The ortho- and para-nitro-benzoic acids can be obtained by oxidizing ortho- and para-nitro-cinnamic acids. Ortho-amino-benzoic acid, $C_6H_4-NH_2COOH$ (anthranilic acid), is closely related to indigo (*q.v.*).

Gum benzoïn, which contains from 12 to 20% of benzoic acid, is used in medicine as the essential constituent of benzoated lard, *Adeps benzoatus*, which owes its antiseptic properties to benzoic acid; and in friar's balsam, *Tinctura benzoïnî composita*, which is an ancient and valuable medicament, still largely used for inhalation in cases of laryngitis, bronchitis and other inflammatory or actually septic conditions of the respiratory tract. It owes its value to the benzoic acid which it contains. A fluid drachm of friar's balsam may be added to a pint of water at a temperature of about 140° F., and the resultant vapour may be inhaled from the spout of a kettle or from a special inhaler. Benzoic acid itself, ammonium benzoate and sodium benzoate are all administered internally in doses of from five to thirty grains. The ammonium salt is most often employed, owing to the stimulant character of the ammonium base. The acid itself is a powerful antiseptic. When administered internally, it causes the appearance of hippuric acid in the urine. This is due to its combination in the body with glycocholl. The combination probably occurs in the kidney. The hippuric acid in the urine acts as a stimulant and disinfectant to the urinary mucous membrane. Benzoic acid is also excreted by the bronchi and tends to disinfect and stimulate the bronchial mucous membrane. Hence the value of friar's balsam. The acid and its salts are antipyretic and were used in Germany instead of salicylates in rheumatic fever. But the most important fact is that ammonium benzoate is largely used—often in combination with urinary anodynes such as tincture of hyoscyamus—as a urinary antiseptic in cases of cystitis (inflammation of the bladder) and pyelitis (inflammation of the pelvis of the kidney).

BENZOIN, $C_6H_5CHOH \cdot CO \cdot C_6H_5$, a ketone-alcohol, which may be prepared by boiling an alcoholic solution of benzaldehyde with potassium cyanide; by reducing benzil ($C_6H_5CO \cdot CO \cdot C_6H_5$) with zinc and acetic acid; or by the oxidation of hydrobenzoin ($C_6H_5 \cdot CHOH \cdot CHOH \cdot C_6H_5$). It is a colourless, crystalline solid, readily soluble in alcohol and ether, melting at 137° C. and boiling at 343–344° C. On passing the vapour of benzoïn over heated lead oxide, it is converted into benzil and benzophenone. Owing to the readiness with which it is oxidized, it acts as a reducing agent, giving a red precipitate of cuprous oxide with Fehling's solution in the cold. Chlorine and nitric acid oxidize it to benzil; chromic acid mixture and potassium permanganate, to benzoic acid and benzaldehyde. On heating with zinc dust, desoxybenzoïn ($C_6H_5CO \cdot CH_2 \cdot C_6H_5$) is obtained; sodium amalgam converts it into hydrobenzoïn; and fuming hydrochloric acid at 130° C. gives dibenzyl ($C_6H_5CH_2 \cdot CH_2 \cdot C_6H_5$). By fusion with alkali it is converted into benzil; and with an alcoholic solution of benzaldehyde in presence of ammonia it forms amarine (triphenyl dihydro-glyoxaline). In the presence of sulphuric acid it condenses with nitriles to oxazoles (q.v.).

BENZOÏN, or GUM BENJAMIN (supposed to be from Arab. *luban*, frankincense, the first syllable being dropped in Romanic as if it were the article), a balsamic resin obtained from *Styrax benzoïn*, a tree of considerable size, native to Sumatra and Java, and from other species of *Styrax*. It is obtained by making incisions in the bark of the trees, and appears to be formed as the result of the wound, not to be secreted normally. There are several varieties of benzoïn in commerce: (1) Siam benzoïn, which apparently does not come from *Styrax benzoïn*, is the finest and most aromatic, and occurs in the form of small "tears," rarely exceeding 2 in. in length by ½ in. in thickness, and of "blocks" made up of these tears agglomerated by a clear reddish-brown resin. The odour of Siam benzoïn is partly due to the presence of vanillin, and the substance contains as much as 38% of benzoic acid but no cinnamic acid. (2) Sumatra benzoïn occurs only in masses formed of dull red resin enclosing white tears. It contains about 20% of cinnamic acid in addition to 18 or even more of benzoic. (3) Palembang benzoïn, an inferior variety, said to be obtained from *Styrax benzoïn* in Sumatra, consists of greyish translucent resinous masses, containing small white opaque tears. It does not appear to contain cinnamic acid. Large quantities of benzoïn are used as incense. Its medicinal uses depend on the contained benzoic acid (q.v.).

BENZOPHENONE (DIPHENYL KETONE), $C_6H_5 \cdot CO \cdot C_6H_5$, the simplest representative of the true aromatic ketones. It may be prepared by distilling calcium benzoate; by condensing benzene with benzoyl chloride in the presence of anhydrous aluminium chloride; by the action of mercury diphenyl on benzoyl chloride, or by oxidizing diphenylmethane with chromic acid. It is a dimorphous substance existing in two enantiotropic forms, one melting at 26° C. and the other at 48° C. (Th. Zincke, *Berichte*, 1871, 4, p. 576). It boils at 306–1° C., under a pressure of 760·32 mm. It is reduced by sodium amalgam to *benzhydrol* or *diphenyl carbinol* $C_6H_5 \cdot CHOH \cdot C_6H_5$; a stronger reducing agent, such as hydriodic acid in the presence of amorphous phosphorus converts it into *diphenylmethane* (C_6H_5)₂·CH₂. Potash fusion converts it into benzene and benzoic acid. With phenylhydrazine it forms a hydrazone, and with hydroxylamine an oxime, which exists in one form only; if, however, one of the phenyl groups in the oxime be substituted in any way then two stereo-isomeric oximes are produced (cf. STEREO-ISOMERISM); thus *parachlorobenzophenone oxime* exists in two different forms (V. Meyer and K. F. Auwers, *Berichte*, 1890, 23, p. 2403). Many derivatives are known, thus *ortho-amino-benzophenone*, melting at 166° C., can be obtained by reduction of the corresponding nitro compound; it condenses under the influence of heated lead monoxide to an acridine derivative and with acetone in presence of caustic soda it gives a quinoline. *Tetramethyl-diamido-benzophenone* or *Michler's ketone*, $CO(C_6H_4N \cdot (CH_3)_2)_2$, melting at 173°, is of technical importance, as by condensation with various substances it can be made to yield dye-stuffs. It is prepared by the action of carbonyl chloride on dimethyl aniline in the presence of aluminium chloride: $COCl_2 + 2C_6H_5N(CH_3)_2 = 2HCl + CO(C_6H_4N(CH_3)_2)_2$.

BENZYL ALCOHOL (PHENYL CARBINOL), $C_6H_5CH_2OH$, occurs as a benzoic ester in Peru balsam, as cinnamic ether in Tolu balsam, as acetic ester in essential oil of jasmine, and also in storax. It may be synthetically prepared by the reduction of benzoyl chloride; by the action of nitrous acid on benzylamine; by boiling benzyl chloride with an aqueous solution of potassium carbonate, or by the so-called "Cannizzaro" reaction, in which benzaldehyde is shaken up with caustic potash, one half of the aldehyde being oxidized to benzoic acid, and the other half reduced to the alcohol. (*Berichte*, 1881, 14, p. 2394).

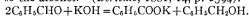

It is a colourless liquid, with a faint aromatic smell, and boils at 206° C. On oxidation with nitric acid it is converted into benzaldehyde, whilst chromic acid oxidizes it to benzoic acid. Reduction by means of hydriodic acid and phosphorus at 140° C. gives toluene, whilst on distillation with alcoholic potash, toluene and benzoic acid are formed.

BEOTHUK, a tribe of North American Indians formerly dwelling in the interior of Newfoundland. A certain mystery attaches to them, since investigation of the few words of their language which have survived suggests that they were of distinct stock. The name (of Micmac origin) is said to mean simply "red men." They were bitterly hostile to the French settlers, and were hunted down and killed off until 1820, when a few survivors made their escape into Labrador. The last of them is believed to have died in 1820.

BEÖTHY, ÖDÖN (1796–1854), Hungarian deputy and orator, was born at Grosswarden, his father being a retired officer and deputy lord-lieutenant of the county of Bihar. At the age of sixteen he served in the war against Napoleon, and was present at the great battle of Leipzig. Like so many others of his compatriots, he picked up Liberal ideas abroad. He was sent to parliament by his county in 1826 and again in 1830, but did not become generally known till the session of 1832–1836, when along with Deák he, as a liberal Catholic, defended the Protestant point of view in "the mixed marriages question." He was also an energetic advocate of freedom of speech. After parliament rose he carried his principles to their logical conclusion by marrying a Protestant lady and, being denied a blessing on the occasion by an indignant bishop, publicly declared that he could very well dispense with such blessings. In 1841 he was elected deputy lord-lieutenant of his county to counteract the influence of the

lord-lieutenant, Lajos Tisza, and powerfully promoted the popular cause by his eloquence and agitation. After 1843 the conservatives succeeded in excluding him both from parliament and from his official position in the county; but during the famous "March Days" (1848) he regained all his authority, becoming at the same time a commander of militia, a deputy and lord-lieutenant. At the first session of the Upper House (5th of July 1848), he moved that it should be radically reformed, and during the war of Independence he energetically served the Hungarian government as a civil commissioner and lord justice. Towards the end of the war he reappeared as a deputy at the Szeged diet, and on the flight of the government took refuge first with Richard Cobden in London and subsequently in Jersey, where he made the acquaintance of Victor Hugo. Thence he went to Hamburg, to meet his wife, and died there on the 7th of December 1854. Böthy was a man of extraordinary ability and character, and an excellent debater. He also exercised as much influence socially over his contemporaries as politically, owing to his unflinching tact and pleasant wit.

See Antal Csengery, *Hungarian Orators and Statesmen* (Hung., Budapest, 1851).

(R. N. B.)

BEOWULF. The epic of Beowulf, the most precious relic of Old English, and, indeed, of all early Germanic literature, has come down to us in a single MS., written about A.D. 1000, which contains also the Old English poem of Judith, and is bound up with other MSS. in a volume in the Cottonian collection now at the British Museum. The subject of the poem is the exploits of Beowulf, son of Ecgtheow and nephew of Hygelac, king of the "Géatas," i.e. the people, called in Scandinavian records Gautar, from whom a part of southern Sweden has received its present name Götland.

The Story.—The following is a brief outline of the story, which naturally divides itself into five parts.

1. Beowulf, with fourteen companions, sails to Denmark, to offer his help to Hrothgar, king of the Danes, whose hall (called "Heorot") has for twelve years been rendered uninhabitable by the ravages of a devouring monster (apparently in gigantic human shape) called Grendel, a dweller in the waste, who used nightly to force an entrance and slaughter some of the inmates. Beowulf and his friends are feasted in the long-deserted Heorot. At night the Danes withdraw, leaving the strangers alone. When all but Beowulf are asleep, Grendel enters, the iron-barred doors having yielded in a moment to his hand. One of Beowulf's friends is killed; but Beowulf, unarmed, wrestles with the monster, and tears his arm from the shoulder. Grendel, though mortally wounded, breaks from the conqueror's grasp, and escapes from the hall. On the morrow, his bloodstained track is followed until it ends in a distant mere.

2. All fear being now removed, the Danish king and his followers pass the night in Heorot, Beowulf and his comrades being lodged elsewhere. The hall is invaded by Grendel's mother, who kills and carries off one of the Danish nobles. Beowulf proceeds to the mere, and, armed with sword and corslet, plunges into the water. In a vaulted chamber under the waves, he fights with Grendel's mother, and kills her. In the vault he finds the corpse of Grendel; he cuts off the head, and brings it back in triumph.

3. Richly rewarded by Hrothgar, Beowulf returns to his native land. He is welcomed by Hygelac, and relates to him the story of his adventures, with some details not contained in the former narrative. The king bestows on him lands and honours, and during the reigns of Hygelac and his son Heardred he is the greatest man in the kingdom. When Heardred is killed in battle with the Swedes, Beowulf becomes king in his stead.

4. After Beowulf has reigned prosperously for fifty years, his country is ravaged by a fiery dragon, which inhabits an ancient burial-mound, full of costly treasure. The royal hall itself is burned to the ground. The aged king resolves to fight, unaided, with the dragon. Accompanied by eleven chosen warriors, he journeys to the barrow. Bidding his companions retire to a distance, he takes up his position near the entrance to the mound—an arched opening whence issues a boiling stream.

The dragon hears Beowulf's shout of defiance, and rushes forth, breathing flames. The fight begins; Beowulf is all but overpowered, and the sight is so terrible that his men, all but one, seek safety in flight. The young Wiglaf, son of Weohstan, though yet untried in battle, cannot, even in obedience to his lord's prohibition, refrain from going to his help. With Wiglaf's aid, Beowulf slays the dragon, but not before he has received his own death-wound. Wiglaf enters the barrow, and returns to show the dying king the treasures that he has found there. With his last breath Beowulf names Wiglaf his successor, and ordains that his ashes shall be enshrined in a great mound, placed on a lofty cliff, so that it may be a mark for sailors far out at sea.

5. The news of Beowulf's dear-bought victory is carried to the army. Amid great lamentation, the hero's body is laid on the funeral pile and consumed. The treasures of the dragon's hoard are buried with his ashes; and when the great mound is finished, twelve of Beowulf's most famous warriors ride around it, celebrating the praises of the bravest, gentlest and most generous of kings.

The Hero.—Those portions of the poem that are summarized above—that is to say, those which relate the career of the hero in progressive order—contain a lucid and well-constructed story, told with a vividness of imagination and a degree of narrative skill that may with little exaggeration be called Homeric. And yet it is probable that there are few readers of Beowulf who have not felt—and there are many who after repeated perusal continue to feel—that the general impression produced by it is that of a bewildering chaos. This effect is due to the multitude and the character of the episodes. In the first place, a very great part of what the poem tells about Beowulf himself is not presented in regular sequence, but by way of retrospective mention or narration. The extent of the material thus introduced out of course may be seen from the following abstract.

When seven years old the orphaned Beowulf was adopted by his grandfather king Hrethel, the father of Hygelac, and was regarded by him with as much affection as any of his own sons. In youth, although famed for his wonderful strength of grip, he was generally despised as sluggish and unwarlike. Yet even before his encounter with Grendel, he had won renown by his swimming contest with another youth named Breca, when after battling for seven days and nights with the waves, and slaying many sea-monsters, he came to land in the country of the Finns. In the disastrous invasion of the land of the Hetware, in which Hygelac was killed, Beowulf killed many of the enemy, amongst them a chieftain the Hugas, named Daghrefn, apparently the slayer of Hygelac. In the retreat he once more displayed his powers as a swimmer, carrying to his ship the armour of thirty slain enemies. When he reached his native land, the widowed queen offered him the kingdom, her son Heardred being too young to rule. Beowulf, out of loyalty, refused to be made king, and acted as the guardian of Heardred during his minority, and as his counsellor after he came to man's estate. By giving shelter to the fugitive Eadgils, a rebel against his uncle the king of the "Swon" (the Swedes, dwelling to the north of the Gautar), Heardred brought on himself an invasion, in which he lost his life. When Beowulf became king, he supported the cause of Eadgils by force of arms; the king of the Swedes was killed, and his nephew placed on the throne.

Historical Value.—Now, with one brilliant exception—the story of the swimming-match, which is felicitously introduced and finely told—these retrospective passages are brought in more or less awkwardly, interrupt inconveniently the course of the narrative, and are too condensed and allusive in style to make any strong poetic impression. Still, they do serve to complete the portraiture of the hero's character. There are, however, many other episodes that have nothing to do with Beowulf himself, but seem to have been inserted with a deliberate intention of making the poem into a sort of cyclopaedia of Germanic tradition. They include many particulars of what purports to be the history of the royal houses, not only of the Gautar and the Danes, but also of the Swedes, the continental

Angles, the Ostrogoths, the Frisians and the Heathobards, besides references to matters of unlocalized heroic story such as the exploits of Sigismund. The Saxons are not named, and the Franks appear only as a dreaded hostile power. Of Britain there is no mention; and though there are some distinctly Christian passages, they are so incongruous in tone with the rest of the poem that they must be regarded as interpolations. In general the extraneous episodes have no great appropriateness to their context, and have the appearance of being abridged versions of stories that had been related at length in poetry. Their confusing effect, for modern readers, is increased by a curiously irrelevant prologue. It begins by celebrating the ancient glories of the Danes, tells in allusive style the story of Scyld, the founder of the "Scylding" dynasty of Denmark, and praises the virtues of his son Beowulf. If this Danish Beowulf had been the hero of the poem, the opening would have been appropriate; but it seems strangely out of place as an introduction to the story of his namesake.

However detrimental these redundancies may be to the poetic beauty of the epic, they add enormously to its interest for students of Germanic history or legend. If the mass of traditions which it purports to contain be genuine, the poem is of unique importance as a source of knowledge respecting the early history of the peoples of northern Germany and Scandinavia. But the value to be assigned to *Beowulf* in this respect can be determined only by ascertaining its probable date, origin and manner of composition. The criticism of the Old English epic has therefore for nearly a century been justly regarded as indispensable to the investigation of Germanic antiquities.

The starting-point of all *Beowulf* criticism is the fact (discovered by N. F. S. Grundtvig in 1815) that one of the episodes of the poem belongs to authentic history. Gregory of Tours, who died in 594, relates that in the reign of Theodorich of Metz (511-534) the Danes invaded the kingdom, and carried off many captives and much plunder to their ships. Their king, whose name appears in the best MSS. as Chlochilaicus (other copies read Chrochilaicus, Hrodolaicus, &c.), remained on shore intending to follow afterwards, but was attacked by the Franks under Theodobert, son of Theodorich, and killed. The Franks then defeated the Danes in a naval battle, and recovered the booty. The date of these events is ascertained to have been between 512 and 520. An anonymous history written early in the eighth century (*Liber Hist. Francorum*, cap. 19) gives the name of the Danish king as Chochililaicus, and says that he was killed in the land of the Attoarii. Now it is related in *Beowulf* that Hygelac met his death in fighting against the Franks and the Hetware (the Old English form of Attoarii). The forms of the Danish king's name given by the Frankish historians are corruptions of the name of which the primitive Germanic form was Hugi-laikaz, and which by regular phonetic change became in Old English *Hygelaec*, and in Old Norse Hugi-leikr. It is true that the invading king is said in the histories to have been a Dane, whereas the Hygelac of *Beowulf* belonged to the "Géatas" or Gautar. But a work called *Liber Monstrorum*,¹ preserved in two MSS. of the 10th century, cites as an example of extraordinary stature a certain "Hugi-laicus, king of the Getae," who was killed by the Franks, and whose bones were preserved on an island at the mouth of the Rhine, and exhibited as a marvel. It is therefore evident that the personality of Hygelac, and the expedition in which, according to *Beowulf*, he died, belong not to the region of legend or poetic invention, but to that of historic fact.

This noteworthy result suggests the possibility that what the poem tells of Hygelac's near relatives, and of the events of his reign and that of his successor, is based on historic fact. There is really nothing to forbid the supposition; nor is there any unlikelihood in the view that the persons mentioned as belonging to the royal houses of the Danes and Swedes had a real existence. It can be proved, at any rate, that several of the names are

derived from the native traditions of these two peoples. The Danish king Hrothgar and his brother Halga, the sons of Healfdene, appear in the *Historia Danica* of Saxo as Roe (the founder of Roskilde) and Helgo, the sons of Haldanus. The Swedish princes Eadgils, son of Othhere, and Onela, who are mentioned in *Beowulf*, are in the Icelandic *Heimskringla* called Adils son of Öttarr, and Áli; the correspondence of the names, according to the phonetic laws of Old English and Old Norse, being strictly normal. There are other points of contact between *Beowulf* on the one hand and the Scandinavian records on the other, confirming the conclusion that the Old English poem contains much of the historical tradition of the Gautar, the Danes and the Swedes, in its purest accessible form.

Of the hero of the poem no mention has been found elsewhere. But the name (the Icelandic form of which is Bjólfr) is genuinely Scandinavian. It was borne by one of the early settlers in Iceland, and a monk named Biulf is commemorated in the *Liber Vitae* of the church of Durham. As the historical character of Hygelac has been proved, it is not unreasonable to accept the authority of the poem for the statement that his nephew Beowulf succeeded Heardred on the throne of the Gautar, and interfered in the dynastic quarrels of the Swedes. His swimming exploit among the Hetware, allowance being made for poetic exaggeration, fits remarkably well into the circumstances of the story told by Gregory of Tours; and perhaps his contest with Breca may have been an exaggeration of a real incident in his career; and even if it was originally related of some other hero, its attribution to the historical Beowulf may have been occasioned by his renown as a swimmer.

On the other hand, it would be absurd to imagine that the combats with Grendel and his mother and with the fiery dragon can be exaggerated representations of actual occurrences. These exploits belong to the domain of pure mythology. That they have been attributed to Beowulf in particular might seem to be adequately accounted for by the general tendency to connect mythical achievements with the name of any famous hero. There are, however, some facts that seem to point to a more definite explanation. The Danish king "Scyld Seefing," whose story is told in the opening lines of the poem, and his son Beowulf, are plainly identical with Sceldwea, son of Sceaf, and his son Beaw, who appear among the ancestors of Woden in the genealogy of the kings of Wessex given in the *Old English Chronicle*. The story of Scyld is related, with some details not found in *Beowulf*, by William of Malmesbury, and, less fully, by the 10th-century English historian Ethelwerd, though it is told not of Scyld himself, but of his father Sceaf. According to William's version, Sceaf was found, as an infant, alone in a boat without oars, which had drifted to the island of "Scandza." The child was asleep with his head on a *sheaf*, and from this circumstance he obtained his name. When he grew up he reigned over the Angles at "Slaswic." In *Beowulf* the same story is told of Scyld, with the addition that when he died his body was placed in a ship, laden with rich treasure, which was sent out to sea unguided. It is clear that in the original form of the tradition the name of the founding was Scyld or Sceldwea, and that his cognomen *Seefing* (derived from *seaf*, a sheaf) was misinterpreted as a patronymic. Sceaf, therefore, is no genuine personage of tradition, but merely an etymological figment.

The position of Sceldwea and Beaw (in Malmesbury's Latin called Sceldius and Beowius) in the genealogy as anterior to Woden would not of itself prove that they belong to divine mythology and not to heroic legend. But there are independent reasons for believing that they were originally gods or demi-gods. It is a reasonable conjecture that the tales of victories over Grendel and the fiery dragon belong properly to the myth of Beaw. If Beowulf, the champion of the Gautar, had already become a theme of epic song, the resemblance of name might easily suggest the idea of enriching his story by adding to it the achievements of Beaw. At the same time, the tradition that the hero of these adventures was a son of Scyld, who was identified (whether rightly or wrongly) with the cognomen of the Danish dynasty of the Scyldings, may well have prompted the

¹ Printed in Berger de Xivrey, *Traditions Tétralogiques* (1836), from a MS. in private hands. Another MS., now at Wolfenbüttel, reads "Huglaccus" for Hugi-laicus, and (ungrammatically) "gentes" for *Getis*.

supposition that they took place in Denmark. There is, as we shall see afterwards, some ground for believing that there were circulated in England two rival poetic versions of the story of the encounters with supernatural beings: the one referring them to Beowulf the Dane, while the other (represented by the existing poem) attached them to the legend of the son of Ecgtheow, but ingeniously contrived to do some justice to the alternative tradition by laying the scene of the Grendel incident at the court of a Scylding king.

As the name of Beow appears in the genealogies of English kings, it seems likely that the traditions of his exploits may have been brought over by the Angles from their continental home. This supposition is confirmed by evidence that seems to show that the Grendel legend was popularly current in this country. In the schedules of boundaries appended to two Old English charters there occurs mention of pools called "Grendel's mere," one in Wiltshire and the other in Staffordshire. The charter that mentions the Wiltshire "Grendel's mere" speaks also of a place called *Beowa hām* ("Beowa's home"), and another Wiltshire charter has a "Scyld's tree" among the landmarks enumerated. The notion that ancient burial mounds were liable to be inhabited by dragons was common in the Germanic world: there is perhaps a trace of it in the Derbyshire place-name *Drakelow*, which means "dragon's barrow."

While, however, it thus appears that the mythic part of the Beowulf story is a portion of primeval Angle tradition, there is no proof that it was originally peculiar to the Angles; and even if it was so, it may easily have passed from them into the poetic cycles of the related peoples. There are, indeed, some reasons for suspecting that the blending of the stories of the mythic Beow and the historical Beowulf may have been the work of Scandinavian and not of English poets. Prof. G. Sarrazin has pointed out the striking resemblance between the Scandinavian legend of *Bödvarr Biarki* and that of the Beowulf of the poem. In each, a hero from Gautland slays a destructive monster at the court of a Danish king, and afterwards is found fighting on the side of *Eadgils* (Adils) in Sweden. This coincidence cannot well be due to mere chance; but its exact significance is doubtful. On the one hand, it is possible that the English epic, which unquestionably derived its historical elements from Scandinavian song, may be indebted to the same source for its general plan, including the blending of history and myth. On the other hand, considering the late date of the authority for the Scandinavian traditions, we cannot be sure that the latter may not owe some of their material to English minstrels. There are similar alternative possibilities with regard to the explanation of the striking resemblances which certain incidents of the adventures with Grendel and the dragon bear to incidents in the narratives of Saxo and the Icelandic sagas.

Date and Origin.—It is now time to speak of the probable date and origin of the poem. The conjecture that most naturally presents itself to those who have made no special study of the question, is that an English epic treating of the deeds of a Scandinavian hero on Scandinavian ground must have been composed in the days of Norse or Danish dominion in England. This, however, is impossible. The forms under which Scandinavian names appear in the poem show clearly that these names must have entered English tradition not later than the beginning of the 7th century. It does not indeed follow that the extant poem is of so early a date; but its syntax is remarkably archaic in comparison with that of the Old English poetry of the 8th century. The hypothesis that *Beowulf* is in whole or in part a translation from a Scandinavian original, although still maintained by some scholars, introduces more difficulties than it solves, and must be dismissed as untenable. The limits of this article do not permit us to state and criticize the many elaborate theories that have been proposed respecting the origin of the poem. All that can be done is to set forth the view that appears to us to be most free from objection. It may be premised that although the existing MS. is written in the West-Saxon dialect, the phenomena of the language indicate transcription from an Anglian (*i.e.* a Northumbrian or Mercian) original; and this conclusion is supported by the fact that while

the poem contains one important episode relating to the Angles, the name of the Saxons does not occur in it at all.

In its original form, *Beowulf* was a product of the time when poetry was composed not to be read, but to be recited in the halls of kings and nobles. Of course an entire epic could not be recited on a single occasion; nor can we suppose that it would be thought out from beginning to end before any part of it was presented to an audience. A singer who had pleased his hearers with a tale of adventure would be called on to tell them of earlier or later events in the career of the hero; and so the story would grow, until it included all that the poet knew from tradition, or could invent in harmony with it. That *Beowulf* is concerned with the deeds of a foreign hero is less surprising than it seems at first sight. The minstrel of early Germanic times was required to be learned not only in the traditions of his own people, but also in those of the other peoples with whom they felt their kinship. He had a double task to perform. It was not enough that his songs should give pleasure; his patrons demanded that he should recount faithfully the history and genealogy both of their own line and of those other royal houses who shared with them the same divine ancestry, and who might be connected with them by ties of marriage or warlike alliance. Probably the singer was always himself an original poet; he might often be content to reproduce the songs that he had learned, but he was doubtless free to improve or expand them as he chose, provided that his inventions did not conflict with what was supposed to be historic truth. For all we know, the intercourse of the Angles with Scandinavia, which enabled their poets to obtain new knowledge of the legends of Danes, Gautar and Swedes, may not have ceased until their conversion to Christianity in the 7th century. And even after this event, whatever may have been the attitude of churchmen towards the old heathen poetry, the kings and warriors would be slow to lose their interest in the heroic tales that had delighted their ancestors. It is probable that down to the end of the 7th century, if not still later, the court poets of Northumbria and Mercia continued to celebrate the deeds of Beowulf and of many another hero of ancient days.

Although the heathen Angles had their own runic alphabet, it is unlikely that any poetry was written down until a generation had grown up trained in the use of the Latin letters learned from Christian missionaries. We cannot determine the date at which some book-learned man, interested in poetry, took down from the lips of a minstrel one of the stories that he had been accustomed to sing. It may have been before 700; much later it can hardly have been, for the old heathen poetry, though its existence might be threatened by the influence of the church, was still in vigorous life. The epic of Beowulf was not the only one that was reduced to writing; a fragment of the song about Finn, king of the Frisians, still survives, and possibly several other heroic poems were written down about the same time. As originally dictated, *Beowulf* probably contained the story outlined at the beginning of this article, with the addition of one or two of the episodes relating to the hero himself—among them the legend of the swimming-match. This story had doubtless been told at greater length in verse, but its insertion in its present place is the work of a poet, not of a mere redactor. The other episodes were introduced by some later writer, who had heard recited, or perhaps had read, a multitude of the old heathen songs, the substance of which he piously sought to preserve from oblivion by weaving it in an abridged form, into the texture of the one great poem which he was transcribing. The Christian passages, which are poetically of no value, are evidently of literary origin, and may be of any date down to that of the extant MS. The curious passage which says that the subjects of Hrothgar sought deliverance from Grendel in prayer at the temple of the Devil, "because they knew not the true God," must surely have been substituted for a passage referring sympathetically to the worship of the ancient gods.

An interesting light on the history of the written text seems to be afforded by the phenomena of the existing MS. The poem is divided into numbered sections, the length of which was probably determined by the size of the pieces of parchment of

which an earlier exemplar consisted. Now the first fifty-two lines, which are concerned with Scyld and his son Beowulf, stand outside this numbering. It may reasonably be inferred that there once existed a written text of the poem that did not include these lines. Their substance, however, is clearly ancient. Many difficulties will be obviated if we may suppose that this passage is the beginning of a different poem, the hero of which was not Beowulf the son of Ecgtheow, but his Danish namesake. It is true that Beowulf the Scylding is mentioned at the beginning of the first numbered section; but probably the opening lines of this section have undergone alteration in order to bring them into connexion with the prefixed matter.

BIBLIOGRAPHY.—The volume containing the *Beowulf* MS. (then, as now, belonging to the Cottonian collection, and numbered "Vitellius A. xv.") was first described by Humphrey Wauley in 1705, in his catalogue of MSS., published as vol. iii. of G. Hickes's *Thesaurus Veterum Linguarum Septentrionalium*. In 1786 G. J. Thorkelin, an Icelandic, made or procured two transcripts of the poem, which are still preserved in the Royal Library at Copenhagen, and are valuable for the criticism of the text. The MS. having subsequently become in places less legible, Thorkelin's edition (1815) is of merely historic interest. The first edition showing competent knowledge of the language was produced in 1833 by J. M. Kemble. Since then editions have been very numerous. The text of the poem was edited by C. W. M. Grein in his *Bibliothek der angelsächsischen Poesie* (1857), and again separately in 1867. Autotypes of the MS. with transliteration by Julius Zupitza, were issued by the Early English Text Society in 1882. The new edition of Grein's *Bibliothek*, by R. P. Wülker, vol. i. (1883), contains a revised text with critical notes. The most serviceable separate editions are those of M. Heyne (7th ed., revised by A. Socin, 1903), A. J. Wyatt (with English notes and glossary, 1898), and F. Holthausen (vol. 1, 1905).

Eleven English translations of the poem have been published (see C. B. Tinker, *The Translations of Beowulf*, 1903). Among these may be mentioned those of J. M. Garnett (6th ed., 1900), a literal rendering in a metre imitating that of the original; J. Earle (1892) in prose; W. Morris (1895) in imitative metre, and almost unintelligibly archaic in diction; and C. B. Tinker (1902) in prose.

For the bibliography of the earlier literature on *Beowulf*, and a detailed exposition of the theories therein advocated, see R. P. Wülker, *Grundriss der angelsächsischen Literatur* (1882). The views of Karl Müllenhoff, which, though no longer tenable as a whole, have formed the basis of most of the subsequent criticism, may be best studied in his posthumous work, *Beowulf, Untersuchungen über das angelsächsische Epos* (1886). Much valuable matter may be found in B. ten Brink, *Beowulf, Untersuchungen* (1888). The work of G. Sarrazin, *Beowulf-studien* (1888), which advocates the strange theory that *Beowulf* is a translation by Cynewulf of a poem by the Danish singer Starkard, contains, amid much that is fanciful, not a little that deserves careful consideration. The many articles by E. Sievers and S. Bugge, in *Beiträge zur Geschichte der deutschen Sprache und Literatur* and other periodicals, are of the utmost importance for the textual criticism and interpretation of the poem. (H. Br.)

BEQUEST (from O. Eng. *becweþan*, to declare or express in words; cf. "quoth"), the disposition of property by will. Strictly, "bequest" is used of personal, and "devise" of real property. (See LEGACY; WILL or TESTAMENT.)

BÉRAIN, JEAN (1638–1711), known as "the Elder," Belgian draughtsman and designer, painter and engraver of ornament, was born in 1638 or 1639 at Saint Mihil (Meuse) and died in Paris on the 24th of January 1711. In 1674 he was appointed *dessinateur de la chambre du cabinet de Roi*, in succession to Gissey, whose pupil he is believed to have been. From 1677 onward he had apartments, near to those of André Charles Boulle (*q.v.*), for whom he made many designs, in the Louvre, where he died. After the death of Le Brun he was commissioned to compose and supervise the whole of the exterior decoration of the king's ships. Without possessing great originality he was inventive and industrious, and knew so well how to assimilate the work of those who had preceded him (especially Raffaello's arabesques) and to adapt it to the taste of the time that his designs became the rage. He furnished designs for the decorations and costumes used in the opera performances, for court festivals, and for public solemnities such as funeral processions, and inspired the ornamentations of rooms and of furniture to such an extent that a French writer says that nothing was done during his later years which he had not designed, or at least which was not in his manner. He was, in fact, the oracle of taste and the supreme pontiff whose fiat was law in all matters of decora-

tion. His numerous designs were for the most part engraved under his own superintendence, and a collection of them was published in Paris in 1711 by his son-in-law, Thuret, clockmaker to the king. There are three books, *Œuvre de J. Bérain, Ornaments inventés par J. Bérain and Œuvres de J. Bérain contenant des ornements d'architecture*. His earliest known works show him as engraver—twelve plates in the collection of *Diverses pièces de serrurerie inventées par Hughes Brissville et gravées par Jean Bérain* (Paris, 1663), and in 1667 ten plates of designs for the use of gunsmiths. M. Guilmard in *Les Maitres ornemanistes*, gives a complete list of his published works.

His son JEAN BÉRAIN, "the Younger" (1678–1726), was born in Paris, where he also died. He was his father's pupil, and exercised the same official functions after his death. Thus he planned the funeral ceremonies at St Denis on the death of the dauphin, and afterwards made the designs for the obsequies of Louis XIV. He is perhaps best known as an engraver. He engraved eleven plates of the collection *Ornements de peinture et de sculpture qui sont dans la galerie d'Apollon au chateau du Louvre, et dans le grand appartement du roy au palais des Tuileries* (Paris, 1710), which have been wrongly attributed to his father, the *Mausolei du duc de Bourgogne*, and that of *Marie-Louise Gabrielle de Savoie, reine d'Espagne* (1714), &c. His work is exceedingly difficult to distinguish from his father's, the similarity of style being remarkable.

CLAUDE BÉRAIN, brother of the elder Jean, was still living in 1726. He was engraver to the king, and executed a good number of plates of ornament and arabesque of various kinds, some of which are included in his more distinguished brother's works. (J. P.-B.)

BÉRANGER, PIERRE JEAN DE (1780–1857), French songwriter, was born in Paris on the 10th of August 1780. The aristocratic *de* was a piece of groundless vanity on the part of his father, who had assumed the name of Béranger de Mersix. He was descended in truth from a country innkeeper on the one side, and on the other, from a tailor in the rue Montorgueil. Of education, in the narrower sense, he had but little. From the roof of his first school he beheld the capture of the Bastille, and this stirring memory was all that he acquired. Later on he passed some time in a school at Péronne, founded by one Belleglise on the principles of Rousseau, where the boys were formed into clubs and regiments, and taught to play solemnly at politics and war. Béranger was president of the club, made speeches before such members of Convention as passed through Péronne, and drew up addresses to Tallien or Robespierre at Paris. In the meanwhile he learned neither Greek nor Latin—not even French, it would appear; for it was after he left school, from the printer Laisney, that he acquired the elements of grammar. His true education was of another sort. In his childhood, shy, sickly and skilful with his hands, as he sat at home alone to carve cherry stones, he was already forming for himself those habits of retirement and patient elaboration which influenced the whole tenor of his life and the character of all that he wrote. At Péronne he learned of his good aunt to be a stout republican; and from the doorstep of her inn, on quiet evenings, he would listen to the thunder of the guns before Valenciennes, and fortify himself in his passionate love of France and distaste for all things foreign. Although he could never read Horace save in a translation, he had been educated on *Télémaque*, Racine and the dramas of Voltaire, and taught, from a child, in the tradition of all that is highest and most correct in French.

After serving his aunt for some time in the capacity of waiter, and passing some time also in the printing-office of one Laisney, he was taken to Paris by his father. Here he saw much low speculation, and many low royalist intrigues. In 1802, in consequence of a distressing quarrel, he left his father and began life for himself in the garret of his ever memorable song. For two years he did literary hackwork, when he could get it, and wrote pastorals, epics and all manner of ambitious failures. At the end of that period (1804) he wrote to Lucien Bonaparte, enclosing some of these attempts. He was then in bad health, and in the last state of misery. His watch was pledged. His

wardrobe consisted of one pair of boots, one greatcoat, one pair of trousers with a hole in the knee, and "three bad shirts which a friendly hand wearied itself in endeavouring to mend." The friendly hand was that of Judith Frère, with whom he had been already more or less acquainted since 1796, and who continued to be his faithful companion until her death, three months before his own, in 1857. She must not be confounded with the Lisette of the songs; the pieces addressed to her (*La Bonne Vieille*, *Maudit printemps*, &c.) are in a very different vein. Lucien Bonaparte interested himself in the young poet, transferred to him his own pension of 1000 francs from the Institute, and set him to work on a *Death of Nero*. Five years later, through the same patronage, although indirectly, Béranger became a clerk in the university at a salary of another thousand.

Meanwhile he had written many songs for convivial occasions, and "to console himself under all misfortunes"; some, according to M. Boiteau, had been already published by his father, but he set no great store on them himself; and it was only in 1812, while watching by the sick-bed of a friend, that it occurred to him to write down the best he could remember. Next year he was elected to the *Caveau Moderne*, and his reputation as a song-writer began to spread. Manuscript copies of *Les Gueux*, *Le Sénateur*, above all, of *Le Roi d'Yvetot*, a satire against Napoleon, whom he was to magnify so much in the sequel, passed from hand to hand with acclamation. It was thus that all his best works went abroad; one man sang them to another over all the land of France. He was the only poet of modern times who could altogether have dispensed with printing.

His first collection escaped censure. "We must pardon many things to the author of *Le Roi d'Yvetot*," said Louis XVIII. The second (1821) was more daring. The apathy of the Liberal camp, he says, had convinced him of the need for some bugle call of awakening. This publication lost him his situation in the university, and subjected him to a trial, a fine of 500 francs and an imprisonment of three months. Imprisonment was a small affair for Béranger. At Sainte Pélagie he occupied a room (it had just been quitted by Paul Louis Courier), warm, well furnished, and preferable in every way to his own poor lodging, where the water froze on winter nights. He adds, on the occasion of his second imprisonment, that he found a certain charm in this quiet, claustal existence, with its regular hours and long evenings alone over the fire. This second imprisonment of nine months, together with a fine and expenses amounting to 1100 francs, followed on the appearance of his fourth collection. The government proposed through Lafitte that, if he would submit to judgment without appearing or making defences, he should only be condemned in the smallest penalty. But his public spirit made him refuse the proposal; and he would not even ask permission to pass his term of imprisonment in a *Maison de santé*, although his health was more than usually feeble at the time. "When you have taken your stand in a contest with government, it seems to me," he wrote, "ridiculous to complain of the blows it inflicts on you, and impolitic to furnish it with any occasion of generosity." His first thought in La Force was to alleviate the condition of the other prisoners.

In the revolution of July he took no inconsiderable part. Copies of his song, *Le Vieux Drapeau*, were served out to the insurgent crowd. He had been for long the intimate friend and adviser of the leading men; and during the decisive week his counsels went a good way towards shaping the ultimate result. "As for the republic, that dream of my whole life," he wrote in 1831, "I did not wish it should be given to us a second time unripe." Louis Philippe, hearing how much the song-writer had done towards his elevation, expressed a wish to see and speak with him; but Béranger refused to present himself at court, and used his favour only to ask a place for a friend, and a pension for Rouget de l'Isle, author of the famous *Marseillaise*, who was now old and poor, and whom he had been already succouring for five years.

In 1848, in spite of every possible expression of his reluctance, he was elected to the Constituent Assembly, and that by so large a number of votes (204,471) that he felt himself obliged to

accept the seat. Not long afterwards, and with great difficulty, he obtained leave to resign. This was the last public event of Béranger's life. He continued to polish his songs in retirement, visited by nearly all the famous men of France. He numbered among his friends Chateaubriand, Thiers, Jacques Laffitte, Michelet, Lamennais, Mignet. Nothing could exceed the amiability of his private character; so poor a man has rarely been so rich in good actions; he was always ready to receive help from his friends when he was in need, and always forward to help others. His correspondence is full of wisdom and kindness, with a smack of Montaigne, and now and then a vein of pleasantry that will remind the English reader of Charles Lamb. He occupied some of his leisure in preparing his own memoirs, and a certain treatise on *Social and Political Morality*, intended for the people, a work he had much at heart, but judged at last to be beyond his strength. He died on the 16th July 1857. It was feared that his funeral would be the signal for some political disturbance; but the government took immediate measures, and all went quietly. The streets of Paris were lined with soldiers and full of townsfolk, silent and uncovered. From time to time cries arose:—"Honneur, honneur à Béranger!"

The songs of Béranger would scarcely be called songs in England. They are elaborate, written in a clear and sparkling style, full of wit and incision. It is not so much for any lyrical flow as for the happy turn of the phrase that they claim superiority. Whether the subject be gay or serious, light or passionate, the medium remains untroubled. The special merits of the songs are merits to be looked for rather in English prose than in English verse. He worked deliberately, never wrote more than fifteen songs a year and often less, and was so fastidious that he has not preserved a quarter of what he finished. "I am a good little bit of a poet," he says himself, "clever in the craft, and a conscientious worker to whom old airs and a modest choice of subjects (*le coin où je me suis confiné*) have brought some success." Nevertheless, he makes a figure of importance in literary history. When he first began to cultivate the *chanson*, this minor form lay under some contempt, and was restricted to slight subjects and a humorous guise of treatment. Gradually he filled these little chiselled toys of verbal perfection with ever more and more of sentiment. From a date comparatively early he had determined to sing for the people. It was for this reason that he fled, as far as possible, the houses of his influential friends and came back gladly to the garret and the street corner. Thus it was, also, that he came to acknowledge obligations to Emile Debraux, who had often stood between him and the masses as interpreter, and given him the key-note of the popular humour. Now, he had observed in the songs of sailors, and all who labour, a prevailing tone of sadness; and so, as he grew more masterful in this sort of expression, he sought more and more after what is deep, serious and constant in the thoughts of common men. The evolution was slow; and we can see in his own works examples of every stage, from that of witty indifference in fifty pieces of the first collection, to that of grave and even tragic feeling in *Les Souvenirs du peuple* or *Le Vieux Vagabond*. And this innovation involved another, which was as a sort of prelude to the great romantic movement. For the *chanson*, as he says himself, opened up to him a path in which his genius could develop itself at ease; he escaped, by this literary postern, from strict academical requirements, and had at his disposal the whole dictionary, four-fifths of which, according to La Harpe, were forbidden to the use of more regular and pretentious poetry. If he still kept some of the old vocabulary, some of the old imagery, he was yet accustoming people to hear moving subjects treated in a manner more free and simple than heretofore; so that his was a sort of conservative reform, preceding the violent revolution of Victor Hugo and his army of uncompromising romantics. He seems himself to have had glimmerings of some such idea; but he withheld his full approval from the new movement on two grounds:—first, because the romantic school misused somewhat brutally the delicate organism of the French language; and second, as he wrote to Sainte-Beuve in 1832, because they adopted the motto of "Art for art," and

set no object of public usefulness before them as they wrote. For himself (and this is the third point of importance) he had a strong sense of political responsibility. Public interest took a far higher place in his estimation than any private passion or favour. He had little toleration for those erotic poets who sing their own loves and not the common sorrows of mankind, "who forget," to quote his own words, "forget beside their mistress those who labour before the Lord." Hence it is that so many of his pieces are political, and so many, in the later times at least, inspired with a socialistic spirit of indignation and revolt. It is by this socialism that he becomes truly modern and touches hands with Burns.

AUTHORITIES.—*Ma biographie* (his own memoirs) (1858); *Vie de Béranger*, by Paul Boiteau (1861); *Correspondance de Béranger*, edited by Paul Boiteau (4 vols., 1860); *Béranger et Lamennais*, by Napoléon Peyrat (1857); *Quarante-cinq lettres de Béranger publiées par Madame Louise Colet* (almost worthless) (1857); *Béranger, ses amis, ses ennemis et ses critiques*, by A. Arnould (2 vols., 1864); J. Janin, *Béranger et son temps* (2 vols., 1866); also *Sainte-Beuve's Portraits contemporains*, vol. 1; J. Garson, *Béranger et la légende napoléonienne* (1897). A bibliography of Béranger's works was published by Jules Brivois in 1876. (R. L. S.)

BERAR, known also as the HYDERABAD ASSIGNED DISTRICTS, formerly a province administered on behalf of the nizâm of Hyderabad by the British government, but since the 1st of October 1903 under the administration of the commissioner-general for the Central Provinces (q.v.). The origin of the name Berar is not known, but may perhaps be a corruption of Vidarbha, the name of a kingdom in the Deccan of which, in the period of the Mahabharata, Berar probably formed part. The history of Berar belongs generally to that of the Deccan, the country falling in turn under the sway of the various dynasties which successively ruled in southern India, the first authentic records showing it to have been part of the Andhra or Satavahana empire. On the final fall of the Chalukyas in the 12th century, Berar came under the sway of the Yadavas of Deogiri, and remained in their possession till the Mussulman invasions at the end of the 13th century. On the establishment of the Bahmani dynasty in the Deccan (1348) Berar was constituted one of the four provinces into which their kingdom was divided, being governed by great nobles, with a separate army. The perils of this system becoming apparent, the province was divided (1478 or 1479) into two separate governments, named after their capitals Gawil and Mahur. The Bahmani dynasty was, however, already tottering to its fall; and in 1490 Imad-ul-Mulk, governor of Gawil, who had formerly held all Berar, proclaimed his independence and proceeded to annex Mahur to his new kingdom. Imad-ul-Mulk was by birth a Kanarese Hindu, but had been captured as a boy in one of the expeditions against Vijayanagar and reared as a Mussulman. He died in 1504 and his direct descendants held the sultanate of Berar until 1561, when Burhan Imad Shah was deposed by his minister Tufal Khan, who assumed the kingship. This gave a pretext for the intervention of Murtaza Nizam Shah of Ahmednagar, who in 1572 invaded Berar, imprisoned and put to death Tufal Khan, his son Shams-ul-Mulk, and the ex-king Burhan, and annexed Berar to his own dominions. In 1595 Sultan Murad, son of the emperor Akbar, besieged Ahmednagar, and was bound off by the formal cession of Berar.

Murad, founding the city of Shahpur, fixed his seat at Berar, and after his death in 1598, and the conquest of the Deccan by Akbar, the province was united with Ahmednagar and Khandesh under the emperor's fifth son, Daniyal (d. 1605), as governor. After Akbar's death (1605) Berar once more became independent under the Abyssinian Malik Ambar (d. 1626), but in the first year of Shah Jahân's reign it was again brought under the sway of the Mogul empire. Towards the close of the 17th century the province began to be overrun by the Mahrattas, and in 1713 the Delhi government formally recognized their right to levy blackmail (*chauth*) on the unhappy population. In 1724 the Nizam-ul-Mulk Asaf Jah established the independent line of the nizams of Hyderabad, and thenceforth the latter claimed to be *de jure* sovereigns of Berar, with exception of certain districts (Mehkar, Umalkhed, &c.) ceded to the peshwa in 1760

and 1795. The claim was contested by the Bhonsla rajahs, and for more than half a century the miserable country was ground between the upper and the nether millstone.

This condition of things was ended by Wellesley's victories at Assaye and Argaon (1803), which forced the Bhonsla raja to cede his territories west of the Wardha, Gawilgarh and Narnala. By the partition treaty of Hyderabad (1804) these ceded territories in Berar were transferred to the nizâm, together with some tracts about Sindkhed and Jalna which had been held by Sindhia. By a treaty of 1822, which extinguished the Mahratta right to levy *chauth*, the Wardha river was fixed as the eastern boundary of Berar, the Melghat and adjoining districts in the plains being assigned to the nizâm in exchange for the districts east of the Wardha held by the peshwa.

Though Berar was no longer oppressed by its Mahratta taskmasters nor harried by Pindari and Bhil raiders, it remained long a prey to the turbulent elements to lose by the sudden cessation of the wars. From time to time bands of soldiery, whom the government was powerless to control, scoured the country, and rebellion succeeded rebellion till 1850, when the last fight against open rebels took place at Chichamba near Risod. Meanwhile the misery of the country was increased by the reckless raising of loans by the nizâm's government and the pledging of the revenues to a succession of great farmers-general. At last the British government had to intervene effectively, and in 1853 a new treaty was signed with the nizâm, under which the Hyderabad contingent was to be maintained by the British government, while for the pay of this force and in satisfaction of other claims, certain districts were "assigned" to the East India Company. It was these "Hyderabad Assigned Districts" which were popularly supposed to form the province of Berar, though they coincided in extent neither with the Berar of the nizams nor with the old Mogul province. In 1860, by a new treaty which modified in the nizâm's favour that of 1853, it was agreed that Berar should be held in trust by the British government for the purposes specified in the treaty of 1853.

Under British control Berar rapidly recovered its prosperity. Thousands of cultivators who had emigrated across the Wardha to the peshwa's dominions, in order to escape the ruinous fiscal system of the nizâm's government, now returned; the American Civil War gave an immense stimulus to the cotton trade; the laying of a line of railway across the province provided yet further employment, and the people rapidly became prosperous and contented.

See *Imperial Gazetteer of India* (Oxford, 1908), and authorities there quoted.

BÉRARD, JOSEPH FRÉDÉRIC (1789-1828), French physician and philosopher, was born at Montpellier. Educated at the medical school of that town, he afterwards went to Paris, where he was employed in connexion with the *Dictionnaire des sciences médicales*. He returned in 1816, and published a work, *Doctrines médicales de l'école de Montpellier* (1819), which is indispensable to a proper understanding of the principles of the Vitalistic school. In 1823 he was called to a chair of medicine at Paris, which he held for three years; he was then nominated professor of hygiene at Montpellier. His health gave way under his labours, and he died in 1828. His most important book is his *Doctrines des rapports du physique et du moral* (Paris, 1823). He held that consciousness or internal perception reveals to us the existence of an immaterial, thinking, feeling and willing subject, the self or soul. Alongside of this there is the vital force, the nutritive power, which uses the physical frame as its organ. The soul and the principle of life are in constant reciprocal action, and the first owes to the second, not the formation of its faculties, but the conditions under which they are evolved. He showed himself unable to understand the points of view of those whom he criticized, and yet his own theories, midway between vitalism and animism, are entirely destitute of originality.

To the *Esprit des doctrines médicales de Montpellier*, published posthumously (Paris, 1830), the editor, H. Pétit, prefixed an account of his life and works; see also Damiron, *Phil. en France au XIX^e siècle* (Paris, 1834); C. J. Tissot, *Anthropologie générale* (1843).

BERAT (Slav. *Byelgorad*; Turk. *Arnaud-Beligradi*), the capital of a sanjak in the vilayet of Iannina, southern Albania, Turkey; on the river Ergene, Ergeni or Osum, a left-hand tributary of the Semeni. Pop. (1900) 15,000. Berat is a fortified town, situated in a fertile valley, which produces wine, olive-oil, fruit and grain. It is the see of an Orthodox metropolitan, and the inhabitants, of whom two-thirds are Albanian and the remainder principally Greek, are equally divided in religion between Christianity and Islam.

BERAUN (Czech *Beroun*), a town of Bohemia, Austria, 27 m. S.W. of Prague by rail. Pop. (1900) 9,693, mostly Czech. It is situated at the confluence of the Beraun with the Litawa river, and is the seat of important textile industry, sugar-refining, corn-milling and brewing. Lime-kilns and the manufacture of cement, and smelting and iron works are carried on in the environs. Beraun is a place of immemorial antiquity. It was originally called *na Brodě* (by the ford), and received the name of Bern, Berun or Verona in the 13th century, when it obtained the privileges of a city from the emperor Charles IV., who was specially attached to the place, calling it "Verona mea." Under his patronage the town rapidly prospered. In 1421 Žižka stormed the town, which later on was retaken and devastated by the troops of Duke Leopold, bishop of Passau. During the Thirty Years' War it was sacked by the Imperialists, the Saxons and the Swedes in turn; and in the first Silesian war the same fate befell it at the hands of the French and Bavarians.

BERBER, a town and mudiria (province) of the Anglo-Egyptian Sudan. The town is on the right bank of the Nile, 1140 ft. above sea-level, in 18° 1' N., 33° 59' E., and 214 m. by rail N.W. of Khartum. Pop. about 6000. Berber derived its importance from being the starting-point of the caravan route, 242 m. long, across the Nubian desert to the Red Sea at Suakin, a distance covered in seven to twelve days. It was also one of the principal stopping-places between Cairo and Khartum. The caravan route to the Red Sea was superseded in 1906 by a railway, which leaves the Wadi Halfa-Khartum line at the mouth of the Atbara. Berber thus lost the Red Sea trade. It remains the centre and market-place for the produce of the Nile valley for a considerable distance. East of the town is an immense plain, which, if irrigated, would yield abundant crops.

Berber, or El Mekerif, is a town of considerable antiquity. Before its conquest by the Egyptians in 1820 its ruler owed allegiance to the kings of Sennar. It was captured by the Mahdists on the 26th of May 1884, and was re-occupied by the Anglo-Egyptian army on the 6th of September 1897. It was the capital of the mudiria until 1905, in which year the headquarters of the province were transferred to Ed Damer, a town near the confluence of the Nile and Atbara. At the northern end of the mudiria is Abu Hamed (*q.v.*), important as a railway junction for Dongola mudiria. The best-known of the tribes inhabiting the province are the Hassania, Jaalin, Bisharin and Kimilab. During the Mahdia most of these tribes suffered severely at the hands of the dervishes. In 1904 the total population of the province was estimated at 83,000. It has since considerably increased. The riverain population is largely engaged in agriculture, the chief crops cultivated being durra, barley, wheat and cotton.

BERBERA, chief town and principal port of the British Somaliland protectorate, North-East Africa, 155 m. S. of Aden, in 10° 26' N., 45° 4' E. Berbera stands at the head of a deep inlet which forms the only completely sheltered haven on the south side of the Gulf of Aden. It is the residence of the commissioner of the protectorate and the headquarters of the Somaliland battalion of the King's African Rifles. The harbour is eleven to thirteen fathoms deep at the entrance (indicated by a lighthouse), decreasing to five fathoms near the shore. Ocean-going steamers find ample accommodation. There are two piers and numerous warehouses. The town is built in two divisions—the native town to the east, the new town, laid out by the Egyptians (1875-1877), to the west. The majority of the better-class houses are of rubble, one-storeyed and flat-roofed. The public buildings include the fort, hospital and barracks.

There are a Roman Catholic mission-house and convent and a government school. The affairs of the town are administered by a municipality. The water-supply is brought to the town by an aqueduct from the hills some 8 m. distant. The bulk of the inhabitants are Somali, who have abandoned a nomadic life and adopted largely the ways of the Arab and Indian traders. The permanent population is under 10,000; but from October to April the population rises to 30,000 or more by the arrival of caravans from Ogaden and Dolbahanta. The traders bring with them tents on the backs of camels and these are pitched near the native town. Their merchandise consists of sheep and goats, gum and resin, skins and ostrich feathers. The trade is almost entirely with Aden, of which Berbera may be considered a commercial dependency. The value of the goods brought in yearly by caravan exceeds on the average £100,000. The total trade of the port for the five years 1901-1902 to 1905-1906 averaged over £200,000 a year. The chief articles of import are cotton goods (European white longcloth and American grey shirting), rice and jowari, flour, dates, sugar and tobacco (the last from Rotterdam). Berbera is said to have been founded by the Ptolemies among the *Barbari* of the adjacent coast lands. It fell subsequently into the possession of Arabs and was included in the Mahommedan state of Adel. At the time of the visit to the town of R. F. Burton and J. H. Speke (1854) it was governed by its own sheiks. In 1870 it was claimed by the khedive Ismaïl, but was not permanently occupied by Egypt until 1875. In 1884 it passed into the possession of Great Britain (see SOMALILAND, § 2, *History*).

BERBERINE, $C_{20}H_{37}NO_4$, an alkaloid occurring together with the alkaloids oxyacanthine $C_{18}H_{29}NO_3$, berbamine $C_{18}H_{29}NO_3$, hydrastine $C_{21}H_{33}NO_6$, and canadine $C_{20}H_{31}NO_4$, in *Berberis vulgaris*; it also occurs in other plants, *Berberis aristata*, *B. aquifolium*, *Hydrastis canadensis*, &c. It is a yellow, crystalline solid, insoluble in ether and chloroform, soluble in 4½ parts of water at 21°, and moderately soluble in alcohol. It is a monacid base; the hydrochloride, $C_{20}H_{37}NO_4 \cdot HCl$, is insoluble in cold alcohol, ether and chloroform, and soluble in 500 parts of water; the acid sulphate, $C_{20}H_{37}NO_4 \cdot H_2SO_4$, dissolves in about 100 parts of water. Canadine is a tetrahydroberberine.

Its constitution was worked out by W. H. Perkin (*J.C.S.*, 1889, 55, p. 63; 1890, 57, p. 991). This followed from a study of the decomposition products, there being obtained hemipinic acid $(CH_3O)_2C_6H_3(COOH)_2$, and a substance which proved to be ω-amino-ethyl-piperonyl carboxylic acid, $CH_2O_2C \cdot C_6H_4 \cdot COOH \cdot CH_2 \cdot CH_2 \cdot NH_2$. His formula was modified by Gadamer (*Abstr. J.C.S.*, 1902, 1, p. 555), who made the free base an aldehyde, but the salts of an *iso*-quinolinium type. This formula, which necessitates the presence of two asymmetric carbon atoms in an alkyl tetrahydroberberine, has been accepted by M. Freund and F. Mayer (*Abstr. J.C.S.*, 1907, 1, p. 632), who showed that two racemic propyl tetrahydroberberines are produced when propyl dihydroberberine is reduced.

BERBERS, the name under which are included the various branches of the indigenous "Libyan" race of North Africa. Since the dawn of history the Berbers have occupied the tract between the Mediterranean and the Sahara from Egypt to the Atlantic. The origin of the name is doubtful. Some believe it to be derived from the word *βάρβαρος* (barbarians), employed first by the Greeks and later by the Romans. Others attribute the first use of the term to the Arab conquerors. However this may be, tribal titles, *Barabara* and *Berberata*, appear in Egyptian inscriptions of 1700 and 1300 B.C., and the Berbers were probably intimately related with the Egyptians in very early times. Thus the true ethnical name may have become confused with *Barbari*, the designation naturally used by classical conquerors. To the Egyptians they were known as "Lebu," "Mashuasha," "Tamahu," "Tehennu" and "Kahaka"; a long list of names is found in Herodotus, and the Romans called them Numidae, Gaetuli and Mauri, terms which have been derived respectively from the Greek *νομάδες* (nomads), the name Gued'oula, of a great Berber tribe, and the Hebrew *mahur* (western). To speak of more modern times

there can be enumerated the Zouaoua and Jebalia (Tripoli and Tunisia); the Chauwia, Kabyles and Beni-Mzab (Algeria); the Shúh (Chlouah), Amazigh and Berbers (Morocco); the Tuareg, Amóshagh, Sourg, &c. (Sahara). These tribes have many sub-tribes, each with a distinctive name. Among the Azgar, an important division of the Tuareg, one of the noble or free tribes, styled Aouraghen, is said to descend from a tribe named Avrigha. The Avrigha, or Afrigha, in ancient times occupied the coast lands near Carthage, and some scholars derive the word Africa from their name (see AFRICA, ROMAN). In regard to the ethnic relations of the Berbers there has been much dispute. The antiquity of their type is evidenced by the monuments of Egypt, where their ancestors are pictured with the same comparatively blond features which many of them still display. The aborigines of the Canary Islands, the Guanches, would seem almost certainly, from the remains of their language, to have been Berbers. But the problem of the actual origin of the Berber race has not yet been solved. Perhaps the most satisfactory theory is that of Sergi, who includes the Berbers in the "Mediterranean Race." General L. L. C. Faidherbe regards them as indigenous Libyans mingled with a fair-skinned people of European origin. Dr Franz Pruner-Bey, Henri Duveyrier and Prof. Flinders Petrie maintain that they are closely related to the ancient Egyptians. Connection has been traced between the early Libyan race and the Cro-Magnon and other early European races and, later, the Basque peoples, Iberians, Picts, Celts and Gauls. The megalithic monuments of Iberia and Celtic Europe have their counterparts in northern Africa, and it is suggested that these were all erected by the same race, by whatever name they be known, Berbers and Libyans in Africa, Iberians in Spain, Celts, Gauls and Picts in France and Britain.

Characteristics.

In spite of a history of foreign conquest—Phoenician, Greek, Roman, Vandal, Arab and French—the Berber physical type and the Berber temperament and nationality have persisted since the stone age. The numerous invasions have naturally introduced a certain amount of foreign blood among the tribes fringing the Mediterranean, but those farther inland have preserved their racial purity to a surprising degree. Though considerable individual differences of type may be found in every village, the Berbers are distinctively a "white" race, and the majority would, if clad in European costume, pass unchallenged as Europeans. Dark hair and brown or hazel eyes are the rule; blue-eyed blonds are found, but their frequency has been considerably overstated. The invaders who have most affected the Berber race are the Arabs, but the two races, with a common religion, often a common government, with the same tribal groupings, have failed to amalgamate to any great extent. This fact has been emphasized by Dr R. G. Latham, who writes: "All that is not Arabic in the kingdom of Morocco, all that is not Arabic in the French provinces of Algeria, and all that is not Arabic in Tunis, Tripoli and Fezzan, is Berber." The explanation lies in a profound distinction of character. The Arab is a herdsman and a nomad; the Berber is an agriculturist and a townsman. The Arab has built his social structure on the Koran, which inculcates absolutism, aristocracy, theocracy; the Berber, despite his nominal Mahomedanism, is a democrat, with his *Jemda* or "Witangemot" and his *Kanum* or unwritten code, the Magna Carta of the individual's liberty as opposed to the community's good. The *Kanum* forbids no sort of exercise of individual will, so long as it is not inimical to the right or rights of other individuals. The Arabizing of the Berbers is indeed limited to little beyond the conversion of the latter to Islam. The Arab, transported to a soil which does not always suit him, so far from thriving, tends to disappear, whereas the Berber becomes more and more aggressive, and yearly increases in numbers. At present he forms at least three-fifths of the population in Algeria, and in Morocco the proportion is greater. The difference between the Berber and the Arab of the Barbary States is summed up by Dr Randall-MacIver in the following words:—"The Berber gives the impression of being, as he is, the descendant of men who have lived in sturdy independence, self-governing and self-reliant.

The Arab is the degenerate offspring of a race which only from its history and past records can claim any title to respect. Cringing, venal, avaricious, dishonest, the Arab combines all the faults of a vicious nature with those which a degraded religion inculcates or encourages. The Berber, on the other hand, is straightforward, honest, by no means averse to money-making, but not unscrupulous in the methods which he employs to this end, intelligent in a degree to which the ordinary Arab never approaches, and trustworthy as no Arab can be."

The Berber's village is his state, and the government is vested in an assembly, the *Jemda*, formed of all males old enough to observe the fast of Ramadan. By them are determined all matters of peace or war, legislation, taxation and justice. The executive officer is the *Amin*, a kind of mayor, elected from some influential family in which the dignity is often in practice hereditary. He owes his position to the good-will of his fellows, receives no remuneration, and resigns as soon as he loses the confidence of the people. By him are appointed certain *Temman* (sing. *Tamen*) who act as overseers, though without executive powers, in the various quarters of the village. The poorest Berber has as great a voice in affairs as the richest. The undue power of the *Jemda* is checked by vendetta and a sort of lynch law, and by the formation of parties (*sofs*), within or without the assembly, for trade, political and other purposes. The Berbers are a warlike people who have never been completely subjugated. Every boy as soon as he reaches sixteen is brought into the *Jemda* and given weapons which he carries till he is sixty. Though each village is absolutely independent as far as its internal affairs are concerned, two or more are often connected by administrative ties to form an *Arsh* or tribe. A number of these tribes form a *Thaakebill* or confederation, which is an extremely loose organization. An exception to this form of government is constituted by the Tuareg, whose organization, owing to their peculiar circumstances of life, is monarchical. Wars are declared by special messengers; the exchange of sticks or guns renders an armistice inviolable. In some tribes a tablet, on which is inscribed the name of every man fit to bear arms, is placed in the mosque. The Berbers, though Mahomedans, do not often observe the prescribed abstinences; they break their fast at Ramadan; and eat wild boar's flesh and drink fig brandy. On the other hand, saints, both male and female, are paid more reverence by Berbers than by Arabs. Around their tombs their descendants settle, and thus sacred villages, often of considerable size, spring up. Almost every village, too, has its saint or prophet, and disputes as to their relative sanctity and powers cause fierce feuds. The hereditary caste known as Marabouts are frequently in open opposition to the absolute authority of the *Jemda*. They are possessed of certain privileges, such as exemption from the chief taxes and the duty of bearing arms. They, however, often take a foremost part in tribal administration, and are frequently called upon to perform the office of arbitrators in questions of disputed policy, &c. In the *Jemda*, too, the Marabout at times takes the place of honour and keeps order. The Berbers, if irreligious, are very superstitious, never leaving their homes without exorcizing evil spirits, and have a good and evil interpretation for every day of the week. Many Berbers still retain certain Christian and Jewish usages, relics of the pre-Islamic days in North Africa, but of their primitive religion there is no trace. They are seldom good scholars, but those under French rule take all the advantage they can of the schools instituted by the government. Their social tendencies are distinctly communistic; property is often owned by the family in common, and a man can call upon the services of his fellow villagers for certain purposes, as the building of a house. Provision for the poor is often made by the community.

The dress of the Berbers was formerly made of home-woven cloth, and the manufacture of woollen stuffs has always been one of the chief occupations of their women. The men wear a tunic reaching to the knees, the women a longer garment. For work the men use a leather apron, and in the cold

Government.

Customs.

season and in travelling a burnous, usually a family heirloom, old and ragged; the women, in winter, throw a coloured cloth over their shoulders. The men's hair is cut short but their beards are allowed to grow. In some districts there are peculiar customs, such as the wearing of small silver nose-rings, seen in El-Jofra. The Berbers' weapons are those of the Arab: the long straight sword, the slightly curved and highly ornamented dagger, and the long gun. Berbers are not great town-builders. Their villages, however, are often of substantial appearance: with houses of untrimmed stones, occasionally with two storeys, built on hills, and invariably defended by a bank, a stone wall or a hedge. Sometimes their homes are mere tufts of turf, or of clay tiles, with mortar made from lime and clay or cow-dung. The sloping roof is covered with reeds, straw or stones. The living room is on the right, the cattle-stall on the left. The dwelling is surrounded by a garden or small field of grain. The second storey is not added till a son marries. In the villages of the western Atlas the greater part of the upper storey consists of a sort of rough verandah. In this mountain district the natives spend the winter in vaults beneath the houses, and, for the sake of warmth, the tenements are built very close. Agriculture, which is carried on even in the mountain districts by means of laboriously constructed terraces, is antiquated in its methods. The plough, often replaced on the steeper slopes by the hoe, is similar to that depicted in ancient Egyptian drawings, and hand irrigation is usual. A sickle, toothed like a saw, is used for reaping. Corn is trodden by oxen, and kept in osier baskets narrowing to the top, or clay granaries. The staple crop is barley, but wheat, lentils, vetches, flax and gourds are also cultivated. Tobacco, maize and potatoes have been introduced; and the aloe and prickly pear, called in Morocco the Christian fig, are also found. The Kabyles understand grafting, have fine orchards and grow vines. The Beni-Abbas tribe in the Algerian Atlas is famed for its walnuts, and many tribes keep bees, chiefly for the commercial value of the wax. The Berber diet largely consists of cucumbers, gourds, water-melons and onions, and a small artichoke (*Cynara humilis*) which grows wild. At the beginning and end of their meal they drink a strongly sweetened liquid made from green tea and mint. Tea-drinking probably became a habit in Morocco about the beginning of the 10th century; coffee came by way of Algiers. At feasts the food is served on large earthenware dishes with high basket-work covers, like bee-skeps but twice as high.

The Berbers have many industries. They mine and work iron, lead and copper. They have olive presses and flour mills, and their own millstone quarries, even travelling into Arab districts to build mills for the Arabs. They make lime, tiles, woodwork for the houses, domestic utensils and agricultural implements. They weave and dye several kinds of cloth, tan and dress leather and manufacture oil and soap. Without the assistance of the wheel the women produce a variety of pottery utensils, often of very graceful design, and decorated with patterns in red and black. Whole tribes, such as the Beni-Sliman, are occupied in the iron trade; the Beni-Abbas made firearms before the French conquest, and -ven cannon are said to have been made by boring. Before it was proscribed by the French, the manufacture of gunpowder was general. The native jewellers make excellent ornaments in silver, coral and enamel. In some places wood-carving has been brought to considerable perfection; and native artists know how to engrave on metal both by etching and the burin. In its collective industry the Berber race is far superior to the Arab. The Berbers are keen traders too, and, after the harvest, hawk small goods, travelling great distances.

A Berber woman has in many ways a better position than her Arab sister. True, her birth is regarded as an event of no moment, while that of a boy is celebrated by great rejoicings, and his mother acquires the right to wear on her forehead the *lajaint*, a mark which only the women who have borne an heir can assume. Her husband buys and can dismiss her at will. She has most of the hard work to do, and is little better than a servant. When she is old and past work,

especially if she has not been the mother of a male child, she is often abandoned. But she has a voice in public affairs; she has laws to protect her, manages the household and goes unveiled; she has a right to the money she earns; she can inherit under wills, and bequeath property, though to avoid the alienation of real property, succession to it is denied her. But most characteristic of her social position is the Berber woman's right to enter into a sacred bond or agreement, represented by the giving of the *anaya*. This is some symbolic object, stick or what not, which passes between the parties to a contract, the obligations under which, if not fulfilled by the contracting parties during their lives, become hereditary. Female saints, too, are held in high honour; and the Berber pays his wife the compliment of monogamy. The Kabyle women have stood side by side with their husbands in battle. Among many Berber tribes the law of inheritance is such that the eldest daughter's son succeeds. South of Morocco proper, Gerhard Rohlfs, who travelled extensively in the region (c. 1861-1867), states that a Berber religious corporation, the *Savie Kartas*, was ruled over by a woman, the chief's wife. The Berbers consult their women in many matters, and only one woman is really held in low esteem. She, curiously, is the *kuata* or "go-between," even though her services are only employed in the respectable task of arranging marriages. Berber women are intelligent and hard-working, and, when young, very pretty and graceful. The Berbers, unlike the Arabs, do not admire fat women. Among the Kabyles the adulteress is put to death, as are those women who have illegitimate children, the latter suffering with their mothers.

Though Arabic has to a considerable extent displaced the Berber language, the latter is still spoken by millions of people from Egypt to the Atlantic and from the Mediterranean to the Sudan. It is spoken nowhere else, though, as **Language.** has been said, place-names in the Canary Islands and other remains of the aboriginal language there prove it to have been the native tongue. Although the Berber tongue shows a certain affinity with Semitic in the construction both of its words and sentences Berber is quite distinct from the Semitic languages; and a remarkable fact is that in spite of the enormous space over which the dialects are spread and the thousands of years that some of the Berber peoples have been isolated from the rest, these dialects show but slight differences from the long-extinct Hamitic speech from which all are derived. Whatever these dialects be called, the Kabyle, the Shilha, the Zenati, the Tuareg or Tamashek, the Berber language is still essentially one, and the similarity between the forms current in Morocco, Algeria, the Sahara and the far-distant oasis of Siwa is much more marked than between the Norse and English in the sub-Aryan Teutonic group. The Berbers have, moreover, a writing of their own, peculiar and little used or known, the antiquity of which is proved by monuments and inscriptions ranging over the whole of North Africa.

The various spoken dialects, though apparently very unlike each other, are not more dissimilar than are Portuguese, Spanish, French and Italian, and their differences are doubtless attributable to the lack of a literary standard. Even where different words are used, there is evidence of a common stem from which the various branches have sprung. The great difficulty of satisfactory comparison arises from the fact that few of the Berber dialects possess any writings. The *Tawahhid* (The Unity of God), said to have been written in Moroccan Berber and believed to be the oldest African work in existence, except Egyptian and Ethiopic, was the work of the Muhawhadi leader, Ibn Tumart the Mahdi, at a time when the officials of the Kairawan mosque were dismissed because they could not speak Berber. Most of the writings found, however, have been in the form of inscriptions, chiefly on ornaments. A collection of the various signs of the alphabet has shown thirty-two letters, four more than Arabic. De Slane, in his notes on the Berber historian Ibn Khaldun, shows the following points of similarity to the Semitic class:—its tri-literal roots, the inflections of the verb, the formation of derived verbs, the genders of the second and

third persons, the pronominal affixes, the aoristic style of tense, the whole and broken plurals and the construction of the phrase. Among the peculiar grammatical features of Berber may be mentioned two numbers (no dual), two genders and six cases, and verbs with one, two, three and four radicals, and imperative and aoristic tense only. As might be expected the Berber tongue is most common in Morocco and the western Sahara—the regions where Arab dominion was least exercised. When Arabic is mentioned as the language of Morocco it is seldom realized how small a proportion of its inhabitants use it as their mother tongue. Berber is the real language of Morocco, Arabic that of its creed and government.

BIBLIOGRAPHY.—General A. Hanoteau and A. Letourneau, *La Kabylie et les coutumes kabyles* (3 vols., Paris, 1872-1873); D. Randall-MacIver and Antony Wilkin, *Libyan Notes* (London, 1901); Antony Wilkin, *Among the Berbers of Algeria* (London, 1900); G. Sergi, *La Mediterranean Race* (London, 1901), and *Africa, Antropologia della Stirpe Comitica* (Turin, 1897); Henri Duveyrier, *Exploration du Sahara* (1864), *Les Progrès de la géographie en Algérie* (1867-1871), *Bull. de la Soc. Khédiviale de Géog.* (1876); E. Renan, "La Société Berbère," *Revue des deux mondes*, vol. for 1873; M. G. Olivier, "Recherches sur l'origine des Berbères," *Bull. de l'Acad. d'Hippone* (1867-1868); F. G. Kohlfs, *Reise durch Marokko* (1860); *Quer durch Africa* (1874-1875); General Faidherbe, *Collection complète des inscriptions numides (lybiqnes)* (1870), and *Les Doimans d'Afrique* (1873); H. M. Flinders Petrie in *The Academy*, 20th of April 1895; Jules Lionel, *Sans berbères* (1894); Sir H. H. Johnston, "A Journey through the Tunisian Sahara," *Geog. Journal*, vol. xi., 1898; De Slane's translation of Ibn Khaldun, *Hist. des Berbères* (Algiers, 1852); W. Z. Ripley, *Races of Europe* (London, 1900); Dr Malbot, "Les Chaouias" in *L'Anthropologie*, 1897 (p. 14); General Faidherbe and Dr Paul Topinard, *Instructions sur l'anthropologie de l'Algérie* (Paris, 1874); E. T. Hamy, *La Nécropole berbère d'Henchir el-Aziz* (Paris, 1896), and *Cités et nécropoles berbères de l'Enfida (Tunisie moyenne)* (ib. 1904).

Berber dictionaries:—*Venture de Paradis* (Paris, 1844); Brosseard (ib. 1844); Delaporte (ib. 1844, by order of minister of war); J. B. Creusat, *Essai de dictionnaire français-kabyle* (Algiers, 1873); A. Hanoteau, *Essai de grammaire de la langue lamacheck, etc.* (Paris, 1860); Minutoli, *Siwah Dialect* (Berlin, 1827).

Folklore, &c.—J. Rivière, *Recueil de contes populaires de la Kabylie* (1882); R. Basset, *Contes populaires berbères* (1887); P. le Blanc de Prebois, *Essai de contes kabyles, avec traduction en français* (Batna, 1897); H. Stumme, *Märchen der Berbern von Tamasraht in Südägypten* (Leipzig, 1900).

BERCEUSE (Fr. for a "lullaby," from *berceau*, a cradle), a cradle-song, the German *Wiegeliied*, a musical composition with a quiet rocking accompaniment.

BERCHEM (or BERGHEM), NICOLAAS (1620-1683), Dutch painter, was born at Haarlem. He received instruction from his father (Pieter Claasz van Haarlem) and from the painters Van Goyen, Jan Wils and Weenix. It is not known why he called himself Berchem (or Berghem, and other variants). His pictures, of which he produced an immense number, were in great demand, as were also his etchings and drawings. His landscapes are highly esteemed; and many of them have been finely engraved by John Vischer. His finest pictures are at the Amsterdam Museum and at the Hermitage, St Petersburg.

BERCHTA (English Bertha), a fairy in South German mythology. She was at first a benevolent spirit, the counterpart of Hulda in North German myth. Later her character changed and she came to be regarded as a witch. In Pagan times Berchta had the rank of a minor deity.

BERCHTESGADEN, a town of Germany, beautifully situated on the south-eastern confines of the kingdom of Bavaria, 1700 ft. above the sea on the southern declivity of the Unterschberg, 6 m. S.S.E. from Reichenhall by rail. Pop. (1900) 10,046. It is celebrated for its extensive mines of rock-salt, which were worked as early as 1174. The town contains three old churches, of which the early Gothic abbey church with its Romanesque cloister is most notable, and some good houses. Apart from the salt-mines, its industries include toys and other small articles of wood, horn and ivory, for which the place has long been famous. The district of Berchtesgaden was formerly an independent spiritual principality, founded in 1100 and secularized in 1803. The abbey is now a royal castle, and in the neighbourhood a hunting-lodge was built by King Maximilian II. in 1852.

BERCK, a bathing resort of northern France, in the department of Pas-de-Calais, 25 m. S. of Boulogne by rail. Pop. (1906) 7638. It comprises two parts—Berck-Ville, 1½ m. from the shore, and Berck-Plage, the latter with a fine sandy beach. There are two children's hospitals, the climate proving peculiarly beneficial in the treatment of scrofulous affections. About 150 boats are employed in the fisheries, and herrings form the staple of an active trade. Boat-building and fish-curing are carried on.

BERDICHEV, a town of W. Russia, in the government of Kiev, 116 m. S.W. of Kiev by rail and not far from the borders of Volhynia. The cathedral of the Assumption, finished in 1832, is the principal place of worship. The fortified Carmelite monastery, founded in 1627, was captured and plundered by Chmielnicki, chief of the Zaporogian Cossacks, in 1647, and disestablished in 1864. An extensive trade is carried on in peltry, silk goods, iron and woad wares, salt fish, grain, cattle and horses. Four fairs are held yearly, the most important being on the 12th of June and the 15th of August. The numerous minor industries include the manufacture of tobacco, soap, candles, oil, brims and leather. Pop. (1867) 52,563; (1897) 53,728, Jews forming about 80%. In the treaty of demarcation between the Lithuanians and the Poles in 1546 Berdichev was assigned to the former. In 1768 Pulaski, leader of the confederacy of Bar, fled, after the capture of that city, to Berdichev, and there maintained himself during a siege of twenty-five days. The town belongs to the Radziwili family.

BERDYANSK, a seaport town of Russia, in the government of Taurida, on the north coast of the Sea of Azov, in 46° 45' N. lat. and 36° 40' E. long. The principal industries are in bricks and tiles, tallow and macaroni. The roads are protected from every wind except the south, which occasions a heavy surf; but against this a mole was constructed in 1863. The chief articles of export are cereals, flour, wool, hemp, skins and fish; and the imports include hardware, fruits, oil and petroleum. In the immediate neighbourhood are salt-lagoons. Pop. (1867) 12,223; (1900) 29,168.

BEREA, a town of Madison county, Kentucky, U.S.A., 131 m. by rail S. of Cincinnati. Pop. (1900) 762. Berea is served by the Louisville & Nashville railway. It is pleasantly situated on the border between the Blue Grass and the Mountain regions. The town is widely known as the seat of Berea College, which has done an important work among the mountaineers of Kentucky (and of Tennessee). The college has about 70 acres of ground (and about 4000 acres of mountain land for forestry study), with a large recitation hall, a library, a chapel (seating 1400 persons), a science hall, an industrial hall, a brick-making plant, a woodwork building, a printing building, a tabernacle for commencement exercises and other buildings. In 1908 Berea had 65 instructors and 1150 students; and it paid the tuition of 141 negro students in Fisk University (Nashville, Tennessee) and in other institutions. The school out of which Berea College has developed was founded in the anti-slavery interests in 1855. An attempt was made to procure for it a college charter in 1859, but the slavery interests caused it to be closed before the end of that year and it was not reopened until 1865, the charter having then been obtained, as Berea College. Negroes as well as whites were admitted until 1904, when education of the two races at the same institution was prohibited by an act of the state legislature (upheld by the U.S. Supreme Court in 1908). This act did not, however, prohibit an institution from maintaining separate schools for the two races, provided these schools were at least 25 m. apart, and a separate school for the negroes was at once projected by Berea.

BEREKHIAH NAQDAN, Jewish fabulist, author of a collection of *Fox Fables*, written in Hebrew. As his title implies (Naqdan = punctuator of the Biblical text), Berekhiah was also a grammarian. He further wrote an ethical treatise and was the author of various translations. His date is disputed. Most authorities place him in the 13th century, but J. Jacobs has identified him with Benedictus le Puncteur, an English Jew of the 12th century.

BERENGARIUS [BERENGAR] (d. 1088), medieval theologian, was born at Tours early in the 11th century; he was educated in the famous school of Fulbert of Chartres, but even in early life seems to have exhibited great independence of judgment. Appointed superintendent of the cathedral school of his native city, he taught with such success as to attract pupils from all parts of France, and powerfully contributed to diffuse an interest in the study of logic and metaphysics, and to introduce that dialectic development of theology which is designated the scholastic. The earliest of his writings of which we have any record is an *Exhortatory Discourse* to the hermits of his district, written at their own request and for their spiritual edification. It shows a clear discernment of the dangers of the ascetic life, and a deep insight into the significance of the Augustinian doctrine of grace. Sometime before 1040 Berengar was made archdeacon of Angers. It was shortly after this that rumours began to spread of his holding heretical views regarding the sacrament of the eucharist. He had submitted the doctrine of transubstantiation (already generally received both by priests and people, although in the west it had been first unequivocally taught and reduced to a regular theory by Paschasius Radbert in 831) to an independent examination, and had come to the conclusion that it was contrary to reason, unwarranted by Scripture, and inconsistent with the teaching of men like Ambrose, Jerome and Augustine. He did not conceal this conviction from his scholars and friends, and through them the report spread widely that he denied the common doctrine respecting the eucharist. His early friend and school companion, Adelman, archdeacon of Liège, wrote to him letters of expostulation on the subject of this report in 1046 and 1048; and a bishop, Hugo of Langres, wrote (about 1049) a refutation of the views which he had himself heard Berengar express in conversation. Berengar's belief was not shaken by their arguments and exhortations, and hearing that Lanfranc, the most celebrated theologian of that age, strongly approved the doctrine of Paschasius and condemned that of "Scotus" (really Ratramnus), he wrote to him a letter expressing his surprise and urging him to reconsider the question. The letter, arriving at Bec when Lanfranc was absent at Rome (1050), was sent after him, but was opened before it reached him, and Lanfranc, fearing the scandal, brought it under the notice of Pope Leo IX. Because of it Berengar was condemned as a heretic without being heard, by a synod at Rome and another at Verceil, both held in 1050. His enemies in France cast him into prison; but the bishop of Angers and other powerful friends, of whom he had a considerable number, had sufficient influence to procure his release. At the council of Tours (1054) he found a protector in the papal legate, the famous Hildebrand, who, satisfied himself with the fact that Berengar did not deny the real presence of Christ in the sacramental elements, succeeded in persuading the assembly to be content with a general confession from him that the bread and wine, after consecration, were the body and blood of the Lord, without requiring him to define how. Trusting in Hildebrand's support, and in the justice of his own cause, he presented himself at the synod of Rome in 1059, but found himself surrounded by zealots, who forced him by the fear of death to signify his acceptance of the doctrine "that the bread and wine, after consecration, are not merely a sacrament, but the true body and the true blood of Christ, and that this body is touched and broken by the hands of the priests, and ground by the teeth of the faithful, not merely in a sacramental but in a real manner." He had no sooner done so than he bitterly repented his weakness; and acting, as he himself says, on the principle that "to take an oath which never ought to have been taken is to estrange one's self from God, but to retract what one has wrongfully sworn to, is to return back to God," when he got safe again into France he attacked the transubstantiation theory more vehemently than ever. He continued for about sixteen years to disseminate his views by writing and teaching, without being directly interfered with by either his civil or ecclesiastical superiors, greatly to the scandal of the multitude and of the zealots, in whose eyes Berengar was "ille apostolus Satanae," and the academy of Tours the "Babylon

nostris temporis." An attempt was made at the council of Poitiers in 1076 to allay the agitation caused by the controversy, but it failed, and Berengar narrowly escaped death in a tumult. Hildebrand, now pope as Gregory VII., next summoned him to Rome, and, in a synod held there in 1078, tried once more to obtain a declaration of his orthodoxy by means of a confession of faith drawn up in general terms; but even this strong-minded and strong-willed pontiff was at length forced to yield to the demands of the multitude and its leaders; and in another synod at Rome (1079), finding that he was only endangering his own position and reputation, he turned unexpectedly upon Berengar and commanded him to confess that he had erred in not teaching a change as to *substantial reality* of the sacramental bread and wine into the body and blood of Christ. "Then," says Berengar, "confounded by the sudden madness of the pope, and because God in punishment for my sins did not give me a steadfast heart, I threw myself on the ground, and confessed with impious voice that I had erred, fearing the pope would instantly pronounce against me the sentence of condemnation, and, as a necessary consequence, that the populace would hurry me to the worst of deaths." He was kindly dismissed by the pope not long after, with a letter recommending him to the protection of the bishops of Tours and Angers, and another pronouncing anathema on all who should do him any injury or call him a heretic. He returned home overwhelmed with shame and bowed down with sorrow for having a second time been guilty of a great impiety. He immediately recalled his forced confession, and besought all Christian men "to pray for him, so that his tears might secure the pity of the Almighty." He now saw, however, that the spirit of the age was against him, and hopelessly given over to the belief of what he had combated as a delusion. He withdrew, therefore, into solitude, and passed the rest of his life in retirement and prayer on the island of St Côme near Tours. He died there in 1088.

Berengar left behind him a considerable number of followers. All those who in the middle ages denied the substantial presence of the body and blood of Christ in the eucharist were commonly designated Berengarians. They differed, of course, in many respects, even in regard to the nature of the supper. Berengar's own views on the subject may be thus summed up:—1. That bread and wine should become flesh and blood and yet not lose the properties of bread and wine was, he held, contradictory to reason, and therefore irreconcilable with the truthfulness of God. 2. He admitted a change (*conversio*) of the bread and wine into the body of Christ, in the sense that to those who receive them they are transformed by grace into higher powers and influences—into the true, the intellectual or spiritual body of Christ. The unbelieving receive the external sign or *sacramentum*; but the believing receive in addition, although invisibly, the reality represented by the sign, the *res sacramentalis*. 3. He rejected the notion that the sacrament of the altar was a constantly renewed sacrifice, and held it to be merely a commemoration of the one sacrifice of Christ. 4. He dwelt strongly on the importance of men looking away from the externals of the sacrament to the spirit of love and piety. The transubstantiation doctrine seemed to him full of evil, from its tendency to lead men to overvalue what was sensuous and transitory. 5. He rejected with indignation the miraculous stories told to confirm the doctrine of transubstantiation. 6. Reason and Scripture seemed to him the only grounds on which a true doctrine of the Lord's supper could be rested. He attached little importance to mere ecclesiastical tradition or authority, and none to the voice of majorities, even when sanctioned by the decree of a pope. In this, as in other respects, he was a precursor of Protestantism.

The opinions of Berengar are to be ascertained from the works written in refutation of them by Adelman, Lanfranc, Guitmund, &c.; from the fragments of the *De sac. coena adv. Lanfr. liber*, edited by Stäudlin (1820-1829); and from the *Liber posterior*, edited by A. F. and F. T. Vischer (1834). See the collection of texts by Sudendorf (1850); the *Church Histories* of Gieseler, ii. 396-411 (Eng. trans.); and Neander, vi. 221-260 (Eng. trans.); A. Harnack's *History of Dogma*; Hauréau's *Histoire de la philosophie scolastique*, i. 225-238; Hermann Reuter, *Geschichte der religiösen Aufklärung des*

Mittelalters, vol. i. (Berlin, 1875); L. Schwabe, *Studien zur Geschichte des Zweiten Abendmahlts* (1887); and W. Broecking, "Bruno von Angers und Berenger von Tours," in *Deutsche Zeitschrift für Geschichtswissenschaft* (vol. xii., 1895).

BÉRENGER, ALPHONSE MARIE MARCELLIN THOMAS (1785-1866), known as Bérenger de la Drôme, French lawyer and politician, son of a deputy of the third estate of Dauphiné to the Constituent Assembly, was born at Valence on the 31st of May 1785. He entered the magistracy and became *procureur général* at Grenoble, but resigned this office on the restoration of the Bourbons. He now devoted himself mainly to the study of criminal law, and in 1818 published *La Justice criminelle en France*, in which with great courage he attacked the special tribunals, provosts' courts or military commissions which were the main instruments of the Reaction, and advocated a return to the old common law and trial by jury. The book had a considerable effect in discrediting the reactionary policy of the government; but it was not until 1828, when Bérenger was elected to the chamber, that he had an opportunity of exercising a personal influence on affairs as a member of the group known as that of constitutional opposition. His courage, as well as his moderation, was again displayed during the revolution of 1830, when, as president of the parliamentary commission for the trial of the ministers of Charles X., he braved the fury of the mob and secured a sentence of imprisonment in place of the death penalty for which they clamoured.

His position in the chamber was now one of much influence, and he had a large share in the modelling of the new constitution, though his effort to secure a hereditary peerage failed. Above all he was instrumental in framing the new criminal code, based on more humanitarian principles, which was issued in 1835. It was due to him that, in 1832, the right, so important in actual French practice, was given to juries to find "extenuating circumstances" in cases when guilt involved the death penalty. In 1831 he had been made a member of the court of appeal (*cour de cassation*), and the same year was nominated a member of the academy of moral and political sciences. He was raised to the peerage in 1839. This dignity he lost owing to the revolution of 1848; and as a politician his career now ended. As a judge, however, his activity continued. He was president of the high courts of Bourges and Versailles in 1849. Having been appointed president of one of the chambers of the court of cassation, he devoted himself entirely to judicial work until his retirement, under the age limit, on the 31st of May 1866. He now withdrew to his native town, and occupied himself with his favourite work of reform of criminal law. In 1833 he had shared in the foundation of a society for the reclamation of young criminals, in which he continued to be actively interested to the end. In 1851 and 1852, on the commission of the academy of moral sciences, he had travelled in France and England for the purpose of examining and comparing the penal systems in the two countries. The result was published in 1855 under the title *La Répression pénale, comparaison du système pénitentiaire en France et en Angleterre*. He died on the 15th of May 1866.

His son, **RENÉ BÉRENGER** (1830-), continued the work of his father, and at the outbreak of the revolution of 1870 was *avocat général* of Lyons. He served as a volunteer in the Franco-German War, being wounded at Nuits on the 28th of December. Returned to the National Assembly by the department of Drôme, he was for a few days in 1873 minister of public works under Thiers. He then entered the senate, of which he was vice-president from 1894 to 1897. He founded in 1871 a society for the reclamation of discharged prisoners, and presided over various bodies formed to secure improvement of the public morals. He succeeded Charles Lucas in 1890 at the Academy of Moral and Political Science.

BERENICE, or **BERENICE**, the Macedonian forms of the Greek *Pherenice*, the name of (A) five Egyptian and (B) two Jewish princesses.

(A) 1. **BERENICE**, daughter of Lagos, wife of an obscure Macedonian soldier and subsequently of Ptolemy Soter, with whose bride Eurydice she came to Egypt as a lady-in-waiting. Her son, Ptolemy Philadelphus, was recognized as heir over the

heads of Eurydice's children. So great was her ability and her influence that Pyrrhus of Epirus gave the name *Berenice* to a new city. Her son Philadelphus decreed divine honours to her on her death. (See Theocritus, *Idylls* xv. and xvii.)

2. **BERENICE**, daughter of Ptolemy Philadelphus, wife of Antiochus Theos of Syria, who, according to agreement with Ptolemy (249), had divorced his wife Laodice and transferred the succession to Berenice's children. On Ptolemy's death, Antiochus repudiated Berenice and took back Laodice, who, however, at once poisoned him and murdered Berenice and her son. The prophecy in Daniel xi. 6 seq. refers to these events.

3. **BERENICE**, the daughter of Magas, king of Cyrene, and the wife of Ptolemy III. Evergetes. During her husband's absence on an expedition to Syria, she dedicated her hair to Venus for his safe return, and placed it in the temple of the goddess at Zephyrium. The hair having by some unknown means disappeared, Conon of Samos, the mathematician and astronomer, explained the phenomenon in courtly phrase, by saying that it had been carried to the heavens and placed among the stars. The name *Coma Berenices*, applied to a constellation, commemorates this incident. Callimachus celebrated the transformation in a poem, of which only a few lines remain, but there is a fine translation of it by Catullus. Soon after her husband's death (221 B.C.) she was murdered at the instigation of her son Ptolemy IV., with whom she was probably associated in the government.

4. **BERENICE**, also called **CLEOPATRA**, daughter of Ptolemy X., married as her second husband Alexander II., grandson of Ptolemy VII. He murdered her three weeks afterwards.

5. **BERENICE**, daughter of Ptolemy Auletes, eldest sister of the great Cleopatra. The Alexandrines placed her on the throne in succession to her father (58 B.C.). She married Seleucus Cybiosactes, but soon caused him to be slain, and married Archelaus, who had been made king of Comana in Pontus (or in Cappadocia) by Pompey. Auletes was restored and put both Berenice and Archelaus to death in 55 B.C.

(B) 1. **BERENICE**, daughter of Salome, sister of Herod I., and wife of her cousin Aristobulus, who was assassinated in 6 B.C. Their relations had been unhappy and she was accused of complicity in his murder. By Aristobulus she was the mother of Herod Agrippa I. Her second husband, Theudion, uncle on the mother's side of Antipater, son of Herod I., having been put to death for conspiring against Herod, she married Archelaus. Subsequently she went to Rome and enjoyed the favour of the imperial household.

2. **BERENICE**, daughter of Agrippa I., king of Judaea, and born probably about A.D. 28. She was first married to Marcus, son of the alabarch¹ Alexander of Alexandria. On his early death she was married to her father's brother, Herod of Chalcis, after whose death (A.D. 48) she lived for some years with her brother, Agrippa II. Her third husband was Polemon, king of Cilicia, but she soon deserted him, and returned to Agrippa, with whom she was living in 60 when Paul appeared before him at Caesarea (Acts xxvi.). During the devastation of Judaea by the Romans, she fascinated Titus, whom along with Agrippa she followed to Rome as his promised wife (A.D. 75). When he became emperor (A.D. 79) he dismissed her finally, though reluctantly, to her own country. Her influence had been exercised vainly on behalf of the Jews in A.D. 66, but the burning of her palace alienated her sympathies. For her influence see Juvenal, *Satires*, vi., and Tacitus, *Hist.* ii. 2.

BERENICE, an ancient seaport of Egypt, on the west coast of the Red Sea, in 23° 56' N., 35° 34' E. Built at the head of a gulf, the *Sinus Immuudus*, or Foul Bay, of Strabo, it was sheltered on the north by Ras Benas (*Lepie Extrema*). The port is now nearly filled up, has a sand-bar at its entrance and can be reached only by small craft. Most important of the ruins is a temple; the remnants of its sculptures and inscriptions preserve the name of Tiberius and the figures of many deities, including a goddess¹ Alabarch or Arabarch (Gr. ἀλαβάρχη, or ἀραβάρχη), the name of the head magistrate of the Jews in Alexandria under the Ptolemaic and Roman rules.

of the emerald mines. Berenice was founded by Ptolemy II. (285-247 B.C.) in order to shorten the dangerous Red Sea voyages, and was named in honour of his mother. For four or five centuries it became the entrepôt of trade between India, Arabia and Upper Egypt. From it a road, provided with watering stations, leads north-west across the desert to the Nile at Coptos. In the neighbourhood of Berenice are the emerald mines of Zabara and Saket.

BERESFORD, LORD CHARLES WILLIAM DE LA POER (1836-), British admiral, second son of the 4th marquess of Waterford, was born in Ireland, and entered the "Britannia" as a naval cadet in 1859. He became lieutenant in 1868, and commander in 1875. In 1874 he was returned to parliament as Conservative M.P. for Waterford, retaining his seat till 1880, and he was already known in this period as a gallant officer, with a special interest in naval administration. In 1875-1876 he accompanied the then prince of Wales on his visit to India as naval A.D.C.; from 1878 to 1881 he was commander of the royal yacht "Osborne." He was in command of the gunboat "Condor" in the Mediterranean when the Egyptian crisis of 1882 occurred; and he became a popular hero in England in connexion with the bombardment of Alexandria (July 11), when he took his ship close in to the forts and engaged them with such conspicuous gallantry that the admiral ordered a special signal "Well done, Condor!" He was promoted captain for his services, and, after taking an active part in the re-establishment of order in Alexandria, he served again in Egypt on Lord Wolsley's staff in the expedition of 1884-85, commanding the naval brigade at Abu Klea, Abu Kru and Metemeh, and, with the river steamer "Safeh," rescuing Sir C. Wilson and his party, who had been wrecked on returning from Khartum (Feb. 4, 1885). In November 1885 he was again returned to parliament as member for East Marylebone (re-elected 1886), and in Lord Salisbury's ministry of 1886 he was appointed a lord of the admiralty. The press agitation in favour of a stronger navy was now in full swing, and it was well known that in Lord Charles Beresford it had an active supporter; but very little impression was made on the government, and in 1888 he resigned his office on this question, a dramatic step which had considerable effect. In the House of Commons he advocated an expenditure of twenty millions sterling on the fleet, and the passing of the Naval Defence Act in 1889 was largely due to his action. At the end of 1889 he became captain of the cruiser "Undaunted" in the Mediterranean, and when this ship was paid off in 1893 he was appointed in command of the steam reserve at Chatham, a post he held for three years. In 1897 he became rear-admiral, and again entered parliament, winning a by-election at York; he retained his seat till 1900, but was mainly occupied during these years by a mission to China on behalf of the Associated Chambers of Commerce; he published his book *The Break-up of China* in 1899. In 1902 he was returned to parliament for Woolwich, but resigned on his appointment to command the Channel squadron (1903-1905); in 1905 he was given the command of the Mediterranean fleet, and from 1906 to 1909 was commander-in-chief of the Channel fleet; in 1906 he became a full admiral. At sea he had always shown himself a remarkable disciplinarian, possessed of great influence over his men, and his reputation as one who would, if necessary, prove a great fighting commander was second to none; and, even when serving afloat and therefore unable to speak direct to the public, he was in the forefront of the campaign for increased naval efficiency. During the administration (1903-1910) of Sir John Fisher (see FISHER, BARON) as first sea lord of the admiralty it was notorious that considerable friction existed between them, and both in the navy and in public a great deal of party-spirit was engendered in the discussion of their opposing views. When Lord Charles Beresford's term expired as commander-in-chief in March 1909 he was finally "unmuzzled," and the attack which for some years his supporters had made against Sir J. Fisher's administration came to a head at a moment coinciding with the new shipbuilding crisis occasioned by the revelations as to the increase of the German fleet. He himself came forward with proposals for a large increase in the navy

and a reorganization of the administrative system, his first step being a demand for an inquiry, to which the government promptly assented (May) in the shape of a small Committee under the prime minister. Its report (August), however, gave him no satisfaction, and he proceeded with his public campaign, bitterly attacking the ministerial policy. In January 1910, at the general election, he was returned as Conservative M.P. for Portsmouth; but meanwhile Sir John Fisher's term of office came to an end, and in his successor, Admiral Sir Arthur Knyvet Wilson (b. 1842), the navy obtained a first sea lord who commanded universal confidence.

BERESFORD, JOHN (1738-1805), Irish statesman, was a younger son of Sir Marcus Beresford, who, having married Catherine, sole heiress of James Power, 3rd earl of Tyrone, was created earl of Tyrone in 1746. After the death of the earl in 1763, Beresford's mother successfully asserted her claim *suo jure* to the barony of La Poer. John Beresford, born on the 14th of March 1738, thus inherited powerful family connexions. He was educated at Trinity College, Dublin, was called to the Irish bar, and entered the Irish parliament as member for Waterford in 1760. His industry, added to the influence of his family, procured his admission to the privy council in 1768, and his appointment as one of the commissioners of revenue two years later. In 1780 he became first commissioner of revenue, a position which gave him powerful influence in the Irish administration. He introduced some useful reforms in the machinery of taxation; and he was the author of many improvements in the architecture of the public buildings and streets of Dublin. He was first brought into conflict with Grattan and the popular party, in 1784, by his support of the proposal that the Irish parliament in return for the removal of restrictions on Irish trade should be bound to adopt the English navigation laws. In 1786 he was sworn a member of the English privy council, and the power which he wielded in Ireland through his numerous dependants and connexions grew to be so extensive that a few years later he was spoken of as the "king of Ireland." He was a vehement opponent of the increasing demand for relief of the Roman Catholics; and when it became known that Lord Fitzwilliam was to succeed Lord Westmorland as lord lieutenant in 1795 for the purpose of carrying out a conciliatory policy, Beresford expressed strong hostility to the appointment. One of Fitzwilliam's first acts was to dismiss Beresford from his employment but with permission to retain his entire official salary for life, and with the assurance that no other member of his family would be removed. Beresford immediately exerted all his influence with his friends in England, to whom he described himself as an injured and persecuted man; he appealed to Pitt, and went in person to London to lay his complaint before the English ministers. There is little doubt that the recall of Lord Fitzwilliam (*q.v.*), which was followed by such momentous consequences in the history of Ireland, was, as the viceroy himself believed, mainly due to Beresford's dismissal. There had been a misunderstanding on the point between Pitt and Fitzwilliam. The latter, whose veracity was unimpeachable, asserted that previous to his coming to Ireland he had informed the prime minister of his intention to dismiss Beresford, and that Pitt had raised no objection. Pitt denied all recollection of any such communication, and on the contrary described the dismissal as "an open breach of the most solemn promise." In a letter to Lord Carlisle, justifying his action, Fitzwilliam mentioned that malversation had been imputed to Beresford. Beresford sent a challenge to Fitzwilliam, but the combatants were interrupted on the field and Fitzwilliam then made an apology.

When Lord Camden replaced Fitzwilliam in the viceroyalty in March 1795, Beresford resumed his former position. On the eve of the rebellion in 1798 his letters to Lord Auckland gave an alarming description of the condition of Ireland, and he counselled strong measures of repression. When first consulted by Pitt on the question of the union Beresford appears to have disliked the idea; but he soon became reconciled to the policy and warmly supported it. After the union Beresford continued to represent

¹ Stanhope, *Life of Pitt*, ii. 301.

Waterford in the imperial parliament, and he remained in office till 1802, taking an active part in settling the financial relations between Ireland and Great Britain. He died near Londonderry on the 5th of November 1805. John Beresford was twice married: in 1760 to a foreign lady, Constantia Ligondes, who died in 1772; and, secondly, in 1774 to Barbara Montgomery, a celebrated beauty who figures in Sir Joshua Reynolds's picture of "The Graces." He had large families by both marriages. His son, John Claudius, kept a riding school in Dublin, which acquired an evil reputation as the chief scene of the floggings by which evidence was extorted of the conspiracy which came to a head in 1798. He took a prominent part in the Irish House of Commons, where he unsuccessfully moved the reduction of the proposed Irish contribution to the imperial exchequer in the debates on the Act of Union, of which, unlike his father, he was to the last an ardent opponent.

See *Correspondence of the Right Hon. John Beresford*, edited by W. Beresford (2 vols., London, 1854); Edward Wakefield, *An Account of Ireland* (2 vols., London, 1812); Earl Stanhope, *Life of William Pitt* (4 vols., London, 1861); W. E. H. Lecky, *History of Ireland in the Eighteenth Century*, vols. iii., iv., v. (5 vols., London, 1892). (R. J. M.)

BERESFORD, WILLIAM CARR BERESFORD, VISCOUNT (1768–1854), British general and Portuguese marshal, illegitimate son of the first marquess of Waterford, was born on the 2nd of October 1768. He entered the British army in 1785, and while in Nova Scotia with his regiment in the following year lost the sight of one eye by a shooting accident. He first distinguished himself at Toulon in 1793, receiving two years later the command of the 88th regiment (Connaught Rangers). In 1799 his regiment was ordered to India, and a few months later Beresford left with Sir David Baird's expedition for Egypt, and was placed in command of the first brigade which led the march from Kosseir across the desert. When, on the evacuation of Egypt in 1803, he returned home, his reputation was established. In 1805 he accompanied Sir David Baird to South Africa, and was present at the capture of Cape Town and the surrender of the colony. From South Africa he was despatched to South America. He had little difficulty in capturing Buenos Aires with only a couple of regiments. But this force was wholly insufficient to hold the colony. Under the leadership of a French *émigré*, the chevalier de Timiers, the colonists attacked Beresford, and at the end of three days' hard fighting he was compelled to capitulate. After six months' imprisonment he escaped, and reached England in 1807, and at the end of that year he was sent to Madeira, occupying the island in the name of the king of Portugal. After six months in Madeira as governor and commander-in-chief, during which he learnt Portuguese and obtained an insight into the Portuguese character, he was ordered to join Sir Arthur Wellesley's army in Portugal. He was first employed as commandant in Lisbon, but accompanied Sir John Moore on the advance into Spain, and took a conspicuous part in the battle of Corunna (see PENINSULAR WAR). In February 1809 Beresford was given the task of reorganizing the Portuguese army. In this task, by systematic weeding-out of inefficient officers and men, he succeeded beyond expectation. By the summer of 1810 he had so far improved the moral and discipline of the force that Wellington brigaded some of the Portuguese regiments with English ones, and at Busaco Portuguese and English fought side by side. Beresford's services in this battle were rewarded by the British government with a knighthood of the Bath and by the Portuguese with a peerage.

In the spring of 1811 Wellington was compelled to detach Beresford from the Portuguese service. The latter was next in seniority to General (Lord) Hill who had gone home on sick leave, and on him, therefore, the command of Hill's corps now devolved. Unfortunately Beresford never really gained the confidence of his new troops. At Campo Mayor his light cavalry brigade got out of hand, and a regiment of dragoons was practically annihilated. He invested Badajoz with insufficient forces, and on the advance of Soult he was compelled to raise the siege and offer battle at Albuera. His personal courage was even more than usually conspicuous, but to the initiative of a junior

staff officer, Colonel (afterwards Viscount) Hardinge, rather than to Beresford's own generalship, was the hardly-won victory to be attributed. Beresford then went back to his work of reorganizing the Portuguese army. He was present at the siege of Badajoz and at the battle of Salamanca, where he was severely wounded (1812). In 1813 he was present at the battle of Vitoria, and at the battles of the Pyrenees, while at the battle of the Nivelle, the Nive and Orthez he commanded the British centre, and later he led a corps at the battle of Toulouse. At the close of the Peninsular War he was created Baron Beresford of Albuera and Cappelouin, with a pension of £2000 a year, to be continued to his two successors.

In 1819 the revolution in Portugal led to the dismissal of the British officers in the Portuguese service. Beresford therefore left Portugal and placed the question of the arrears of pay of his army before the king at Rio Janeiro. On his return the new Portuguese government refused to allow him to land, and he accordingly left for home. On arriving in England he turned his attention to politics, and strongly supported the duke of Wellington in the House of Lords. In 1823 his barony was made a viscountcy, and when the duke of Wellington formed his first cabinet in 1828 he gave Beresford the office of master-general of the ordnance. In 1830 Beresford retired from politics, and for some time subsequently he was occupied in a heated controversy with William Napier, the historian of the Peninsular War, who had severely criticised his tactics at Albuera. On this subject Wellington's opinion of Beresford is to the point. The duke had no illusions as to his being a great general, but he thought very highly of his powers of organization, and he went so far as to declare, during the Peninsular War, that, in the event of his own death, he would on this ground recommend Beresford to succeed him. The last years of Beresford's life were spent at Bedgebury, Kent, where he had purchased a country estate. He died on the 8th of January 1854.

BEREZINA, a river of Russia, in the government of Minsk, forming a tributary of the Dnieper. It rises in the marshes of Borizov and flows south, inclining to east, for 350 m. (250 m. navigable), for the most part through low-lying but well-wooded country. As a navigable river, and forming a portion of the canal system which unites the Black Sea with the Baltic, it is of importance for commerce, but is subject to severe floods. It was just above Borizov that Napoleon's army forced the passage of the Berezina, with enormous losses, on the 26th–28th of November 1812, during the retreat from Moscow.

BEREZOV, a town of Asiatic Russia, in the government of Tobolsk, 700 m. N. of the city of that name, situated on three hills on the left bank of the Sova, 26 m. above its mouth in the Ob, in 63° 55' N. lat. and 65° 7' E. long. It has more than once suffered from conflagrations—for example, in 1710 and 1808. Prince Menshikov, the favourite of Peter the Great and Catherine I., died here an exile, in 1729. In 1730 his enemy and rival, Prince Dolgoruki, was interned here with his family; and in 1742 General Ostermann was sent to Berezov with his wife and died there in 1747. The yearly mean temperature is 25° Fahr., the maximum cold being 4-7°. It has a cathedral, near which lie buried Mary Menshikov, once betrothed to the tsar Peter II., and some of the Dolgorukis. There is some trade in furs, mammoth bones, dried and salted fish. Pop. (1897) 1073.

BEREZOVSK, a village of east Russia, in the government of Perm, on the eastern slope of the Ural, 8 m. N.E. of Ekaterinburg. It is the centre of an important gold-mining region (5 m. by 2½) of the same name. The mines have been known since 1747. The inhabitants also manufacture boots, cut stone and carry on cabinet-making.

BERG (*Ducatus Montensis*), a former duchy of Germany, on the right bank of the Rhine, bounded N. by the duchy of Cleves, E. by the countship of La Marck and the duchy of Westphalia, and S. and W. by the bishopric of Cologne. Its area was about 1120 sq. m. The district was raised in 1108 to the rank of a countship, but did not become a duchy till 1380, after it had passed into the possession of the Jülich family. In 1423 the duchy of Jülich fell to Adolf Berg, and in 1437 the countship

of Ravensberg was united to the duchies. The male line of the dukes of Jülich-Berg-Ravensberg became extinct in 1511, and the duchy passed by marriage to John III. (d. 1530), duke of Cleves and count of La Marck, whose male line became extinct with the death of John William, bishop of Münster, in 1609. Of the latter's four sisters, the eldest (Marie Eleonore) was married to Albert Frederick, duke of Prussia, the second (Anna) to Philip Louis, count palatine of Neuburg, the third (Magdalena) to John, count palatine of Zweibrücken, and the fourth (Sybille) to Charles of Habsburg, margrave of Burgau. The question of the succession led to a prolonged contest, which was one of the causes of the Thirty Years' War. It was settled in 1614 by a partition, under which Berg, with Jülich, was assigned to the count palatine of Neuburg, in whose line it remained till 1742, when it passed to the Sultzbach branch of the house of Wittelsbach. On the death of Charles Theodore, the last of this line, in 1799, Jülich and Berg fell to Maximilian Joseph of Zweibrücken (Maximilian I. of Bavaria), who ceded the duchies in 1806 to Napoleon. Berg was bestowed by Napoleon, along with the duchy of Cleves and other possessions, on Joachim Murat, who bore the title of grand-duke of Berg; and after Murat's elevation to the throne of Naples, it was transferred to Louis, the son of the king of Holland. By the congress of Vienna in 1815 it was made over to Prussia.

See B. Schönneshöfer, *Geschichte des Bergischen Landes* (Elberfeld, 1895); Stokvis, *Manuel d'histoire*, &c. vol. iii. (Leiden, 1890-1893); and R. Gêcke, *Das Grossherzogtum Berg unter Joachim Murat, Napoleon I^{er} und Louis Napoleon, 1806-1813* (Cologne, 1877).

BERGAMASK, or **BERGOMASK** (from the town of Bergamo in North Italy), a clumsy rustic dialect (cf. Shakespeare, *Midsummer Night's Dream*, v. 360) copied from the natives of Bergamo, reputed to be very awkward in their manners.

BERGAMO (anc. *Bergomum*), a city and episcopal see of Lombardy, Italy, capital of the province of Bergamo, situated at the foot of the Alps, at the junction of the Brembo and Serio, 33½ m. N.E. of Milan by rail, and 26 m. direct. Pop. (1901) town, 25,425; commune, 46,861. The town consists of two distinct parts, the older Città Alta, upon a hill 1200 ft. above sea-level, strongly fortified by the Venetians, and the new town (Città Bassa) below, the two being connected by a funicular railway. The most interesting building of the former is the fine Romanesque church of S. Maria Maggiore, founded in 1137 and completed in 1355, with a baroque interior and some interesting works of art. Adjoining it to the north is the Cappella Colleoni, with a richly sculptured polychrome façade, and a modernized interior, containing the fine tombs of Bartolommeo Colleoni (c. 1400-1475), a native of Bergamo, and his daughter Medea. The work was executed in 1470-1476 by Giovanni Antonio Amadeo, who was also employed at the Certosa di Pavia. The market-place (now Piazza Garibaldi) contains the Gothic Palazzo Vecchio or Broletto; close by are the cathedral (1614) and a small baptistry of 1340, rebuilt in 1898. The lower town contains an important picture-gallery, consisting of three collections of works of north Italian masters, one of which was bequeathed in 1891 by the art critic Giovanni Morelli. Bergamo has fine modern buildings and numerous silk and cotton factories. It also has a considerable cattle market, though its yearly Fiera di S. Alessandro (the patron saint) has lost some of its importance. Railways radiate from it to Lecco, Ponte della Selva, Usmate (for Monza or Seregno), Treviglio (on the main line from Milan to Verona and Venice) and (via Rovato) to Brescia, and steam tramways to Treviglio, Sarnico and Soncino.

The ancient Bergomum was the centre of the tribe of the Orobiti; it became, after their subjection to Rome, a Roman municipality with a considerable territory, and after its destruction by Attila, became the capital of a Lombard duchy. From 1264 to 1428 it was under Milan, but then became Venetian, and remained so until 1797. Remains of the Roman city are not visible above ground, but various discoveries made are recorded by G. Mantovani in *Not. Scav.*, 1890, 25. (T. As.)

BERGAMOT, OIL OF, an essential oil obtained from the rind of the fruit of the *Citrus bergamia*. The bergamot is a small

tree with leaves and flowers like the bitter orange, and a round fruit nearly 3 in. in diameter, having a thin lemon-yellow smooth rind. The tree is cultivated in southern Calabria, whence the entire supply of bergamot oil is drawn. Machinery is mostly used to express the oil from the fruit, which is gathered in November and December. The oil, which on standing deposits a stearoptene, bergamot camphor or bergaptene, is a limpid greenish-yellow fluid of a specific gravity of 0.882 to 0.886, and its powerful but pleasant odour is mainly due to the presence of linalyl acetate, or *bergamotol*, which can be artificially prepared by heating linalol with acetic anhydride. The chief use of bergamot oil is in perfumery. The word apparently is derived from the Italian town Bergamo. The name Bergamot, for a variety of pear, is an entirely different word, supposed to be a corruption of the Turkish *beg-armudi* (= prince's pear; cf. Ger. *Fürstenbirn*).

BERGEDORF, a town of Germany, in the territory of Hamburg, on the river Bille, 10 m. by rail E. by S. from the city. Pop. (1900) 23,728. It produces vegetables and fruit for the Hamburg markets, and carries on tanning, glass manufacture, brewing and brick-making. It received civic rights in 1275, belonged to Lübeck and Hamburg conjointly from 1420 to 1868, and in the latter year was purchased by Hamburg. The surrounding district, exceptionally fertile marshland, is known as Die Vierlande, being divided into four parishes, whence the name is derived.

BERGEN, a city and seaport of Norway, forming a separate county (*amt*), on the west coast, in lat. 60° 23' N. (about that of the Shetland Islands). Pop. (1900) 72,179. It lies at the head of the broad Byfjord, and partly on a rocky promontory (Nordnaes) between the fine harbour (Vaagen) and the Puddefjord. Its situation is very beautiful, the moist climate (mean annual rainfall, 74 in.) fostering on the steep surrounding hills a vegetation unusually luxuriant for the latitude. Behind the town lie the greater and lesser Lungegaard Lakes, so that the site is in effect a peninsula. The harbour is crowded with picturesque timber-ships and fishing-smacks, and is bordered by quays. The principal street is Strandgaden, on the Nordnaes, parallel with the harbour, communicating inland with the *torv* or market-place, which fronts the harbour and contains the fish and fruit market. The portion of the city on the mainland rises in an amphitheatre. The houses, of wood or stucco, are painted in warm reds and yellows. On the banks of the lesser Lungegaard Lake is the small town park, and above the greater lake the pleasant Nygaards park, with an aquarium adjoining. Among the principal buildings are the cathedral (rebuilt in the 16th century), and several other churches, among which the Mariæ Kirke with its Romanesque nave is the earliest; a hospital, diocesan college, naval academy, school of design and a theatre. An observatory and biological station are maintained. The museums are of great interest. The Vestlandske fishery and industrial museum also contains a picture gallery, and exhibition of the Bergen Art Union (*Kunstforening*). The Bergen museum contains antiquities and a natural history collection. The Hanseatic museum is housed in a carefully-preserved *gaard*, or store-house and offices of the Hanseatic League of German merchants, who inhabited the German quarter (Tydskenbyrggen) and were established here in great strength from 1445 to 1558 (when the Norwegians began to find their presence irksome), and brought much prosperity to the city in that period. The Bergenhus and Fredriksberg forts defend the north and south entrances of the harbour respectively. The first was originally built in the 13th century by King Haakon Haakonsson, and subsequently enlarged; and still bears marks of an English attack when a Dutch fleet was driven to shelter here in 1665. Near it are remains of another old fort, the Sverresborg. Electric trams ply in the principal streets.

Bergen is the birthplace of the poets Ludvig Holberg (1684-1754) and Johan Welhaven (1807-1873), of Johan Dahl the painter (1788-1857), of Ole Bull (1810-1880) and Edvard Grieg the musicians. There are statues to Holberg and Bull, and also to Christie, president of the Storting (parliament) in 1815 and 1818.

Bergen ranks first of the Norwegian ship-owning centres, having risen to this position from fifth in 1879. The trade, however, is exceeded by that of Christiania. The staple export trade is in fish and their products; other exports are butter, copper ore and hides. The principal imports are coal, machinery, salt, grain and provisions. The manufactures are not extensive, but the preparation of fish products, shipbuilding, weaving and distillery, with manufactures of paper, pottery, tobacco and ropes are carried on. Bergen is an important centre of the extensive tourist traffic of Norway. Regular steamers serve the port from Hull and Newcastle (about 40 hours), from Hamburg, and from all the Norwegian coast towns. Many local steamers penetrate the fjords, touching at every village and *gaard*. Bergen is the nearest port to the famous Hardanger fjord, and is the starting-point of a remarkable railway which runs through many tunnels and fine scenery towards Vossevangen or Voss. In 1896 a beginning was made with the continuation of this line through the mountains to connect with Christiania. In the first 50 m. from Voss the line ascends 4080 ft., passing through a tunnel 5796 yds. long.

Bergen (formerly Björgvin) was founded by King Olaf Kyrre in 1070-1075, and rapidly grew to importance, the Byfjord becoming the scene of several important engagements in the civil wars of subsequent centuries. The famous Hansa merchants maintained a failing position here till 1764. The town suffered frequently from fire, as in 1702 and 1855, and the broad open spaces (*Almenninge*) which interrupt the streets are intended as a safeguard against the spread of flames.

See Y. Nielsen, *Bergen fra die ældste tider indtil nutiden* (Christiania, 1877); H. Jager, *Bergen og Bergensene* (Bergen, 1889).

BERGEN-OP-ZOOM, a town in the province of North Brabant, Holland, situated on both sides of the small river Zoom, near its confluence with the East Scheldt, 3½ m. by rail E. by N. of Flushing. It is connected by steam tramway with Antwerp (20 m. S.) and with the islands of Tholen and Duiveland to the north-west. Pop. (1900) 13,663. The houses are well built, the market-places and squares handsome and spacious. It possesses a port and an arsenal, and contains a fine town hall, with portraits of the ancient margraves of Bergen-op-Zoom, a Latin school, and an academy of design and architecture. The remains of the old castle of the margraves have been converted into barracks. The tower is still standing and is remarkable for its increase in size as it rises, which causes it to rock in a strong wind. The church contains a monument to Lord Edward Bruce, killed in a duel with Sir Edward Sackville, afterwards earl of Dorset, in 1613. There are numerous tile-works and potteries of fine ware; and a considerable trade is carried on in anchovies and oysters caught in the Scheldt. A large sugar-beet industry has also sprung up here in modern times.

Bergen-op-Zoom is a very old town, but little is known of its early history beyond the fact that it was taken by the Normans in 880. In the 13th century it became the seat of Count Gerhard of Wesemael, who surrounded it with walls and built a castle. By the end of the 15th century it had become one of the most prosperous towns of Holland, on account of its fisheries and its cloth-trade. In 1576 the town joined the United Netherlands, and was shortly afterwards fortified. In 1588 it was successfully defended against the duke of Parma by an English and Dutch garrison commanded by Colonel Morgan, and in 1605 it was suddenly attacked by Du Terail. In 1622 the Spaniards, under Spinola, made another attempt to take the town, but were forced to abandon the enterprise after a siege of ten weeks and the loss of 1200 men. Towards the end of the 17th century the fortifications were greatly strengthened by Coehoorn, and in 1725 they were further extended. In 1747, however, the town was taken by the French, under Marshal Löwendahl, who surprised it by means of a subterranean passage. Restored at the end of the war, it was again taken by the French under Pichegru in 1795. The English, under Sir Thomas Graham, afterwards Lord Lynedoch, in March 1814 made an attempt to take it by a *coup de main*, but were driven back with great loss

by the French, who surrendered the place, however, by the treaty of peace in the following May.

The lordship of Bergen-op-Zoom appears, after the definite union of the Low Countries with the Empire in 924, as an hereditary fief of the Empire, and the succession of its lords may be traced from Henry (1098-1125), who also held Breda. In 1533 it was raised to a margraviate by the emperor Charles V., and was held by various families until in 1799 it passed, through the Sultzbach branch of the Wittelsbachs, to the royal house of Bavaria, by whom it was renounced in favour of the Batavian republic in 1801.

BERGERAC, a town of south-western France, capital of an arrondissement in the department of Dordogne, on the right bank of the Dordogne, 60 m. E. of Bordeaux on the railway to Cahors. Pop. (1906) 10,545; commune, 15,623. The river is rendered navigable by a large dam and crossed by a fine bridge which leads to the suburb of La Madeleine. Apart from a few old houses in the older quarter by the river, the town contains no monuments of antiquarian interest. There is a handsome modern church built in the middle of the 19th century. Bergerac is the seat of a sub-prefect and has tribunals of first instance and of commerce and a communal college. Wine of fine quality is grown in the district and is the chief source of the commerce of the town, which is mainly carried on with Libourne and Bordeaux. There is trade in grain, truffles, chestnuts, brandy and in the salmon of the Dordogne. The town has flour-mills, iron-works, tanneries, distilleries and nursery-gardens, and it has manufactures of casks and of vinegar. There are quarries of millstone in the vicinity. In the 16th century Bergerac was a very flourishing and populous place, but most of its inhabitants having embraced Calvinism it suffered greatly during the religious wars and by the revocation of the edict of Nantes (1685). It was in 1577 the scene of the signing of the sixth peace between the Catholics and Protestants. Its fortifications and citadel were demolished by Louis XIII. in 1621.

BERGHAUS, HEINRICH (1797-1884), German geographer, was born at Kleve on the 3rd of May 1797. He was trained as a surveyor, and after volunteering for active service under General Tauenzien in 1813, joined the staff of the Prussian trigonometrical survey in 1816. He carried on a geographical school at Potsdam in company with Heinrich Lange, August Petermann, and others, and long held the professorship of applied mathematics at the Bauakademie. But he is most famous in connexion with his cartographical work. His greatest achievement was the *Physikalischer Atlas* (Gotha, 1838-1848), in which work, as in others, his nephew HERMANN BERGHAUS (1828-1890) was associated with him. He had also a share in the re-issue of the great *Stieler Handatlas* (originally produced by Adolf Stieler in 1817-1823), and in the production of other atlases. His written works were numerous and important, including *Allgemeine Länder- und Völkerrunde* (Stuttgart, 1837-1840), *Grundriss der Geographie in fünf Büchern* (Berlin, 1842), *Die Völker des Erdballs* (Leipzig, 1845-1847), *Was man von der Erde weiss* (Berlin, 1856-1860), and various large works on Germany. In 1863 he published *Briefwechsel mit Alexander von Humboldt* (Leipzig). He died at Stettin on the 17th of February 1884.

BERGK, THEODOR (1812-1881), German philologist, was born at Leipzig on the 22nd of May 1812. After studying at the university of his native town, where he profited by the instruction of G. Hermann, he was appointed in 1835 to the lectureship in Latin at the orphan school at Halle. After holding posts at Neustrelitz, Berlin and Cassel, he succeeded (1842) K. F. Hermann as professor of classical literature at Marburg. In 1852 he went to Freiburg, and in 1857 returned to Halle. In 1868 he resigned his professorship, and settled down to study and literary work in Bonn. He died on the 20th of July 1881, at Ragatz in Switzerland, where he had gone for the benefit of his health. Bergk's literary activity was very great, but his reputation mainly rests upon his work in connexion with Greek literature and the Greek lyric poets. His *Poetae Lyrici Graeci* (1843, 5th ed. 1900, &c.) and *Griechische Literaturgeschichte* (1872-1887, completed by G. Hinrichs and R. Peppmüller) are standard

works. He also edited Anacreon (1834), the fragments of Aristophanes (1840), Aristophanes (3rd ed., 1872), Sophocles (2nd ed., 1868), a lyric anthology (4th ed., 1890). Among his other works may be mentioned: *Augusti Kerum a se gestarum Index* (1873); *Inscriptionen römischer Schleudergeschosse* (1876); *Zur Geschichte und Topographie der Rheinlande in römischer Zeit* (1882); *Beiträge zur römischen Chronologie* (1884).

His *Kleine philologische Schriften* have been edited by Peppmüller (1884-1886), and contain, in addition to a complete list of his writings, a sketch of his life. See Sandys, *Hist. of Class. Schol.* iii. 146 (1908).

BERGLER, STEPHAN, German classical scholar, was born about 1680 at Kronstadt in Transylvania. The date of his death is uncertain. After studying at Leipzig, he went to Amsterdam, where he edited Homer and the *Onomasticon* of Julius Pollux for Wetzstein the publisher. Subsequently, at Hamburg, he assisted the great bibliographer J. A. Fabricius in the production of his *Bibliotheca Graeca* and his edition of Sextus Empiricus. He finally found a permanent post in Bucharest as secretary to the prince of Walachia, Alexander Mavrocordat, whose work *Περὶ τῶν καθήκοντων* (*De Officiis*) he had previously translated for Fritzsche, the Leipzig bookseller, by whom he had been employed as proof-reader and literary hack. In the prince's library Bergler discovered the introduction and the first three chapters of Eusebius's *Demonstratio Evangelica*. He died in Bucharest, and was buried at his patron's expense. According to another account, Bergler, finding himself without means, drifted to Constantinople, where he came to an untoward end (c. 1740). He is said to have become a convert to Islam; this report was probably a mistake for the undisputed fact that he embraced Roman Catholicism. Bergler led a wild and irregular life, and offended his friends and made many enemies by his dissipated habits and cynical disposition. In addition to writing numerous articles for the Leipzig *Acta Eruditorum*, Bergler edited the editio princeps of the Byzantine historiographer Genesius (1733), and the letters of Alciphron (1715), in which seventy-five hitherto unpublished letters were for the first time included.

BERGMAN, TORBERN OLOF (1735-1784), Swedish chemist and naturalist, was born at Katrineberg, Västergötland, Sweden, on the 20th of March 1735. At the age of seventeen he entered the university of Upsala. His father wished him to read either law or divinity, while he himself was anxious to study mathematics and natural science; in the effort to please both himself and his father he overworked himself and injured his health. During a period of enforced abstinence from study, he amused himself with field botany and entomology, to such good purpose that he was able to send Linnaeus specimens of several new kinds of insects, and in 1756 he succeeded in proving that, contrary to the opinion of that naturalist, *Coccus aquaticus* was really the ovum of a kind of leech. In 1758, having returned to Upsala, he graduated there, and soon afterwards began to teach mathematics and physics at the university, publishing papers on the rainbow, the aurora, the pyroelectric phenomena of tourmaline, &c. In 1767 Johann Gottschalk Wallerius (1709-1785) having resigned the chair of chemistry and mineralogy, Bergman determined to become a candidate, though he had paid no particular attention to chemistry. As evidence of his attainments he produced a memoir on the manufacture of alum, but his pretensions were strongly opposed, and it was only through the influence of Gustavus III., then crown prince and chancellor of the university, that he gained the appointment, which he held till the end of his life. He died at Medevi on Lake Vetter on the 8th of July 1784. Bergman's most important chemical paper is his *Essay on Elective Attractions* (1775), a study of chemical affinity. In methods of chemical analysis, both by the blowpipe and in the wet way, he effected many improvements, and he made considerable contributions to mineralogical and geological chemistry, and to crystallography. He also made observations of the transit of Venus in 1761, and published a *Physical Description of the Earth* in 1766.

His works were collected and printed in 6 vols. as *Opuscula Physica et Chemica* in 1779-1790, and were translated into French, German and English.

BERGSCHRUND (Ger. *Berg*, mountain; *Schrund*, cleft or crevice), a gaping crack in the upper part of a snowfield or glacier, near the rock wall, caused by the glacier moving bodily away from the mountain-side as the mass settles downwards. The crack is roughly parallel to the rock-face of the upper edge of the glacier basin, and extends downwards to the solid rock beneath the glacier where at the bottom of this huge crevasse there are blocks of ice, and large pieces of rock torn off by the lower portion of the glacier from the rock wall and floor.

BERGUES, a town of northern France, in the department of Nord, at the junction of the canal of the Colme with canals to Dunkirk and Furnes (in Belgium), 5 m. S.S.E. of Dunkirk by rail. Pop. (1906) 4499. The town has a belfry, the finest in French Flanders, dating from the middle of the 16th century and restored in the 19th century. The church of St Martin is a brick building of the 17th century in the Gothic style with a modern façade. The town hall, dating from the latter half of the 19th century, contains a municipal library and an interesting collection of pictures. The industries of the town include brewing and malting, and the manufacture of brushes and oil.

BERHAMPUR, a town of British India, the headquarters of Murshidabad district, in Bengal, situated on the left bank of the river Bhagirathi, 5 m. below Murshidabad city. Pop. (1901) 24,397. Berhampur was fixed upon after the battle of Plassey as the site of the chief military station for Bengal; and a huge square of brick barracks was erected in 1767, at a cost of £300,000. Here was committed the first overt act of the mutiny, on the 25th of February 1857. No troops are now stationed here, and the barracks have been utilized for a jail, a lunatic asylum and other civic buildings. A college, founded by government in 1853, was made over in 1888 to a local committee, being mainly supported by the munificence of the rani Svarnamayi. In the municipality of Berhampur is included the remnant of the once important, but now utterly decayed city of Cossimbazar (*q.v.*).

BERHAMPUR, a town of British India, in the presidency of Madras. Pop. (1901) 25,729. It is the headquarters of Ganjam district, and is situated about 9 m. from the sea. It is a station on the East Coast railway, which connects Calcutta with Madras. Berhampur had a military cantonment, sometimes distinguished as Bampur, containing a wing of a native regiment; but the troops have been transferred elsewhere. There is some weaving of silk cloth, and export trade in sugar. The college, originally founded by government, is now maintained by the raja of Kallikota. Silk-weaving and sugar-manufacture are carried on.

BERI-BERI, a tropical disease of the greatest antiquity, and known to the Chinese from an extremely remote period. It gradually dropped out of sight of European practice, until an epidemic in Brazil in 1863, and the opening up of Japan, where it prevailed extensively, and the investigations into the disease in Borneo, brought it again into notice. The researches of Scheube and Bälz in Japan, and of Pekelharing and Winkler in the Dutch Indies, led to its description as a form of peripheral neuritis (see also NEUROPATHOLOGY). The geographical distribution of beri-beri is between 45° N. and 35° S. It occurs in Japan, Korea and on the Chinese coast south of Shanghai; in Manila, Tongking, Cochin China, Burma, Singapore, Malacca, Java and the neighbouring islands; also in Ceylon, Mauritius, Madagascar and the east coast of Africa. In the Western hemisphere it is found in Cuba, Panama, Venezuela and South America. It has been carried in ships to Australia and to England. Sir P. Manson has "known it originate in the port of London in the crews of ships which had been in harbour for several months," and he suggests that when peripheral neuritis occurs in epidemic form it is probably beri-beri.

The cause is believed by many authorities to be an infective agent of a parasitic nature, but attempts to identify it have not been entirely successful. It is "not obviously communicable from person to person" (Manson), but may be carried from

place to place. It clings to particular localities, buildings and ships, in which it has a great tendency to occur; for instance, it is apt to break out again and again on certain vessels trading to the East. It haunts low-lying districts along the coast, and the banks of rivers. Moisture and high temperature are required to develop its activity, which is further favoured by bad ventilation, overcrowding and underfeeding. Another strongly supported hypothesis is that it is caused by unwholesome diet. The experience of the Japanese navy points strongly in this direction. Beri-beri was constantly prevalent among the sailors until 1884, when the dietary was changed. A striking and progressive diminution at once set in, and continued until the disease wholly disappeared. Major Ronald Ross suggested that beri-beri was really arsenical poisoning. A natural surmise is that it is due to some fungoid growth affecting grain, such as rice, maize or some other food stuff commonly used in the localities where beri-beri is prevalent, and among sailors. The conditions under which their food is kept on board certain ships might explain the tendency of the disease to haunt particular vessels. Dr Charles Hose is the principal advocate of this theory. Having had much experience of beri-beri in Sarawak, he associates it with the eating of mouldy rice, a germ in the fungus constituting the poison. But Dr Hose's views as to rice have been strongly opposed by Dr Hamilton Wright and others.

The most susceptible age is from 15 to 40. Children under 15 and persons over 50 or 60 are rarely attacked. Men are more liable than women. Race has no influence. Previous attacks powerfully predispose.

The symptoms are mainly those of peripheral neuritis with special implication of the phrenic and the pneumogastric nerves. There is usually a premonitory stage, in which the patient is languid, easily tired, depressed, and complains of numbness, stiffness and cramps in the legs; the ankles are oedematous and the face is puffy. After this, pronounced symptoms set in rapidly, the patient suddenly loses power in the legs and is hardly able to walk or stand; this paresis is accompanied by partial anaesthesia, and by burning or tingling sensations in the feet, legs and arms; the finger-tips are numb, the calf muscles tender. These symptoms increase; the oedema becomes general, the paralysis more marked; breathlessness and palpitation come on in paroxysms; the urine is greatly diminished. There is no fever, unless it is of an incidental character, and no brain symptoms arise. The patient may remain in this condition for several days or weeks, when the symptoms begin to subside. On the disappearance of the oedema the muscles of the leg are found to be atrophied. Recovery is very slow, but appears to be certain when once begun. When death occurs it is usually from syncope through over-distension of the heart. The mortality varies greatly, from 2 to 50% of the cases. The disease is said to be extremely fatal among the Malays. After death there is found to be serious infiltration into all the tissues, and often haemorrhages into the muscles and nerves, but the most important lesion is degeneration of the peripheral nerves. The cerebrospinal centres are not affected, and the degeneration of the nerve-fibres is more marked the farther they are from the point of origin. The implication of the phrenic and pneumogastric nerves, and of the cardiac plexus, accounts for the breathlessness, palpitation and heart failure; that of the vaso-motor system for the oedema and diminution of urine, and that of the spinal nerves for the loss of power, the impairment and perversion of sensation. According as these nerves are variously affected the symptoms will be modified, some being more prominent in one case and some in another.

AUTHORITIES.—See Sir Patrick Manson, *Tropical Diseases* (new ed., 1907); for a critical discussion of the subject, see *The Times* of 28th October 1905; a full bibliography is given by Manson in Allbutt and Rolleston's *System of Medicine* (1907).

BERING (BERING), VITUS (1680—1741). Danish navigator, was born in 1680 at Horsens. In 1703 he entered the Russian navy, and served in the Swedish war. A series of explorations of the north coast of Asia, the outcome of a far-reaching plan devised by Peter the Great, led up to Bering's first voyage to

Kamchatka. In 1725, under the auspices of the Russian government, he went overland to Okhotsk, crossed to Kamchatka, and built the ship "Gabriel." In her he pushed northward in 1728, until he could no longer observe any extension of the land to the north, or its appearance to the east. In the following year he made an abortive search for land eastward, and in 1730 returned to St Petersburg. He was subsequently commissioned to a further expedition, and in 1740 established the settlement of Petropavlovsk in Kamchatka; and built two vessels, the "St Peter" and "St Paul," in which in 1741 he led an expedition towards America. A storm separated the ships, but Bering sighted the southern coast of Alaska, and a landing was made at Kayak Island or in the vicinity. Bering was forced by adverse conditions to return quickly, and discovered some of the Aleutian Islands on his way back. He was afflicted with scurvy, and became too ill to command his ships, which were at last driven to refuge on an uninhabited island in the south-west of Bering Sea, where Bering himself and many of his company died. This island bears his name. Bering died on the 19th of December 1741. It was long before the value of his work was recognized; but Captain Cook was able to prove his accuracy as an observer.

See G. F. Müller, *Sammlung russischer Geschichten*, vol. iii. (St Petersburg, 1758); P. Lauridsen, *Bering og de Russiske Opdagelsesrejser* (Copenhagen, 1885).

BERING ISLAND, SEA and STRAIT. These take their name from the explorer Vitus Bering. The island (also called Avatcha), which was the scene of his death, lies in the south-western part of the sea, off the coast of Kamchatka, being one of the Commander or Komandor group, belonging to Russia.



It is 69 m. long and 28 m. in extreme breadth; the area is 615 sq. m. The extreme elevation is about 300 ft. The smaller Copper Island lies near. The islands are treeless, and the climate is severe, but there is a population of about 650. Bering Sea is the northward continuation of the Pacific Ocean, from which it is demarcated by the long chain of the Aleutian Islands. It is bounded on the east by Alaska, and on the west by the Siberian and Kamchatkan coast. Its area is estimated at 870,000 sq. m. In the north and east it has numerous islands (St Lawrence, St Matthew, Nunivak and the Pribiloff group) and is shallow; in the south-west it reaches depths over 2000 fathoms. The seal-fisheries are important (see *BERING SEA ARBITRATION*). The sea is connected with the Arctic Ocean northward by Bering Strait, at the narrowest part of which East Cape (Deshnev) in Asia approaches within about 56 m. of Cape Prince of Wales on the American shore. North and south of these points the coasts on both sides rapidly diverge. They are steep and rocky, and considerably indented. The extreme depth of the strait approaches 50 fathoms, and it contains two small islands known as the Diomed Islands. These granite domes, lacking a harbour, lie about a mile apart, and the boundary line between the possessions of Russia and the United States passes between them. They are occupied by a small tribe of about 80 Eskimo, who have

from early times plied the trade of middlemen between Asia and America. They call the western island Nunárbook and the eastern Ignálook. Haze and fogs greatly prevail in the strait, which is never free of ice.

The earliest names associated with the exploration of Bering Strait are those of Russians seeking to extend their trading facilities. Isai Ignatiev made a voyage eastward from the Kolyma river in 1646, and Simon Dezhnev in 1648 followed his route and prolonged it, rounding the East or Dezhnev Cape, and entering the strait. The post of Anadyrsk was founded on the river Anadyr, and overland communications were gradually opened up. A Russian named Popov first learnt a rumour of the existence of islands east of Cape Dezhnev, and of the proximity of America, and presently there followed the explorations of Vitus Bering. In 1731 the navigator Michael Gvosdev was driven by storm from a point north of Cape Dezhnev to within sight of the Alaskan coast, which he followed for two days. Under Bering on his last voyage (1741) was Commander Chirikov of the "St Paul," and after being separated from his leader during foggy weather this officer reached the Alaskan coast and explored a considerable stretch of it. Lieutenant Waxel and William Steller, a naturalist, left at the head of Bering's party after his death, by their researches laid the foundation of the important fur trade of these waters. The Aleutian Islands gradually became known in the pursuit of this trade, through Michael Novodiskov (1743) and his successors, and it was not until Captain James Cook, working from the south, explored the sea and strait in 1778 that the tide of discovery set farther northward.

BERING SEA ARBITRATION. The important fishery dispute between Great Britain and the United States, which was closed by this arbitration, arose in the following circumstances.

In the year 1867 the United States government had purchased from Russia all her territorial rights in Alaska and the adjacent islands. The boundary between the two powers, as laid down by the treaty for purchase, was a line drawn from the middle of Bering Strait south-west to a point midway between the Aleutian and Komandorski Islands dividing Bering Sea into two parts, of which the larger was on the American side of this line. This portion included the Pribiloff Islands, which are the principal breeding-grounds of the seals frequenting those seas. By certain acts of congress, passed between 1868 and 1873, the killing of seals was prohibited upon the islands of the Pribiloff group and in "the waters adjacent thereto" except upon certain specified conditions. No definition of the meaning of the words "adjacent waters" was given in the act. In 1870 the exclusive rights of killing seals upon these islands was leased by the United States to the Alaska Commercial Company, upon conditions limiting the numbers to be taken annually, and otherwise providing for their protection. As early as 1872 the operations of foreign sealers attracted the attention of the United States government, but any precautions then taken seem to have been directed against the capture of seals on their way through the passages between the Aleutian Islands, and no claim to jurisdiction beyond the three-mile limit appears to have been put forward. On the 12th of March 1881, however, the acting secretary of the United States treasury, in answer to a letter asking for an interpretation of the words "waters adjacent thereto" in the acts of 1868 and 1873, stated that all the waters east of the boundary line were considered to be within the waters of Alaska territory. In March 1886 this letter was communicated to the San Francisco customs by Mr Daniel Manning, secretary of the treasury, for publication. In the same summer three British sealers, the "Carolena," "Onward" and "Thornton," were captured by an American revenue cutter 60 m. from land. They were condemned by the district judge on the express ground that they had been sealing within the limits of Alaska territory. Diplomatic representations followed, and an order for release was issued, but in 1887 further captures were made and were judicially supported upon the same grounds. The respective positions taken up by the two govern-

ments in the controversy which ensued may be thus indicated. The United States claimed as a matter of right an exclusive jurisdiction over the sealing industry in Bering Sea; they also contended that the protection of the fur seal was, upon grounds both of morality and interest, an international duty, and should be secured by international arrangement. The British government repudiated the claim of right, but were willing to negotiate upon the question of international regulation. Between 1887 and 1890 negotiations were carried on between Russia, Great Britain and the United States with a view to a joint convention. Unfortunately the parties were unable to agree as to the principles upon which regulation should be based. The negotiations were wrecked upon the question of pelagic sealing. The only seal nurseries were upon the Pribiloff Islands, which belonged to the United States, and the Komandorski group, which belonged to Russia. Consequently to prohibit pelagic sealing would have been to exclude Canada from the industry. The United States, nevertheless, insisted that such prohibition was indispensable on the grounds—(1) that pelagic sealing involved the destruction of breeding stock, because it was practically impossible to distinguish between the male and female seal when in the water; (2) that it was unnecessarily wasteful, inasmuch as a large proportion of the seals so killed were lost. On the other hand, it was contended by Great Britain that in all known cases the extermination of seals had been the result of operations upon land, and had never been caused by sealing exclusively pelagic. The negotiations came to nothing, and the United States fell back upon their claim of right. In June 1890 it was reported that certain American revenue cutters had been ordered to proceed to Bering Sea. Sir Julian Pausanefote, the British ambassador at Washington, having failed to obtain an assurance that British vessels would not be interfered with, laid a formal protest before the United States government.

Thereupon followed a diplomatic controversy, in the course of which the United States developed the contentions which were afterwards laid before the tribunal of arbitration. The claim that Bering Sea was *mare clausum* was abandoned, but it was asserted that Russia had formerly exercised therein rights of exclusive jurisdiction which had passed to the United States, and they relied *inter alia* upon the ukase of 1821, by which foreign vessels had been forbidden to approach within 100 Italian miles of the coasts of Russian America. It was pointed out by Great Britain that this ukase had been the subject of protest both by Great Britain and the United States, and that by treaties similar in their terms, made between Russia and each of the protesting powers, Russia had agreed that their subjects should not be troubled or molested in navigating or fishing in any part of the Pacific Ocean. The American answer was that the Pacific Ocean did not include Bering Sea. They also claimed an interest in the fur seals, involving the right to protect them outside the three-mile limit. In August 1890 Lord Salisbury proposed that the question at issue should be submitted to arbitration. This was ultimately assented to by the secretary of state, James Gillespie Blaine, on the understanding that certain specific points, which he indicated, should be laid before the arbitrators. On the 29th of February 1892 a definitive treaty was signed at Washington. Each power was to name two arbitrators, and the president of the French Republic, the king of Italy, the king of Norway and Sweden were each to name one. The points submitted were as follows:—(1) What exclusive jurisdiction in the sea now known as Bering Sea, and what exclusive rights in the seal fisheries therein, did Russia assert and exercise prior to and up to the time of the cession of Alaska to the United States? (2) How far were her claims of jurisdiction as to the seal fisheries recognized and conceded by Great Britain? (3) Was the body of water now known as Bering Sea included in the phrase "Pacific Ocean," as used in the treaty of 1825 between Great Britain and Russia, and what rights, if any, in Bering Sea were held exclusively exercised by Russia after the said treaty? (4) Did not all the rights of Russia as to jurisdiction and as to the seal fisheries in Bering Sea east of the water boundary, in the treaty between the United States and Russia of the 30th or

March 1867, pass unimpaired to the United States under that treaty? (5) Had the United States any and what right of protection over, or property in, the fur seals frequenting the islands of Bering Sea when such seals are found outside the three-mile limit? In the event of a determination in favour of Great Britain the arbitrators were to determine what concurrent regulations were necessary for the preservation of the seals, and a joint commission was to be appointed by the two powers to assist them in the investigation of the facts of seal life. The question of damages was reserved for further discussion, but either party was to be at liberty to submit any question of fact to the arbitrators, and to ask for a finding thereon. The tribunal was to sit at Paris. The treaty was approved by the Senate on the 20th of March 1892, and ratified by the president on the 22nd of April.

The United States appointed as arbitrator Mr John M. Harlan, a justice of the Supreme Court, and Mr John T. Morgan, a member of the Senate. The British arbitrators were Lord Hannen and Sir John Thompson. The neutral arbitrators were the baron de Courcel, the marquis Visconti Venosta, and Mr Gregers Gram, appointed respectively by the president of the French Republic, the king of Italy, and the king of Norway and Sweden. The sittings of the tribunal began in February and ended in August 1893. The main interest of the proceedings lies in the second of the two claims put forward on behalf of the United States. This claim cannot easily be stated in language of precision; it is indicated rather than formulated in the last of the five points specially submitted by the treaty. But its general character may be gathered from the arguments addressed to the tribunal. It was suggested that the seals had some of the characteristics of the domestic animals, and could therefore be the subject of something in the nature of a right of property. They were so far amenable to human control that it was possible to take their increase without destroying the stock. Sealing upon land was legitimate sealing; the United States being the owners of the land, the industry was a trust vested in them for the benefit of mankind. On the other hand, pelagic sealing, being a method of promiscuous slaughter, was illegitimate; it was *contra bonos mores* and analogous to piracy. Consequently the United States claimed a right to restrain such practices, both as proprietors of the seals and as proprietors and trustees of the legitimate industry. It is obvious that such a right was a novelty hitherto unrecognized by any system of law. Mr J. C. Carter, therefore, as counsel for the United States, submitted a theory of international jurisprudence which was equally novel. He argued that the determination of the tribunal must be grounded upon "the principles of right," that "by the rule or principle of right was meant a moral rule dictated by the general standard of justice upon which civilized nations are agreed, that this international standard of justice is but another name for international law, that the particular recognized rules were but cases of the application of a more general rule, and that where the particular rules were silent the general rule applied." The practical result of giving effect to this contention would be that an international tribunal could make new law and apply it retrospectively. Mr Carter's contention was successfully combated by Sir Charles Russell, the leading counsel for Great Britain.

The award, which was signed and published on the 15th of August 1893, was in favour of Great Britain on all points. The question of damages, which had been reserved, was ultimately settled by a mixed commission appointed by the two powers in February 1896, the total amount awarded to the British sealers being \$473,151.26. (M. H. C.)

BERIOT, CHARLES AUGUSTE DE (1800—1870), Belgian violinist and composer. Although not definitely a pupil of Viotti or Baillet he was much influenced by both. He was very successful in his concert tours, and held appointments at the courts of Belgium and France. From 1843 to 1852 he was violin professor at the Brussels conservatoire. Then his eyesight began to fail, and in 1858 he became blind. His compositions are still often played, and are good, clean displays of technique.

BERJA, a town of southern Spain, in the province of Almería; on the south-eastern slope of the Sierra de Gádor, 10 m. N.E. of Adra by road. Pop. (1900) 13,224. Despite the lack of a railway Berja has a considerable trade. Lead is obtained among the mountains, and the more sheltered valleys produce grain, wine, oil, fruit and esparto grass. These, with the paper, linen and cotton goods manufactured locally in small quantities, are exported from Adra.

BERKA, a town and watering-place of Germany, in the grand-duchy of Saxe-Weimar, on the Ilm and the Weimar-Kranichfeld railway, 8 m. S. of Weimar. Pop. 2300. It has sulphur baths, which are largely frequented in the summer. Berka was once celebrated for its Cistercian nunnery, founded in 1251. Two m. down the Ilm is the curious castle of Burgfarth, partly hewn out of the solid rock.

BERKELEY, the name of an ancient English family remarkable for its long tenure of the feudal castle built by the water of Severn upon the lands from which the family takes its name. It traces an undoubted descent from Robert (d. 1170) son of Harding. Old pedigree-makers from the 14th century onward have made of Harding a younger son of a king of Denmark and a companion of the Conqueror, while modern historians assert his identity with one Harding who, although an English thane, is recorded by Domesday Book in 1086 as a great landowner in Somerset. This Harding the thane was son of Einod or Alnod, who is recognized as Eadnoth the Staller, slain in beating off the sons of Harold when they attacked his county. But if Harding the Berkeley ancestor be the Harding who, as the queen's butler, witnesses King Edward's Waltham charter of 1062, his dates seem strangely apart from those of Robert his son, dead a hundred and eight years later. Of Robert fitz Harding we know that he was a Bristol man whose wealth and importance were probably increased by the trade of the port. A partisan of Henry, son of the empress, that prince before his accession to the throne granted him, by his charter at Bristol in the earlier half of 1153, the Gloucestershire manor of Bitton, and a hundred librates of land in the manor of Berkeley, Henry agreeing to strengthen the castle of Berkeley, which was evidently already in Robert's hands. In his rhymed chronicle Robert of Gloucester tells how—

"A bourgeois at Bristowe—Robert Harding
Vor gret tresour and riches—so wel was mid the king
That he gat him and is cis—the noble baronie
That so riche is of Berke—mid al the seignorie."

Later in the same year the duke of Normandy granted to Robert fitz Harding Berkeley manor and the appurtenant district called "Berkeleahernesse," to hold in fee by the service of one knight or at a rent of 100 s. Being at Berkeley, the duke confirmed to Robert a grant of Bedminster made by Robert, earl of Gloucester, and in the first year of his reign as king of England he confirmed his own earlier grant of the Berkeley manor. About this time Robert, who had founded St Augustine's Priory in Bristol, gave to the Black Canons there the five churches in Berkeley and Berkeley Herness. In their priory church he was buried in 1170, Berkeley descending to his son and heir Maurice.

Berkeley had already given a surname to an earlier family sprung from Roger, his Domesday tenant, whose descendants seem to have been ousted by the partisan of the Angevin. But if there had been a feud between the families it was ended by a double alliance, a covenant having been made at Bristol about November 1153 in the presence of Henry, duke of Normandy, whereby Maurice, son of Robert fitz Harding, was to marry the daughter of Roger of Berkeley, Roger's own son Roger marrying the daughter of Robert. In his certificate of 1166 Robert tells the king that, although he owes the service of five knights for Berkeley, Roger of Berkeley still holds certain lands of the honour for which he does no service to Robert. This elder line of Berkeley survived for more than two centuries on their lands of Dursley and Cumberley, but after his father's death Maurice, son of Robert, is styled Maurice of Berkeley. Robert of Berkeley, the eldest son of Maurice, paid in 1190 the vast sum of £1000 for livery of his great inheritance, but, rising with the rebellious

barons against King John, his castle was taken into the king's hands. Seizin, however, was granted in 1220 to Thomas his brother and heir, but the estate was again forfeit in the next generation for a new defection, although the wind of the royal displeasure was tempered by the fact that Isabel de Creoun, wife of Maurice, lord of Berkeley, was the king's near kinswoman. Thomas, son of Maurice, was allowed to succeed his father in the lands, and, having a writ of summons to parliament in 1295, he is reckoned the first hereditary baron of the line.

Even in the age of chivalry the lords of Berkeley were notable warriors. Thomas, who as a lad had ridden on the barons' side at Evesham, followed the king's wars for half a century of his long life, flying his banner at Falkirk and at Bannockburn, in which fight he was taken by the Scots. His seal of arms is among those attached to the famous letter of remonstrance addressed by the barons of England to Pope Boniface VIII. Maurice, his son, joined the confederation against the two Despencers, and lay in prison at Wallingford until his death in 1326, the queen's party gaining the upper hand too late to release him. But as the queen passed by Berkeley on her way to seize Bristol, she gave back the castle, which had been kept by the younger Despencer, to Thomas, the prisoner's heir, who, with Sir John Mautravers, soon received in his hold the deposed king brought thither secretly. The chroniclers agree that Thomas of Berkeley had no part in the murder of the king, whom he treated kindly. It was when Thomas was away from the castle that Mautravers and Gournay made an end of their charge. Through the providence of this Thomas the Berkeley estates were saved to the male line of his house, a fine levied in the twenty-third year of Edward III. so settling them. Thomas of Berkeley fought at Crecy and Calais, bringing six knights and thirty-two squires to the siege in his train, with thirty mounted archers and two hundred men on foot. His son and heir-apparent, Maurice of Berkeley, was the hero of a misadventure recorded by Froissart, who tells how a young English knight, displaying his banner for the first time on the day of Poitiers, rode after a flying Picard squire, by whom he was grievously wounded and held to ransom. Froissart errs in describing this knight as Thomas lord of Berkeley, for the covenant made in 1360 for the release of Maurice is still among the Berkeley muniments, the ransom being stated at £1080.

Being by his mother a nephew of Roger Mortimer, earl of March, the paramour of Queen Isabel, Maurice Berkeley married Elizabeth, daughter of Hugh Despenser, the younger of Edward II.'s favourites and the intruder in Berkeley Castle. With his son and heir Thomas of Berkeley, one of the commissioners of parliament for the deposing of Richard II. and a warden of the Welsh marches who harried Owen of Glendower, the direct male line of Robert fitz Harding failed, and but for the settlement of the estates Berkeley would have passed from the family. On this Thomas's death in 1417 Elizabeth, his daughter and heir, and her husband, Richard Beauchamp, earl of Warwick, the famous traveller, statesman and joustier, seized Berkeley Castle. Earl and countess only withdrew after James Berkeley, the nephew and heir male, had livery of his lands by the purchased aid of Humphrey of Gloucester. But the Beauchamps returned more than once to vain attacks on the stout walls of Berkeley, and a quarrel of two generations ended with the pitched battle of Nibley Green. Fought between the retainers of William, Lord Berkeley, son of James, and those who followed Thomas Talbot, Viscount Lisle, grandson of the illustrious Talbot and great-grandson of the countess of Warwick, this was the last private battle on English ground between two feudal lords. Young Lisle was shot under the beaver by an arrow, and the feud ended with his death, all claims of his widow being settled with an annuity of £100. Bitter as was the long quarrel, it kept the Berkeleys from casting their interest into the Wars of the Roses, in which most of their fellows of the ancient baronage sank and disappeared.

The victorious Lord Berkeley, whose children died young, was on ill terms with his next brother, and made havoc of the great

Berkeley estates by grants to the Crown and the royal house, for which he was rewarded with certain empty titles. Edward IV. gave him a viscount's patent in 1481, and Richard III. created him earl of Nottingham in 1483. His complacency extending to the new dynasty, Henry VII. made him earl marshal in 1485 and marquis of Berkeley in 1487. For this last patent he, by a settlement following a recovery suffered, gave the king and his heirs male Berkeley Castle and all that remained to him of his ancestors' lands, enjoying for his two remaining years a bare life interest. At his death in 1491 the king took possession, bringing his queen with him on a visit to Berkeley.

Here follows a curious chapter of the history of the Berkeley peerage. When Thomas, Lord Berkeley, died in 1417, it might have been presumed that his dignity would descend to his heir, the countess of Warwick. Nevertheless, his nephew and heir male was summoned as a baron from 1421, apparently by reason of his tenure of the castle and its lands. When the marquis of Berkeley was dead without surviving issue, the castle having passed to the crown, Maurice, the brother and heir, had no summons. Yet this Maurice's son, another Maurice, had a summons as a baron, although not "with the room in the parliament chamber that the lords of Berkeley had of old time." The old precedence was restored when Thomas, brother and heir of this baron, was summoned. This Thomas, who had a command at Flodden, held his ancestors' castle as constable for the king. A final remainder under the marquis's settlement brought back castle and lands on the failure in 1553 of the heirs male of the body of Henry VII., and Henry, Lord Berkeley, had special livery of them in his minority. Yet although seized of the castle he took a lower seat in the parliament house than did his grandfather who was not so seized, being given place after Abergavenny, Audley and Strange.

By these things we may see that peerage law in old time rested upon the pleasure of the sovereign and upon no ascertained and unvarying custom. Of the power behind that pleasure this Henry, Lord Berkeley, had one sharp reminder. He was, like most of his line, a keen sportsman, and, returning to Berkeley to find that a royal visit had made great slaughter among his deer, he showed his resentment by disparking Berkeley Park. Thereat Queen Elizabeth sent him a warning in round Tudor fashion. Let him beware, she wrote, for the earl of Leicester coveted the castle by the Severn.

At the Restoration, George, Lord Berkeley, who had been one of the commissioners to invite Charles II.'s return from the Hague, petitioned for a higher place in parliament, claiming a barony by right of tenure before 1205, but his claim was silenced by his advancement on September 11, 1679, to be viscount of Dursley and earl of Berkeley. James, the 3rd earl, an active sea captain who was all but lost in company with Sir Cloudesley Shovel, became knight of the Garter and lord high admiral and commander-in-chief in the Channel, he and his house being loyal supporters of the Hanoverian dynasty.

The last and most curious chapter of the history of the Berkeley honours was opened by Frederick Augustus, the 5th earl of Berkeley (1745-1810). This peer married at Lambeth, on the 16th of May 1766, one Mary Cole, the daughter of a small tradesman at Wotton-under-Edge, with whom he had already lived for several years, several children having been born to them. In order to legitimize the issue born before the marriage, the earl in 1801 made declaration of an earlier marriage contracted privately at Berkeley in 1785. On his death in 1811 the validity of this alleged marriage was tested by the committee of privileges of the House of Lords, and it was shown without doubt that the evidence for it, a parish register entry, was a forgery.

Under the will of his father, Colonel William Berkeley, the eldest illegitimate son, had the castle and estates, and on the failure of his claim to the earldom he demanded a writ of summons as a baron by reason of his tenure of the castle. No judgment was given in the matter, the king in council having declared in 1660 that baronies by tenure were "not in being and so not fit to be revived." But Colonel Berkeley's political influence afterwards procured him (1831) a peerage as Lord Segrave of

Berkeley, and ten years later an earldom with the title of Fitzhardinge. He died without issue in 1857. His brother, Sir Maurice Fitzhardinge Berkeley, who succeeded to Berkeley under the terms of the 5th earl's will, revived the claims, and was likewise given a new barony (1861) as Lord Fitzhardinge, a title in which he was succeeded by two of his sons, the 3rd baron (b. 1830) being in 1909 owner of the Berkeley and Cranford estates. The earldom of Berkeley was never assumed by the eldest legitimate son of the 5th earl, and was in 1909 enjoyed by Randal Thomas Mowbray Berkeley, 8th earl, grandson of admiral Sir George Cranford Berkeley, second son of the 4th earl. In 1837 Mrs Milman (d. 1890), daughter and heir of Thomas Moreton Fitzhardinge Berkeley, 6th earl *de jure*, was declared by letters patent under the great seal to have succeeded to the ancient barony of Berkeley created by the writ of 1421; and she was succeeded by her daughter.

Many branches have been thrown out by this family during its many centuries of existence. Of these the most important descended from Maurice of Berkeley, the baron who died in Wallingford hold in 1326. His second son Maurice was ancestor of the Berkeleys of Stoke Giffard, whose descendant, Norborne Berkeley, claimed the barony of Botetourt and had a summons in 1764, dying without issue in 1770. Sir Maurice Berkeley of Bruton, a cadet of Stoke Giffard, was forefather of the Viscounts Fitzhardinge, the Lords Berkeley of Stratton (1658-1773) and the earls of Falmouth, all extinct, the Berkeleys of Stratton bequeathing their great London estate, including Berkeley Square and Stratton Street, to the main line. Edward Berkeley of Pylle in Somerset, head of a cadet line of the Bruton family, married Philippa Speke, whose mother was Joan, daughter of Sir John Portman of Orchard Portman, baronet. His grandson William, on succeeding to the Orchard Portman and Bryanston estates, took the additional name of Portman, and from him come the Viscounts Portman of Bryanston (1873). From James, Lord Berkeley, who died in 1463, descended Rowland Berkeley, a clothier of Worcester, who bought the estates of Spetchley. Rowland's second son, Sir Robert Berkeley, the king's bench justice who supported the imposition of ship-money, was ancestor of the Berkeleys of Spetchley, now the only branch of the house among untitled squires.

See John Smyth's *Lives of the Berkeleys*, compiled c. 1618, edited by Sir John Maclean (1883-1885); J. H. Round's introduction to the Somerset Domesday, V.C.H. series; G. E. C. (okayue)'s *Complete Peerage*; Jaycey's *Descriptive Catalogue of the Charters and Muniments at Berkeley Castle* (1892); *Dictionary of National Biography*; *Transactions of Bristol and Gloucestershire Archaeological Society*, 3 vols., viii., xlv., et passim; *The Red Book of the Exchequer*, Chronicles of Roger of Wendover, Matthew Paris, Adam of Murimuth, Robert of Gloucester, Henry of Huntingdon, &c. (Rolls Series); British Museum Charters, &c. (O. Ba.)

BERKELEY, GEORGE (1685-1753), Irish bishop and philosopher, the eldest son of William Berkeley (an officer of customs who had, it seems, come to Ireland in the suite of Lord Berkeley of Stratton, lord lieutenant, 1670-1672, to whom he was related), was born on the 12th of March 1685, in a cottage near Dysert Castle, Thomastown, Ireland. He passed from the school at Kilkenny to Trinity College, Dublin (1700), where, owing to the peculiar subtlety of his mind and his determination to accept no doctrine on the evidence of authority or convention, he left the beaten track of study and was regarded by some as a dunce, by others as a genius. During his career at Dublin the works of Descartes and Newton were superseding the older text-books, and the doctrines of Locke's *Essay* were eagerly discussed. Thus he "entered on an atmosphere which was beginning to be charged with the elements of reaction against traditional scholasticism in physics and in metaphysics" (A. C. Fraser). He became a fellow in 1707. His interest in philosophy led him to take a prominent share in the foundation of a society for discussing the new doctrines, and is further shown by his *Common Place Book*, one of the most valuable autobiographical records in existence, which throws much light on the growth of his ideas, and enables us to understand the significance of his early writings. We find here the consciousness of creative thought focused in a new principle which is to revolutionize speculative science.

There is no sign of any intimate knowledge of ancient or scholastic thought; to the doctrines of Spinoza, Leibnitz, Malebranche, Norris, the attitude is one of indifference or lack of appreciation, but the influence of Descartes and specially of Locke is evident throughout. The new principle (nowhere in the *Common Place Book* explicitly stated) may be expressed in the proposition that no existence is conceivable—and therefore possible—which is not either conscious spirit or the ideas (*i.e.* objects) of which such spirit is conscious. In the language of a later period this principle may be expressed as the absolute synthesis of subject and object; no object exists apart from Mind. Mind is, therefore, prior both in thought and in existence, if for the moment we assume the popular distinction. Berkeley thus diverted philosophy from its beaten track of discussion as to the meaning of matter, substance, cause, and preferred to ask first whether these have any significance apart from the conscious spirit. In the pursuit of this inquiry he rashly invaded other departments of science, and much of the *Common Place Book* is occupied with a polemic, as vigorous as it is ignorant, against the fundamental conceptions of the infinitesimal calculus.

In 1707 Berkeley published two short mathematical tracts; in 1709, in his *New Theory of Vision*, he applied his new principle for the first time, and in the following year stated it fully in the *Principles of Human Knowledge*. In these works he attacked the existing theories of externality which to the unphilosophical mind is proved by visual evidence. He maintained that visual consciousness is merely a system of arbitrary signs which symbolize for us certain actual or possible tactual experience—in other words a purely conventional language.

The contents of the visual and the tactual consciousness have no element in common. The visible and visual signs are definitely connected with tactual experiences, and the association between them, which has grown up in our minds through custom or habit, rests upon, or is guaranteed by, the constant conjunction of the two by the will of the Universal Mind. But this synthesis is not brought forward prominently by Berkeley. It was evident that a similar analysis might have been applied to tactual consciousness which does not give externality in its deepest significance any more than the visual; but with deliberate purpose Berkeley at first drew out only one side of his argument. In the *Principles of Human Knowledge*, externality in its ultimate sense as independence of all mind is considered. Matter, as an abstract, unperceived substance or cause, is shown to be impossible, an unreal conception; true substance is affirmed to be conscious spirit, true causality the free activity of such a spirit, while physical substantiality and causality are held to be merely arbitrary, though constant, relations among phenomena connected subjectively by suggestion or association, objectively in the Universal Mind. In ultimate analysis, then, nature is conscious experience, and forms the sign or symbol of a divine, universal intelligence and will.

In 1711 Berkeley delivered his *Discourse on Passive Obedience*, in which he deduces moral rules from the intention of God to promote the general happiness, thus working out a theological utilitarianism, which may be compared with the later positions of Austin and J. S. Mill. From 1707 he had been engaged as college tutor; in 1712 he paid a short visit to England, and in April 1713 he was presented by Swift at court. His abilities, his courtesy and his upright character made him a universal favourite. While in London he published his *Dialogues* (1713), a more popular exposition of his new theory; for exquisite facility of style these are among the finest philosophical writings in the English language. In November he became chaplain to Lord Peterborough, whom he accompanied on the continent, returning in August 1714. He travelled again in 1715-1720 as tutor to the only son of Dr St George Ashe (?1658-1718, bishop successively of Cloyne, Clogher and Derry). In 1721, during the disturbed state of social relations consequent on the bursting of the South Sea bubble, he published an *Essay towards preventing the Ruin of Great Britain*, which shows the intense interest he took in practical affairs. In the same year he returned to Ireland as chaplain to the duke of Grafton, and was made

divinity lecturer and university preacher. In 1722 he was appointed to the deanery of Dromore, a post which seems to have entailed no duties, as we find him holding the offices of Hebrew lecturer and senior proctor at the university. The following year Miss Vanhomrigh, Swift's Vanessa, left him half her property. It would appear that he had only met her once at dinner. In 1724 he was nominated to the rich deanery of Derry, but had hardly been appointed before he was using every effort to resign it in order to devote himself to his scheme of founding a college in the Bermudas, and extending its benefits to the Americans. With infinite exertion he succeeded in obtaining from government a promise of £20,000, and after four years spent in preparation, sailed in September 1728, accompanied by some friends and by his wife, daughter of Judge Forster, whom he had married in the preceding month. Three years of quiet retirement and study were spent in Rhode Island, but it gradually became apparent that government would never hand over the promised grant, and Berkeley was compelled to give up his cherished plan. Soon after his return he published the fruits of his studies in *Alciphron, or the Minute Philosopher* (1733), a finely written work in the form of dialogue, critically examining the various forms of free-thinking in the age, and bringing forward in antithesis to them his own theory, which shows all nature to be the language of God. In 1734 he was raised to the bishopric of Cloyne. The same year, in his *Analyst*, he attacked the higher mathematics as leading to freethinking; this involved him in a hot controversy. The *Querist*, a practical work in the form of questions on what would now be called social or economical philosophy, appeared in three parts, 1735, 1736, 1737. In 1744 was published the *Siris*, partly occasioned by the controversy as to the efficacy of tar-water in cases of small-pox, but rising far above the circumstance from which it took its rise, and revealing hidden depths in the Berkeleyan metaphysics. In 1751 his eldest son died, and in 1752 he removed with his family to Oxford for the sake of his son George, who was studying there. He died suddenly in the midst of his family on the 14th of January 1753, and was buried in Christ Church, Oxford.

In the philosophies of Descartes and Locke a large share of attention had been directed to the idea of matter, which was held to be the abstract, unperceived background of real experience, and was supposed to give rise to our ideas of external things through its action on the sentient mind. Knowledge being limited to the ideas produced could never extend to the unperceived matter, or substance, or cause which produced them, and it became a problem for speculative science to determine the grounds for the very belief in its existence. Philosophy seemed about to end in scepticism or in materialism. Now Berkeley put this whole problem in a new light by pointing out a preliminary question. Before we deduce results from such abstract ideas as cause, substance, matter, we must ask what in reality they mean—what is the actual content of consciousness which corresponds to these words? Do not all these ideas, when held to represent something which exists absolutely apart from all knowledge of it, involve a contradiction? In putting this question, not less than in answering it, consists Berkeley's originality as a philosopher. The essence of the answer is that the universe is inconceivable apart from mind—that existence, as such, denotes conscious spirits and the objects of consciousness. Matter and external things, in so far as they are thought to have an existence beyond the circle of consciousness, are impossible, inconceivable. External things are things known to us in immediate perception. To this conclusion Berkeley seems, in the first place, to have been led by the train of reflection that naturally conducts to subjective or egoistic idealism. It is impossible to overstep the limits of self-consciousness; whatever words I use, whatever notions I have, must refer to and find their meaning in facts of consciousness. But this is by no means the whole or even the principal part of Berkeley's philosophy; it is essentially a theory of causality, and this is brought out gradually under the pressure of difficulties in the first solution of the early problem. To merely subjective idealism, sense percepts differ from ideas of imagination in degree, none in kind; but to belong to the individual, as Berkeley holds, however, the difference is fundamental; sense ideas are not due to our own activity; they must therefore be produced by some other will—by the divine intelligence. Sense experience is thus the constant action upon our minds of supreme active intellect, and is not the consequence of dead inert matter. It might appear, therefore, that sensible things had an objective existence in the mind of God; that an idea so soon as it passes out of our consciousness passes into that of God. This is an interpretation, frequently and not without some justice, put upon Berkeley's own expression. But it is not a

satisfactory account of his theory. Berkeley is compelled to see that an immediate perception is not a *thing*, and that what we consider permanent or substantial is not a sensation but a group of qualities, which in ultimate analysis means sensations either immediately felt or such as our experience has taught us would be felt in conjunction with these. Our belief in the reality of a thing may therefore be said to mean assurance that this association in our minds between actual and possible sensations is somehow guaranteed. Further, Berkeley's own theory would never permit him to speak of possible sensations, meaning by that the ideas of sensations called up to our minds by present experience. He could never have held that these afforded any explanation of the permanent existence of real objects. His theory is quite distinct from this, which really amounts to nothing more than subjective idealism. External things are produced by the will of the divine intelligence; they are caused, and caused in a regular order; there exists in the divine mind archetypes, of which sense experience may be said to be the realization in our finite minds. Our belief in the permanence of something which corresponds to the association in our minds of actual and possible sensations means belief in the orderliness of nature; and that is merely assurance that the universe is pervaded and regulated by mind. Physical science is occupied in endeavouring to decipher the divine ideas which find realization in our limited experience, in trying to interpret the divine language of which natural things are the words and letters, and in striving to bring human conceptions into harmony with the divine thoughts. Instead, therefore, of fate or necessity, or matter, or the unknown, a living, active mind is looked upon as the centre and spring of the universe, and this is the essence of the Berkeleyan metaphysics.

The deeper aspects of Berkeley's new thought have been almost universally neglected or misunderstood. Of his spiritual empiricism one side only has been accepted by later thinkers, and looked upon as the whole. The subjective mechanism of association which with Berkeley is but part of the true explanation, and is dependent on the objective realization in the divine mind, has been received as in itself a satisfactory theory. *Sunt Cogitationes* has been regarded by thinkers who profess themselves Berkeleyans as the one proposition warranted by consciousness; the empiricism of his philosophy has been eagerly welcomed, while the spiritual intuition, without which the whole system is meaningless, has been cast aside. For this he is himself in no small measure to blame. The deeper spiritual intuition, present from the first, was only brought into clear relief in order to meet difficulties in the earlier statements, and the extension of the intuition itself beyond the limits of our own consciousness, which completely removes his position from mere subjectivism, rests on foundations uncritically assumed, and at first sight irreconcilable with certain positions of his system. The necessity and universality of the judgments of causality and substantiality are taken for granted; and there is no investigation of the place held by these notions in the mental constitution. The relation between the divine mind and finite intelligence, at first thought as that of agent and recipient, is complicated and obscured when the necessity for explaining the permanence of real things comes forward. The divine archetypes, according to which sensible experience is regulated and in which it finds its real objectivity, are different in kind from mere sense ideas, and the question then arises whether in these we have not again the "things as they are," which Berkeley at first so contemptuously dismissed. He leaves it undetermined whether or not our knowledge of sense things, which is never entirely presentative, involves some reference to the objects of course of nature or thoughts of the divine mind. And if so what is the nature of the notions necessarily implied in the simplest knowledge of a thing, as distinct from mere sense feeling? That in knowing objects certain thoughts are implied which are not presentations or their copies is at times dimly seen by Berkeley himself; but he was content to propound a question with regard to those notions, and to look upon them as merely Locke's ideas of relation. Such ideas of relation are in truth the stumbling-block in Locke's philosophy, and Berkeley's empiricism is equally far from accounting for them.

With all these defects, however, Berkeley's new conception marks a distinct stage of progress in human thought. His true place in the history of speculation may be seen from the simple observation that the difficulties or obscurities in his scheme are really the points on which later philosophy has turned. He once for all lifted the problem of metaphysics to a higher level, and, in conjunction with his successor, Hume, determined the form into which later metaphysical questions have been thrown.

BIBLIOGRAPHY.—The standard edition of Berkeley's Works is that of A. Campbell Fraser in 4 vols. (i.-iii. *Works*; iv. *Life, Letters and Discourses*) published by the Clarendon Press in 1871. This edition, revised throughout and largely re-written, was re-published by the same author (1901). Another complete edition edited by G. Sampson, with a biographical sketch by A. J. Balfour, and a useful bibliographical summary, appeared in 1897-1898. Prof. Fraser also published an excellent volume of selections (5th ed., 1899), and a short general account in a volume on Berkeley in the *Blackwood Philos. Class.* For Berkeley's theory of vision see manuals of psychology (e.g. G. F. Stout, Wm. James); for his ethical views H. Sidgwick, *Hist. of Ethics* (5th ed., 1902); A. Bain, *Mental and*

Moral Science (1872). See also Sir L. Stephen, *English Thought in the 18th Century* (3rd ed., 1902); J. S. Mill's *Disquisitions*, vols. ii, and iv.; T. Huxley, *Critiques and Addresses*, pp. 220 seq.; G. S. Fullerton, *System of Metaphysics* (New York, 1904); John Watson, *Outline of Philos.* (New York, 1898); J. McCosh, *Locke's Theory of Knowledge* (1884); T. Lorenz, *Ein Beitrag zur Lebensgeschichte G. Berkeleys* (1900) and *Weitere Beiträge z. Leb. G. B.'s* (1901); histories of modern philosophy generally.

(K. Ad.; J. M. M.)

BERKELEY, MILES JOSEPH (1803–1889), English botanist, was born on the 1st of April 1803, at Biggin Hall, Northamptonshire, and educated at Rugby and Christ's College, Cambridge, of which he became an honorary fellow. Taking holy orders, he became incumbent of Apethorpe in 1837, and vicar of Sibbertoft, near Market Harborough, in 1868. He acquired an enthusiastic love of cryptogamic botany in his early years, and soon was recognized as the leading British authority on fungi and plant pathology. He was especially famous as a systematist in mycology, some 6000 species of fungi being credited to him, but his *Introduction to Cryptogamic Botany*, published in 1857, and his papers on "Vegetable Pathology" in the *Gardener's Chronicle* in 1854 and onwards, show that he had a very broad grasp of the whole domain of physiology and morphology as understood in those days. Moreover, it should be pointed out that Berkeley began his work as a field naturalist and collector, his earliest objects of study having been the mollusca and other branches of zoology, as testified by his papers in the *Zoological Journal* and the *Magazine of Natural History*, between 1828 and 1836. As a microscopist he was an assiduous and accurate worker, as is shown by his numerous drawings of the smaller algae and fungi, and his admirable dissections of mosses and hepaticae. His investigations on the potato murrain, caused by *Phytophthora infestans*, on the grape mildew, to which he gave the name *Oidium Tuckeri*, and on the pathogenic fungi of wheat rust, hop mildew, and various diseases of cabbage, pears, coffee, onions, tomatoes, &c., were important in results bearing on the life-history of these pests, at a time when very little was known of such matters, and must always be considered in any historical account of the remarkable advances in the biology of these organisms which were made between 1850 and 1880; and when it is remembered that this work was done without any of the modern appliances or training of a properly equipped laboratory, the real significance of Berkeley's pioneer work becomes apparent. It is as the founder of British mycology, however, that his name will live in the history of botany, and his most important work is contained in the account of native British fungi in Sir W. Hooker's *British Flora* (1836), in his *Introduction to Cryptogamic Botany* (1857), and in his *Outlines of British Fungology* (1860). His magnificent herbarium at Kew, which contains over 9000 specimens, and is enriched by numerous notes and sketches, forms one of the most important type series in the world. Berkeley died at Sibbertoft on the 30th of July 1889. He was a man of refined and courteous bearing, an accomplished classical student, with the simple and modest habits that befit a man of true learning.

A list of his publications will be found in the *Catalogue of Scientific Papers* of the Royal Society, and sketches of his life in *Proc. Roy. Soc.*, 1890, 47, 9, by Sir Joseph Hooker, and *Annals of Botany*, 1897, 11, by Sir W. T. Thickett-Dwyer. (H. M. W.)

BERKELEY, SIR WILLIAM (c. 1608–1677), British colonial governor in America, was born in or near London, England, about 1608, the youngest son of Sir Maurice Berkeley, an original member of the London Company of 1606, and brother of John, first Lord Berkeley of Stratton, one of the proprietors of the Carolinas. He graduated at Oxford in 1629, and in 1632 was appointed one of the royal commissioners for Canada, in which office he won the personal favour of Charles I., who appointed him a gentleman of the privy chamber. During this period he tried his hand at literary work, producing among other things a tragi-comedy entitled *The Lost Lady* (1638). In August 1641 he was appointed governor of Virginia, but did not take up his duties until the following year. His first term as governor, during which he seems to have been extremely popular with the majority of the colonists, was notable principally for his

religious intolerance and his expulsion of the Puritans, who were in a great minority. During the Civil War in England he remained loyal to the king, and offered an asylum in Virginia to Charles II. and the loyalists. On the arrival of a parliamentary fleet in 1652, however, he retired from office and spent the following years quietly on his plantation. On the death, in 1660, of Samuel Matthews, the last parliamentary governor, he was chosen governor by the Virginia assembly, and was soon recommissioned by Charles II. His natural arrogance and tyranny seems to have increased with years, and the second period of his governorship was a stormy one. Serious frontier warfare with the Indians was followed (1676) by Bacon's Rebellion (see VIRGINIA), brought on by Berkeley's misrule, and during its course all his worst traits became evident. His cruelty and barbarity in punishing the rebels did not meet with the approval of Charles II., who is said to have remarked that "the old fool has put to death more people in that naked country than I did here for the murder of my father." Berkeley was called to England in 1677 ostensibly to report on the condition of affairs in the colony, and a lieutenant-governor (Herbert Jeffreys) was put in his place. Berkeley sailed in May, but died soon after his arrival, at Twickenham, and was buried there on the 13th of July 1677. In addition to the play mentioned he wrote *A Discourse and View of Virginia* (London, 1663).

BERKELEY, a city of Alameda county, California, U.S.A., on the E. shore of San Francisco Bay, named after Bishop Berkeley on account of his line "Westward the course of empire takes its way." Pop. (1890) 5101; (1900) 13,214, of whom 3216 were foreign-born; (1910) 40,434. It is served by the Southern Pacific and the Santa Fé railway systems, both transcontinental; and is connected by electric lines (and ferry) with San Francisco, and by five electric lines with Oakland. Its attractive situation and pleasant outlooks have made it a favourite residential suburb of San Francisco, which lies at a distance of 7 m. across the bay. Berkeley is the seat of the California state university (see CALIFORNIA, UNIVERSITY OF), opened in 1873; the inter-related Berkeley Bible Seminary (1896, Disciples of Christ); Pacific Theological Seminary (established in 1866 at Oakland, in 1901 at Berkeley, Congregational); Seminary of the Pacific Coast Baptist Theological Union, and Unitarian Theological School—all associated with the University of California; and the state institution for the deaf, dumb and blind. The site of Berkeley was a farming region until its selection for the home of the university. Berkeley was incorporated as a town in 1878.

BERKELEY, a market town of Gloucestershire, England, near the river Severn, in that portion of its valley known as the Vale of Berkeley, on a branch from the Midland railway. Pop. (1901) 774. It is pleasantly situated on a gentle eminence, in a rich pastoral vale to which it gives name, celebrated for its dairies, producing the famous cheese known as "double Gloucester." The town has a handsome church (Early English and Decorated), a grammar school, and some trade in coal, timber, malt and cheese. Berkeley was the birthplace of Dr Edward Jenner (1749), who is buried in the church. Berkeley Castle, on an eminence south-east of the town, is one of the noblest baronial castles existing in England, and one of the few inhabited. The Berkeley Ship Canal connects Gloucester with docks at Sharpness, avoiding the difficult navigation of the upper part of the Severn estuary.

The manor of Berkeley gives its name to the noble family of Berkeley (q.v.). According to tradition, a nunnery to which the manor belonged existed here before the Conquest, and Earl Godwin, by bringing about its dissolution, obtained the manor. All that is certainly known, however, is that in Domesday the manor is assigned to one Roger, who took his surname from it. His descendants seem to have been ousted from their possessions during the 12th century by Robert fitz Harding, an Angevin partisan, who already held the castle when, in 1153, Henry, duke of Normandy (who became King Henry II. in the following year), granted him the manor. Under an agreement made in the same year, Maurice, son of Robert fitz Harding, married a daughter

of Roger of Berkeley. Their descendants styled themselves of Berkeley, and in 1200 the town was confirmed to Robert of Berkeley with toll, soc, sac, &c., and a market on whatever day of the week he chose to hold it. This charter was confirmed to Thomas, Lord Berkeley, in 1330, and in 1395-1396 Lord Berkeley received a grant of another fair on the vigil and day of Holyrood. The descendants of the Berkeley family still hold the manor and town. Berkeley Castle was the scene of the death of Edward II. The king was at first entrusted to the care of Lord Berkeley, who, being considered too lenient, was obliged to give up his prisoner and castle to Sir John Mautravers and Thomas Gournay. The town has no charter, but is mentioned as a borough in 1284-1285. It was governed by a mayor and twelve aldermen, but by 1864 their privileges had become merely nominal, and the corporation was dissolved in 1885 under the Municipal Corporations Act. Berkeley was formerly noted for the manufacture of clothing, but the trade had decreased by the 16th century, for Leland, writing about 1520, says "the town of Berkeley is no great thing. . . . It hath very much occupied and yet somewhat doth clothing."

See John Fisher, *History of Berkeley* (1864).

BERKHAMPSTEAD (GREAT BERKHAMPSTEAD), a market town in the Watford parliamentary division of Hertfordshire, England, 28 m. N.W. from London by the London & North-Western railway. Pop. of urban district (1901) 5140. It lies pleasantly in the narrow well-wooded valley of the Bulbourne, and is close to the Grand Junction canal. The church of St Peter, a large cruciform structure, exhibits all the Gothic styles, and earlier fragments are traceable. There are several brasses of interest. The poet William Cowper was born in the rectory in 1731. The large grammar school is a foundation of 1541. Straw-plaiting and the manufacture of small wooden wares are the principal industries, and there are large chemical works. Of the castle earthworks and fragments of walls remain. The name of the town is Great Berkhamstead (or Berkhamsted), in distinction from Little Berkhamstead near Hatfield in this county.

Berkhamstead (Beorhamstede, Berchamstede) was undoubtedly of some importance in Saxon times since there were fifty-two burgesses there at the time of the Conquest. In 1156 Henry II. granted the men and merchants of the town the same laws and customs as they had in the time of Edward the Confessor, and that they should be quit of toll throughout England, Normandy, Aquitaine and Anjou. Berkhamstead rose to importance with its castle, which is said to have been built by Robert, count of Mortain, and when the castle fell into ruin after 1496 the town also began to decay. In 1618, however, the burgesses received an incorporation charter; but after the civil wars the corporate body began to fall through poverty, and in the 18th century had ceased to exist. The burgesses returned two members to parliament in 1320 and again in 1338 and 1341, but were never represented again. Before the 13th century the burgesses held a weekly market on Sunday and a yearly fair on St James's day, but in 1218 Henry III. altered the market day to Monday. Roofing tiles were manufactured in Berkhamstead as early as the 13th century, and in Elizabeth's reign the making of malt was the chief industry.

BERKSHIRE, THOMAS HOWARD, 1ST EARL OF (1587-1669), 2nd son of Thomas Howard, 1st earl of Suffolk and of Catherine, daughter of Sir Henry Knevet, Kt., widow of Richard Rich, was baptized on the 8th of October 1587. He succeeded to his mother's estate of Charlton in Wiltshire, was created K.B. in 1605, became master of the horse to Prince Charles, and was created Lord Howard of Charlton and Viscount Andover in 1622, K.G. in 1625, and earl of Berkshire in 1626. In 1634 he was chosen high steward of the university of Oxford. He was a commissioner for negotiating the treaty of Ripon in 1642, and accompanied the king to York in 1642. While attempting to execute the king's commission of array in Oxfordshire in August he was taken prisoner by Hampden at Wallington and imprisoned in the Tower, but after being censured by the Lords was liberated in September. In 1643 he was made governor of the prince of Wales, a post for which he was in no way fitted, and in which

he showed himself factious and obstructive. He accompanied the prince to Scilly and to Jersey, but on the latter's departure for France went to Holland. At the Restoration he was made a privy councillor and received rewards. He died on the 16th of July 1669, and was buried in Westminster Abbey. According to Clarendon "his affection for the crown was good; his interest and reputation less than anything but his understanding." He married Elizabeth, daughter and co-heir of William, earl of Exeter, by whom he had nine sons and four daughters. Of these Charles succeeded him as 2nd earl of Berkshire; Thomas succeeded the latter; and Philip was ancestor of John, 15th earl of Suffolk and 8th earl of Berkshire, and so of the later earls of Suffolk and Berkshire.

BERKSHIRE [abbreviated *Berks*, pronounced *Barkshire*], a southern county of England, bounded N. by Oxfordshire and Buckinghamshire, E. by Surrey, S. by Hampshire, W. by Wiltshire, and N.W. for a short distance by Gloucestershire. Its area is 721.9 sq. m. Its entire northern boundary is formed by the river Thames, in the basin of which practically the whole county is included. In the north-west a narrow and broken line of hills, pierced in the west by the Cole stream, which here forms the county boundary, extends past Faringdon and culminates in a height over 500 ft. at Cumnor Hurst, which, with Wytham Hill, fills a deep northward bend of the Thames, and overlooks the city of Oxford from the west. The range separates the Thames valley from the Vale of White Horse which is traversed by the small river Ock, and bounded on the south by a line of hills known as the White Horse Hills or Berkshire Downs, richly wooded along their base, and rising sharply to bare rounded summits. In White Horse Hill on the western confines of the county a height of 856 ft. is reached. The line of these hills is continued north-eastward by the Chiltern Hills in Oxfordshire, but a division between the two is made by the Thames in a narrow valley or gap at Goring. Southward the Downs are scored with deep narrow valleys, the chief of which are those of the Lambourn and the Pang. The last stream runs eastward directly to the Thames; but the Lambourn and others join the Kennet, which drains a beautiful sylvan valley to the Thames at Reading. Another line of downs closely confines the vale of Kennet on the south from Newbury upwards, and although the greater part of these does not fall within the county, their highest point, Inkpen Beacon (1011 ft.), does so. The Enborne stream, rising here, and flowing parallel to the Kennet until turning north to join it, is for a considerable distance the county boundary. Between Reading and Windsor the Thames makes a northward bend, past Henley and Marlow, in the form of three sides of a square. Within the bend slight hills border the river, but south of these, and in the Ludlow valley south of Reading, the county is low and flat. In the south-east of the county, however, there is a high sandy plateau, forming part of Bagshot Heath, over 400 ft. in elevation, and extending into Surrey. Fir-woods are characteristic of this district, and northward towards the Thames extends the royal park of Windsor, which is magnificently timbered. The proportion to the total area of the county which is under woods is, however, by no means so great as in the adjacent counties of Surrey and Hampshire. There is fine trout-fishing in the Kennet and some of its feeders.

Geology.—The dominant feature of the county, the Chiltern and White Horse Hills, owes its form to the Chalk, which spreads from Ashbury and Hungerford on the west to Henley and Maidenhead on the east. In the northern face of the escarpment we find the Lower Chalk with a hard bed, the Totternhoe Stone; on the southern slope lies the Chalk-with-Flints. At Kintbury it is quarried for the manufacture of whiting. At the foot of the Chalk escarpment is the Upper Greensand with a narrow crop towards the west which is broken up into patches eastwards. Looking northward from the Chalk hills, the low-lying ground is occupied successively by the Gault Clay, the Kimmeridge Clay, and finally by the Oxford Clay, which extends beyond the Thames into Oxfordshire. This low-lying tract is relieved by an elevated ridge of Corallian beds, between the Kimmeridge Clay and the Gault. It extends from near Farington past Abingdon

to Cumnor and Wytham Hill. At Faringdon there are some interesting gravels of Lower Greensand age, full of the fossil remains of sponges. South of the Chalk, the county is occupied by Eocene rocks, mottled clays, well exposed in the brickfields about Reading, and hence called the Reading beds. At Finchampton, Sunninghill and Ascot, these deposits are overlaid by the more sandy beds of the Bagshot series. Between the two last named formations is a broad outcrop of London Clay. Numerous outliers of Eocene rest on the Chalk beyond the main line of boundary. The Chalk of Inkpen Beacon is brought up to the south side of the Tertiary rocks by a syndinal fold; similarly, an anticline has brought up the small patch of Chalk in Windsor Park. Clay-with-Flints lies in patches and holes on the chalk, and flint gravels occur high up on either side of the Thames. Fairly thick beds of peat are found in the alluvium of the Kennet at Newbury.

Industries.—About seven-ninths of the total area is under cultivation; a large proportion of this being in permanent pasture; as much attention is paid to dairy-farming. Butter and cheese are largely produced, and the making of condensed milk is a branch of the industry. Many sheep are pastured on the Downs, important sheep-markets being held at the small town of East or Market Ilsey; and an excellent breed of pigs is named after the county. The parts about Faringdon are specially noted for them. Oats are the principal grain crop; although a considerable acreage is under wheat. Turnips and swedes are largely cultivated, and apples and cherries are grown. Besides the royal castle of Windsor, fine county seats are especially numerous.

The only manufacturing centre of first importance is Reading, which is principally famous for its biscuit factories. The manufacture of clothing and carpets is carried on at Abingdon; but a woollen industry introduced into the county as early as the Tudor period is long extinct. Engineering works and paper mills are established at various places; and boat-building is carried on at Reading and other riverside stations. There are extensive seed warehouses and testing grounds near Reading; and the Kennet and Windsor ales are in high repute. Whiting is manufactured from chalk at Kintbury on the Kennet.

Communications.—Communications are provided principally by the Great Western railway, the main line of which crosses the county from east to west by Maidenhead, Reading and Didcot. A branch line serves the Kennet valley from Reading; and the northern line of the company leaves the main line at Didcot, a branch from it serving Abingdon. The Basingstoke branch runs south from Reading, and lines serve Wallingford from Cholsey, and Faringdon from Uffington. Communication with the south of England is maintained by a joint line of the South Western and South Eastern & Chatham companies terminating at Reading, and there are branches of the Great Western and South Western systems to Windsor. The Lambourn valley light railway runs north-west to Lambourn from Newbury. Wide water-communications are afforded by the Thames, and the Kennet is in part canalized, to form the eastern portion of the Kennet and Avon canal system, connecting with the Bristol Avon above Bath.

Population and Administration.—The area of the ancient county is 462,208 acres; with a population in 1891 of 239,138, and in 1901 of 256,509. The area of the administrative county is 462,367 acres. The county contains twenty hundreds. The municipal boroughs are Abingdon (pop. 6480), Maidenhead (12,980), Newbury (11,061), Reading, the county town and a county borough (72,217), Wallingford (2808), Windsor or New Windsor (14,130), Wokingham (3551). Wantage (3766) is an urban district. Among lesser towns may be mentioned Faringdon in the north-west (2000), Hungerford on the Kennet (2000), and Lambourn in the valley of that name (2071), the villages of Bray (2078), Cookham (3874) and Tilehurst (2545), which, like others on the banks of the Thames, have grown into residential towns; and Sandhurst (2386). The county is in the Oxford circuit, and assizes are held at Reading. It has one court of quarter sessions, and is divided into twelve petty

sessional divisions. The boroughs of Abingdon, Newbury, Maidenhead, Reading, Wallingford and Windsor have separate commissions of the peace, and Abingdon, Newbury, Reading and Windsor have separate courts of quarter sessions. There are 108 civil parishes. Berkshire forms an archdeaconry in the diocese of Oxford; a small portion, however, falls within the diocese of Salisbury. There are 202 ecclesiastical parishes or districts, wholly or in part within the county. There are three parliamentary divisions, Northern or Abingdon, Southern or Newbury, and Eastern or Wokingham, each returning one member; while the parliamentary borough of Reading returns one member, and parts of the borough of Oxford and Windsor are included in the county. There are several important educational establishments in the county. Radley College near Abingdon, Wellington College near Sandhurst, and Bradfield College, at the village of that name, 8 m. west of Reading, are among the more important modern public schools for boys. Bradfield College was founded in 1850, and is well known for the realistic performances of classical Greek plays presented by the scholars in an open theatre designed for the purpose. Abingdon and Reading schools rank among the lesser public schools. At Reading is a university extension college, and in the south-east of the county is the Sandhurst Royal Military College.

History.—During the Heptarchy Berkshire formed part of the kingdom of Wessex, and interesting relics of Saxon occupation have been discovered in various parts of the county. Of these the most remarkable are the burial grounds at Long Wittenham and Frilford, and there is evidence that the Lambourn valley was occupied in early Saxon times. The cinerary urns found in Berkshire undoubtedly contain the ashes of the Anglians who came south under Penda in the 7th century. The fortification called Cherbury Castle, not far from Denchworth, is said to have been first made up by Canute.

At the time of the Norman invasion Berkshire formed part of the earldom of Harold, and supported him staunchly at the battle of Hastings. This loyalty was punished by very sweeping confiscations, and at the time of the Domesday survey no estates of any importance were in the hands of Englishmen. When Alfred divided the county into shires, this county received the name of Berrocscir, as Asser says, "from the wood of Berroc, where the box-tree grows most plentifully." At the time of the survey it comprised twenty-two hundreds; at the present day there are only twenty, of which eleven retain their ancient names. Many parishes have been transferred from one hundred to another, but the actual boundary of the county is practically unchanged. Part of the parishes of Shilton and Langford formed detached portions of the shire, until included in Oxfordshire in the reign of William IV. Portions of Combe and Shalbourne parishes have also been restored to Hampshire and Wiltshire respectively, while the Wiltshire portion of Hungerford has been transferred to Berkshire. The county was originally included in the see of Winchester, but in A.D. 900 it was removed to the newly-formed see of "Wiltshire," afterwards united with Sherborne. In 1075 the seat of the bishopric was removed to Salisbury, and in 1836 by an order in council Berkshire was transferred to the diocese of Oxford. The archdeaconry is of very early origin and is co-extensive with the county. Formerly it comprised four rural deaneries, but the number has lately been increased to nine. Much of the early history of the county is recorded in the *Chronicles* of the abbey of Abingdon, which at the time of the survey was second only to the crown in the extent and number of its possessions. The abbot also exercised considerable judicial and administrative powers, and his court was endowed with the privileges of the hundred court and was freed from liability to interference by the sheriff. Berkshire and Oxfordshire had a common sheriff until the reign of Elizabeth, and the shire court was held at Grauntport. The assizes were formerly held at Reading,

The derivation from Bihroci, a British tribe in the time of Caesar, which probably inhabited Surrey or Middlesex, seems philologically impossible.

Abingdon and Newbury, but are now held entirely at Reading.

At the time of the Domesday survey the chief lay-proprietor was Henry de Ferrers, ancestor of the earls of Derby, but it is remarkable that none of the great Berkshire estates has remained with the same family long. Thomas Fuller quaintly observes that "the lands of Berkshire are very skittish and apt to cast their owners." The De la Poles succeeded to large estates by a marriage with the heiress of Thomas Chaucer, son of the poet, but the family became extinct in the male line, and the estates were alienated. The same fate befell the estates of the Achards, the Fitzwarrens and later the families of Norris and Befils.

The natural advantages of this county have always encouraged agricultural rather than commercial pursuits. The soil is especially adapted for sheep-farming, and numerous documents testify to the importance and prosperity of the wool-trade in the 12th century. At first this trade was confined to the export of the raw material, but the reign of Edward III. saw the introduction of the clothing industry, for which the county afterwards became famous. This trade began to decline in the 17th century, and in 1641 the Berkshire clothiers complained of the deadness of their trade and the difficulty of getting ready money, attributing the same to delay in the execution of justice. The malting industry and the timber trade also flourished in the county until the 19th century. Agriculturally considered, the Vale of the White Horse is especially productive, and Camden speaks of the great crops of barley grown in the district.

Owing to its proximity to London, Berkshire has from early times been the scene of frequent military operations. The earliest recorded historical fact relating to the county is the occupation of the district between Wallingford and Ashbury by Offa in 758. In the 9th and 10th centuries the county was greatly impoverished by the ravages of the Danes, and in 871 the invaders were defeated by Æthelwulf at Englefield and again at Reading. During the disorders of Stephen's reign Wallingford was garrisoned for Matilda and was the scene of the final treaty in 1153. Meetings took place between John and his barons in 1213 at Wallingford and at Reading, and in 1216 Windsor was besieged by the barons. At the opening of the civil war of the 17th century, the sheriff, on behalf of the inhabitants of Berkshire, petitioned that the county might be put in a posture of defence, and here the royalists had some of their strongest garrisons. Reading endured a ten days' siege by the parliamentary forces in 1643, and Wallingford did not surrender until 1646. Newbury was the site of two battles in 1643 and 1644.

In 1295, Berkshire returned two members to parliament for the county and two for the borough of Reading. Later the boroughs of Newbury, Wallingford, Windsor and Abingdon secured representation, and from 1557 until the Reform Act of 1832 the county was represented by a total of ten members. By this act Abingdon and Wallingford were each deprived of a member, but the county returned three members instead of two. Since the Redistribution of Seats Act 1885 the county has returned three members for three divisions, and Windsor and Reading return one member each, the remaining boroughs having lost representation.

Antiquities.—The remains of two great Benedictine monasteries at Abingdon and Reading are scanty. The ecclesiastical architecture of the county is not remarkable, excepting a few individual churches. Thus for Norman work the churches of Shellingford and Cholsey may be noted, together with the very small chapel, of early date, at Upton near Didcot. The church of Blewbury in the same locality is in the main transitional Norman, and retains some of its original vaulting. Of Early English churches there are several good examples, notably at Uffington, with its unusual angular-headed windows, Buckland near Faringdon, and Wantage. The tower of St Helen's, Abingdon, well illustrates this period. The cruciform church of Shottesbrooke, with its central spire, is a beautiful and almost unaltered Decorated building; and St George's chapel in Windsor Castle is a superb specimen of Perpendicular work.

Apart from Windsor, Berkshire retains no remarkable medieval castles or mansions.

AUTHORITIES.—Chief of the older works are: Elias Ashmole, *Antiquities of Berkshire* (3 vols. 1719, 2nd ed., London, 1723; 3rd ed., Reading, 1736); D. and S. Lysons, *Magna Britannia*, vol. i. Other works are: Marshall, *Topographical and Statistical Details of the County of Berkshire* (London, 1830); Earl of Carnarvon, *Archæology of Berkshire* (London, 1859); C. King, *History of Berkshire* (London, 1887); Lowsley, *Glossary of Berkshire Words* (London, 1888), and *Index to Wills in the Court of the Archdeacon of Berkshire, 1508-1052* (Oxford, 1893); *Victoria County History, Berkshire*. See also *The Berks Archæological Society's Quarterly Journal*, and *Berkshire Notes and Queries*.

BÊRLAD, the capital of the department of Tutova, Rumania, on the river Bêlad, which waters the high plains of Eastern Moldavia. Pop. (1900) 24,484, about one-fourth of whom are Jews. At Bêlad the railway from Jassy diverges, one branch skirting the river Sereth, the other skirting the Pruth; both reunite at Galatz. Among a maze of narrow and winding streets Bêlad possesses a few good modern buildings, including a fine hospital, administered by the St Spiridon Foundation of Jassy. Bêlad has manufactures of soap and candles, and some trade in timber and farm-produce, while the annual horse-fairs are visited by dealers from all parts of the country. In the vicinity are traces of a Roman camp.

BERLICHINGEN, GOETZ or **GOTTFRIED VON** (1480-1562), German knight, was born at the castle of Jagsthausen now in Württemberg. In 1497 he entered the service of Frederick IV., margrave of Brandenburg-Ansbach, and in 1498 fought for the emperor Maximilian I. in Burgundy, Lorraine and Brabant, and next year in Switzerland. About 1500 he raised a company of freelances, and at their head took part in various private wars. In 1505, whilst assisting Albert IV., duke of Bavaria, at the siege of Landshut, his right hand was shot away, and an iron one was substituted which is still shown at Jagsthausen. In spite of this "Goetz with the iron hand" continued his feuds, their motive being mainly booty and ransom. In 1512 an attack near Forchheim on some merchants returning from the great fair at Leipzig, caused him to be put under the ban of the empire by Maximilian, and he was only released from this in 1514 upon a promise to pay 14,000 gulden. In 1516 he made a raid into Hesse and captured Philip IV., count of Waldeck, whom he compelled to pay a ransom of 8400 gold gulden, and in 1518 was again placed under the ban. He fought for Ulrich I., duke of Württemberg, when he was attacked by the Swabian League in 1519, and after a spirited resistance was compelled, through want of ammunition and provisions, to surrender the town of Möckmühl. In violation of the terms of the capitulation he was held prisoner, and handed over to the citizens of Heilbronn, but owing to the efforts of Sickingen and Georg von Frundsberg was released in 1522, upon paying 2000 gulden, and swearing not to take vengeance on the League. When the Peasants' War broke out in 1525 Goetz was compelled by the rebels of the Odenwald district to act as their leader. He accepted the position, according to his own account, partly because he had no choice, partly in the hope of curbing the excesses of the insurgents; but, finding himself in this respect powerless, after a month of nominal leadership, he took the first opportunity of escaping to his castle. For his part in the rebellion he was called to account before the diet of Speier, and on the 17th of October 1526 was acquitted by the imperial chamber. In spite of this the Swabian League seized the opportunity of paying off old scores against him. Lured to Augsburg, under promise of safe conduct, to clear himself of the charges made against him on behalf of the League, he was there treacherously seized on the 28th of November 1528, and kept a close prisoner for two years. In 1530 he was liberated on repeating his oath of 1522, and undertaking not to leave the neighbourhood of his castle of Hornberg on the Neckar. He appears to have remained there quietly until 1540 when the emperor Charles V. released him from his oath. In 1542 he fought against the Turks in Hungary, and in 1544 accompanied Charles when he invaded France. He returned to Hornberg, where he passed his time until his death on the 23rd of July 1562. He was twice married and left three daughters and seven

sons. The counts von Berlichingen-Rossach, of Helmstadt near Heidelberg, one of the two surviving branches of the family, are his descendants. The other branch, that of the Freiherrn von Berlichingen-Jagsthausen, is descended from Goetz's brother Hans. "Goetz von Berlichingen" is the title of Goethe's play, which, published in 1773, marked an epoch in the history of German drama (see GOETHE).

See R. Pallmann, *Der historische Goetz von Berlichingen* (Berlin, 1894); F. W. G. Graf von Berlichingen-Rossach, *Geschichte des Ritters Goetz von Berlichingen und seiner Familie* (Leipzig, 1861). Goetz's *Autobiography*, valuable as a record of his times, was first published by Pistorius at Nuremberg (1731), and again at Halle (1886).

BERLIN, ISAAH (1725-1799), an eminent rabbi of Breslau; he was the author of acute notes on the Talmud which had their influence in advancing the critical study of that work.

BERLIN, the largest city of the German empire, the capital of the kingdom of Prussia. It is the principal residence of the German emperor and king of Prussia, the seat of the imperial parliament (*Reichstag*) and the Prussian diet (*Landtag*) and of the state offices of the empire, except of the supreme court of justice (*Reichsgericht*), which is fixed at Leipzig. It lies in a flat, sandy plain, 110 ft. above sea-level, on both banks of the navigable Spree, which intersects it from S.E. to N.W. The highest elevation in the immediate neighbourhood is the Kreuzberg (200 ft.), a hill in the southern suburb of Schöneberg, which commands a fine view of the city. The situation of Berlin, midway between the Elbe and the Oder, with which rivers it is connected by a web of waterways, at the crossing of the main roads from Silesia and Poland to the North Sea ports and from Saxony, Bohemia and Thuringia to the Baltic, made it in medieval days a place of considerable commercial importance. In modern times the great network of railways, of which it is the centre and which mainly follow the lines of the old roads, further established its position. Almost equidistant from the remotest frontiers of Prussia, from north to south, and from east to west, 180 m. from Hamburg and 84 from Stettin, its situation, so far from being prejudicial to its growth and prosperity, as was formerly often asserted, has been, in fact, the principal determining factor in its rapid rise to the position of the greatest industrial and commercial city on the continent of Europe. In point of wealth and population it ranks immediately after London and Paris.

The boundaries of the city have not been essentially extended since 1860, and though large and important suburbs have crept up and practically merged with it, its administrative area remains unchanged. It occupies about 29 sq. m., and has a length from E. to W. of 6 and a breadth from N. to S. of 5½ m., contains nearly 1000 streets, has 87 squares and open spaces, 73 bridges and a population (1905) of 2,033,000 (including a garrison of about 22,000). If, however, the outer police district, known as "Greater Berlin," embracing an area of about 10 m. radius from the centre, be included, the population amounts to about 3¼ millions.

Berlin is essentially a modern city, the quaint two-storied houses, which formerly characterized it, having given place to palatial business blocks, which somewhat dwarf the streets and squares, which once had an air of stately spaciousness. The bustle of the modern commercial city has superseded the austere dignity of the old Prussian capital. Thus the stranger entering it for the first time will find little to remind him of its past history. The oldest part of Berlin, the city and Alt-Kölln, built along the arms of the Spree, is, together with that portion of the town lying immediately west, the centre of business activity. The west end and the south-west are the residential quarters, the north-west is largely occupied by academic, scientific and military institutions, the north is the seat of machinery works, the north-east of the woollen manufactures, the east and south-east of the dyeing, furniture and metal industries, while in the south are great barracks and railway works.

In 1870 Berlin was practically bounded on the south by the Landwehr Canal, but it has since extended far beyond, and the Tempelhofer Feld, where military reviews are held, then

practically in the country, is now surrounded by a dense belt of houses. The Landwehr Canal, leaving the Spree near the Schlesische Tor (gate), and rejoining it at Charlottenburg, after a course of 6 m., adds not a little to the charm of the southern and western districts, being flanked by fine boulevards and crossed by many handsome bridges. The object of this canal was to relieve the congestion of the water traffic in the heart of Berlin. It was superseded, however, in its turn by a new broad and deep canal opened in 1906, lying from 3 to 4 m. farther south. This, the Teltow Canal, leaves the Spree above Berlin at Köpenick, and running south of Rixdorf, Südende and Gross-Lichterfelde, enters the Havel at Teltow. This important engineering work was planned not only to afford a more convenient waterway between the upper Spree and the Havel (and thus to the Elbe), but was to remove from the city to its banks and vicinity those factories of which the noxious gases and other poisonous emanations were regarded as dangerous to the health of the community. A dislocation of the manufacturing factors has therefore been in progress, which with the creation of a "trans Tiberim" (as in ancient Rome) is, in many respects, altering the character and aspect of the metropolis.

The effect upon Berlin of the successful issue of the Franco-Prussian War of 1870-71 was electrical. The old Prussian capital girded itself at once to fulfil its new rôle. The concentration upon the city of a large garrison flushed with victory, and eager to emulate the vanquished foe in works of peace, and vie with them in luxury, was an incentive to Berliners to put forth all their energy. Besides the military, a tremendous immigration of civilian officials took place as the result of the new conditions, and, as accommodation was not readily available, rents rose to an enormous figure. Doubts were often expressed whether the capital would be able to bear the burden of empire, so enormous was the influx of new citizens. It is due to the magnificent services of the municipal council that the city was enabled to assimilate the hosts of newcomers, and it is to its indefatigable exertions that Berlin has in point of organization become the model city of Europe. In no other has public money been expended with such enlightened discretion, and in no other has the municipal system kept pace with such rapid growth and displayed greater resource in emergencies. In 1870 the sanitary conditions of Berlin were the worst of any city of Europe. It needed a Virchow to open the eyes of the municipality to the terrible waste of life such a state of things entailed. But open sewers, public pumps, cobble-paved roads, open market-places and overcrowded subterranean dwellings are now abolished. The city is excellently drained, well-paved, well-lighted and furnished with an abundant supply of filtered water, while the cellar dwellings have given place to light and airy tenements, and Berlin justly claims to rank among the cleanest and healthiest capitals in Europe. The year 1878 marks a fresh starting-point in the development of the city. In that year Berlin was the meeting-place of the congress which bears its name. The recognition of Germany as a leading factor in the world's counsels had been given, and the people of Berlin could indulge in the task of embellishing the capital in a manner befitting its position. From this time forward, state, municipal and private enterprise have worked hand in hand to make the capital cosmopolitan. The position it has at length attained is due not alone to the enterprise of its citizens and the municipality. The brilliancy of the court and the triumph of the sense of unity in the German nation over the particularism of the smaller German states have conducted more than all else to bring about this result. It has become the chief pleasure town of Germany; and though the standard of morality, owing to the enormous influx of people bent on amusement, has become lower, yet there is so much healthy, strenuous activity in intellectual life and commercial rivalry as to entitle it, despite many moral deficiencies, to be regarded as the centre of life and learning in Germany. Dr A. Shadwell (*Industrial Efficiency*, London, 1906) describes it as representing "the most complete application of science, order and method of public life," adding

"it is a marvel of civic administration, the most modern and most perfectly organized city that there is."

Streets.—The social and official life of the capital centres round Unter den Linden, which runs from the royal palace to the Brandenburg Tor. This street, one of the finest and most spacious in Europe, nearly a mile in length, its double avenue divided by a favourite promenade, planted with lime trees, presents Berlin life in all its varying aspects. Many historical events have taken place in this famous boulevard, notably the entry of the troops in 1871, and the funeral pageant of the emperor William I. South of Unter den Linden lies the Friedrichstadt, with its parallel lines of straight streets, including the Behren-strasse—the (seat of finance)—the Wilhelm-strasse, with the palace of the imperial chancellor, the British embassy, and many government offices—the official quarter of the capital—and the busy Leipzig-strasse, running from the Potsdamer-platz to the Dönhoff-platz. This great artery and Unter den Linden are crossed at right angles by the Friedrich-strasse, 2 m. long, flanked by attractive shops and restaurants, among them the beer palaces of the great breweries. In the city proper, the König-strasse and the Kaiser-Wilhelm-strasse, the latter a continuation of Unter den Linden, are the chief streets; while in the fashionable south-west quarter Viktoria-strasse, Bellevue-strasse, Potsdamer-strasse and Kurfürsten-strasse and the Kurfürstendamm are the most imposing. Among the most important public squares are the Opern-platz, around or near which stand the opera house, the royal library, the university and the armoury; the Gendarmenmarkt, with the royal theatre in its centre, the Schloss-platz; the Lustgarten, between the north side of the royal palace, the cathedral and the old and new museums; the Pariser-platz with the French embassy, at the Brandenburg Gate; the Königs-platz, with the column of Victory, the Reichstagsgebäude and the Bismarck and Moltke monuments; the Wilhelms-platz; the circular Belle-Alliance-platz, with a column commemorating the battle of Waterloo; and, in the western district, the spacious Lützow-platz.

Bridges.—Of the numerous bridges, the most remarkable are the Schloss-brücke, built after designs by Schinkel in 1822–1824, with eight colossal figures of white marble, representing ideal stages in a warrior's life, the work of Drake, Albert Wolf and other eminent sculptors; the Kurfürsten- or Lange-brücke, built 1692–1695, and restored in 1895, with an equestrian statue of the great elector, and the Kaiser-Wilhelm-brücke (1886–1889) connecting the Lustgarten with the Kaiser-Wilhelm-strasse in the inner town. In the modern residential quarter are the Potsdamer-Viktoria-brücke, which carries the traffic from two converging streets into the outer Potsdamer-strasse, and the Herkules-brücke connecting the Lützow-platz with the Tiergarten. The first three cross the Spree and the last two the Landwehr Canal.

Churches.—Berlin, until the last half of the 19th century, was in respect of its churches probably the poorest of the capitals of Christendom, and the number of worshippers on an average Sunday was then less than 2% of the population. The city now contains over a hundred places of worship, of which ten are Roman Catholic, and nine Jewish synagogues. Of the older Evangelical churches but four date from medieval days, and of them only the Marien-kirche, with a tomb of Field marshal O. C. von Sparr (1605–1665), and the Nikolai-kirche are particularly noteworthy. Of a later date, though of no great pretensions to architectural merit, are the Petri-kirche with a lofty spire, the Französische-kirche and the Neue-kirche with dome-capped towers, on the Gendarmenmarkt, and the round, Roman Catholic St Hedwigs-kirche behind the Opera-house. The Garrison church in the centre of the city, which was erected in 1722 and contained numerous historical trophies, was destroyed by fire in 1908. Of modern erections the new cathedral (*Dom*), on the Spree, which replaces the old building pulled down in 1893, stands first. It is a clumsy, though somewhat imposing edifice of sandstone in Italian Renaissance style, and has a dome rising, with the lantern, to a height of 380 ft. The Kaiser-Wilhelm-

Gedächtnis-kirche (in the suburb Charlottenburg) with a lofty spire, the Dankes-kirche (in commemoration of the emperor William I.'s escape from the hand of the assassin, Nobiling, in 1878) in Wedding, and the Kaiser-Friedrich-Gedächtnis-kirche on a grassy knoll in the north of the Tiergarten are also worthy of notice. In the Monbijou Park, on the north bank of the Spree, is the pretty English church of St George. The main Jewish synagogue, a fine building in oriental style, erected in 1866, stands in a commanding position in the Oranienburger-strasse and is remarkable for its stained glass. Berlin was a walled city until 1867–1868. Of the former nineteen city gates only one remains, the Brandenburg Gate (1789–1793), an imitation of the Propylaea at Athens. It is 201 ft. broad and nearly 65 ft. high, and is supported by twelve Doric columns, each 44 ft. in height, and surmounted by a car of victory (Auriga), which, taken by Napoleon to Paris in 1807, was brought back by the Prussians in 1814. The gate has been enlarged by two lateral colonnades, each supported by sixteen columns.

Public Buildings.—In secular buildings Berlin is very rich. Entering the city at the Potsdam Gate, traversing a few hundred yards of the Leipzig-strasse, turning into Wilhelm-strasse, and following it to Unter den Linden, then beginning at the Brandenburg Gate and proceeding down Unter den Linden to its end, one passes, among other buildings, the following, many of them of great architectural merit—the admiralty, the ministry of commerce, the ministry of war, the ministry of public works, the palace of Prince Frederick Leopold, the palace of the imperial chancellor, the foreign office, the ministry of justice, the residences of the ministers of the interior and of public worship, the French and the Russian embassies, the arcade, the palace of the emperor William I, the university, the royal library, the opera, the armoury, the palace of the emperor Frederick III., the Schloss-brücke, the royal palace, the old and new museums and the national gallery. At a short distance from this line are the new town-hall, the mint, the imperial bank and the royal theatre. Berlin differs from all other great capitals in this respect that with the exception of the royal palace, which dates from the 16th century, all its public buildings are modern. This palace, standing in the very heart of the city, is a huge quadrangular building, with four courts, and is surmounted by a dome 220 ft. high. It contains more than 600 rooms and halls; among the latter the Weisse-saal used for great court pageants; the halls of the chapters of the Black and the Red Eagle orders, a picture gallery and a chapel. The first floor overlooking the Schloss-platz is the Berlin residence of the emperor, and that square is embellished by a huge fountain (Neptuns-brunnen) by R. Begas. Facing the west portal is the monument to the emperor William I., and before the north gate, opening upon the Lustgarten, are the famous bronze groups, the "horse-tamers" by Clodt, the gift of the emperor Nicholas I. of Russia. The establishment of the imperial government in Berlin naturally brought with it the erection of a large number of public buildings, and the great prosperity of the country, as well as the enhanced national feeling, has enabled them to be built on a scale of splendour befitting the capital of an empire. First in importance is the Reichstagsgebäude (see ARCHITECTURE, plate ix, fig. 47), in which the federal council (*Bundesrat*) and the imperial parliament (*Reichstag*) hold their sittings. A special feature is the library, which is exceedingly rich in works on constitutional law. A new house has also been built for the Prussian parliament (*Landtag*) in the Albrecht-strasse. Other new official buildings are the patent office on the site of the old ministry of the interior; the new ministry of posts (with post museum) at the corner of the Mauer-strasse and Leipziger-strasse; the central criminal court in Moabit; the courts of first instance on the Alexander-platz; the ministry of police, and the *Reichsversicherungsamt*, the centre for the great system of state insurance. In addition to these, many buildings have been restored and enlarged, chief among them being the armoury (*Zeughaus*), the war office and the ministry of public works, while the royal mews (*Marstall*) has been entirely rebuilt with an imposing façade.

Among the public monuments comes first, in excellence, Rauch's celebrated statue of Frederick the Great, which stands in Unter den Linden opposite the palace of the emperor William I.; and in size the monument to the emperor William I. (by R. Begas), erected opposite the west portal of the royal palace. The space for the site was gained by pulling down the old houses composing the Schlossfreiheit and damming the Spree. The monument, which cost £200,000, is surmounted by an equestrian statue of the emperor in a martial cloak, his right hand resting on a field marshal's baton, reins in his charger, which is led by a female genius of peace. The high pedestal on which these figures stand is surrounded by an Ionic colonnade. The equestrian statue of the great elector on the Lange-brücke has been already mentioned. In the Lustgarten is a statue of Frederick William III., by Wolff; in the Tiergarten, Drake's marble monument to the same ruler; and in the mausoleum in the park in Charlottenburg he and his queen, Louisa, are sculptured in marble by Rauch. Here also lie the emperor William I. and the empress Augusta under marble effigies by Encke. A second group of monuments on the Wilhelms-platz commemorates the generals of the Seven Years' War; and a third in the neighbourhood of the opera-house the generals who fought against Napoleon I. On the Kreuzberg a Gothic monument in bronze was erected by Frederick William III. to commemorate the victories of 1813-1815; and in the centre of the Königs-platz stands a lofty column in honour of the triumphs of 1864, 1866 and 1870-1871, surmounted by a gilded figure of Victory. Literature, science and art are represented in different parts of the city by statues and busts of Rauch, Schinkel, Thier, Benth, Schadow, Winckelmann, Schiller, Hegel and Jahn. On the Königs-platz between the column of Victory and the Reichstagsgebäude, and immediately facing the western façade of the latter, is the bronze statue of Bismarck, unveiled in 1901, a figure 20 ft. in height standing on a granite base. From the south side of the Königs-platz crossing the Tiergarten and intersecting the avenue from the Brandenburg Gate to Charlottenburg runs the broad Sieges-allee adorned by thirty-two groups of marble statuary representing famous rulers of the house of Hohenzollern, the gift of the emperor William II. to the city. The Tiergarten, the beautiful west-end park with its thickets of dense undergrowth and winding lanes and lakes has lost somewhat of its sylvan character owing to building encroachments on the north side and the laying out of new rides and drives. It has, in addition to those above enumerated, statues of Queen Louisa, Goethe and Lessing.

Communications.—Berlin is the centre of the North German network of railways. No fewer than twelve main lines concentrate upon it. Internal communication is provided for by the Ringbahn, or outer circle, which was opened in 1871, and by a well-devised system connects the termini of the various main lines. The through traffic coming from east and west is carried by the Stadtbahn, or city railway, which also connects with and forms an integral part of the outer circle. This line runs through the heart of the city, and was originally a private enterprise. Owing, however, to the failure of the company, the work was taken in hand by the state, and the line opened in 1878. It has four tracks—two for the main-line through traffic, and two for local and suburban service, and is carried at a height of about 20 ft. above the streets. Its length is 12 m., the total cost 3½ millions sterling. The chief stations are Zoologischer Garten, Friedrichs-strasse, Alexander-platz and Schlesischer Bahnhof. Lying apart from the system are the Lehrter Bahnhof for Hamburg and Bremen, the Stettiner for Baltic ports, and the Grlitzer, Anhalter and Potsdamer termini for traffic to the south, of which the last two are fine specimens of railway architecture. Internal communication is also provided for by an excellent system of electric tram-lines, by an overhead electric railway running from the Zoologischer Garten to the Schlesische Tor with a branch to the Potsdam railway station, and by an underground railway laid at a shallow depth under the Leipzigerstrasse. Most of the cabs (victorias and broughams) have fare-indicators. Steamboats ply above and below the city.

Industry, Trade and Commerce.—It is in respect of its manufacture and trade that Berlin has attained its present high pitch of economic prosperity. More than 50% of its working population are engaged in industry, which embraces almost all branches, of which new ones have lately sprung into existence, whilst most of the older have taken a new lease of life. The old wool industry, for example, has become much extended, and now embraces products such as shawls, carpets, hosiery, &c. Its silk manufactures, formerly so important, have, however, gradually gone back. It is particularly in the working of iron, steel and cloth, and in the by-products of these, that Berlin excels. The manufacture of machinery and steam-engines shows an enormous development. No fewer than 100 large firms, many of them of world-wide reputation, are engaged in this branch alone. Among the chief articles of manufacture and production are railway plant, sewing machines, bicycles, steel pens, chronometers, electric and electric-telegraph plant, bronze, chemicals, soap, lamps, linoleum, china, pianofortes, furniture, gloves, buttons, artificial flowers and ladies' mantles, the last of an annual value exceeding £5,000,000. It has extensive breweries and vies in the amount of the output of this production with Munich. Berlin is also the great centre and the chief market for speculation in corn and other cereals which reach it by water from Poland, Austria and South Russia, while in commerce in spirits it rivals Ham-Lurg. It is also a large publishing centre, and has become a serious rival to Leipzig in this regard.

The Börse, where 4000 persons daily do business, is the chief market in Germany for stocks and shares, and its dealings are of great influence upon the gold market of the world. Numerous banks of world-wide reputation, doing an extensive international business, have their seats in Berlin, chief among them, in addition to the Reichs-bank, being the Berliner Kassen-Verein, the Diskontogesellschaft, the Deutsche Bank, and the Boden-Kredit Bank.

Learning and Art.—Berlin is becoming the centre of the intellectual life of the nation. The Friedrich Wilhelm University, although young in point of foundation, has long outstripped its great rival Leipzig in numbers, and can point with pride to the fact that its teaching staff has yielded to none in the number of illustrious names. It was founded in 1810, when Prussia had lost her celebrated university of Halle, which Napoleon had included in his newly created kingdom of Westphalia. It was as a weapon of war, as well as a nursery of learning, that Frederick William III. and the great men who are associated with its origin, called it into existence. Wilhelm von Humboldt was at that time at the head of the educational department of the kingdom, and men like Fichte and Schleiermacher worked on the popular mind. Within the first ten years of its existence it counted among its professors such names as Neander, Savigny, Eichhorn, Böckh, Bekker, Hegel, Raumer, Niebuhr and Buttmann. Later followed men like Hengstenberg, Homeyer, Bethmann-Hollweg, Puchta, Stahl and Heffter; Schelling, Trendelenburg, Bopp, the brothers Grimm, Zumpt, Carl Richter; later still, Twisten and Dörner, Gneist and Hinschius; Langenbeck, Bardeleben, Virchow, Du-Bois Reymond; von Ranke, Curtius, Lipsius, Hofmann the chemist, Kiepert the geographer; Helmholtz, van't Hoff, Koch, E. Fischer, Waldeyer and von Bergmann among scientists and surgeons; Mommsen, Treitschke and Sybel among historians, Harnack among theologians, Brunner among jurists. Taking ordinary, honorary, extraordinary professors and licensed lecturers (*Privat-docenten*) together, its professorial strength consisted, in 1904-1905, of 23 teachers in the faculty of theology, 32 in that of law, 175 in that of medicine and 227 in that of philosophy—altogether 457. The number of matriculated students during the same period was 7154, as against 5488 in the preceding summer term. The number of matriculated students is usually greater in winter than in summer; the reason of the disproportion being that in the summer university towns having pleasant surroundings, such as Bonn, Heidelberg, Kiel and Jena, are more frequented. Berlin is essentially a Prussian university—of students from non-German states, Russia sends most, then the United States of America, while Great Britain is credited with comparatively

few. It is, however, in the ugly palace of Prince Henry of Prussia, which was given for the purpose in the days of Prussian poverty and distress, that the university is still housed, and although some internal rearrangement has been effected, no substantial alterations have been made to meet the ever-increasing demand for lecture-room accommodation. The garden towards Unter den Linden is adorned by a bronze statue of Helmoltz; the marble statues of Wilhelm and Alexander von Humboldt, which were formerly placed on either side of the gate, have been removed to the adjacent garden. Technical education is provided in the magnificent buildings erected at a cost of £100,000 in Charlottenburg, which are equipped with all the apparatus for the teaching of science. Among other institutions of university rank and affiliated to it are the school of mines, the agricultural college, the veterinary college, the new seminary for oriental languages, and the high school for music. The geodetic institute has been removed to Potsdam. The university is, moreover, rich in institutions for the promotion of medical and chemical science, for the most part housed in buildings belonging to the governing body. There should also be mentioned the Royal Academy of Sciences, founded in 1700. The name of Leibnitz is associated with its foundation, and it was raised to the rank of a royal academy by Frederick the Great in 1743. The Royal Academy of Arts is under the immediate protection of the king, and is governed by a director and senate. There is also an academy of vocal music.

Schools.—Berlin possesses fifteen *Gymnasias* (classical schools, for the highest branches of the learned professions), of which four are under the direct supervision of the provincial authorities and have the prefix *königlich* (royal), while the remaining eleven are municipal and under the control of the civic authorities. They are attended by about 7000 scholars, of whom a fourth are Jews. There are also eight *Real-Gymnasias* (or "modern" schools), numerous *Real-schulen* (commercial schools), public high schools for girls, and commodious and excellently organized elementary schools.

Museums.—The buildings of the royal museum are divided into the old and new museums. The former is an imposing edifice situated on the north-east side of the Lustgarten, facing the royal palace. It was built in the reign of Frederick William III. from designs by Schinkel. Its portico supported by eighteen colossal Ionic columns is reached by a wide flight of steps. The back and side walls of the portico are covered with frescoes, from designs by Schinkel, representing the world's progress from chaos to organic and developed life. The sides of the flight of steps support equestrian bronze groups of the Amazon by Kiss, and the Lion-slayer by Albert Wolff. Under the portico are monuments of the sculptors Rauch and Schadow, the architect Schinkel, and the art critic Winkelmann. The interior consists of a souterrain, and of a first floor, entered from the portico through bronze doors, after designs by Stüler, weighing $7\frac{1}{2}$ tons, and executed at a cost of £3600. This floor consists of a rotunda, and of halls and cabinets of sculpture. The second floor, which formerly contained the national gallery of paintings, is occupied by a collection of northern antiquities and by the Schliemann treasures.

The new museum, connected with the old museum by a covered corridor, is, in its internal arrangements and decorations, one of the finest structures in the capital. The lowest of its three floors contains the Egyptian museum; on the first floor plaster casts of ancient, medieval and modern sculpture are found, while the second contains a cabinet of engravings. On the walls of the grand marble staircase, which rises to the full height of the building, Kaubach's cycle of stereochromic pictures is painted, representing the six great epochs of human progress, from the confusion of tongues at the Tower of Babel and the dispersion of the nations to the Reformation.

The national gallery, a fine building surrounded by a Corinthian colonnade and lying between the royal museums and the Spree, contains a number of modern German paintings. Behind these buildings, again, is the Pergamum museum, which houses a unique collection, the result of the excavations at

Pergamum. Still farther away, on a triangular plot of land enclosed by the two arms of the Spree and the metropolitan railway, stands the Kaiser Friedrich museum (1904). This edifice, in the Italian baroque style, surmounted by a dome, possesses but little architectural merit, and its position is so confined that great ingenuity had to be employed in its internal arrangements to meet the demands of space, but its collection of pictures is one of the finest in Europe. Hither were removed, from the old and new museums, the national gallery of pictures, the statuary of the Christian epoch and the numismatic collection. The gallery of paintings, on the first floor, is distributed into the separate schools of Germany, Italy, Flanders and Holland, while another of the central rooms embraces those of Spain, France and England. The collection, which in 1874 contained 1300 paintings, was then enriched by the purchase by the Prussian government for £51,000 of the Suermondt collection which, rich in pictures of the Dutch and Flemish schools, contained also a few by Spanish, Italian and French masters. The gallery as a whole has been happily arranged, and there are few great painters of whom it does not contain one or more examples. The Kunst-gewerbe museum, at the corner of the Königgrätzer-strasse and Albrecht-strasse, contains valuable specimens of applied art.

Theatres.—In nothing has the importance of Berlin become more conspicuous than in theatrical affairs. In addition to the old-established Opernhaus and Schauspielhaus, which are supported by the state, numerous private playhouses have been erected, notably the Lessing and the Deutsches theatres, and it is in these that the modern works by Wildenbruch, Sudermann, and Hauptmann have been produced, and it may be said that it is in Berlin that the modern school of German drama has its home. In music Berlin is not able to vie with Leipzig, Dresden or Munich, yet it is well represented by the Conservatorium, with which the name of Joachim is connected, while the more modern school is represented by Xaver Scharwenka.

Government, Administration and Politics.—On the 1st of April 1881 Berlin was divided off from the province of Brandenburg and since forms a separate administrative district. But the chief presidency (*Oberpräsidium*), the Consistory, the provincial school-board, and the board of health of the province of Brandenburg remain tribunals of last instance to which appeals lie from Berlin. The government is partly semi-military (police) and partly municipal. The ministry of police (a branch of the home office) consists of six departments: (1) general; (2) trade; (3) building; (4) criminal; (5) passports; (6) markets. It controls the fire brigade, has the general inspection over all strangers, and is responsible for public order. The civil authority (*Magistrat*) consists of a chief mayor (*Oberbürgermeister*), a mayor (*Bürgermeister*), and a city council (*Stadtrat*). The *Oberbürgermeister*, who is *ex officio* a member of the Prussian Upper House, and the *Bürgermeister* are elected by the common council (*Stadterordnetenversammlung*) of 144 members, *i.e.* three delegates chosen by manhood suffrage for each ward of the city; but the election is subject to the veto of the king without reason given. The *Stadtrat* consists of 32 members, of whom 15 are paid officials (including 2 syndics, 2 councillors for building, and 2 for education), while 17 serve gratuitously. For general work the *Magistrat* and the *Stadterordnetenversammlung* coalesce, and committees are appointed for various purposes out of the whole body, these being usually presided over by members of the *Magistrat*. Their jurisdiction extends to water-supply, the drainage, lighting and cleaning of the streets, the care of the poor, hospitals and schools. Politically the city is divided into six Reichstag and four Landtag constituencies, returning six and nine members respectively, and it must be noted that in the case of the Landtag the allocation of seats dated from 1860, so that the city, in proportion to its population, was in 1908 much under-represented. It should have had twenty-five members instead of nine.

Population.—The stupendous growth of the population of Berlin during the last century is best illustrated by the following figures. In 1816 it contained 197,717 inhabitants; in 1849,

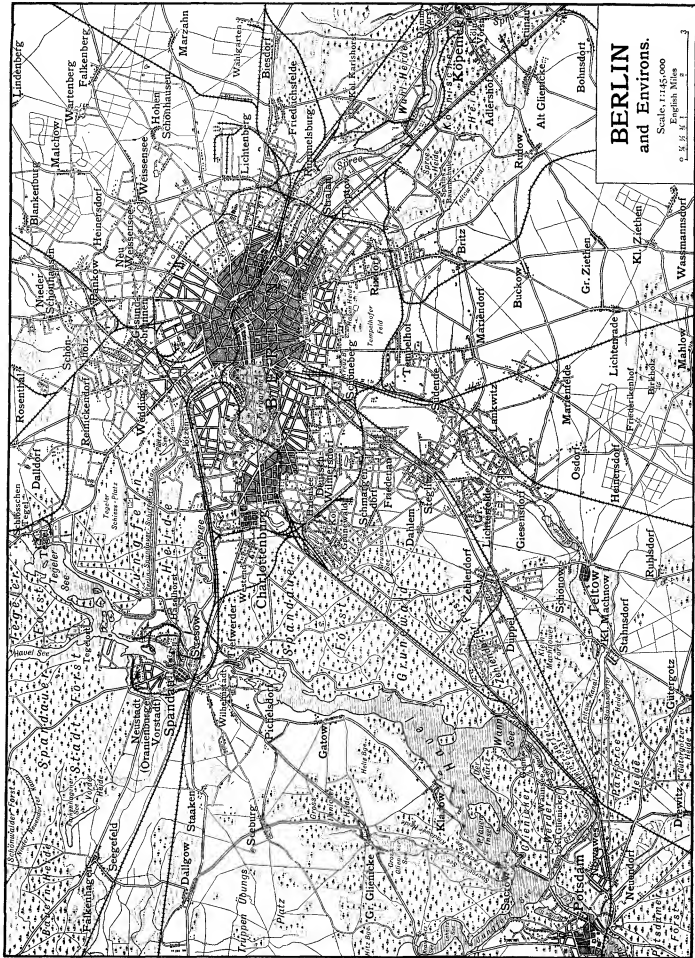

BERLIN and Environs.

Scale, 1:145,000
English Miles
0 1/2 1 1/2 2 3

431,566; in 1871, 826,341; in 1880, 1,122,330; 1890, 1,578,794, and in 1905, 2,033,900. The birth-rate is about 30, and the death-rate 20 per 1000 inhabitants a year. Illegitimate births amount to about 15% of the whole. According to religion, about 84% are Protestants, 10% Roman Catholics and 5% Jews, but owing to the great number of Jews who for social and other reasons ostensibly embrace the Christian faith, these last figures do not actually represent the number of Jews by descent living in the city.

Environns.—Marvellous as has been the transformation in the city itself, no less surprising results have been effected since 1875 in the surroundings of Berlin. On the east, north and west, the city is surrounded at a distance of some 5 m. from its centre by a thick belt of pine woods, the Jungfernheide, the Spandauer Forst, and the Grunewald, the last named stretching away in a south-westerly direction as far as Potsdam, and fringing the beautiful chain of Havel lakes. These forests enjoyed until quite recent times an unenviable notoriety as the camping-ground and lurking-place of footpads and other disorderly characters. After the opening of the circular railway in 1871, private enterprise set to work to develop these districts, and a "villa colony" was built at the edge of the Grunewald between the station West-end and the Spandauer Bock. From these beginnings, owing mainly to the expansion of the important suburb of Charlottenburg, has resulted a complete transformation of the eastern part of the Grunewald into a picturesque and delightful villa suburb, which is connected by railway, steam-tramway and a magnificent boulevard—the Kurfürstendamm—with the city. Nowadays the little fishing villages on the shores of the lakes, notably the Wannsee, cater for the recreation of the Berliners, while palatial summer residences of wealthy merchants occupy the most prominent sites. Suburban Berlin may be said to extend practically to Potsdam.

Traffic.—The public streets have a total length of about 350 m., and a large staff of workmen is regularly employed in maintaining and cleaning the public roads and parks. The force is well controlled, and the work of cleaning and removing snow after a heavy fall is thoroughly and efficiently carried out. The less important thoroughfares are mostly paved with the so-called Vienna paving, granite bricks of medium size, while the principal streets, and especially those upon which the traffic is heavy, have either asphalt or wood paving.

Water-Supply and Drainage.—The water-supply is mainly derived from works on the Müggel and Tegeler lakes, the river water being carefully filtered through sand. The drainage system is elaborate, and has stood the test of time. The city is divided into twelve radial systems, each with a pumping station, and the drainage is forced through five mains to eighteen sewage farms, each of which is under careful sanitary supervision, in respect both of the persons employed thereon, and the products, mainly milk, passing thence to the city for human consumption. Only in a few isolated cases has any contamination been traced to fever or other zymotic germs. In this connexion it is worth noting that the infectious diseases hospital has a separate system of drainage which is carefully disinfected, and not allowed to be employed for the purposes of manufacture.

Hospitals.—In no other city of the world is the hospital organization so well appointed as in Berlin, or are the sick poor tended with greater solicitude. State, municipal and private charity here again join hands in the prompt relief of sickness and cases of urgency. The municipal hospitals are six in number, the largest of which is the Virchow hospital, situate in Moabit and opened in 1906. It is arranged on the pavilion system, contains 2000 beds, and is one of the most splendidly equipped hospitals in the world. The cost amounted to £900,000. Next comes that of Friedrichshain, also built on the pavilion system, while the state controls six (not including the prison infirmaries) of which the world-renowned Charité in the Luisen-strasse is the principal. The hospitals of the nursing sisters (Diakonissen Anstalten) number 8, while there are 60 registered private hospitals under the superintendence of responsible doctors and under the inspection of government.

Charities.—Berlin is also very richly endowed with charitable institutions for the relief of pauperism and distress. In addition to the municipal support of the poor-houses there are large funds derived from bequests for the relief of the necessitous and deserving poor; while night shelters and people's kitchens have been organized on an extensive scale for the temporary relief of the indigent unemployed. For the former several of the arches of the city railway have been utilized, and correspond in internal arrangement to like shelters instituted by the Salvation Army in London and various other cities.

Markets.—Open market-places in Berlin are things of the past, and their place has been taken by airy and commodious market halls. Of these, 14 in number, the central market, close to the Alexander-platz station of the city railway with which it is connected by an admirable service of lifts for the rapid unloading of goods, is the finest. It has a ground area of about 17,000 sq. yds., and is fitted with more than 2000 stalls. The other markets are conveniently situated at various accessible places within the city, and the careful police supervision to which they are subjected, both in the matter of general cleanliness, and in the careful examination of all articles of food exposed for sale, has tended to the general health and comfort of the population.

The central cattle market and slaughter-houses for the inspection and supply of the fresh meat consumed in the metropolis occupy an extensive area in the north-east of the city on the Ringbahn, upon which a station has been erected for the accommodation of meat trains and passengers attending the market. The inspection is rigorously carried out, and only carcasses which have been stamped as having been certified good are permitted to be taken away for human consumption.

History.—The etymology of the word "Berlin" is doubtful. Some derive it from Celtic roots—*ber*, small, short, and *lyn*, a lake; others regard it as a Wend word, meaning a free, open place; others, again, refer it to the word *werl*, a river island. Another authority derives it from the German word *Brühl*, a marshy district, and the Slavonic termination *in*; thus Brühl, by the regular transmutation Bthl (compare Ger. *brunnen* and Eng. *burn*), Bührlin. More recent research, however, seems to have established the derivation from *Wehr*, dam.

Similar obscurity rests on the origin of the city. The hypotheses which carried it back to the early years of the Christian era have been wholly abandoned. Even the margrave Albert the Bear (d. 1170) is no longer unquestionably regarded as its founder, and the tendency of opinion now is to date its origin from the time of his great-grandsons, Otto III. and John I. When first alluded to, what is now Berlin was spoken of as two towns, Kölln and Berlin. The first authentic document concerning the former is from the year 1237, concerning the latter from the year 1244, and it is with these dates that the trustworthy history of the city begins. In 1307 the first attempt was made to combine the councils of Kölln and Berlin, but the experiment was abandoned four years later, and the two towns continued their separate existence till 1432, when the establishment of a common council for both led to disturbances of which the outcome was that Frederick II. the Iron in 1442 abolished this arrangement, seriously curtailed the privileges of both towns, and began the building of a castle at Kölln. A feud between the elector and the Berliners ended in the defeat of the latter, who in 1448 were forced to accept the constitution of 1442. From this time Berlin became and continued to be the residence of the Hohenzollerns, the elector John Cicero (1486-1499) being the first to establish a permanent court inside the walls. It was not, however, until the time of King Frederick William I. that the sovereigns ceased to date their official acts from Kölln. In 1539, under the elector Joachim II., Berlin embraced the Lutheran religion. Henceforth the history of Berlin was intimately bound up with the house of Hohenzollern. The conversion of the elector John Sigismund in 1613 to the Reformed (Calvinist) faith was hotly resented by the Berliners and led to bloody riots in the city. The 'Thirty Years' War all but ruined the city, the population of which sank from some 14,000 in 1600 to less than 8000 in 1650. It was restored and the foundations of its modern

splendour were laid by the Great Elector, by the time of whose death (1688) the population had risen to some 20,000. During this period several suburbs had begun to grow up, Friedrichswerder in 1667 and the Dorotheenstadt, so named in 1676 after the electress Dorothea its founder. In 1688 Frederick III. (afterwards King Frederick I.) began the Friedrichstadt, completed by Frederick William I. Under Frederick I., who did much to embellish the city as the royal *Residenzstadt*, the separate administrations of the quarters of Berlin, Kölln, Friedrichstadt, Friedrichswerder and Dorotheenstadt were combined, and the separate names were absorbed in that of Berlin. The fortifications begun in 1658 were finally demolished under Frederick the Great in 1745, and the Neue Friedrichstrasse, the Alexander-strasse and the Wall-strasse were laid out on their site.

Twice during the Seven Years' War Berlin was attacked by the enemy: in 1757 by the Austrians, who penetrated into the suburbs and levied a heavy contribution, and in 1760 by the Russians, who bombarded the city, penetrated into it, and only retired on payment of a ransom of 1,500,000 thalers (£225,000). After the disastrous campaign of Jena, Berlin suffered much during the French occupation (24th October 1806 to 1st December 1808). In spite of these misfortunes, however, the progress of the city was steady. In 1800 the present municipal government was instituted. In 1810 the university was founded. After the alliance of Prussia and Russia in 1812 Berlin was again occupied by the French, but in March 1813 they were finally driven out. The period following the close of the war saw great activity in building, especially in the erection of many noble monuments and public buildings, e.g. those by the architect Karl Friedrich Schinkel. The most notable event in the history of Berlin during the 19th century, prior to the Franco-German War, was the March revolution of 1848 (see GERMANY: *History*, and FREDERICK WILLIAM IV., king of Prussia). The effect of the war of 1870-71 on the growth of Berlin has been sufficiently indicated already.

AUTHORITIES.—For the history of Berlin see the publications of the "Verein für die Geschichte Berlins": the *Berlinische Chronik nebst Urkundenbuch*, and the periodicals *Der Bär* (1875, &c.) and *Mitteilungen* (1884, &c.). Of histories may be mentioned A. Streckfuss, *500 Jahre Berliner Geschichte* (new ed. by Fernbach, 1900); *Berlin im 17ten Jahrhundert* (4 vols., 1867-1869), and *Statistisches Jahrbuch der Stadt Berlin* (1904-1905); Fülch, *Statistisch-diplomatische Beiträge zur Geschichte der Stadt Berlin* (5 vols., 1837-1842); Brockhaus, *Konversations-Lexikon* (1904); Meyer, *Konversations-Lexikon* (1904); Baedeker, *Führer durch Berlin*; Woelf, *Führer durch Berlin*; J. Pollard, *The Corporation of Berlin* (Edinburgh, 1893); A. Shadwell, *Industrial Efficiency* (London, 1906); *Berliner Jahrbuch für Handel und Industrie* (1905); and O. Schwebel, *Geschichte der Stadt Berlin* (Berlin, 1888). (P. A. A.)

BERLIN, CONGRESS AND TREATY OF. The events that led up to the assembling of the congress of Berlin, the outcome of which was the treaty of the 13th of July 1878, are described elsewhere (see EUROPE: *History*; TURKEY: *History*; RUSSO-TURKISH WAR). Here it must suffice to say that the terms of the treaty of San Stefano (3rd March 1878), by which the Russo-Turkish War had been brought to a conclusion, seemed to those of the other powers who were most interested scarcely less fatal to the Ottoman dominion than that Russian occupation of Constantinople which Great Britain had risked a war to prevent. By this instrument Bulgaria was to become a practically independent state, under the nominal suzerainty of the sultan, bounded by the Danube, the Black Sea, the Aegean and Albania, and cutting off the latter from the remnant of Rumelia which, with Constantinople, was to be left to the Turks. At the same time the other Christian principalities, Servia and Montenegro, were largely increased in size and their independence definitively recognized; and the proposals of the powers with regard to Bosnia and Herzegovina, communicated to the Ottoman plenipotentiaries at the first sitting of the conference of Constantinople (23rd December 1876), were to be immediately executed. These provisions seemed to make Russia permanently arbiter of the fate of the Balkan peninsula, the more so since the vast war indemnity of 1,400,000,000 roubles exacted in the treaty promised to cripple

the resources of the Ottoman government for years to come.

The two powers whose interests were most immediately threatened by the terms of the peace were Austria and Great Britain. The former especially, refusing to be bribed by the Russian offer of Bosnia and Herzegovina, saw herself cut off from all chance of expansion in the Balkan peninsula and threatened with the establishment there of the paramount power of Russia, a peril it had been her traditional policy to avert. On the 5th of February, accordingly, Count Andrassy issued a circular note, addressed to the signatory powers of the treaty of Paris of 1856 and the London protocol of 1871, suggesting a congress for the purpose of establishing "the agreement of Europe on the modifications which it may become necessary to introduce into the above-mentioned treaties" in view of the preliminaries of peace signed by Russia and Turkey. This appeal to the sanctity of international engagements, traditional in the diplomatic armoury of Austria, and strengthened by so recent a precedent as that of 1871, met with an immediate response. On the 1st of April Lord Salisbury had already addressed a circular note to the British embassies refusing on behalf of the British government to recognize any arrangements made in the peace preliminaries, calculated to modify European treaties, "unless they were made the subject of a formal agreement among the parties to the treaty of Paris," and quoting the "essential principle of the law of nations" promulgated in the London protocol. By Great Britain therefore the Austrian proposal was at once accepted. Germany was very willing to fall in with the views of her Austrian ally and share in a council in which, having no immediate interests of her own, Bismarck could win new laurels in his rôle of "honest broker." In these circumstances Russia could not but accept the principle of a congress. She tried, however, to limit the scope of its powers by suggesting the exclusion of certain clauses of the treaty from its reference, and pointed out (circular of Prince Gorchakov, April 6th) that Russia had not been the first nor the only power to violate the treaties in question. The answer of Lord Beaconsfield was to mobilize the militia and bring Indian troops to the Mediterranean; and finally Russia, finding that the diplomatic support which she had expected from Bismarck failed her, consented to submit the whole treaty without reserve to the congress.

On the 3rd of June Count Münster, in the name of the German government, issued the formal invitation to the congress. The congress met, under the presidency of Prince Bismarck, at Berlin on the 13th of June. Great Britain was represented by Lord Beaconsfield, Lord Salisbury and Lord Odo Russell, ambassador at Berlin; Germany by Prince Bismarck, Baron Ernst von Bülow and Prince Chlodwig von Hohenlohe-Schillingfürst, ambassador at Paris; Austria by Count Andrassy, Count Louis Károlyi and Baron Heinrich Karl von Haymerle, ambassador at Rome; France by William II. Waddington, the Comte de Saint-Vallier, ambassador at Berlin, and Félix Hippolyte Desprez, director of political affairs in the department for foreign affairs; Russia by the chancellor, Prince Gorchakov, Count Peter Shuvalov, ambassador to the court of St James's, and Paul d'Oubril, ambassador at Berlin; Turkey by Alexander Cathedry Pasha, minister of public works, Ali Pasha, *ushir* of the Ottoman armies, and Sadullah Bey, ambassador at Berlin. The bases of the conferences had, of course, been settled beforehand, and the final act of the congress was signed by the plenipotentiaries mentioned above exactly a month after the opening of the congress, on the 13th of July.

The treaty of Berlin consists in all of sixty-four articles, of which it will be sufficient to note those which have had a special bearing on subsequent international developments. So far as they affect the territorial boundaries fixed by the treaties of Paris and San Stefano it will be sufficient to refer to the sketch map in the article EUROPE: *History*. By Art. I. Bulgaria was "constituted an autonomous and tributary principality under the suzerainty of H.I.M. the Sultan"; it was to have "a Christian government and a national militia." Art. II. fixed

the boundaries of the new state and provided for their delimitation by a European commission, which was "to take into consideration the necessity for H.I.M. the Sultan to be able to defend the Balkan frontiers of Eastern Rumelia." Arts. III. to XII. provide for the election of a prince for Bulgaria, the machinery for settling the new constitution, the adjustment of the relations of the new Bulgarian government to the Ottoman empire and its subjects (including the question of tribute, the amount of which was, according to Art. XII., to be settled by agreement of the signatory powers "at the close of the first year of the working of the new organization"). By Art. X. Bulgaria, so far as it was concerned, was to take the place of the Sublime Porte in the engagements which the latter had contracted, as well towards Austria-Hungary as towards the Ruscchuck-Varna Railway Company, for working the railway of European Turkey in respect to the completion and connexion, as well as the working of the railways situated in its territory.

By Art. XIII. a province was formed south of the Balkans which was to take the name of "Eastern Rumelia," and was to remain "under the direct military and political control of H.I.M. the Sultan, under conditions of administrative autonomy." It was to have a Christian governor-general. Arts. XIV. to XXIII. define the frontiers and organization of the new province, questions arising out of the Russian occupation, and the rights of the sultan. Of the latter it is to be noted that the sultan retained the right of fortifying and occupying the Balkan passes (Art. XV.) and all his rights and obligations over the railways (Art. XXI.).

Art. XXV., which the events of 1908 afterwards brought into special prominence, runs as follows: "The provinces of Bosnia and Herzegovina shall be occupied and administered by Austria-Hungary. The government of Austria-Hungary, not desiring to undertake the administration of the sanjak of Novi-Bazar, . . . the Ottoman administration will continue to exercise its functions there. Nevertheless, in order to assure the maintenance of the new political state of affairs, as well as freedom and security of communications, Austria-Hungary reserves the right of keeping garrisons and having military and commercial roads in the whole of this part of the ancient vilayet of Bosnia."

By Art. XXVI. the independence of Montenegro was definitively recognized, and by Art. XVIII. she received certain accessions of territory, including a strip of coast on the Adriatic, but under conditions which tended to place her under the tutelage of Austria-Hungary. Thus, by Art. XXIX. she was to have neither ships of war nor a war flag, the port of Antivari and all Montenegrin waters were to be closed to the war-ships of all nations; the fortifications between the lake and the coast were to be razed; the administration of the maritime and sanitary police at Antivari and along the Montenegrin littoral was to be carried on by Austria-Hungary "by means of light coast-guard boats"; Montenegro was to adopt the maritime code in force in Dalmatia, while the Montenegrin merchant flag was to be under Austro-Hungarian consular protection. Finally, Montenegro was to "come to an understanding with Austria-Hungary on the right to construct and keep up across the new Montenegrin territory a road and a railway."

By Art. XXXIV. the independence of Serbia was recognized, subject to conditions (as to religious liberty, &c.) set forth in Art. XXXV. Art. XXXVI. defined the new boundaries.

By Art. XLIII. the independence of Rumania, already proclaimed by the prince ($\frac{\text{May } 22}{\text{June } 3} 1877$), was recognized. Subsequent articles define the conditions and the boundaries.

Arts. LII. to LVII. deal with the question of the free navigation of the Danube. All fortifications between the mouths and the Iron Gates were to be razed, and no vessels of war, save those of light tonnage in the service of the river police and the customs, were to navigate the river below the Iron Gates (Art. LII.). The Danube commission, on which Rumania was to be represented, was maintained in its functions (Art. LIII.) and provision made for the further prolongation of its powers (Art. LIV.).

Art. LVIII. cedes to Russia the territories of Ardahan, Kars and Batoum, in Asiatic Turkey. By Art. LIX. "H.M. the emperor of Russia declares that it is his intention to constitute Batoum a free port, essentially commercial."

By Art. LXI. "the Sublime Porte undertakes to carry out, without further delay, the improvements and reforms demanded by local requirements in the provinces inhabited by the Armenians, and to guarantee their security against the Circassians and Kurds." It was to keep the powers informed periodically of "the steps taken to this effect."

Art. LXII. made provision for the securing religious liberty in the Ottoman dominions.

Finally, Art. LXIII. declares that "the treaty of Paris of 30th March 1856, as well as the treaty of London of 13th March 1871, are maintained in all such of their provisions as are not abrogated or modified by the preceding stipulations."

For the full text of the treaty in the English translation see E. Hertslet, *Map of Europe by Treaty*, vol. iv. p. 2759 (No. 530); for the French original see *State Papers*, vol. lxxx. p. 749. (W. A. P.)

BERLIN, a city of Coos county, New Hampshire, U.S.A., on the Androscoggin river, in the N. part of the state, about 98 m. N.W. of Portland, Maine. Pop. (1890) 3720; (1900) 8886, of whom 4643 were foreign-born; (1910 census) 11,780. The area of the city in 1906 was 57-81 sq. m. Berlin is served by the Grand Trunk and Boston & Maine railways. It is situated in the heart of the White Mountains and 16 m. from the base of Mt. Washington. Berlin Falls, on the picturesque Androscoggin river, furnishes an immense water-power, the development of which for manufacturing purposes accounts for the rapid growth of the city. The forests of northern New England and of the province of Quebec supply the raw material for the extensive saw-mills and planing-mills, the pulp- and paper-mills, and the sulphite fibre mills, said to be the largest in existence. In 1905 the city's factory products were valued at \$5,989,110, of which 78-5% was the value of the paper and wood pulp manufactured. Berlin was first settled in 1821, was incorporated as a township in 1829, and was chartered as a city in 1897.

BERLIN, a city and port of entry, Ontario, Canada, and capital of Waterloo county, 58 m. W. of Toronto, on the Grand Trunk railway. It is the centre of a prosperous farming and manufacturing district, inhabited chiefly by German immigrants and their descendants. An electric railway connects it with the town of Waterloo (pop. 4100) 2 m. to the north, which has important flour and woolen mills and distilleries. Berlin is a flourishing manufacturing town, and contains a beet sugar refinery, automobile, leather, furniture, shirt and collar, felt, glove, button and rubber factories. Pop. (1881) 4054; (1901) 9747.

BERLIN, a four-wheeled carriage with a separate hooded seat behind, detached from the body of the vehicle; so called from having been first used in Berlin. It was designed about 1670, by a Piedmontese architect in the service of the elector of Brandenburg. It was used as a travelling carriage, and Swift refers to it in his advice to authors "who scribble in a berlin." As an adjective, the word is used to indicate a special kind of goods, originally made in Berlin, of which the best known is Berlin wool. A Berlin warehouse is a shop for the sale of wools and fancy goods (cf. Italian warehouse). The spelling "berlin" is also used by Sir Walter Scott for the "birline," a large Gaelic rowing-boat.

BERLIOZ, HECTOR (1803-1869), French musical composer, was born on the 11th of December 1803 at Côte-Saint-André, a small town near Grenoble, in the department of Isère. His father, Louis Berlioz, was a physician of repute, and by his desire Hector for some time devoted himself to the study of medicine. At the same time he had music lessons, and, in secret, perused numerous theoretical works on counterpoint and harmony, with little profit it seems, till the hearing and subsequent careful analysis of one of Haydn's quartets opened a new vista to his unguided aspirations. A similar work written by Berlioz in imitation of Haydn's masterpiece was favorably received by his friends. From Paris, where he had been sent to complete his

medical studies, he at last made known to his father the unalterable decision of devoting himself entirely to art, the answer to which confession was the withdrawal of all further pecuniary assistance. In order to support life Berlioz had to accept the humble engagement of a singer in the chorus of the Gymnase theatre. Soon, however, he became reconciled to his father and entered the Conservatoire, where he studied composition under Reicha and Lesueur. His first important composition was an opera called *Les Francs-Juges*, of which, however, only the overture remains extant. In 1825 he left the Conservatoire, and began a course of self-education, founded chiefly on the works of Beethoven, Gluck, Weber and other German masters. About this period Berlioz saw for the first time the talented Irish actress Henrietta Smithson, who was then charming Paris by her impersonations of Ophelia, Juliet and other Shakespearian characters. The enthusiastic young composer became deeply enamoured of her at first sight, and tried, for a long time in vain, to gain the love or even the attention of his idol. To an incident of this wild and persevering courtship Berlioz's first symphonic work, *Épisode de la vie d'un artiste*, owes its origin. By the advice of his friends Berlioz once more entered the Conservatoire, where, after several unsuccessful attempts, his cantata *Sardanapalus* gained him the first prize for foreign travel (1830), in spite of the strong personal antagonism of one of the umpires. During a stay in Italy Berlioz composed an overture to *King Lear*, and *Le Retour à la vie*—a sort of symphony, with intervening poetical declamation between the single movements, called by the composer a melologue, and written in continuation of the *Épisode de la vie d'un artiste*, along with which work it was performed at the Paris Conservatoire in 1832. Paganini on that occasion spoke to Berlioz the memorable words: "Vous commencez par où les autres ont fini." Miss Smithson, who also was present on the occasion, consented to become the wife of her ardent lover in 1833. The marriage was a tempestuous mistake. In 1840 he separated from his wife, who died in 1854. Six months later Berlioz married Mademoiselle Récio. His second wife did not live very long, nor was there much that was edifying in this marriage. Between the date of his first marriage and 1840 came out his dramatic symphonies *Harold en Italie*, *Funèbre et triomphale*, and *Roméo et Juliette*; his opera *Benvenuto Cellini* (1837); his *Requiem*, and other works. In the course of time Berlioz won his due share of the distinctions generally awarded to artistic merit, such as the ribbon of the Legion of Honour and the membership of the Institute. But these distinctions he owed, perhaps, less to a genuine admiration of his compositions than to his successes abroad and his influential position as the musical critic of the *Journal des Débats* (a position which he held from 1838 to 1864, and which he never used or abused to push his own works). In 1842 Berlioz went for the first time to Germany, where he was hailed with welcome by the leading musicians of the younger generation, Robert Schumann foremost amongst them. The latter paved the way for the French composer's success by a comprehensive analysis of the *Épisode* in his musical journal, the *Neue Zeitschrift für Musik*. In 1846 he produced his magnificent cantata *La Damnation de Faust*. Berlioz gave successful concerts at Leipzig and other German cities, and repeated his visit on various later occasions—in 1852 by invitation of Liszt, to conduct his opera, *Benvenuto Cellini* (hissed off the stage in Paris), at Weimar; and in 1855 to produce his oratorio-trilogy, *L'Enfance du Christ*, in the same city. This latter work had been previously performed at Paris, where Berlioz mystified the critics by pretending to have found the last chorus amongst the manuscript scores of a composer of the 17th century, Pierre Ducrey by name. In 1855 his *Te Deum* was written for the opening of the Paris exhibition. Berlioz also made journeys to Vienna (1866) and St Petersburg (1867), where his works were received with great enthusiasm. In 1861 he produced his work *Beatrice et Bénédict*, and in 1863 *Les Troyens*. He died in Paris on the 8th of March 1869.

It is not only as a composer that the life of Berlioz is full of interest, although in this respect his achievement is singularly significant for the comprehension of the modern spirit in music.

But it is as the symbol of French romanticism in the whole domain of aesthetic perception that his pre-eminence has come to be recognized. His *Mémoires* (begun in London in 1848 and finished in 1865) illustrate this romantic spirit at its highest elevation as well as at its lowest depths. Victor Hugo was a romantic, Musset was a romantic, but Berlioz was romanticism itself. As a boy he is in despair over the despair of Dido, and his breath is taken away at Virgil's "Quaesivert coelo lucem ingemuitque reperta." At the age of twelve he is in love with "Estelle," whom he meets fifty years afterwards. The scene is described by himself (1865) with minute fidelity—a scene which Flaubert must have known by heart when he wrote its parallel in the novel *L'Éducation sentimentale*. The romance of this meeting between the man—old, isolated, unspeakably sad, with the halo of public fame burning round him—and the woman—old also, a mother, a widow, whose beauty he had worshipped when she was eighteen—is striking. In a frame of chastened melancholy and joy at the sight of Estelle, Berlioz goes to dine with Patti and her family. Patti, on the threshold of her career, pets Berlioz with such uncontrollable affection, that as the composer wrote a description of his feelings he was overwhelmed at the bitterness of fate. What would he not have given for Estelle to show him such affection! Patti seemed to him like a marvellous bird with diamond wings flitting round his head, resting on his shoulder, plucking his hair and singing her most joyous songs to the accompaniment of beating wings. "I was enchanted but not moved. The fact is that the young, beautiful, dazzling, famous virtuoso who at the age of twenty-two has already seen musical Europe and America at her feet, does not win the power of love in me; and the aged woman, sad, obscure, ignorant of art, possesses my soul as she did in the days gone by, as she will do until my last day." If this episode touches the sublime, it may be urged with almost equal truth that his description of the exhumation of his two wives and their reburial in a single tomb touches the ridiculous. And yet the scene is described with a perception of all the detail which would call for the highest praise in a novelist. Perhaps some parallel between the splendid and the ridiculous in this singular figure may be seen in the comparison of Nadar's caricature with Charpentier's portrait of the composer.

The profound admiration of Berlioz for Shakespeare, which rose at moments to such a pitch of folly that he set Shakespeare in the place of God and worshipped him, cannot be explained simply on the ground that Henrietta Smithson was a great Shakespearian actress. Unquestionably the great figures in English literature had a profound attraction for him, and while the romantic spirit is obvious in his selections from Byron and Scott, it can also be traced in the quality of his enthusiasm for Shakespeare. It is in his music more than in his literary attitude, however, that is disclosed something in addition to the pure romance of Schumann.—something that places him nearer in kind to Wagner, who recognized in him a composer from whose works he might learn something useful for the cultivation of his own ideals. As a youth the power of Beethoven's symphonies made a deep impression on Berlioz, and what has been described as the "poetical idea" in Beethoven's creations ran riot in the young medical student's mind. He thus became one of the most ardent and enlightened originators of what is now known as "programme music." Technically he was a brilliant musical colourist, often extravagant, but with the extravagant emotionalism of genius. He was a master of the orchestra; indeed, his treatment of the orchestra and his invention of unprecedented effects of *timbre* give him a solitary position in musical history; he had an extraordinary gift for the use of the various instruments, and himself propounded a new ideal for the force to be employed, on an enormous scale.

His literary works include the *Traité d'instrumentation* (1844); *Voyage musical en Allemagne et en Italie* (1845); *Les Soirées d'orchestre* (1853); *Les Grotesques de la musique* (1859); *À travers chant* (1862); *Mémoires* (1870); *Lettres intimes* (1882). For a full list of his musical works, Grove's Dictionary should be consulted.

The new critical edition of the complete musical works (published by Breitkopf and Härtel) is in ten series. I. Symphonies: *Fantastique*, Op. 14; *Funèbre et triomphale*, Op. 15, for military band and chorus; *Harold en Italie*, Op. 16, with viola solo; *Roméo et Juliette*, with chorus and soli. II. Overtures (ten, including the five belonging to larger works). III. Smaller instrumental works, of which only the Funeral March for *Hamlet* is important. IV. Sacred music: the *Grande Messe des morts*, Op. 5; the *Te Deum*, Op. 22; *L'Enfance du Christ*, Op. 25, and four smaller pieces. V. Secular cantatas, including *Un tel scène de Faust*, Op. 1; *Lélio, ou le retour à la vie*, Op. 146 (sequel to *Symphonie fantastique*), and *La Damnation de Faust*, Op. 24. VI. Songs and lyric choruses with orchestra, two vols. VII. Songs and lyric choruses with pianoforte, 2 vols. including arrangements of the orchestral songs. VIII. Operas: *Benvenuto Cellini*; *Les Troyens* (five acts in two parts, *La Prise de Troie* and *Les Troyens à Carthage*); Recitatives for the dialogue in Weber's *Freischütz*. IX. Arrangements, including the well-known orchestral version of Weber's *Invitation à la danse*. X. Fragments and new discoveries.

Adolphe Julien's biography of Berlioz (1888) first gave a careful account of the details of his life. See also the books by R. Pohl (1884), P. Galibert (1890), E. Hippau (1890), G. Nougard (1885), L. Mesnard (1888), Louise Pohl (1900), and D. Bernard (trans. by H. M. Dunstan, 1882). An illuminating essay on Berlioz is in F. Wilson Young's *Mastersingers* (1902). See also the essay in W. H. Hadow's *Studies in Modern Music* (1st series, 1908). Berlioz's *Travail d'instrumentation* has been translated into German and brought up to date by Richard Strauss (Peters' edition [1906]).

BERM (probably a variant of "brim"), a narrow ledge of ground, generally the level banks of a river. In parts of Egypt the whole area reached by the Nile is included in the berm. Thus of the lands near Berber, Mr C. Dupuis writes (in Sir William Garstin's *Report on the Upper Nile*, 1904), "In most places there is a well-defined alluvial berm of recent formation and varying width, up to perhaps a couple of kilometres." In military phraseology the berm is the space of ground between the base of a rampart and the ditch.

BERMONDSEY, a south-eastern metropolitan borough of London, England, bounded N. and E. by the Thames, S.E. by Deptford, S.W. by Camberwell, and W. by Southwark. Pop. (1901) 130,760. It is a district of poor streets, inhabited by a labouring population employed in leather and other factories, and in the Surrey Commercial Docks and the wharves bordering the river. The parish of Rotherhithe or Redriff has long been associated with a seafaring population. A tunnel connecting it with the opposite shore of the river was opened in June 1908. The neighbouring Thames Tunnel was opened in 1843, but, as the tolls were insufficient to maintain it, was sold to the East London Railway Company in 1865. The Herold Institute, a branch of the Borough Polytechnic, Southwark, is devoted to instruction in connexion with the leather trade. Southwark Park in the centre of the borough is 63 acres in extent. Bermondsey is in the parliamentary borough of Southwark, including the whole of Rotherhithe and part of the Bermondsey division. The borough council consists of a mayor, 9 aldermen, and 54 councillors. Area 1499.6 acres.

The name appears in Domesday, the suffix designating the former insular, marshy character of the district; while the prefix is generally taken to indicate the name of a Saxon overlord, Beormund. Bermondsey was in favour with the Norman kings as a place of residence, and there was a palace here, perhaps from pre-Norman times. A Cluniac monastery was founded in 1082, and Bermondsey Cross became a favoured place of pilgrimage. The foundation was erected into an abbey in 1390, and Abney Road recalls its site. Similarly, Spa Road points to the existence of a popular spring and pleasure grounds, maintained for some years at the close of the 18th century. Jacob Street marks Jacob's Island, the scene of the death of Bill Sikes in Dickens's *Oliver Twist*. Tooley Street, leading east from Southwark by London Bridge railway station, is well known in connexion with the story of three tailors of Tooley Street, who addressed a petition to parliament opening with the comprehensive expression "We, the people of England." The name is a corruption of St Olave, or Olaf, the Christian king of Norway, who in 904 attacked London by way of the river, and broke down London Bridge.

See E. T. Clarke, *Bermondsey, its Historic Memories* (1901)

BERMUDAS, a group of islands in the Atlantic Ocean, forming a British colony, in 32° 15' N. and 64° 50' W., about 580 m. E. by S. from Cape Hatteras on the American coast. The group, consisting of small islands and reefs (which mark the extreme northern range of the coral-building polyps), is of oval form, measuring 22 m. from N.E. to S.W., the area being 20 sq. m. The largest of the islands is Great Bermuda, or the Main Island, 14 m. long and about a mile in average width, enclosing on the east Harrington or Little Sound, and on the west the Great Sound, which is thickly studded with islets, and protected on the north by the islands of Watford, Boaz, Ireland and Somerset. The remaining members of the group, St George, Paget, Smith, St David, Cooper, Nonsuch, &c., lie N.E. of the Main Island, and form a semicircle round Castle Harbour. The fringing islands which encircle the islands, especially on the north and west, leave a few deep passages wide enough to admit the largest vessels.

Geology.—The Bermudas consist of aeolian limestones (cf. **BAHAMAS**) which in some of the larger islands form irregular hills attaining a height of some 200-250 ft. These limestones are composed chiefly of comminuted shells drifted and deposited by the wind, and they are very irregularly stratified, as is usually the case with wind-blown deposits. Where fresh the rock is soft, but where it has been exposed to the action of the sea it is covered by a hard crust and often loses all trace of stratification. The surface is frequently irregularly honeycombed. Even the reefs are not wholly formed of coral. They are ridges of aeolian limestone plastered over by a thin layer of corals and other calcareous organisms. The very remarkable "serpentine atolls" are covered by a solid crust made of the convoluted tubes of serpulæ and *Vermetes*, together with barnacles, mussels, nudibranchs, corallines and some true incrusting corals. They probably rest upon a foundation of aeolian rock. The Bermudas were formerly much more extensive than at present, and they may possibly stand upon the summit of a hidden volcano. There are evidences of small oscillations of levels, but no proofs of great elevation or depression.

Soil, Climate, &c.—The surface soil is a curious kind of red earth, which is also found in ochre-like strata throughout the limestone. It is generally mixed with vegetable matter and coral sand. There is a total want of streams and wells of fresh water, and the inhabitants are dependent on the rain, which they collect and preserve in tanks. The climate is mild and healthy, although serious epidemics of yellow fever and typhus have occurred. The maximum reading of the thermometer is about 87° F. and its minimum 49°, the mean annual temperature being 70°. The islands attract a large number of visitors annually from America. Vegetation is very rapid, and the soil is clad in a mantle of almost perpetual green. The principal kind of tree is the so-called "Bermudas cedar," really a species of juniper, which furnishes timber for small vessels. The shores are fringed with the mangrove; the prickly pear grows luxuriantly in the most barren districts; and wherever the ground is left to itself the sage bush springs up profusely. The citron, sour orange, lemon and lime grow wild; but the apple and peach do not come to perfection. The loquat, an introduction from China, thrives admirably. The mild climate assists the growth of esculent plants and roots; and a considerable trade is carried on with New York, principally in onions, early potatoes, tomatoes, and beetroot, together with lily bulbs, cut flowers and some arrowroot. Medicinal plants, as the castor-oil plant and aloe, come to perfection without culture; and coffee, indigo, cotton and tobacco are also of spontaneous growth. Few oxen or sheep are reared in the colony, meat, as well as bread and most vegetables, being imported from America. The indigenous mammals are very few, and the only reptiles are a small lizard and the green turtle. Birds, however, especially aquatic species, are very numerous. Insects are comparatively few, but ants swarm destructively in the heat of the year. Fish are plentiful round the coasts, and the whale-fishery was once an important industry, but the fisheries as a whole have not been developed.

Towns, and Administration.—There are two towns in the Bermudas: St George, on the island of that name, founded in

1794 and incorporated in 1797; and Hamilton, on the Main Island, founded in 1790 and incorporated in 1793. St George was the capital till the senate and courts of justice were removed by Sir James Cockburn to Hamilton, which being centrally situated, is more convenient. Hamilton, which is situated on the inner part of the Great Sound, had a population in 1901 of 2246, that of St George being 985. In Ireland Island is situated the royal dockyard and naval establishment. The harbour of St George's has space enough to accommodate a vast fleet; yet, till deepened by blasting, the entrance was so narrow as to render it almost useless. The Bermudas became an important naval and coaling station in 1860, when a large iron dry dock was towed across the Atlantic and placed in a secure position in St George, while, owing to their important strategic position in mid-Atlantic, the British government maintains a strong garrison. The Bermudas are a British crown colony, with a governor resident at Hamilton, who is assisted by an executive council of 6 members appointed by the crown, a legislative council of 9 similarly appointed, and a representative assembly of 36 members, of whom four are returned by each of nine parishes. The currency of the colony, which had formerly twelve shillings to the pound sterling, was assimilated to that of England in 1842. The English language is universal. The colony is ecclesiastically attached to the bishopric of Newfoundland. In 1847 an educational board was established, and there are numerous schools; attendance is compulsory, but none of the schools is free. Government scholarships enable youths to be educated for competition in the Rhodes scholarships to Oxford University. The revenue of the islands shows a fairly regular increase during the last years of the 19th century and the first of the 20th, as from £37,830 in 1805 to £63,457 in 1904; expenditure is normally rather less than revenue. In the year last named imports were valued at £580,979 and exports at £130,305, the annual averages since 1895 being about £426,300 and £112,500 respectively. The population shows a steady increase, as from 13,948 in 1881 to 17,535 in 1901; 6383 were whites and 11,152 coloured in the latter year.

History.—The discovery of the Bermudas resulted from the slipwreck of Juan Bermudez, a Spaniard (whose name they now bear), when on a voyage from Spain to Cuba with a cargo of hogs, early in the 16th century. Henry May, an Englishman, suffered the same fate in 1593; and lastly, Sir George Somers shared the destiny of the two preceding navigators in 1609. Sir George, from whom the islands took the alternative name of Somers, was the first who established a settlement upon them, but he died before he had fully accomplished his design. In 1612 the Bermudas were granted to an offshoot of the Virginia Company, which consisted of 120 persons, 60 of whom, under the command of Henry More, proceeded to the islands. The first source of colonial wealth was the growing of tobacco, but the curing industry ceased early in the 18th century. In 1726 Bishop George Berkeley chose the Bermudas as the seat of his projected missionary establishment. The first newspaper, the *Bermuda Gazette*, was published in 1784.

See Godet, *Bermuda, its History, Geology, Climate, &c.* (London, 1860); Ledford, *Discovery and Settlement of the Bermudas* (London, 1877-1879); A. Heilprin, *Bermuda Islands* (Philadelphia, 1880); Stark, *Bermuda Guide* (London, 1898); Cole, *Bermuda . . . Bibliography* (Boston, 1907); and for geology see also A. Comp. Zool., "Visit to the Bermudas in March 1804," *Bull. Mus. Comp. Zool. Harvard*, vol. xvi. no. 2, 1895; A. E. Verrill, "Notes on the Geology of the Bermudas," *Amer. Journ. Sci.* ser. 4, vol. ix, (1900), pp. 313-340; "The Bermudas Islands; Their Scenery, &c.," *Trans. Conn. Acad. Arts and Sci.* vol. xi. pt. 2 (1901-1902).

BERMUDEZ, a N.E. state of Venezuela, bounded by the Caribbean Sea and the Orinoco river, bounded E. by the gulf of Paria and the Delta-Anacuero territory, and W. by the states of Guario and Miranda. Pop. (est. 1905) 364,158. It was created in 1881 by the union of the states of Barcelona, Cumaná and Maturín, dissolved in 1901 into its three original states, and reorganized in 1904 with a slight modification of territory. The state includes the oldest settlements in Venezuela, and was once very prosperous, producing cattle and exporting hides, but wars and political disorders have partly destroyed its industries and

impeded their development. Its principal productions are coffee, sugar, and cacao, and—less important—cotton, tobacco, coconuts, timber, indigo and dyewoods. Its more important towns are the capital, Barcelona, Maturín (pop. 14,473), capital of a district of the same name, and Cumaná (10,000), on the gulf of Cariaco, founded in 1520 and one of the oldest towns of the continent.

BERN (Fr. *Berne*), after the Grisons, the largest of the Swiss cantons, but by far the most populous, though politically Bern ranks after that of Zürich. It extends right across Switzerland from beyond the Jura to the snow-clad ranges that separate Bern from the Valais. Its total area is 2641.9 sq. m., of which 2081 sq. m. are classed as "productive" (including 501 sq. m. of forests, and 2.1 m. of vineyards), while of the remainder 111.3 sq. m. are occupied by glaciers (the Valais and the Grisons alone surpass it in this respect). It is mainly watered by the river Aar (*q.v.*), with its affluents, the Kander (left), the Saane or Sarire (left) and the Emme (right); the Aar forms the two lakes of Brienz and Thun (*q.v.*). The great extent of this canton accounts for the different character of the regions therein comprised. Three are usually distinguished:—(1) The *Oberland* or Highlands, which is that best known to travellers, for it includes the snowy Alps of the Bernese Oberland (culminating in the Finsteraarhorn, 14,026 ft., and the Jungfrau, 13,669 ft.), as well as the famous summer resorts of Grindelwald, Mürren, Lauterbrunnen, Interlaken, Meiringen, Kandersteg, Adelboden, Thun and the fine pastoral valley of the Simme. (2) The *Mittelland* or Midlands, comprising the valley of the Aar below Thun, and that of the Emme, thus taking in the outliers of the high Alps and the open country on every side of the town of Bern. (3) The *Seeland* (Lakeland) and the Jura, extending from Bienna and its lake across the Jura to Porrentruy in the plains and to the upper course of the Birs. The Oberland and Mittelland form the "old" canton, the Jura having only been acquired in 1815, and differing from the rest of the canton by reason of its French-speaking and Romanist inhabitants.

In 1900 the total population of the canton was 589,433, of whom 483,388 were German-speaking, 97,780 French-speaking, and 7167 Italian-speaking; while there were 506,690 Protestants, 80,489 Romanists (including the Old Catholics), and 1543 Jews. The capital is Bern (*q.v.*), while the other important towns are Bienna (*q.v.*), Burgdorf (*q.v.*), Delémont or Delserg (5053 inhabitants), Porrentruy or Pruntrut (6959 inhabitants), Thun (*q.v.*), and Langenthal (4709 inhabitants). There is a university (founded in 1834) in the town of Bern, as well as institutions for higher education in the principal towns. The canton is divided into 30 administrative districts, and contains 507 communes (the highest number in Switzerland). From 1803 to 1814 the canton was one of the six "Directorial" cantons of the Confederation. The existing cantonal constitution dates from 1893, but in 1905 the direct popular election of the executive of 9 members (hitherto named by the legislature) was introduced. The legislature or *Grossrath* is elected for four years (like the executive), in the proportion of 1 member to every 2500 (or fraction over 1250) of the resident population. The *obligatory Referendum* obtains in the case of all laws, and of decrees relating to an expenditure of over half a million francs, while 12,000 citizens have the right of *initiative* in the case of legislative projects, and 15,000 may demand the revision of the cantonal constitution. The 2 members sent by the canton to the federal *Sänderath* are elected by the *Grossrath*, while the 29 members sent to the federal *Nationalrath* are chosen by a popular vote. In the Alpine portions of the canton the breeding of cattle (those of the Simme valley are particularly famous) is the chief industry; next come the elaborate arrangements for summer travellers (the *Fremdenindustrie*). It is reckoned that there are 2430 "Alps" or mountain pastures in the canton, of which 1474 are in the Oberland, 627 in the Jura, and 280 in the Emme valley; they can maintain 95,478 cows and are of the estimated value of 463 million francs. The cheese of the Emme valley is locally much esteemed. Other industries in the Alpine region are wood-carving (at Brienz) and wine manufacture (on the shores

of the lakes of Bienna and of Thun). The Mittelland is the agricultural portion of the canton. Watchmaking is the principal industry of the Jura, Bienna and St Imier being the chief centres of this industry. Iron mines are also worked in the Jura, while the Heimberg potteries, near Thun, produce a locally famous ware, and there are both quarries of building stone and tile factories. The canton is well supplied with railway lines, the broad gauge lines being 228 m. in length, and the narrow gauge lines 157½ m.—in all 385½ m. Among these are many funicular cog-wheel lines, climbing up to considerable heights, so up to Mürren (5368 ft.), over the Wengern Alp (6772 ft.), up to the Schynige Platte (6463 ft.), and many others still in the state of projects. All these are in the Oberland where, too, is the so-called Jungfrau railway, which in 1906 attained a point (the Eismeer station) in the south wall of the Eiger (13,042 ft.) that was 10,371 ft. in height, the loftiest railway station in Switzerland.

The canton of Bern is composed of the various districts which the town of Bern acquired by conquest or by purchase in the course of time. The more important, with dates of acquisition, are the following:—Laupen (1324), Hasli and Meiringen (1334), Thun and Burgdorf (1384), Untereisen and the Upper Simme valley (1386), Frutigen, &c. (1400), Lower Simme valley (1430-1449), Interlaken, with Grindelwald, Lauterbrunnen and Brienz (1528, on the suppression of the Austin Canons of Interlaken), Saanen or Gessenay (1555), Köniz (1729), and the Bernese Jura with Bienna (1815, from the bishopric of Basel). But certain regions previously won were lost in 1798—Aargau (1415), Aigle and Grandson (1475), Vaud (1536), and the Pays d'En-Haut or Château d'Oex (1555). From 1708 to 1802 the Oberland formed a separate canton (capital, Thun) of the Helvetic Republic.

(W. A. B. C.)

BERN (*Fr. Berne*), the capital of the Swiss canton of the same name, and, by a Federal law of 1848, the political capital of the Swiss confederation. It is most picturesquely situated on a high bluff or peninsula, round the base of which flows the river Aar, thus completely cutting off the old town, save to the west. Five lofty bridges have been thrown over the Aar, the two most modern being the Kirchfeld and Kornhaus bridges which have greatly contributed to create new residential quarters near the old town. Within the town the arcades (or *Lauben*) on either side of the main street, and the numerous elaborately ornamented fountains attract the eye, as well as the two remaining towers that formerly stood on the old walls but are now in the centre of the town; the *Zeitglockenthurm* (famous for its singular 16th-century clock, with its mechanical contrivances, set in motion when the hour strikes) and the *Käfigthurm*. The principal medieval building in Bern is the (now Protestant) Münster, begun in 1421 though not completed till 1573. The tower, rising conspicuously above the town, has recently been well restored, but the church was never a cathedral church (as is often stated), for there has never yet been a bishop of Bern. The federal Houses of Parliament (*Bundeshaus*) were much enlarged in 1888-1892, the older portions dating from 1852-1857, and also contain the offices of the federal executive and administration. The town-hall dates from 1406, while some of the houses belonging to the old guilds contain much of interest. The town library (with which that of the university was incorporated in 1905) contains a vast store of MSS. and rare printed books, but should be carefully distinguished from the national Swiss library, which, with the building for the federal archives, is built in the new Kirchfeld quarter. There are a number of museums; the historical (archaeological and medieval), the natural history (in which the skin of Barry, the famous St Bernard dog, is preserved), the art (mainly modern Swiss pictures), and the Alpine (in which are collections of all kinds relating to the Swiss Alps). Bern possesses a university (founded in 1834) and two admirably organized hospitals. The old fortifications (*Schanzen*) have been converted into promenades, which command wonderful views of the snowy Alps of the Bernese Oberland. Just across the Nydeck bridge is the famous bear pit in which live bears are kept, as they are supposed to have given the name to the town;

certainly a bear is shown on the earliest known town seal (1224), while live bears have been maintained at the charges of the town since 1513. There is comparatively little industrial activity in the town, the importance of which is mainly political, though of late years it has been selected as the seat of various international associations (postal, telegraph, railway, copyright, &c.). The climate is severe, as the town is much exposed to cold winds blowing from the snowy Alps. In point of population it is exceeded in Switzerland by Zürich, Basel and Geneva, though the number of inhabitants has risen from 27,538 in 1850 and 43,107 in 1880 to 64,227 in 1900. In 1900, 59,698 inhabitants were German-speaking; while 57,144 were Protestants, 6087 Romanists (including Old Catholics) and 655 Jews. The height of the town above the sea-level is 1788 ft.

The ancient castle of Nydeck, at the eastern end of the peninsula, guarded the passage over the Aar, and it was probably its existence that induced Berchtold V., duke of Züringen, to found Bern in 1191 as a military post on the frontier between the Alamanni (German-speaking) and the Burgundians (French-speaking). Thrice the walls which protected the town were moved westwards, about 1250, in 1346 and in 1622, though even at the last-named date the town only stretched a little way to the west of (or beyond) the present railway station. After the extinction of the Züringen dynasty (1218) Bern became a free imperial city, but it had to fight hard for its independence, which was finally secured by the victories of Dornbühl (1298) over Fribourg and the Habsburgs, and of Laupen (1339) over the neighbouring Burgundian nobles. In the second battle Bern received help from the three forest cantons with which it had become allied in 1323, while in 1353 it entered the Swiss confederation as its eighth member. It soon took the lead in the confederation, though always aiming at enlarging its own borders, even at great risks (see the article on the canton). In 1528 Bern accepted the religious reformation, and henceforth became one of its chief champions in Switzerland. In the 17th century the number of families by which high offices of state could be held was diminished, so that in 1605 there were 152 thus qualified, but in 1691 only 104, while towards the end of the 18th century there were only 69 such families. Meanwhile the rule of the town was extending over more and more territory, so that finally it possessed 52 bailiwicks (acquired between 1324 and 1729), the Bernese patricians being thus extremely powerful and forming an oligarchy that administered affairs like a benevolent and well-ordered despotism. In 1723 Major Davel, at Lausanne, and in 1749 Henzi, in Bern itself, tried to break down this monopoly, but in each case paid the penalty of failure on the scaffold. The whole system was swept away by the French in 1798, and though partially revived in 1815, came to an end in 1831, since which time Bern has been in the van of political progress. From 1815 to 1848 it shared with Zürich and Lucerne the supreme rule (which shifted from one to the other every two years) in the Swiss confederation, while in 1848 a federal law made Bern the sole political capital, where the federal government is permanently fixed and where the ministers of foreign powers reside.

AUTHORITIES.—*Die Alp- und Weidewirtschaft im Kant. Bern* (Bern, 1903); *Archiv d. hist. Vereins d. Kant. Bern*, from 1848, and *Blätter für bernische Geschichte*, from 1905; *Bernische Biographie* (Bern, 1898-1906); E. Friedl, *Bärndätsch als Spiegel bernischen Volkstums*; vol. i. (Lützelhof, Bern, 1905), and vol. ii. (Grindelwald, Bern, 1908); *Festschrift zur 70ten Säkulfeier d. Gründung Berns*, 1191 (Bern, 1891); *Fonles Rerum Bernensium* (to 1378), 9 vols., Bern, 1883-1908; K. Geiser, *Geschichte d. bernischen Verfassung*, 1191-1471 (Bern, 1888); B. Haller, *Bern in seinen Rathsmannalen*, 1465-1565 (3 vols., Bern, 1900-1902); E. F. and W. F. von Müllinen, *Beiträge zur Heimatskunde d. Kantons Bern, deutschen Theils* (3 vols., Bern, 1879-1894); W. F. von Müllinen, *Berns Geschichte*, 1191-1891 (Bern, 1891); E. vcn Rodt, *Bernische Stadtgeschichte* (Bern, 1888), and 6 finely illustrated vols. on Bern in the 13th to 19th centuries (Bern, 1858-1907); L. S. von Tschamer, *Rechtsgeschichte des Obermimenthalens bis zum Jahre 1798* (Bern, 1908); E. von Wattenwyl, *Geschichte d. Stadt u. Landschaft Bern* (to 1400), 2 vols.; Schafhausen and Bern (1867-1872); F. E. Wetti, *Die Rechtsquellen d. Kant. Bern*, vol. i. (Aarau, 1902); Gertrud Zürcher, *Kinderpiel u. Kinderlied im Kant. Bern* (Zürich, 1902). (W. A. B. C.)

BERNARD, SAINT (1090-1153), abbot of Clairvaux one of the most illustrious preachers and monks of the middle ages, was born at Fontaines, near Dijon, in France. His father, a knight named Tecelin, perished on crusade; and his mother Aleth, a daughter of the noble house of Mon-Bar, and a woman distinguished for her piety, died while Bernard was yet a boy. The lad was constitutionally unfitted for the career of arms, and his own disposition, as well as his mother's early influence, directed him to the church. His desire to enter a monastery was opposed by his relations, who sent him to study at Châlons in order to qualify for high ecclesiastical preferment. Bernard's resolution to become a monk was not, however, shaken, and when he at last definitely decided to join the community which Robert of Molesmes had founded at Cîteaux in 1108, he carried with him his brothers and many of his relations and friends. The little community of reformed Benedictines, which was to produce so profound an influence on Western monachism (see CISTERCIANS and MONASTICISM) and had seemed on the point of extinction for lack of novices, gained a sudden new life through this accession of some thirty young men of the best families of the neighbourhood. Others followed their example; and the community grew so rapidly that it was soon able to send offshoots. One of these daughter monasteries, Clairvaux, was founded in 1115, in a wild valley branching from that of the Aube, on land given by Count Hugh of Troyes, and of this Bernard was appointed abbot.

By the new constitution of the Cistercians Clairvaux became the chief monastery of the five branches into which the order was divided under the supreme direction of the abbot of Cîteaux. Though nominally subject to Cîteaux, however, Clairvaux soon became the most important Cistercian house, owing to the fame and influence of Bernard.¹ His saintly character, his self-mortification—of so severe a character that his friend, William of Champeaux, bishop of Châlons, thought it right to remonstrate with him—and above all, his marvellous power as a preacher, soon made him famous, and drew crowds of pilgrims to Clairvaux. His miracles were noised abroad, and sick folk were brought from near and far to be healed by his touch. Before long the abbot, who had intended to devote his life to the work of his monastery, was drawn into the affairs of the great world. When in 1124 Pope Honorius II. mounted the chair of St Peter, Bernard was already reckoned among the greatest of French churchmen; he now shared in the most important ecclesiastical discussions, and papal legates sought his counsel. Thus in 1128 he was invited by Cardinal Matthew of Albano to the synod of Troyes, where he was instrumental in obtaining the recognition of the new order of Knights Templars, the rules of which he is said to have drawn up; and in the following year, at the synod of Châlons-sur-Marne, he ended the crisis arising out of certain charges brought against Henry, bishop of Verdun, by persuading the bishop to resign. The European importance of Bernard, however, began with the death of Pope Honorius II. (1130) and the disputed election that followed. In the synod convoked by Louis the Fat at Étampes in April 1130 Bernard successfully asserted the claims of Innocent II. against those of Anacletus II., and from this moment became the most influential supporter of his cause. He threw himself into the contest with characteristic ardour. While Rome itself was held by Anacletus, France, England, Spain and Germany declared for Innocent, who, though banished from Rome, was—in Bernard's phrase—"accepted by the world." The pope travelled from place to place, with the powerful abbot of Clairvaux at his side; he stayed at Clairvaux itself, humble still, so far as its buildings were concerned; and he went with Bernard to parley with the emperor Lothair III. at Liège.

In 1133, the year of the emperor's first expedition to Rome, Bernard was in Italy persuading the Genoese to make peace with the men of Pisa, since the pope had need of both. He accompanied Innocent to Rome, successfully resisting the proposal to reopen negotiations with Anacletus, who held the castle of Sant' Angelo and, with the support of Roger of Sicily, was too strong

to be subdued by force. Lothair, though crowned by Innocent in St Peter's, could do nothing to establish him in the Holy See so long as his own power was sapped by his quarrel with the house of Hohenstaufen. Again Bernard came to the rescue; in the spring of 1135 he was at Bamberg successfully persuading Frederick of Hohenstaufen to submit to the emperor. In June he was back in Italy, taking a leading part in the council of Pisa, by which Anacletus was excommunicated. In northern Italy the effect of his personality and of his preaching was immense; Milan itself, of all the Lombard cities most jealous of the imperial claims, surrendered to his eloquence, submitted to Lothair and to Innocent, and tried to force Bernard against his will into the vacant see of St Ambrose. In 1137, the year of Lothair's last journey to Rome, Bernard was back in Italy again; at Monte Cassino, setting the affairs of the monastery in order, at Salerno, trying in vain to induce Roger of Sicily to declare against Anacletus, in Rome itself, agitating with success against the antipope. Anacletus died on the 25th of January 1138; on the 13th of March the cardinal Gregory was elected his successor, assuming the name of Victor. Bernard's crowning triumph in the long contest was the abdication of the new antipope, the result of his personal influence. The schism of the church was healed, and the abbot of Clairvaux was free to return to the peace of his monastery.

Clairvaux itself had meanwhile (1135-1136) been transformed outwardly—in spite of the reluctance of Bernard, who preferred the rough simplicity of the original buildings—into a more suitable seat for an influence that overshadowed that of Rome itself. How great this influence was is shown by the outcome of Bernard's contest with Abelard (*q.v.*). In intellectual and dialectical power the abbot was no match for the great schoolman; yet at Sens in 1141 Abelard feared to face him, and when he appealed to Rome Bernard's word was enough to secure his condemnation.

One result of Bernard's fame was the marvellous growth of the Cistercian order. Between 1130 and 1145 no less than ninety-three monasteries in connexion with Clairvaux were either founded or affiliated from other rules, three being established in England and one in Ireland. In 1145 a Cistercian monk, once a member of the community of Clairvaux—another Bernard, abbot of Aquae Silviae near Rome, was elected pope as Eugenius III. This was a triumph for the order; to the world it was a triumph for Bernard, who complained that all who had suits to press at Rome applied to him, as though he himself had mounted the chair of St Peter (*Ep.* 239).

Having healed the schism within the church, Bernard was next called upon to attack the enemy without. Languedoc especially had become a hotbed of heresy, and at this time the preaching of Henry of Lausanne (*q.v.*) was drawing thousands from the orthodox faith. In June 1145, at the invitation of Cardinal Alberic of Ostia, Bernard travelled in the south, and by his preaching did something to stem the flood of heresy for a while. Far more important, however, was his activity in the following year, when, in obedience to the pope's command, he preached a crusade. The effect of his eloquence was extraordinary. At the great meeting at Vezelay, on the 21st of March, as the result of his sermon, King Louis VII. of France and his queen, Eleanor of Guienne, took the cross, together with a host of all classes, so numerous that the stock of crosses was soon exhausted; Bernard next travelled through northern France, Flanders and the Rhine provinces, everywhere rousing the wildest enthusiasm; and at Spire on Christmas day he succeeded in persuading Conrad, king of the Romans, to join the crusade.

The lamentable outcome of the movement (see CRUSADES) was a hard blow to Bernard, who found it difficult to understand this manifestation of the hidden counsels of God, but ascribed it to the sins of the crusaders (*Ep.* 288; *de Consid.* ii. 1). The news of the disasters to the crusading host first reached Bernard at Clairvaux, where Pope Eugenius, driven from Rome by the revolution associated with the name of Arnold of Brescia, was his guest. Bernard had in March and April 1148 accompanied the pope to the council of Reims, where he led the attack on

¹ The Cistercians of this branch of the order were commonly known as Bernardines.

certain propositions of the scholastic theologian Gilbert de la Porrée (*q.v.*). From whatever cause—whether the growing jealousy of the cardinals, or the loss of prestige owing to the rumoured failure of the crusade, the success of which he had so confidently predicted—Bernard's influence, hitherto so ruinous to those suspected of heterodoxy, on this occasion failed of its full effect. On the news of the full extent of the disaster that had overtaken the crusaders, an effort was made to retrieve it by organizing another expedition. At the invitation of Suger, abbot of St Denis, now the virtual ruler of France, Bernard attended the meeting of Chartres convened for this purpose, where he himself was elected to conduct the new crusade, the choice being confirmed by the pope. He was saved from this task, for which he was physically and constitutionally unfit, by the intervention of the Cistercian abbots, who forbade him to undertake it.

Bernard was now ageing, broken by his austerities and by ceaseless work, and saddened by the loss of several of his early friends. But his intellectual energy remained undimmed. He continued to take an active interest in ecclesiastical affairs, and his last work, the *De Consideratione*, shows no sign of failing power. He died on the 20th of August 1153.

The greatness of St Bernard lay not in the qualities of his intellect, but of his character. Intellectually he was the child of his age, inferior to those subtle minds whom the world, fired by his contagious zeal, conspired to crush. Morally he was their superior; and in this moral superiority lay the secret of his power. The age recognized in him the embodiment of its ideal: that of medieval monasticism at its highest development. The world had no meaning for him save as a place of banishment and trial, in which men are but "strangers and pilgrims" (Serm. i., Epiph. n. 1; Serm. vii., Lent. n. 1); the way of grace, back to the lost inheritance, had been marked out once for all, and the function of theology was but to maintain the landmarks inherited from the past. With the subtleties of the schools he had no sympathy, and the dialectics of the schoolmen quavered into silence before his terrible invective. Yet, within the limits of his mental horizon, Bernard's vision was clear enough. His very life proves with what merciless logic he followed out the principles of the Christian faith as he conceived it; and it is impossible to say that he conceived it amiss. For all his overmastering zeal he was by nature neither a bigot nor a persecutor. Even when he was preaching the crusade he interfered at Mainz to stop the persecution of the Jews, stirred up by the monk Radulf. As for heretics, "the little foxes that spoil the vines," these "should be taken, not by force of arms, but by force of argument," though, if any heretic refused to be thus taken, he considered "that he should be driven away, or even a restraint put upon his liberty, rather than that he should be allowed to spoil the vines" (Serm. lxi.). He was evidently troubled by the mob violence which made the heretics "martyrs to their unbelief." He approved the zeal of the people, but could not advise the imitation of their action, "because faith is to be produced by persuasion, not imposed by force"; adding, however, in the true spirit of his age and of his church, "it would without doubt be better that they should be coerced by the sword than that they should be allowed to draw away many other persons into their error." Finally, oblivious of the precedent of the Pharisees, he ascribes the steadfastness of these "dogs" in facing death to the power of the devil (Serm. lxxi. on Canticles ii. 15).

This is Bernard at his worst. At his best—and, fortunately, this is what is mainly characteristic of the man and his writings—he displays a nobility of nature, a wise charity and tenderness in his dealings with others, and a genuine humility, with no touch of servility, that make him one of the most complete exponents of the Christian life. His broadly Christian character is, indeed, witnessed to by the enduring quality of his influence. The author of the *Imitatio* drew inspiration from his writings; the reformers saw in him a medieval champion of their favourite doctrine of the supremacy of the divine grace; his works, down to the present day, have been reprinted in countless editions. This is perhaps due to the fact that the chief fountain of his own

inspiration was the Bible. He was saturated in its language and in its spirit; and though he read it, as might be expected, uncritically, and interpreted its plain meanings allegorically—as the fashion of the day was—it saved him from the grosser aberrations of medieval Catholicism. He accepted the teaching of the church as to the reverence due to our Lady and the saints, and on feast-days and festivals these receive their due meed in his sermons; but in his letters and sermons their names are at other times seldom invoked. They were overshadowed completely in his mind by his idea of the grace of God and the moral splendour of Christ; "from Him do the Saints derive the odour of sanctity; from Him also do they shine as lights" (*Ep.* 464).

The cause of Bernard's extraordinary popular success as a preacher can only imperfectly be judged by the sermons that survive. These were all delivered in Latin, evidently to congregations more or less on his own intellectual level. Like his letters, they are full of quotations from and reference to the Bible, and they have all the qualities likely to appeal to men of culture at all times. "Bernard," wrote Erasmus in his *Art of Preaching*, "is an eloquent preacher, much more by nature than by art; he is full of charm and vivacity and knows how to reach and move the affections." The same is true of the letters and to an even more striking degree. They are written on a large variety of subjects, great and small, to people of the most diverse stations and types; and they help us to understand the adaptable nature of the man, which enabled him to appeal as successfully to the unlearned as to the learned.

Bernard's works fall into three categories:—(1) *Letters*, of which over five hundred have been preserved, of great interest and value for the history of the period. (2) *Treatises*: (a) dogmatic and polemical, *De gratia et libero arbitrio*, written about 1127, and following closely the lines laid down by St Augustine; *De baptismo alioque questionibus ad mag. Hugonem de S. Victore*; *Contra quaedam capitula errorum Abaelardi ad Innocentium II.* (in justification of the action of the synod of Sens); (b) ascetic and mystical, *De gradibus humilitatis et superbiae*, his first work, written perhaps about 1121; *De diligendo Deo* (about 1126); *De conversione ad clericos*, an address to candidates for the priesthood; *De Consideratione*, Bernard's last work, written about 1148 at the pope's request for the edification and guidance of Eugenius III.; (c) about monasticism, *Apologia ad Guilelmum*, written about 1127 to William, abbot of St Thierry; *De laude novae militiae ad milites templi* (c. 1132–1136); *De precepto et dispensatione*, an answer to various questions on monastic conduct and discipline addressed to him by the monks of St Peter at Chartres (some time before 1143); (d) on ecclesiastical government, *De moribus et officio episcoporum*, written about 1126 for Henry, bishop of Sens; the *De Consideratione* mentioned above; (e) a biography, *De vita et rebus gestis S. Malachiae, Hiberniae episcopi*, written at the request of the Irish abbot Congan and with the aid of materials supplied by him; it is of importance for the ecclesiastical history of Ireland in the 12th century; (f) sermons—divided into *Sermones de tempore*; *de sanctis*; *de diversis*; and eighty-six sermons, in *Cantica Cantuarum*, an allegorical and mystical exposition of the Song of Solomon; (g) hymns. Many hymns ascribed to Bernard survive, e.g. *Jesu dulcis memoria*, *Jesu rex admirabilis*, *Jesu decus angelicum*, *Sabae caput cruentatum*. Of these the three first are included in the Roman breviary. Many have been translated and are used in Protestant churches.

St Bernard's works were first published in anything like a complete edition at Paris in 1508, under the title *Seraphica mellifluis doctoris S. Bernardi scripta*, edited by André Bocard; the first really critical and complete edition is that of Dom J. Mabillon *Saucti Bernardi opp. &c.* (Paris, 1667, improved and enlarged in 1690, and again, by Massuet and Texier, in 1710), reprinted by J. P. Migne, *Patrolog. lat.* (Paris, 1859). There is an English translation of Mabillon's edition, including, however, only the letters and the sermons on the Song of Songs, with the biographical and other prefaces, by Samuel J. Eales (4 vols., London, 1889–1895). See further Leopold Janaschek,

Bibliographia Bernardina (Vienna, 1891), which includes 2761 entries, including 120 works wrongly ascribed to Bernard.

AUTHORITIES.—The principal source for the life of St Bernard is the *Vita Prima*, compiled, in six books, by various contemporary writers: book i. by William, abbot of St Thierry near Reims; book ii. by Ernard, or Arnald, abbot of Bonnevalle; books iii., iv. and v. by Geoffrey (Gaufrid), monk of Clairvaux and Bernard's secretary; book vi., on Bernard's miracles, by Geoffrey and Philip, another monk of Clairvaux, &c. A MS. is preserved, *int. al.*, in the library of Lambeth Palace (S. xiv. No. 163). The *Vita* was first published in *Bernardi op. omni.* by Mabillon (Paris, 1690), ii. pp. 1061 ff.; it was included in Migne, *Patrol. lat.* clxxxv. pp. 225-416, which also contains the abridgments or amplifications, by later hands, of the *Vita Prima*, known as the *Vita Secunda*, *Terria* and *Quarta*. For a critical study of these sources see G. Hüffer, *Der heilige Bernhard von Clairvaux* (2 vols., Münster, 1886), and E. Vacandard, *Vie de Saint Bernard* (2 vols., Paris, 1895).

Among the numerous modern works on St Bernard may be mentioned, besides the above, J. C. Morison, *The Life and Times of St Bernard* (London, 1863); G. Chevallier, *Histoire de Saint Bernard* (2 vols., Lille, 1888); S. J. Eales, *St Bernard, abbot of Clairvaux* (London, 1890, "Fathers for English Readers" series); *ib.* *Life and Works of St Bernard* (London, 1889); R. S. Storrs, *Bernard of Clairvaux: the Times, the Man and His Work* (New York, 1893); Comte d'Haussonville, *Saint Bernard* (Paris, 1906). See also the article by Vacandard in A. Vacant's *Dictionnaire de théologie* (with full bibliography), and that by St. Gertrude in Herzog's *Handb. der Realencyclopädie* (3rd ed.), vol. ii. (bibliography). Further works, monographs, &c., are given s. "Vita S. Bernardi" in Pottstast, *Bibliotheca Historica Medii Aevi* (Berlin, 1896). (W. A. P.)

BERNARD OF CHARTRES (1080?-1176), surnamed SYLVESTRIS, scholastic philosopher, described by John of Salisbury as *perfectissimus inter Platonicos nostri saeculi*. He and his brother Theodore were among the chief members of the school of Chartres (France), founded in the early part of the 11th century by Fulbert, the great disciple of Gerbert. This school flourished at a time when medieval thought was directed to the ancient philosophy of Plato and Aristotle, and had pervasively come to regard Aristotle as merely the founder of abstract logic and formal intellectualism, as opposed to Plato whose doctrine of Ideas seemed to tend in a naturalistic direction. Thus Bernard is a Platonist and yet the representative of a "return to Nature" which curiously anticipates the humanism of the early Renaissance. John of Salisbury (*Metalogicus*, iv. 35) attributes to him two treatises, of which one contrasts the eternity of ideas with the finite nature of things, and the other is an attempt to reconcile Plato and Aristotle. The only extant fragments of Bernard's writings are from a treatise *Megacosmos* and *Microcosmos* (edited by C. S. Barach at Innsbruck, 1876). The source of Bernard's inspiration was Plato's *Timaeus*. He maintained that ideas are really existent and are laid up for ever in the mind of God. He further attempted to build up a symbolism of numbers with the view of elaborating the doctrine of the Trinity, and explaining the meaning of unity, plurality and likeness.

See SCHOLASTICISM; also V. Cousin, *Œuvres inédites* of Abelard (Paris, 1836); Hauréau, *Philosophie scolastique*, i. 396 foll.

BERNARD, CHARLES DE, whose full name was PIERRE MARIE CHARLES DE BERNARD DU GRAL DE LA VILLETTE (1804-1850), French writer, was born at Besançon on the 25th of February 1804. After studying for the law, and then taking to journalism, he was encouraged by Balzac (whose *Peau de chagrin* he had reviewed) to settle in Paris and devote himself to authorship; and the result was a series of volumes of fiction, remarkable for their picture of provincial society and the Parisian bourgeoisie. The best of these are *Le Neud gordien* (1838), containing among other short stories *Une Aventure de magistrat*, from which Sardou drew his comedy of the *Pommes du voisin*; *Gerfauc* (1838), considered his masterpiece; *Les Ailes d'Icare* (1840), *La Peau du lion* (1841) and *Le Gentilhomme campagnard* (1847).

His *Œuvres complètes* (12 vols.), which appeared after his death on the 6th of March 1850, include also his poetry and two comedies written in collaboration with "Léonce" (C. H. L. Laurencot, 1805-1862). A flattering appreciation by Armand de Pontmartin is appended to this collection. In W. M. Thackeray's *Paris Sketch-book* ("On some fashionable French novels") there is an admirable criticism of Bernard. See also an essay by Henry James in *French Poets and Novelists* (1884).

BERNARD, CLAUDE (1813-1878), French physiologist, was born on the 12th of July 1813 in the village of Saint-Julien near Villefranche. He received his early education in the Jesuit school of that town, and then proceeded to the college at Lyons, which, however, he soon left to become assistant in a druggist's shop. His leisure hours were devoted to the composition of a vaudeville comedy, *La Rose du Rhône*, and the success it achieved moved him to attempt a prose drama in five acts, *Arthur de Bretagne*. At the age of twenty-one he went to Paris, armed with this play and an introduction to Saint-Marc Girardin, but the critic dissuaded him from adopting literature as a profession, and urged him rather to take up the study of medicine. This advice he followed, and in due course became interne at the Hôtel Dieu. In this way he was brought into contact with the great physiologist, F. Magendie, who was physician to the hospital, and whose official *préparateur* at the Collège de France he became in 1841. Six years afterwards he was appointed his deputy-professor at the collège, and in 1855 he succeeded him as full professor. Some time previously he had been chosen the first occupant of the newly-instituted chair of physiology at the Sorbonne. There no laboratory was provided for his use, but Louis Napoleon, after an interview with him in 1864, supplied the deficiency, at the same time building a laboratory at the natural history museum in the Jardin des Plantes, and establishing a professorship, which Bernard left the Sorbonne to accept in 1868—the year in which he was admitted a member of the Institute. He died in Paris on the 10th of February 1878 and was accorded a public funeral—an honour which had never before been bestowed by France on a man of science.

Claude Bernard's first important work was on the functions of the pancreas gland, the juice of which he proved to be of great significance in the process of digestion; this achievement won him the prize for experimental physiology from the Academy of Sciences. A second investigation—perhaps his most famous—was on the glycogenic function of the liver; in the course of this he was led to the conclusion, which throws light on the causation of diabetes, that the liver, in addition to secreting bile, is the seat of an "internal secretion," by which it prepares sugar at the expense of the elements of the blood passing through it. A third research resulted in the discovery of the vaso-motor system. While engaged, about 1851, in examining the effects produced in the temperature of various parts of the body by section of the nerve or nerves belonging to them, he noticed that division of the cervical sympathetic gave rise to more active circulation and more forcible pulsation of the arteries in certain parts of the head, and a few months afterwards he observed that electrical excitation of the upper portion of the divided nerve had the contrary effect. In this way he established the existence of vaso-motor nerves—both vaso-dilator and vaso-constrictor. The study of the physiological action of poisons was also a favourite one with him, his attention being devoted in particular to curare and carbon monoxide gas. The earliest announcements of his results, the most striking of which were obtained in the ten years from about 1850 to 1860, were generally made in the recognized scientific publications; but the full exposition of his views, and even the statement of some of the original facts, can only be found in his published lectures. The various series of these *Leçons* fill seventeen octavo volumes. He also published *Introduction à la médecine expérimentale* (1865), and *Physiologie générale* (1872).

An English *Life of Bernard*, by Sir Michael Foster, was published in London in 1899.

BERNARD, JACQUES (1658-1718), French theologian and publicist, was born at Nions in Dauphiné on the 1st of September 1658. Having studied at Geneva, he returned to France in 1679, and was chosen minister of Venterol in Dauphiné, whence he afterwards removed to the church of Vinsobres. As he continued to preach the reformed doctrines in opposition to the royal ordinance, he was obliged to leave the country and retired to Holland, where he was well received and appointed one of the pensionary ministers of Gouda. In July 1686 he commenced his *Histoire abrégée de l'Europe*, which he continued monthly till

December 1688. In 1692 he began his *Lettres historiques*, containing an account of the most important transactions in Europe; he carried on this work till the end of 1698, after which it was continued by others. When Le Clerc discontinued his *Bibliothèque universelle* in 1691, Bernard wrote the greater part of the twentieth volume and the five following volumes. In 1698 he collected and published *Actes et négociations de la paix de Ryswic*, in four volumes 12mo. In 1699 he began a continuation of Bayle's *Nouvelles de la république des lettres*, which continued till December 1710. In 1705 he was unanimously elected one of the ministers of the Walloon church at Leiden; and about the same time he succeeded M. de Valder in the chair of philosophy and mathematics at Leiden. In 1716 he published a supplement to Moreri's dictionary, in two volumes folio. The same year he resumed his *Nouvelles de la république des lettres*, and continued it till his death, on the 27th of April 1718. Besides the works above mentioned, he was the author of two practical treatises, one on late repentance (1712), the other on the excellence of religion (1714).

BERNARD, MOUNTAGUE (1820-1882), English international lawyer, the third son of Charles Bernard of Jamaica, the descendant of a Huguenot family, was born at Tibbicut Court, Gloucestershire, on the 28th of January 1820. He was educated at Sherborne school, and Trinity College, Oxford. Graduating B.A. in 1842, he took his B.C.L., was elected Vinerian scholar and fellow, and having read in chambers with Roundell Palmer (afterwards Lord Selborne), was called to the bar at Lincoln's Inn in 1846. He was specially interested in legal history and in church questions, and was one of the founders of the *Guardian*. In 1852 he was elected to the new professorship of international law and diplomacy at Oxford, attached to All Souls' College, of which he afterwards was made a fellow. But besides his duties at Oxford he undertook a good deal of non-collegiate work: he was a member of several royal commissions; in 1871 he went as one of the high commissioners to the United States, and signed the treaty of Washington, and in 1872 he assisted Sir Roundell Palmer before the tribunal of arbitration at Geneva. In 1874 he resigned his professorship at Oxford, but as member of the university of Oxford commission of 1876 he was mainly responsible for bringing about the compromise ultimately adopted between the university and the colleges. Bernard's reputation as an international lawyer was widespread, and he was an original member of the Institut de Droit International (1873). His published works include *An Historical Account of the Neutrality of Great Britain during the American Civil War* (London, 1870), and many lectures on international law and diplomacy.

BERNARD, SIMON (1770-1830), French general of engineers, was born at Dôle, educated at the École Polytechnique, and entered the army in the corps of engineers. He rose rapidly, and served (1805-1812) as aide-de-camp to Napoleon. He was wounded in the retreat after Leipzig, and distinguished himself the same year (1813) in the gallant defence of Torgau against the allies. After the emperor's fall he emigrated to the United States, where, being made a brigadier-general of engineers, he executed a number of extensive military works for the government, notably at Fortress Monroe, Va., and around New York, and did a large amount of the civil engineering connected with the Chesapeake and Ohio Canal and the Delaware Breakwater. He returned to France after the revolution of 1830, was made a lieutenant-general by Louis Philippe, and in 1836 served as minister of war.

BERNARD, SIR THOMAS, BART. (1750-1818), English social reformer, was born at Lincoln on the 27th of April 1750, the younger son of Sir Francis Bernard, 1st bart. (1711-1779), who as governor of Massachusetts Bay (1760-1770) played a responsible part in directing the British policy which led to the revolt of the American colonies. On the death of his elder brother in 1810, Bernard succeeded to the baronetcy conferred on his father in 1760. His early education was obtained in America, partly at Harvard, in which college his father took a great interest. He then acted as confidential secretary to his

father during the troubles which led (1766) to the governor's recall, and accompanied Sir Francis to England, where he was called to the bar, and practised as a conveyancer. He married a rich wife, and acquired a considerable fortune, and then devoted most of his time to social work for the benefit of the poor. He was treasurer of the Foundling Hospital, in the concerns of which he took an important part. He helped to establish in 1796 the "Society for Bettering the Condition and Increasing the Comforts of the Poor," in 1800 a school for indigent blind, and in 1801 a fever institution. He was active in promoting vaccination, improving the conditions of child labour, advocating rural allotments, and agitating against the salt duties. He took great interest in education, and with Count Rumford he was an originator of the Royal Institution in London. He died without issue on the 1st of July 1818.

BERNARDIN OF SIENA, ST (1380-1444), Franciscan friar and preacher, was born of a noble family in 1380. His parents died in his childhood, and on the completion of his education he spent some years in the service of the sick in the hospitals, and thus caught the plague, of which he nearly died. In 1402 he entered the Franciscan order in the strict branch called Observant, of which he became one of the chief promoters (see FRANCISCANS). Shortly after his profession the work of preaching was laid upon him, and for more than thirty years he preached with wonderful effect all over Italy, and played a great part in the religious revival of the beginning of the 15th century. In 1437 he became vicar-general of the Observant branch of the Franciscans. He refused three bishoprics. He died in 1444 at Aquila in the Abruzzi, and was canonized in 1450.

The first edition of his works, for the most part elaborate sermons, was printed at Lyons in 1501; later ones in 1636, 1650 and 1745. His Life will be found in the Bollandists and in *Lives of the Saints* on the 20th of May; a good modern biography has been written by Paul Thureau-Dangin (1896), and translated into English by Gertrude von Hügel (1908). (E. C. B.)

BERNAUER, AGNES (d. 1435), daughter of an Augsburg baker, was secretly married about 1432 to Albert (1401-1460), son of Ernest, duke of Bavaria-Munich. Ignorant of the fact that this union was a lawful one, Ernest urged his son to marry, and reproached him with his connexion with Agnes. Albert then declared she was his lawful wife; and subsequently, during his absence, she was seized by order of Duke Ernest and condemned to death for witchcraft. On the 12th of October 1435 she was drowned in the Danube near Straubing, in which town her remains were afterwards buried by Albert. This story lived long in the memory of the people, and its chief interest lies in its literary associations. It has afforded material for several dramas, and Adolf Büttger, Friedrich Hebbel and Otto Ludwig have each written one entitled *Agnes Bernauer*.

BERNAY, a town of north-western France, capital of an arrondissement in the department of Eure, on the left bank of the Charentonne, 31 m. W.N.W. of Evreux, on the Western railway between that town and Lisieux. Pop. (1906) 5973. It is beautifully situated in the midst of green wooded hills, and still justifies Madame de Staël's description of it as "a basket of flowers." Of great antiquity, it possesses numerous quaint wooden houses and ancient ecclesiastical buildings of considerable interest. The abbey church is now used as a market, and the abbey, which was founded by Judith of Brittany early in the 11th century, and underwent a restoration in the 17th century, serves for municipal and legal purposes. The church of Ste Croix, which has a remarkable marble figure of the infant Jesus, dates from the 14th and 15th centuries, that of Notre-Dame de la Couture, which preserves some good stained glass, from the 14th, 15th and 16th centuries. Bernay has a sub-prefecture, a communal college, tribunals of commerce and of first instance, and a board of trade-arbitrators. Among the industrial establishments of the place are manufactories of cotton and woollen goods, bleacheries and dye-works. Large numbers of Norman horses are sold in Lent, at the fair known as the *Foire fleurie*, and there is also a trade in grain. Bernay grew up round the Benedictine abbey mentioned above, and early in the 13th century was the seat of a viscount. The town, formerly fortified

was besieged by Bertrand du Guesclin, constable of France, in 1378; it was taken several times by the English during the first half of the 15th century, and by Admiral de Coligny in 1563. The fortress was razed in 1589.

BERNAYS, JAKOB (1824-1881), German philologist and philosophical writer, was born at Hamburg of Jewish parents on the 11th of September 1824. His father, Isaac Bernays (1792-1849), a man of wide culture, was the first orthodox German rabbi to preach in the vernacular. Jakob studied from 1844 to 1848 at the university of Bonn, the philological school of which, under Welcker and Ritschl (whose favourite pupil Bernays became), was the best in Germany. In 1853 he accepted the chair of classical philology at the newly founded Jewish theological college (the Fränkel seminary) at Breslau, where he formed a close friendship with Mommsen. In 1866, when Ritschl left Bonn for Leipzig, Bernays returned to his old university as extraordinary professor and chief librarian. He remained at Bonn until his death on the 26th of May 1881. His chief works, which deal mainly with the Greek philosophers, are:—*Die Lebensbeschreibung des J. J. Scaliger* (1855); *Über das Phokylidische Gedicht* (1856); *Die Chronik des Sulpicius Severus* (1861); *Die Dialoge des Aristoteles im Verhältnis zu seinen übrigen Werken* (1863); *Theophrastos' Schrift über Frömmigkeit* (1866); *Die Heraklitischen Briefe* (1869); *Lucian und die Cyniker* (1870); *Zwei Abhandlungen über die Aristotelische Theorie des Dramas* (1880). The last of these was a republication of his *Grundzüge der verlorenen Abhandlungen des Aristoteles über die Wirkung der Tragödie* (1857), which aroused considerable controversy.

See notices in *Biographisches Jahrbuch für Alterthumskunde* (1881), and *Algemeine deutsche Biographie*, xlv. (1902); art. in *Jewish Encyclopedia*; also Sandys, *Hist. of Class. Schol.* iii. 176 (1908).

His brother, **MICHAEL BERNAYS** (1834-1897), was born in Hamburg on the 27th of November 1834. He studied first law and then literature at Bonn and Heidelberg, and obtained a considerable reputation by his lectures on Shakespeare at Leipzig and an explanatory text to Beethoven's music to *Egmont*. Having refused an invitation to take part in the editorship of the *Preussische Jahrbücher*, in the same year (1866) he published his celebrated *Zur Kritik und Geschichte des Goetheschen-Textes*. He confirmed his reputation by his lectures at the university of Leipzig, and in 1873 accepted the post of extraordinary professor of German literature at Munich specially created for him by Louis II. of Bavaria. In 1874 he became an ordinary professor, a position which he only resigned in 1889 when he settled at Karlsruhe. He died at Karlsruhe on the 25th of February 1897. At an early age he had embraced Christianity, whereas his brother Jakob remained a Jew. Among his other publications were: *Briefe Goethes an F. A. Wolf* (1868); *Zur Entstehungsgeschichte des Schlegelschen Shakespeare* (1872); an introduction to Hirzel's collection entitled *Der junge Goethe* (1875); and he edited a revised edition of Voss's translation of *The Odyssey*. From his literary remains were published *Schriften zur Kritik und Litteraturgeschichte* (1895-1899).

BERNBURG, a town in the duchy of Anhalt, Germany, on the Saale, 29 m. N. by W. from Halle by rail, formerly the capital of the now incorporated duchy of Anhalt-Bernburg. Pop. (1900) 34,427; (1905) 34,920. It consists of four parts, the Altstadt or old town, the Bergstadt or hill town, the Neustadt or new town, and the suburb of Waldau—the Bergstadt on the right and the other three on the left of the river Saale, which is crossed by a massive stone bridge. It is a well-built city, the principal public buildings being the government house, the church of St Mary, the gymnasium and the house of correction. The castle, formerly the ducal residence, is in the Bergstadt, defended by moats, and surrounded by beautiful gardens. Bernburg is the seat of considerable industry, manufacturing machinery and boilers, sugar, pottery and chemicals, and has lead and zinc smelting. Market-gardening is also extensively carried on, and there is a large river traffic in grain and agricultural produce.

Bernburg is of great antiquity. The Bergstadt was fortified by Otto III. in the 10th century, and the new town was founded in the 13th. For a long period the different parts were under separate municipalities, the new town uniting with the old in 1560, and the Bergstadt with both in 1824. Prince Frederick removed the ducal residence to Ballenstedt in 1765.

BERNERS, JOHN BOURCHIER, 2ND BARON (1469-1533), English translator, was born probably at Tharfield, Hertfordshire, about 1469. His father was killed at Barnet in 1471, and he inherited his title in 1474 from his grandfather, John Bourchier, who was a descendant of Edward III. It is supposed that he was educated at Oxford, perhaps at Balliol. His political life began early, for in 1484 he was implicated in a premature attempt to place Henry, duke of Richmond (afterwards Henry VII.), on the throne, and fled in consequence to Brittany. In 1497 he helped to put down an insurrection in Cornwall and Devonshire, raised by Michael Joseph, a blacksmith, and from this time was in high favour at court. He accompanied Henry VIII. to Calais in 1513, and was a captain of pioneers at the siege of Therouanne. In the next year he was again sent to France as chamberlain to the king's sister Mary on her marriage with Louis XII., but he soon returned to England. He had been given the reversion of the office of lord chancellor, and in 1516 he received the actual appointment. In 1518 he was sent to Madrid to negotiate an alliance with Charles of Spain. He sent letters to Henry chronicling the bull-fights and other doings of the Spanish court, and to Wolsey complaining of the expense to which he was put in his position as ambassador. In the next year he returned to England, and with his wife Catherine Howard, daughter of the duke of Norfolk, was present in 1520 at the Field of the Cloth of Gold. But his affairs were greatly embarrassed. He was harassed by lawsuits about his Hertfordshire property and owed the king sums he was unable to repay. Perhaps in the hope of repairing his fortune, he accepted the office of deputy of Calais, where he spent the rest of his life in comparative leisure, though still harassed by his debts, and died on the 16th of March 1533.

His translation of *Syr Johan Froyssart of the Cronycles of England, France, Spayne, Portynagle, Scotland, Brelayne, Flaunders; and other places adjoynynge*, was undertaken at the request of Henry VIII., and was printed by Richard Pynson in two volumes dated 1523 and 1525. It was the most considerable historical work that had yet appeared in English, and exercised great influence on 16th-century chroniclers. Berners tells us in his prefaces of his own love of histories of all kinds, and in the introduction to his story of Arthur of Little Britain he excuses its "fayned mater" and "many unpossybyltyes" on the ground that other well reputed histories are equally incredible. He goes on to excuse his deficiencies by saying that he knew himself to be unskilled in the "faucundous arte of retoyryke," and that he was but a "lerner of the language of Frenschse." The want of rhetoric is not to be deplored. The style of his translation is clear and simple, and he rarely introduces French words or idioms. Two romances from the French followed: *The Boke of Duke Huon of Burdeux* (printed in the French by Wynkin de Worde), and *The History of the Moost noble and valyant knight Arthur of lytell brytayne*. His other two translations, *The Castell of Love* (printed 1540), from the *Carcel de Amor* of Diego de San Pedro, and *The Golden Boke of Marcus Aurelius* (completed six days before his death, printed 1534), from a French version of Antonio Guevara's book, are in a different manner. The *Golden Boke* gives Berners a claim to be a pioneer of Euphuism, although Lyly was probably acquainted with Guevara not through his version, but through Sir Thomas North's *Dial of Princes*. Berners is also credited with a book on the duties of the inhabitants of Calais, which Mr Sidney Lee thinks may be identical with the ordinance for watch and ward of Calais preserved in the Cotton MSS. and with a lost comedy, *Ite in vineam meam*, which used to be acted at Calais after vespers.

A biographical account of Berners is to be found in Mr Sidney Lee's introduction to *Huon of Bourdeux* (Early English Text Society

1882-1883). Among the many editions of his translation of Froissart may be mentioned that in the "Tudor Translations" (1901), with an introductory critical note by Professor W. P. Ker.

BERNERS, BARNES or **BERNES, JULIANA** (b. 1388 ?), English writer on hawking and hunting, is said to have been prioress of Sopwell nunnery near St Albans, and daughter of Sir James Berners, who was beheaded in 1388. She was probably brought up at court, and when she adopted the religious life, she still retained her love of hawking, hunting and fishing, and her passion for field sports. The only documentary evidence regarding her, however, is the statement at the end of her treatise on hunting in the *Boke of St Albans*, "Explicit Dam Juliana Barnes in her boke of huntynge" (edition of 1486), and the name is changed by Wynkyn de Worde to "dame Juliana Bernes." There is no such person to be found in the pedigree of the Berners family, and there is a gap in the records of the priory of Sopwell between 1430 and 1480. Juliana Berners is the supposed author of the work generally known as the *Boke of St Albans*. The first and rarest edition was printed in 1486 by an unknown schoolmaster at St Albans. It has no title-page. Wynkyn de Worde's edition (fol. 1496), also without a title-page, begins:—"This present boke shewyth the manere of hawkyng and huntynge: and also of duiysnyng of Cote armours. It shewyth also a good matere belongynge to horses: wyth other commendable treatyses. And ferdermore of the blasynge of armys: as hereafter it maye appere." This edition was adorned by three woodcuts, and included a "Treatyse of fysshynge wyth an Angle," not contained in the St Albans edition. J. Haslewood, who published a facsimile of that of Wynkyn de Worde (London, 1811, folio), with a biographical and bibliographical notice, examined with the greatest care the author's claims to figure as the earliest woman author in the English language. He assigned to her little else in the *Boke* except part of the treatise on hawking and the section on hunting. It is expressly stated at the end of the "Blasynge of Armys" that the section was "translatyd and compylt," and it is likely that the other treatises are translations, probably from the French. An older form of the treatise on fishing was edited in 1883 by Mr T. Satchell from a MS. in possession of Mr A. Denison. This treatise probably dates from about 1450, and formed the foundation of that section in the book of 1496. Only three perfect copies of the first edition are known to exist. A facsimile, entitled *The Book of St Albans*, with an introduction by William Blades, appeared in 1881. During the 16th century the work was very popular, and was many times reprinted. It was edited by Gervase Markham in 1595 as *The Gentleman's Academie*.

BERNHARD OF SAXE-WEIMAR, DUKE (1604-1639), a celebrated general in the Thirty Years' War, was the eleventh son of John, duke of Saxe-Weimar. He received an unusually good education, and studied at Jena, but soon went to the court of the Saxon elector to engage in knightly exercises. At the outbreak of the Thirty Years' War he took the field on the Protestant side, and served under Mansfeld at Wiesloch (1622), under the margrave of Baden at Wimpfen (1622), and with his brother William at Stadtlohn (1623). Undismayed by these defeats, he took part in the campaigns of the king of Denmark; and when Christian withdrew from the struggle Bernhard went to Holland and was present at the famous siege of Hertogenbosch (Bois-le-Duc) in 1629. When Gustavus Adolphus landed in Germany Bernhard quickly joined him, and for a short time he was colonel of the Swedish life guards. After the battle of Breitenfeld he accompanied Gustavus in his march to the Rhine and, between this event and the battle of the Alte Veste, Bernhard commanded numerous expeditions in almost every district from the Moselle to Tirol. At the Alte Veste he displayed the greatest courage, and at Lützen, when Gustavus was killed, Bernhard immediately assumed the command, killed a colonel who refused to lead his men to the charge, and finally by his furious energy won the victory at sundown. At first as a subordinate to his brother William, who as a Swedish lieutenant-general succeeded to the command, but later as an independent commander, Bernhard continued to push his forays over southern

Germany; and with the Swedish General Horn he made in 1633 a successful invasion into Bavaria, which was defended by the imperialist general Arldinger. In this year he acquired the duchy of Würzburg, installing one of his brothers as *Stadthalter*, and returning to the wars. A stern Protestant, he exacted heavy contributions from the Catholic cities which he took, and his repeated victories caused him to be regarded by German Protestants as the saviour of their religion. But in 1634 Bernhard suffered the great defeat of Nördlingen, in which the flower of the Swedish army perished. In 1635 he entered the service of France, which had now intervened in the war. He was now at the same time general-in-chief of the forces maintained by the Heilbronn union of Protestant princes, and a general officer in the pay of France. This double position was very difficult; in the following campaigns, ably and resolutely conducted as they were, Bernhard sometimes pursued a purely French policy, whilst at other times he used the French mercenaries to forward the cause of the princes. From a military point of view his most notable achievements were on the common ground of the upper Rhine, in the Breisgau. In his great campaign of 1638 he won the battles of Rheinfelden, Wittenweier and Thann, and captured successively Rheinfelden, Freiburg and Breisach, the last reputed one of the strongest fortresses in Europe. Bernhard had in the first instance received definite assurances from France that he should be given Alsace and Hagenau, Würzburg having been lost in the *débaîche* of 1634; he now hoped to make Breisach the capital of his new duchy. But his health was now broken. He died on the 8/18th of July 1639 at the beginning of the campaign, and the governor of Breisach was bribed to transfer the fortress to France. The duke was buried at Breisach, his remains being subsequently removed to Weimar.

See J. A. C. Helfferich, *Geschichte Bernhards des Grossen, Herzogs von Saxe-Weimar* (Jena, 1747); B. Röse, *Herzog Bernhard d. Herzog von Saxe-Weimar* (Weimar, 1828-1829); Droysen, *Bernhard v. Weimar* (Leipzig, 1885).

BERNHARDT, SARAH (ROSINE BERNARD) (1845-), French actress, was born in Paris on the 22nd of October 1845, of mixed French and Dutch parentage, and of Jewish descent. She was, however, baptized at the age of twelve and brought up in a convent. At thirteen she entered the Conservatoire, where she gained the second prize for tragedy in 1861 and for comedy in 1862. Her *début* was made at the Comédie Française on the 11th of August 1862, in a minor part in Racine's *Iphigénie en Aulide*, without any marked success, nor did she do much better in burlesque at the Porte St-Martin and Gymnase. In 1867 she became a member of the company at the Odéon, where she made her first definite successes as Cordelia in a French translation of *King Lear*, as the queen in Victor Hugo's *Ruy Blas*, and, above all, as Zanetto in François Coppée's *Le Passant* (1869). When peace was restored after the Franco-German War she left the Odéon for the Comédie Française, thereby incurring a considerable monetary forfeit. From that time she steadily increased her reputation, two of the most definite steps in her progress being her performances of Phèdre in Racine's play (1874) and of Dona Sol in Victor Hugo's *Hernani* (1877). In 1879 she had a famous season at the Gaiety in London. By this time her position as the greatest actress of her day was securely established. Her amazing power of emotional acting, the extraordinary realism and pathos of her death-scenes, the magnetism of her personality, and the beauty of her "voix d'or," made the public tolerant of her occasional caprices. She had developed some skill as a sculptor, and exhibited at the Salon at various times between 1876 (honourable mention) and 1881. She also exhibited a painting there in 1880. In 1878 she published a prose sketch, *Dans les nuages; les impressions d'une chaise*. Her comedy *L'Acme* was produced in 1888 at the Odéon without much success. Her relations with the other *sociétaires* of the Comédie Française having become somewhat strained, a crisis arrived in 1880, when, enraged by an unfavourable criticism of her acting, she threw up her position on the day following the first performance of Emile Augier's *L'Aventurier*. This obliged her to pay a forfeit of £4000 for breach of contract.

Immediately after the rupture she gave a series of performances in London, relying chiefly upon Scribe and Legouvé's *Adrienne Lecouvreur* and Meilhac and Halévy's *Frou Frou*. These were followed by tours in Denmark, America and Russia, during 1880 and 1881, with *La Dame aux camélias* as the principal attraction. In 1882 she married Jacques Damala, a Greek, in London, but separated from him at the end of the following year. After a fresh triumph in Paris with Sardou's *Fédora* at the Vaudeville she became proprietress of the Porte St-Martin. Jean Richepin's *Nana Sahib* (1883), Sardou's *Théodora* (1884) and *La Tosca* (1887), Jules Barbier's *Jeanne d'Arc* (1890) and Sardou and Moreau's *Citopâtre* (1890) were among her most conspicuous successes here, where she remained till she became proprietress of the Renaissance theatre in 1893. During those ten years she made several extended tours, including visits to America in 1886-1887 and 1888-1889. Between 1891 and 1893 she again visited America (North and South), Australia, and the chief European capitals. In November 1893 she opened the Renaissance with *Les Rois* by Jules Lemaitre, which was followed by *Sylvestre* and Morand's *Isely* (1894), Sardou's *Gismonda* (1894) and Edmond Rostand's *La Princesse lointaine* (1895). In 1895 she also appeared with conspicuous success as Magda in a French translation of Sudermann's *Heimat*. For the next few years she visited London almost annually, and America in 1896. In that year she made a success with an adaptation of Alfred de Musset's *Lorenzaccio*. In Easter week of 1897 she played in a religious drama, *La Samaritaine*, by Rostand. In December 1896 an elaborate fête was organized in Paris in her honour; and the value of this public recognition of her position at the head of her profession was enhanced by cordial greetings from all parts of the world. By this time she had played one hundred and twelve parts, thirty-eight of which she had created. Early in 1899 she removed from the Renaissance to the Théâtre des Nations, a larger house, which she opened with a revival of *La Tosca*. In the same year she made the bold experiment of a French production of *Hamlet*, in which she played the title part. She repeated the impersonation in London not long afterwards, where she also appeared (1901) as the fate-ridden son of Napoleon I., in Rostand's *L'Aiglon*, which had been produced in Paris the year before. Of the successful productions of her later years perhaps none was more remarkable than her impersonation of La Tisbé in Victor Hugo's romantic drama *Angelo* (1905).

See Jules Huret, *Romantic Bernhardt* (1889); and her own volume of autobiography (1907).

BERNHARDY, GOTTFRIED (1800-1875), German philologist and literary historian, was born on the 20th of March 1800, at Landsberg on the Wartia, in Brandenburg. He was the son of Jewish parents in reduced circumstances. Two well-to-do uncles provided the means for his education, and in 1811 he entered the Joachimsthal gymnasium at Berlin. In 1817 he went to Berlin University to study philology, where he had the advantage of hearing F. A. Wolf (then advanced in years), August Böckh and P. Buttmann. In 1822 he took the degree of doctor of philosophy at Berlin, and in 1825 became extraordinary professor. In 1829 he succeeded C. Reisig as ordinary professor and director of the philological seminary at Halle, and in 1844 was appointed chief librarian of the university. He died suddenly on the 14th of May 1875. The most important of Bernhardt's works were his histories (or sketches) of Greek and Roman literature; *Grundriss der römischen Litteratur* (5th ed., 1872); *Grundriss der griechischen Litteratur* (pt. I., Introduction and General View, 1836; pt. II., Greek Poetry, 1845; pt. III., Greek Prose Literature, was never published). A fifth edition of pts. I. and II., by R. Volkmann, began in 1892. Other works by Bernhardt are: *Eratosthenica* (1822); *Wissenschaftliche Syntax der griechischen Sprache* (1829, suppts. 1854, 1862); *Grundlinien zur Encyclopädie der Philologie* (1832); the monumental edition of the Lexicon of Suidas (1834-1853); and an edition of F. A. Wolf's *Kleine Schriften* (1869).

See Volkmann, *C. Bernhardt* (1887).

BERNI, FRANCESCO (1497-1536), Italian poet, was born about 1497 at Lamporecchio, in Bibbiena, a district lying along

the Upper Arno. His family was of good descent, but excessively poor. At an early age he was sent to Florence, where he remained till his 10th year. He then set out for Rome, trusting to obtain some assistance from his uncle, the Cardinal Bibbiena. The cardinal, however, did nothing for him, and he was obliged to accept a situation as clerk or secretary to Ghiberti, datary to Clement VII. The duties of his office, for which Berni was in every way unfit, were exceedingly irksome to the poet, who, however, made himself celebrated at Rome as the most witty and inventive of a certain club of literary men, who devoted themselves to light and sparkling effusions. So strong was the admiration for Berni's verses, that mocking or burlesque poems have since been called *poesie bernesca*. About the year 1530 he was relieved from his servitude by obtaining a canonry in the cathedral of Florence. In that city he died in 1536, according to tradition poisoned by Duke Alessandro de' Medici, for having refused to poison the duke's cousin, Ippolito de' Medici; but considerable obscurity rests over this story. Berni stands at the head of Italian comic or burlesque poets. For lightness, sparkling wit, variety of form and fluent diction, his verses are unsurpassed. Perhaps, however, he owes his greatest fame to the recasting (*Rifacimento*) of Boiardo's *Orlando Innamorato*. The enormous success of Ariosto's *Orlando Furioso* had directed fresh attention to the older poem, from which it took its characters, and of which it is the continuation. But Boiardo's work, though good in plan, could never have achieved wide popularity on account of the extreme ruggedness of its style. Berni undertook the revision of the whole poem, avowedly altering no sentiment, removing or adding no incident, but simply giving to each line and stanza due gracefulness and polish. His task he completed with marvellous success; scarcely a line remains as it was, and the general opinion has pronounced decisively in favour of the revision over the original. To each canto he prefixed a few stanzas of reflective verse in the manner of Ariosto, and in one of these introductions he gives us the only certain information we have concerning his own life. Berni appears to have been favourably disposed towards the Reformation principles at that time introduced into Italy, and this may explain the bitterness of some remarks of his upon the church. The first edition of the *Rifacimento* was printed posthumously in 1541, and it has been supposed that a few passages either did not receive the author's final revision, or have been retouched by another hand.

A partial translation of Berni's *Orlando* was published by W. S. Rose (1823).

BERNICIAN, the northern of the two English kingdoms which were eventually united in the kingdom of Northumbria. Its territory is said to have stretched from the Tyne northwards, ultimately reaching the Forth, while its western frontier was gradually extended at the expense of the Welsh. The chief royal residence was Bamburgh, and near it was the island of Lindisfarne, afterwards the see of a bishop. The first king of whom we have any record is Ida, who is said to have obtained the throne about 547. Æthelfrith, king of Bernicia, united Deira to his own kingdom, probably about 605, and the union continued under his successor Edwin, son of Ella or Ælle, king of Deira. Bernicia was again separate from Deira under Eanfrith, son of Æthelfrith (633-634), after which date the kings of Bernicia were supreme in Northumbria, though for a short time under Oswio Deira had a king of its own.

See Bede, *Hist. Eccles.* ii. 14, iii. 1, 14; Nennius, § 63; Simeon of Durham, i. 339. (F. G. M. B.)

BERNICIAN SERIES, in geology, a term proposed by S. P. Woodward in 1856 (*Manual of Mollusca*, p. 400) for the lower portion of the Carboniferous System, below the Millstone Grit. The name was suggested by that of the ancient province of Bernicia on the Anglo-Scottish borderland. It is practically equivalent to the "Daninian" of A. de Lapparent and Munier-Chalmas (1893). In 1875 G. Tate's "Calcareous and Carbonaceous" groups of the Carboniferous Limestone series of Northumberland were united by Professor Lebour into a single series, to which he applied the name "Bernician"; but later he speaks of the whole of the Carboniferous rocks of Northumberland and its

borders as of the "Bernician type," which is the most satisfactory way in which the term may now be used (*Report of the Brit. Sub-committee on Classification and Nomenclature*, 2nd ed., Cambridge, 1888). "Demetian" was the corresponding designation proposed by Woodward for the Upper Carboniferous rocks.

BERNINI, GIOVANNI LORENZO (1598-1680), Italian artist, was born at Naples. He was more celebrated as an architect and a sculptor than as a painter. At a very early age his great skill in modelling introduced him to court favour at Rome, and he was specially patronized by Maffeo Barberini, afterwards Pope Urban VIII., whose palace he designed. None of his sculptured groups at all come up to the promised excellence of his first effort, the Apollo and Daphne, nor are any of his paintings of particular merit. His busts were in so much request that Charles I. of England, being unable to have a personal interview with Bernini, sent him three portraits by Vandyck, from which the artist was enabled to complete his model. His architectural designs, including the great colonnade of St Peter's, brought him perhaps his greatest celebrity. Louis XIV., when he contemplated the restoration of the Louvre, sent for Bernini, but did not adopt his designs. The artist's progress through France was a triumphal procession, and he was most liberally rewarded by the great monarch. He left a fortune of over £100,000.

BERNIS, FRANÇOIS JOACHIM DE PIERRE DE (1715-1794), French cardinal and statesman, was born at St Marcel-d'Ardèche on the 22nd of May 1715. He was of a noble but impoverished family, and, being a younger son, was intended for the church. He was educated at the Louis-le-Grand college and the seminary of Saint-Sulpice, Paris, but did not take orders till 1755. He became known as one of the most expert epigrammatists in the gay society of Louis XV.'s court, and by his verses won the friendship of Madame de Pompadour, the royal mistress, who obtained for him an apartment, furnished at her expense, in the Tuilleries, and a yearly pension of 1500 livres (about £60). In 1751 he was appointed to the French embassy at Venice, where he acted, to the satisfaction of both parties, as mediator between the republic and Pope Benedict XIV. During his stay in Venice he received subdeacon's orders, and on his return to France in 1755 was made a papal councillor of state. He took an important part in the delicate negotiations between France and Austria which preceded the Seven Years' War. He regarded the alliance purely as a temporary expedient, and did not propose to employ the whole forces of France in a general war. But he was overruled by his colleagues. He became secretary for foreign affairs on the 27th of June 1757, but owing to his attempts to counteract the spendthrift policy of the marquise de Pompadour and her creatures, he fell into disgrace and was in December 1758 banished to Soissons by Louis XV., where he remained in retirement for six years. In the previous November he had been created cardinal by Clement XIII. On the death of the royal mistress in 1764, Bernis was recalled and once more offered the seals of office, but declined them, and was appointed archbishop of Albi. His occupancy of the see was not of long duration. In 1769 he went to Rome to assist at the conclave which resulted in the election of Clement XIV., and the talent which he displayed on that occasion procured him the appointment of ambassador in Rome, where he spent the remainder of his life. He was partly instrumental in bringing about the suppression of the Jesuits, and acted with greater moderation than is generally allowed. He lost his influence under Pius VI., who was friendly to the Jesuits, and the French Revolution, to which he was hostile, reduced him almost to penury; the court of Spain, however, mindful of the support he had given to their ambassador in obtaining the condemnation of the Jesuits, came to his relief with a handsome pension. He died at Rome on the 3rd of November 1794, and was buried in the church of S. Luigi de' Francesi. In 1803 his remains were transferred to the cathedral at Nîmes. His poems, the longest of which is *La Religion vengée* (Parma, 1794), have no merit; they were collected and published after his death (Paris, 1797, &c.); his *Mémoires et lettres 1715-58* (2 vols., Paris, 1878) are still interesting to the historian.

See Frédéric Masson's prefaces to the *Mémoires et lettres*, and *Le Cardinal de Bernis depuis son ministère* (Paris, 1884); E. et J. de Goncourt, *Mme de Pompadour* (Paris, 1888), and Sainte-Beuve, *Causeries du lundi*, t. viii.

BERNKASTEL, a town of Germany, in the Prussian Rhine province, on the Mosel, in a deep and romantic valley, connected by a branch to Wengerohr with the main Trier-Coblenz railway. Pop. 2300. It has some unimportant manufactures; the chief industry is in wine, of which Bernkastel Doctor enjoys great repute. Above the town lie the ruins of the castle Landstut. Bernkastel originally belonged to the chapter of Trier, and received its name from one of the provosts of the cathedral, Adalbero of Luxemburg (hence *Adalberonis castellum*).

BERNOULLI, or **BERNOULLI**, the name of an illustrious family in the annals of science, who came originally from Antwerp. Driven from their country during the oppressive government of Spain for their attachment to the Reformed religion, the Bernoullis sought first an asylum at Frankfort (1583), and afterwards at Basel, where they ultimately obtained the highest distinctions. In the course of a century eight of its members successfully cultivated various branches of mathematics, and contributed powerfully to the advance of science. The most celebrated were Jacques (James), Jean (John) and Daniel, the first, second and fourth as dealt with below; but, for the sake of perspicuity they may be considered as nearly as possible in the order of family succession. A complete summary of the great developments of mathematical learning, which the members of this family effected, lies outside the scope of this notice. More detailed accounts are to be found in the various mathematical articles.

J. JACQUES BERNOULLI (1654-1705), mathematician, was born at Basel on the 27th of December 1654. He was educated at the public school of Basel, and also received private instruction from the learned Hoffmann, then professor of Greek. At the conclusion of his philosophical studies at the university, some geometrical figures, which fell in his way, excited in him a passion for mathematical pursuits, and in spite of the opposition of his father, who wished him to be a clergyman, he applied himself in secret to his favourite science. In 1676 he visited Geneva on his way to France, and subsequently travelled to England and Holland. While at Geneva he taught a blind girl several branches of science, and also how to write; and this led him to publish *A Method of Teaching Mathematics to the Blind*. At Bordeaux his *Universal Tables on Dialling* were constructed; and in London he was admitted to the meetings of Robert Boyle, Robert Hooke and other learned and scientific men. On his final return to Basel in 1682, he devoted himself to physical and mathematical investigations, and opened a public seminary for experimental physics. In the same year he published his essay on comets, *Conamen Novi Systematis Cometarum*, which was occasioned by the appearance of the comet of 1680. This essay, and his next publication, entitled *De Gravitate Adheris*, were deeply tinged with the philosophy of René Descartes, but they contain truths not unworthy of the philosophy of Sir Isaac Newton's *Principia*.

Jacques Bernoulli cannot be strictly called an independent discoverer; but, from his extensive and successful application of the calculus and other mathematical methods, he is deserving of a place by the side of Newton and Leibnitz. As an additional claim to remembrance, he was the first to solve Leibnitz's problem of the isochronous curve (*Acta Eruditorum*, 1690). He proposed the problem of the catenary (*q.v.*) or curve formed by a chain suspended by its two extremities, accepted Leibnitz's construction of the curve and solved more complicated problems relating to it. He determined the "elastic curve," which is formed by an elastic plate or rod fixed at one end and bent by a weight applied to the other, and which he showed to be the same as the curvature of an impervious sail filled with a liquid (*littoria*). In his investigations respecting cycloidal lines and various spiral curves, his attention was directed to the loxodromic and logarithmic spirals, in the last of which he took particular interest from its remarkable property of reproducing itself under a variety of conditions.

In 1696 he proposed the famous problem of isoperimetrical figures, and offered a reward for its solution. This problem engaged the attention of British as well as continental mathematicians; and its proposal gave rise to a painful quarrel with his brother Jean. Jean offered a solution of the problem; his brother pronounced it to be wrong. Jean then amended his solution, and again offered it, and claimed the reward. Jacques still declared it to be no solution, and soon after published his own. In 1701 he published also the demonstration of his solution, which was accepted by the marquis de l'Hôpital and Leibnitz. Jean, however, held his peace for several years, and then dishonestly published, after the death of Jacques, another incorrect solution; and not until 1718 did he admit that he had been in error. Even then he set forth as his own his brother's solution purposely disguised.

In 1687 the mathematical chair of the university of Basel was conferred upon Jacques. He was once made rector of his university, and had other distinctions bestowed on him. He and his brother Jean were the first two foreign associates of the Academy of Sciences of Paris; and, at the request of Leibnitz, they were both received as members of the academy of Berlin. In 1684 he had been offered a professorship at Heidelberg; but his marriage with a lady of his native city led him to decline the invitation. Intense application brought on infirmities and a slow fever, of which he died on the 16th of August 1705. Like another Archimedes, he requested that the logarithmic spiral should be engraven on his tombstone, with these words, *Eadem multa resurgo*.

Jacques Bernoulli wrote elegant verses in Latin, German and French; but although these were held in high estimation in his own time, it is on his mathematical works that his fame now rests. These are—*Jacobi Bernoulli Basilienensis Opera* (Genevæ, 1744), 2 tom. 4to; *Arts Conjectandæ, opus posthumum: accedunt tractatus de Series Infinitis, et epistola (Gallicè scripta) de Ludo Piliæ Reticularis* (Basiliæ, 1713), 1 tom. 4to.

II. JEAN BERNOULLI (1667-1748), brother of the preceding, was born at Basel on the 27th of July 1667. After finishing his literary studies he was sent to Neuchâtel to learn commerce and acquire the French language. But at the end of a year he renounced the pursuits of commerce, returned to the university of Basel, and was admitted to the degree of bachelor in philosophy; and a year later, at the age of 18, to that of master of arts. In his studies he was aided by his elder brother Jacques. Chemistry, as well as mathematics, seems to have been the object of his early attention; and in the year 1690 he published a dissertation on effervescence and fermentation. The same year he went to Geneva, where he gave instruction in the differential calculus to Nicolas Fatio de Duillier, and afterwards proceeded to Paris, where he enjoyed the society of N. Malebranche, J. D. Cassini, Philip de Lahire and Pierre Varignon. With the marquis de l'Hôpital he spent four months studying higher geometry and the resources of the new calculus. His independent discoveries in mathematics are numerous and important. Among these were the exponential calculus, and the curve called by him the *linea brachistochrona*, or line of swiftest descent, which he was the first to determine, pointing out at the same time the relation which this curve bears to the path described by a ray of light passing through strata of variable density. On his return to his native city he studied medicine, and in 1694 took the degree of M.D. Although he had declined a professorship in Germany, he now accepted an invitation to the chair of mathematics at Groningen (*Commercium Philosophicum*, epist. xi. and xii.). There, in addition to the learned lectures by which he endeavoured to revive mathematical science in the university, he gave a public course of experimental physics. During a residence of ten years in Groningen, his controversies were almost as numerous as his discoveries. His dissertation on the "barometric light," first observed by Jean Picard, and discussed by Jean Bernoulli under the name of mercurial phosphorus, or mercury shining in vacuo (*Diss. physica de mercurio lucente in vacuo*), procured him the notice of royalty, and engaged him in controversy. Through the influence of Leibnitz he received from the king of Prussia a gold medal for his supposed discoveries; but Nicolaus Hartsoeker

and some of the French academicians disputed the fact. The family quarrel about the problem of isoperimetrical figures above mentioned began about this time. In his dispute with his brother, in his controversies with the English and Scottish mathematicians, and in his harsh and jealous bearing to his son Daniel, he showed a mean, unfair and violent temper. He had declined, during his residence at Groningen, an invitation to Utrecht, but accepted in 1705 the mathematical chair in the university of his native city, vacant by the death of his brother Jacques; and here he remained till his death. His inaugural discourse was on the "new analysis," which he so successfully applied in investigating various problems both in pure and applied mathematics.

He was several times a successful competitor for the prizes given by the Academy of Sciences of Paris; the subjects of his essays being:—the laws of motion (*Discours sur les lois de la communication du mouvement*, 1727), the elliptical orbits of the planets, and the inclinations of the planetary orbits (*Essai d'une nouvelle physique celeste*, 1735). In the last case his son Daniel divided the prize with him. Some years after his return to Basel he published an essay, entitled *Nouvelle Théorie de la manœuvre des vaisseaux*. It is, however, his works in pure mathematics that are the permanent monuments of his fame. Jean le Rond d'Alembert acknowledges with gratitude, that "whatever he knew of mathematics he owed to the works of Jean Bernoulli." He was a member of almost every learned society in Europe, and one of the first mathematicians of a mathematical age. He was as keen in his resentments as he was ardent in his friendships; fondly attached to his family, he yet disliked a deserving son; he gave full praise to Leibnitz and Leonhard Euler, yet was blind to the excellence of Sir Isaac Newton. Such was the vigour of his constitution that he continued to pursue his usual mathematical studies till the age of eighty. He was then attacked by a complaint at first apparently trifling; but his strength daily and rapidly declined till the 1st of January 1748, when he died peacefully in his sleep.

His writings were collected under his own eye by Gabriel Cramer, professor of mathematics at Geneva, and published under the title of *Johannis Bernoulli Operi Omnia* (Lausan. et Genevæ), 4 tom. 4to; his interesting correspondence with Leibnitz appeared under the title of *Gul. Leibnitzii et Johannis Bernoulli Commercium Philosophicum et Mathematicum* (Lausan. et Genevæ, 1745), 2 tom. 4to.

III. NICOLAS BERNOULLI (1695-1726), the eldest of the three sons of Jean Bernoulli, was born on the 27th of January 1695. At the age of eight he could speak German, Dutch, French and Latin. When his father returned to Basel he went to the university of that city, where, at the age of sixteen, he took the degree of doctor in philosophy, and four years later the highest degree in law. Meanwhile the study of mathematics was not neglected, as appears not only from his giving instruction in geometry to his younger brother Daniel, but from his writings on the differential, integral, and exponential calculus, and from his father considering him, at the age of twenty-one, worthy of receiving the torch of science from his own hands. ("Lampada nunc tradam filio meo natu maximo, juveni xxi. annorum, ingenio mathematico aliusque dotibus sastro instructo," *Com. Phil. ep. 223*.) With his father's permission he visited Italy and France, and during his travels formed friendship with Pierre Varignon and Count Riccati. The invitation of a Venetian nobleman induced him again to visit Italy, where he resided two years, till his return to be a candidate for the chair of jurisprudence at Basel. He was unsuccessful, but was soon afterwards appointed to a similar office in the university of Bern. Here he resided three years, his happiness only marred by regret on account of his separation from his brother Daniel. Both were appointed at the same time professors of mathematics in the academy of St Petersburg; but this office Nicolas enjoyed for little more than eight months. He died on the 26th of July 1726 of a lingering fever. Sensible of the loss which the nation had sustained by his death, the empress Catherine ordered him a funeral at the public expense.

Some of his works are published in his father's works, and others in the *Acta Eruditorum* and the *Comment. Acad. Petropol.*

IV. DANIEL BERNOULLI (1700-1782), the second son of Jean Bernoulli, was born on the 29th of January 1700, at Groningen. He studied medicine and became a physician, but his attention was early directed also to geometrical studies. The severity of his father's manner was ill-calculated to encourage the first efforts of one so sensitive; but fortunately, at the age of eleven, he became the pupil of his brother Nicolas. He afterwards studied in Italy under Francesco Domenico Michelotti and Giambattista Morgagni. After his return, though only twenty-four years of age, he was invited to become president of an academy then projected at Genoa; but, declining this honour, he was, in the following year, appointed professor of mathematics at St Petersburg. In consequence of the state of his health, however, he returned to Basel in 1733, where he was appointed professor of anatomy and botany, and afterwards of experimental and speculative philosophy. In the labours of this office he spent the remaining years of his life. He had previously published some medical and botanical dissertations, besides his *Exercitationes quaedam Mathematicae*, containing a solution of the differential equation proposed by Riccati and now known by his name. In 1738 appeared his *Hydrodynamica*, in which the equilibrium, the pressure, the reaction and varied velocities of fluids are considered both theoretically and practically. One of these problems, illustrated by experiment, deals with an ingenious mode of propelling vessels by the reaction of water ejected from the stern. Some of his experiments on this subject were performed before Pierre Louis M. de Maupertuis and Alexis Claude Clairaut, whom the fame of the Bernoullis had attracted to Basel. With a success equalled only by Leonhard Euler, Daniel Bernoulli gained or shared no less than ten prizes of the Academy of Sciences of Paris. The first, for a memoir on the construction of a clesydra for measuring time exactly at sea, he gained at the age of twenty-four; the second, for one on the physical cause of the inclination of the planetary orbits, he divided with his father; and the third, for a communication on the tides, he shared with Euler, Colin Maclaurin and another competitor. The problem of vibrating cords, which had been some time before resolved by Brook Taylor (1685-1731) and d'Alembert, became the subject of a long discussion conducted in a generous spirit between Bernoulli and his friend Euler. In one of his early investigations he gave an ingenious though indirect demonstration of the problem of the parallelogram of forces. His labours in the decline of life were chiefly directed to the doctrine of probabilities in reference to practical purposes, and in particular to economical subjects, as, for example, to inoculation, and to the duration of married life in the two sexes, as well as to the relative proportion of male and female births. He retained his usual vigour of understanding till near the age of eighty, when his nephew Jacques relieved him of his public duties. He was afflicted with asthma, and his retirement was relieved only by the society of a few chosen friends. He died on the 17th of March 1782 at Basel. Excluded by his professional character from the councils of the republic, he nevertheless received all the deference and honour due to a first magistrate. He was wont to mention the following as the two incidents in his life which had afforded him the greatest pleasure,—that a stranger, whom he had met as a travelling companion in his youth, made to his declaration "I am Isaac Bernoulli" the incredulous and mocking reply, "And I am Isaac Newton"; and that, while entertaining König and other guests, he solved without rising from table a problem which that mathematician had submitted as difficult and lengthy. Like his father, he was a member of almost every learned society of Europe, and he succeeded him as foreign associate of the Academy of Paris.

Several of his investigations are contained in the earlier volumes of the *Comment. Acad. Petropol.*; and his separately published works are:—*Dissertatio Inaugur. Phys. Med. de Respiratione* (Basil. 1721), 4to; *Positiones Anatomico-Botanicæ* (Basil. 1721), 4to; *Exercitationes quaedam Mathematicæ* (Venetis, 1724), 4to; *Hydrodynamica* (Argentorati, 1738), 4to.

V. JEAN BERNOULLI (1710-1790), the youngest of the three sons of Jean Bernoulli, was born at Basel on the 18th of May 1710. He studied law and mathematics, and, after travelling in

France, was for five years professor of eloquence in the university of his native city. On the death of his father he succeeded him as professor of mathematics. He was thrice a successful competitor for the prizes of the Academy of Sciences of Paris. His prize subjects were, the capstan, the propagation of light, and the magnet. He enjoyed the friendship of P. L. M. de Maupertuis, who died under his roof while on his way to Berlin. He himself died in 1790. His two sons, Jean and Jacques, are the last noted mathematicians of the family.

VI. NICOLAS BERNOULLI (1687-1750), cousin of the three preceding, and son of Nicolas Bernoulli, one of the senators of Basel, was born in that city on the 10th of October 1687. He visited England, where he was kindly received by Sir Isaac Newton and Edmund Halley (*Com. Phil.* ep. 199), held for a time the mathematical chair at Padua, and was successively professor of logic and of law at Basel, where he died on the 29th of November 1750. He was editor of the *Ars Conjectandi* of his uncle Jacques. His own works are contained in the *Acta Eruditorum*, the *Giornale de' letterati d'Italia*, and the *Commercium Philosophicum*.

VII. JEAN BERNOULLI (1744-1807), grandson of the first Jean Bernoulli, and son of the second of that name, was born at Basel on the 4th of November 1744. He studied at Basel and at Neuchâtel, and when thirteen years of age took the degree of doctor in philosophy. At nineteen he was appointed astronomer royal of Berlin. Some years after, he visited Germany, France and England, and subsequently Italy, Russia and Poland. On his return to Berlin he was appointed director of the mathematical department of the academy. Here he died on the 13th of July 1807. His writings consist of travels and astronomical, geographical and mathematical works. In 1774 he published a French translation of Leonhard Euler's *Elements of Algebra*. He contributed several papers to the Academy of Berlin.

VIII. JACQUES BERNOULLI (1750-1789), younger brother of the preceding, and the second of this name, was born at Basel on the 17th of October 1750. Having finished his literary studies, he was, according to custom, sent to Neuchâtel to learn French. On his return he graduated in law. This study, however, did not check his hereditary taste for geometry. The early lessons which he had received from his father were continued by his uncle Daniel, and such was his progress that at the age of twenty-one he was called to undertake the duties of the chair of experimental physics, which his uncle's advanced years rendered him unable to discharge. He afterwards accepted the situation of secretary to count de Brenner, which afforded him an opportunity of seeing Germany and Italy. In Italy he formed a friendship with Lorgna, professor of mathematics at Verona, and one of the founders of the *Società Italiana* for the encouragement of the sciences. He was also made corresponding member of the royal society of Turin; and, while residing at Venice, he was, through the friendly representation of Nicolaus von Fuss, admitted into the academy of St Petersburg. In 1788 he was named one of its mathematical professors.

He was tragically drowned while bathing in the Neva in July 1789, a few months after his marriage with a daughter of Albert Euler, son of Leonhard Euler.

Several of his papers are contained in the first six volumes of *Nova Acta Acad. Scien. Imper. Petropol.*, in the *Acta Helvetica*, in the *Memoirs of the Academies of Berlin and Turin*, and in his brother John's publications. He also published separately some juridical and physical theses, and a German translation of *Mémoires du philosophe de Merian*. See generally M. Cantor, *Geschichte der Mathematik*; J. C. Poggendorff, *Biographisch-literarisches Handwörterbuch* (1863-1904).

BERNSTEIN, AARON (1812-1884), Jewish scientist, author and reformer. In the middle of the 19th century Bernstein took an active share in the movement for synagogue reform in Germany. He was the author of two delightful Ghetto stories, *Vögel der Maggid* and *Mendel Gibbor*, being one of the originators of this genre of modern fiction. He was also a publicist, and his *History of Revolution and Reaction in Germany* (3 vols., 1883-1884) was a collection of important political essays.

BERNSTORFF, ANDREAS PETER, COUNT VON (1735-1797), Danish statesman, was born at Hanover on the 28th of August 1735. His career was determined by his uncle, Johann Hartwig Ernst Bernstorff, who early discerned the talents of his nephew and induced him to study in the German and Swiss universities and travel for some years in Italy, France, England and Holland, to prepare himself for a statesman's career. During these *Wanderjahre* he made the acquaintance of the poets Gellert and Jacobi, the learned Jean-Jacques Barthélemy, the duc de Choiseul, and Gottfried Achenwall, the statistician. At his uncle's desire he rejected the Hanoverian for the Danish service, and in 1750 took his seat in the German chancery at Copenhagen. In 1767, at the same time as his uncle, he was created a count, and in 1769 was made a privy-councillor. He is described at this period as intellectual, upright and absolutely trustworthy, but obstinate and self-opinionated to the highest degree, arguing with antiquaries about coins, with equestrians about horses, and with foreigners about their own countries, always certain that he was right and they wrong, whatever the discussion might be. He shared the disgrace of his uncle when Struensee came into power, but re-entered the Danish service after Struensee's fall at the end of 1772, working at first in the financial and economical departments, and taking an especial interest in agriculture. The improvements he introduced in the tenures of his peasantry anticipated in some respects the agricultural reforms of the next generation.

In April 1773 Bernstorff was transferred to the position for which he was especially fitted, the ministry of foreign affairs, with which he combined the presidency of the German chancery (for Schleswig-Holstein). His predecessor, Adolf Siegfried Osten, had been dismissed because he was not *persona grata* at St Petersburg, and Bernstorff's first official act was to conclude the negotiations which had long been pending with the grand-duke Paul as duke of Holstein-Gottorp. The result was the exchange-treaty of the 1st of June (May 21 O.S.) 1773, confirming the previous treaty of 1767 (see **BERNSTORFF, J. H. E.**). This was followed by the treaty of alliance between Denmark and Russia of the 12th of August 1773, which was partly a mutually defensive league, and partly an engagement between the two states to upset the new constitution recently established in Sweden by Gustavus III., when the right moment for doing so should arrive. For this mischievous and immoral alliance, which bound Denmark to the wheels of the Russian empress's chariot and sought to interfere in the internal affairs of a neighbouring state, Bernstorff was scarcely responsible, for the preliminaries had been definitely settled in his uncle's time and he merely concluded them. But there can be no doubt that he regarded this anti-Swedish policy as the correct one for Denmark, especially with a monarch like Gustavus III. on the Swedish throne. It is also pretty certain that the anti-Swedish alliance was Russia's price for compounding the Gottorp difficulty.

Starting from the hypothesis that Sweden was "Denmark-Norway's most active and irreconcilable enemy," Bernstorff logically included France, the secular ally of Sweden, among the hostile powers with whom an alliance was to be avoided, and drew near to Great Britain as the natural foe of France, especially during the American War of Independence, and this too despite the irritation occasioned in Denmark-Norway by Great Britain's masterful interpretation of the expression "contraband." Bernstorff's sympathy with England grew stronger still when in 1779 Spain joined her enemies; and he was much inclined, the same winter, to join a triple alliance between Great Britain, Russia and Denmark-Norway, proposed by England for the purpose of compelling the Bourbon powers to accept reasonable terms of peace. But he was overruled by the crown prince Frederick, who thought such a policy too hazardous, when Russia declined to have anything to do with it. Instead of this the Russian chancellor Nikita Panin proposed an armed league to embrace all the neutral powers, for the purpose of protecting neutral shipping in time of war. This league was very similar to one proposed by Bernstorff himself in September 1778 for enforcing the principle "a free ship makes the cargo free";

but as now presented by Russia, he rightly regarded it as directed exclusively against England. He acceded to it indeed (9th of July 1780) because he could not help doing so; but he had previously, by a separate treaty with England, on the 4th of July, come to an understanding with that power as to the meaning of the expression "contraband of war." This independence caused great wrath at St Petersburg, where Bernstorff was accused of disloyalty, and ultimately sacrificed to the resentment of the Russian government (13th of November 1780), the more readily as he already disagreed on many important points of domestic administration with the prime minister Høegh Guldberg. He retired to his Mecklenburg estates, but on the fall of Guldberg four years later, was recalled to office (April 1784). The ensuing thirteen years were perhaps the best days of the old Danish absolutism. The government, under the direction of such enlightened ministers as Bernstorff, Reventlow and others, held the mean between Struensee's extravagant cosmopolitanism and Guldberg's stiff conservatism. In such noble projects of reform as the emancipation of the serfs (see **REVENTLOW**) Bernstorff took a leading part, and so closely did he associate himself with everything Danish, so popular did he become in the Danish capital, that a Swedish diplomatist expressed the opinion that henceforth Bernstorff could not be removed without danger. Liberal-minded as he was, he held that "the will of the nation should be a law to the king," and he boldly upheld the freedom of the press as the surest of safety-valves.

Meanwhile foreign complications were again endangering the position of Denmark-Norway. As Bernstorff had predicted, Panin's neutrality project had resulted in a breach between Great Britain and Russia. Then came Gustavus III.'s sudden war with Russia in 1788. Bernstorff was bound by treaty to assist Russia in such a contingency, but he took care that the assistance so rendered should be as trifling as possible, to avoid offending Great Britain and Prussia. Still more menacing became the political situation on the outbreak of the French Revolution. Ill-disposed as Bernstorff was towards the Jacobins, he now condemned on principle any interference in the domestic affairs of France, and he was persuaded that Denmark's safest policy was to keep clear of every anti-French coalition. From this unassailable standpoint he never swerved, despite the promises and even the menaces both of the eastern and the western powers. He was rewarded with complete success and the respect of all the diplomatists in Europe. His neutrality treaty with Sweden (17th of March 1794), for protecting their merchantmen by combined squadrons, was also extremely beneficial to the Scandinavian powers, both commercially and politically. Taught by the lesson of Poland, he had, in fact, long since abandoned his former policy of weakening Sweden. Bernstorff's great faculties appeared, indeed, to mature and increase with age, and his death, on the 21st of June 1797, was regarded in Denmark as a national calamity.

Count Bernstorff was twice married, his wives being the two sisters of the writers Counts Christian and Friedrich Leopold zu Stolberg. He left seven sons and three daughters. Of his sons the best known is Christian Günther, count von Bernstorff. Another, Count Joachim, was attached to his brother's fortunes so long as he remained in the Danish service, was associated with him in representing Denmark at the congress of Vienna, and in 1815 was appointed ambassador at that court.

See Rasmus Nyrum, *Bernstorffs Efterlæse* (Kjöbenhavn, 1799); Peter Edward Holm, *Danmark-Norges udenrigske Historie* (Copenhagen, 1875); *Danmarks Riges Historie V.* (Copenhagen, 1897-1905); Christian Ulrich Detlev von Eggers, *Denkværdighederne aus dem Leben des Grafen A. P. Bernstorff* (Copenhagen, 1800); Aage Früs, *A. P. Bernstorff og O. Høegh-Guldberg* (Copenhagen, 1899); and *Bernstorfferne og Danmark* (Copenhagen, 1903). (R. N. B.)

BERNSTORFF, CHRISTIAN GÜNTHER, COUNT VON (1760-1835), Danish and Prussian statesman and diplomatist, son of Count Andreas Peter von Bernstorff, was born at Copenhagen on the 3rd of April 1769. Educated for the diplomatic service under his father's direction, he began his career in 1787, as attaché to the representative of Denmark at the opening of the Swedish diet. In 1789 he went as secretary of legation to Berlin,

where his maternal uncle, Count Leopold Friedrich zu Stolberg, was Danish ambassador. His uncle's influence, as well as his own social qualities, obtained him rapid promotion; he was soon chargé d'affaires, and in 1791 minister plenipotentiary. In 1794 he exchanged this post for the important one of ambassador at Stockholm, where he remained until May 1797, when he was summoned to Copenhagen to act as substitute for his father during his illness. On the death of the latter (21st June), he succeeded him as secretary of state for foreign affairs and privy councillor. In 1800 he became head of the ministry. He remained responsible for the foreign policy of Denmark until May 1810, a fateful period which saw the battle of Copenhagen (2nd of April 1801), the bombardment of Copenhagen and capture of the Danish fleet in 1807. After his retirement he remained without office until his appointment in 1811 as Danish ambassador at Vienna. He remained here, in spite of the fact that for a while Denmark was nominally at war with Austria, until, in January 1814, on the accession of Denmark to the coalition against Napoleon, he publicly resumed his functions as ambassador. He accompanied the emperor Francis to Paris, and was present at the signature of the first peace of Paris. With his brother Joachim, he represented Denmark at the congress of Vienna and, as a member for the commission for the regulation of the affairs of Germany, was responsible for some of that confusion of Danish and German interests which was to bear bitter fruit later in the Schleswig-Holstein question (*q.v.*). He again accompanied the allied sovereigns to Paris in 1815, returning to Copenhagen the same year. In 1817 he was appointed Danish ambassador at Berlin, his brother Joachim going at the same time to Vienna. In the following year Prince Hardenberg made him the formal proposition that he should transfer his services to Prussia, which, with the consent of his sovereign, he did.

It was, therefore, as a Prussian diplomat that Bernstorff attended the congress of Aix-la-Chapelle (October 1818), at the close of which he returned to Berlin as minister of state and head of the department for foreign affairs. Bernstorff's management of Prussian policy during the many years that he remained in office has been variously judged. He was by training and temperament opposed to the Revolution, and he was initiated into his new duties as a Prussian minister by the reactionary Ancillon. He is accused of having subordinated the particular interests of Prussia to the European policy of Metternich and the "Holy Alliance." Whether any other policy would in the long run have served Prussia better is a matter for speculation. It is true that Bernstorff supported the Carlsbad decrees, and the Vienna Final Act; he was also the faithful henchman of Metternich at the congresses of Laibach, Troppau and Verona. On the other hand, he took a considerable share in laying the foundations of the customs union (*Zollverein*), which was destined to be the foundation of the Prussian hegemony in Germany. In his support of Russia's action against Turkey in 1828 also he showed that he was no blind follower of Metternich's views. In the crisis of 1830 his moderation in face of the warlike clamour of the military party at Berlin did much to prevent the troubles in Belgium and Poland from ending in a universal European conflagration.

From 1824 onward Bernstorff had been a constant sufferer from hereditary gout, intensified and complicated by the results of overwork. In the spring of 1832 the state of his health compelled him to resign the ministry of foreign affairs to Ancillon, who had already acted as his deputy for a year. He died on the 18th of March 1835.

See J. Caro in *Allgem. Deutsch. Biog. s. v.*; also H. von Treitschke, *Deutsche Geschichte* (Leipzig, 1874-1879).

BERNSTORFF, JOHANN HARTWIG ERNST, COUNT VON (1712-1772), Danish statesman, who came of a very ancient Mecklenburg family, was the son of Joachim Engelke, Freiherr von Bernstorff, chamberlain to the elector of Hanover, and was born on the 13th of May 1712. His maternal grandfather, Andreas Gottlieb Bernstorff (1640-1726), had been one of the ablest ministers of George I., and under his guidance Johann

was very carefully educated, acquiring amongst other things that intimate knowledge of the leading European languages, especially French, which ever afterwards distinguished him. He was introduced into the Danish service by his relations, the brothers Plessen, who were ministers of state under Christian VI. In 1732 he was sent on a diplomatic mission to the court of Dresden; and from 1738 he represented Holstein at the diet of Regensburg, from 1744 to 1750 he represented Denmark at Paris, whence he returned in 1754 to Denmark as minister of foreign affairs. Supported by the powerful favourite A. G. Moltke, and highly respected by Frederick V., he occupied for twenty-one years the highest position in the government, and in the council of state his opinion was decisive. But his chief concern was with foreign affairs. Ever since the conclusion of the Great Northern War, Danish statesmen had been occupied in harvesting its fruits, namely, the Gottorp portions of Schleswig definitely annexed to Denmark in 1721 by the treaty of Nystad, and endeavouring to bring about a definitive general understanding with the house of Gottorp as to their remaining possessions in Holstein. With the head of the Swedish branch of the Gottorps, the crown prince Adolphus Frederick, things had been arranged by the exchange of 1750; but an attempt to make a similar arrangement with the chief of the elder Gottorp line, the cesarevitch Peter Feodorovich, had failed. In intimate connexion with the Gottorp affair stood the question of the political equilibrium of the north. Ever since Russia had become the dominant Baltic power, as well as the state to which the Gottorps looked primarily for help, the necessity for a better understanding between the two Scandinavian kingdoms had clearly been recognized by the best statesmen of both, especially in Denmark from Christian VI.'s time; but unfortunately this sound and sensible policy was seriously impeded by the survival of the old national hatred on both sides of the Sound, still further complicated by Gottorp's hatred of Denmark. Moreover, it was a diplomatic axiom in Denmark, founded on experience, that an absolute monarchy in Sweden was incomparably more dangerous to her neighbour than a limited monarchy, and after the collapse of Swedish absolutism with Charles XII., the upholding of the comparatively feeble, and ultimately anarchical, parliamentary government of Sweden became a question of principle with Danish statesmen throughout the 18th century. A friendly alliance with a relatively weak Sweden was the cardinal point of Bernstorff's policy. But his plans were traversed again and again by unforeseen complications, the failure of the most promising presumptions, the perpetual shifting of apparently stable alliances; and again and again he had to modify his means to attain his ends. Amidst all these perplexities Bernstorff approved himself a consummate statesman. It seemed almost as if his wits were sharpened into a keener edge by his very difficulties; but since he condemned on principle every war which was not strictly defensive, and it had fallen to his lot to guide a comparatively small power, he always preferred the way of negotiation, even sometimes where the diplomatic tangle would perhaps best have been severed boldly by the sword. The first difficult problem he had to face was the Seven Years' War. He was determined to preserve the neutrality of Denmark at any cost, and this he succeeded in doing, despite the existence of a subsidy-treaty with the king of Prussia, and the suspicions of England and Sweden. It was through his initiative, too, that the convention of Kloster-Seven was signed (10th of September 1757), and on the 4th of May 1758 he concluded a still more promising treaty with France, whereby, in consideration of Denmark's holding an army-corps of 24,000 men in Holstein till the end of the war, to secure Hamburg, Lübeck and the Gottorp part of Holstein from invasion, France, and ultimately Austria also, engaged to bring about an exchange between the king of Denmark and the cesarevitch, as regards Holstein. But the course of the war made this compact inoperative. Austria hastened to repudiate her guarantee to Denmark in order not to offend the new emperor of Russia, Peter III., and one of Peter's first acts on ascending the throne was to declare war against Denmark. The coolness

and firmness of Bernstorff saved the situation. He protested that the king of Denmark was bound to defend Schleswig "so long as there was a sword in Denmark and a drop of blood in the veins of the Danish people." He rejected the insulting ultimatum of the Russian emperor. He placed the best French general of the day at the head of the well-equipped Danish army. But just as the Russian and Danish armies had come within striking distance, the tidings reached Copenhagen that Peter III. had been overthrown by his consort. Bernstorff was one of the first to recognize the impotence of the French monarchy after the Seven Years' War, and in 1763 he considered it expedient to exchange the French for the Russian alliance, which was cemented by the treaty of the 28th of April (March 11) 1765. This compact engaged Denmark to join with Russia in upholding the existing Swedish constitution, in return for which Catherine II. undertook to adjust the Gottorp difficulty by the cession of the Gottorp portion of Holstein in exchange for the counties of Oldenburg and Delmenhorst. For his part in this treaty Bernstorff was created count. On the accession of Christian VII., in 1766, Bernstorff's position became very precarious, and he was exposed to all manner of attacks, being accused, without a shadow of truth, of exploiting Denmark, and of unduly promoting foreigners. It is remarkable, however, that though Bernstorff ruled Denmark for twenty years he never learnt Danish. His last political achievement was to draw still closer to Russia by the treaty of the 13th of December 1769, the most important paragraph of which stipulated that any change in the Swedish constitution should be regarded by Denmark and Russia as a *casus belli* against Sweden, and that in the event of such a war Denmark should retain all the territory conquered from Sweden. This treaty proved to be a great mistake on Denmark's part, but circumstances seemed at the time to warrant it. Nine months later, on the 13th of September 1770, Bernstorff was dismissed as the result of Struensee's intrigues, and, rejecting the brilliant offers of Catherine II. if he would enter the Russian service, retired to his German estates, where he died on the 18th of February 1772. Bernstorff was not only one of the ablest but one of the noblest and most conscientious statesmen of his day. The motto he chose on receiving the order of the Daneborg was "Integritas et rectum custodiunt me," and throughout a long life he was never false to it.

See Poul Vedel, *Den aeldre Grev Bernstorffs ministerium* (Copenhagen, 1882); *Correspondance ministérielle du Comte J. H. E. Bernstorff*, ed. Vedel (Copenhagen, 1882); Aage Friis, *Bernstorffs og Danmark* (Copenhagen, 1899). (R. N. B.)

BEROSSUS, a priest of Bel at Babylon, who translated into Greek the standard Babylonian work on astrology and astronomy, and compiled (in three books) the history of his country from native documents, which he published in Greek in the reign of Antiochus II. (250 B.C.). His works have perished, but extracts from the history have been preserved by Josephus and Eusebius, the latter of whom probably derived them not directly from Berossus, but through the medium of Alexander Polyhistor and Apollodorus. The extracts containing the Babylonian cosmology, the list of the antediluvian kings of Babylonia, and the Chaldaean story of the Deluge, have been shown by the decipherment of the cuneiform texts to have faithfully reproduced the native legends; we may, therefore, conclude that the rest of the History was equally trustworthy. On the other hand, a list of post-diluvian dynasties, which is quoted by Eusebius and Georgius Syncellus as having been given by Berossus, cannot, in its present form, be reconciled with the monumental facts, though a substratum of historical truth is discoverable in it. As it stands, it is as follows:—

- | | | |
|----|--------------------|------------------------|
| 1. | 86 Chaldaean kings | 34,080 or 33,091 years |
| 2. | 8 Median | " 224 |
| 3. | 11 other kings | " no number. |
| 4. | 49 Chaldaean | " 458 |
| 5. | 9 Arabian | " 245 |
| 6. | 45 Assyrian | " 576 |

After these, according to Eusebius, came the reign of Pul. By means of an ingenious chronological combination, the several items of which, however, are very questionable, J. A. Brandis

assigned 258 years to the 3rd dynasty; other summations have been proposed with equally little assurance of certainty. If Eusebius can be trusted, the 6th dynasty ended in 720 B.C., the year in which Pul or Tiglath-pileser III. was crowned king of Babylonia. But all attempts to harmonize the scheme of dynasties thus ascribed to Berossus with the list given us in the so-called dynastic Tablets discovered by Dr. Pinches have been failures. The numbers, whether of kings or of years, cannot have been handed down to us correctly by the Greek writers. All that seems certain is that Berossus arranged his history so that it should fill the astronomical period of 36,000 years, beginning with the first man and ending with the conquest of Babylon by Alexander the Great.

See J. P. Cory, *Ancient Fragments* (1826, ed. by E. R. Hodges, 1876); Fr. Lenormant, *Essai de commentaire des fragments cosmogoniques de Bérose* (1872); A. von Gutschmid in the *Rheinisches Museum* (1853); George Smith in *T.S.B.A.* iii., 1874, pp. 361-370; Th. G. Pinches in *F.S.B.A.*, 1880-1881. (A. H. S.)

BERRY, CHARLES ALBERT (1852-1899), English non-conformist divine, was born on the 14th of December 1852 at Bradshawgate, Leigh, Lancashire. At the age of seventeen he entered Airedale College, Bradford, to train for the Congregational ministry, and in 1875 became pastor of St George's Road Congregational church, Bolton. He became widely known as a man of administrative ability, a vigorous platform speaker and an eloquent preacher. In July 1883 he undertook the pastorate of the church at Queen Street, Wolverhampton, with the supervision of nine dependent churches in the neighbourhood. Here again he exercised a wide influence, due in part to his evangelical conviction, eloquence, broad views and powers of organization, but also to the magnetic force of his personality. In 1887 he went to America in fulfilment of a promise to Henry Ward Beecher of Brooklyn, and received a unanimous invitation to succeed Beecher in what was then the best-known pulpit in the United States. Berry, however, felt that his work lay in England and declined the invitation. In 1892 he took part in a conference at Grindelwald on the question of Christian Reunion, and subsequently, with Hugh Price Hughes and Alexander Mackennal of Bowdon, conducted a campaign throughout England, introducing the ideas and principles of Free Church federation. He was the first president of the Free Church congress. He played an effective part in expressing the popular desire for peace between England and America in reply to President Cleveland's message on the Venezuelan boundary dispute, and was invited to Washington to preach in connexion with the endeavour to establish an international arbitration treaty. In 1896 he was elected chairman of the Congregational Union of England and Wales. In 1898 his health began to fail, and he died suddenly on the 31st of January 1899. His published works consist chiefly of addresses, and two volumes of sermons, *Vision and Duty*, and *Mischievous Goodness*. (D. M.N.)

BERRY, CHARLES FERDINAND, DUKE OF (1778-1820), younger son of Charles X. of France, was born at Versailles. At the Revolution he left France with his father, then comte d'Artois, and served in the army of Condé from 1792 to 1797. He afterwards joined the Russian army, and in 1801 took up his residence in England, where he remained for thirteen years. During that time he married an Englishwoman, Anna Brown, by whom he had two daughters, afterwards the baronne de Charette and the comtesse de Lucigne-Faucigny. The marriage was cancelled for political reasons in 1814, when the duke set out for France. His frank, open manners gained him some favour with his countrymen, and Louis XVIII. named him commander-in-chief of the army at Paris on the return of Napoleon from Elba. He was, however, unable to retain the loyalty of his troops, and retired to Ghent during the Hundred Days. In 1816 he married the princess Caroline Ferdinande Louise (1798-1870), eldest daughter of King Francis I. of Naples. On the 13th of February 1820 he was mortally wounded, when leaving the opera-house at Paris with his wife, by a saddler named Louis Pierre Louvel. Seven months after his death the duchess gave birth to a son, who received the title of duke of Bordeaux,

but who is known in history as the comte de Chambord. A daughter, afterwards duchess of Parma, was born in 1819.

The duchess of Berry was compelled to follow Charles X. to Holywood after July 1830, but it was with the resolution of returning speedily and making an attempt to secure the throne for her son. From England she went to Italy, and in April 1832 she landed near Marseilles, but, receiving no support, was compelled to make her way towards the loyal districts of Vendée and Brittany. Her followers, however, were defeated, and, after remaining concealed for five months in a house in Nantes, she was betrayed to the government and imprisoned in the castle of Blaye. Here she gave birth to a daughter, the fruit of a secret marriage contracted with an Italian nobleman, Count Ettore Lucchesi-Palli (1805-1864). The announcement of this marriage at once deprived the duchess of the sympathies of her supporters. She was no longer an object of fear to the French government, who released her in June 1833. She set sail for Sicily, and, joining her husband, lived in retirement from that time till her death, at Brunnesse in Switzerland, in April 1870.

BERRY, JOHN, DUKE OF (1340-1416), third son of John II, king of France and Bonne of Luxemburg, was born on the 30th of November 1340 at Vincennes. He was created count of Poitiers in 1356, and was made the king's lieutenant in southern France, though the real power rested chiefly with John of Armagnac, whose daughter Jeanne he married in 1360. The loss of his southern possessions by the treaty of Bretigny was compensated by the fiefs of Auvergne and Berry, with the rank of peer of France. The duke went to England in 1360 as a hostage for the fulfilment of the treaty of Bretigny, returning to France in 1367 on the pretext of collecting his ransom. He took no leading part in the war against the English, his energies being largely occupied with the satisfaction of his artistic and luxurious tastes. For this reason perhaps his brother Charles V. assigned him no share in the government during the minority of Charles VI. He received, however, the province of Languedoc. The peasant revolt of the *Tuchins* and *Coquins*, as the insurgents were called, was suppressed with great harshness, and the duke exacted from the states of Languedoc assembled at Lyons a fine of £15,000. He fought at Rosebeke in 1382 against the Flemings and helped to suppress the Parisian revolts. By a series of delays he caused the failure of the naval expedition prepared at Sluys against England in 1386, and a second accusation of military negligence led to disgrace of the royal princes and the temporary triumph of the *marmousets*, as the advisers of the late king were nicknamed. Charles VI. visited Languedoc in 1389-1390, and enquired into his uncle's government. The duke was deprived of the government of Languedoc, and his agent, Bétizac, was burnt. When in 1401 he was restored, he delegated his authority in the province, where he was still hated, to Bernard d'Armagnac. In 1396 he negotiated a truce with Richard II. of England, and his marriage with the princess Isabella of France. He tried to mediate between his brother Philip the Bold of Burgundy and his nephew Louis, duke of Orleans, and later between John "sans Peur" of Burgundy and Orleans. He broke with John after the murder of Orleans, though he tried to prevent civil war, and only finally joined the Armagnac party in 1410. In 1413 he resumed his rôle of mediator, and was for a short time tutor to the dauphin. He died in Paris on the 15th of June 1416, leaving vast treasures of jewelry, objects of art, and especially of illuminated MSS., many of which have been preserved. He decorated the Sainte Chapelle at Bourges; he built the Hôtel de Nesle in Paris, and palaces at Poitiers, Bourges, Mehun-sur-Yèvre and elsewhere.

See also L. Raynal, *Histoire du Berry* (Bourges, 1845); "Jean, duc de Berry," in S. Luce, *La France pendant la guerre de Cent Ans* (1890), vol. 1.; Toulgôët-Tréanna, in *Mém. de la Soc. des antiquaires du centre*, vol. xvii. (1890). His beautiful illuminated *Livre d'heures* was reproduced (Paris, fol. 1904) by P. Durrieu.

BERRY, or BERRI, a former province of France, absorbed in 1790 in the departments of Cher, corresponding roughly with Haut-Berry, and Indre, representing Bas-Berry. George Sand, the most famous of "berrichon" writers, has described the quiet scenery and rural life of the province in the rustic novels of her

later life. Berry is the *civitas* or *pagus* Bituricensis of Gregory of Tours. The Bituriges were said by Livy (v. 34) to have been the dominating tribe in Gaul in the 7th century, one of their kings, Ambigat, having ruled over all Gaul. In Caesar's time they were dependent on the Aedui. The tribes inhabiting the districts of Berry and Bourbonnais were distinguished as Bituriges Cubi. The numerous menhirs and dolmens to be found in the district, to which local superstitions still cling, are probably monuments of still earlier inhabitants. In 52 B.C. the Bituriges, at the order of Vercingetorix, set fire to their towns, but spared Bourges (Avaricum) their capital, which was taken and sacked by the Romans. The province was amalgamated under Augustus with Aquitaine, and Bourges became the capital of Aquitania Prima. In 475 Berry came into the possession of the west Goths, from whom it was taken (c. 507) by Clovis. The first count of Berry, Chunibert (d. 763), was created by Waifer, duke of Aquitaine, from whom the county was wrested by Pippin the Short, who made it his residence and left it to his son Carloman, on whose death it fell to his brother Charlemagne. The countship of Berry was suppressed (926) by Rudolph, king of the Franks (fl. 923-936). Berry was for some time a group of lordships dependent directly on the crown, but the chief authority eventually passed to the viscounts of Bourges, who, while owning the royal suzerainty, preserved a certain independence until 1101, when the viscount Odo Arpin de Dun sold his fief to the crown. Berry was part of the dowry of Eleanor, wife of Louis VII., and on her divorce and remarriage with Henry II. of England it passed to the English king. Its possession remained, however, a matter of dispute until 1200, when Berry reverted by treaty with John of England to Philip Augustus, and the various fiefs of Berry were given as a dowry to John's niece, Blanche of Castile, on her marriage with Philip's son Louis (afterwards Louis VIII.). Philip Augustus established an effective control over the administration of the province by the appointment of a royal *bailli*. Berry suffered during the Hundred Years' War, and more severely during the wars of religion in the 16th century. It had been made a duchy in 1360, and its first duke, John [Jean] (1340-1416), son of the French king John II., encouraged the arts and beautified the province with money wrung from his government of Languedoc. Thenceforward it was held as an appanage of the French crown, usually by a member of the royal family closely related to the king. Charles of France (1447-1472), brother of Louis XI., was duke of Berry, but was deprived of this province, as subsequently of the duchies of Normandy and Guienne, for intrigues against his brother. The duchy was also governed by Jeanne de Valois (d. 1505), the repudiated wife of Louis XII.; by Marguerite d'Angoulême, afterwards queen of Navarre; by Marguerite de Valois, afterwards duchess of Savoy; and by Louise of Lorraine, widow of Henry III., after whose death (1601) the province was finally reabsorbed in the royal domain. The title of duke of Berry, divested of territorial significance, was held by princes of the royal house. Charles (1686-1714), duke of Berry, grandson of Louis XIV., and third son of the dauphin Louis (d. 1711), married Marie Louise Elisabeth (1686-1714), eldest daughter of the duke of Orleans, whose intrigues made her notorious. The last to bear the title of duke of Berry was the ill-fated Charles Ferdinand, grandson and heir of Charles X.

BERRYER, ANTOINE PIERRE (1790-1868), French advocate and parliamentary orator, was the son of an eminent advocate and counsellor to the *parlement*. He was educated at the Collège de Juilly, on leaving which he adopted the profession of the law; he was admitted advocate in 1811, and in the same year he married. In the great conflict of the period between Napoleon I. and the Bourbons, Berryer, like his father, was an ardent Legitimist; and in the spring of 1815, at the opening of the campaign of the Hundred Days, he followed Louis XVIII. to Ghent as a volunteer. After the second restoration he distinguished himself as a courageous advocate of moderation in the treatment of the military adherents of the emperor. He

¹ See R. le Mauclé, *Jeanne de France, duchesse d'Orléans et de Berry* (Paris, 1883).

assisted his father and Dupin in the unsuccessful defence of Marshal Ney before the chamber of peers; and he undertook alone the defence of General Cambronné and General Debelle, procuring the acquittal of the former and the pardon of the latter. By this time he had a very large business as advocate, and was engaged on behalf of journalists in many press prosecutions. He stood forward with a noble resolution to maintain the freedom of the press, and severely censured the rigorous measures of the police department. In 1830, not long before the fall of Charles X., Berruyer was elected a member of the chamber of deputies. He appeared there as the champion of the king and encouraged him in his reactionary policy. After the revolution of July, when the Legitimists withdrew in a body, Berruyer alone retained his seat as deputy. He resisted, but unsuccessfully, the abolition of the hereditary peerage. He advocated trial by jury in press prosecutions, the extension of municipal franchises and other liberal measures. In May 1832 he hastened from Paris to see the duchess of Berry on her landing in the south of France for the purpose of organizing an insurrection in favour of her son, the duke of Bordeaux, since known as the Comte de Chambord. Berruyer attempted to turn her from her purpose; and failing in this he set out for Switzerland. He was, however, arrested, imprisoned and brought to trial as one of the insurgents. He was immediately acquitted. In the following year he pleaded for the liberation of the duchess, made a memorable speech in defence of Chateaubriand, who was prosecuted for his violent attacks on the government of Louis Philippe, and undertook the defence of several Legitimist journalists. Among the more noteworthy events of his subsequent career were his defence of Louis Napoleon after the ridiculous affair of Boulogne, in 1840, and a visit to England in December 1843, for the purpose of formally acknowledging the pretender, the duke of Bordeaux, then living in London, as Henry V. and lawful king of France. Berruyer was an active member of the National Assembly convoked after the revolution of February 1848, again visited the pretender, then at Wiesbaden, and still fought in the old cause. This long parliamentary career was closed by a courageous protest against the *coup d'état* of December 2, 1851. After a lapse of twelve years, however, he appeared once more in his forsaken field as a deputy to the Corps Législatif. Berruyer was elected member of the French Academy in 1854. A visit paid by this famous orator to Lord Brougham in 1865 was made the occasion of a banquet given in his honour by the benchers of the Temple and of Lincoln's Inn. In November 1868 he was removed by his own desire from Paris to his country seat at Augerville, and there he died on the 29th of the same month.

BERSERKER (from the "sark" or shirt of the "bear," or other animal-skins worn by them), in Scandinavian mythology, the name of the twelve sons of the hero Berserk, grandson of the eight-handed Starkadder and Alfildie. Berserk was famed for the reckless fury with which he fought, always going into battle without armour. By the daughter of King Swafurlam, whom he had killed, he had the twelve sons who were his equals in bravery. In Old Norse the term *berserker* thus became synonymous with reckless courage, and was later applied to the bodyguards of several of the Scandinavian heroes.

BERT, PAUL (1833-1886), French physiologist and politician, was born at Auxerre (Yonne) on the 17th of October 1833. He entered the École Polytechnique at Paris with the intention of becoming an engineer; then changing his mind, he studied law; and finally, under the influence of the zoologist, L. P. Gratiolet (1815-1865), he took up physiology, becoming one of Claude Bernard's most brilliant pupils. After graduating at Paris as doctor of medicine in 1863, and doctor of science in 1866, he was appointed professor of physiology successively at Bordeaux (1866) and the Sorbonne (1869). After the revolution of 1870 he began to take part in politics as a supporter of Gambetta. In 1874 he was elected to the Assembly, where he sat on the extreme left, and in 1876 to the chamber of deputies. He was one of the most determined enemies of clericalism, and an ardent advocate of "liberating national education from

religious sects, while rendering it accessible to every citizen." In 1881 he was minister of education and worship in Gambetta's short-lived cabinet, and in the same year he created a great sensation by a lecture on modern Catholicism, delivered in a Paris theatre, in which he poured ridicule on the fables and follies of the chief religious tracts and handbooks that circulated especially in the south of France. Early in 1886 he was appointed resident-general in Annam and Tonkin, and died of dysentery at Hanoi on the 11th of November of that year. But he was more distinguished as a man of science than as a politician or administrator. His classical work, *La Pression barométrique* (1878), embodies researches that gained him the biennial prize of 20,000 francs from the Academy of Sciences in 1875, and is a comprehensive investigation on the physiological effects of air-pressure, both above and below the normal. His earliest researches, which provided him with material for his two doctoral theses, were devoted to animal grafting and the vitality of animal tissues, and they were followed by studies on the physiological action of various poisons, on anaesthetics, on respiration and asphyxia, on the causes of the change of colour in the chameleon, &c. He was also interested in vegetable physiology, and in particular investigated the movements of the sensitive plant, and the influence of light of different colours on the life of vegetation. After about 1880 he produced several elementary text-books of scientific instruction, and also various publications on educational and allied subjects.

BERTANI, AGOSTINO (1812-1886), Italian revolutionist, was born at Milan on the 19th of October 1812. He took part in the insurrection of 1848, though opposed to the fusion of Lombardy with Piedmont. During the Roman republic of 1849, he, as medical officer, organized the ambulance service, and, after the fall of Rome, withdrew to Genoa, where he worked with Sir James Hudson for the liberation of the political prisoners of Naples, but held aloof from the Mazzinian conspiracies. In 1859 he founded a revolutionary journal at Genoa, but, shortly afterwards, joined as surgeon the Garibaldian corps in the war of 1859. After Villafranca he became the organizer-in-chief of the expeditions to Sicily, remaining at Genoa after Garibaldi's departure for Marsala, and organizing four separate volunteer corps, two of which were intended for Sicily and two for the papal states. Cavour, however, obliged all to sail for Sicily. Upon the arrival of Garibaldi at Naples, Bertani was appointed secretary-general of the dictator, in which capacity he reorganized the police, abolished the secret service fund, founded twelve infant asylums, suppressed the duties upon Sicilian products, prepared for the suppression of the religious orders, and planned the sanitary reconstruction of the city. Entering parliament in 1861, he opposed the Garibaldian expedition, which ended at Aspromonte, but nevertheless tended Garibaldi's wound with affectionate devotion. In 1866 he organized the medical service for the 40,000 Garibaldians, and in 1867 fought at Mentana. His parliamentary career, though marked by zeal, was less brilliant than his revolutionary activity. Up to 1870 he remained an agitator, but, after the liberation of Rome, seceded from the historic left, and became leader of the extreme left, a position held until his death on the 30th of April 1886. His chief work as deputy was an inquiry into the sanitary conditions of the peasantry, and the preparation of the sanitary code adopted by the Crispi administration. (H. W. S.)

BERTAT (Arab. *Jebaloïn*), negroes of the Shanggalla group of tribes, mainly agriculturists. They occupy the valleys of the Yabus and Tumat, tributaries of the Blue Nile. They are shortish and very black, with projecting jaws, broad noses and thick lips. By both sexes the hair is worn short or the head shaved; on cheeks and temple are tribal marks in the form of scars. The huts of the Bertat are circular, the floor raised on short poles. Their weapons are the spear, throwing-club, sword and dagger, and also the *kubdea* or throwing-knife. Blocks of salt are the favourite form of currency. Gold washing is practised. Nature worship still struggles against the spread of Mahomedanism. The Bertat, estimated to number some 80,000, c. 1880, were

nearly exterminated during the period of Dervish ascendancy (1884-1898) in the eastern Sudan. Settled among them are Arab communities governed by their own sheiks, while the *mèks* or rulers of the Bertat speak Arabic, and show traces of foreign blood. (See FAZOLLI.)

See Koeltitz, "The Bertat," *Journal of the Anthropological Institute*, xxxiii, 51; *Anglo-Egyptian Sudan*, edited by Count Gleichen (London, 1905).

BERTAUT, JEAN (1552-1611), French poet, was born at Caen in 1552. He figures with Desportes in the disdainful couplet of Boileau on Ronsard:—

"Ce poète orgueilleux, trébuché de si haut,
Rendit plus retenus Desportes et Bertaute."

He wrote light verse to celebrate the incidents of court life in the manner of Desportes, but his verse is more fantastic and fuller of conceits than his master's. He early entered the church, and had a share in the conversion of Henry IV., a circumstance which assured his career. He was successively councillor of the parlement of Grenoble, secretary to the king, almoner to Marie de' Medici, abbot of Aulnay and finally, in 1606, bishop of Sées. After his elevation to the bishopric he ceased to produce the light verse in which he excelled, though his scruples did not prevent him from preparing a new edition of his *Recueil de quelques vers amoureux* (1602) in 1606. The serious poems in which he celebrated the public events of his later years are dull and lifeless. Bertaute died at Sées on the 8th of June 1611. His works were edited by M. Ad. Chénévères in 1801.

BERTH, originally a nautical term, probably connected with the verb "to bear," first found in literature at the end of the 16th century, with the alternative spelling "birth." Its primary meaning is "sea-room," whether on the high seas or at anchor. Hence the phrase "to give a wide berth to," meaning "to keep at a safe distance from," both in its literal and its metaphorical use. From meaning sea-room for a ship at anchor, "berth" comes to mean also the position of a stow on her moorings ("to berth a ship"). The word further means any place on a ship allotted for a special purpose, where the men mess or sleep, or an office or appointment on board, whence the word has passed into colloquial use with the meaning of a situation or employment. From the Icelandic *byrdi*, a board, is also derived the ship-building term "berth," meaning to board, put up bulk-heads, etc.

BERTHELOT, MARCELLIN PIERRE EUGÈNE (1827-1907), French chemist and politician, was born at Paris on the 29th of October 1827, being the son of a doctor. After distinguishing himself at school in history and philosophy, he turned to the study of science. In 1851 he became a member of the staff of the Collège de France as assistant to A. J. Balard, his former master, and about the same time he began his life-long friendship with Ernest Renan. In 1854 he made his reputation by his doctoral thesis, *Sur les combinaisons de la glycérine avec les acides*, which described a series of beautiful researches in continuation and amplification of M. E. Chevreul's chemical work. In 1859 he was appointed professor of organic chemistry at the *École Supérieure de Pharmacie*, and in 1865 he accepted the new chair of organic chemistry, which was specially created for his benefit at the Collège de France. He became a member of the Academy of Medicine in 1863, and ten years afterwards entered the Academy of Sciences, of which he became perpetual secretary in 1880 in succession to Louis Pasteur. He was appointed inspector general of higher education in 1876, and after his election as life senator in 1881 he continued to take an active interest in educational questions, especially as affected by compulsory military service. In the Goblet ministry of 1886-1887 he was minister of public instruction, and in the Bourgeois cabinet of 1895-1896 he held the portfolio for foreign affairs. His scientific jubilee was celebrated in Paris in 1901. He died suddenly, immediately after the death of his wife, on the 18th of March 1907, at Paris, and with her was buried in the Panthéon.

The fundamental conception that underlay all Berthelot's chemical work was that all chemical phenomena depend on the action of physical forces which can be determined and measured. When he began his active career it was generally believed

that, although some instances of the synthetical production of organic substances had been observed, on the whole organic chemistry must remain an analytical science and could not become a constructive one, because the formation of the substances with which it deals required the intervention of vital activity in some shape. To this attitude he offered uncompromising opposition, and by the synthetical production of numerous hydrocarbons, natural fats, sugars and other bodies he proved that organic compounds can be formed by ordinary methods of chemical manipulation and obey the same laws as inorganic substances, thus exhibiting the "creative character in virtue of which chemistry actually realizes the abstract conceptions of its theories and classifications—a prerogative so far possessed neither by the natural nor by the historical sciences." His investigations on the synthesis of organic compounds were published in numerous papers and books, including *Chimie organique fondée sur la synthèse* (1860) and *Les Carburés d'hydrogène* (1901). Again he held that chemical phenomena are not governed by any peculiar laws special to themselves, but are explicable in terms of the general laws of mechanics that are in operation throughout the universe; and this view he backed with the aid of thousands of experiments, in his *Mécanique chimique* (1878) and his *Thermochimie* (1897). This branch of study naturally conducted him to the investigation of explosives, and on the theoretical side led to the results published in his work *Sur la force de la poudre et des matières explosives* (1872), while on the practical side it enabled him to render important services to his country as president of the scientific defence committee during the siege of Paris in 1870-71 and subsequently as chief of the French explosives committee. In the later years of his life he turned to the study of the earlier phases of the science which he did so much to advance, and students of chemical history are greatly indebted to him for his book on *Les Origines de l'alchimie* (1885) and his *Introduction à l'étude de la chimie des anciens et du moyen âge* (1889), as well as for publishing translations of various old Greek, Syriac and Arabic treatises on alchemy and chemistry (*Collection des anciens alchimistes grecs*, 1887-1888, and *La Chimie au moyen âge*, 1893). He was also the author of *Science et philosophie* (1886), which contains a well-known letter to Renan on "La Science idéale et la science positive," of *La Révolution chimique, Lavoisier* (1890), of *Science et morale* (1897), and of numerous articles in *La Grande Encyclopédie*, which he helped to establish.

BERTHIER, LOUIS ALEXANDRE, prince of Neuchâtel (1753-1815), marshal of France and chief of the staff under Napoleon I., was born at Versailles on the 20th of February 1753. As a boy he was instructed in the military art by his father, an officer of the *Corps de génie*, and at the age of seventeen he entered the army, serving successively in the staff, the engineers and the prince de Lambesc's dragoons. In 1780 he went to North America with Rochambeau, and on his return, having attained the rank of colonel, he was employed in various staff posts and in a military mission to Prussia. During the Revolution, as chief of staff of the Versailles national guard, he protected the aunts of Louis XVI. from popular violence, and aided their escape (1791). In the war of 1792 he was at once made chief of staff to Marshal Lückner, and he bore a distinguished part in the Argonne campaign of Dumouriez and Kellermann. He served with great credit in the Vendean War of 1793-95, and was in the next year made a general of division and chief of staff (*Major-Général*) to the army of Italy, which Bonaparte had recently been appointed to command. His power of work, accuracy and quick comprehension, combined with his long and varied experience and his complete mastery of detail, made him the ideal chief of staff to a great soldier; and in this capacity he was Napoleon's most valued assistant for the rest of his career. He accompanied Napoleon throughout the brilliant campaign of 1796, and was left in charge of the army after the peace of Campo Formio. In this post he organized the Roman republic (1798), after which he joined his chief in Egypt, serving there until Napoleon's return. He assisted in the *coup d'état* of 18th Brumaire, afterwards becoming minister of war for

a time. In the campaign of Marengo he was the nominal head of the Army of Reserve, but the first consul accompanied the army and Berthier acted in reality, as always, as chief of staff to Napoleon. At the close of the campaign he was employed in civil and diplomatic business. When Napoleon became emperor, Berthier was at once made a marshal of the empire. He took part in the campaigns of Austerlitz, Jena and Friedland, and was created duke of Valengin in 1806, sovereign prince of Neuchâtel in the same year and vice-constable of the empire in 1807. In 1808 he served in the Peninsula, and in 1809 in the Austrian War, after which he was given the title of prince of Wagram. Berthier married a niece of the king of Bavaria. He was with Napoleon in Russia in 1812, Germany in 1813, and France in 1814, fulfilling, till the fall of the empire, the functions of "major-general" of the *Grande Armée*. He abandoned Napoleon to make his peace with Louis XVIII. in 1814, and accompanied the king in his solemn entry into Paris. During Napoleon's captivity in Elba, Berthier, whom he informed of his projects, was much perplexed as to his future course, and, being unwilling to commit himself, fell under the suspicion both of his old leader and of Louis XVIII. On Napoleon's return he withdrew to Bamberg, where he died on the 1st of June 1815. The manner of his death is uncertain; according to some accounts he was assassinated by members of a secret society, others say that, maddened by the sight of Russian troops marching to invade France, he threw himself from his window and was killed. Berthier was not a great commander. When he was in temporary command in 1809 the French army in Bavaria underwent a series of reverses. Whatever merit as a general he may have possessed was completely overshadowed by the genius of his master. But his title to fame is that he understood and carried out that master's directions to the minutest detail.

BERTHOLLET, CLAUDE LOUIS (1748-1822), French chemist, was born at Talloire, near Annecy in Savoy, on the 9th of December 1748. He studied first at Chambéry and afterwards at Turin, where he graduated in medicine. Settling in Paris in 1772, he became the private physician of Philip, duke of Orleans, and by his chemical work soon gained so high a reputation that in 1780 he was admitted into the Academy of Sciences. In 1785 he declared himself an adherent of the Lavoisierian school, though he did not accept Lavoisier's view of oxygen as the only and universal acidifying principle, and he took part in the reform in chemical nomenclature carried out by Lavoisier and his associates in 1787. Among the substances of which he investigated the composition were ammonia, sulphuretted hydrogen and prussic acid, and his experiments on chlorine, which he regarded, not as an element, but as oxygenated muriatic (oxymuriatic) acid, led him to propose it as a bleaching agent in 1785. He also prepared potassium chlorate and attempted to use it in the manufacture of gunpowder as a substitute for saltpetre. When, at the beginning of the French Revolution, the deficiency in the supply of saltpetre became a serious matter, he was placed at the head of the commission entrusted with the development of its production in French territory, and another commission on which he served had for its object the improvement of the methods of iron manufacture. He was also a member in 1794 of the committee on agriculture and the arts, and technical science was further indebted to him for a systematic exposition of the principles of dyeing—*Éléments de l'art de la teinture*, 1791, of which he published a second edition in 1800, in association with his son, A. B. Berthollet (1783-1811). After 1794 he was teacher of chemistry in the polytechnic and normal schools of Paris, and in 1795 he took an active part in remodelling the Academy as the Institut National. In the following year he and Gaspard Monge were chosen chiefs of a commission charged with the task of selecting in Italy the choicest specimens of ancient and modern art for the national galleries of Paris; and in 1798 he was one of the band of scientific men who accompanied Napoleon to Egypt, there forming themselves into the Institute of Egypt on the plan of the Institut National. On the fall of the Directory he was made a senator and grand officer of the Legion of Honour; under the empire he became a count; and after the

restoration of the Bourbons he took his seat as a peer. In the later years of his life he had at Arcueil, where he died on the 6th of November 1822, a well-equipped laboratory, which became a centre frequented by some of the most distinguished scientific men of the time, their proceedings being published in three volumes, between 1807 and 1817, as the *Mémoires de la société d'Arcueil*. Berthollet's most remarkable contribution to chemistry was his *Essai de statique chimique* (1803), the first systematic attempt to grapple with the problems of chemical physics. His doctrines did not meet with general approval among his contemporaries, partly perhaps because he pushed them too far, as for instance in holding that two elements might combine in constantly varying proportions, a view which gave rise to a long dispute with L. J. Proust; but his speculations, in particular his insistence on the influence of the relative masses of the acting substances in chemical reactions, have exercised a dominating influence on the modern developments of the theory of chemical affinity, of which, far more than T. O. Bergman, whom he controverted, he must be regarded as the founder.

BERTHON, EDWARD LYON (1813-1899), English inventor, was born in London, on the 20th of February 1813, the son of an army contractor and descendant of an old Huguenot family. He studied for the medical profession in Liverpool and at Dublin, but after his marriage in 1834 he gave up his intention of becoming a doctor, and travelled for about six years on the continent. Keenly interested from boyhood in mechanical science, he made experiments in the application of the screw propeller for boats. But his model, with a two-bladed propeller, was only ridiculed when it was placed before the British admiralty. Berthon therefore did not complete the patent and the idea was left for Francis Smith to bring out more successfully in 1838. In 1841 he entered Magdalene College, Cambridge, in order to study for the Church. There he produced what is usually known as "Berthon's log," in which the suction produced by the water streaming past the end of a pipe projected below a ship is registered on a mercury column above. In 1845 he was ordained, and after holding a curacy at Lymington was given a living at Fareham. Here he was able to carry on experiments with his log, which was tested on the Southampton to Jersey steamboats; but the British admiralty gave him no encouragement, and it remained uncompleted. He next designed some instruments to indicate the trim and rolling of boats at sea; but the idea for which he is chiefly remembered was that of the "Berthon Folding Boat" in 1849. This invention was again adversely reported on by the admiralty. Berthon resigned his living at Fareham, and subsequently accepted the living of Romsey. In 1873, encouraged by Samuel Plimsoll, he again applied himself to perfecting his collapsible boat. Success was at last achieved, and in less than a year he had received orders from the admiralty for boats to the amount of £15,000. Some were taken by Sir George Nares to the Arctic, others were sent to General Gordon at Khartoum, and others again were taken to the Zambesi by F. C. Selous. Berthon died on the 27th of October 1899.

BERTHOUD, FERDINAND (1727-1807), Swiss chronometer-maker, was born at Plancemont, Neuchâtel, in 1727, and settling in Paris in 1745 gained a great reputation for the excellence and accuracy of his chronometers. He was a member of the Institute and a fellow of the Royal Society of London, and among other works wrote *Essai sur l'horlogerie* (1763). He died in 1807 at Montmorency, Seine et Oise. He was succeeded in business by his nephew, Louis Berthoud (1750-1813).

BERTILLON, LOUIS ADOLPHE (1821-1883), French statistician, was born in Paris on the 1st of April 1821. Entering the medical profession, he practised as a doctor for a number of years. After the revolution of 1870, he was appointed inspector-general of benevolent institutions. He was one of the founders of the school of anthropology of Paris, and was appointed a professor there in 1876. His *Démographie figurée de la France* (1874) is an able statistical study of the population of France. He died at Neuilly on the 28th of February 1883.

His son ALPHONSE BERTILLON, the anthropometrist, was born in Paris in 1853. He published in 1883 a work *Ethnographie*

moderne des races sauvages, but his chief claim to distinction lies in the system invented by him for the identification of criminals, which is described by him in his *Photographie judiciaire*, Paris, 1800 (see ANTHROPOMETRY). He was officially appointed in 1804 to report on the handwriting of the *bordereau* in the Dreyfus case, and was a witness for the prosecution before the court de cassation on the 18th of January 1809.

BERTIN, a family of distinction in the history of French journalism. The most important member of the family, generally regarded as the father of modern French journalism, LOUIS FRANÇOIS BERTIN (1766-1841), known as Bertin *ainé*, was born in Paris on the 14th of December 1766. He began his journalistic career by writing for the *Journal Français* and other papers during the French Revolution. After the 18th Brumaire he founded the paper, with which the name of his family has chiefly been connected, the *Journal des Débats*. He was suspected of royalist tendencies by the consulate and was exiled in 1801. He returned to Paris in 1804 and resumed the management of the paper, the title of which had been changed by order of Napoleon to that of *Journal de l'Empire*. Bertin had to submit to a rigorous censorship, and in 1811 the conduct, together with the profits, was taken over entirely by the government. In 1814 he regained possession and restored the old title and continued his support of the royalist cause—during the Hundred Days; he directed the *Moniteur de Gand*—till 1823, when the *Journal des Débats* became the recognized organ of the constitutional opposition. Bertin's support was, however, given to the July monarchy after 1830. He died on the 13th of September 1841. LOUIS FRANÇOIS BERTIN DE VAUX (1771-1842), the younger brother of Bertin *ainé*, took a leading part in the conduct of the *Journal des Débats*, to the success of which his powers of writing greatly contributed. He entered the chamber of deputies in 1815, was made councillor of state in 1827, and a peer of France in 1830. The two sons of Bertin *ainé*, EDOUARD FRANÇOIS (1797-1871) and LOUIS MARIE FRANÇOIS (1801-1854), were directors in succession of the *Journal des Débats*. Edouard Bertin was also a painter of some distinction.

BERTINORO, OBADIAH, Jewish commentator of the Mishnah, died in Jerusalem about 1500. Bertinoro much improved the status of the Jews in the Holy Land; before his migration thither the Jews of Palestine were in a miserable condition of poverty and persecution. His commentary on the Mishnah is the most useful of all helps to the understanding of that work. It is printed in most Hebrew editions of the Mishnah. Surenhusius, in his Latin edition of the last-named code (Amsterdam 1698-1703), translated Bertinoro's commentary.

BERTINORO, a town and episcopal see of Emilia, Italy, in the province of Forlì, 8 m. S.E. direct of Forlì and 5½ m. N. of the station of Forlimpopoli, and 800 ft. above sea-level. Pop. (1001) town, 3753; commune, 7786. The town commands a fine view to the north over the plain of Emilia and the lower course of the Po, itself lying on the foothills of the Apennines. It appears to have been first fortified by Frederick Barbarossa, and its castle stood frequent sieges in the middle ages. Polenta, 2½ m. to the south of it, was the birthplace of Francesca da Rimini. The castle is almost entirely ruined, but the church of S. Donato, of the Lombard period, with Byzantine capitals, is interesting; Giosuè Carducci has written a fine ode on the subject (*La Chiesa di Polenta*, Bologna, 1897).

See C. Ricci, "Della Chiesa e castello di Polenta" in *Atti e Memorie della Deputazione di Storia patria per le provincie di Romagna*, ser. iii. vol. ix. (Bologna, 1891), 1 seq. (T. As.)

BERTOLD (1442-1504), elector and archbishop of Mainz, son of George, count of Henneberg, entered the ecclesiastical profession, and after passing through its lower stages, was made archbishop of Mainz in 1484. He appears to have been a firm supporter of law and order, an enemy of clerical abuses and a careful administrator of his diocese. Immediately after his election as archbishop he began to take a leading part in the business of the Empire, and in 1486 was very active in securing the election of Maximilian as Roman king. His chief work, however, was done as an advocate of administrative reform in Germany.

During the reign of the emperor Frederick III. he had brought this question before the diet, and after Frederick's death, when he had become imperial chancellor, he was the leader of the party which pressed the necessity for reform upon Maximilian at the diet of Worms in 1495. His proposals came to nothing, but he continued the struggle at a series of diets, and urged the Germans to emulate the courage and union of the Swiss cantons. He gained a temporary victory when the diet of Augsburg in 1500 established a council of regency (*Reichsregiment*), and in 1502 persuaded the electors to form a union to uphold the reforms of 1495 and 1500. The elector died on the 21st of December 1504. Bertold was a man of great ability and resourcefulness, and as a statesman who strove for an ordered and united Germany was far in advance of his age.

See J. Weiss, *Bertold von Henneberg, Erzbischof von Mainz* (Freiburg, 1889).

BERTOLD VON REGENSBURG (c. 1220-1272), the greatest German preacher of the later middle ages, was a native of Regensburg, and entered the Franciscan monastery there. From about 1250 onwards his fame as a preacher spread over all the German-speaking parts of the continent of Europe. He wandered from village to village and town to town, preaching to enormous audiences, always in the open air; the earnestness and straightforward eloquence with which he insisted that true repentance came from the heart, that pious pilgrimages and the absolution of the Church were mere outward symbols, appealed to all classes. He died in Regensburg on the 13th of December 1272. His German sermons, of which seventy-one have been preserved, are among the most powerful in the language, and form the chief monuments of Middle High German prose. His style is clear, direct and remarkably free from cumbersome Latin constructions; he employed, whenever he could, the pithy and homely sayings of the peasants, and is not reluctant to point his moral with a rough humour. As a thinker, he shows little sympathy with that strain of medieval mysticism which is to be observed in all the poetry of his contemporaries.

The best edition of Bertold's German sermons is that by F. Pfeiffer and A. Strobel (2 vols., 1862-1880; reprinted, 1906); there is also a modern German version by F. Göbel (4th ed., 1906). The Latin sermons were edited by G. Jakob (1880). See C. W. Strohmer, *Bertold von Regensburg, der grösste Volksprediger des deutschen Mittelalters* (1877). K. Unkel, *Bertold von Regensburg* (1882), and E. Bernhardt, *Bruder Bertold von Regensburg* (1905). A. E. Schönbach, *Studien zur Geschichte der altdutschen Predigt* (Publications of the Vienna Academy, 1906).

BERTRAM, CHARLES (1723-1765), English literary impostor, was born in London, the son of a silk dyer. In 1747, being then teacher of English at the school for Danish naval cadets at Copenhagen, he wrote to Dr William Stukeley, the English antiquarian, that he had discovered a manuscript written by a monk named Richard of Westminster, which corrected and supplemented the *Itinerary* of Antoninus in Britain. He subsequently sent to Stukeley a copy of various parts of the work and a facsimile of a few lines of the manuscript. These were so cleverly executed that they quite deceived the English palaeographers of the period. Stukeley, finding that a chronicler of the fourteenth century, Richard of Cirencester, had also been an inmate of Westminster Abbey, identified him with Bertram's Richard of Westminster, and, in 1756, read an analysis of the "discovery" before the Society of Antiquaries, which was published with a copy of Richard's map. In 1757 Bertram published at Copenhagen a volume entitled *Britannicarum Gentium Historiae Antiquae Scriptores Tres*. This contained the works of Gildas and Nennius and the full text of Bertram's forgery, and though Bertram's map did not correspond with that of Richard, Stukeley discarded the latter and adopted Bertram's concoction in his *Itinerarium Curiosum* published in 1776. Although Thomas Reynolds in his *Iter Britanniarum* (1799), an edition of the British portion of Antoninus' *Itinerary*, was distinctly sceptical as to the value of Bertram's manuscript, its authenticity was generally accepted until the middle of the 19th century. No original of the manuscript could then be found at Copenhagen, and B. B. Woodward, librarian of Windsor Castle, proved conclusively, by a series of articles in the *Gentleman's Magazine* in 1866 and 1867, that

the supposed facsimile of calligraphy produced by Bertram was a blend of the style of various periods, while the greater portion of the idiomatic Latin in the book was a mere translation of 18th century English phraseology. Nevertheless, as late as 1872, a translation of Bertram's forgery was included in Bohn's Antiquarian Library as one of the *Six English Chronicles*, and there is no doubt that the work had a wide and misleading influence upon many antiquarian writers. Bertram died in 1765.

BERTRAND, HENRI GRATIEN, COMTE (1773-1844), French general, was born at Châteauroux. At the outbreak of the Revolution, he had just finished his studies, and he entered the army as a volunteer. During the expedition to Egypt, Napoleon named him colonel (1798), then brigadier-general, and after Austerlitz his aide-de-camp. His life was henceforth closely bound up with that of Napoleon, who had the fullest confidence in him, honouring him in 1813 with the title of grand marshal of the court. It was Bertrand who in 1800 directed the building of the bridges by which the French army crossed the Danube at Wagram. In 1813, after the battle of Leipzig, it was due to his initiative that the French army was not totally destroyed. He accompanied Napoleon to Elba in 1814, returned with him in 1815, held a command in the Waterloo campaign, and then, after the defeat, accompanied Napoleon to St Helena. He did not return to France until after Napoleon's death, and then Louis XVIII. allowed him to retain his rank, and he was elected deputy in 1830. In 1840 he was chosen to go to bring Napoleon's remains to France. He died at Châteauroux on the 31st of January 1844. His touching fidelity has made his name very popular in France.

BERTRICH, a village and watering place of Germany, in the Prussian Rhine province, in a narrow valley running down to the Mosel near Cochem. Its waters are efficacious in cases of gout, rheumatism and biliary affections. Pop. 500.

BÉRULLE, PIERRE DE (1575-1629), French cardinal and statesman, was born at Scilly, near Troyes, on the 4th of February 1575. He was educated by the Jesuits and at the university of Paris. Soon after his ordination in 1599, he assisted Cardinal Duperron in his controversy with the Protestant Philippe de Mornay, and made numerous converts. He founded the Congregation of the French Oratory in 1611 and introduced the Carmelite nuns into France, notwithstanding the opposition of the friars of that order, who were jealous of his ascendancy. Bérulle also played an important part as a statesman. He obtained the necessary dispensations from Rome for Henrietta Maria's marriage to Charles I., and acted as her chaplain during the first year of her stay in England. In 1626, as French ambassador to Spain, he concluded the treaty of Monzon. After the reconciliation of Louis XIII. with his mother, Marie de' Medici, through his agency, he was appointed a councillor of state, but had to resign this office, owing to his Austrian policy, which was opposed by Richelieu. Bérulle encouraged Descartes' philosophical studies, and it was through him that the Samaritan Pentateuch, recently brought over from Constantinople, was inserted in Lejay's *Polyglot Bible*. His treatise, *Des Grands de Jésus*, was a favourite book with the Jansenists. He died on the 2nd of October 1629. His works, edited by P. Bourgoing (2 vols., 1644) were reprinted, by Migne in 1857.

See *M. de Bérulle et les Carmélites; Le Père de Bérulle et l'oratoire de Jésus; Le Cardinal de Bérulle et Richelieu* (3 vols., 1872-1876), by the Abbé M. Houssaye; and H. Sidney Lear's *Priestly Life in France in the Seventeenth Century* (London, 1873).

BERVIE, or INVERBERVIE, a royal and police burgh of Kincardineshire, Scotland. Pop. (1901) 1207. It is situated at the mouth of Bervie Water and is the terminus of the North British railway's branch line from Montrose, which lies 14 m. S.W. The leading industries include manufactures of woollens, flax and chemicals, and there is also a brisk trade in live-stock. Bervie unites with Arbroath, Brechin, Forfar and Montrose in returning one member (for the "Montrose burghs") to parliament. David II., driven by stress of weather, landed here with his queen Joanna in 1341, and, out of gratitude for the hospitality

of the townsfolk, granted them a charter, which James VI. confirmed. Hallgreen Castle, a stronghold of the 14th century, is maintained in repair. About one m. south is the fishing village of Gourdon (pop. 1197), where boat-building is carried on. There is a small but steady export business from the harbour, which has a pier and breakwater. St Ternan's, the Romanesque parish church of Arbuthnot, 2½ m. north-west, stands on the banks of the Bervie. In the chapel dedicated to St Mary, which was afterwards added to it, is the burial-place of the Arbuthnots, who took their title from the estate in 1644. John Arbuthnot, Queen Anne's physician and the friend of Swift and Pope, was a native of the parish. Kinneff, 2 m. north, on the coast, is of interest as the place where the Scottish regalia were concealed during the siege of Dunnotar Castle.

BERWICK, JAMES FITZJAMES, DUKE OF (1670-1734), marshal of France, was the natural son of James, duke of York, afterwards James II. of England, by Arabella Churchill (1648-1730), sister of the great duke of Marlborough. He was born at Moulins (Bourbonnais) on the 21st of August 1670. He received his education in France at the hands of the Jesuits, and at the age of fifteen, his father having succeeded to the throne, he was sent to learn the business of a soldier under the famous general of the empire, Charles of Lorraine. He served his first campaign in Hungary, and was present at the siege of Buda. He then returned to England, was made a colonel of the 8th Foot, and in 1687 created duke of Berwick, earl of Teignmouth and Baron Bosworth. He then went out afresh to Hungary and was present at the battle of Mohacz. On his return to England he was made K.G., colonel of the 3rd troop of horse guards (Royal Horse Guards Blue) and governor of Portsmouth, but soon afterwards the revolution forced him to flee to France. He served under James II. in the campaign in Ireland, and was present at the battle of the Boyne. For a short time he was left in Ireland as commander-in-chief, but his youth and inexperience unfitted him for the post, and he was a mere puppet in stronger hands. He then took service in the French army, fought under Marshal Luxembourg in Flanders, and took part in the battles of Steinkirk and Neerwinden, at the latter of which he was taken prisoner. He was, however, immediately exchanged for the duke of Ormond, and afterwards he served under Villeroi. In 1695 he married the widow of Patrick Sarsfield, who died in 1698. His second marriage, with Anne Bulkeley, took place in 1700. As a lieutenant-general he served in the campaign of 1702, after which he became naturalized as a French subject in order to be eligible for the marshalate. In 1704, he first took command of the French army in Spain. So highly was he now esteemed for his courage, abilities and integrity, that all parties were anxious to have him on their side (*Éloge*, by Montesquieu). His tenure of the command was, however, very short, and after one campaign he was replaced by the Marshal de Tessé. In 1705 he commanded against the Camisards in Languedoc, and when on this expedition he is said to have carried out his orders with remorseless rigour. His successful expedition against Nice in 1706 caused him to be made marshal of France, and in the same year he returned to Spain as commander-in-chief of the Franco-Spanish armies. On the 25th of April 1707, the duke won the great and decisive victory of Almanza, where an Englishman at the head of a French army defeated Ruvigny, earl of Galway, a Frenchman at the head of an English army. The victory established Philip V. on the throne of Spain. Berwick was made a peer of France by Louis XIV., and duke of Liria and of Xeroca and lieutenant of Aragon by Philip. Thenceforward Berwick was recognized as one of the greatest generals of his time, and successively commanded in nearly all the theatres of war. From 1709 to 1712 he defended the south-east frontier of France in a series of campaigns which, unmarked by any decisive battle, were yet models of the art of war as practised at the time. The last great event of the War of the Spanish Succession was the storming of Barcelona by Berwick, after a long siege, on the 11th of September 1714. Three years later he was appointed military governor of the province of Guienne, in which post he became intimate with

Montesquieu. In 1718 he found himself under the necessity of once more entering Spain with an army; and this time he had to fight against Philip V., the king who owed chiefly to Berwick's courage and skill the safety of his throne. One of the marshal's sons, known as the duke of Liria, was settled in Spain, and was counselled by his father not to shrink from doing his duty and fighting for his sovereign. Many years of peace followed this campaign, and Marshal Berwick was not again called to serve in the field till 1733. He advised and conducted the siege of Philippsburg, and while the siege was going on was killed by a cannon-shot on the 12th of June 1734. Cool, self-possessed and cautious as a general, Marshal Berwick was at the same time not wanting in audacity and swiftness of action. He was a true general of the 18th century, not less in his care for the lives of his men than in his punctiliousness and rigidity in matters of discipline.

The *Mémoires* of Marshal Berwick, revised, annotated and continued by the Abbé Hooke, were published by the marshal's grandson in 1778. Montesquieu made many contributions to this.

BERWICKSHIRE, a county of Scotland, forming its south-eastern extremity, bounded N. by Haddingtonshire and the North Sea; E. by the North Sea; S.E. by the county of the borough and town of Berwick; S. by the Tweed and Roxburghshire, and W. by Mid-Lothian. Its area is 292,577 acres or 457 sq. m., and it has a coast-line of 21 m. The county is naturally divided into three districts: Lauderdale, or the valley of the Leader, in the W.; Lammermuir, the upland district occupied by the hills of that name in the N.; and the Merse (the March or Borderland, giving a title to the earls of Wemyss), the largest district, occupying the S.E. The Lammermuirs are a range of round-backed hills, whose average height is about 1000 ft., while the highest summit, Says Law, reaches 1740 ft. From these hills the Merse stretches to the S. and E., and is a comparatively level tract of country. The coast is lofty, rocky and precipitous, broken by ravines and not accessible, except at Eyemouth Harbour, for small vessels, and at Coldingham and Burnmouth for fishing boats. St Abb's Head, a promontory with a lighthouse upon it, rises to 310 ft. The Eye is the only river of any size which falls directly into the sea. The others—the Leader, the Eden, the Leet and the Whiteadder with its tributaries, the Blackadder and the Dye—all flow into the Tweed. Of these the largest and most important is the Whiteadder, which has its source in the parish of Whittinghame on the East Lothian side of the Lammermuirs, and, following a sinuous course of 35 m., joins the Tweed within the bounds or liberties of Berwick. There are small lochs at Coldingham, Legerwood, Spottiswoode, the Hirsell, near Coldstream, Hule Moss on Greenlaw Moor, and tiny sheets of water near Duns and Mersington.

Geology.—The north portion of the county embraces that part of the Silurian tableland of the south of Scotland which stretches from the Lammermuir Hills east to St Abb's Head. The strata consist mainly of grits, greywackes, flags and shales, repeated by innumerable folds, trending north-east and south-west, which are laid bare in the great cliff section between Fast Castle and St Abb's Head. This section of the tableland includes sediments, chiefly of Tarannon age, which form a belt 10 m. across from the crest of the Lammermuir Hills to a point near Westruther and Longformacus. In the Earnsclough Burn north-east of Lauder representatives of Llandoverly, Caradoc and Llandeilio rocks, together with the Arenic cherts, appear along an anticlinal fold in the midst of the younger strata. Again in the extreme north-west of the county near Channekirk and to the north of the Tarannon belt radiolarian cherts and black shales with graptolites of Upper Llandeilio and Caradoc age are met with. The Lower Old Red Sandstone rocks, which rest unconformably on the folded and denuded Silurian strata, appear at Eyemouth and Reston Junction, and at St Abb's Head are associated with contemporaneous volcanic rocks which are evidently on the same horizon as the interbedded lavas of Lower Old Red age in the Cheviots. The intrusive igneous materials of this period are represented by the granitic mass of Cockburn Law and the porphyrites of the Dirrington Laws. The Upper Old Red Sand-

stone, consisting of conglomerates and sandstones, rest unconformably alike on the Silurian platform as at Siccar Point and on the lower division of that system. The age of these beds has been determined by the occurrence of remains of *Holoptychius nobilissimus* in the sandstones at Earlston and in the Whiteadder north of Duns. On the Black Hill of Earlston these strata are traversed by a sheet of trachyte resembling the type of rock capping the Eildon Hills (see ROXBURGHSHIRE: *Geology*). Overlying the strata just described there is a succession of volcanic rocks extending from Greenlaw southwards by Stichil and Kelso to Carham, which, at several localities, are followed by a band of corstone resembling that near the top of the Upper Old Red Sandstone in the midland valley of Scotland. Next in order comes a great development of the Cementstone group of the Carboniferous system which spreads over nearly the whole of the low ground of the Merse and attains a great thickness. At Marshall Meadows north of Berwick-on-Tweed, thin bands of marine limestone occur, which probably represent some of the calcareous beds above the Fell sandstones south of Spittal.

Climate and Agriculture.—Owing to the maritime position, the winter is seldom severe in the lowland districts, but spring is a trying season on account of the east winds, which often last into summer. The mean annual rainfall is 30½ in. and the average temperature for the year is 47° F., for January 37° F., and for July 58.5° F. The climate is excellent as regards both the health of the inhabitants and the growth of vegetation. The soils vary, sometimes even on the same farm. Along the rivers is a deep rich loam, resting on gravel or clay, chiefly the former. The less valuable clay soil of the Merse has been much improved by drainage. The more sandy and gravelly soils are suitable for turnips, of which great quantities are grown. Oats and barley are the principal grain crops, but wheat also is raised. The flocks of sheep are heavy, and cattle are pastured in considerable numbers. Large holdings predominate—indeed, the average size is the highest in Scotland—and scientific farming is the rule. The labourers, who are physically well developed, are as a whole frugal, industrious and intelligent, but somewhat migratory in their habits. This feature in their character, which they may have by inheritance as Borderers, has admirably fitted them for colonial life, to which the scarcity of industrial occupation has largely driven the surplus population.

Other Industries.—Next to agriculture the fisheries are the most important industry. The Tweed salmon fisheries are famous, and the lesser rivers of the Merse are held in high esteem by anglers. Eyemouth, Burnmouth, Coldingham and Cove are engaged in the sea fisheries. Cod, haddock, herring, ling, lobsters and crabs are principally taken. The season for herring is from May to the middle of September and for white fish from October to the end of May. Coal, copper ore and ironstone exist in too small quantities to work, and the limestone is so far from a coal district as to be of little economic value. Earlston sends out gingham and woollen cloths. At Cumledge on the Whiteadder, blankets and plaids are manufactured, and paper is made at Chirnside. The other manufactures are all connected with agriculture, such as distilleries, breweries, tanneries, &c. The trade is also mainly agricultural. Fairs are held at Duns, Lauder, Coldstream and Greenlaw; but the sales of cattle and sheep mostly take place at the auction marts at Reston, Duns and Earlston. There are grain markets at Reston and Earlston. Berwick, from which the county derives its name, is still its chief market. There is, however, no legal or fiscal connexion between the county and the borough.

The North British railway monopolizes the communications of the county. The system serves the coast districts from Berwick to Cockburnspath, and there is a branch from Reston to St Boswells.

Population and Government.—The population of Berwickshire was 32,290 in 1801 and 30,824 in 1901, in which year the number of persons speaking Gaelic and English was 74, and one person spoke Gaelic only. The only considerable towns are Eyemouth (pop. in 1901. 2436) and Duns (2206). The county returns one

member to parliament. Lauder is the only royal burgh, and Duns the county town, a status, however, which was held by Greenlaw from 1606 to 1853, after which date it was shared by both towns until conferred on Duns alone. Berwickshire forms a sheriffdom with Roxburgh and Selkirk shires, and there is a resident sheriff-substitute at Duns, who sits also at Greenlaw, Coldstream, Aytoun and Lauder. In addition to board and voluntary schools throughout the county, there is a high school, which is also a technical school, at Duns, and Coldstream and Lauder public schools have secondary departments. Duns school is subsidized by the county council, which pays the expenses of students attending it from a distance.

History.—Traces of Roman occupation and of ancient British settlement exist in various parts of the Merse. Edin's or Etin's Hall, on Cockburn Law, 4 m. north of Duns, is still called the Pech's or Pict's House, and is one of the very few brochs found in the Lowlands. After the Romans withdrew (400) the country formed part of the Saxon kingdom of Northumbria, and the inhabitants were converted to Christianity through the missionary efforts of Modan in the 6th, and Oswald, Aidan and Cuthbert (traditionally believed to have been born in the vale of the Leader) in the 7th centuries. The Northmen invaded the seaboard, but the rugged coast proved an effectual barrier. The Danes, however, landed in 886, and destroyed the nunnery at Coldingham, founded about 650 by Ebba, daughter of Æthelfrith, king of Northumbria, after whom the adjoining promontory of St Abb's Head was named. After the battle of Carham (1018) the district, which then constituted part of the division of Lothian, was annexed to Scotland. Birgham (pron. Birjam), 3½ m. west of Coldstream, was the scene of the conference in 1188 between William the Lion and the bishop of Durham, which discussed the attempt of the English church to assert supremacy over the Scottish. Here also met in 1280 a convention of the Scots estates to consider the projected marriage of Prince Edward of England to the Maid of Norway; and here was signed in 1290 the treaty of Birgham, assuring the independence of Scotland. During the long period of international strife the shire was repeatedly overrun by armies of the English and Scots kings, who were constantly fighting for the ancient frontier town of Berwick. It was finally ceded to England in 1482, and the people afterwards gradually settled down to peaceful pursuits. The ford at the confluence of the Leet and Tweed near Coldstream gave access to south-eastern Scotland. Edward I. crossed it with his army in 1206, encamping at Hutton the day before the siege of Berwick, and it was similarly employed as late as 1640, when the marquess of Montrose led the Covenanters on their march to Newcastle, although James VI. had already caused a bridge to be constructed from Berwick to Tweedmouth. There are several places of historic interest in the county. Upon the site of the nunnery at Coldingham King Edgar in 1008 founded a Benedictine priory, which was one of the oldest monastic institutions in Scotland and grew so wealthy that James III. annexed its revenues to defray his extravagance, a step that precipitated the revolt of the nobles (1488). The priory was seriously damaged in the earl of Hertford's inroad in 1545, and Cromwell blew up part of the church in 1650. The chancel (without aisles) was repaired and used as the parish church. The remains contain some fine architectural features, such as, on the outside, the Romanesque arcades surmounted by lancet windows at the east end, and, in the interior, the Early Pointed triforium. On the coast, about 4 m. north-west of Coldingham, are the ruins of Fast Castle—the "Wolf's Crag" of Scott's *Bride of Lammermoor*—situated on a precipitous headland. From Sir Patrick Hume it passed to Sir Robert Logan of Restalrig, who is alleged to have been one of the Gowrie conspirators, and to have intended to imprison James VI. within its walls (1600). Four miles west is the Pease or Peaths bridge, built by Thomas Telford in 1786 across the deep pass which was of old one of the strongest natural defences of Scotland. The bridge is 123 ft. high, 300 ft. long and 16 ft. wide. Near it are the ruins of Cockburnspath Tower, once a strong fortress and supposed to be the "Ravenswood" of the *Bride of Lammermoor*. In the

south-west of the shire besides Dryburgh Abbey (*q.v.*) there are, at Earliston, the remains of the castle that was traditionally the residence of Thomas the Rhymer. Hume Castle, the ancient seat of the Home family, a picturesque ruin about 3 m. south of Greenlaw, is so conspicuously situated as to be visible from nearly every part of the county. Coldstream and Lamberton, being close to the Border, were both resorted to (like Gretna Green in the west) by eloping couples for clandestine marriage. In Lamberton church was signed in 1502 the contract for the marriage of James IV. and Margaret Tudor, which led, a century later, to the union of the crowns of Scotland and England.

See W. S. Crockett, *Minstrelsy of the Merse* (Paisley, 1893); *In Praise of Tweed* (Selkirk, 1899); *The Scott County* (London, 1902); J. Robson, *The Churches and Churchyards of Berwickshire* (Kelso, 1893); F. H. Groome, *A Short Border History* (Kelso, 1895); J. Tate, *Two Centuries of Border Church Life* (Kelso, 1899); Margaret Warrender, *Marchmont and the Humes of Polwarth* (Edinburgh, 1894); W. K. Hunter, *History of the Priory of Coldingham* (Edinburgh, 1858).

BERWICK-UPON-TWEED, a market town, seaport, municipal borough and county in itself, of England, at the mouth of the Tweed on the north bank, 339 m. N. by W. from London. Pop. (1901) 13,437. For parliamentary purposes it is in the Berwick-upon-Tweed division of Northumberland. It is the junction on the East Coast route from London to Scotland between the North Eastern and North British railways, a branch of the company first named running up the Tweed valley by Coldstream and Kelso. The town lies in a bare district on the slope and flat summit of an abrupt elevation, higher ground rising to the north and south across the river. It has the rare feature of a complete series of ramparts surrounding it. Those to the north and east are formed of earth faced with stone, with bastions at intervals and a ditch now dry. They are of Elizabethan date, but there are also lines of much earlier date, the fortifications of Edward I. Much of these last has been destroyed, and threatened encroachment upon the remaining relics so far aroused public feeling that in 1905 it was decided that the Board of Works should take over these ruins, including the Bell Tower, from the town council, and enclose them as national relics. The Bell Tower, from which alarms were given when border raiders were observed, is in fair preservation. There are slight remains of the castle, which fell into disrepair after the union of the crowns of England and Scotland. There are no traces of the churches, monasteries or other principal buildings of the ancient town. The church of Holy Trinity is a plain building without steeple, of the time of Cromwell. Of modern places of worship, the most noteworthy is Wallace Green United Presbyterian church (1850). The chief public building is the town hall (1760), a stately classic building surmounted by a lofty spire. Educational institutions include an Elizabethan grammar school and a blue-coat school; and there is a local museum. Two bridges connect the town with the south side of the Tweed. The older, which is very substantial, was finished in 1634, having taken twenty-four years in building. It has fifteen arches, and is 924 ft. long, but only 17 ft. wide. A unique provision for its upkeep out of Imperial funds dates from the reign of Charles II. The other, the Royal Border Bridge, situated a quarter of a mile up the river, is a magnificent railway viaduct, 126 ft. high, with twenty-eight arches, which extends from the railway station, a castellated building on part of the site of the old castle, to a considerable distance beyond the river. This bridge was designed by Robert Stephenson and opened by Queen Victoria in 1850.

The reach of the river from the old bridge to the mouth forms the harbour. The entrance to the harbour is protected by a stone pier, which stretches half a mile south-east from the north bank of the river mouth. The depth of water at the bar is 17 ft. at ordinary tides, 22 ft. at spring tides, but the channel is narrow, a large rocky portion of the harbour on the north side being dry at low water. There is a wet dock of 3½ acres. Principal exports are grain, coal and fish; imports are bones and bone-ash, manure stuffs, linseed, salt, timber and iron. The herring and other sea fisheries are of some value, and the salmon fishery, in the hands of a company, has long been famous. A fair is held

annually at the end of May. There are iron-works and boat-building yards.

The custom of specially mentioning Berwick-upon-Tweed after Wales, though abandoned in acts of parliament, is retained in certain proclamations. The title of "county in itself" also helps to recall its ancient history. The liberties of the borough, commonly called Berwick Bounds, include the towns of Spittal, at the mouth, and Tweedmouth immediately above it, on the south bank of the river. The first is a watering-place (pop. 2074), with pleasant sands and a chalybeate spa; the second (pop. 3086) has iron foundries, engineering works and fish-curing establishments. Berwick-upon-Tweed is governed by a mayor, 6 aldermen and 18 councillors. Area, 6396 acres.

Very little is known of the history of Berwick before the Conquest. It was not until the Tweed became the boundary between England and Scotland in the 12th century that Berwick as the chief town on that boundary became really important. Until the beginning of the 14th century Berwick was one of the four royal boroughs of Scotland, and although it possesses no charter granted before that time, an inquisition taken in Edward III.'s reign shows that it was governed by a mayor and bailiffs in the reign of Alexander III., who granted the town to the said mayor and the commonalty for an annual rent. After Edward I. had conquered Berwick in 1302 he gave the burgesses another charter, no longer existing but quoted in several confirmations, by which the town was made a free borough with a gold merchant. The burgesses were given the right to elect annually their mayor, who with the commonalty should elect four bailiffs. They were also to have freedom from toll, pontage, &c., two markets every week on Monday and Friday, and a fair lasting from the feast of Holyrood to that of the Nativity of St John the Baptist. Five years later, in 1307, the mayor and burgesses received another charter, granting them for their town with all things that belonged to it at the time of Alexander III., for a fee-farm rent of 500 marks, which was granted back to them in 1313 to help towards enclosing their town with a wall. While the war with Scotland dragged on through the early years of the reign of Edward II., the fortification of Berwick was a matter of importance, and in 1317 the mayor and bailiffs undertook to defend it for the yearly sum of 6000 marks; but in the following year, "owing to their default," the Scots entered and occupied it in spite of a truce between the two kingdoms. After Edward III. had recovered Berwick the inhabitants petitioned for the recovery of their prison called the Belfroy or Bell tower, the symbol of their independence, which their predecessors had built before the time of Alexander III., and which had been granted to William de Keythorpe when Edward I. took the town. Edward III. in 1326 and 1356 confirmed the charter of Edward I., and in 1357, evidently to encourage the growth of the borough, granted that all who were willing to reside there and desirous of becoming burgesses should be admitted as such on payment of a fine. These early charters were confirmed by most of the succeeding kings, until James I. granted the incorporation charter in 1604; but on his accession to the English throne, Berwick of course lost its importance as a frontier town. Berwick was at first represented in the court of the Exchequer and in 1326 in Robert Bruce's parliament. After being taken by the English it remained unrepresented until it was re-taken by the Scots, when it sent two members to the parliament at Edinburgh from 1476 to 1479. In 1482 the burgesses were allowed to send two members to the English parliament, and were represented there until 1885, when the town was included in the Berwick-upon-Tweed division of the county of Northumberland. No manufactures are mentioned as having been carried on in Berwick, but its trade, chiefly in the produce of the surrounding country, was important in the 12th century. It has been noted for salmon fishery in the Tweed from very early times. There was a bridge over the Tweed at Berwick in the time of Alexander and John, Kings of Scotland, but it was broken down in the time of the latter and not rebuilt until the end of the 14th century.

See *Victoria County History, Northumberland*; John Fuller, *History of Berwick-upon-Tweed*, &c. (1799); John Scott, *Berwick-upon-Tweed: a Mineral of the Town and Guild* (1888).

BERYL, a mineral containing beryllium and aluminium in the form of a silicate; its formula is $Be_3 Al_2 Si_6 O_{18}$. The species includes the emerald (*q.v.*), the aquamarine (*q.v.*) and other transparent varieties known as "precious beryl," with certain coarse varieties unfit for use as gem-stones. The name comes from the Gr. $\beta\acute{\eta}\rho\alpha\lambda\lambda\omicron\varsigma$, a word of uncertain etymology applied to the beryl and probably several other gems. It is notable that the relation of the emerald to the beryl, though proved only by chemical analysis, was conjectured at least as far back as the time of Pliny.

Beryl crystallizes in the hexagonal system, usually taking the form of long six-sided prisms, striated vertically and terminated

with the basal plane, sometimes associated with various pyramidal faces (see fig.). It cleaves rather imperfectly parallel to the base. The colour of beryl may be blue, green, yellow, brown or rarely pink; while in some cases the mineral is colourless. The specific gravity is about 2.7, and the hardness 7.5 to 8, so that for a gem-stone beryl is comparatively soft. Whilst the gem-varieties are transparent, the coarse beryl may be opaque. The transparent crystals are pleochroic—a character well marked in emerald.

Beryl was much prized as a gem-stone by the ancients, and Greek intaglios of very fine workmanship are extant. The Roman jewellers, taking advantage of the columnar form of the natural crystal, worked it into long cylinders for ear-pendants. It was a favourite stone with the artists of the Renaissance, but in modern times has lost popularity, except in the form of emerald, which remains one of the most valued gem-stones. It is notable that English lapidaries of the 18th century often included the sard under the term beryl—a practice which has led to some confusion in the nomenclature of engraved gems.

Beryl occurs as an accessory constituent of many granitic rocks, especially in veins of pegmatite, whilst it is found also in gneiss and in mica-schist. Rolled pebbles of beryl occur, with topaz, in Brazil, especially in the province of Minas Geraes. Crystals are found in drusy cavities in granite in the Urals, notably near Mursinka; in the Altai Mountains, which have yielded very long prismatic crystals; and in the mining district of Nerchinsk in Siberia, principally in the Adun-Chalon range, where beryl occurs in veins of topaz-rock piercing granite. Among European localities may be mentioned Elba, good crystals being occasionally found in the tourmaline-granite of San Piero. In Ireland excellent crystals of beryl occur in druses of the granite of the Mourne Mountains in Co. Down, and others less fine are found in the highlands of Donegal, whilst the mineral is also known from the Leinster granite. It occurs likewise in the granite of the Grampians in Scotland, and is not unknown in Cornwall, specimens having been found, with topaz, apatite, &c., in joints of the granite of St Michael's Mount.

Many localities in the United States yield beryl, sometimes sufficiently fine to be cut as a gem. It is found, for example, at Hiddenite and elsewhere in Alexander county, N.C.; at Haddam and Monroe, Conn.; at Stoneham and at Albany, in Oxford county, Maine; at Royalston, Mass.; and at Mt. Antero, Colorado, where it occurs with phenacite. Beryl of beautiful pink colour occurs in San Diego county, California. Coarse beryl, much rifted, is found in crystals of very large size at Grafton and Acworth, N.H.; a crystal from Grafton weighing more than 2½ tons. A colourless beryl from Goshen, Mass., has been called Goshenite; whilst crystals of coarse yellow beryl from Rubislaw quarry in Aberdeenshire, Scotland, have been termed Davidsonite.

Beryl suffers alteration by weathering, and may thus pass into kaolin and mica.

BERYLLIUM, or **GLUCINIUM** (symbol Be, atomic weight 9.1), one of the metallic chemical elements, included in the same sub-group of the periodic classification as magnesium. It was prepared in the form of its oxide in 1798 by L. N. Vauquelin (*Ann. de chimie*, 1798, xxvi, p. 155) from the mineral beryl, and though somewhat rare, is found in many minerals. It was first obtained, in an impure condition, in 1828 by A. A. B. Bussy (1794-1882) and F. Wöhler by the reduction of the chloride with potassium, and in 1855 H. J. Debray prepared it, in a compact state, by reducing the volatilized chloride with melted sodium, in an atmosphere of hydrogen. L. F. Nilson and O. Pettersson (*Wied. Ann.* 1878, iv, p. 554) have also prepared the metal by heating beryllium potassium fluoride with sodium; P. M. Lebeau (*Comptes rendus*, 1895-1898, vols. 120-127) has obtained it in lustrous hexagonal crystals by electrolyzing the double fluoride of beryllium and sodium or potassium with an excess of

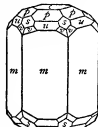

Crystal of beryl.

beryllium fluoride. It is a malleable metal, of specific gravity 1.64 (Nilson and Pettersson) and a specific heat of 0.4079. Its melting-point is below that of silver. In a fine state of division it takes fire on heating in air, but is permanent at ordinary temperatures in oxygen or air; it is readily attacked by hydrochloric and sulphuric acids, but scarcely acted on by nitric acid. It is also soluble in solutions of the caustic alkalis, with evolution of hydrogen a behaviour similar to that shown by aluminium. It combines readily with fluorine, chlorine and bromine, and also with sulphur, selenium, phosphorus, &c.

Considerable discussion has taken place at different times as to the position which beryllium should occupy in the periodic classification of the elements, and as to whether its atomic weight should be 9.1 or 13.65, but the weight of evidence undoubtedly favours its position in Group II., with an atomic weight 9.1 (O=16) (see Nilson and Pettersson, *Berichte*, 1880, 13, p. 1451; 1884, 17, p. 987; B. Brauner, *Berichte*, 1881, 14, p. 53; T. Carnelley, *Journ. of Chem. Soc.*, 1879, xxxv, p. 563; 1880, xxxvii, p. 125, and W. N. Hartley, *Journ. of Chem. Soc.*, 1883, xliii, p. 316). The specific heat of beryllium has been calculated by L. Meyer (*Berichte*, 1880, 13, p. 1780) from the data of L. F. Nilson and O. Pettersson, and appears to increase rapidly with increasing temperature, the values obtained being 0.3073 at 20° C., 0.4481 at 73.2° C. and 0.5819 at 256.8° C.

Beryllium compounds are almost wholly prepared from beryl. The mineral is fused with potassium carbonate, and, on cooling, the product is treated with sulphuric acid, the excess of which is removed by evaporation; water is then added and the silica is filtered off. On concentration of the solution, the major portion of the aluminium present separates as alum, and the mother liquor remaining contains beryllium and iron sulphates together with a little alum. This is now treated for some days with a hot concentrated solution of ammonium carbonate, which precipitates the iron and aluminium but keeps the beryllium in solution. The iron and aluminium precipitates are filtered off, and the filtrate boiled, when a basic beryllium hydroxide containing a little ferric oxide is precipitated. To remove the iron, the precipitate is again dissolved in ammonium carbonate and steam is blown through the liquid when iron oxide is precipitated. This operation is repeated several times, and the final precipitate is dissolved in hydrochloric acid and precipitated by ammonia, washed and dried. It has also been obtained by J. Gibson (*Journ. of Chem. Soc.*, 1893, xliii, p. 909) from beryl by conversion of the beryllium into its fluoride.

Beryllium oxide, beryllia or glucina, BeO , is a very hard white powder which can be melted and distilled in the electric furnace, when it condenses in the form of minute hexagonal crystals. After ignition it dissolves with difficulty in acids. The hydroxide $\text{Be}(\text{OH})_2$ separates as a white bulky precipitate on adding a solution of an alkaline hydroxide to a soluble beryllium salt; and like those of aluminium and zinc, this hydroxide is soluble in excess of the alkaline hydroxide, but is reprecipitated on prolonged boiling. Beryllium chloride BeCl_2 , like aluminium chloride, may be prepared by heating a mixture of the oxide and sugar charcoal in a current of dry chlorine. It is deliquescent, and readily soluble in water, from which it separates on concentration in crystals of composition $\text{BeCl}_2 \cdot 4\text{H}_2\text{O}$. Its vapour density has been determined by Nilson and Pettersson, and corresponds to the molecular formula BeCl_2 . The sulphate is obtained by dissolving the oxide in sulphuric acid; if the solution be not acid, it separates in pyramidal crystals of composition $\text{BeSO}_4 \cdot \text{H}_2\text{O}$, while from an acid solution of this salt, crystals of composition $\text{BeSO}_4 \cdot 7\text{H}_2\text{O}$ are obtained. Double sulphates of beryllium and the alkali metals are known, e.g. $\text{Be}(\text{NO}_3)_2 \cdot \text{K}_2\text{SO}_4 \cdot 3\text{H}_2\text{O}$ as are also many basic sulphates. The nitrate $\text{Be}(\text{NO}_3)_2 \cdot 3\text{H}_2\text{O}$ is prepared by adding barium nitrate to beryllium sulphate solution; it crystallizes with difficulty and is very deliquescent. It readily yields basic salts.

The carbide BeC_2 is formed when beryllia and sugar charcoal are heated together in the electric furnace. Like aluminium carbide it is easily decomposed by water with the production of methane. Several basic carbonates are known, being formed by the addition of beryllium salts to solutions of the alkaline carbonates; the normal carbonate is prepared by passing a current of carbon dioxide through water containing the basic carbonate in suspension, the solution being filtered and concentrated over sulphuric acid in an atmosphere of carbon dioxide. The crystals so obtained are very unstable and decompose rapidly with evolution of carbon dioxide.

Beryllium salts are easily soluble and mostly have a sweetish taste (hence the name *Glimmerstein* (g.l., from $\gamma\lambda\mu\kappa\sigma\varsigma$, sweet); they are readily precipitated by alkaline hydroxides with formation of the white hydroxide, and may be distinguished from salts of all other metals by the solubility of the oxide in ammonium carbonate. Beryllium is estimated quantitatively by precipitation with ammonia, and ignition to oxide. Its atomic weight has been determined by L. F.

Nilson and O. Pettersson (*Berichte*, 1880, 13, p. 1451) by analysis of the sulphate, from which they took the value 9.08, and by G. Krüss and H. Morath (*Berichte*, 1890, 23, p. 2556) on the conversion of the sulphate $\text{BeSO}_4 \cdot 4\text{H}_2\text{O}$ into the oxide, from which they obtained the value 9.05. C. L. Parsons (*Journ. Amer. Chem. Soc.*, 1904, xxvi, p. 721) obtained the values 9.113 from analyses of beryllium acetoxy-l-acetate and beryllium basic acetate.

For a bibliography see C. L. Parsons, *The Chemistry and Literature of Beryllium* (1909).

BERYLLONITE, a mineral phosphate of beryllium and sodium, NaBe_2PO_4 , found as highly complex orthorhombic crystals and as broken fragments in the disintegrated material of a granitic vein at Stoneham, Maine, where it is associated with feldspar, smoky quartz, beryl and columbite. It was discovered by Prof. E. S. Dana in 1888, and named beryllonite because it contains beryllium in large amount. The crystals vary from colourless to white or pale yellowish, and are transparent with a vitreous lustre; there is a perfect cleavage in one direction. Hardness 5½-6; specific gravity 2.845. A few crystals have been cut and faceted, but, as the refractive index is no higher than that of quartz, they do not make very brilliant gem-stones.

BERZELIUS, JÖNS JAKOB (1779-1848), Swedish chemist, was born at Väversunda Sogard, near Linköping, Sweden, on the 20th (or 29th) of August 1779. After attending the gymnasium school at Linköping he went to Upsala University, where he studied chemistry and medicine, and graduated as M.D. in 1802. Appointed assistant professor of botany and pharmacy at Stockholm in the same year, he became full professor in 1807, and from 1815 to 1832 was professor of chemistry in the Caroline medico-surgical institution of that city. The Stockholm Academy of Sciences elected him a member in 1808, and in 1818 he became its perpetual secretary. The same year he was ennobled by Charles XIV., who in 1835 further made him a baron. His death occurred at Stockholm on the 7th of August 1848. During the first few years of his scientific career Berzelius was mainly engaged on questions of physiological chemistry, but about 1807 he began to devote himself to what he made the chief object of his life—the elucidation of the composition of chemical compounds through study of the law of multiple proportions and the atomic theory. Perceiving the exact determination of atomic and molecular weights to be of fundamental importance, he spent ten years in ascertaining that constant for some two thousand simple and compound bodies, and the results he published in 1818 attained a remarkable standard of accuracy, which was still further improved in a second table that appeared in 1826. He used oxygen—in his view the pivot round which the whole of chemistry revolves—as the basis of reference for the atomic weights of other substances, and the data on which he chiefly relied were the proportions of oxygen in oxygen compounds, the doctrines of isomorphism, and Gay Lussac's law of volumes. When Volta's discovery of the electric cell became known, Berzelius, with W. Hisinger (1766-1852), began experiments on the electrolysis of salt solutions, ammonia, sulphuric acid, &c., and later this work led him to his electrochemical theory, a full exposition of which he gave in his memoir on *The Theory of Chemical Proportions and the Chemical Action of Electricity* (1814). This theory was founded on the supposition that the atoms of the elements are electrically polarized, the positive charge predominating in some and the negative in others, and from it followed his dualistic hypothesis, according to which compounds are made up of two electrically different components. At first this hypothesis was confined to inorganic chemistry, but subsequently he extended it to organic compounds, which he saw might similarly be regarded as containing a group or groups of atoms—a compound radicle—in place of simple elements. Although his conception of the nature of compound radicles did not long retain general favour—indeed he himself changed it more than once—he is entitled to rank as one of the chief founders of the radicle theory. Another service of the utmost importance which he rendered to the study of chemistry was in continuing and extending the efforts of Lavoisier and his associates to establish a convenient system of chemical nomenclature. By using the initial letters of the Latin

(occasionally Greek) names of the elements as symbols for them, and adding a small numeral subscript, to show the number of atoms of each present in a compound, he introduced the present system of chemical formulation (see CHEMISTRY). Mention should also be made of the numerous improvements he effected in analytical methods and the technique of the blowpipe (*Über die Anwendung des Löthrohrs*, 1820), of his classification of minerals on a chemical basis, and of many individual researches such as those on tellurium, selenium, silicon, thorium, titanium, zirconium and molybdenum, most of which he isolated for the first time. Apart from his original memoirs, of which he published over 250, mostly in Swedish in the *Transactions* of the Stockholm Academy, his remarkable literary activity is attested by his *Lehrbuch der Chemie*, which went through five editions (first 1803-1818, fifth 1843-1848) and by his *Jahresbericht* or annual report on the progress of physics and chemistry, prepared at the instance of the Stockholm Academy, of which he published 27 vols. (1821-1848).

BES, or **BĒSAS** (Egypt. *Bēs* or *Bēsa*), the Egyptian god of recreation, represented as a dwarf with large head, goggle eyes, protruding tongue, shaggy beard, a bushy tail seen between his bow legs hanging down behind (sometimes clearly as part of a skin girdle) and usually a large crown of feathers on his head. A Bes-like mask was found by Petrie amongst remains of the twelfth dynasty, but the earliest occurrence of the god is in the temple of the queen Hatshepsut at Deir el Bahri (c. 1500 B.C.), where he is figured along with the hippopotamus goddess as present at the queen's birth. His figure is that of a grotesque mountebank, intended to inspire joy or drive away pain and sorrow, his hideousness being perhaps supposed actually to scare away the evil spirits. In his joyous aspect Bes plays the harp or flute, dances, &c. He is figured on mirrors, ointment vases and other articles of the toilet. Amulets and ornaments in the form of the figure or mask of Bes are common after the New Kingdom; he is often associated with children and with child-birth and is figured in the "birth-houses" devoted to the cult of the child-god. Perhaps the earliest known instance of his prominent appearance of large size in the sculptures of the temples is under Tahraka, at Jebel Barkal, Nubia, at the beginning of the 7th century B.C. As the protector of children and others he is the enemy of wooden beasts, such as lions, crocodiles, serpents and scorpions. Large wood figures of Bes are generally found to contain the remains of a human foetus. In the first centuries of our era an oracle of Besas was consulted at Abydos, where A. H. Sayce has found graffiti concerning him, and prescriptions exist for consulting Besas in dreams. It has been held that Bes was of non-Egyptian origin, African, as Wiedemann, or Arabian or even Babylonian, as W. Max Müller contends; he is sometimes entitled "coming from the Divine Land" (i.e. the East or Arabia), or "Lord of Puoni" (Punt), i.e. the African coast of the Red Sea; his effigy occurs also on Greek coins of Arabia. It is remarkable also that, contrary to the usual rule, he is commonly represented in Egyptian sculptures and paintings full faced instead of in profile. But the connexion of the god with Puoni may have grown out of the fact that dwarf dancers were especially brought to Egypt from Ethiopia and Puoni.

See K. Sethe in Pauly-Wissowa, *Realencyclopädie*, s.v. A. Wiedemann, *Religion of the Ancient Egyptians* (London, 1897), p. 159; E. A. W. Budge, *Gods of the Egyptians*, ii, p. 284 (London); W. Max Müller, *Asien u. Europa* (Leipzig, 1893), p. 310. (F. L. G.)

BESANÇON, a city of eastern France, capital of the department of Doubs, 76 m. E. of Dijon by the Paris-Lyon railway. Pop. (1906) town, 41,760; commune, 56,168. It is situated on the left bank of the river Doubs, 820 ft. above sea-level at the foot of the western Jura, and is enclosed by hills in every direction. The Doubs almost surrounds the city proper forming a peninsula, the neck of which is occupied by a height crowned by the citadel; on the right bank lie populous industrial suburbs. The river is bordered by fine quays, and in places by the shady promenades which are a feature of Besançon. On the right

bank there is a fine bathing establishment in the Mouillère quarter, supplied by the saline springs of Miserey. The cathedral of St Jean, the chief of the numerous churches of the town, was founded in the 4th century but has often undergone reconstruction and restoration; it resembles the Rhenish churches of Germany in the possession of apses at each of its extremities. Several styles are represented in its architecture which for the most part is the work of the 11th, 12th and 13th centuries; the eastern apse and the tower date from the reign of Louis XV. In the interior there are a "Madonna and Child" of Fra Bartolommeo and a number of other paintings and works of art. The archiepiscopal palace adjoining the cathedral is a building of the 18th century. The church of Ste. Madeleine belongs to the 18th and 19th centuries. The Palais de Granvelle, in the heart of the town, was built from 1534 to 1540 by Nicolas Perrenot de Granvelle, chancellor of Charles V., and is the most interesting of the secular buildings. It is built round a square interior court surrounded by arcades, and is occupied by learned societies. The hôtel de ville dates from the 16th century, to which period many of the old mansions of Besançon also belong. The law-court, rebuilt in recent times, preserves a Renaissance façade and a fine audience-hall of the 18th century. Some relics of old military architecture survive, among them a cylindrical tower of the 15th century near the Porte Notre-Dame, the southern gate of the city, and the Porte Rivotte, a gate of the 16th century, flanked by two round towers. The Roman remains at Besançon are of great archaeological value. Close to the cathedral there is a triumphal arch decorated with bas-reliefs known as the Porte Noire, which is generally considered to have been built in commemoration of the victories of Marcus Aurelius over the Germans in 167. It is in poor preservation and was partly rebuilt in 1820. Remains of a Roman theatre, of an amphitheatre, of an aqueduct which entered the town by the Porte Taillée, a gate cut in the rock below the citadel, and an arch of a former Roman bridge, forming part of the modern bridge, are also to be seen. Besançon has statues of Victor Hugo and of the Marquis de Jouffroy d'Abbans (b. 1751), inventor of steam-navigation.

Besançon is important as the seat of an archbishopric, a court of appeal and a court of assizes, as centre of an *académie* (educational division), as seat of a prefect and as headquarters of the VIIth army corps. It also has tribunals of first instance and of commerce, a chamber of commerce, a board of trade-arbitrators, an exchange and a branch of the Bank of France. Its educational establishments include the university with its faculties of science and letters and a preparatory school of medicine and pharmacy, an artillery school, the lycée Victor Hugo for boys, a lycée for girls, an ecclesiastical seminary, training colleges for teachers, and schools of watch-making, art, music and dairy-work. The library contains over 130,000 volumes, and the city has good collections of pictures, antiquities and natural history. The chief industry of Besançon is watch- and clock-making, introduced from the district of Neuchâtel at the end of the 18th century. It employs about 12,000 workpeople, and produces about three-fourths of the watches sold in France. Subsidiary industries, such as enamelling, are also important. The metallurgical works of the *Société de la Franche-Comté* are established in the city and there are saw-mills, printing-works, paper-factories, distilleries, and manufactories of boots and shoes, machinery, hosiery, leather, elastic fabric, confectionery and artificial silk. There is trade in agricultural produce, wine, metals, &c. The canal from the Rhone to the Rhine passes under the citadel by way of a tunnel, and the port of Besançon has considerable trade in coal, sand, &c.

As a fortress Besançon forms one of a group which includes Dijon, Langres and Belfort; these are designed to secure Franche Comté and to cover a field army operating on the left flank of a German army of invasion. The citadel occupies the neck of the peninsula upon which the town stands; along the river bank in a semicircle is the town *enceinte*, and the suburb of Battant on the right bank of the Doubs is also "regularly" fortified as a bridge-head. These works, and Forts Chaudanne and Brégille

overlooking the Doubs at the bend, were constructed prior to 1870. The newer works enclose an area more suited to the needs of modern warfare: the chain of detached forts along the ridges of the left bank has a total length of 7½ m., and the centre of this chain is supported by numerous forts and batteries lying between it and the citadel. On the other bank Fort Chaudanne is now the innermost of several forts facing towards the south-west, and the foremost of these works connects the fortifications of the left bank with another chain of detached forts on the right bank. The latter completely encloses a large area of ground in a semicircle of which Besançon itself is the centre, and the whole of the newer works taken together form an irregular ellipse of which the major axis, lying north-east by south-west, is formed by the Doubs.

Besançon is a place of great antiquity. Under the name of Vesontio it was, in the time of Julius Caesar, the chief town of the Sequani, and in 58 B.C. was occupied by that general. It was a rich and prosperous place under the Roman emperors, and Marcus Aurelius promoted it to the rank of a *colonia* as *Colonia Victrix Sequanorum*. During the succeeding centuries it was several times destroyed and rebuilt. The archbishopric dates from the close of the 2nd century, and the archbishops gradually acquired considerable temporal power. As the capital of the free county of Burgundy, or Franche-Comté, it was united with the German kingdom when Frederick I. married Beatrix, daughter of Renaud III., count of Upper Burgundy. In 1184 Frederick made it a free imperial city, and about the same time the archbishop obtained the dignity of a prince of the Empire. It afterwards became detached from the German kingdom, and during the 14th century came into the possession of the dukes of Burgundy, from whom it passed to the emperor Maximilian I., and his grandson Charles V. Cardinal Granvella, who was a native of the city, became archbishop in 1584, and founded a university which existed until the French Revolution. After the abdication of Charles V. it came into the possession of Spain, although it remained formally a portion of the Empire until its cession at the peace of Westphalia in 1648. During the 17th century it was attacked several times by the French, to whom it was definitely ceded by the peace of Nijmegen in 1678. It was then fortified by the engineer Vauban. Until 1789 it was the seat of a *parlement*. In 1814 it was invested and bombarded by the Austrians, and was an important position during the Franco-German War of 1870-71.

See A. Castan, *Besançon et ses environs* (Besançon, 1887); A. Guénard, *Besançon, description historique* (Besançon, 1860).

BESANT, SIR WALTER (1836-1901), English author, was born at Portsmouth, on the 14th of August 1836, third son of William Besant of that town. He was educated at King's College, London, and Christ's College, Cambridge, of which he was a scholar. He graduated in 1859 as 18th wrangler, and from 1861 to 1867 was senior professor of the Royal College, Mauritius. From 1868 to 1885 he acted as secretary to the Palestine Exploration Fund. In 1884 he was mainly instrumental in establishing the Society of Authors, a trade-union of writers designed for the protection of literary property, which has rendered great assistance to inexperienced authors by explaining the principles of literary profit. Of this society he was chairman from its foundation in 1884 till 1892. He married Mary, daughter of Mr Eustace Foster-Barham of Bridgwater, and was knighted in 1895. He died at Hampstead, on the 6th of June 1901. Sir Walter Besant practised many branches of literary art with success, but he is most widely known for his long succession of novels, many of which have enjoyed remarkable popularity. His first stories were written in collaboration with James Rice (*q.v.*). Two at least of these, *The Golden Butterfly* (1876) and *Ready-Money Mortiboy* (1872), are among the most vigorous and most characteristic of his works. Though not without exaggeration and eccentricity, attributable to the influence of Dickens, they are full of rich humour, shrewd observation and sound common-sense, and contain characters which have taken their place in the long gallery of British fiction. After Rice's death, Sir Walter Besant wrote alone, and in *All Sorts*

and *Conditions of Men* (1882) produced a stirring story of East End life in London, which set on foot the movement that culminated in the establishment of the People's Palace in the Mile End Road. Though not himself a pioneer in the effort made by Canon Barnett and others to alleviate the social evils of the East End by the personal contact of educated men and women of a superior social class, his books rendered immense service to the movement by popularizing it. His sympathy with the poor was shown in another attempt to stir public opinion, this time against the evils of the sweating system, in *The Children of Gibbon* (1886).

Other popular novels by him were *Dorothy Forster* (1884), *Armour of Lyonesse* (1890), and *Beyond the Dreams of Avarice* (1895). He also wrote critical and biographical works, including *The French Humorists* (1873), *Rabelais* (1879), and lives of Coligny, Whittington, Captain Cook and Richard Jefferies. Besant undertook a series of important historical and archaeological volumes, dealing with the associations and development of the various districts of London—of which the most important was *A Survey of London*, unfortunately left unfinished, which was intended to do for modern London what Stow did for the Elizabethan city. Other books on London (1892), *Westminster* (1895) and *South London* (1899) showed that his mind was full of his subject. No man of his time evinced a keener interest in the professional side of literary work, and the improved conditions of the literary career in England were largely due to his energetic and capable exposition of the commercial value of authorship and to the unselfish efforts which Sir Walter constantly made on behalf of his fellow-workers in the field of letters.

See also *Autobiography of Sir Walter Besant* (1902), with a preface note by S. S. Sprigge; the preface to the library edition (1887) of *Ready-Money Mortiboy* contains a history of the literary partnership of Besant and Rice.

BESENVAL DE BRONSTATT, PIERRE VICTOR, BARON DE (1722-1794), French soldier, was born at Soleure. He was the son of Jean Victor Besenval, colonel of the regiment of Swiss guards in the pay of France, who was charged in 1707 by Louis XIV. with a mission to Sweden, to reconcile Charles XII. with the tsar Peter the Great, and to unite them in alliance with France against England. Pierre Victor served at first as aide-de-camp to Marshal Broglie during the campaign of 1748 in Bohemia, then as aide-de-camp to the duke of Orleans during the Seven Years' War. He then became commander of the Swiss Guards. When the Revolution began Besenval remained firmly attached to the court, and he was given command of the troops which the king had concentrated on Paris in July 1789—a movement which led to the taking of the Bastille on the 14th of July. Besenval showed incompetence in the crisis, attempted to flee. He was arrested, tried by the tribunal of the Châtelet, but acquitted. He then fell into obscurity and died in Paris in 1794. Besenval de Bronstatt is principally known as the author of *Mémoires*, which were published in 1805-1807 by the vicomte T. A. de Ségur, in which are reported many scandalous tales, true or false, of the court of Louis XVI. and Marie Antoinette. The authenticity of these memoirs is not absolutely established.

BESKOW, BERNHARD VON, BARON (1796-1868), Swedish dramatist and historian, son of a Stockholm merchant, was born on the 10th of April 1796. His vocation for literature was assisted by his tutor, the poet Johan Magnus Stjernstolpe (1777-1831), whose works he edited. He entered the civil service in 1814, was ennobled in 1826 and received the title of baron in 1843. He held high appointments at court, and was, from 1834 onwards, perpetual secretary of the Swedish academy, using his great influence with tact and generosity. His poetry is over-decorated, and his plays are grandiose historical poems in dramatic form. Among them are "Erik XIV." (2 parts, 1826); and four pieces collected (1836-1838) as *Dramatiska Studier*; the most famous of which is the tragedy of "Thorkel Knutsson." His works include many academical memoirs, volumes of poems, philosophy and a valuable historical study,

Om Gustav den Tredje såsom konung och menniska (5 vols. 1860-1869, "Gustavus III. as king and man"), printed in the transactions of the Swedish Academy (vols. 32, 34, 37, 42, 44). He died on the 17th of October 1868.

See also a notice by C. D. af Wirsén in his *Lefnadsteckningar* (Stockholm, 1901).

BESNARD, PAUL ALBERT (1849-), French painter, was born in Paris and studied at the École des Beaux-Arts, winning the *Prix de Rome* in 1874. Until about 1880 he followed the academic tradition, but then broke away completely, and devoted himself to the study of colour and light as conceived by the impressionists. The realism of this group never appealed to his bold imagination, but he applied their technical method to ideological and decorative works on a large scale, such as his frescoes at the Sorbonne, the École de Pharmacie, the Salle des Sciences at the hôtel de ville, the mairie of the first arrondissement, and the chapel of Berck hospital, for which he painted twelve "Stations of the Cross" in an entirely modern spirit. A great virtuoso, he achieved brilliant successes alike in water-colour, pastel, oil and etching, both in portraiture, in landscape and in decoration. A good example of his daring unconventionality is his portrait of Madame Réjane; and his close analysis of light can be studied in his picture "Femme qui se chauffe" at the Luxembourg in Paris.

BESOM (Old Eng. *besema*, a rod), originally a bundle of rods or twigs, used for sweeping, &c.; a stiff broom.

BESSARABIA, a government of south-west Russia, separated on the W. and S. from Moldavia and Walachia by the Pruth, and on the E. and N. from the Russian governments of Podolia and Kherson by the Dniester; on the S.E. it is washed by the Black Sea. Area, 17,614 sq. m. The northern districts are invaded by offshoots of the Carpathians, which reach altitudes of 800 to 1150 ft., and are cut up by numerous ravines and river valleys. Here, however, agriculture is the prevailing occupation, the soil being the fertile black earth. The crops principally raised are wheat and maize, though here, as well as in other parts of the government, barley, flax, tobacco, water-melons, gourds, fruit, wine, saffron and madder are grown. The middle of the government is also hilly (850-1000 ft.), and is heavily timbered, chiefly with beech, oak and mountain-ash, and, though to a smaller extent, with birch. The districts south of the old Roman earthworks which link the Dniester with the Pruth along the line of the Botna, just south of Bender, consist of level pastureland known as the Budjak steppes. Here stock-breeding is the predominant calling, the people owning large numbers of sheep, cattle and horses, also goats, pigs and buffaloes. Lagoons fringe the lower course of the Pruth and the coast of the Black Sea, and marshy ground exists beside the Reuth and other tributaries of the Dniester. The climate is rather subject to extremes, the mean temperature for the year, at Kishinev, being 50° Fahr., of January 27°, and of July 72°. The rainfall amounts to over 25 in. annually. Salt, saltpetre and marble are the principal mineral products. Manufacturing industry is only just beginning, wine-making (17,000,000 gallons annually), cloth-mills, iron-works, soap-works and tanneries being the principal branches. Both the Dniester and the Pruth are important waterways commercially, the former being navigable up to Mogilev and the latter to Leovo (46° 30' N. lat.). Down the Dniester come timber and wooden wares from Galicia, and grain and wool from Bessarabia itself. Three branches of the railway from Odessa to Poland penetrate the government and proceed towards the Carpathians. The population numbered 988,431 in 1860 and 1,938,326 in 1897, of whom only 302,852 were urban, while 942,179 were women. In 1906 it was estimated at 2,262,400. It consists of various races, nearly one-half (920,019 in 1897) being Moldavians, the others Little Russians, Jews (37% in the towns and 14% in the rural districts), Bulgarians (103,225), Germans (60,200), with some Gypsies (Zigani), Greeks, Armenians, Tatars and Albanians. The Germans, who form some thirty prosperous colonies in the Budjak steppes west from Akkerman, have been settled there since about 1814. The government is divided into eight districts, the chief towns of which are Akker-

man (pop. 32,470 in 1900), Bender (33,741 in 1900), Byeltsi (18,526 in 1897), Izmail (33,607 in 1900), Khotin (18,126), Kishinev (125,787 in 1900), Orgeyev (113,356), and Soroki (25,523 in 1900). The capital is Kishinev. Kagul, on the Pruth, and Reni on the Danube (the place to which Alexander of Bulgaria was carried when kidnapped by the Russians in 1886), are small, but lively, river-ports.

The original inhabitants were Cimmerians, and after them came Scythians. During the early centuries of the Christian era Bessarabia, being the key to one of the approaches towards the Byzantine empire, was invaded by many successive races. In the 2nd century it was occupied by the Getae, a Thracian tribe, whom the Roman emperor Trajan conquered in 106; he then incorporated the region in the province of Dacia. In the following century the Goths poured into this quarter of the empire, and in the 5th century it was overrun one after the other by the Huns, the Avars and the Bulgarians. Then followed in the 7th century the Bessi, a Thracian tribe, who gave their name to the region, and in the 9th the Ugrians, that is to say the ancestors of the present Magyars of Hungary, the country being then known as Atel-kuzu. The Ugrians were forced farther west by the Turkish tribe of the Petchengs in the 10th century, and these were succeeded in the 11th century by the Kumans (Comani) or Polovtsians, a kindred Turkish stock or federation. In the 13th century Bessarabia was overrun by the irresistible Mongols under the leadership of Batu, grandson of Jenghiz Khan. In this century also the Genoese founded trading factories on the banks of the Dniester. In 1367 Bessarabia was subdued and annexed by the ruling prince of Moldavia. During the 16th century it was in the possession alternately of the Turks and the Nogais or Crimean Tatars. From early in the 18th century it was a bone of contention between the Ottoman Turks and the Russians, the latter capturing it five times between 1711 and 1812. In the latter year it was definitely annexed to Russia, and in 1829 its frontier was pushed southwards so as to include the delta of the Danube. After the Crimean War, however, Russia ceded to Moldavia not only this later addition, but also certain districts in the south of the existing government, amounting altogether to an area of 4250 sq. m. and a population of 180,000. By the treaty of Berlin (1878) Russia recovered of this 3580 sq. m., with a population of 127,000.

See Nakko, *History of Bessarabia*, in Russian (1873).

(P. A. K.; J. T. Be.)

BESSARION, JOHANNES, or BASILIUS (c. 1395-1472), titular patriarch of Constantinople, and one of the illustrious Greek scholars who contributed to the great revival of letters in the 15th century, was born at Trebizond, the year of his birth being variously given as 1389, 1395 or 1403. He was educated at Constantinople, and in 1423 went to the Peloponnese to hear Gemistus Pletho expound the philosophy of Plato. On entering the order of St Basil, he adopted the name of an old Egyptian anchorite Bessarion, whose story he has related. In 1437 he was made archbishop of Nicaea by John VII. Palaeologus, whom he accompanied to Italy in order to bring about a union between the Greek and Latin churches with the object of obtaining help from the West against the Turks. The Greeks had bitterly resented his attachment to the party which saw no difficulty in a reconciliation of the two churches. At the councils held in Ferrara and Florence Bessarion supported the Roman church, and gained the favour of Pope Eugenius IV., who invested him with the rank of cardinal. From that time he resided permanently in Italy, doing much, by his patronage of learned men, by his collection of books and manuscripts, and by his own writings, to spread abroad the new learning. He held in succession the archbishopric of Siponto and the bishoprics of Sabina and Frascati. In 1463 he received the title of Latin patriarch of Constantinople; and it was only on account of his Greek birth that he was not elevated to the papal chair. For five years (1450-1455) he was legate at Bologna, and he was engaged on embassies to many foreign princes, among others to Louis XI. of France in 1471. Vexation at an insult offered him by Louis is said to have hastened his death, which took place on the 19th

of November 1742, at Ravenna. Bessarion was one of the most learned scholars of his time. Besides his translations of Aristotle's *Metaphysics* and Xenophon's *Memorabilia*, his most important work is a treatise directed against George of Trebizond, a violent Aristotelian, entitled *In Calumniatorem Platonis*. Bessarion, who thought a Platonist, is not so thoroughgoing in his admiration as Gemistus Pletho, and rather strives after a reconciliation of the two philosophies. His work, by opening up the relations of Platonism to the main questions of religion, contributed greatly to the extension of speculative thought in the department of theology. His library, which contained a very extensive collection of Greek MSS., was presented by him to the senate of Venice, and formed the nucleus of the famous library of St Mark.

See A. M. Bandini, *De Vita et Rebus Gestis Bessarionis* (1777); H. Vast, *Le Cardinal Bessarion* (1878); E. Legrand, *Bibliographie Hellénique* (1885); G. Voigt, *Die Wiederbelebung des klassischen Altertums*, ii. (1893); on Bessarion at the councils of Ferrara and Florence, A. Sadov, *Bessarion de Nicée* (1883); on his philosophy, monograph by A. Kandelos (in Greek: Athens, 1888); most of his works are in Migne, *Patrologia Graeca*, cxi.

BESSBOROUGH, EARLS OF. The Ponsonby family, who have contributed many conspicuous men to Irish and English public life, trace their descent to Sir John Ponsonby (d. 1678), of Cumberland, a Commonwealth soldier who obtained land grants in Ireland. His son William (1657-1724) was created Baron Bessborough (1721) and Viscount Duncannon (1723), and the latter's son Brabazon was raised to the earldom of Bessborough in 1739. He was the father not only of the 2nd earl (1704-1793), but of John Ponsonby (q.v.), speaker of the Irish House of Commons. The 2nd earl was a well-known Whig politician, who held various offices of state; and his son the 3rd earl (1758-1844) was father of the 4th earl (1781-1847), first commissioner of works in 1831-1834, lord privy seal from 1835 to 1839 and lord-lieutenant of Ireland in 1846. He was succeeded by his three sons, the 5th earl (d. 1880), 6th earl (1815-1895), a famous cricketer and chairman of the Bessborough commission (1881) to inquire into the Irish land system, and 7th earl (d. 1906), and the last named by his son the 8th earl.

BESSÈGES, a town of south-eastern France, in the department of Gard, on the Cèze, 20 m. north of Alais by rail. Pop. (1906) 7662. The town is important for its coal-mines, blast-furnaces and iron-works.

BESSEL, FRIEDRICH WILHELM (1784-1846), German astronomer, was born at Minden on the 22nd of July 1784. Placed at the age of fifteen in a counting-house at Bremen, he was impelled by his desire to obtain a situation as supercargo on a foreign voyage to study navigation, mathematics and finally astronomy. In 1804 he calculated the orbit of Halley's comet from observations made in 1607 by Thomas Harriot, and communicated his results to H. W. M. Olbers, who procured their publication (*Monatliche Correspondenz*, x. 425), and recommended the young aspirant in 1805 for the post of assistant in J. H. Schröter's observatory at Lilienthal. A masterly investigation of the comet of 1807 (Königsberg, 1810) enhanced his reputation, and the king of Prussia summoned him, in 1810, to superintend the erection of a new observatory at Königsberg, of which he acted as director from its completion in 1813 until his death. In this capacity he inaugurated the modern era of practical astronomy. For the purpose of improving knowledge of star-places he reduced James Bradley's Greenwich observations, and derived from them an invaluable catalogue of 3222 stars, published in the volume rightly named *Fundamenta Astronomiae* (1818). In *Tabulae Regiomontanae* (1830), he definitively established the uniform system of reduction still in use. During the years 1821-1833, he observed all stars to the ninth magnitude in zones extending from -15° to $+45^{\circ}$ dec., and thus raised the number of those accurately determined to about 50,000. He corrected the length of the seconds' pendulum in 1826, in a discussion re-published by H. Bruns in 1889; measured an arc of the meridian in East Prussia in 1831-1832; and deduced for the earth in 1841 an ellipticity of $\frac{1}{298}$. His ascertainment in 1838 (*Astr. Nach.*, Nos. 365-366) of a parallax

of $0''.31$ for 61 Cygni was the first authentic result of the kind published. He announced in 1844 the binary character of Sirius and Procyon from their disturbed proper motions; and was preparing to attack the problem solved later by the discovery of Neptune, when fatal illness intervened. He died at Königsberg on the 17th of March 1846. Modern astronomy of precision is essentially Bessel's creation. Apart from the large scope of his activity, he introduced such important novelties as the effective use of the heliometer, the correction for personal equation (in 1823), and the systematic investigation of instrumental errors. He issued 21 volumes of *Astronomische Beobachtungen auf der Sternwarte zu Königsberg* (1815-1844), and a list of his writings drawn up by A. L. Busch appeared in vol. 24 of the same series. Especial attention should be directed to his *Astronomische Untersuchungen* (2 vols. 1841-1842), *Populäre Vorlesungen* (1848), edited by H. C. Schumacher, and to the important collection entitled *Abhandlungen* (4 vols. 1875-1882), issued by R. Engelmann at Leipzig. His minor treatises numbered over 350. In pure mathematics he enlarged the resources of analysis by the invention of Bessel's Functions. He made some preliminary use of these expressions in 1817, in a paper on Kepler's Problem (*Transactions Berlin Academy*, 1816-1817, p. 49), and fully developed them seven years later, for the purposes of a research into planetary perturbations (*Ibid.* 1824, pp. 1-52).

See also H. Durège, *Bessels Leben und Wirken* (Zürich, 1861); J. F. Encke, *Gedächtnissrede auf Bessel* (Berlin, 1846); C. T. Anger, *Erinnerung an Bessels Leben und Wirken* (Danzig, 1845); *Astronomische Nachrichten*, xxiv. 49, 331 (1846); *Monthly Notices Roy. Astr. Society*, vii. 199 (1847); *Allgemeine deutsche Biographie*, ii. 558-567.

BESSEL FUNCTION, a certain mathematical relation between two variables. The Bessel function of order m satisfies the differential equation $\frac{d^2u}{dx^2} + \frac{1}{x} \frac{du}{dx} + \left(1 - \frac{m^2}{x^2}\right)u = 0$, and may be expressed as the series $\frac{e^{-ix}}{2^m m!} \left\{ 1 - \frac{x^2}{2^2 m^2} + \frac{x^4}{4 \cdot 2^2 m^2 + 2 \cdot 4 \cdot 2^2 m^2 + 2 \cdot 4 \cdot 2^2 m^2} \dots \right\}$; the function of zero order is deduced by making $m=0$, and is equivalent to the series $1 - \frac{x^2}{2^2} + \frac{x^4}{2^2 \cdot 4^2} - \dots$. O. Schläömlich defines these functions as the coefficients of the power of t in the expansion of $\exp \frac{1}{2} \rho(t-t^{-1})$. The symbol generally adopted to represent these functions is $J_m(\rho)$ where m denotes the order of the function. These functions are named after Friedrich Wilhelm Bessel, who in 1817 introduced them in an investigation on Kepler's Problem. He discussed their properties and constructed tables for their evaluation. Although Bessel was the first to systematically treat of these functions, it is to be noted that in 1732 Daniel Bernoulli obtained the function of zero order as a solution to the problem of the oscillations of a chain suspended at one end. This problem has been more fully discussed by Sir A. G. Greenhill. In 1764 Leonhard Euler employed the functions of both zero and integral orders in an analysis into the vibrations of a stretched membrane; an investigation which has been considerably developed by Lord Rayleigh, who has also shown (1878) that Bessel's functions are particular cases of Laplace's functions. There is hardly a branch of mathematical physics which is independent of these functions. Of the many applications we may notice:—Joseph Fourier's (1824) investigation of the motion of heat in a solid cylinder, a problem which, with the related one of the flow of electricity, has been developed by W. E. Weber, G. F. Riemann and S. D. Poisson; the flow of electromagnetic waves along wires (Sir J. J. Thomson, H. Hertz, O. Heaviside); the diffraction of light (E. Lömmel, Lord Rayleigh, Georg Wilhelm Struve); the theory of elasticity (A. E. Love, H. Lamb, C. Chree, Lord Rayleigh); and to hydrodynamics (Lord Kelvin, Sir G. Stokes).

The remarkable connexion between Bessel's functions and spherical harmonics was established in 1868 by F. G. Mehler, who proved that a simple relation existed between the function of zero order and the zonal harmonic of order n . Heinrich Eduard Heine has shown that the functions of higher orders may be considered as limiting values of the associated functions;

this relation was discussed independently, in 1878, by Lord Rayleigh.

For the mathematical investigation see SPHERICAL HARMONICS and for tables see TABLE, MATHEMATICAL.

See A. Gray and G. B. Matthews, *Treatise on Bessel's Functions* (1895); *Encyclopædie der math. Wissenschaften*; F. W. Bessel, *Untersuchung des Teils der planetarischen Störungen* (1824).

BESSEMER, SIR HENRY (1813-1898), English engineer, was born on the 19th of January 1813, at Charlton, in Hertfordshire. Throughout his life he was a prolific inventor, but his name is chiefly known in connexion with the Bessemer process for the manufacture of steel, by which it has been rendered famous throughout the civilized world. Though this process is now largely supplemented, and even displaced, by various rivals, at the time it was brought out it was of enormous industrial importance, since it effected a great cheapening in the price of steel, and led to that material being widely substituted for others which were inferior in almost every respect but that of cost. Bessemer's attention was drawn to the problem of steel manufacture in the course of an attempt to improve the construction of guns. Coming to the conclusion that if any advance was to be made in artillery better metal must be available, he established a small ironworks in St Pancras, and began a series of experiments. These he carried on for two years before he evolved the essential idea of his process, which is the decarbonization of cast iron by forcing a blast of air through the mass of metal when in the molten condition. The first public announcement of the process was made at the Cheltenham meeting of the British Association in 1856, and immediately attracted considerable notice. Many metallurgists were sceptical on theoretical grounds about his results, and only became convinced when they saw that his process was really able to convert melted cast iron into malleable iron in a perfectly fluid state. But though five firms applied without delay for licences to work under his patents, success did not at once attend his efforts; indeed, after several ironmasters had put the process to practical trial and failed to get good results, it was in danger of being thrust aside and entirely forgotten. Its author, however, instead of being discouraged by this lack of success, continued his experiments, and in two years was able to turn out a product, the quality of which was not inferior to that yielded by the older methods. But when he now tried to induce makers to take up his improved system, he met with general rebuffs, and finally was driven to undertake the exploitation of the process himself. To this end he erected steelworks in Sheffield, on ground purchased with the help of friends, and began to manufacture steel. At first the output was insignificant, but gradually the magnitude of the operations was enlarged until the competition became effective, and steel traders generally became aware that the firm of Henry Bessemer & Co. was underselling them to the extent of £20 a ton. This argument to the pocket quickly had its effect, and licences were applied for in such numbers that, in royalties for the use of his process, Bessemer received a sum in all considerably exceeding a million sterling.

Of course, patents of such obvious value did not escape criticism, and invalidity was freely urged against them on various grounds. But Bessemer was fortunate enough to maintain them intact without litigation, though he found it advisable to buy up the rights of one patentee, while in another case he was freed from anxiety by the patent being allowed to lapse in 1859 through non-payment of fees. At the outset he had found great difficulty in making steel by his process—in his first licences to the trade iron alone was mentioned. Experiments he made with South Wales iron were failures because the product was devoid of malleability; Mr Göransson, a Swedish ironmaster, using the purer charcoal pig iron of that country, was the first to make good steel by the process, and even he was successful only after many attempts. His results prompted Bessemer to try the purer iron obtained from Cumberland haematite, but even with this he did not meet with much success, until Robert Mushet showed that the addition of a certain quantity of spiegeleisen had the effect of removing the difficulties.

Whether or not Mushet's patents could have been sustained, the value of his procedure was shown by its general adoption in conjunction with the Bessemer method of conversion. At the same time it is only fair to say that whatever may have been the conveniences of Mushet's plan, it was not absolutely essential; this Bessemer proved in 1865, by exhibiting a series of samples of steel made by his own process alone. The pecuniary rewards of Bessemer's great invention came to him with comparative quickness; but it was not till 1870 that the Royal Society admitted him as a fellow and the government honoured him with a knighthood. Bessemer died at Denmark Hill, London, on the 15th of March 1898.

Among Bessemer's numerous other inventions, not one of which attained a title of the success or importance of the steel process, were movable dies for embossed stamps, a gold paint, sugar machinery, and a ship which was to save her passengers from the miseries of *mal de mer*. This last had her saloon mounted in such a way as to be free to swing relatively to the boat herself, and the idea was that this saloon should always be maintained steady and level, no matter how rough the sea. For this purpose hydraulic mechanism of Bessemer's design was arranged under the control of an attendant, whose duty it was to keep watch on a spirit-level, and counteract by proper manipulation of the apparatus any deviation from the horizontal that might manifest itself on the floor of the saloon owing to the rolling of the vessel. A boat, called the "Bessemer," was built on this plan in 1875 and put on the cross-Channel service to Calais, but the mechanism of the swinging saloon was not found effective in practice and was ultimately removed.

An *Autobiography* was published in 1905.

BESSEMER, a town of Jefferson county, Alabama, U.S.A., about 12 m. S.W. of Birmingham, a little N. of the centre of the state. Pop. (1890) 4544; (1900) 6538, including 3695 negroes; (1910) 10,864. The town is served by the Alabama Great Southern (Queen & Crescent route), the Louisville & Nashville, the Kansas City, Memphis & Birmingham (St Louis & San Francisco system), the Birmingham Southern, and the Atlanta, Birmingham & Atlantic railways. Bessemer is situated in the midst of the iron ore and limestone district of Alabama, in the south part of Jones' Valley (about 3 m. wide.); to the east is the Red Ore mountain range, rich in red haematite; to the north-west are the Warrior coalfields; to the south-west, south and south-east are immense fossiliferous iron ore seams and the Cahaba coalfields; in the immediate vicinity of the city are limestone quarries, and about 18 m. north-east are the limestone kilns of Gate City. Mining, iron smelting and the manufacture of iron and coke are the chief industries of Bessemer; truck farming is also an important industry. In 1900 Bessemer was the eighth city of the state in population, second in amount of capital invested in manufacturing, and fourth in the value of its manufactured product for the year. Bessemer was laid out in 1837, and was incorporated in 1859.

BESSIÈRES, JEAN BAPTISTE, duke of Istria (1768-1813), French marshal, was born near Cahors in 1768. He served for a short time in the "Constitutional Guard" of Louis XVI. and as a non-commissioned officer took part in the war against Spain. In the Army of the Eastern Pyrenees and in the Army of the Moselle he repeatedly distinguished himself for valour, and in 1796, as captain, he served in Bonaparte's Italian campaign. At Rovredo his conduct brought him to his chief's notice, and after Rivoli he was sent to France to deliver the captured colours to the Directory. Hastening back to the front, he accompanied Napoleon in the invasion of Styria in command of the "Guides," who formed the nucleus of the later Consular and Imperial Guard. As *chef de brigade* he next served in the Egyptian expedition, and won further distinction at Acre and Aboukir. Returning to Europe with Napoleon, he was present at Marcngo (1800) as second-in-command of the Constular Guard, and led a brilliant and successful cavalry charge at the close of the day, though its effect on the battle was not as decisive as Napoleon pretended. Promoted general of division in 1802 and marshal of France in 1804, he made the most famous

campaigns of the *Grande Armée* as colonel-general of the Guard Cavalry (1805, 1806, 1807). In 1805 he had received the Grand Eagle of the Legion of Honour, and in 1809 was created duke of Istria. With the outbreak of the Peninsular War, Marshal Bessières had his first opportunity of an independent command, and his crushing victory over the Spaniards at Medina del Rio Seco (1808) justified Napoleon's choice. When disaster in other parts of the theatre of war called Napoleon himself to the Peninsula, Bessières continued to give the emperor the very greatest assistance in his campaign. In 1809 he was again with the *Grande Armée* in the Danube valley. At Essling his repeated and desperate charges checked the Austrians in the full tide of their success. At Wagram he had a horse killed under him. Replacing Bernadotte in the command of the Army of the North, a little later in the same year, the newly-created duke of Istria successfully opposed the British Walcheren expedition, and in 1811 he was back again, in a still more important command, in Spain. As Masséna's second-in-command he was present at the battle of Fuentes d'Onor, but Napoleon never detached him for very long, and in 1812 he commanded the Guard Cavalry at Borodino and in the retreat from Moscow. Wherever engaged he won further distinction, and at the beginning of the 1813 campaign he was appointed to the command of the whole of Napoleon's cavalry. Three days after the opening of the campaign, while reconnoitring the defile of Poserna-Rippach, Bessières was killed by a musket-ball. Napoleon, who deeply felt the loss of one of his truest friends and ablest commanders, protected his children, and his eldest son was made a member of the Chamber of Peers by Louis XVIII. As a commander, especially of cavalry, Bessières left a reputation excelled by very few of Napoleon's marshals, and his dauntless courage and cool judgment made him a safe leader in independent command. He was personally beloved to an extraordinary extent amongst his soldiers, and (unlike most of the French generals of the time) amongst his opponents. It is said that masses were performed for his soul by the priests of insurgent Spain, and the king of Saxony raised a monument to his memory.

His younger brother, BERTRAND, BARON BESSIÈRES (1773-1855), was a distinguished divisional leader under Napoleon. After serving with a good record in Italy, in Egypt and at Hohenlinden, he had a command in the *Grande Armée*, and in 1808 was sent to Spain. He commanded a division in Catalonia and played a notable part at the action of Molins de Rey near Barcelona. Disagreements with his superior, General Duhesme, led to his resignation, but he subsequently served with Napoleon in all the later campaigns of the empire. Placed on the retired list by the Bourbons, his last public act was his defence of the unfortunate Ney. The rest of his long life was spent in retirement.

BESSUS, satrap of Bactria and Sogdiana under Darius III. In the battle of Gaugamela (1st of October 331) he commanded the troops of his satrapy. When Alexander pursued the Persian king on his flight to the East (summer 330), Bessus with some of the other conspirators deposed Darius and shortly afterwards killed him. He then tried to organize a national resistance against the Macedonian conqueror in the eastern provinces, proclaimed himself king and adopted the name Artaxerxes. But he was taken prisoner by treachery in the summer of 329. Alexander sent him to Ecbatana, where he was condemned to death. Before his execution his nose and ears were cut off, according to the Persian custom; we learn from the Behistun inscription that Darius I. punished the usurpers in the same way.

BEST, WILLIAM THOMAS (1826-1897), English organist, the son of a solicitor, was born at Carlisle on the 13th of August 1826. Having decided upon a musical career, he received his first instruction from the cathedral organist. He applied himself especially to Bach's music, and became a player of great skill. His successive appointments were to Pembroke chapel, Liverpool, 1840; to a church for the blind, 1847, and the Liverpool Philharmonic Society, 1848. For a short time (1854-1855) he was in London at the Panopticon in Leicester Square, the church of St Martin-in-the-Fields, and Lincoln's Inn chapel. In 1855

he returned to Liverpool as organist of St George's Hall, where his performances rapidly became famous throughout England. Ill-health compelled him at last to retire in 1894. He was engaged as solo organist at all the Handel festivals at the Crystal Palace, and also as organist at the Albert Hall, where he inaugurated the great organ in 1871. He had been in the receipt of a civil list pension of £100 a year since 1880, and in 1890 went to Australia to give organ recitals in the town hall of Sydney. Best died at Liverpool on the 10th of May 1897.

His command over all the resources of his own instrument was mastery; his series of Saturday recitals at St George's Hall, carried on for many years, included the whole field of organ music, and of music that could be arranged for the organ, ancient and modern; and his performances of Bach's organ works were particularly fine. His own compositions for the organ, chiefly comprised in the publication entitled *Organ Pieces for Church Use*, have a strong and marked individuality. Best, unlike many soloists, was an all-round musician, and fully acquainted with every branch of the art. His bust, by Conrad Dressler, has been placed on the platform in front of the Liverpool organ, as a memorial of his long series of performances there.

BESTIA, the name of a family in ancient Rome, of which the following were the most distinguished.

1. **LUCIUS CALPURNIUS BESTIA**, Roman tribune of the people in 121 B.C., consul in 111. Having been appointed to the command of the operations against Jugurtha, he at first carried on the campaign energetically, but soon, having been heavily bribed, concluded a disgraceful peace. On his return to Rome he was brought to trial for his conduct and condemned, in spite of the efforts of Marcus Scaurus who, though formerly his legate and equally guilty, was one of the judges. He is probably identical with the Bestia who encouraged the Italians in their revolt, and went into exile (90) to avoid punishment under the law of Q. Varius, whereby those who had secretly or openly aided the Italian allies against Rome were to be brought to trial (Appian, *Bell. Civ. i. 37*; Val. Max. viii. 6. 4). Both Cicero and Sallust express a high opinion of Bestia's abilities, but his love of money demoralized him. He is mentioned in a Carthaginian inscription as one of a board of three, perhaps an agricultural commissioner.

See Sallust, *Jugurtha*; Cicero, *Brutus*, xxxiv. 128; for the general history, A. H. J. Greenidge, *Hist. of Rome*, vol. i. (1904), pp. 346 foll.

2. **LUCIUS CALPURNIUS BESTIA**, one of the Catilinarian conspirators, possibly a grandson of the above. He was tribune elect in 63, and it had been arranged that, after entering upon his office, he should publicly accuse Cicero of responsibility for the impending war. This was to be the signal for the outbreak of revolution. The conspiracy, however, was put down and Bestia had to content himself with delivering a violent attack upon the consul on the expiration of his office. This Bestia is probably not the Lucius Calpurnius Bestia, aedile, and a candidate for the praetorship in 57. He was accused of bribery during his candidature, and, in spite of Cicero's defence, was condemned. In 43 he attached himself to the party of Antony, apparently in the hope of obtaining the consulship.

Sallust, *Catiline*, xvii. 43; Appian, *Bell. Civ. ii. 3*; Cicero, *Ad Q. Fr. ii. 3, 6*.

BESTUZHEV-RYUMIN, ALEXIUS PETROVICH, COUNT (1693-1768), grand chancellor of Russia, the second son of Count Peter Bestuzhev, the early favourite of the empress Anne, was born at Moscow on the 1st of June 1693. Educated abroad, with his elder brother Mikhail, at Copenhagen and Berlin, he especially distinguished himself in languages and the applied sciences. Peter the Great, in 1712, attached him to Prince Kurakin at the Utrecht Congress that he might learn diplomacy, and for the same reason permitted him in 1713 to enter the service of the elector of Hanover. George I. took him to London in 1714, and sent him to St Petersburg as his accredited minister with a notification of his accession. Bestuzhev then returned to England, where he remained four years. It was the necessary apprenticeship to his brilliant diplomatic career. His passion for intrigue is curiously illustrated by his letter to the tsarevich

Alexius at Vienna, assuring his "future sovereign" of his devotion, and representing his sojourn in England as a deliberate seclusion of a zealous but powerless well-wisher. This extraordinary indiscretion might well have cost him his life, but the tsarevich fortunately destroyed the letter.¹ On his return to Russia he served for two years without any salary as chief gentleman of the Bedchamber at the court of Anne of Courland, and in 1721 succeeded Vasily Dolgoruki as Russian minister at Copenhagen. Copenhagen was then a whirlpool of diplomatic intrigue, for George I. was endeavouring to arm the northern powers against Peter the Great, and this it was Bestuzhev's mission to counteract. On the occasion of the peace of Nystad, which terminated the 21 years' war between Russia and Sweden, Bestuzhev designed and struck a commemorative medal with a panegyric Latin inscription, which so delighted Peter (then at Derbent) that he sent a letter of thanks written with his own hand and his portrait set in brilliants. It was at this time too that the many-sided Alexius invented his famous "drops," or *tinctura tonicensina Bestuzheffi*, the recipe of which was stolen by the French brigadier Lamotte, who made his fortune by introducing it at the French court, where it was known as *Élixir d'Or*.

The sudden death of Peter the Great seriously injured Bestuzhev's prospects. For more than ten years he remained at Copenhagen, looking vainly towards Russia as a sort of promised land from which he was excluded by enemies or rivals. He rendered some important services, however, to the empress Anne, for which he was decorated and made a privy councillor. He also won the favour of Biren, and on the tragic fall of Artemy Volynsky in 1730 was summoned home to take his place in the council. He assisted Biren to obtain the regency in the last days of the empress Anne, but when his patron fell three weeks later, his own position became extremely precarious. His chance came when the empress Elizabeth, immediately after her accession, summoned him back to court, and appointed him vice-chancellor. For the next twenty years, during a period of exceptional difficulty, he practically controlled the foreign policy of Russia. Bestuzhev rightly recognized that, at this time, France was the natural enemy of Russia. The interests of the two states in Turkey, Poland and Sweden were diametrically opposed, and Russia could never hope to be safe from the intrigues of France in these three borderlands. All the enemies of France were thus necessarily the friends of Russia, and her friends Russia's enemies. Consequently Great Britain, and still more Austria, were Russia's natural allies, while the aggressive and energetic king of Prussia was a danger to be guarded against. It was, therefore, the policy of Bestuzhev to bring about a quadruple alliance between Russia, Austria, Great Britain and Saxony, to counterpoise the Franco-Prussian league. But he was on dangerous ground. The empress herself was averse from an alliance with Great Britain and Austria, whose representatives had striven to prevent her accession; and many of her personal friends, in the pay of France and Prussia, took part in innumerable conspiracies to overthrow Bestuzhev. Nevertheless, step by step, Bestuzhev, aided by his elder brother Mikhail, carried out his policy. On the 11th of December 1742, a defensive alliance was concluded between Great Britain and Russia. Bestuzhev had previously rejected with scorn the proposals of the French government to mediate between Russia and Sweden on the basis of a territorial surrender on the part of the former; and he conducted the war so vigorously that by the end of 1742 Sweden lay at the mercy of the empress. At the peace congress of Åbo (January-August 1743) he insisted that the whole of Finland should be ceded to Russia, by way of completing the testament of Peter the Great. But the French party contrived to get better terms for Sweden, by artfully appealing to the empress's fondness for the house of Holstein. The Swedes, at the desire of Elizabeth, accepted Adolphus Frederick, duke of Holstein, as their future king, and, in return, received back Finland, with the exception of a small strip of land up to the river Kymmene. Nor could

¹ A copy of the letter was taken by way of precaution, beforehand, by the Austrian ministers, and this copy is still in the Vienna archives.

Bestuzhev prevent the signing of a Russo-Prussian defensive alliance (March 1743); but he deprived it of all political significance by excluding from it the proposed guarantee of Frederick's Silesian conquests. Moreover, through Bestuzhev's efforts, the credit of the Prussian king (whom he rightly regarded as more dangerous than France) at the Russian court fell steadily, and the vice-chancellor prepared the way for an alliance with Austria by acceding to the treaty of Breslau (1st of November 1743). A bogus conspiracy, however, got up by the Holstein faction, aided by France and Prussia, who persuaded Elizabeth that the Austrian ambassador was intriguing to replace Ivan VI. on the throne, alienated the empress from Austria for a time; and Bestuzhev's ruin was regarded as certain when, in 1743, the French agent, the marquis de La Chétardie, arrived to reinforce his other enemies. But he found a friend in need in M. L. Vorontsov, the empress's confidant, who shared his political views.² Still his position was most delicate, especially when the betrothal between the grand-duke Peter and Sophia of Anhalt-Zerbst (afterwards Catharine II.) was carried through against his will, and Elizabeth of Holstein, the mother of the bride, arrived in the Prussian interests to spy upon him. Frederick II., conscious of the instability of his French ally, was now eager to contract an offensive alliance with Russia; and the first step to its realization was the overthrow of Bestuzhev, "upon whom," he wrote to his minister Axel von Mardefeld, "the fate of Prussia and my own house depends." But Bestuzhev succeeded, at last, in convincing the empress that Chétardie was an impudent intriguer, and on the 6th of June 1744, that diplomatist was ordered to quit Russia within twenty-four hours. Five weeks later Bestuzhev was made grand chancellor (July 15th). Before the end of the year Elizabeth of Holstein was also expelled from Russia, and Bestuzhev was supreme.

The attention of European diplomacy at this time was concentrated upon the king of Prussia, whose insatiable acquisitiveness disturbed all his neighbours. Bestuzhev's offer, communicated to the British government at the end of 1745, to attack Prussia if Great Britain would guarantee subsidies to the amount of some £6,000,000, was rejected as useless now that Austria and Prussia were coming to terms. Then he turned to Austria, and on the 22nd of May 1746, an offensive and defensive alliance was concluded between the two powers manifestly directed against Prussia. In 1747, alliances were also concluded with Denmark and the Porte. At the same time Bestuzhev resisted any rapprochement with France, and severely rebuked the court of Saxony for its intrigues with that of Versailles. About this time he was hampered by the persistent opposition of the vice-chancellor Mikhail Vorontsov, formerly his friend, now his jealous rival, who was secretly supported by Frederick the Great. In 1748, however, he got rid of him by proving to the empress that Vorontsov was in the pay of Prussia. The hour of Bestuzhev's triumph coincided with the peace congress of Aix-la-Chapelle, which altered the whole situation of European politics and introduced fresh combinations, the breaking away of Prussia from France and a rapprochement between England and Prussia, with the inevitable corollary of an alliance between France and the enemies of Prussia. Bestuzhev's violent political prejudices at first prevented him from properly recognizing this change. Passion had always been too large an ingredient in his diplomacy. His Anglomania also misled him. His enemies, headed by his elder brother Mikhail and the vice-chancellor Vorontsov, powerless while his diplomacy was faultless, quickly took advantage of his mistakes. When, on the 16th of January 1756, the Anglo-Prussian, and on the 2nd of May the Franco-Austrian alliances were concluded, Vorontsov advocated the accession of Russia to the latter league, whereas Bestuzhev insisted on a subsidy treaty with Great Britain. But his influence was now on the wane. The totally unexpected Anglo-Prussian alliance had justified the arguments of his enemies that England was impossible, while his hatred of France prevented him from adopting the only alternative of an alliance with her. To prevent underground intrigues, Bestuzhev now proposed the erection of a council of ministers, to settle all important

affairs, and at its first session (14th-30th of March) an alliance with Austria, France and Poland against Frederick II. was proposed, though Bestuzhev opposed any composition with France. He endeavoured to support his failing credit by a secret alliance with the grand-duchess Catherine, whom he proposed to raise to the throne instead of her Holstein husband, Peter, from whom Bestuzhev expected nothing good either for himself or for Russia. The negotiations were conducted through the Pole Stanislaus Poniatowski. The accession of Russia to the anti-Prussian coalition (1756) was made over his head, and the cowardice and incapacity of Bestuzhev's friend, the Russian commander-in-chief, Stephen Apraksin, after the battle of Gross-Jagersdorf (1757), was made the pretext for overthrowing the chancellor. His unwillingness to agree to the coalition was magnified into a determination to defeat it, though it is quite obvious that he could only gain by the humiliation of Frederick, and nothing was ever proved against him. Nevertheless he was deprived of the chancellorship and banished to his estate at Goretovo (April 1759), where he remained till the accession of Catharine II., who recalled him to court and created him a field marshal. But he took no leading part in affairs and died on the 21st of April 1768, the last of his race.

See *The Shortest of the Russian Historical Society*, vols. 1, 3, 5, 7, 12, 22, 25, 66, 69, 80, 81, 85-86, 91, 92, 96, 99, 100, 103 (St Petersburg, 1870, &c.); *Politische Correspondenz Friedrichs des Grossen*, vols. 1-21 (Berlin, 1879-1904); R. Nisbet Bain, *The Daughter of Peter the Great* (London, 1899). (R. N. B.)

BESTUZHEV-RYUMIN, MIKHAIL PETROVICH, COUNT (1688-1760), Russian diplomatist, elder brother of the foregoing, was educated at Berlin, and was sent by Peter the Great to represent Russia at Copenhagen in 1705. In 1720 he was appointed resident at London at a time when the English court was greatly inflamed against Peter, who was regarded as a dangerous rival in the Baltic; and Bestuzhev was summarily dismissed for protesting against the lately-formed Anglo-Swedish alliance. On the conclusion of the peace of Nystad in 1721 he was sent as ambassador to the court of Stockholm. His first official act was the signing of a defensive alliance between Russia and Sweden for twelve years, in 1724. He was successively transferred to Warsaw (1726) and to Berlin (1730), but returned to Stockholm in 1732. How far Bestuzhev was concerned in the murder (June 28th, 1739) of the Swedish diplomatic agent Sinclair in Silesia on his journey home from Constantinople, it is difficult to say. It is certain that Bestuzhev sent information to his court of Sinclair's mission, which was supposed to be hostile to Russia, and even supplied the portrait of the envoy for recognition. The Swedish authorities are unanimous in describing Bestuzhev as the arch-plotter in this miserable affair; yet, while the active agents were banished to Siberia, Bestuzhev was not even censured. The Sinclair murder led ultimately to the Swedish-Russian War of 1741, when Bestuzhev was transferred first to Hamburg and subsequently to Hanover, where he endeavoured to conclude an alliance between Great Britain and Russia. On his return to Russia in 1743, he was made grand marshal, and married Anna, the widow of Paul Yaguzhinsky, Peter the Great's famous pupil. A few months later his wife was implicated in a bogus conspiracy got up by the French ambassador, the marquis de La Châtardie, to ruin the Bestuzhevs (see BESTUZHEV-RYUMIN, ALEXIUS), and after a public whipping, had her tongue cut out and was banished to Siberia. Thither Bestuzhev had not the manhood to follow her, but went abroad, and subsequently resumed his diplomatic career. His last and most brilliant mission was to Versailles, shortly after the conclusion of the coalition against Frederick the Great, where he cut a great figure. He died at Paris on the 26th of February 1760.

See Robert Nisbet Bain, *The Daughter of Peter the Great* (London, 1899); Mikhail Sergievich, *History of Russia* (Rus.), vols. xv-xxii. (2nd ed., St Petersburg, 1897). (R. N. B.)

BET and **BETTING** (probably from O. Fr. *abeter*, to instigate, Eng. "abet," i.e. with money). To "bet" is to stake money or something valuable on some future contingency. Betting in some form or other has been in vogue from the earliest days,

commencing in the East with royal and noble gamblers, and gradually extending itself westwards and throughout all classes. In all countries where the English tongue is spoken betting is now largely indulged in; and in the United Kingdom it spread to such an extent amongst all grades of society, during the 19th century, that the interference of the legislature was necessary (see GAMING AND WAGERING). Bets can, of course, be made on any subject, and are a common method of backing one's opinion or skill, whether at games of cards or in any other connexion; but the commonest form of betting is associated with the turf. In the early days of horse-racing persons who wished to bet often failed to gratify their inclination because of the difficulty of finding any one ready to wager. To obviate this difficulty the professional bookmaker arose. It was perceived that if a man laid money against a number of horses, conducting his business on discreet principles, he would in all probability receive enough to pay the bettor who was successful and to leave a surplus for himself; for the "bookmaker," as the professional betting man came to be called, had enormous advantages in his favour. He was presumably shrewd and wary, whereas many of those with whom he dealt were precisely the opposite, and benefit arose to him from the mistakes and miscalculations of owners and trainers of horses, and from the innumerable accidents which occur to prevent anticipated success; moreover, if he carried out the theory of his calling he would so arrange his book, by what is called "betting to figures," that the money he received would be more than he could possibly be called upon to pay. In practice, of course, this often does not happen, because "backers" will sometimes support two or three horses in a race only, and the success of one may result in loss to the bookmaker; but in the long run it has been almost invariably found that the bookmaker grows rich and that the backer of horses loses money. It is the bookmaker who regulates the odds, and this he does, sometimes by anticipating, sometimes by noting, the desire of backers to support certain animals. Such things as stable secrets can scarcely be said to exist at the present time; the bookmaker is usually as well able as any one else to estimate the chances of the various horses engaged in races. Notwithstanding that the reports of a trial gallop are of comparatively little value to any except the few persons who know what weights the animals carried when tried, the bookmaker is extraordinarily keen, and frequently successful, in his search for information; and on this the odds depend.

Betting in connexion with horse-racing is of two kinds: "post," when wagering does not begin until the numbers of the runners are hoisted on the board; and "ante-post," when wagering opens weeks or months before the event; though of this latter there is far less than was formerly the case, doubtless for the reason that before the introduction of so many new and valuable stakes attention was generally concentrated on a comparatively small number of races. Bets on the Derby, the Oaks and the St Leger were formerly common nearly a year before the running of the races, and a few handicaps, such as the Chester Cup, used to occupy attention months beforehand; the weights, of course, being published at a much longer interval prior to the contest than is at present the rule. As regards ante-post betting, bookmakers have their own ideas as to the relative prospects of the horses entered. A person who wishes to back a horse asks the price, and accepts or declines, as the case may be. If the bet is laid it will probably be quoted in the newspapers, and other persons who propose to wager on the race are so likely to follow suit that it is shrewdly suspected that in not a few cases bets are quoted which never have been laid, in order to induce the backers to speculate. According to the public demand for a horse the price shortens. If there is little or no demand the odds increase, the market being almost entirely regulated by the money; so that if a great many people bet on a certain animal the odds become shorter and shorter, till in many cases instead of laying odds against a horse, the bookmaker comes to take odds, that is, to agree to pay a smaller sum than he would receive from the backer if the animal lost. Post betting is conducted on very much the same principles. When the numbers are

hoisted bookmakers proclaim their readiness to lay or take certain odds, which vary according to the demand for the different animals. Backers are influenced by many considerations: by gossip, by the opinions of writers on racing, and in many cases, unfortunately, by the advice of "tipsters," who by advertisements and circulars profess their ability to indicate winners, a pretence which is obviously absurd, as if these men possessed the knowledge they claim, they would assuredly keep it to themselves and utilize it for their own private purposes.

The specious promises of such men do infinite mischief, as they so often appeal with success to the folly and gullibility of the ignorant, and in recent years the extent to which betting has grown has resulted in attempts to check it by organized means. A society for the purpose was formed in England called the Anti-Gambling League. A bookmaker named Dunn was summoned in 1897 for betting in Tattersall's enclosure, which it was contended contravened the Betting House Act of 1853. This act had been aimed against what were known as "list houses," establishments then kept by bookmakers for betting purposes, and associated with many disgraceful scandals. In the preamble to his bill Lord Cockburn began by remarking that "Whereas a new form of betting has of late sprung up," and the Anti-Gambling League sought to argue that this included a form of betting which had not sprung up of late but had on the contrary been carried on without interference for many generations. The divisional court of the queen's bench (*Hawke v. Dunn*, 13 T.L.R. 281) held that such betting was an infringement of the act, and that the enclosure was a "place" within the meaning of the act, and had been used by the respondent for the purpose of betting with persons resorting thereto, and that he was liable to be convicted. The case was remitted to the justices, who convicted the defendant. A somewhat similar case was decided on the same day (*M'Inany v. Hildreth*, 1897, 13 T.L.R. 285), in which it was held that a professional bookmaker who went to a place known as the "pit heap" at Jarrow, to which the public had access at all times, and made bets with persons assembled there, was properly convicted, and that the "pit heap" itself and the place where he stood were "places" within the meaning of the act. It was afterwards held by the court of appeal (*Powell v. Kempton Park Racecourse Co., Ltd.*, 1897, 2 Q.B. 242), in an action brought to restrain a racecourse company from opening or keeping an enclosure on a racecourse by allowing it to be used by bookmakers, that the words "other place" must be construed as meaning a defined place, that the user of such a place implied some exclusive right in the user against others, and that the racecourse owners had not been guilty of permitting the enclosure to be used in the manner prohibited by the act of 1853. The decision in *Hawke v. Dunn* was disapproved of; and the House of Lords afterwards affirmed the decision of the court of appeal.

The Street Betting Act 1906 enacted that any person frequenting or loitering in streets or public places for the purpose of bookmaking, or betting, or wagering, should be liable on summary conviction, in the case of a first offence, to a fine not exceeding ten pounds, in the case of a second offence, to a fine not exceeding twenty pounds, and in the case of a third or subsequent offence, or in any case where he is proved to have committed the offence of having a betting transaction with a person under the age of sixteen years, to a fine, on conviction on indictment, not exceeding fifty pounds or to imprisonment with or without hard labour for a term not exceeding six months. On summary conviction the fine is a sum not exceeding thirty pounds or imprisonment with or without hard labour for a term not exceeding three months. A wide definition is given to the words "street" and "public place," and racecourses are expressly exempted from the operation of the act.

On all French racecourses (since 1866), as on others nearly everywhere else on the continent, and likewise in the British colonies, a system of betting known as the *Pari-Mutuel* or Totalizator, is carried on. Rows of offices are established behind or near the stands, on each of which lists are exhibited containing the numbers of the horses that are to run in the

coming race. At some of these the minimum wager is five francs, at others ten, twenty, fifty, one hundred, five hundred and in some cases a thousand. The person who proposes to bet goes to the clerk at one of these offices, mentions the number, as indicated on the card, of the horse he wishes to back, and states whether he desires to bet on it to win or for a place only. He receives a voucher for his money. After the race the whole amount collected at the various offices is put together and divided after a percentage has been deducted for the administration and for the poor. As soon as this has been done, the money is divided and the prices to be paid to winners are exhibited on boards. These prices are calculated on a unit of ten francs. Thus, for instance, if the winner is notified as bringing in twenty-five francs, the meaning is that the backer receives his original stake of ten and fifteen in addition, the money being paid immediately by another clerk attached to the office at which the bet was made. The great French municipalities derive considerable revenue in relief of rates from the *Paris Mutuels*. In Japan this system was made illegal in 1908.

BETAÏNE (OXYNEURINE, LYCINE), $C_4H_{13}NO_3$, a substance discovered in the sugar beet (*Beta vulgaris*) in 1866 by C. Scheibler (*Ber.*, 1869, 2, p. 292). It is also found in cotton seed, in the vetch and in wheat sprouts (E. Schulz and S. Frankurt, *Ber.*, 1893, 26, p. 2151). It may be synthetically prepared by oxidizing choline with chromic acid (O. Liebreich, *Ber.*, 1869, 2, 13), $(CH_3)_2N(OH) \cdot CH_2 \cdot CH_2OH \rightarrow C_4H_{13}NO_3 + H_2O$; by heating trimethylamine with monoacetic acid (Liebreich), $(CH_3)_3N + CH_3COOH = (CH_3)_3N(Cl) \cdot CH_2 \cdot COOH$ (betaine hydrochloride); and by heating amino-acetic acid (glycocol) with methyl iodide in the presence of an alkali (P. Griess, *Ber.*, 1875, 8, p. 1406). It crystallizes from alcohol in large deliquescent crystals; and is readily soluble in water, but insoluble in ether. It is a weak base. As is shown by the various syntheses of the base, it is the methyl hydroxide of dimethyl glycocoll. This free base readily loses water on heating and gives an internal anhydride of constitution $(CH_3)_2N \langle \begin{smallmatrix} \text{O} \\ \text{C} \end{smallmatrix} \rangle CO$, which is the type of the so-called "betaïnes." These organic betaïnes are internal anhydrides of carboxylic acids, which contain an ammonium hydroxide group in the α -position. A. Hantzsch (*Ber.*, 1886, 19, p. 31) prepared the betaïnes of nicotinic, picolinic and collidine carboxylic acids from the potassium salts of the acids, by treatment with methyl iodide, followed by moist silver oxide. The reaction may be shown as follows:—

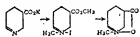

The methyl betaïne of nicotinic acid is identical with the alkaloid *trigonelline*, which was discovered in 1885 by E. Jahns in the seeds of *Trigonella faenum-graecum* (*Ber.*, 1885, 18, p. 2518). It has also been obtained from nicotine by A. Pictet by oxidizing the methyl hydroxide of nicotine with potassium permanganate (*Ber.*, 1897, 30, p. 2117).

Substances closely related to betaïne are choline, neurine and muscarine. Choline (bilineurine, sincaline), $(C_5H_{12}NO_2)$, $C_4H_9NO_2$ or $HO \cdot CH_2 \cdot CH_2 \cdot N(CH_3)_2 \cdot OH$, first isolated by A. Strecker in 1862 (*Ann.* 123, p. 353; 148, p. 76), is found in the bile, in brain substance, and in yolk of egg in the form of lecithin, a complex ester of glycerin with phosphoric acid and the fatty acids. It is also found in combination with sinapic acid in sinapin, the glucoside obtained from white mustard, and can be obtained from this glucoside by hydrolysis with baryta water,

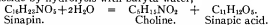

Sinapin. Choline. Sinapic acid.

It can be synthetically prepared by the action of trimethylamine on an aqueous solution of ethylene oxide (A. Wurtz, *Ann. Suppl.*, 1868, 6, p. 201). If forms deliquescent crystals of strongly alkaline reaction, and absorbs carbon dioxide from the air. It is not poisonous. By continued boiling of its aqueous solution, it is resolved into glycol and trimethylamine.

Neurine, trimethyl vinyl ammonium hydroxide (*C. vebrov*, nerve), $CH_2 \cdot CH \cdot N(CH_3)_2 \cdot OH$, is a product of the putrefaction of albumen. It may be prepared by the action of moist silver oxide on ethylene dichloride and trimethylamine,



It is a crystalline solid, very soluble in water, and is strongly basic and very poisonous. Muscarine, $C_8H_{11}NO_2$, is an exceedingly poisonous substance found in many fungi. It may be obtained synthetically by oxidizing choline with dilute nitric acid (O. Schmiedeberg, *Jahresb.*, 1876, p. 804). The exact constitution has not yet been definitely determined.

BETEL NUT. The name betel is applied to two different plants, which in the East are very closely associated in the purposes to which they are applied. The betel nut is the fruit of the Areca or betel palm, *Areca Catechu*, and the betel leaf is the produce of the betel vine or pan, *Chavica Betel*, a plant allied to that which yields black pepper. The Areca palm is a native of the Malay Peninsula and Islands and is extensively cultivated over a wide area in the East, including southern India, Ceylon, Siam, the Malay Archipelago and the Philippine Islands. It is a graceful tree with a straight, slender, unbranched stem reaching 40 or 50 ft. in height and about $1\frac{1}{2}$ ft. in circumference, and bearing a crown of 6-9 very large spreading pinnate fronds. The fruit is about the size of a small hen's egg, and within its fibrous rind is the seed or so-called nut, the albumen of which is very hard and has a prettily mottled grey and brown appearance. The chief purpose for which betel nuts are cultivated and collected is for use as a masticatory,—their use in this form being so widespread among Oriental nations that it is estimated that one-tenth of the whole human family indulge in betel chewing. For this use the fruits are annually gathered between the months of August and November, before they are quite ripe, and deprived of their husks. They are prepared by boiling in water, cutting up into slices, and drying in the sun, by which treatment the slices assume a dark brown or black colour. When chewed a small piece is wrapped up in a leaf of the betel vine or pan, with a pellet of shell lime or chunam; and in some cases a little cardamom, turmeric or other aromatic is added. The mastication causes a copious flow of saliva of a brick-red colour, which dyes the mouth, lips and gums. The habit blackens the teeth, but it is asserted by those addicted to it that it strengthens the gums, sweetens the breath and stimulates the digestive organs. Among the Orientals betel is offered on ceremonial visits in the same manner as wine is produced on similar occasions by Europeans. Betel nuts are further used as a source of catechu, which is procured by boiling the nuts in water. The water of the first boiling becomes red and thick, and when this is inspissated after the removal of the nuts it forms a catechu of high astringency and dark colour called in Bombay "Kossa." The nuts are again boiled, and the inspissated juice of the second decoction yields a weaker catechu of a brown or reddish colour. Betel nuts have been used by turners for ornamental purposes, and for coat buttons on account of the beauty of their structure. At one time they were supposed to be useful as a vermifuge. The nuts of other species of *Areca* are used by the poorer classes in the East as substitutes for the genuine betel nut.

The alkaloid arecaidine, $C_8H_{11}NO_2$, occurs in areca or betel nuts, together with three other alkaloids: arecoline, $C_8H_{11}NO_2$, guvaine, $C_8H_{11}NO_2$, and arecaine, $C_8H_{11}NO_2$. Arecaidine forms white crystals easily soluble in water, and difficultly soluble in alcohol. Chemically it is methyl-tetrahydro-nicotinic acid. Dehydration results in the formation of a "betaine," which is a tetrahydro-trigoneine (see BETAINE). Arecoline is an oil, and the physiological action of the betel nut is alone due to this substance. Chemically it is the methyl ester of arecaidine. Guvaine, named from "guvaca," an Indian designation of the betel palm, forms white crystals. It is a secondary base, but its constitution is uncertain. Arecaine is *n*-methyl-guvaine.

BETHANY (mod. *el-'Azariyeh*), a village nearly 2 m. E.S.E. from Jerusalem, on the eastern slope of the Mount of Olives, 2208 ft. above the sea. It is interesting as the residence of Lazarus and his sisters, and a favourite retreat of Jesus (see especially John xi., which describes the miracle of the resurrection of Lazarus at this place). From the 4th century down to the time of the Mahomedan invasion several ecclesiastical buildings were erected on the spot, but of these no distinct traces remain. *El-'Azariyeh* is a poor village of about thirty families, with few marks of antiquity; there is no reason to believe that the houses of Mary and Martha and of Simon the Leper, or the sepulchre of Lazarus, still shown by the monks, have any claim to the

names they bear. Another Bethany (with the alternative reading Bethabara) is mentioned in John i. 28, as "beyond Jordan"; it has not been identified.

BETHEL (Heb. "House of God"), originally called *Luz*, an ancient city of Palestine, on the N.W. border of the tribe of Benjamin, 11 m. N. of Jerusalem and nearly 2900 ft. above sea-level. From very early times it was a holy place, a circumstance probably due primarily to a very extraordinary group of boulders and rock-outcrops north of the town. Abraham recognized its sanctity (Gen. xii. 8); Jacob, in ignorance, slept in the sacred enclosure and was granted a vision ("Jacob's ladder," Gen. xxviii.). For a while the ark seems to have been deposited here (Judg. xx. 27), and it was a place for consulting the oracle (Judg. xx. 18). At the secession of the northern kingdom under Jeroboam, Bethel became a royal residence and a national shrine (1 Kings xii. 29-31, Amos vii. 13), for which its position at the junction of main roads from N. to S. and E. to W. well fitted it. It was taken from Jeroboam by Abijah, king of Judah (2 Chr. xiii. 10). It seems to have continued to flourish down into the Christian era; remains of its ecclesiastical buildings still exist. The present village, which bears the name of Beitin, occupies about three or four acres, and has a population of 2000.

BÉTHENCOURT, JEAN DE (c. 1360-1422), French explorer, belonged to a noble family of Normandy, and held important offices at the court of Charles VI., king of France. His spirit was fired by hearing of the deeds of explorers and adventurers, and having formed a plan to conquer the Canary Islands he raised some money by pledging his Norman estates, and sailed from La Rochelle on the 1st of May 1402 with two ships, commanded by himself and Gadifer de la Salle. He was delayed by a mutiny off the coast of Spain, but reached the island of Lanzarote in July. Unable to carry out his project of conquest, he left his men at the Canaries and went to seek help at the court of Castile. He obtained men and provisions from Henry III. king of Castile, through the good offices of his uncle, Robert de Braquemont, who had considerable influence with Henry; he also received the title of king, and did homage to Henry for his future conquests. Returning to the Canaries in 1404 he found that Gadifer de la Salle had conquered Lanzarote and Fuerteventura, and explored other islands. La Salle, unwilling to accept a position of inferiority, left the Canaries and appealed unsuccessfully for redress at the court of Castile. Béthencourt was unable to complete his work of conquest and exploration. In 1405 he visited Normandy, and returned with fresh colonists who occupied Hierro. In December 1406 he left the islands to the government of his nephew, Maciot de Béthencourt, reserving for himself the royal title and a share in any profits obtained. He returned to Normandy, where he appears to have spent the remainder of his days. He died in 1422, and was buried in the church of Grainville-la-Teinturière. Béthencourt wrote a very untrustworthy account of his "conquest of the Canary Islands," *Le Canarien, livre de la conquête et conversion ses Canaries*. This has been published with introduction and notes by G. Gravier (Rouen, 1874), and an English translation was edited by R. H. Major for the Hakluyt Society (London, 1872).

See also CANARY ISLANDS, for the controversy as to the relations between Béthencourt and La Salle.

BETHESDA (i.e. "House of Mercy," John v. 2), better perhaps *BETHZATHA* or *BETHSAIDA*, a pool or public bath in Jerusalem, where miraculous cures were believed to be performed. The following identifications have been suggested: *Birket Isra'îl*, near St Stephen's gate; a large cistern, near St Anne's church; the "Twin Pools," north of the Haram (the ancient Temple area); the *Hasmmam esh-Shifa'*, or pool of healing, west of the Haram; the Virgin's fountain, south of the Haram; and the "Pool of Siloam." Which, if any, of these identifications is correct, it is impossible to say.

BETHESDA, an urban district of Carnarvonshire, N. Wales, 5 m. from Bangor, by a branch of the London & North-Western railway. Pop. (1901) 5281. It lies near the lower end of the

fine Nant Ffrancon (valley of the Ogwen stream). The scriptural name is due, as often in Wales, to the village or hamlet taking its title from the Nonconformist church. Here are extensive slate quarries belonging to Lord Penrhyn. A narrow-gauge railway connects these with Port Penrhyn, at the mouth of the stream Cegid (hemlock, "cicutia"), which admits the entry of vessels of 300 tons to the quay at low water.

BETH-HORON ("the place of the hollow way"), the name of two neighbouring villages, upper and lower Beth-horon, on the ascent from the coast plain of Palestine to the high tableland of Benjamin, which was until the 16th century the high road from Jerusalem to the sea. The two towns thus played a conspicuous part in Israelitish military history (see Josh. x. 10; 1 Sam. xiii. 18; 1 Kings ix. 17; 1 Macc. iii. 13-24, vii. 39 ff., ix. 50). Josephus (*Bell. Jud.* ii. 19) tells of the rout of a Roman army under Cestius Gallus in A.D. 66. The Talmud states that many rabbis were born in the place. It is now represented by Beit 'Ur-el-foka and Beit 'Ur-et-tahta.

BETHLEHEM (Heb. "House of Bread," or, according to a more questionable etymology, "of [the god] Lakhmu"), a small town in Palestine, situated on a limestone ridge (2550 ft. above sea-level), 5 m. S. of Jerusalem. The neighbourhood produces wheat, barley, olives and vines in abundance. It was occupied in very early times, though the references in Judges xvii., xix., and Ruth¹ are of doubtful date. It was the early home of David and of Joab (2 Sam. ii. 32). It was fortified by Rehoboam, and in the neighbouring inn of Chimham the murderers of Gedaliah took refuge (Jer. xli. 17). Micah (v. 2) and other writers speak of it as Bethlehem-Ephrathah; perhaps Ephrathah was the name of the district. Almost complete obscurity, however, was gathering round it when it became (according to Matt. ii. and Luke ii.) the birthplace of Jesus. The traditional scene of the Nativity, a grotto on the eastern part of the ridge, is alleged to have been desecrated during the reign of Hadrian by a temple of Adonis. In 330 it was enclosed by a basilica built by the orders of the emperor Constantine. This basilica (S. Maria a Praesepio), which is still standing, was restored and added to by Justinian, and was later surrounded by the three convents successively erected by the Greek, Latin and Armenian Churches (see de Vogüé, *Les Églises de la Terre Sainte*). Captured by the Crusaders in the 11th century, Bethlehem was made an episcopal see; but the bishopric soon sank to a titular dignity. Beside the grotto of the Nativity other traditional sites are shown within the church, such as the Altar of the Magi, the Tomb of Eusebius, the cave wherein Jerome made his translation of the Bible, &c.

There are several monasteries and convents, and British, French and German schools. The village is well built and comparatively clean. The population (8000) has contained few Moslems since the Moslem quarter was destroyed by Ibrahim Pasha, in revenge for the murder of one of his favourites, after the insurrection of 1834. The carving of crucifixes and other sacred mementoes gives employment to a large proportion of the population. In 1850 a dispute arose between France and Russia, in the name of the Latin and Greek Churches respectively, concerning the possession of the key of the chief door of the basilica, and concerning the right to place a silver star, with the arms of France, in the grotto of the Nativity. The Porte, after much futile temporizing, yielded to France. The disappointment thus inflicted on Russia was a determining cause of the outbreak of the Crimean War (see Kinglake, *Invasion of the Crimea*, chap. iii.). [There is a tiny village of the same name in Zebulun, 7 m. N.W. of Nazareth (Josh. xv. 19).]

See bibliography under PALESTINE. For the modern town see Palmer, "Das jetzige Bethlehem," in the *Zeitschrift der Deutsche Palästina-Verein*, xvii. p. 89. (R. A. S. M.)

BETHLEHEM, a borough of Northampton and Lehigh counties, Pennsylvania, U.S.A., on the N. bank of the Lehigh river, opposite South Bethlehem and 55 m. N. of Philadelphia. Pop. (1890) 6762; (1900) 7203 (350 foreign-born); (1910) 12,837. It is served by the Central of New Jersey, the Lehigh & New England, the Lehigh Valley and the Phila-

delphia & Reading railways, and is connected by two long bridges with South Bethlehem. The borough lies on a ridge of ground commanding delightful landscape scenery extending north up the course of the river to the Blue Mountains 20 m. away. In Church Street and its vicinity still stand several specimens of the 17th-century style of architecture of eastern Germany. The same sect that erected these buildings, the Moravians, or United Brethren, maintain here the Moravian College and Theological Seminary, and a well-known school for girls (the Moravian Seminary), founded as a church boarding school in 1749 and reorganized in 1785, for girls of all denominations. During the War of Independence, from December 1776 to April 1777, and from September 1777 to April 1778, the old Colonial Hall in this seminary (built 1748) was used as a general hospital of the continental army. From its roof the famous Moravian trombones were long played on festal or funeral occasions, and later summoned the people to musical festivals. The Moravians have given Bethlehem a national reputation as a musical centre. Only a few years after the city was founded, Benjamin Franklin was strongly impressed with the fine music in its church, and towards the close of the 19th century a choir under the direction of the organist, J. Frederick Wolle, became widely known by rendering for the first time in America Bach's *St John Passion* (in 1888), followed after short intervals by the *St Matthew Passion*, the *Christmas Oratorio*, the *Mass in B Minor*, and finally by an annual Bach festival continuing for three days, which was discontinued after Wolle's removal to the university of California in 1905. Bethlehem has often been called the American Bayreuth. Among the borough's industrial establishments, the manufactories of iron and steel are the most important, but it also manufactures brass, zinc, and silk and knit goods. The municipality owns and operates its waterworks. Bethlehem was founded by the Moravians, led by Count Nikolaus Ludwig Zinzendorf, shortly before Christmas in 1741, and the season of the year suggested its name; for the first century of its existence it was almost exclusively a settlement of that sect, and it is still their American headquarters. Bethlehem was incorporated as a borough in 1845. In 1904 the borough of West Bethlehem (pop. in 1900, 3465) was consolidated with Bethlehem.

See J. M. Levering, *A History of Bethlehem, Pennsylvania* (Bethlehem, 1903).

BETHLEHEMITES, a name borne at different times by three orders in the Roman Catholic Church. (1) A community of friars at Cambridge, in 1257, whose habit was distinguished from that of the ordinary Dominicans by a five-rayed red star (in reference to Matt. ii. 9 f). (2) An order of knighthood similar to the Knights of St John, established by Pius II. in 1459 to resist the inroads of the Turks. (3) The Bethlehemite Order of Guatemala, a nursing community founded in 1650 by Pedro Betancourt (d. 1667), extended by the brothers Rodrigo and Antonio of the Cross, and raised to an order by Innocent XI. in 1687. They wore a dress like that of the Capuchins, and Clement XI. in 1707 gave them the privileges of the mendicant orders. They spread throughout Central America and Mexico and as far south as Lima, and with the order of sisters, founded in 1668 by Anna Maria del Galdo, were conspicuous for their devotion during times of plague and other contagious diseases. This order became extinct about 1850. The name Bethlehemites has also sometimes been given to the Hussites of Bohemia because their leader preached in the Bethlehem church at Prague.

BETHLEN, GABRIEL (GÁBOR) (1580-1629), prince of Transylvania, the most famous representative of the Iktári branch of a very ancient Hungarian family, was born at Ilyé, and educated at Szarhegy, at the castle of his uncle András Lázár. Thence he was sent to the court of Prince Zsigmond Báthory, whom he accompanied on his famous Wallachian campaign in 1600. Subsequently he assisted Stephen Bocskay to mount the throne of Transylvania (1605), and remained his chief counsellor. Bethlen also supported Bocskay's successor Gabriel Báthory (1608-1613), but the prince became jealous of Bethlen's superior abilities, and he was obliged to take refuge with the Turks.

¹The country of Moab is clearly visible from around Bethlehem.

In 1613 he led a large army against his persecutor, on whose murder by two of his officers that year Bethlen was placed on the throne by the Porte, in opposition to the wishes of the emperor, who preferred a prince who would incline more towards Vienna than towards Constantinople. On the 13th of October 1613, the diet of Klausenburg confirmed the choice of the sultan. In 1615 Gábor was also officially recognized by the emperor Matthias. Bethlen no sooner felt firmly seated on his throne than he seized the opportunity presented to him by the outbreak of the Thirty Years' War to take up arms in defence of the liberties and the constitution of the extra-Transylvanian Hungarian provinces, with the view of more effectually assuring his own position. While Ferdinand was occupied with the Bohemian rebels, Bethlen led his armies into Hungary (1619), and soon won over the whole of the northern counties, even securing Pressburg and the Holy Crown. Nevertheless he was not averse to a peace, nor to a preliminary suspension of hostilities, and negotiations were opened at Pressburg, Kassa and Besztercebánya successively, but came to nothing because Bethlen insisted on including the Bohemians in the peace, whereupon (20th of August 1620) the estates of North Hungary elected him king. Bethlen accepted the title but refused to be crowned, and war was resumed, till the defeat of the Czechs at the battle of the White Hill gave a new turn to affairs. In Bohemia, Ferdinand II. took a fearful revenge upon the vanquished; and Bethlen, regarding a continuation of the war as unprofitable, concluded the peace of Nikolsburg (31st of December 1621), renouncing the royal title on condition that Ferdinand confirmed the peace of Vienna (which had granted full liberty of worship to the Protestants) and engaged to summon a general diet within six months. For himself Bethlen secured the title of prince of the Empire, the seven counties of the Upper Theiss, and the fortresses of Tokaj, Munkács and Ecsed. Subsequently Bethlen twice (1623 and 1626) took up arms against Ferdinand as the ally of the anti-Habsburg Protestant powers. The first war was concluded by the peace of Vienna, the second by the peace of Pressburg, both confirmatory of the peace of Nikolsburg. After the second of these insurrections, Bethlen attempted a rapprochement with the court of Vienna on the basis of an alliance against the Turks and his own marriage with one of the Austrian archduchesses; but Ferdinand had no confidence in him and rejected his overtures. Bethlen was obliged to renounce his anti-Turkish projects, which he had hitherto cherished as the great aim and object of his life, and continue in the old beaten paths. Accordingly, on his return from Vienna he wedded Catherine, the daughter of the elector of Brandenburg, and still more closely allied himself with the Protestant powers, especially with Gustavus Adolphus of Sweden, who, he hoped, would assist him to obtain the Polish crown. He died before he could accomplish any of his great designs (15th of November 1629), having previously secured the election of his wife Catherine as princess. His first wife, Susannah Károlyi, died in 1622.

Gabriel Bethlen was certainly one of the most striking and original personages of his century. A zealous Calvinist, whose boast it was that he had read the Bible twenty-five times, he was nevertheless no persecutor, and even helped the Jesuit Kaldy to translate and print his version of the Scriptures. He was in communication all his life with the leading contemporary statesmen, so that his correspondence is one of the most interesting and important of historical documents. He also composed hymns.

The best editions of his correspondence are those by Sándor Szilágyi, both published at Buda (1866 and 1879). The best life of him is that by the Bohemian historian Anton Gindely, *Acta et documenta historica Gabrielis Bethleni Illustrata* (Budapest, 1890). This work has been largely utilized by Ignác Asády in his excellent *Gabriel Bethlen and his Court* (Hung., Budapest, 1890). (R. N. B.)

BETHNAL GREEN, an eastern metropolitan borough of London, England, bounded N. by Hackney, E. by Poplar, S. by Stepney and W. by Shoreditch. Pop. (1901) 129,680. It is a district of poor houses, forming part of the area commonly known as the "East End." The working population is employed in the making of match-boxes, boot-making, cabinet-making

and other industries; but was formerly largely devoted to silk-weaving, which spread over the district from its centre in Spitalfields (see STEFNEY). This industry is still maintained. The Bethnal Green museum was opened in 1872. It contains exhibits of food and animal products, formerly at South Kensington, entomological collections, &c.; and various loan exhibitions are held from time to time. The Museum also housed the Wallace collection until the opening of Hertford House, and the pictures now in the National Portrait Gallery. It stands in public gardens; there are several other small open spaces; and some 70 out of the 217 acres of Victoria Park are within the borough. Close by the park there stood, until the 19th century, a house believed to have belonged to the notorious Bishop Bonner, the persecutor of Protestants in the reign of Mary; his name is still attached to a street here. Among institutions are the missionary settlement of the Oxford House, founded in 1884, with its women's branch, St Margaret's House; the North-Eastern hospital for children, the Craft school and the Leather Trade school. The parliamentary borough of Bethnal Green has two divisions, each returning one member. The borough council consists of a mayor, 5 aldermen and 30 councillors. Area, 750.3 acres.

BÉTHUNE (FAMILY). The *seigneurs* of Béthune, *avoués* (*advocati*) of the great abbey of Saint-Vaast at Arras from the 11th century, were the ancestors of a great French house whence sprang the dukes of Sully, Charost, Orval, and Ancenis; the marquises of Rosny, Courville and Chabris; the counts of Selles and the princes of Boisbelle and Henrichemont. Conon de Béthune (*q.v.*), the crusader and poet, was an early forebear. The most illustrious member of the Béthune family was Maximilien, baron of Rosny, and afterwards duke of Sully (*q.v.*), minister of Henry IV. His brother Philip, count of Selles and of Charost, was ambassador to Scotland, Rome, Savoy and Germany, and died in 1649. Hippolyte de Béthune, count of Selles and marquis of Chabris, who died in 1665, bequeathed to the king a magnificent collection of historical documents and works of art. The Charost branch of the family gave France a number of generals during the 17th and 18th centuries.

The last duke of Charost, Armand Joseph de Béthune (1738-1800), French economist and philanthropist, served in the army during the Seven Years' War, after which he retired to his estates in Berry, where, and also in Brittany and Picardy, he sought to ameliorate the lot of his peasants by abolishing feudal dues, and introducing reforms in agriculture. During the Terror he was arrested, but was liberated after the 9th Thermidor. He was mayor of the 10th arrondissement of Paris under the Consulate, and died at Paris on the 27th of October 1800, of small-pox, contracted during a visit to a workshop for the blind which he had founded. He published essays on the way to destroy mendicancy and to improve the condition of the labourers, and also on the establishment of a fund for rural relief and the organization of rural education. His life throws light on some phases of the *ancien régime* which are often overlooked by historians. Louis XV. said of Charost, "Look at this man, his appearance is insignificant, but he has put new life into three of my provinces." His only son, Armand Louis de Béthune, marquis de Charost, was beheaded on the 28th of April 1794.

BÉTHUNE, CONON or **QUESNES, DE** (c. 1150-1224), French *trouvère* of Arras, was born about the middle of the 12th century. He came about 1180 to the court of France, where he met Marie de France, countess of Champagne. To this princess his love poems are dedicated, and much of his time was passed at her court where the *trouvères* were held in high honour. At the French court he met with some criticisms from Queen Alix, the widow of Louis VII., on the roughness of his verse and on his Picard dialect. To these criticisms, interesting as proof of the already preponderant influence of the dialect of the Île de France, the poet replied by some verses in the satirical vein that best suited his temperament. Some of his best songs were inspired by anger at the delays before the crusade of 1188-1102. His plain-speaking made him many enemies, and when he returned

with the rest after the fruitless capture of Acre, these were not slow to take advantage of the opportunity for retaliation. Conon took part with Baldwin of Flanders in the crusade which resulted in 1204 in the capture of Constantinople, and he is said to have been the first to plant the crusaders' standard on the walls of the city. He held high office in the new empire and died about 1224. His verses, of which the crusading song *Ah! amors com dure departie* is well known, are marked by a vigour and martial spirit which distinguish them from the work of other troubères.

The completest edition of his works is in the *Trouvères belges* of Aug. Scheler (1876).

BÉTHUNE, a town of northern France, capital of an arrondissement in the department of Pas-de-Calais, 24 m. N.N.W. of Arras, on the Northern railway between that town and St Omer. Pop. (1906) 12,601. Béthune is situated on a low hill at the confluence of the Lawe with the canal from Aire to Bauvin. Once strongly fortified, it is now surrounded by wide boulevards, and new quarters have grown up on its outskirts. The old town is composed of winding streets and *culs-de-sac* bordered by old houses in the Flemish style. In the central square stands one of the finest bellfries of northern France, a square structure surmounted by a wooden campanile, dating from the 14th century. St Vaast, the principal church of Béthune, belongs to the 16th century. The town is the seat of a sub-prefect, and has a tribunal of first instance, a chamber of commerce and a communal college among its public institutions. Béthune lies in the midst of the richest coal mines in France. Its industries include the distillation of oil, tanning, salt-refining, brewing, and the manufacture of earthenware and casks. Trade is carried on in flax, cloth, cereals, oil-seeds, &c.

The town, which dates from the 11th century, was governed by its own lords till 1248, after which date it passed through the ownership of the counts of Flanders, the dukes of Burgundy, and the sovereigns of Austria and Spain. Ceded to France by the peace of Nijmegen (1678), it was taken by the allied forces in 1710, and restored to France by the treaty of Utrecht.

BETROTHAL (A.S. *treowth*, "truth"), the giving "one's truth," or pledging one's faith to marry. Although left optional by the church and not necessary in law, betrothal was anciently a formal ceremony which in most cases preceded the actual marriage service, usually by a period of some weeks, but the marriage might for various reasons be delayed for years. The canon law distinguished two types of betrothal:—(1) *Sponsalia de praesenti*, (2) *Sponsalia de futuro*. The first was a true though irregular marriage, and was abolished by the council of Trent as leading to clandestine unions and therefore being inimical to morality. The second, or betrothal properly so called, was a promise to marry at a future date, which promise without further ceremony became a valid marriage upon consummation. The church never precisely determined the form of the ceremony, but demanded for its validity that it should have been entered into freely and at a legal age, i.e. after the seventh birthday. The church further declared that females between the ages of seven and twelve, and males between seven and fourteen, could be betrothed, but not married, and that all such betrothals were to be public. The ill-defined laws as to betrothals tended to encourage abuses; and the people, especially in the rural districts, inclined to hold betrothal sufficient justification for cohabitation. Such pre-contract is known to have existed in the case of Shakespeare (*q.v.*). Francis Douce (*Illustrations of Shakespeare and of Ancient Manners*, 1807) says that betrothal consisted of the "interchange of rings—the kiss—the joining of hands, to which is to be added the testimony of witnesses." In France the presence of a priest seems to have been considered essential, and though this was not so elsewhere it was customary for the couple to get their parish priest to witness their promise. In England solemn betrothal was almost universally practised. Among the peasantry the place of rings was taken by a coin which was broken between the pair, each taking a part. But almost any gift sufficed. A case in 1582

is recorded where the lover gave the girl a pair of gloves, two oranges, two handkerchiefs and a red silk girdle. Sometimes the bride-elect received a bent or crooked sixpence. At the conclusion of the ceremony, which by no means always took place in a church, it seems to have been usual for the couple to pledge each other in a cup of wine, as do the Jews and Russians to-day. This drinking together was ever the universal custom of parties in ratification of a bargain. Joseph Strutt (1749–1802) states that by the civil law gifts given at betrothal could be recovered by the parties, if the marriage did not take place. But only conditionally, for if the man "had had a kiss for his money, he should lose one half of that which he gave. Yet with the woman it is otherwise, for, kissing or not kissing, whatever she gave, she may ask and have it again. However, this extends only to gloves, rings, bracelets and such-like small wares." Though the church abstained from prescribing the form of the ceremony, it jealously watched over the fulfilment of such contracts and punished their violation. Betrothal, validly contracted, could be dissolved either by mutual consent, or by the supervening of some radical physical or social change in the parties, or by the omission to fulfil one of the conditions of the contract. But here the church stepped in, and endeavoured to override such law as existed in the matter by decreeing that whoever, after betrothal, refused to marry *in facie ecclesiae*, was liable to excommunication till relieved by public penance. In England the law was settled by an act of 1753, which enacted that an aggrieved party could obtain redress only by an action at common law for breach of promise of marriage (see MARRIAGE).

Formal betrothal is no longer customary in England, but on the European continent it retains much of its former importance. There it is either solemn (publicly in church) or private (simply before witnesses). Such betrothals are legal contracts. They are only valid between persons of legal age, both of whom consent; and they are rendered void by fraud, intimidation and duress. In Germany if the parties are under age the consent of the parents is needed; but if this is unreasonably withheld the couple may appeal to a magistrate, who can sanction the betrothal. If the parents disagree, the father's wish prevails. Public betrothal carries with it an obligation to marry, and in case of refusal an action "lies" for the injured party. In Germany the betrothal is generally celebrated before the relatives, and the couple are called bride and bridegroom from that day until marriage. In Russia, where it was once as binding as marriage, it is now a mere formal part of the marriage ceremony.

Among the ancient Jews betrothal was formal and as binding as marriage. After the ceremony, which consisted of the handing of a ring or some object of value to the bride and formal words of contract, and the mutual pledging of the couple in consecrated wine, a period of twelve months elapsed before the marriage was completed by the formal home-taking; unless the bride was a widow or the groom a widower, when this interval was reduced to thirty days. Latterly the ceremony of betrothal has become a part of the marriage ceremony, and the engagement has become the informal affair it is in England.

For betrothal customs in China, the East and elsewhere, consult L. J. Miln, *Wooings and Weddings in Many Climes* (London, 1900), and H. N. Hutchinson, *Marriage Customs in Many Lands* (London, 1897). On early English law as to betrothals see Sir F. Pollock and Maitland, *History of English Law before the time of Edward I.* (2nd ed., 1898). See also J. O. Halliwell-Phillipps, *Outlines of the Life of Shakespeare* (London, 1848, 1883).

BETTERMENT (i.e. "making better," as opposed to "worsement"), a general term, used particularly in connexion with the increased value given to real property by causes for which a tenant or the public, but not the owner, is responsible; it is thus of the nature of "unearned increment." When, for instance, some public improvement results in raising the value of a piece of private land, and the owner is thereby "bettered" through no merit of his own, he gains by the betterment, and many economists and politicians have sought to arrange, by taxation or otherwise, that the increased value shall come into the pocket of the public rather than into his. A betterment tax would be so assessed as to divert from the owner of the property the profit

thus accruing "unearned" to him. (See also COMPENSATION.) The whole problem is one of the incidence of taxation and the question of land values, and various applications of the principle of betterment have been tried in America and in England, raising considerable controversy from time to time.

See A. A. Baumann, *Betterment, Worsenment and Recoupment* (1894).

BETTERTON, THOMAS (c. 1635-1710), English actor, son of an under-cook to King Charles I., was born in London. He was apprenticed to John Holden, Sir William Davenant's publisher, and possibly later to a bookseller named Rhodes, who had been wardrobe-keeper to the theatre in Blackfriars. The latter obtained in 1659 a licence to set up a company of players at the Cockpit in Drury Lane; and on the reopening of this theatre in 1660, Betterton made his first appearance on the stage. His talents at once brought him into prominence, and he was given leading parts. On the opening of the new theatre in Lincoln's Inn Fields in 1661, Sir William Davenant, the patentee, engaged Betterton and all Rhodes's company to play in his *Siege of Rhodes*. Betterton, besides being a public favourite, was held in high esteem by Charles II., who sent him to Paris to examine stage improvements there. According to Cibber it was after his return that shifting scenes instead of tapestry were first used in an English theatre. In 1692, in an unfortunate speculation, Betterton and his friend Sir Francis Watson were ruined; but Betterton's affection for Sir Francis was so strong that he adopted the latter's daughter and educated her for the stage. In 1693, with the aid of friends, he erected the New Playhouse in the tennis court in Lincoln's Inn Fields. It was opened in 1695 with Congreve's *Love for Love*. But in a few years the profits fell off; and Betterton, labouring under the infirmities of age and gout, determined to quit the stage. At his benefit performance, when the profits are said to have been over £500, he played Valentine in *Love for Love*. In 1710 he made his last appearance as Melantius in *The Maid's Tragedy*; he died on the 28th of April, and was buried in Westminster Abbey.

In appearance he was athletic, slightly above middle height, with a tendency to stoutness; his voice was strong rather than melodious, but in recitation it was used with the greatest dexterity. Pepps, Pope, Steele and Cibber all bestow lavish praise on his acting. His repertory included a large number of Shakespearean rôles, and although many of these were presented in the tasteless versions of Davenant, Dryden, Shadwell and Nahum Tate, yet they could not hide the great histrionic gifts which Betterton possessed, nor does his reputation rest on these performances alone. The blamelessness of his life was conspicuous in an age and a profession notorious for dissolute habits. Betterton was author of several adaptations which were popular in their day. In 1662 he had married Mary Saunderson (d. 1712), an admirable actress, whose Ophelia shared the honours with his Hamlet.

See Howe, *Thomas Betterton* (1891); *The Life and Times of Thomas Betterton* (1886).

BETTIA, a town of British India, in the Champaran district of Bengal; situated on a former branch of the Harha river, with a station on the Tirchoot section of the Bengal & North-Western railway. Bettia is the residence of one of the leading noblemen of northern Behar, who enjoys a rent-roll of £66,000. In 1901, owing to a disputed succession, the estate was under the management of the court of wards. It comprises land in no fewer than ten districts, much of which is let on permanent leases to indigo-planters. Besides the palace of the maharaja, the town contains a middle English school and a female dispensary, entirely supported out of the estate. There is a Roman Catholic mission, with about 1000 converts, which was founded by an Italian priest in 1746.

BETTINELLI, SAVERIO (1718-1808), Italian Jesuit and man of letters, was born at Mantua on the 18th of July 1718. After studying under the Jesuits in his native city and at Bologna he entered the society in 1736. He taught the belles-lettres from 1739 to 1744 at Brescia, where Cardinal Quirini, Count Mazzuchelli, Count Duranti and other scholars, formed an illus-

trious academy. He next went to Bologna, to pursue the study of divinity, and there he enjoyed the society of many learned and literary men. At the age of thirty he went to Venice, where he became professor of rhetoric, and was on friendly terms with the most illustrious persons of that city and state. The superintendence of the college of nobles at Parma was entrusted to him in 1751; and he had principal charge of the studies of poetry and history, and the entertainments of the theatre. He remained there eight years, visiting, at intervals, other cities of Italy, either on the affairs of his order, for pleasure or for health. In 1755 he traversed part of Germany, proceeded as far as Strassburg and Nancy, and returned by way of Germany into Italy, taking with him two young sons or nephews of the prince of Hohenlohe, who had requested him to take charge of their education. He made, the year following, another journey into France, along with the eldest of his pupils; and during this excursion he wrote his famous *Lettere dieci di Virgilio agli Arcadi*, which were published at Venice with his *scioliti* verses, and those of Frugoni and Algarotti. The opinions maintained in these letters against the two great Italian poets and particularly against Dante, created him many enemies, and embroiled him with Algarotti. In 1758 he went into Lorraine, to the court of King Stanislaus, who sent him on a matter of business to visit Voltaire. Voltaire presented him with a copy of his works, with a flattering inscription in allusion to Bettinelli's *Letters of Virgil*. From Geneva he returned to Parma, where he arrived in 1759. He afterwards lived for some years at Verona and Modena, and he had just been appointed professor of rhetoric there, when, in 1773, the order of Jesuits was abolished in Italy. Bettinelli then returned into his own country, and resumed his literary labours with new ardour. The siege of Mantua by the French compelled him to leave the city, and he retired to Verona, where he formed an intimate friendship with the chevalier Hippolito Pindemonti. In 1797 he returned to Mantua. Though nearly eighty years old, he resumed his labours and his customary manner of life. He undertook in 1799 a complete edition of his works, which was published at Venice in 24 vols. 12mo. Arrived at the age of ninety years, he still retained his gaiety and vivacity of mind, and died on the 13th of September 1808. The works of Bettinelli are now of little value. The only one still deserving remembrance, perhaps, is the *Risorgimento negli studj, nelle Arti e ne' Costumi dopo il Mille* (1775-1786), a sketch of the progress of literature, science, the fine arts, industry, &c., in Italy.

BETTWYS Y COED, an urban district of Carmarthenshire, North Wales, 4 m. from Llanwrst and 16 m. from Llandudno, on a branch of the London & North-Western railway. Pop. (1901) 1070. The name means "warm place of the wood," according to Llyn's definition of *betwys*. The other derivation of the word from *Abbatia (domus)* agrees with its vicinity to Ysppyty' Ifan (Euan), *Hospitium Ioannis*, near Pentre'r Eoelas. The words "y coed" are added to distinguish this Bettwys from several others in Wales, especially that near Llandelilo Fawr, Carmarthenshire, not far from the Bettwys hills. Bettwys y coed is a favourite village for artists and tourists. It is a centre for excursions towards Capel Curig and Snowdon, or towards Blaenau Ffestiniog, via Roman Bridge. There is excellent fishing for salmon and trout, and in summer coaches leave their daily loads of tourists here. The best-known streams and waterfalls are Llugwy, Lledr, with Rhaia dry wenol (Swallow falls), Conwy and Machno falls. In the neighbourhood are Dolwyddelan castle and the mill of Moel Siabod.

BETTY, WILLIAM HENRY WEST (1791-1854), English actor, known as "the young Roscius," was born on the 13th of September 1791 at Shrewsbury. He first appeared on the stage at Belfast before he was twelve years old, as Osman in Aaron Hill's *Zara*, an English version of Voltaire's *Zaïre*. His success was immediate, and he shortly afterwards appeared in Dublin, where it is said that in three hours of study he committed the

¹ Other places named "Ysppyty" are Y. Cynfyn and Y. Ystwyth. For the name Ysppyty, cf. Bale's *King John*, 2125: "So many masendecns (maisons Dieu), hospitals and spytlye howses."

part of Hamlet to memory. His precocious talents aroused great enthusiasm in Glasgow and Edinburgh, and he was favourably compared with some of the greatest tragedians. In 1804 he first appeared at Covent Garden, when the troops had to be called out to preserve order, so great was the crush to obtain admittance. At Drury Lane the house was similarly packed, and he played for the then unprecedented salary of over 75 guineas a night. He was a great success socially, George III. himself presenting him to the queen, and Pitt upon one occasion adjourning the House of Commons that members might be in time for his performance. But this enthusiasm gradually subsided, and in 1808 he made his final appearance as a boy actor, and entered Christ's College, Cambridge. He re-appeared four years later, but the public would have none of him, and he retired to the enjoyment of the large fortune which he had amassed as a prodigy. He died on the 24th of August 1874. His son Henry Betty (1810-1897) was also an actor.

BETUL, a town and district of British India, in the Nerbudda division of the Central Provinces. In 1901 the population of the town was 4739. The administrative headquarters of the district have been transferred to the town of Badnur (q.v.), 3 m. north.

The district of BETUL has an area of 3826 sq. m. In 1901 the population was 285,363, showing a decrease of 12 % in the decade, due to the results of famine. The mean elevation above the sea is about 2000 ft. The country is essentially a highland tract, divided naturally into three distinct portions, differing in their superficial aspects, the character of their soil and their geological formation. The northern part of the district forms an irregular plain of the sandstone formation. It is a well-wooded tract, in many places stretching out in charming glades like an English park, but it has a very sparse population and little cultivated land. In the extreme north a line of hills rises abruptly out of the great plain of the Nerbudda valley. The central tract alone possesses a rich soil, well watered by the Machna and Sampna rivers, almost entirely cultivated and studded with villages. To the south lies a rolling plateau of basaltic formation (with the sacred town of Multai, and the springs of the river Tapti at its highest point), extending over the whole of the southern face of the district, and finally merging into the wild and broken line of the Ghats, which lead down to the plains. This tract consists of a succession of stony ridges of trap rock, enclosing valleys or basins of fertile soil, to which cultivation is for the most part confined, except where the shallow soil on the tops of the hills has been turned to account. The principal crops are wheat, millet, and other food-grains, pulse, oil-seeds, and a little sugar-cane and cotton. A large part of the area is covered with forests, which yield teak and other timber. The only manufacture is cotton cloth. A railway is projected from Itarsi through the district to Berar. Good roads are few; and none of the rivers is navigable. This district suffered very severely from the famine of 1806-1807, in 1807 the death-rate being as high as 73 per 1000. It suffered again in 1900, when in May the number of persons relieved rose to one-third of the total population.

Little is known of the early history of the district except that it must have been the centre of the first of the four ancient Gond kingdoms of Kherla, Deogarh, Mandla and Chanda. According to Ferishta, the Persian historian, these kingdoms engrossed in 1398 all the hills of Gondwana and adjacent countries, and were of great wealth and power. About the year 1418 Sultan Husain Shah of Malwa invaded Kherla, and reduced it to a dependency. Nine years later the raja rebelled, but although with the help of the Bahmani kings of the Deccan he managed for a time to assert his independence, he was finally subdued and deprived of his territories. In 1467 Kherla was seized by the Bahmani king, but was afterwards restored to Malwa. A century later the kingdom of Malwa became incorporated into the dominions of the emperor of Delhi. In 1703 a Mussulman convert of the Gond tribe held the country, and in 1743 Raghaji Bhonsla, the Maharrata ruler of Berar, annexed it to his dominions. The Maharratas in the year 1818 ceded this district to the East India Company as payment for a contingent, and by the treaty of 1826 it was formally incorporated with the British possessions.

Detachments of British troops were stationed at Multai, Betul and Shahpur to cut off the retreat of Apa Sahib, the Maharrata general, and a military force was quartered at Betul until June 1862. The ruined city of Kherla formed the seat of government under the Gonds and preceding rulers, and hence the district was, until the time of its annexation to the British dominions, known as the "Kherla Sarkar." The town of Multai contains an artificial tank, from the centre of which the Tapti is said to take its rise: hence the reputed sanctity of the spot, and the accumulation of temples in its honour.

The climate of Betul is fairly healthy. Its height above the plains and the neighbourhood of extensive forests moderate the heat, and render the temperature pleasant throughout the greater part of the year. During the cold season the thermometer at night falls below the freezing point; little or no hot wind is felt before the end of April, and even then it ceases after sunset. The nights in the hot season are comparatively cool and pleasant. During the monsoon the climate is very damp, and at times even cold and raw, thick clouds and mist enveloping the sky for many days together. The average annual rainfall is 40 in. In the denser jungles malaria prevails for months after the cessation of the rains, but the Gonds do not appear to suffer much from its effects. Travellers and strangers who venture into these jungles run the risk of fever of a severe type at almost all seasons of the year.

BETWA, a river of India, which rises in the native state of Bhopal in Malwa, and after a course of 360 m., for the most part in a north-easterly direction, falls into the Jumna at Hamipur. A weir is thrown across the Betwa about 15 m. from Jhansi town, whence a canal 168 m. long takes off, irrigating 106,000 acres of the Jalaun district; similar works have been carried out elsewhere on the river.

BEUDANT, FRANÇOIS Sulpice (1787-1850), French mineralogist and geologist, was born at Paris on the 5th of September 1787. He was educated at the École Polytechnique and École Normale, and in 1811 was appointed professor of mathematics at the lycée of Avignon. Thence he was called, in 1813, to the lycée of Marseilles to fill the post of professor of physics. In the following year the royal mineralogical cabinet was committed to his charge to be conveyed into England, and from that time his attention was directed principally towards geology and cognate sciences. In 1817 he published a paper on the phenomena of crystallization, treating especially of the variety of forms assumed by the same mineral substance. In 1818 he undertook, at the expense of the French government, a geological journey through Hungary, and the results of his researches, *Voyage minéralogique et géologique en Hongrie*, 3 vols. 4to, with atlas, published in 1822, established for him a European reputation. In 1820 he was appointed to the professorship of mineralogy in the Paris faculty of sciences, and afterwards became inspector-general of the university. He subsequently published treatises on physics and on mineralogy and geology, and died on the 10th of December 1850.

BEUGNOT, JACQUES CLAUDE, Count (1761-1835), French politician, was born at Bar-sur-Aube. A magistrate under the old régime, he was elected deputy to the Legislative Assembly (1791), then to the Convention, He was involved in the proscription of the Girondists and imprisoned until the 9th Thermidor. He next entered into relations with the family of Bonaparte, and in 1799, after the 18th Brumaire, again entered politics, becoming successively prefect of the lower Seine, councillor of state, and finance minister to Jerome Bonaparte, king of Westphalia. In 1808 Beugnot, who had meanwhile been appointed administrator of the duchy of Berg-Cleves, received the cross of officer of the Legion of Honour with the title of count. He returned to France in 1813, after the battle of Leipzig, and was made prefect of the department of Nord. In 1814 he was a member of the provisional government as minister of the interior; and by Louis XVIII. he was named director-general of police and afterwards minister of marine. He followed Louis to Ghent during the Hundred Days, and became

one of his confidants. He contributed to draw up Louis's charter, and in his memoirs boasted of having furnished the text of the proclamation addressed by the king to the French people before his return to France; but it is known now that it was another text that was adopted. Lacking the support of the ultra-royalists, he was given the title of minister of state without portfolio, which was equivalent to a retirement. Elected deputy, he attached himself to the moderate party, and defended the liberty of the press. In 1831 Louis Philippe made him a peer of France and director-general of manufactures and commerce. He died on the 24th of June 1835.

His son, AUGUSTE ARTHUR BEUGNOT (1797-1865), was an historian and scholar, who published an *Essai sur les institutions de Saint Louis* (1821), *Histoire de la destruction du paganisme en occident* (2 vols., 1885), and edited the *Olim* of the parlement of Paris, the *Assizes of Jerusalem*, and the *Coutumes de Beauvoisis* of Philippe de Beaumanoir. He was a member of the chamber of peers under Louis Philippe, and opposed Villemain's plan for freedom of education. After 1848 he maintained the same rôle, acting as reporter of the *loi Falloux*. He retired from public life after the *coup d'état* of Napoleon III., and died on the 15th of March 1865.

The *Mémoires* of J. C. Beugnot were published by his grandson, Count Albert Beugnot (2nd ed., Paris, 1868); see H. Wallon, *Éloges académiques* (1882); and E. Dejean, *Un Préfet du Consulat: J. C. Beugnot* (Paris, 1907).

BEULÉ, CHARLES ERNEST (1826-1874), French archaeologist and politician, was born at Saumur on the 29th of June 1826. He was educated at the École Normale, and after having held the professorship of rhetoric at Moulins for a year, was sent to Athens in 1851 as one of the professors in the École Française there. He had the good fortune to discover the propylæa of the Acropolis, and his work, *L'Acropole d'Athènes* (2nd ed., 1863), was published by order of the minister of public instruction. On his return to France, promotion and distinctions followed rapidly upon his first successes. He was made doctor of letters, chevalier of the Legion of Honour, professor of archaeology at the Bibliothèque Impériale, member of the Académie des Inscriptions et Belles-Lettres and perpetual secretary of the Académie des Beaux-Arts. He took great interest in political affairs, with which the last few years of his life were entirely occupied. Elected a member of the National Assembly in 1871, he zealously supported the Orleanist party. In May-November 1873 he was minister of the interior in the Broglie ministry. He died by his own hand on the 4th of April 1874. His other important works are: *Études sur le Péloponnèse* (2nd ed., 1875); *Les Monnaies d'Athènes* (1858); *L'Architecture au siècle de Pisistrate* (1860); *Fouilles à Carthage* (1861). Beulé was also the author of high-class popular works on artistic and historical subjects: *Histoire de l'art grec avant Périclès* (2nd ed., 1870); *Le Procès des Césars* (1867-1870, in four parts; *Auguste, sa famille et ses amis; Tibère et l'héritage d'Auguste; Le Sang de Germanicus; Titus et sa dynastie*).

See IDEVILLE, *Monsieur Beulé, Souvenirs personnels* (1874).

BEURNONVILLE, PIERRE DE RUEL, MARQUIS DE (1752-1821), French general. After service in the colonies, he married a wealthy Creole, and returning to France purchased the post of lieutenant of the Swiss guard of the count of Provence. During the Revolution he was named lieutenant-general, and took an active part in the battles of Valmy and Jemmapes. Minister of war in February 1793, he denounced his old commander, C. F. Dumouriez, to the Convention, and was one of the four deputies sent to watch him. Given over by him to the Austrians on the 3rd of April 1793, Beurnonville was not exchanged until November 1795. He entered the service again, commanded the armies of the Sambre-et-Meuse and of the North, and was appointed inspector of infantry of the army of England in 1798. In 1800 he was sent as ambassador to Berlin, in 1802 to Madrid. Napoleon made him a senator and count of the empire. In 1814 he was a member of the provisional government organized after the abdication of Napoleon, and was created a peer of France. During the Hundred Days

he followed Louis XVIII. to Ghent, and after the second restoration was made marquis and marshal of France.

See A. CHAQUET, *Les Guerres de la Révolution* (Paris, 1886).

BEUST, FRIEDRICH FERDINAND VON (1809-1886), Austrian statesman, was descended from a noble family which had originally sprung from the Mark of Brandenburg, and of which one branch had been for over 300 years settled in Saxony. He was born on the 13th of January 1809 in Dresden, where his father held office at the Saxon court. After studying at Leipzig and Göttingen he entered the Saxon public service; in 1836 he was made secretary of legation at Berlin, and afterwards held appointments at Paris, Munich and London. In March 1848 he was summoned to Dresden to take the office of foreign minister, but in consequence of the outbreak of the revolution was not appointed. In May he was appointed Saxon envoy at Berlin, and in February 1849 was again summoned to Dresden, and this time appointed minister of foreign affairs, an office which he continued to hold till 1866. In addition to this he held the ministry of education and public worship from 1849 to 1853; that of internal affairs in 1853, and in the same year was appointed minister-president. From the time that he entered the ministry he was, however, the leading member of it, and he was chiefly responsible for the events of 1849. By his advice the king refused to accept the constitution proclaimed by the Frankfurt parliament, a policy which led to the outbreak of revolution in Dresden, which was suppressed after four days' fighting by Prussian troops, for whose assistance Beust had asked. On Beust fell also the chief responsibility for governing the country after order was restored, and he was the author of the so-called *coup d'état* of June 1850 by which the new constitution was overthrown. The vigour he showed in repressing all resistance to the government, especially that of the university, and in reorganizing the police, made him one of the most unpopular men among the Liberals, and his name became synonymous with the worst form of reaction, but it is not clear that the attacks on him were justified. After this he was chiefly occupied with foreign affairs, and he soon became one of the most conspicuous figures in German politics. He was the leader of that party which hoped to maintain the independence of the smaller states, and was the opponent of all attempts on the part of Prussia to attract them into a separate union; in 1849-1850 he had been obliged to join the "three kings' union" of Prussia, Hanover and Saxony, but he was careful to keep open a loophole for withdrawal, of which he speedily availed himself. In the crisis of 1851 Saxony was on the side of Austria, and he supported the restoration of the diet of the confederation. In 1854 he took part in the Bamberg conferences, in which the smaller German states claimed the right to direct their own policy independent of that of Austria or of Prussia, and he was the leading supporter of the idea of the *Trias*, i.e. that the smaller states should form a closer union among themselves against the preponderance of the great monarchies. In 1863 he came forward as a warm supporter of the claims of the prince of Augustenburg to Schleswig-Holstein (see SCHLESWIG-HOLSTEIN QUESTION); he was the leader of the party in the German diet which refused to recognize the settlement of the Danish question effected in 1852 by the treaty of London, and in 1864 he was appointed representative of the diet at the congress of London. He was thus thrown into opposition to the policy of Bismarck, and he was exposed to violent attacks in the Prussian press as a "particularist," i.e. a supporter of the independence of the smaller states. The expulsion of the Saxon troops from Rendsburg nearly led to a conflict with Prussia. Beust was accused of having brought about the war of 1866, but the responsibility for this must rest with Bismarck. On the outbreak of war Beust accompanied the king to Prague, and thence to Vienna, where they were received by the emperor with the news of Königgrätz. Beust undertook a mission to Paris to procure the help of Napoleon. When the terms of peace were discussed he resigned, for Bismarck refused to negotiate with him.

After the victory of Prussia there was no place for Beust in

Germany, and his public career seemed to be closed, but he quite unexpectedly received an invitation from the emperor of Austria to become his foreign minister. It was a bold decision, for Beust was not only a stranger to Austria, but also a Protestant; but the choice of the emperor justified itself. Beust threw himself into his new position with great energy; it was owing to him that the negotiations with Hungary were brought to a successful issue. When difficulties came he went himself to Budapest, and acted directly with the Hungarian leaders. In 1867 he also held the position of Austrian minister-president, and he carried through the measures by which parliamentary government was restored. He also carried on the negotiations with the pope concerning the repeal of the concordat, and in this matter also did much by a liberal policy to relieve Austria from the pressure of institutions which had checked the development of the country. In 1868, after giving up his post as minister-president, he was appointed chancellor of the empire, and received the title of count. His conduct of foreign affairs, especially in the matter of the Balkan States and Crete, successfully maintained the position of the empire. In 1866 he accompanied the emperor on his expedition to the East. He was still to some extent influenced by the anti-Prussian feeling he had brought from Saxony. He maintained a close understanding with France, and there can be little doubt that he would have welcomed an opportunity in his new position of another struggle with his old rival Bismarck. In 1867, however, he helped to bring the affair of Luxemburg to a peaceful termination. In 1870 he did not disguise his sympathy for France, and the failure of all attempts to bring about an intervention of the powers, joined to the action of Russia in denouncing the treaty of Paris, was the occasion of his celebrated saying that he was nowhere able to find Europe. After the war was over he completely accepted the new organization of Germany.

As early as December 1870 he had opened a correspondence with Bismarck with a view to establishing a good understanding with Germany. Bismarck accepted his advances with alacrity, and the new *entente*, which Beust announced to the Austro-Hungarian delegations in July 1871, was sealed in August by a friendly meeting of the two old rivals and enemies at Gastein.

In 1871 Beust interfered at the last moment, together with Andrassy, to prevent the emperor accepting the federalist plans of Hohenwart. He was successful, but at the same time he was dismissed from office. The precise cause for this is not known, and no reason was given him. At his own request he was appointed Austrian ambassador at London; in 1878 he was transferred to Paris; in 1882 he retired from public life. He died at his villa at Altenberg, near Vienna, on the 24th of October 1886, leaving two sons, both of whom entered the Austrian diplomatic service. His wife, a Bavarian lady, survived him only a few weeks. His elder brother Friedrich Konstantin (1806-1891), who was at the head of the Saxon department for mines, was the author of several works on mining and geology, a subject in which other members of the family had distinguished themselves.

Beust was in many ways a diplomatist of the old school. He had great social gifts and personal graces; he was proud of his proficiency in the lighter arts of composing waltzes and *vers de société*. His chief fault was vanity, but it was an amiable weakness. It was more vanity than rancour which made him glad to appear even in later years as the great opponent of Bismarck; and if he cared too much for popularity, and was very sensitive to neglect, the saying attributed to Bismarck, that if his vanity were taken away there would be nothing left, is very unjust. He was apt to look more to the form than the substance, and attached too much importance to the verbal victory of a well-written despatch; but when the opportunity was given him he showed higher qualities. In the crisis of 1849 he displayed considerable courage, and never lost his judgment even in personal danger. If he was defeated in his German policy, it must be remembered that Bismarck held all the good cards, and in 1866 Saxony was the only one of the smaller states

which entered on the war with an army properly equipped and ready at the moment. That he was no mere reactionary the whole course of his government in Saxony, and still more in Austria, shows. His Austrian policy has been much criticized, on the ground that in establishing the system of dualism he gave too much to Hungary, and did not really understand Austrian affairs; and the Austro-Hungarian crisis during the early years of the present century has given point to this view. Yet it remains the fact that in a crisis of extraordinary difficulty he carried to a successful conclusion a policy which, even if it was not the best imaginable, was probably the best attainable in the circumstances.

Beust was the author of reminiscences: *Aus drei Viertel-Jahrhunderten* (2 vols., Stuttgart, 1887; English trans. edited by Baron H. de Worms); and he also wrote a shorter work, *Erinnerungen an Erinnerungen* (Leipzig, 1881), in answer to attacks made on him by his former colleague, Hieron. v. Frieser, in his reminiscences. See also Ebeling, *K. P. Graf v. Beust* (Leipzig, 1876), a full and careful account of his political career, especially up to 1866; *Diplomatic Sketches: No. 1, Count Beust*, by Outsider (Baron Carl v. Malortie); *Flathe, Geschichte von Sachsen*, vol. iii. (Gotha, 1877); Friesen, *Erinnerungen aus meinem Leben* (Dresden, 1880). (J. W. H. E.)

BEUTHEN, or **NIEDERBEUTHEN**, a town of Germany, in the north of Prussian Silesia, on the Oder, the capital of the mediatised principality of Carolath-Beuthen. Pop. (1900) 3764. The chief industries of the place are straw-plaiting, boat-building, and the manufacture of pottery; and a considerable traffic is carried on by means of the river.

BEUTHEN, or **ÖBERBEUTHEN**, a town of Germany, in the extreme south-east of Prussian Silesia, on the railway between Breslau and Cracow, 121 m. S.E. of the former. Pop. (1905) 60,078. It is the centre of the mining district of Upper Silesia; and its population is mainly engaged in such operations and in iron and zinc smelting. Beuthen is an old town, and was formerly the capital of the Bohemian duchy of Beuthen, which in 1620 was ultimately granted, as a free lordship of the Empire, to Lazarus, Baron Henckel von Donnersmarck, by the emperor Ferdinand II., and parts of which, now mediatised, are held by two branches of the counts Henckel von Donnersmarck.

BEVEL (from an O. Fr. word, cf. mod. *biveau*, a joiner's instrument), the inclination of one surface of a solid body to another; also, any angle other than a right angle, and particularly, in joinery, the angle to which a piece of timber has to be cut. The mechanic's instrument known as a bevel consists of a rule with two arms so jointed as to be adjustable to any angle. In heraldry, a bevel is an angular break in a line. Bevelment, as a term of crystallography, means the replacement of an edge of a crystal by two planes equally inclined to the adjacent planes. As an architectural term "bevel" is a sloped or canted edge given to a sill or horizontal course of stone, but is more frequently applied to the canted edges worked round the projecting bands of masonry which for decorative purposes are employed on the quoins of walls or windows and in some cases, with vertical joints, cover the whole wall. When the outer face of the stone band is left rough so that it forms what is known as rusticated masonry, the description would be bevelled and rusticated. The term is sometimes applied to the spaying of the edges of a window on the outside, but the wide expansion made inside in order to admit more light is known as a spay.

BEVERLEY, **WILLIAM ROXBY** (1814?-1880), English artist and scene-painter, was born at Richmond, Surrey, about 1814, the son of William Roxby, an actor-manager who had assumed the name of Beverley. His four brothers and his sister all entered the theatrical profession, and Beverley soon became both actor and scene-painter. In 1831 his father and his brothers took over the old Durham circuit, and he joined them to play heavy comedy for several seasons, besides painting scenery. His work was first seen in 1831 in London, for the pantomime *Baron Munchausen* at the Victoria theatre, which was being managed by his brother Henry. He was appointed scenic director for the Covent Garden operas in 1853. In 1854 he entered the service of the Drury Lane theatre under the management of E. T. Smith, and for thirty years continued to produce

wonderful scenes for the pantomimes, besides working for Covent Garden and a number of other theatres. In 1851 he executed part of a great diorama of Jerusalem and the Holy Land, and produced dioramic views of the ascent of Mont Blanc, exhibited at the Egyptian Hall, Piccadilly, and in 1884 a panorama of the Lakes of Killarney. He was a frequent exhibitor of sea pictures at the Royal Academy from 1865 to 1880. In 1884, failing eyesight put an end to his painting. He died in comparative poverty at Hampstead on the 17th of May 1880. He was the last of the old school of one surface painters, and famed for the wonderful atmospheric effects he was able to produce. Although he was skilled in all the mechanical devices of the stage, and painted in 1881 scenery for *Michael Strogoff* at the Adelphi, in which for the first time in England the still life of the stage was placed in harmony with the background, he was strongly opposed to the new school of scene-builders.

BEVERLEY, a market town and municipal borough in the Holderness parliamentary division of the East Riding of Yorkshire, England, 8 m. N.N.W. of Hull by a branch of the North-Eastern railway. Pop. (1901) 13,183. It lies in a level country east of the line of slight elevations known as the Wolds, near the river Hull, and has communication by canal with Hull. The church of St John the Evangelist, commonly called Beverley Minster, is a magnificent building, exceeding in size and splendour some of the English cathedrals. A monastery was founded here by John of Beverley (c. 640-721), a native of the East Riding, who was bishop successively of Hexham and York, and was canonized in 1037. A college of secular canons followed in the 10th century, the provostship of which subsequently became an office of high dignity, and was held by Thomas Becket, afterwards archbishop of Canterbury. Of the existing building, the easternmost bay of the nave, the transepts with east and west aisles, the choir with aisles and short transepts, and the Lady chapel, are Early English, a superb example of the finest development of that style. The remainder of the nave is Decorated, excepting the westernmost bay which is Perpendicular, as is the ornate west front with its graceful flanking towers. The north porch is also a beautiful example of this style. The most noteworthy details within the church are the exquisite Early English staircase which led to the chapter house (no longer remaining), and the Percy tomb, a remarkable example of Decorated work, commemorating Eleanor, wife of Henry Percy (d. 1328). The church of St Mary is a cruciform building with central tower, almost entirely of Decorated and Perpendicular work. Though overshadowed by the presence of the minster, it is yet a very fine example of its styles, its most noteworthy features being the tower and the west front. Beverley was walled, and one gate of the 15th century remains; there are also some picturesque old houses. The industries are tanning, iron-founding, brewing and the manufacture of chemicals; and there is a large agricultural trade. Beverley is the seat of a suffragan bishop in the diocese of York. The municipal borough is under a mayor, 6 aldermen and 18 councillors, and has an area of 2404 acres, including a large extent of common pasture land.

Beverley (Beverlac) was said to be on the site of a British settlement. Evidently a church had existed there before 704, since in that year it was restored by St John of Beverley, who also founded a monastery there, and was himself buried in the church. In the devastation of the north of England which followed the Conquest, Beverley is said to have escaped by a miracle attributed to St John; the Norman leader, while about to enter and pillage the church, fell from his horse dead, and the king, thinking this a sign that the town was under the protection of heaven, exempted it from pillage. From the time of St John of Beverley until the dissolution of the monasteries, the manor and town of Beverley belonged to the archbishopric of York, and is said to have been held under a charter of liberties supposed to have been granted by King Æthelstan in 925. This charter, besides other privileges, is said to have granted sanctuary in Beverley, and the "leuge" over which this privilege extended was afterwards shown to include the whole town. Confirmations of Æthelstan's charter were granted by Edward the Confessor and other succeeding kings. In the reign of Henry I. Thurstan, archbishop of York, gave the burgesses their first charter, which is one of the earliest granted to any town in England. In it he granted them the same privileges as the citizens of York, among these being

a gild merchant and freedom from toll throughout the whole of Yorkshire, with right to take it at all the markets and fairs in their town except at the three principal fairs, the toll of which belonged to the archbishop. In 1200 King John granted the town a new charter, for which the burgesses had to pay 500 marks. Other charters generally confirming the first were granted to the town by most of the early kings. The incorporation charter granted by Queen Elizabeth in 1573 was confirmed by Charles I. in 1629 and Charles II. in 1663, and renewed by James II. on his accession. Parliamentary representation by two members began in the reign of Edward I., but lapsed, until the corporation charter of 1573, from which date it continued until the Reform Act of 1867. In 1554-1555 Queen Mary granted the three fairs on the feasts of St John the Confessor, the Translation of St John and the Nativity of St John the Baptist, together with the weekly markets on Wednesday and Saturday, which had been held by the archbishops of York by traditional grant of Edward the Confessor to the burgesses of the town. Cloth-weaving was one of the chief industries of Beverley; it is mentioned and appears to have been important as early as 1315.

See *Victoria County History—Yorkshire*; G. Poulson, *Beverlac; Antiquities and History of Beverley and of the Procontry, &c., of St John's* (2 vols., 1829); G. Oliver, D. D., *History and Antiquities of Beverley*, &c. (1829).

BEVERLY, a seaboard city of Essex county, Massachusetts, U.S.A., situated on the N. shore of Massachusetts Bay, opposite Salem. It is 18 m. from Boston on the Boston & Maine railway. Pop. (1890) 10,821; (1900) 13,884, of whom 2814 were foreign-born; (1910, census) 18,650. The land area of the city is about 15 sq. m. The surface is the typical glacial topography, with a few low, rocky hills, less than 100 ft. in height. There are beautiful drives through well-wooded districts, studded with handsome summer houses. In the city are a public library, the Beverly hospital, the New England industrial school for deaf mutes (organized, 1876; incorporated, 1879), and the Beverly historical society (1891), which owns a large colonial house, in which there is a valuable historical collection. The city has an excellent public school system. There are a number of manufacturing establishments; in 1905 the total factory product of the city was valued at \$4,101,168, boots and shoes accounting for more than one-half of the total. Leather and shoe machinery also are important manufactures; and the main plant of the United Shoe Machinery Corporation is located here. Market gardening is a considerable industry, and large quantities of vegetables are raised under glass for the Boston markets. Fishing is an industry no longer of much importance. Beverly is connected by a regular line of oil-steamer with Port Arthur, Texas, and is the main distributing point for the Texas oil fields. The first settlement within the limits of Beverly was made by Roger Conant in 1626. The town was a part of Salem until 1668, when it was incorporated as a separate township; in 1804 it was chartered as a city. In 1788 there was established here the first cotton mill to be successfully operated in the United States. The manufacture of Britannia ware was begun in 1812. George Cabot lived for many years in Beverly, which he represented in the provincial congress (1779); Nathan Dane (1752-1835) was also a resident; and it was the birthplace of Wilson Flagg (1805-1884), the author of *Studies in the Field and Forest* (1857), *The Woods and By-Ways of New England* (1872), *The Birds and Seasons of New England* (1875), and *A Year with the Birds* (1881). It was also the birthplace and early home of Lucy Larcom (1826-1893), and the scene of much of her *Story of a New England Girlhood* (Boston, 1880).

BEVIS OF HAMPTON, the name of an English metrical romance. Bevis is the son of Guy, count of Hampton (Southampton) and his young wife, a daughter of the king of Scotland. The countess asks a former suitor, Doon or Devoun, emperor of Almaine (Germany), to send an army to murder Guy in the forest. The plot is successful, and she marries Doon. When threatened with future vengeance by her ten-year-old son, she determines to make away with him also, but he is saved from death by a faithful tutor, is sold to heathen pirates, and reaches the court of King Hermin, whose realm is variously placed in Egypt and Armenia (Armoica). The exploits of Bevis, his love for the king's daughter Josiane, his mission to King Bradmond of Damascus with a sealed letter demanding his own death, his

imprisonment, his final vengeance on his stepfather are related in detail. After succeeding to his inheritance he is, however, driven into exile and separated from Josiane, to whom he is reunited only after each of them has contracted, in form only, a second union. The story also relates the hero's death and the fortunes of his two sons.

The oldest extant version appears to be *Boete de Haumtone*, an Anglo-Norman text which dates from the first half of the 13th century. The English metrical romance, *Sir Beves of Hamtoun*, is founded on some French original varying slightly from those which have been preserved. The oldest MS. dates from the beginning of the 14th century. The French *chanson de geste*, *Beuve d'Haustone*, was followed by numerous prose versions. The printed editions of the story were most numerous in Italy, where *Bovo d'Antona* was the subject of more than one poem, and the tale was interpolated in the *Realis di Francia*, the Italian compilation of Carolingian legend. Although the English version that we possess is based on a French original, it seems probable that the legend took shape on English soil in the 10th century, and that it originated with the Danish invaders. Doon may be identified with the emperor Otto the Great, who was the contemporary of the English king Edgar of the story. R. Zenker (*Boeve-Amlethus*, Berlin and Leipzig, 1904) establishes a close parallel between Bevis and the Hamlet legend as related by Saxo Grammaticus in the *Historia Danica*. Among the more obvious coincidences which point to a common source are the vengeance taken on a stepfather for a father's death, the letter bearing his own death-warrant which is entrusted to the hero, and his double marriage.¹ The motive of the feigned madness is, however, lacking in Bevis. The princess who is Josiane's rival is less ferocious than the Hermuthrada of the Hamlet legend, but she threatens Bevis with death if he refuses her. Both seem to be modelled on the type of Thyro of the Beowulf legend. A fanciful etymology connecting Bevis (Boeve) with Béova (Beowulf), on the ground that both were dragon slayers, is inadmissible.

BIBLIOGRAPHY.—*The Romance of Sir Beves of Hamtoun*, edited from six MSS. and the edition (without date) of Richard Pynson, by E. Kolbing (Early Eng. Text Soc., 1885-1886-1894); A. Stimming, "Der anglonormannische Boeve de Haumtone," in H. Suchier's *Bibl. Norm. vol. vii.* (Halle, 1899); the Welsh version, with a translation, is given by R. Williams, *Selections of the Hengwrt MSS.* (vol. ii., London, 1892); the old Norse version by G. Cederblad, *Forn-sögur Sudhlandia* (Lund, 1884); A. Wesselsöfsky, "Zum russischen Bovo d'Antona" (in *Archiv für slav. Phil.*, vol. viii., 1885); for the early printed editions of the romance in English, French and Italian see G. Brunet, *Manuel du libraire*, s.vv. Bevis, Beufes and Buovo.

BEWDLEY, a market town and municipal borough in the Bewdley parliamentary division of Worcestershire, England; 137 m. N.W. by W. from London and 1¼ N. by W. from Worcester by rail. Pop. (1901) 2866. The Worcester-Shrewsbury line of the Great Western is here joined by lines east from Birmingham and west from Tenbury. Bewdley is pleasantly situated on the sloping right bank of the Severn, on the eastern border of the forest of Wyre. A bridge by Telford (1797) crosses the river. A free grammar school, founded in 1501, was re-founded by James I. in 1606, and possesses a large library bequeathed in 1812. The town manufactures combs and horn goods, brass and iron wares, leather, malt, bricks and ropes. The town is governed by a mayor, 4 aldermen and 12 councillors. Area, 2105 acres.

Bewdley (i.e. Beaulieu) is probably referred to in the Domesday survey as "another Ribbestof," and was held by the king. The manor, then called *Beilus Locus* or Beaulieu on account of its beautiful situation, was afterwards granted to the Mortimers, in whose family it continued until it was merged in the crown on the accession of Edward IV. It is from this time that Bewdley dates its importance. Through its situation on the Severn it was connected with the sea, and in 1250 a bridge, the only one between it and Worcester, was built across the river and added greatly to the commerce of the town. From Edward IV. Bewdley received its charter in 1472, and there

appears to be no evidence that it was a borough before this time. Other charters were granted in 1605, 1685 and 1708. By James I.'s charter the burgesses sent one member to parliament, and continued to do so until 1885. A fair and a market on Wednesday were granted by Edward III. in 1373 to his grand-daughter Philippa, wife of Edmund Mortimer, and confirmed to Richard, duke of York, by Henry VI. Edward IV. also granted the burgesses a market on Saturdays, and three fairs, which were confirmed to them by Henry VII. Coal-mines were worked in Bewdley as early as 1669, and the town was formerly noted for making caps.

BEWICK, THOMAS (1753-1828), English wood-engraver, was born at Cherryburn, near Newcastle-on-Tyne, in August 1753. His father rented a small colliery at Micklebybank, and sent his son to school at Mickleby. He proved a poor scholar, but showed, at a very early age, a remarkable talent for drawing. He had no tuition in the art, and no models save natural objects. At the age of fourteen he was apprenticed to Mr Beilby, an engraver in Newcastle. In his office Bewick engraved on wood for Dr Hutton a series of diagrams illustrating a treatise on mensuration. He seems thereafter to have devoted himself entirely to engraving on wood, and in 1775 he received a premium from the Society for the Encouragement of Arts and Manufactures for a woodcut of the "Huntsman and the Old Hound." In 1784 appeared his *Select Fables*, the engravings in which, though far surpassed by his later productions, were incomparably superior to anything that had yet been done in that line. The *Quadrupeds* appeared in 1790, and his great achievement, that with which his name is inseparably associated, the *British Birds*, was published from 1797-1804. Bewick, from his intimate knowledge of the habits of animals acquired during his constant excursions into the country, was thoroughly qualified to do justice to his great task. Of his other productions the engravings for Goldsmith's *Traveller* and *Deserted Village*, for Parnell's *Hermit*, for Somerville's *Chase*, and for the collection of *Fables of Aesop and Others*, may be specially mentioned. Bewick was for many years in partnership with his former master, and in later life had numerous pupils, several of whom gained distinction as engravers. He died on the 8th of November 1828.

His autobiography, *Memoirs of Thomas Bewick, by Himself*, appeared in 1862.

BEXHILL, a municipal borough and watering-place in the Rye parliamentary division of Sussex, England, 62 m. S.E. by S. from London, on the London, Brighton & South Coast, and the South-Eastern & Chatham railways. Pop. (1891) 5206; (1901) 12,213. The ancient village, with the Norman and Early English church of St Peter, lies inland on the slope of the low hills fringing the coast, but the watering-place on the shore has developed very rapidly since about 1884, owing to the exertions of Earl De la Warr, who owns most of the property. It has a marine parade, pier, golf links, and the usual appointments of a seaside resort, while the climate is bracing and the neighbouring country pleasant. Bexhill was incorporated in 1902, the corporation consisting of a mayor, 6 aldermen and 18 councillors. Area, 8013 acres.

BEXLEY, NICHOLAS VANSITTART, BARON (1766-1851), English politician, was the fifth son of Henry Vansittart (d. 1770), governor of Bengal, and was born in London on the 20th of April 1766. Educated at Christ Church, Oxford, he took his degree in 1787, and was called to the bar at Lincoln's Inn in 1791. He began his public career by writing pamphlets in defence of the administration of William Pitt, especially on its financial side, and in May 1796 became member of parliament for Hastings, retaining his seat until July 1802, when he was returned for Old Sarum. In February 1801 he was sent on a diplomatic errand to Copenhagen, and shortly after his return was appointed joint secretary to the treasury, a position which he retained until the resignation of Addington's ministry in April 1804. Owing to the influence of his friend, Ernest, duke of Cumberland, he became secretary for Ireland under Pitt in January 1805, resigning his office in the following September. With Addington, now Viscount Sidmouth, he joined the government of Fox and Grenville as secretary to the treasury in February 1806, leaving office with Sidmouth just before the fall of the ministry in March

¹ On double marriage in early romance see G. Paris, "La Légende du mari aux deux femmes," in *La Poésie du moyen âge* (2nd series, Paris, 1895); and A. Nutt, "The Lai of Eliduc," &c., in *Folk-Lore*, vol. iii. (1892).

1807. During these and the next few years Vansittart's reputation as a financier was gradually rising. In 1809 he proposed and carried without opposition in the House of Commons thirty-eight resolutions on financial questions, and only his loyalty to Sidmouth prevented him from joining the cabinet of Spencer Perceval as chancellor of the exchequer in October 1809. He opposed an early resumption of cash payments in 1811, and became chancellor of the exchequer when the earl of Liverpool succeeded Perceval in May 1812. Having forsaken Old Sarum, he had represented Helston from November 1806 to June 1812; and after being member for East Grinstead for a few weeks, was returned for Harwich in October 1812.

When Vansittart became chancellor of the exchequer the country was burdened with heavy taxation and an enormous debt. Nevertheless, the continuance of the war compelled him to increase the custom duties and other taxes, and in 1813 he introduced a complicated scheme for dealing with the sinking fund. In 1816, after the conclusion of peace, a large decrease in taxation was generally desired, and there was a loud outcry when the chancellor proposed only to reduce, not to abolish, the property or income tax. The abolition of this tax, however, was carried in parliament, and Vansittart was also obliged to remit the extra tax on malt, meeting a large deficiency principally by borrowing. He devoted considerable attention to effecting real or supposed economies with regard to the national debt. He carried an elaborate scheme for handing over the payment of naval and military pensions to contractors, who would be paid a fixed annual sum for forty-five years; but no one was found willing to undertake this contract, although a modified plan on the same lines was afterwards adopted. Vansittart became very unpopular in the country, and he resigned his office in December 1822. His system of finance was severely criticized by Huskisson, Tierney, Brougham, Hume and Ricardo. On his resignation Liverpool offered Vansittart the post of chancellor of the duchy of Lancaster. Accepting this offer in February 1823, he was created Baron Bexley in March, and granted a pension of £3000 a year. He resigned in January 1828. In the House of Lords Bexley took very little part in public business, although he introduced the Spitalfields weavers bill in 1823, and voted for the removal of Roman Catholic disabilities in 1824. He took a good deal of interest in the British and Foreign Bible Mission, the Church Missionary Society and kindred bodies, and assisted to found King's College, London. He died at Foot's Cray, Kent, on the 8th of February 1851. His wife, whom he married in July 1806, was Isabella (d. 1810), daughter of William Eden, 1st Baron Auckland, and as he had no issue the title became extinct on his death. There are nine volumes of Vansittart's papers in the British Museum.

See Spencer Walpole, *History of England* (London, 1890); S. C. Buxton, *Finance and Politics* (London, 1888).

BEXLEY, an urban district in the Dartford parliamentary division of Kent, England, 12 m. S.E. by E. of London by the South-Eastern & Chatham railway. Pop. (1901) 12,918. Bexley, which is mentioned in Domesday Book, has had a church since the 9th century. The present church of St Mary is Early English and later. With the rental of the manor of Bexley, William Camden, the antiquary, founded the ancient history professorship at Oxford. Hall Place, which contains a fine Jacobean staircase and oak-panelled hall, is said to occupy the site of the dwelling-place of the Black Prince. The course of Watling Street may be traced over Bexley Heath, where, too, there exist deep pits, widening into vaults below, and probably of British origin.

BEY (a modern Turk. word, the older form being *beg*, cf. Pers. *baig*), the administrator of a district, now generally an honorific title throughout the Turkish empire; the granting of this in Egypt is made by the sultan of Turkey through the khedive. In Tunis "bey" has become the hereditary title of the reigning sovereigns (see TUNISIA).

BEYBAZAR, the chief town of a *kaza* of the Angora vilayet in Asiatic Turkey, situated on an affluent of the Sakaria (anc. *Sangarius*), about 52 m. W. of Angora. It corresponds to the

anc. *Lagania*, renamed *Anastasiopolis* under the emperor Anastasius (491-518), a bishopric by the 5th century. Its well-built wooden houses cover the slopes of three hills at the mouth of a gorge filled with fruit gardens and vineyards. The chief products are rice, cotton and fruits. From Beybazar come the fine pears sold in Constantinople as "Angora pears"; its muskmelons are equally esteemed; its grapes are used only for a sweetmeat called *jenidi-sujuk* ("nutty fruit sausage"). There are few remains of antiquity apart from numerous rock-cut chambers lining the banks of the stream. Pop. about 4000 to 5000.

BEYLE, MARIE HENRI (1783-1842), better known by his *nom de plume* of STENDHAL, French author, was born at Grenoble on the 23rd of January 1783. With his father, who was an *avocat* in the parlement of Grenoble, he was never on good terms, but his intractable disposition sufficiently explains his unhappy childhood and youth. Until he was twelve years old he was educated by a priest, who succeeded in inspiring him with a lasting hatred of clericalism. He was then sent to the newly established *École Centrale* at Grenoble, and in 1799 to Paris with a letter of introduction to the Daru family, with which the Beyles were connected. Pierre Daru offered him a place in the ministry for war, and with the brothers Daru he followed Napoleon to Italy. Most of his time in Italy was spent at Milan, a city for which he conceived a lasting attachment. Much of his *Chartreuse de Parme* seems to be autobiographical of this part of his life.

He was a spectator of the battle of Marengo, and afterwards enlisted in a dragoon regiment. With rapid promotion he became adjutant to General Michaud; but after the peace of Amiens in 1802 he returned to study in Paris. There he met an actress, Mélanie Guilbert, whom he followed to Marseilles. His father cut off his supplies on hearing of this escapade, and Beyle was reduced to serving as clerk to a grocer. Mélanie Guilbert, however, soon abandoned him to marry a Russian, and Beyle returned to Paris. Through the influence of Daru he obtained a place in the commissariat, which he filled with some distinction from 1806 to 1814. Charged with raising a levy in Brunswick of five million francs, he extracted seven; and during the retreat from Moscow he discharged his duties with efficiency. On the fall of Napoleon he refused to accept a place under the new régime, and retired to Milan, where he met Silvio Pellico, Manzoni, Lord Byron and other men of note. At Milan he contracted a *liaison* with a certain Angelina P., whom he had admired fruitlessly during his earlier residence in that city. In 1814 he published, under the pseudonym of Alexandre César Bombet, his *Lettres écrites de Vienne en Autriche sur le célèbre compositeur, Joseph Haydn, suivies d'une vie de Mozart, et de considérations sur Métastase et l'état présent de la musique en Italie*. His letters on Haydn were borrowed from the *Haydini* (1812) of Joseph Carpani, and the section on Mozart had no greater claim to originality. The book was reprinted (1817) as *Vies de Haydn, Mozart et Métastase*. His *Histoire de la peinture en Italie* (2 vols., 1817) was originally dedicated to Napoleon.

His friendship with some Italian patriots brought him in 1821 under the notice of the Austrian authorities, and he was exiled from Milan. In Paris he felt himself a stranger, as he had never recognized French contemporary art in literature, music or painting. He frequented, however, many literary salons in Paris, and found some friends in the "idéologues" who gathered round Destutt de Tracy. He was the most closely allied with Prosper Mérimée, a dilettante and an ironist like himself. He published at this time his *Essai sur l'amour* (1822), of which only seventeen copies were sold in eleven years, though it afterwards became famous, Racine et Shakespeare (1823-1825), *Vie de Rossini* (1824), *D'un nouveau complot contre les industriels* (1825), *Promenades dans Rome* (1826), and his first novel, *Armance, ou quelques scènes de Paris en 1827* (1827). After the Revolution of 1830 he was appointed consul at Trieste, but the Austrian government refused to accept him, and he was sent to Civita Vecchia instead. *Le Rouge et le noir, chronique du XIX^e siècle* (2 vols., 1830) appeared in Paris after his departure, but attracted

small notice. He had published in 1838 *Mémoires d'un touriste*, and in 1839 *La Chartreuse de Parme* (2 vols.), which was the last of his publications, and the first to secure any popular success, though his earlier writings had been regarded as significant by a limited public. It was enthusiastically reviewed by Balzac in his *Revue Parisienne* (1840). Beyle remained at Civita Vecchia, discharging his duties as consul perfunctorily and with frequent intervals of absence until his death, which took place in Paris on the 23rd of March 1842. He wrote his own epitaph,¹ describing himself as a Milanese.

His posthumous works include a fragmentary *Vie de Napoléon* (1875); *Mélanges d'art et de littérature* (1867); *Chroniques italiennes* (1868), including "L'Abbesse de Castro," "Les Cenci," "Vittoria Accoromboni," "Vanina Vanini," "La Duchesse de Palliano," some of which has appeared separately; *Romans et nouvelles* and *Nouvelles inédites* (1855); *Correspondance* (2 vols., 1855); *Lamie* (ed. C. Stryienski, 1889); his *Journal 1801-1814* (ed. Stryienski and F. de Nion, 1888), of which the section dealing with the Russian and German campaigns is unfortunately lost; *Vie de Henri Brulard* (1890), a disguised autobiography, chiefly the history of his numerous love affairs; *Lettres intimes* (1892); *Lucien Leuwen* (ed. J. de Mitty, 1894); *Souvenirs d'égotisme* (ed. C. Stryienski, 1892), autobiography and unpublished letters.

Stendhal's reputation practically rests on the two novels *Le Rouge et le noir* and *La Chartreuse de Parme*. In the former of these he borrowed his plot from events which had actually happened some years previously. Julien Sorel in the novel is tutor in a noble family and seduces his pupil's mother. He eventually kills her to avenge a letter accusing him to the family of his betrothed, Mlle de la Mole. Julien is a picture of Beyle as he imagined himself to be. *La Chartreuse de Parme* has less unity of purpose than *Le Rouge et le noir*. For its setting the author drew largely on his own experiences. Fabrice's experiences at Waterloo are his own in the Italian campaign, and the countess Pietranera is his Milanese Angelina. But of the two novels it is more picturesque and has been more popular. Stendhal's real vogue dates from the early sixties, but his importance is essentially literary. In spite of his egotism and the limitations of his ideas, his acute analysis of the motives of his personages has appealed to successive generations of writers, and a great part of the development of the French novel must be traced to him. Brunetière has pointed out (*Manual of French Lit.*, Eng. trans., 1898) that Stendhal supplied the Romanticists with the notion of the interchange of the methods and effects of poetry, painting and music, and that in his worship of Napoleon he agreed with their glorification of individual energy. Stendhal, however, thoroughly disliked the Romanticists, though Sainte-Beuve acknowledged (*Causeries du lundi*, vol. ix.) that his books gave ideas. Taine (*Essais de critique et d'histoire*, 1857) found in him a great psychologist; Zola (*Romanciers naturalistes*, 1881) actually claimed him as the father of the naturalist school; and Paul Bourget (*Essais de psychologie contemporaine*, 1883) cited *Le Rouge et le noir* as one of the classic novels of analysis.

The 1846 edition of *La Chartreuse de Parme* contains a prefatory notice by R. Colomb, and a reprint of Balzac's article. In addition to the authorities already mentioned see the essay on Beyle (1850) by Prosper Mérimée; A. A. Paton, *Henry Beyle, a Critical and Biographical Study* (1874); Adolphe Paupe, *Histoire des œuvres de Stendhal* (1903); A. Chuquet, *Stendhal-Beyle* (1902); a review by R. Doumic (*Revue des deux mondes*, February 1902), deprecating the excessive attention paid to Beyle's writings; and Édouard Rod, *Stendhal* (1902) in the "Grands écrivains français" series. See also *Correspondance de Stendhal, 1800-1842*, with preface by M. Barrès (Paris, 1908).

BEYRICH, HEINRICH ERNST VON (1815-1896), German geologist, was born at Berlin on the 31st of August 1815, and educated at the university in that city, and afterwards at Bonn, where he studied under Goldfuss and Nöggerath. He obtained his degree of Ph.D. in 1837 at Berlin, and was subsequently employed in the mineralogical museum of the university, becoming director of the palaeontological collection in 1857, and director of the museum in 1875. He was one of the founders

of the German Geological Society in 1848. He early recognized the value of palaeontology in stratigraphical work; and he made important researches in the Rhenish mountains, in the Harz and Alpine districts. In later years he gave special attention to the Tertiary strata, including the Brown Coal of North Germany. In 1854 he proposed the term Oligocene for certain Tertiary strata intermediate between the Eocene and Miocene; and the term is now generally adopted. In 1865 he was appointed professor of geology and palaeontology in the Berlin University, where he was eminently successful as a teacher; and when the Prussian Geological Survey was instituted in 1873 he was appointed co-director with Wilhelm Hauchecorne (1848-1900). He published *Beiträge zur Kenntniss der Vereinerungen des rheinischen Übergangs-gebirges* (1837); *Über einige bähmische Trilobiten* (1845); *Die Conchylien des norddeutschen Tertiärgebirges* (1853-1857). He died on the 9th of July 1896.

BEYSCHLAG, WILLIBALD (1823-1900), German Protestant divine, was born at Frankfort-on-Main on the 5th of September 1823. He studied theology at Bonn and Berlin (1840-1844), and in 1856 was appointed court-preacher at Karlsruhe. In 1860, he moved to Halle as professor ordinarius of practical theology. A theologian of the mediating school, he became leader of the *Mittelpartei*, and with Albrecht Wolters founded as its organ the *Deutschevangelische Blätter*. As a representative of this party, he took a prominent part in the general synods of 1875 and 1876. His championship of the rights of the laity and his belief in the autonomy of the church led him to advocate the separation of church and state. He died at Halle on the 25th of November 1900. Among his other works are *Die Christologie des Neuen Testaments* (1866), *Der Altkatholicismus* (three editions, 1882-1883), *Leben Jesu* (2 vols., 1885; 3rd ed., 1893), *Neutestamentliche Theologie* (2 vols., 1891-1892; 2nd ed., 1896), *Christenlehre auf Grund des kleinen luth. Katechismus* (1900), and an autobiography *Als meinem Leben* (2 parts, 1896-1898).

See P. Schaff, *Living Divines* (1887); Lichtemberger, *Hist. Germ. Theol.* (1889); Calver-Zeller, *Kirchenlexikon*.

BEZA (DE BÈZE), THEODORE (1510-1605), French theologian, son of *bailli* Pierre de Bèze, was born at Vezelay, Burgundy, on the 24th of June 1510. Of good descent, his parents were known for generous piety. He owed his education to an uncle, Nicolas de Bèze, counsellor of the Paris parliament, who placed him (1529) under Melchior Wolmar at Orleans, and later at Bourges. Wolmar, who had taught Greek to Calvin, grounded Beza in Scripture from a Protestant standpoint; after his return to Germany (1534) Beza studied law at Orleans (May 1535 to August 1539), beginning practice in Paris (1539) as lay licentiate. To this period belong his exercises in Latin verse, in the loose taste of the day, foolishly published by him as *Juvenilia* in 1548. Though not in orders, he held two benefices. A severe illness wrought a change; he married his mistress, Claude Desnoz, and joined the church of Calvin at Geneva (October 1548). In November 1549 he was appointed Greek professor at Lausanne, where he acted as Calvin's adjutant in various publications, including his defence of the burning of Servetus, *De Haereticis a civili magistratu puniendis* (1554). In 1558 he became professor in the Geneva academy, where his career was brilliant. His conspicuous ability was shown in the abovementioned Colloquy of Poissy (1561). On Calvin's death (1564) he became his biographer and administrative successor. As a historian, Beza, by his chronological inexactitude, has been the source of serious mistakes; as an administrator, he softened the rigour of Calvin. His editions and Latin versions of the New Testament had a marked influence on the English versions of Geneva (1557 and 1560) and London (1611). The famous codex D. was presented by him (1581) to Cambridge University, with a characteristically dubious account of the history of the manuscript. His works are very numerous, but of little moment, except those already mentioned. He resigned his offices in 1600, and died on the 13th of October 1605. He had taken a second wife (1588), Catherine del Piano, a widow, but left no issue. He was not the author of the *Histoire ecclésiastique* (1580), sometimes ascribed

¹ Qui giace Arrigo Beyle Milanese: visse, scrisse, amò.

to him; nor, probably, of the vulgar skit published under the name of Benedict Panavantius (1551).

See Laingæus, *De Vita et Moribus* (1585, calumnious); Antoine la Faye, *De Vita et Obitu* (1606, eulogistic); Schlosser, *Leben* (1806); Baum, *Th. Beza*, portrait (1843-1851); Heppé, *Leben* (1861). (A. G. O.)

BEZANT or **BYZANT** (from Byzantium, the modern Constantinople), originally a Byzantine gold coin which had a wide circulation throughout Europe up to about 1250. Its average value was about nine shillings. Bezants were also issued in Flanders and Spain. Silver bezants, in value from one to two shillings, were in circulation in England in the 13th and 14th centuries. In Wycliffe's translation of the Bible he uses the word for a "talent" (e.g. in Luke xv. 8). In heraldry, bezants are represented by gold circles on the shield, and were introduced by the crusaders.

BEZANTÉE, in architecture, a name given to an ornamented moulding much used in the Norman period, resembling the coins (bezants) struck in Byzantium.

BEZBORODKO, ALEKSANDER ANDREEVICH, PRINCE (1747-1799), grand chancellor of Russia, was born at Gluchova on the 14th of March 1747, and educated at home and in the clerical academy at Kiev. He entered the public service as a clerk in the office of Count P. A. Rumyantsev, then governor-general of Little Russia, whom he accompanied to the Turkish War in 1768. He was present at the engagements of Larga and Kaluga, and at the storming of Silistria. On the conclusion of the peace of Kuchuk-Kainarji (1774) the field marshal recommended him to Catharine II., and she appointed him in 1775 her petition-secretary. He thus had the opportunity of impressing the empress with his brilliant gifts, the most remarkable of which were exquisite manners, a marvellous memory and a clear and pregnant style. At the same time he set to work to acquire the principal European languages, especially French, of which he became a master. It was at this time that he wrote his historical sketches of the Tatar wars and of Little Russia.

His activity was prodigious, and Catharine called him her factotum. In 1780 he accompanied her on her journey through White Russia, meeting the emperor Joseph, who urged him to study diplomacy. On his return from a delicate mission to Copenhagen, he presented to the empress "a memorial on political affairs" which comprised the first plan of a partition of Turkey between Russia and Austria. This document was transmitted almost word for word to Vienna as the Russian proposals. He followed this up by *Epitomised Historical Information concerning Moldavia*. For these two state papers he was rewarded with the posts of "plenipotentiary for all negotiations" in the foreign office and postmaster-general. From this time he was inseparably associated with Catharine in all important diplomatic affairs, though officially he was the subordinate of the vice-chancellor, Count Alexander Osterman. He wrote all the most important despatches to the Russian ministers abroad, concluded and subscribed all treaties, and performed all the functions of a secretary of state. He identified himself entirely with Catharine's political ideas, even with that of re-establishing the Greek empire under her grandson Constantine. The empress, as usual, richly rewarded her *comes* with pensions and principalities. In 1786 he was promoted to the senate, and it was through him that the empress communicated her will to that august state-decoration. In 1787 he accompanied Catharine on her triumphal progress through South Russia in the capacity of minister of foreign affairs. At Kaniev he conducted the negotiations with the Polish king, Stanislaus II., and at Novuiya Kaidaniya he was in the empress's carriage when she received Joseph II.

The second Turkish War (1787-92) and the war with Gustavus III. (1788-90) heaped fresh burdens on his already heavily laden shoulders, and he suffered from the intrigues of his numerous jealous rivals, including the empress's latest favourite, A. M. Mamonov. All his efforts were directed towards the conclusion of the two oppressive wars by an honourable peace. The pause of Verelá with Gustavus III. (14th of August 1790)

was on the terms dictated by him. On the sudden death of Potemkin he was despatched to Jassy to prevent the peace congress there from breaking up, and succeeded, in the face of all but insuperable difficulties, in concluding a treaty exceedingly advantageous to Russia (9th of January 1792). For this service he received the thanks of the empress, the ribbon of St Andrew and 50,000 roubles. On his return from Jassy, however, he found his confidential post of secretary of petitions occupied by the empress's last favourite, P. A. Zubov. He complained of this "diminution of his dignity" to the empress in a private memorial in the course of 1793. The empress reassured him by fresh honours and distinctions on the occasion of the solemn celebration of the peace of Jassy (2nd of September 1793), when she publicly presented him with a golden olive-branch encrusted with brilliants. Subsequently Catharine reconciled him with Zubov, and he resumed the conduct of foreign affairs. He contributed more than any other man to bring about the downfall and the third partition of Poland, for which he was magnificently recompensed. But diplomacy by no means exhausted Bezborodko's capacity for work. He had a large share in the internal administration also. He reformed the post-office, improved the banking system of Russia, regulated the finances, constructed roads, and united the Uniate and Orthodox churches.

On the death of Catharine, the emperor Paul entrusted Bezborodko with the examination of the late empress's private papers, and shortly afterwards made him a prince of the Russian empire, with a correspondingly splendid apanage. On the retirement of Osterman he received the highest dignity in the Russian empire—that of imperial chancellor. Bezborodko was the only Russian minister who retained the favour of Paul to the last. During the last two years of his life the control of Russia's diplomacy was entirely in his hands. His programme at this period was peace with all the European powers, revolutionary France included. But the emperor's growing aversion from this pacific policy induced the astute old minister to attempt to "seek safety in moral and physical repose." Paul, however, refused to accept his resignation and would have sent him abroad for the benefit of his health, had not a sudden stroke of paralysis prevented Bezborodko from taking advantage of his master's kindness. He died at St Petersburg on the 6th of April 1799. In private life Bezborodko was a typical Catharinian, corrupt, licentious, consciencless and self-seeking. But he was infinitely generous and affectionate, and spent his enormous fortune liberally. His banquets were magnificent, his collections of pictures and statues unique in Europe. He was the best friend of his innumerable poor relatives, and the Maecenas of all the struggling authors of his day. Sycophantic he might have been, but he was neither ungrateful nor vindictive. His patriotism is as indisputable as his genius.

See *Sbornik* (Collections) of the *Imperial Russian Historical Society* (Fr. and Russ.), vols. 60-100 (St Petersburg, 1870-1904); Nikolai Ivanovich Grigorovich, *The Chancellor A. A. Bezborodko in Connexion with the Events of His Time* (Rus. St Petersburg, 1879-1881). (R. N. B.)

BEZEL (from an O. Fr. word, cf. Mod. Fr. *biseau*, *basile*, possibly connected with Lat. *bis*, twice), a sloping edge, as of a cutting tool, also known as *basil*. In jewelry, the term is used for the oblique sides or faces of a gem; the rim which secures the crystal of a watch in position or a jewel in its setting, and particularly the enlarged part of a ring on which the device is engraved (see *RINGS*).

BÉZIERS, a town of southern France, capital of an arrondissement in the department of Hérault, 47 m. S.W. of Montpellier by rail. Pop. (1906) 46,262. Béziers is situated in a wine-growing district on a hill on the left bank of the river Orb, which is joined at this point by the Canal du Midi. The Allées Paul Riquet, named after the creator of the canal, occupy the centre of Béziers and divide the old town with its maze of narrow and irregular streets from the new quarter to the east. They form a long and shady promenade, terminating at one end in the Placc de la République and the theatre, the front of which is decorated with bas-reliefs by David d'Angers,

and at the other in a beautiful park, the Plateau des Poètes. The most interesting portion of the town is the extreme west where the old ramparts overlook the Orb. Above them towers St Nazaire, the finest of the churches of Béziers; it dates from the 12th to the 14th centuries and is a good specimen of the ecclesiastical fortification common in southern France. Its chief artistic features are the rose window in the western façade, and the stained glass and curious iron grilles of the choir-windows, which belong to the 14th century. Adjoining the south transept there are Gothic cloisters of the 14th century. The Orb is crossed by four bridges, the railway bridge, an ancient bridge of the 13th or 14th century, a modern bridge and the fine aqueduct by which the Canal du Midi is carried over the river. About half a mile to the south-west of the town are the locks of Fonserranes, in which in 330 yds. the water of the canal descends 80 ft. to reach the level of the Orb. There are remains of a Roman arena which have been built into the houses of the rue St Jacques. Béziers is seat of a sub-prefect and has tribunals of first instance and of commerce, communal colleges and several learned societies. It is an agricultural market and carries on an active trade in wine, brandy, fruit, leather and sulphur. Its industries are chiefly connected with the wine trade (cask and cork making, &c.) and there are important distilleries. It also has iron-works and tanneries.

The Romans established a colony at Béziers, and it was the headquarters of the seventh legion, under the title of *Baeterræ Septimanorum*. The present name occurs in the form *Besara* as early as Festus Avienus (later 4th century). The town was completely destroyed in 1209 by the forces of Simon de Montfort in the crusade against the Albigensens, on which occasion 20,000 persons were massacred. The walls were rebuilt in 1289; but the town again suffered severely in the civil and religious wars of the 16th century, and all its fortifications were destroyed in 1632.

BÉZIQUE (probably from Span. *besico*, little kiss, in allusion to the meeting of the queen and knave, an important feature in the game), a game at cards played with two similar packs from which the twos, threes, fours, fives and sixes have been rejected, shuffled together and used as one. It is modelled on a group of card games which possess many features in common; the oldest of these is *mariage*, then follow *brusquemille*, *l'homme de brou*, *briscan* or *brisque*, and *cing-cens*. Bézique (also called *besi* and *besique*) is, in fact, *brisque* played with a double pack, and with certain modifications rendered necessary by the introduction of additional cards. The cards rank as follows:—Ace, ten, king, queen, knave, nine, eight, seven.

The usual game is for two players. The players cut for deal, and the higher bézique card deals. The objects of the play are: (1) to promote in the hand various combinations of cards, which, when declared, entitle the holder to certain scores; (2) to win aces and tens, known as "brisques"; (3) to win the so-called last trick. The dealer deals eight cards to each, first three, then two, and again three. The top card of those remaining (called the "stock") is turned up for trumps. As sometimes played, the first marriage, or the first sequence, decides the trump suit; there is then no score for the seven of trumps (see below). The stock is placed face downwards between the players and slightly spread. The non-dealer leads any card, and the dealer plays to it, but need not follow suit, nor win the trick. If he wins the trick by playing a higher card of the same suit led, or a trump, the lead falls to him. In case of ties the leader wins. Whoever wins the trick leads to the next; but before playing again each player takes a card from the stock and adds it to his hand, the winner of the trick taking the top card. This alternate playing and drawing a card continues until the stock (including the trump card or card exchanged for it, which is taken up last) is exhausted. The tricks remain face upwards on the table, but must not be searched during the play of the hand.

The scores are shown as follows:—

Table of Dealer Scores.

<i>Sevens of trumps</i> , turned up, dealer marks	10
<i>Sevens of trumps</i> , declared (see below) or exchanged, player marks	10

<i>Marriage</i> (king and queen of any suit) declared	20
<i>Royal marriage</i> (king and queen of trumps) declared	40
<i>Bézique</i> (queen of spades and knave of diamonds) declared	40
<i>Double bézique</i> (all the four bézique cards) declared	500
<i>Four aces</i> (any four, whether duplicates or not) declared	100
<i>Four kings</i> (any four) declared	80
<i>Four queens</i> (any four) declared	60
<i>Four knaves</i> (any four) declared	40
<i>Sequence</i> (ace, ten, king, queen, knave of trumps) declared	250
<i>Aces and tens</i> , in tricks, the winner for each one marks	10
<i>Last trick</i> of all (as sometimes played, the last trick before the stock is exhausted) the winner marks	10

A "declaration" can only be made by the winner of a trick immediately after he has won it, and before he draws from the stock. It is effected by placing the declared cards (one of which at least must not have been declared before) face upwards on the table, where they are left, unless they are played, as they may be. A player is not bound to declare. A card led or played cannot be declared. More than one declaration may be made at a time, provided no card of one combination forms part of another that is declared with it. Thus four knaves and a marriage may be declared at the same time; but a player cannot declare king and queen of spades and knave of diamonds together to score marriage and bézique. He must first declare one combination, say bézique; and when he wins another trick he can score marriage by declaring the king. A declaration cannot be made of cards that have already all been declared. Thus, if four knaves (one being a bézique knave) and four queens (one being a bézique queen) have been declared, the knave and queen already declared cannot be declared again as bézique. To score all the combinations with these cards, after the knaves are declared and another trick won, bézique must next be made, after which, on winning another trick, the three queens can be added and four queens scored. Lastly, a card once declared can only be used again in declaring in combinations of a different class. For example: the bézique queen can be declared in bézique, marriage and four queens; but having once been declared in single bézique, she cannot form part of another single bézique. Two declarations may, in a sense, be made to a trick, but only one can be scored at the time. Thus with four kings declared, including the king of spades, bézique can be declared and scored, but the spade marriage cannot be scored till the holder wins another trick. The correct formula is "Forty, and 20 to score." The seven of trumps may be either declared or exchanged for the turn-up after winning a trick, and before drawing. When exchanged, the turn-up is taken into the player's hand, and the seven put in its place. The second seven can, of course, be declared. A seven when declared is not left on the table, but is simply shown.

The winner of the last trick can declare anything hitherto undeclared in his hand. After this all declarations cease. The winner of the last trick takes the last card of the stock, and the loser the turn-up card (or seven exchanged for it). All cards on the table, that have been declared and not played, are taken up by their owners. The last eight tricks are then played, but the second player must follow suit if able, and must win the trick if able. Finally, each player counts his tricks for the aces and tens they may contain, unless (as is often done) they are scored at the time. If a player revokes in the last eight tricks, or does not win the card led, if able, the last eight tricks belong to his adversary. The deal then passes on alternately until the game (1000) is won. If the loser does not make 500, his opponent counts a double game, or double points, according as they have agreed. The score is best kept by means of a special bézique-marker.

Three- and Four-Handed Bézique.—When three play, three packs are used together. All play against each other. The player on the left of the dealer is first dealt to and has the first lead. The rotation of dealing goes to the left. If double bézique has been scored, and one pair has been played, a second double bézique may be made with the third pair and the pair on the table. Triple bézique scores 1500. All the cards of the triple bézique must be on the table at the same time and unplayed to a trick. All may be declared together, or a double bézique may be added to a single one, or a third bézique may be added to a double bézique already declared. The game is 2000

up. Sometimes the three players cut, the one who cuts the highest card plays against the other two in consultation, and continues to do so till the allies win a game, when the two cut as before to see who shall be the single player. Only two packs are then used.

When four play four packs are used. The players may then score independently or may play as partners. A second double bézique or triple bézique may be scored as before; to form them the béziques may be declared from the hand of either partner. A player may declare when he or his partner takes a trick. In playing the last eight tricks, the winner of the last trick and the adversary to his left play their cards against each other, and then the other two similarly play theirs. Four people may also play in pairs by consultation, only two packs being then required.

Polish Bézique (also called "Open Bézique" and "Fildniski") differs from ordinary bézique in the following particulars. The game is not less than 2000 up. Whenever a scoring card is played, the winner of the trick places it face upwards in front of him (the same with both cards if two scoring cards are played to a trick), forming rows of aces, kings, queens, knaves and trump tens (called *open cards*). Cards of the same denomination are placed overlapping one another lengthwise from the player towards his adversary to economise space. When a scoring card is placed among the open cards, all the sevens, eights, nines, and plain suit tens in the tricks are turned down and put on one side. Open cards cannot be played a second time, and can only be used in declaring. Whether so used or not they remain face upwards on the table until the end of the hand, including the last eight tricks. A player can declare, i.e. place a trump card or cards, which added to his open cards complete any combination that scores. Every declaration must include a card played to the trick last won. Aces and tens must be scored as soon as won, and not at the end of the hand. The seven of trumps can be exchanged by the winner of the trick containing it; and if the turn-up card is one that can be used in declaring, it becomes an open card when exchanged. The seven of trumps when not exchanged is scored for by the player winning the trick containing it.

Compound declarations are allowed, i.e. cards added to the open cards can at once be used, without waiting to win another trick, in as many combinations of different classes as they will form with the winner's open cards. For example: A has three open kings, and declares a trick containing a king. Before drawing again he places the fourth king with the other three, and scores 80 for kings. This is a simple declaration. But suppose the card led was the queen of trumps, and A wins it with the king, and he has the following open cards—three kings, three queens, and ace, ten, knave of trumps. He at once declares royal marriage (40); four kings (80); four queens (60); and sequence (250); and scores in all, 430. Again: ace of spades is turned up, and ace of hearts is led. The second player has two open aces, and wins the ace of hearts with the seven of trumps and exchanges. He scores for the exchange, 10; for the ace of hearts, 10; for the ace of spades, 10; and adds the aces to his open cards, and scores 100 for aces; in all, 130. If a declaration or part of a compound declaration is omitted, and the winner of the trick draws again, he cannot amend his score.

The ordinary rule holds that a second declaration cannot be made of a card already declared in the same class. Thus: a queen once married cannot be married again; a fifth king added to four already declared does not entitle to another score for kings. The fundamental point to be borne in mind is, that no declaration can be effected by means of cards held in the hand. Thus: A having three open queens and a queen in hand cannot add it to his open cards. He must win another trick containing a queen, when he can declare queens. Declarations continue during the play of the last eight tricks just the same as during the play of the other cards.

Rubicon Bézique.—Four packs are used. Nine cards are dealt by the dealer to each player. The rate of Polish bézique hold good in regard to dealing, bidding, playing to lead, drawing and declaring; but a player who receives a hand containing no picture-card (king, queen, or knave) scores 50 for *carte blanche*, which he shows. If he does not draw a picture-card, he can again score for *carte blanche*. The trump suit is decided by the first sequence or marriage declared. As four packs are used, triple and quadruple bézique may be made. Triple bézique counts 1500, quadruple 4500. Tricks are left face upwards till a *brisque* (ace or ten) is played, when the winner takes all the played cards and puts them in a heap; their only value is the value of the *brisques*, which are only counted when the scores are very close; then they are used to decide the game. They may be counted during the play, provided there are not more than twelve cards in the hand. Declarations can only be made after winning a trick and before drawing. In addition to the ordinary bézique declarations, sequence, counting 150, can be made in plain suits. If the dealer, except *carte blanche*, remain on the table. If he holds of *carte blanche* hold four aces and wins the first trick, he can declare his aces. With the exceptions already made, the scores for declarations are the same as at ordinary bézique. Declaration is not compulsory. Cards led or played cannot be declared. There are three classes of declarations, their order being (1) marriage and sequence, (2) bézique, (3) fours. A card once declared can be used for a second declaration, but only in an equal or superior class. If a card of a declared com-

bination be played to a trick, another card of the same rank may be used to form a second similar combination; e.g. if aces be declared and one of them be played by the playing of a fifth ace, aces can be declared again. If a player has a chance of a double declaration he can declare both, but can only score one at the time. As in other variations of bézique he announces, say, "forty, and twenty to score." He should repeat, "Twenty to score," after every trick, until he can legally score it, but if he plays a card of the combination he cannot score the points. To the last nine tricks, after the stock is exhausted, the second player must follow suit and win the trick by trumping or over-playing, if he can. The winner of the odd trick scores 50. The game consists of one deal. In reckoning the score all fractions of 100 are neglected; the winner scores 500 for game in addition to the difference between his own points and his opponent's. The loser is "rubiconed" if he does not score 1000 points, in which case the winner adds the loser's points to his own, takes 300 for *brisques* and 1000 for game, but the loser may claim his *brisques* to save a rubicon, though they are not reckoned among his points. If a rubiconed player has scored less than 100 the opponent counts the score as 100.

BEZWADA, a town of British India, in the Kistna district of Madras, on the left bank of the river Kistna, at the head of its delta. Pop. (1901) 24,224. Here are the headquarters of the Kistna canal system, which irrigates more than 500,000 acres, and also provides navigation throughout the delta. The anicut or dam at Bezwada, begun in 1852, consists of a mass of rubble, fronted with masonry, 1240 yds. long. Here also is the central junction of the East Coast railway from Madras to Calcutta, 267 m. from Madras, where one branch line comes down from the Warangal coalfield in the Nizam's Dominions, and another from Bellary on the Southern Mahratta line. Ancient cuttings on the hills west of Bezwada have been held by some to mark the site of a Buddhist monastery; by others they are considered to have been quarries. At Undavalle to the south are some noted cave-shrines.

BHAGALPUR, a city of British India, in the Behar province of Bengal, which gives its name to a district and to a division; situated on the right bank of the Ganges, 265 m. from Calcutta. It is a station on the East Indian railway. Pop. (1901) 75,760, showing an increase of 9% in the decade. The chief educational institution is the Tejnarayan Jubilee college (1887), supported almost entirely by fees. Adjacent to the town are the two Augustus Cleveland monuments, one erected by government, and the other by the Hindus, to the memory of the civilian, who, as collector of Bhagalpur at the end of the 18th century, "by conciliation, confidence and benevolence, attempted and accomplished the entire subjection of the lawless and savage inhabitants of the Jungletery of Rajmahal."

The DISTRICT OF BHAGALPUR stretches across both banks of the Ganges. It has an area of 4226 sq. m. In 1901 the population was 2,088,953, showing an increase of 3% in the decade. Bhagalpur is a long and narrow district, divided into two unequal parts by the river Ganges. In the southern portion of the district the scenery in parts of the hill-ranges and the highlands which connect them is very beautiful. The hills are of primary formation, with fine masses of contorted gneiss. The ground is broken up into picturesque gorges and deep ravines, and the whole is covered with fine forest trees and a rich undergrowth. Within this portion also lie the lowlands of Bhagalpur, fertile, well planted, well watered, and highly cultivated. The country north of the Ganges is level, but beautifully diversified with trees and verdure. Three fine rivers flow through the district—the Ganges, Kusi and Ghagri. The Ganges runs a course of 60 m. through Bhagalpur, is navigable all the year round, and has an average width of 3 m. The Kusi rises in the Himalayas and falls into the Ganges near Colgong within Bhagalpur. It is a fine stream, navigable up to the foot of the hills, and receives the Ghagri 8 m. above its debouchure.

In the early days of British administration the hill people, the Nats and Santals, gave much trouble. They were the original inhabitants of the country whom the Aryan conquerors had driven back into the barren hills and unhealthy forests. This they avenged from generation to generation by plundering and ravaging the plains. The efforts to subdue or restrain these marauders proved fruitless, till Augustus Cleveland won them by mild measures, and successfully made over the protection of the

district to the very hill people who a few years before had been its scourge. Rice, wheat, barley, oats, Indian corn, various kinds of millet, pulses, oil-seeds, tobacco, cotton, indigo, opium, flax and hemp and sugar-cane, are the principal agricultural products of Bhagalpur district. The jungles afford good pasturage in the hot weather, and abound in lac, silk cocoons, catechu, resin and the *mahuā* fruit, which is both used as fruit and for the manufacture of spirits. Lead ores (chiefly argentiferous galena) and building stone are found, and iron ore is distributed over the hilly country. Attempts made to work the galena in 1878-79 and 1900 were abandoned, and the iron ore is little worked. Gold is washed from the river sand in small particles.

The climate of Bhagalpur partakes of the character both of the deltaic districts of Bengal and of the districts of Behar, between which it is situated. The hot season sets in about the end of March, and continues till the beginning of June, the temperature at this time rising as high as 110° Fahr. The rains usually begin at the end of June and last till the middle of September; average annual rainfall, 55 in. The cold season commences at the beginning of November and lasts till March. During December and January the temperature falls as low as 41° Fahr. The average annual temperature is 78°. Bhagalpur formed a part of the ancient Sanskrit kingdom of Anga. In later times it was included in the powerful Hindu kingdom of Magadha or Behar, and in the 7th century A.D. it was an independent state, with the city of Champa for its capital. It afterwards formed a part of the Mahomedan kingdom of Gaur, and was subsequently subjugated by Akbar, who declared it to be a part of the Delhi empire. Bhagalpur passed to the East India Company by the grant of the emperor Shah Alam in 1765.

There are indigo factories, and other industries include the weaving of tussur silk and the making of coarse glass. A large trade is carried on by rail and river with Lower Bengal. The tract south of the Ganges is traversed by the loop-line of the East Indian railway, and there is also a railway across the northern tract.

THE DIVISION OF BHAGALPUR stretches across the Ganges from the Nepal frontier to the hills of Chota Nagpur. It comprises the five districts of Monghyr, Bhagalpur, Purnea, Darjeeling, and the Santal Parganas. The total area is 19,776 sq. m.; and in 1901 the population was 8,091,405.

BHAMO, a town and district of Burma. The town was in ancient times the capital of the Shan state of Manmaw, later the seat of a Burmese governor. It is now the headquarters of a district in the Mandalay division of Upper Burma (Chinese frontier). It is situated about 300 m. up the river from Mandalay. It is the highest station on the Irrawaddy held by British troops, and the nearest point on the river to the Chinese frontier. In 1901 it contained 10,734 inhabitants, of whom a considerable number were Chinamen, natives of India and Shan-Chinese. It stretches for a distance of nearly 4 m. along the Irrawaddy bank in a series of small villages, transformed into quarters of the town, but the town proper is confined mainly to the one high ridge of land running at right angles to the river. The surface of the ground is much cut up by ravines which fill and dry up according to the rise and fall of the river. When the Irrawaddy is at its height the lower portion of the town is flooded, and the country all round is a sheet of water, but usually for no very long time. Here or hereabouts has long been the terminus of a great deal of the land commerce from China. For years after its annexation by Great Britain in 1885 the trade routes were unsafe owing to attacks from Kachins. These have now ceased, and the roads, which were mere bridle-tracks, have been greatly improved. The two chief are the so-called Santa and Ponaing route, through Manyün (Manwaing) and Nantien to Momein, and the southern or Sawadi route by way of Namhkam. Cart roads are now being constructed on both routes, and that south of the Taiping river could easily be continued through Manyün to Momein if the Chinese should be induced to co-operate. There is a fairly large military garrison in Bhamo distributed between two forts to the north and east of the town. There are in general stationed here a native regiment, two sections of

a battery and the wing of a European regiment. Besides the barracks there are a circuit house, dāk bungalow, courthouse, and post and telegraph offices. There is a branch railway from Myitkyina to Katha, whence there is daily communication by river to Bhamo.

THE DISTRICT OF BHAMO lies wholly in the basin of the Irrawaddy, which, as well as its tributaries, runs through the heart of it. On the east of the river is the Shan plateau, running almost due north and south. West of the Irrawaddy there is a regular series of ranges, enclosing the basins of the Kaukkwe, Mosit, Indaw and other streams, down which much timber is floated. Beyond the Kaukkwe there is a ridge of hills, which starts at Leka, near Mogaung, and diverges to the south, the eastern ridge dividing the Kaukkwe from the Mosit, and the western forming the eastern watershed of the Nam Yin and running south into Katha. It is an offshoot from the latter of these ridges that forms the third defile of the Irrawaddy between Bhamo and Sinbo. The district covers an area of 4146 sq. m., and the population in 1901 was 79,515. It is mainly composed of Shan-Burmese and Kachins. The Shan-Burmese inhabit the valleys and alluvial plains on each side of the river. The Kachins, who probably came from the sub-regions of the Himalayas, occupy the hills throughout the district. There are also settlements of Shans, Shan-Chinese, Chinese and Assamese. There are extensive fisheries in the Shwegu and Mo-hyin circles, and in the Indaw, a chain of lakes just behind the Mosit, opposite Shwegu. The district abounds in rich teak forests, and there are reserves representing 60,000 acres of teak plantation. The whole of the country along the banks of the Irrawaddy, the Mole, Taiping and Kaukkwe, is generally in a water-logged condition during the rains. The climate in the district is therefore decidedly malarious, especially at the beginning and end of the rains. From November to March there is very bracing cold weather. The highest temperatures range a few degrees over 100° F. up to 106°, and the lowest a few degrees under 40°. The average maximum for the year is about 87°, the average minimum about 62°. The rainfall averages 72 in. a year. (J. G. S.)

BHANDARA, a town and district of British India, in the Nagpur division of the Central Provinces. The town (pop. in 1901, 14,023) is situated on the left bank of the river Wainganga, 7 m. from a station on the Bengal-Nagpur railway. It has considerable manufactures of cotton cloth and brass-ware, and a first-grade middle school, with a library.

THE DISTRICT OF BHANDARA has an area of 3965 sq. m. In 1901 the population was 663,062, showing a decrease of 11 % since 1891 compared with an increase of 8 % in the preceding decade. The district is bounded on the N., N.E. and E. by lofty hills, inhabited by Gonds and other aboriginal tribes, while the W. and N.W. are comparatively open. Small branches of the Satpura range make their way into the interior of the district. The Ambagarh or Sendurjhar hills, which skirt the south of the Chandpur pargana, have an average height of between 300 and 400 ft. above the level of the plain. The other elevated tracts are the Balahi hills, the Kanheri hills and the Nawegaon hills. The Wainganga is the principal river in the district, and the only stream that does not dry up in the hot weather,—its affluents within the district being the Bawanthari, Bagh, Kanhan and Chulban. There are 3648 small lakes and tanks in Bhandara district, whence it is called the "lake region of Nagpur"; they afford ample means of irrigation. More than one-third of the district lies under jungle, which yields gum, medicinal fruit and nuts, edible fruits, lac, honey and the blossoms of the *mahuā* tree (*Bassia latifolia*), which are eaten by the poorer classes, and used for the manufacture of a kind of spirit. Tigers, panthers, deer, wild hogs and other wild animals abound in the forests, and during the rainy season many deaths occur from snake-bites. Iron is the chief mineral product. Gold is also found in the bed of the Sone river. Laterite, shale and sandstone occur all over the district. Native cloth, brass wares, pot-stone wares, cartwheels, straw and reed baskets, and a small quantity of silk, form the only manufactures. The principal crops are rice, wheat, millet, other food-grains,

pulse, linseed, and a little sugar-cane. The district is traversed by the main road from Nagpur to the east, and also by the Bengal-Nagpur railway. It suffered in the famine of 1806-1807, and yet more severely in 1900.

Bhandara district contains 25 semi-independent chieftains. These little states are exempted from the revenue system, and only pay a light tribute. Their territory, however, is included within the returns of area and population above given. The climate of Bhandara is unhealthy,—the prevailing diseases being fever, small-pox and cholera. Nothing is known of the early history of the district. Tradition says that at a remote period a tribe of men, called the Gaulis or Gaulars, overran and conquered it. At the end of the 17th century it belonged to the Gond raja of Deogarh. In 1743 it was conquered by the Mahrattas, who governed it till 1853, when it lapsed to the British government, the raja of Nagpur having died without an heir.

BHANG, an East Indian name for the hemp plant, *Cannabis sativa* (see HEMP), but applied specially to the leaves dried and prepared for use as a narcotic drug. In India the products of the plant for use as a narcotic and intoxicant are recognized under the three names and forms of Bhang, Gunja or Ganja, and Churrus or Charas. Bhang consists of the larger leaves and capsules of the plant on which an efflorescence of resinous matter has occurred. The leaves are in broken and partly agglutinated pieces, having a dark-green colour and a heavy but not unpleasant smell. Bhang is used in India for smoking, with or without tobacco; it is prepared in the form of a cake or manjan, and it is made into an intoxicating beverage by infusing in cold water and straining. Gunja is the flowering or fruit-bearing tops of the female plants. It is gathered in stalks of several inches in length, the tops of which form a matted mass, from the agglutination of flowers, seeds and leaflets by the abundant resinous exudation which coats them. Churrus is the crude resinous substance separated from the plant. The use of preparations of hemp among the Mussulman and Hindu population of India is very general; and the habit also obtains among the population of central Asia, the Arabs and Egyptians, extending even to the negroes of the valley of the Zambezi and the Hottentots of South Africa. The habit appears to date from very remote times, for Herodotus says of the Scythians, that they creep inside huts and throw hemp seeds on hot stones.

BHARAHAT, or **BARHUT**, a village in the small state of Nagod in India, lying about $24^{\circ} 15' N.$ by $80^{\circ} 45' E.$, about 120 m. S.W. of Allahabad. General A. Cunningham discovered there in 1873 the remains of a *stupa* (i.e. a burial mound over the ashes of some distinguished person) which were excavated, in 1874, by his assistant, J. D. Beglar. The results showed that it must have been one of the most imposing and handsome in India; and it is especially important now from the large number of inscriptions found upon it. The ancient name of the place has not been yet traced, but it must have been a considerable city and its site lay on the high road between the ancient capitals of Ujjeni and Kosambi. The *stupa* was circular, 70 ft. in diameter and 42 ft. high. It was surrounded by a stone railing 100 ft. in diameter, so that between railing and *stupa* there was an open circle round which visitors could walk; and the whole stood towards the east side of a paved quadrangle about 300 ft. by 320 ft., surrounded by a stone wall. On the top of the *stupa* was an ornament shaped like the letter T, and as the base of the *stupa* was above the quadrangle, the total height of the monument was between 50 and 60 ft. But its main interest, to us, lies in the railing. This consisted of eighty square pillars, 7 ft. 1 in. in height, connected by cross-bars about 1 ft. broad. Both pillars and cross-bars were elaborately carved in bas-relief, and most of them bore inscriptions giving either the name of the donor, or the subject of the bas-relief, or both. There were four entrances through the railing, facing the cardinal points, and each one protected by the railing coming out at right angles, and then turning back across it in the shape of the letter L. This gave the whole ground plan of the monument, and no doubt designedly so, the shape of a gigantic *swastika*

(i.e. a symbol of good fortune). By the forms of the letters of the inscriptions, and by the architectural details, the age of the monument has been approximately fixed in the 3rd century B.C. The bas-reliefs give us invaluable evidence of the literature, and also of the clothing, buildings and other details of the social conditions of the peoples of Buddhist India at that period. The subjects are taken from the Buddhist sacred books, more especially from the accounts given in them of the life of the Buddha in his last or in his previous births. Unfortunately, only about half the pillars, and about one-third of the cross-bars have been recovered. When the *stupa* was discovered the villagers had already carried off the greater part of the monument to build their cottages with the stones and bricks of it. The process has gone on till now nothing is left except what General Cunningham found and rescued and carried off to Calcutta. Even the mere money value of the lost pieces must be immense, and among them is the central relic box, which would have told us in whose honour the monument was put up.

See A. Cunningham, *The Stupa of Bharhut* (London, 1879); T. W. Rhys Davids, *Buddhist India* (London, 1903). (T. W. R. D.)

BHARAL, the Tatar name for the "blue sheep" *Ovis* (Pseudois) *nahura*, of Ladak and Tibet. The general colour is blue-grey with black "points" and white markings and belly; and the horns of the rams are olive-brown and nearly smooth, with a characteristic backward curvature. In the absence of face-lands, as well as in certain other features, the bharal serves to connect more typical sheep (*q.v.*) with goats.

BHARATPUR, or **BHURTPORE**, a native state of India, in the Rajputana agency. Its area covers 1982 sq. m. The country is generally level, about 700 ft. above the sea. Small detached hills, rising to 200 ft. in height, occur, especially in the northern part. These hills contain good building stone for ornamental architecture, and in some of them iron ore is abundant. The Banganga is the only river which flows through the state. It takes its rise at Manoharpur in the territory of Jaipur, and flowing eastward passes through the heart of the Bharatpur state, and joins the Jamna below Agra.

Bharatpur rose into importance under Suraj Mall, who bore a conspicuous part in the destruction of the Delhi empire. Having built the forts of Dig and Kumber in 1730, he received in 1756 the title of raja, and subsequently joined the great Mahratta army with 30,000 troops. But the misconduct of the Mahratta leader induced him to abandon the confederacy, just in time to escape the murderous defeat at Panipat. Suraj Mall raised the Jat power to its highest point; and Colonel Dow, in 1770, estimated the raja's revenue (perhaps extravagantly) at £2,000,000 and his military force at 60,000 or 70,000 men. In 1803 the East India Company concluded a treaty, offensive and defensive, with Bharatpur. In 1804, however, the raja assisted the Mahrattas against the British. The English under Lord Lake captured the fort of Dig and besieged Bharatpur, but were compelled to raise the siege after four attempts at storming. A treaty, concluded on the 17th of April 1805, guaranteed the raja's territory; but he became bound to pay £200,000 as indemnity to the East India Company. A dispute as to the right of the succession again led to a war in 1825, and Lord Combermere captured Bharatpur with a besieging force of 20,000 men, after a desperate resistance, on the 18th of January 1826. The fortifications were dismantled, the hostile chief being deported to Benares, and an infant son of the former raja installed under a treaty favourable to the company. In 1853 the Bharatpur ruler died, leaving a minor heir. The state came under British management, and the administration was improved, the revenue increased, a system of irrigation developed, new tanks and wells constructed and an excellent system of roads and public buildings organized. Owing to the hot winds blowing from Rajputana, the climate of Bharatpur is extremely sultry till the setting in of the periodical rains.

In 1901 the population was 626,665, a decrease of 2%. The estimated revenue is £180,000. The maharaja Ram Singh, who succeeded his father in 1893, was deprived of power of government

in 1805 on the ground of intemperate conduct; and in 1900 was finally deposed for the murder of one of his personal attendants. He was succeeded by his infant son Kishen Singh. During his minority the administration was undertaken by a native minister, together with a state council, under the general superintendence of the political agent. Imperial service cavalry are maintained. The state is traversed for about 40 m. by the Rajputana railway.

The CITY OF BHARATPUR is 34 m. W. of Agra by rail. The population in 1901 was 43,601, showing a decrease of over 23,000 in the decade. The immense mud ramparts still stand. It has a handsome palace, a new hospital and a high school. There are special manufactures of *chauris*, or flappers, with handles of sandalwood, ivory or silver, and tails also made of strips of ivory or sandalwood as fine as horse-hair.

BHATGAON, a town of Nepal, 8 m. from Khatmandu. It is a celebrated place of Hindu superstition, the favourite residence of the Brahmans of Nepal, and contains more families of that order than either Khatmandu or Patan. It has a population of about 30,000, and its palace and buildings generally are of a more striking appearance than in other Nepalese towns. The town is said to possess many Sanskrit libraries.

BHATTIANA, a tract of country in the Punjab province of India, covering the Ghaggar valley from Fatehabad in the district of Hissar to Bhatnair in Bikanir. It derives its name from the Bhattis, a wild Rajput clan, who held the country lying between Hariana, Bikanir and Bahawalpur. It skirts the borders of the great sandy desert, and only contains a small and scattered population. This tract was ravaged by Timur in his invasion of India; and in 1795 paid a nominal allegiance to George Thomas, the adventurer of Hariana. After the victories of Lord Lake in 1803 it passed with the rest of the Delhi territory under British rule, but was not settled until 1810. A district of Bhattiana was formed in 1837, but in 1858 it was merged in the Sirsa district, which was divided up in 1884. The Bhattis number some 350,000, and are a fine tall race, making capital soldiers.

BHAU DAJI (RAMKRISHNA VITHAL) (1822-1874), Hindu physician of Bombay, Sanskrit scholar and antiquary, was born in 1822 at the village of Manjare, in the native state of Sawant-wari, of humble parents dealing in clay dolls. Dr Bhau's career is a striking instance of great results arising from small accidents. An Englishman noticing his cleverness at chess induced his father to give the boy an English education. Accordingly Bhau was brought to Bombay and was educated at the Elphinstone Institution. He relieved his father of the cost of his education by winning many prizes and scholarships, and on his father's death two years later he cheerfully undertook the burden of supporting his mother and a brother (Narayan), who also in after-life became a distinguished physician and surgeon. About this time he gained a prize for an essay on infanticide, and was appointed a teacher in the Elphinstone Institution. He began to devote his time to the study of Indian antiquities, deciphering inscriptions and ascertaining the dates and history of ancient Sanskrit authors. He then studied at the Grant Medical College, and was one of the first batch who graduated there in 1850. In 1851 he set up as a medical practitioner in Bombay, where his success was so great that he soon made a fortune. He studied the Sanskrit literature of medicine, and also tested the value of drugs to which the ancient Hindus ascribed marvellous powers, among other pathological subjects of historical interest investigating that of leprosy. Being an ardent promoter of education, he was appointed a member of the board of education, and was one of the original fellows of the university of Bombay. As the first native president of the students' literary and scientific society, and the champion of the cause of female education, a girls' school was founded in his name, for which an endowment was provided by his friends and admirers. In the political progress of India he took a great and active interest, and the Bombay Association and the Bombay branch of the East Indian Association owe their existence to his ability and exertions. He was twice chosen sheriff of Bombay, in 1869 and 1871.

Various scientific societies in England, France, Germany and America conferred on him their membership. He contributed numerous papers to the journal of the Bombay branch of the Royal Asiatic Society. He found time to make a large collection of rare ancient Sanskrit manuscripts at great cost and trouble. He died in May 1874. His brother, Dr Narayan Daji (who helped him to set up the charitable dispensary in Bombay), did not long survive him. Dr Bhau was a man of the most simple and amiable character and manners; his kindness and sympathy towards the poor and distressed were unbounded, and endeared his memory among the Hindus of Bombay. (N. B. W.)

BHAUNAGAR, or BHAVNAGAR, a native state of India in the Kathiawar agency, Bombay. Its area covers 2860 sq. m. In 1901 the population was 412,664, showing a decrease of 12% in the decade; the estimated revenue is £255,800, and the tribute £10,300. The chief, whose title is thakor sahib, is head of the famous clan of the Gohel Rajputs of Kathiawar. The enlightened system of administration formed during the rule of the thakor sahib maharaja Sir Takhtsinghi Jawsatsinghi, G.C.S.I., was continued with admirable results under the personal supervision of his son, the maharaja Bhausinghi, K.C.S.I. (b. 1875), and forms a model for other native states. The Gohel Rajputs are said to have settled in the district about 1260. Bhaunagar suffered terribly from the famine of 1899-1900. About 60 m. of the Bhaunagar-Gondal railway run through the state, with its terminus at the town of Bhaunagar, which is the principal port. The town of Bhaunagar is situated on the west coast of the gulf of Cambay. The population in 1901 was 56,442. It is the chief port in Kathiawar, though only admitting vessels of small burden. It was founded in 1723 by the thakor sahib Bhausinghi, after whom it is named, in place of his former capital, Sihor, which was considered too exposed to the Mahratra power.

BHEESTY (from the Persian *bihisti*, paradise), the Hindustani name for a water carrier, the native who supplies water from a pigskin or goat-skin bag.

BHERA, a town of British India, in the Shahpur district of the Punjab, situated on the river Jhelum. Pop. (1901) 18,680. It is the terminus of a branch of the North-Western railway. It is an important centre of trade, with manufactures of cotton goods, metal-work, carving, &c. Bhera was founded about 1540 on its present site, but it took the place of a city on the opposite bank of the river, of far greater antiquity, which was destroyed at this period.

BHILS, or BHEELS ("bowmen," from Dravidian *bil*, a bow), a Dravidian people of central India, probably aborigines of Marwar. They live scattered over a great part of India. They are found as far north as the Aravalli Hills, in Sind and Rajputana, as well as Khandesh and Ahmedabad. They are mentioned in Sanskrit works, and it is thought that Ptolemy (vii. i. 66) refers to them as *Φυλάκται* ("leaf wearers"), though this word might equally apply to the Gonds. Expelled by the Aryans from the richer lowlands, they are found to-day in greatest numbers on the hills of central India. In many Rajput states the princes on succession have their foreheads marked with blood from the thumb or toe of a Bhil. The Rajputs declare this a mark of Bhil allegiance, but it is more probably a relic of days when the Bhils were a power in India. The Bhils eagerly keep the practice alive, and the right of giving the blood is hereditary in certain families. The popular legend of the Bhil origin assigns them a semi-divine birth, Mahadeva (Siva) having wedded an earth maiden who bore him children, the ugliest of whom killed his father's bull and was banished to the mountains. The Bhils of to-day claim to be his descendants. Under the Moguls the Bhils were submissive, but they rebelled against the Mahratras, who, being unable to subdue them, treated them with the utmost cruelty. The race became outlaws, and they have lived their present wild life ever since. Their nomad habits and skill with their bows helped them to maintain successfully the fight with their oppressors. An unsuccessful attempt was made in 1818 by the British to conquer them. Milder measures were then tried, and the Bhil Agency was formed in 1825. The Bhil corps was then organized

with a view to utilizing the excellent fighting qualities of the tribesmen. This corps has done good service in gradually reducing their more lawless countrymen to habits of order, and many Bhils are now settled in regular industries.

The pure Bhil is to-day much what he has always been, a savage forest dweller. The Bhils are a stunted race, but well built, active and strong, of a black colour, with high cheek-bones, wide nostrils, broad noses and coarse features. Like all Dravidians the hair is long and wavy. The lowland Bhils are not now easily distinguished from the low-caste Hindus. Surgeon-major T. H. Hendley writes:—"The Bhil is an excellent woodman, knows the shortest cuts over the hills; can walk the roughest paths and climb the steepest crags without slipping or feeling distressed. Though robbers, and timorous owing to ages of ill-treatment, the men are brave when trusted, and very faithful. History proves them always to have been faithful to their nominal Rajput sovereigns, especially in their adversity. The Bhil is a merry soul, loving a jest." The hill Bhils wear nothing but a loin-cloth, their women a coarse robe; lowland Bhils wear turban, coat and waist-cloth. The Bhils have oaths none of them will break. The most sacred is that sworn by a dog, the Bhil praying that the curse of a dog may fall on him if he breaks his word. Their chief divinity is Hanuman, the monkey-god. Offerings are made to the much-feared goddess of smallpox. Stone worship is found among them, and some lowland Bhils are Moslems, while many have adopted Hinduism.

The Bhils of pure blood number upwards of a million, and there are some 200,000 Bhils of mixed descent.

See Gustav Oppert, *The Original Inhabitants of India* (1893); T. H. Hendley, "Account of Marwar Bhils," in *Bengal Asiatic Journal*, vol. 44; W. I. Sinclair in *Indian Antiquary*, vol. iv. pp. 336-338; Col. W. Kincaid, "On the Bheel Tribes of the Vindhyan Range," *Jour. Anthropol. Institute*, vol. ix.

BHIMA (Sanskrit, "The Terrible"), in Hindu mythology, a hero, one of the Pandava princes who figure in the *Mahabharata*. He was distinguished by his huge body, strength and voracity.

BHIWANI, a town of British India, in the Hissar district of the Punjab, 38 m. S.E. of Hissar town by rail. Pop. (1901) 35,017. It is an important centre of trade with Rajputana, and has factories for ginning and pressing cotton, and metal manufactures. Its rise dates from 1817, when it was made a free market.

BHOPAL, a native state of India, in the central India agency. Its area is 6902 sq. m., and its population in 1901 was 665,061, showing a decrease of 30% in the decade. This seems to be in part due to a difference in nomenclature, but the state suffered heavily from famine in 1896-1897 and 1899-1900. Bhopal is the principal Mussulman state in central India, ranking next to Hyderabad among the Mahomedan states of India. The surface of the country is uneven, being traversed by the Vindhya ranges, a peak of which near Rayson is upwards of 2500 ft. above sea-level. The general inclination of the country is towards the north, in which direction most of the streams of the state flow, while others, passing through the Vindhya ranges, flow to the Nerbudda.

Bhopal state was founded in 1723 by Dost Mahommed Khan, an Afghan adventurer. In 1778, when General Thomas Goddard made his bold march across India, the state of Bhopal was the only Indian power that showed itself friendly; and in 1809 when another British expedition under General Close appeared in the same parts, the nawab of Bhopal petitioned earnestly but in vain to be received under British protection. But in 1817, at the outbreak of the Pindari War, a treaty of dependence was concluded between the chief and the British government. Since then Bhopal has been steadily loyal to the British government, and during the Mutiny it rendered good services. The throne has descended in the female line since 1844, when Sikandar Begum became ruler. Succeeding begums have taken a great interest in the work of governing the state, which they carried on with marked success. The sultan Jahan Begum, succeeded on the death of her mother, Shah Jahan Begum, in June 1901, being the only female ruler in India.

The estimated revenue of the state is £250,000, and the state

pays a subsidy of £13,000 for the Bhopal battalion. Besides the Bhopal battalion, a regiment of imperial service cavalry is maintained, under the name of the Victoria Lancers. There is a branch railway from Itarsi to Bhopal city, continued to Jhansi. The British currency has been introduced, and in 1897-1898, Rs. 71,00,000 of Bhopali coins were converted. The residence of the political agent and the headquarters of the Bhopal battalion are at Sehore, 20 m. west of Bhopal city. The city of Bhopal, a railway station, had a population in 1901 of 76,561. The palace, with its rock fortress, is called Fatehgarh. An excellent water-supply has been provided from two large artificial lakes. There are two hospitals. There is an export trade in opium.

BHOPAL AGENCY, an administrative section of central India, takes its name from the state of Bhopal, which is included in it. The Bhopal agency is administered by the agent to the governor-general in central India. Its area is 11,653 sq. m., and its population in 1901 was 1,157,607. It was created in 1818. In 1900 this district suffered severely from famine owing to the complete failure of the monsoon, and the cultivated area decreased by 50 or 60%; but, on the whole, trade has improved of late years owing to the new railways, which have stimulated commerce and created fresh centres of industry.

BHOPAWAR, an agency in central India. It consists of the Dhar and Barwani states, three minor states, Ali Rajpur, Jhabua and Jobat, and a number of districts and estates. Its total area is 7684 sq. m., and its population on this area in 1901 was 547,546. But in 1901 and 1904 certain districts were transferred from this agency to the Indore residency, created in 1899, and the area of Bhopawar was thus reduced by 3283 sq. m. The chief towns are Dhar (pop. 17,792), Barwani (6277) and Kukshi (5402).

BHOR, a native state of India, in the Poona political agency, Bombay, forming one of the Satara Jagirs; situated among the higher peaks of the Western Ghats. Its area covers 925 sq. m. The population in 1901 was 137,268, showing a decrease of 12% in the decade; the estimated gross revenue is £21,437; the tribute, £310. The chief, whose title is *pati sachiv*, is a Brahman by caste. The town of BHOR is 25 m. south of Poona. In 1901 the population was 4178. The Bhor Ghat, on the northern border of the state, has always been the main pass over the Western Ghats, or means of communication between the sea-coast and the Deccan. Since 1861 it has been traversed by the main line of the Great Indian Peninsula railway.

BHUJ, a town of India, the capital of the native state of Kach, in the Gujarat division of Bombay, situated at the base of a fortified hill. Pop. (1901) 26,362. It contains some interesting examples of architecture of the middle of the 16th century and later; it was a place sacred to the snake-god Bhujanga.

BHUTAN, an independent kingdom in the Eastern Himalayas, lying between the Brahmaputra and the southern face of the mountains. It is under various commercial and other arrangements with the government of India, from whom it receives an annual subsidy of £3333. It is bounded on the N. by Tibet; on the E. by a tract inhabited by various uncivilized independent mountain tribes; on the S. by the British province of Assam, and the district of Jalpaiguri; and on the W. by the independent native state of Sikkim. The whole of Bhutan presents a succession of lofty and rugged mountains abounding in picturesque and sublime scenery. This alpine region sends out numerous rivers in a southerly direction, which, forcing their passage through narrow defiles, and precipitated in cataracts over the precipices, eventually pour themselves into the Brahmaputra. Of the rivers traversing Bhutan, the most considerable is the Manas, flowing in its progress to the Brahmaputra under the walls of Tasegaon, below which it is unfordable. At the foot of Tasegaon Hill it is crossed by a suspension bridge. The other principal rivers are the Machu, Tchinchu, Torsha, Manchi and Dharla. Information respecting the country accumulates but slowly. In 1863 Captain Godwin Austen accompanied Sir Ashley Eden's mission to the court of the Deb raja, and made a survey of the route to Punakha. There has also been a certain amount of geographical sketching combined with trigonometrical

observations; and there are the route surveys of native explorers. In 1887-1888 two native Indian explorers "R. N." and "P. A." traversed a part of Western Bhutan, but were forced to retire owing to the disturbed state of the districts. They re-entered the country on the east from Dewangiri. Here they explored the Kuru, or Lhobrak Chu, which proves to be the largest river in Bhutan. It drains the tract between the Yamdok Tso and Tigu Lakes, and is fed by the glaciers of the Kulha Kangri and other great ranges. The Lhobrak was finally identified with the Manas river, a geographical discovery of some importance. A previously unknown tribe, the Chingmis, were discovered in Eastern Bhutan, who are socially on a higher level than the Bhutias, and differ from them chiefly in the matter of wearing pigtails. Some excellent survey work was done in Bhutan by a native surveyor during the progress of the Tibetan Expedition in 1904. The Monla Kachung pass (17,500 ft.), by which "R. N." crossed into Tibet, is nearly on the meridian of Gualpara, and is one of the most important passes between Bhutan and Tibet. East of Bhutan, amongst the semi-independent hill states which sometimes own allegiance to Tibet and sometimes assert complete freedom from all authority, the geographical puzzle of the course of the Tsanpo, the great river of Tibet, has been solved by the researches of Captain Harman, and the explorations of the native surveyor "K. P." The Tsanpo has been definitely ascertained to be the same river as the Brahmaputra. The tracts inhabited by the aboriginal tribes entitled Lo Nakpo, Lo Karpo and Lo Tawa ("Lo" signifies "barbarous" in Tibetan), are described as a pleasant country; the lands on either side of the Tsanpo being well cultivated and planted with mangoes, plantains and oranges.

Nothing is known certainly about the area and population of Bhutan, the former being estimated at 16,800 sq. m. At the head of the Bhutan government there are nominally two supreme authorities, the Dharm raja, the spiritual head, and the Deb raja, the temporal ruler. Recently official correspondence has been written in the name of the Dharm raja, but it is not known whether this change really signifies anything. To aid these rajas in administering the country, there is a council of permanent ministers, called the Lenehen. Practically, however, there is no government at all. Subordinate officers and rapacious governors of forts wield all the power of the state, and tyranny, oppression and anarchy reign over the whole country. The Dharm raja succeeds as an incarnation of the deity. On the death of a Dharm raja a year or two elapses, and the new incarnation then reappears in the shape of a child who generally happens to be born in the family of a principal officer. The child establishes his identity by recognizing the cooking utensils, &c., of the late Dharm raja; he is then trained in a monastery, and on attaining his majority is recognized as raja, though he exercises no more real authority in his majority than he did in his infancy. The Deb raja is in theory elected by the council. In practice he is merely the nominee of whichever of the two governors of East and West Bhutan happens for the time to be the more powerful. The people are industrious, and devote themselves to agriculture, but from the geological structure of the country, and from the insecurity of property, regular husbandry is limited to comparatively few spots. The people are oppressed and poor. "Nothing that a Bhutia possesses is his own," wrote the British envoy in 1864; "he is at all times liable to lose it if it attracts the cupidity of any one more powerful than himself. The lower classes, whether villagers or public servants, are little better than the slaves of higher officials. In regard to them no rights of property are observed, and they have at once to surrender anything that is demanded of them. There never was, I fancy, a country in which the doctrine of 'might is right' formed more completely the whole and sole law and custom of the land than it does in Bhutan. No official receives a salary; he has certain districts made over to him, and he may get what he can out of them; a certain portion of his gains he is compelled to send to the durbar; and the more he extorts and the more he sends to his superior, the longer his tenure of office is likely to be."

Physically the Bhutias are a fine race, although dirty in their habits and persons. Their food consists of meat, chiefly pork, turnips, rice, barley-meal and tea made from the brick-tea of China. Their favourite drink is *chong*, distilled from rice or barley and millet, and *Marud*, beer made from fermented millet. A loose woollen coat reaching to the knees, and bound round the waist by a thick fold of cotton cloth, forms the dress of the men; the women's dress is a long cloak with loose sleeves. The houses of the Bhutias are of three and four storeys; all the floors are neatly boarded with deal; and on two sides of the house is a verandah ornamented with carved work generally painted. The Bhutias are neat joiners, and their doors, windows and panelling are perfect in their way. No iron-work is used; the doors open on ingenious wooden hinges. The appearance of the houses is precisely that of Swiss chalets, picturesque and comfortable—the only drawback being a want of chimneys, which the Bhutias do not know how to construct. The people nominally profess the Buddhist religion, but in reality their religious exercises are confined to the propitiation of evil spirits, and the mechanical recital of a few sacred sentences. Around the cottages in the mountains the land is cleared for cultivation, and produces thriving crops of barley, wheat, buckwheat, millet, mustard, chillies, etc. Turnips of excellent quality are extensively grown; they are free from fibre and remarkably sweet. The wheat and barley have a full round grain, and the climate is well adapted to the production of both European and Asiatic vegetables. Potatoes have been introduced. The Bhutias lay out their fields in a series of terraces cut out of the sides of the hills; each terrace is riveted and supported by stone embankments, sometimes 20 ft. high. Every field is carefully fenced with pine branches, or protected by a stone wall. A complete system of irrigation permeates the whole cultivated part of a village, the water being often brought from a long distance by stone aqueducts. Bhutias do not care to extend their cultivation, as an increased revenue is exacted in proportion to the land cultivated, but devote their whole energies to make the land yield twice what it is estimated to produce. The forests of Bhutan abound in many varieties of stately trees. Among them are the beech, ash, birch, maple, cypress and yew. Firs and pines cover the mountain heights; and below these, but still at an elevation of eight or nine thousand feet, is a zone of vegetation, consisting principally of oaks and rhododendrons. The cinnamon tree is also found. Some of the roots and branches were examined by Captain Samuel Turner during his journey to Tibet; but the plant being neither in blossom nor bearing fruit, it was impossible to decide whether it was the true cinnamon or an inferior kind of cassia. The leaf, however, corresponded with the description given of the true cinnamon by Linnaeus. The lower ranges of the hills abound in animal life. Elephants are so numerous as to be dangerous to travellers; but tigers are not common, except near the river Tista, and in the dense red jungle and forests of the Dwars. Leopards abound in the Hah valley; deer everywhere, some of them of a very large species. The musk deer is found in the snows, and the barking deer on every hill side. Wild hogs are met with even at great elevations. Large squirrels are common. Bears and rhinoceros are also found. Pheasants, jungle fowls, pigeons and other small game abound. The Bhutias are no sportsmen. They have a superstitious objection to firing a gun, thinking that it offends the deities of the woods and valleys, and brings down rain. A species of horse, which seems indigenous to Bhutan, and is used as a domestic animal, is called *Wangan*, from Tangastan, the general appellation of that assemblage of mountains which constitutes the territory of Bhutan. It is peculiar to this tract, not being found in any of the neighbouring countries of Assam, Nepal, Tibet or Bengal, and unites in an eminent degree the two qualities of strength and beauty. The *Wangan* horse usually stands about thirteen hands high, is short-bodied, clean-limbed, deep in the chest and extremely active, his colour usually inclining to piebald. In so barren and rude a country the manufacturing industry of its people is, as might be expected,

in a low stage, the few articles produced being all destined for home consumption. These consist of coarse blankets and cotton cloths made by the villagers inhabiting the southern tract. Leather, from the hide of the buffalo, imperfectly tanned, furnishes the soles of snow boots. Circular bowls are neatly turned from various woods. A small quantity of paper is made from a plant described as the *Daphne papyrifera*. Swords, iron spears and arrow-heads, and a few copper caldrons, fabricated from the metal obtained in the country, complete the list of manufactures.

Trade connections are rather with Tibet than with India. In 1901-1902 the value of the import and export trade with British India amounted only to £57,000. The military resources of the country are on an insignificant scale. Beyond the guards for the defence of the various castles, there is nothing like a standing army. The total military force was estimated by the British envoy in 1864 at 6000. The climate of Bhutan varies according to the difference of elevation. At the time when the inhabitants of Punākha (the winter residence of the rajas) are afraid of exposing themselves to the blazing sun, those of Ghasa experience all the rigour of winter, and are chilled by perpetual snows. Yet these places are within sight of each other. The rains descend in floods upon the heights; but in the vicinity of Tasisudon, the capital, they are moderate; there are frequent showers, but nothing that can be compared to the tropical rains of Bengal. Owing to the great elevation and steepness of the mountains, dreadful storms arise among the hollows, often attended with fatal results.

History.—Bhutan formerly belonged to a tribe called by the Bhutias Tephu, generally believed to have been the people of Kuch Behar. About A.D. 1670 some Tibetan soldiers subjugated the Tephus, took possession of the country and settled down in it. The relations of the British with Bhutan commenced in 1772, when the Bhutias invaded the principality of Kuch Behar, a dependency of Bengal. The Kuch Behar Raja applied for aid, and a force under Captain James was despatched to his assistance; the invaders were expelled and pursued into their own territories. Upon the intercession of Teshu Lama, then regent of Tibet, a treaty of peace was concluded in 1774 between the East India Company and the ruler of Bhutan. In 1783 Captain S. Turner was deputed to Bhutan, with a view of promoting commercial intercourse, but his mission proved unsuccessful. From this period little intercourse took place with Bhutan, until the occupation of Assam by the British in 1826. It was then discovered that the Bhutias had usurped several tracts of low land lying at the foot of the mountains, called the Dwars or passes, and for these they agreed to pay a small tribute. They failed to pay, however, and availed themselves of the command of the passes to commit depredations within the British territory. Captain R. B. Pemberton was accordingly deputed to Bhutan to adjust the points of difference. But his negotiations yielded no definite result; and every other means of obtaining redress and security proving unsuccessful, the Assam Dwars were wrested from the Bhutias, and the British government consented to pay to Bhutan a sum of £1000 per annum as compensation for the resumption of their tenure, during the good behaviour of the Bhutias. Continued outrages and aggressions were, however, committed by the Bhutias on British subjects in the Dwars. Notwithstanding repeated remonstrances and threats, scarcely a year passed without the occurrence of several raids in British territory headed by Bhutia officials, in which they plundered the inhabitants, massacred them, or carried them away as slaves. In 1863 Sir Ashley Eden was sent as an envoy to Bhutan to demand reparation for these outrages. He did not succeed in his mission; he was subjected to the grossest insults; and under compulsion signed a treaty giving over the disputed territory to Bhutan, and making other concessions which the Bhutan government demanded. On Sir A. Eden's return the viceroy at once disavowed his treaty, sternly stopped the former allowance for the Assam Dwars, and demanded the immediate restoration of all British subjects kidnapped during the last five years. The Bhutias not complying with this demand, the governor-general

issued a proclamation, dated the 12th of November 1864, by which the eleven Western or Bengal Dwars were forthwith incorporated with the queen's Indian dominions. No resistance was at first offered to the annexation; but, suddenly, in January 1865, the Bhutias surprised the English garrison at Dewangiri, and the post was abandoned with the loss of two mountain guns. This disaster was soon retrieved by General Sir Henry Tombs, and the Bhutias were compelled to sue for peace, which was concluded on the 11th of November 1865. The Bhutan government formally ceded all the eighteen Dwars of Bengal and Assam, with the rest of the territory taken from them, and agreed to liberate all kidnapped British subjects. As the revenues of Bhutan mainly depended on these Dwars, the British government, in return for these concessions, undertook to pay the Deb and Dharm rajas annually, subject to the condition of their continued good behaviour, an allowance beginning at £2500 and rising gradually to the present figure. Since that time the annexed territories have settled down into peaceful and prosperous British districts. The recent relations between the Indian government and Bhutan have been satisfactory; and during the troubles with Tibet in 1904 the attitude of the Bhutias was perfectly correct and friendly.

See *Report on Explorations in Sikkim, Bhutan and Tibet* (Deva Dun, 1889); Tanner, "Our present Knowledge of the Himalayas," *R.G.S. Proceedings*, vol. xiii. (T. H. H.)

BIANCHINI, FRANCESCO (1662-1729), Italian astronomer and antiquary, was born of a noble family at Verona on the 13th of December 1662. In 1684 he went to Rome, and became librarian to Cardinal Ottoboni, who, as Pope Alexander VIII. (1689), raised him to the offices of papal chamberlain and canon of Santa Maria Maggiore. Clement XI. sent him on a mission to Paris in 1712, and employed him to form a museum of Christian antiquities. He died at Rome on the 2nd of March 1729. A paper by him on G. D. Cassini's new method of parallaxes was inserted in the *Acta Eruditorum* of Leipzig in 1685. He published separately:—*Istoria Universale* (Roma, 1697), only one volume of which appeared; *De Calendario et Cyclo Caesaris* (1703); *Hesperii et Phosphori nova Phenomena* (1729), in which he asserted Venus to rotate in 24½ days; and (posthumously) *Astronomicae et Geographicae Observationes Selectae* (1737) and *Opuscula Varia* (1754).

See Fontenelle's "Éloge" (*Mémoires de l'Acad. de l'Histoire*, p. 102, Paris, 1729); Mazzoleni, *Vite di Francesco Bianchini* (Verona, 1735); Tiplado, *Biografia degli Italiani Illustri*, vii. 288 (Venezia, 1840); Mazzuchelli, *Scrittori d'Italia*; Maffei, *Verona Illustrata*, p. 254, &c.

BIARRITZ, a watering-place of south-western France, in the department of Basses-Pyrénées, on the sea-coast about 5 m. S.W. of Bayonne. Pop. (1906) 13,629. From a mere fishing village, with a few hundred inhabitants in the beginning of the 19th century, Biarritz rose rapidly into a place of importance under the patronage of the emperor Napoleon III. and the empress Eugénie, with whom it was a favourite resort. The town is situated on a promontory jutting north-west into the Bay of Biscay and on the coast which extends on each side of it. The beach to the north-east is known as the Grande Plage, that to the south-west as the Côte des Basques. The Grande Plage is more than half a mile long and stretches to the Cap St Martin, on which stands a lighthouse. It is divided into two parts by a small headland once the site of the villa of the empress Eugénie, between which and the main promontory are the two casinos, the principal baths and many luxurious villas and fine hotels. Towards the north-east the promontory of Biarritz ends in a projection known as the Atalaye, crowned by the ruins of a castle and surrounded by rocky islets. Some of these are united to the mainland and to each other by jetties which curve round so as to form the Port de Refuge, a haven available only in fair weather. South-west of the Atalaye lies the Port-Vieux, a sheltered cove now used only as a bathing-place. The Port des Pêcheurs, the principal of the three harbours, is on the south-east side of the Atalaye and is that most used by the fishermen of the town. Apart from unimportant manufactures of pottery, chocolate, &c., fishing is the only industry; Biarritz depends for its prosperity on the visitors who are attracted by its mild climate and the

bathing. The season is almost continuous; in the winter the English, in the summer Russians, Spaniards and French fill the hotels of the town. Among its attractions is a golf club, established in 1888, with a course of 18 holes.

BIAS of Priene in Ionia, one of the so-called Seven Sages of Greece, son of Teutamius, flourished about 570 B.C. He was famous for his patriotism, the nobility of his character and his eloquence. A number of gnomes or aphorisms are attributed to him, which may be found collected in F. W. A. Mullach, *Fragmenta Philosophorum Græcorum* (1860). He is said to have written a poem on the best means of making Ionia prosperous. His advice to its inhabitants, at the time of the Persian invasion, to migrate to Sardinia and there found a single pan-Ionic city (Herodotus i. 170), has generally been regarded as historical. One much-quoted saying of his may be mentioned. When his native town was besieged by the enemy, the inhabitants resolved to escape with their most valuable belongings. One of them seeing Bias without anything, advised him to follow the example of the rest. "I am doing so," said he, "for I carry all my belongings with me" (*omnia mea mecum porto*). He was honoured with a splendid funeral, and a sanctuary called Teutamium was dedicated to him.

See Bohren, *De Septem Sapientibus* (1860).

BIAS (from the Fr. *biais*, of unknown origin; the derivation from Lat. *bifax*, two-faced, is wrong), something oblique or slanting. The term is used especially of a piece of cloth cut obliquely across the texture, or of a seam of two such pieces brought together; and in the game of bowls (*g.v.*) it is applied alike to the one-sided construction of the bowl, flattened on one side and protruding on the other, and to the slanting line the bowl takes when thrown. The figurative sense of the word, prejudice or undue leaning to one side of a subject, is derived from this bowling term.

BIBACULUS, MARCUS FURIUS, Roman poet, flourished during the last century of the republic. According to Jerome, he was born at Cremona in 103 B.C., and probably lived to a great age. He wrote satirical poems after the manner of Catullus, whose bitterness he rivalled, according to Quintilian (*Instit.* x. 1. 196), in his iambs. He even attacked Augustus (and perhaps Caesar), who treated the matter with indifference. He was also author of prose *Lucubrations* and perhaps of an epic poem on Caesar's Gallic wars (*Præmagna Belli Gallici*). Otto Ribbeck attributes to him one of the shorter poems usually assigned to Virgil. It is doubtful whether he is the person ridiculed by Horace (*Satires*, ii. 5. 40) and whether he is identical with the *turgidus Alpinus* (*Satires*, i. 10. 36), the author of an Æthiopia dealing with the life and death of Memnon and of a poem on the Rhine. Some critics, on the ground that Horace would not have ventured to attack so dangerous an adversary, assume the existence of a poet whose real name was Furius (or Cornelius) Alpinus. Bibaculus was ridiculed for his high-flown and exaggerated style and manner of expression.

See Weichert, "De M. Furio Bibaculo," in his *Poetorum Latinorum Reliquiæ* (1830); fragments in L. Müller's edition of *Catullus* in the Teubner Series (1870).

BIBER, HEINRICH JOHANN FRANZ VON (1644-1704), German violinist and composer, was for some time musical conductor at Salzburg, and was ennobled by the emperor Leopold in 1681. He is regarded as the earliest important German composer for the violin, his works including sonatas and church music.

BIBERACH, a town of Germany, in the kingdom of Württemberg, on the Kiss, a small affluent of the Danube, 22 m. S.S.W. from Ulm. Pop. (1900) 8300. It is still surrounded by medieval walls and towers, and is strikingly picturesque. Its principal church dates from the 12th century, and it possesses a hospital with rich endowments. Its main industries are cloth, bell-casting, toys and zinc wares, and its fruit markets are famous.

Biberach appears as a village in the 8th century, and in 1312 it became a free imperial city. During the 'Thirty Years' War it underwent various vicissitudes, and was for a while held by the Swedes. In 1707 it was captured and put to ransom by the

French, who afterwards, in 1706 and 1800, defeated the Austrians in the neighbourhood. In 1803 the city was deprived of its imperial freedom and assigned to Baden, and in 1806 was transferred to Württemberg. Biberach is the birthplace of the sculptor Johann Lorenz Natter (1705-1763) and the painter Bernhard Neher (1806-1886); Christoph Martin Wieland, born in 1733 at the neighbouring village of Oberholzheim, spent several years in the town.

BIBIRINE, or **BEBEERINE**, $C_{12}H_{25}NO_3$, an alkaloid obtained from the bark and fruit of the greenheart (*g.v.*) tree, *Nectandra rodiaei*, called *bibiru* or *sipiri* in Guiana, where the tree grows. The substance was discovered about the year 1835 by Hugh Rodie, a surgeon in Demerara, who used it as a febrifuge in substitution for quinine.

BIBLE. The word "Bible," which in English, as in medieval Latin, is treated as a singular noun, is in its original Greek form a plural, τὰ βιβλία, *the (sacred) books*—correctly expressing the fact that the sacred writings of Christendom (collectively described by this title) are made up of a number of independent records, which set before us the successive stages in the history of revelation. The origin of each of these records forms a distinct critical problem, and for the discussion of these questions of detail the reader is referred to the separate articles on the Biblical books. An account of the Bible as a whole involves so many aspects of interest, that, apart from the separate articles on its component books, the general questions of importance arising out of its present shape require to be discussed in separate sections of this article. They are here divided accordingly, into two main divisions:—(A) Old Testament, and (B) New Testament; and under each of these are treated (1) the Canon, (2) the texts and versions, (3) textual criticism, (4) the "higher criticism," i.e. a general historical account (more particularly considered for separate books in the articles on them) of the criticism and views based on the substance and matter, as apart from criticism devoted to the correction and elucidation of the text, and (5) chronology. For the literary history of the translated *English Bible*, see the separate article under **BIBLE, ENGLISH**.

(A) OLD TESTAMENT

1. Canon.

We shall begin by giving a general account of the historical and literary conditions under which the unique literature of the Old Testament sprang up, of the stages by which it gradually reached its present form, and (so far as this is possible) of the way in which the Biblical books were brought together in a canonical collection. There exists no formal historical account of the formation of the Old Testament canon. The popular idea that this canon was closed by Ezra has no foundation in antiquity. Certainly in the apocryphal book of 2 Esdras, written towards the end of the 1st century A.D., we read (xiv. 20-26, 38-48), that, the law being burnt, Ezra, at his own request, was miraculously inspired to rewrite it; he procured accordingly five skilled scribes, and dictated to them for forty days, during which time they wrote 94 books, i.e. not only (according to the Jewish reckoning) the 24 books of the Old Testament, but 70 apocryphal books as well, which, being filled, it is said, with a superior, or esoteric wisdom, are placed upon even a higher level (vv. 46, 47) than the Old Testament itself. No argument is needed to show that this legend is unworthy of credit; even if it did deserve to be taken seriously, it still contains nothing respecting either a completion of the canon, or even a collection, or redaction, of sacred books by Ezra. Yet it is frequently referred to by patristic writers; and Ezra, on the strength of it, is regarded by them as the genuine restorer of the lost books of the Old Testament (see **EZRA**).

In 2 Macc. ii. 13 it is said that Nehemiah, "founding a library, gathered together the things concerning the kings and prophets, and the (writings) of David, and letters of kings about sacred gifts." These statements are found in a part of 2 Macc. which is admitted to be both late and full of untrustworthy matter; still, the passage may preserve an indistinct reminiscence of an early stage in the formation of the canon, the writings referred

to being possibly the books of Samuel and Kings and some of the Prophets, a part of the Psalter, and documents such as those excerpted in the book of Ezra, respecting edicts issued by Persian kings in favour of the Temple. But obviously nothing definite can be built upon a passage of this character.

The first traces of the idea current in modern times that the canon of the Old Testament was closed by Ezra are found in the 13th century A.D. From this time, as is clearly shown by the series of quotations in Ryle's *Canon of the Old Testament*, p. 257 ff. (2nd ed., p. 260 ff.), the legend—for it is nothing better—grew, until finally, in the hands of Elias Levita (1538), and especially of Johannes Buxtorf (1665), it assumed the form that the "men of the Great Synagogue,"—a body the real existence of which is itself very doubtful, but which is affirmed in the Talmud to have "written" (!) the books of Ezekiel, the Minor Prophets, Daniel and Esther—with Ezra as president, first collected the books of the Old Testament into a single volume, restored the text, where necessary, from the best MSS., and divided the collection into three parts, the Law, the Prophets and the "Writings" (the Hagiographa). The reputation of Elias Levita and Buxtorf led to this view of Ezra's activity being adopted by other scholars, and so it acquired general currency. But it rests upon no authority in antiquity whatever.

The statement just quoted, however, that in the Jewish canon the books of the Old Testament are divided into three parts, though the arrangement is wrongly referred to Ezra, is in itself both correct and important. "The Law, the Prophets and the Writings (*i.e.* the Hagiographa)" is the standing Jewish expression for the Old Testament; and in every ordinary Hebrew Bible the books are arranged accordingly in the following three divisions:—

1. The *Tōrah* (or "Law"), corresponding to our "Pentateuch" (5 books).

2. The "Prophets," consisting of eight books, divided into two groups:—

(a) The "Former Prophets"; Joshua, Judges, Samuel; Kings.¹
 (b) The "Latter Prophets"; Isaiah, Jeremiah, Ezekiel, the Minor Prophets (called by the Jews "the Twelve," and counted by them as *one* book).

3. The "Writings," also sometimes the "Sacred Writings," *i.e.*, as we call them, the "Hagiographa," consisting of three groups, containing in all eleven books:—

(a) The poetical books, Psalms, Proverbs, Job.
 (b) The five *Megilloth* (or "Rolls")—grouped thus together in later times, on account of the custom which arose of reading them in the synagogues at five sacred seasons—Song of Songs, Ruth, Lamentations, Ecclesiastes, Esther.
 (c) The remaining books, Daniel, Ezra and Nehemiah (forming *one* book), Chronicles.¹

There are thus, according to the Jewish computation, twenty-four "books" in the Hebrew canon. The threefold division of the canon just given is recognized in the Talmud, and followed in all Hebrew MSS., the only difference being that the books included in the Latter Prophets and in the Hagiographa are not always arranged in the same order. No book, however, belonging to one of these three divisions is ever, by the Jews, transferred to another. The expansion of the Talmudic twenty-four to the thirty-nine Old Testament books of the English Bible is effected by reckoning the Minor Prophets one by one, by separating Ezra from Nehemiah, and by subdividing the long books of Samuel, Kings and Chronicles. The different order of the books in the English Bible is due to the fact that when the Hebrew Bible was translated into Greek between the 3rd and 1st centuries B.C., the Hebrew tripartite division was disregarded, and the books (including those now known as the "Apocrypha") were grouped mostly by subjects, the historical books being placed first (Genesis—Esther), the poetical books next (Job—Song of Songs), and the prophetic books last (Isaiah—Malachi).

¹ The books of Samuel, Kings, Ezra and Nehemiah, and Chronicles, were by the Jews each treated (and written) as one book, and were not divided by them into two till the 16th century, through Christian influence.

Substantially the same order was followed in the Vulgate. The Reformers separated the books which had no Hebrew original (*i.e.* the Apocrypha) from the rest, and placed them at the end; the remaining books, as they stood in the Vulgate, were then in the order which they still retain in the English Bible.

The tripartite division of the Hebrew canon thus recognized by Jewish tradition can, however, be traced back far beyond the Talmud. The Proverbs of Jesus, the son of Sirach (*c.* 200 B.C.), which form now the apocryphal book Ecclesiasticus, were translated into Greek by the grandson of the author at about 130 B.C.; and in the preface prefixed by him to his translation he speaks of "the law, and the prophets, and the other books of our fathers," and again of "the law, and the prophets, and the rest of the books," expressions which point naturally to the same threefold division which was afterwards universally recognized by the Jews. The terms used, however, do not show that the Hagiographa was already completed, as we now have it; it would be entirely consistent with them, if, for instance, particular books, as Esther, or Daniel, or Ecclesiastes, were only added to the collection subsequently. Another allusion to the tripartite division is also no doubt to be found in the expression "the law, the prophets, and the psalms," in Luke xxiv. 44. A collection of sacred books, including in particular the prophets, is also referred to in Dan. ix. 2 (R.V.), written about 166 B.C.

This threefold division of the Old Testament, it cannot reasonably be doubted, rests upon an historical basis. It represents three successive stages in the history of the collection. The Law was the first part to be definitely recognized as authoritative, or canonized; the "Prophets" (as defined above) were next accepted as canonical; the more miscellaneous collection of books comprised in the Hagiographa was recognized last. In the absence of all external evidence respecting the formation of the canon, we are driven to internal evidence in our endeavour to fix the dates at which these three collections were thus canonized. And internal evidence points to the conclusion that the Law could scarcely have been completed, and accepted formally, as a whole, as canonical before 444 B.C. (*cf.* Neh. viii.—x.); that the "Prophets" were completed and so recognized about 250 B.C., and the Hagiographa between about 150 and 100 B.C. (See further Ryle's *Canon of the Old Testament*.)

Having thus fixed approximately the *terminus ad quem* at which the Old Testament was completed, we must now begin at the other end, and endeavour to sketch in outline the process by which it gradually reached its completed form. And here it will be found to be characteristic of nearly all the longer books of the Old Testament, and in some cases even of the shorter ones as well, that they were not completed by a single hand, but that they were gradually expanded, and reached their present form by a succession of stages.

Among the Hebrews, as among many other nations, the earliest beginnings of literature were in all probability poetical. At least the opening phrases of the song of Moses in Exodus xv.; the song of Deborah in Judges v.; the fragment from the "Book of the Wars of Yahweh," in Numbers xxi. 14, 15; the war-ballad, celebrating an Israelitish victory, in Numbers xxi. 27-30; the extracts from the "Book of Jasher" (or "of the Upright," no doubt a title of Israel) quoted in Joshua x. 12, 13 ("Sung, stand thou still upon Gibeon," &c.); in 2 Sam. i. (David's eulogy over Saul and Jonathan); and, very probably, in the Septuagint of 1 Kings viii. 13 [Sept. 53], as the source of the poetical fragment in vv. 12, 13, describing Solomon's building of the Temple, show how great national occurrences and the deeds of ancient Israelitish heroes stimulated the national genius for poetry, and evoked lyric songs, suffused with religious feeling, by which their memory was perpetuated. The poetical descriptions of the character, or geographical position, of the various tribes, now grouped together as the Blessings of Jacob (Gen. xlix.) and Moses (Deut. xxxiii.), may be mentioned at the same time. These poems, which are older, and in most cases considerably older, than the narratives in which they are now embedded, if they were collected into books, must have been fairly numerous,

and we could wish that more examples of them had been preserved.

The historical books of the Old Testament form two series: one, consisting of the books from Genesis to 2 Kings (exclusive of Ruth, which, as we have seen, forms in the Hebrew canon part of the Hagiographa), embracing the period from the Creation to the destruction of Jerusalem by the Chaldeans in 586 B.C.; the other, comprising the books of Chronicles, Ezra and Nehemiah, beginning with Adam and ending with the second visit of Nehemiah to Jerusalem in 432 B.C. These two series differ from one another materially in scope and point of view, but in one respect they are both constructed upon a similar plan; no entire book in either series consists of a single, original work; but older writings, or sources, have been combined by a compiler—or sometimes, in stages, by a succession of compilers—in such a manner that the points of juncture are often clearly discernible, and the sources are in consequence capable of being separated from one another. The authors of the Hebrew historical books, as we now have them, do not, as a rule, as a modern author would do, *rewrite* the matter in their own language; they *excerpt* from pre-existing documents such passages as are suitable to their purpose, and incorporate them in their work, sometimes adding at the same time matter of their own. Hebrew writers, however, exhibit usually such strongly marked individualities of style that the documents or sources, thus combined, can generally be distinguished from each other, and from the comments or other additions of the compiler, without difficulty. The literary differences are, moreover, often accompanied by differences of treatment, or representation of the history, which, where they exist, confirm independently the conclusions of the literary analysis. Although, however, the historical books generally are constructed upon similar principles, the method on which these principles have been applied is not quite the same in all cases. Sometimes, for instance, the excerpts from the older documents form long and complete narratives; in other cases (as in the account of the Flood) they consist of a number of short passages, taken alternately from two older narratives, and dovetailed together to make a continuous story; in the books of Judges and Kings the compiler has fitted together a series of older narratives in a framework supplied by himself; the Pentateuch and book of Joshua (which form a literary whole, and are now often spoken of together as the *Hexateuch*) have passed through more stages than the books just mentioned, and their literary structure is more complex.

The Hexateuch (Gen.—Josh.).—The traditions current among the Israelites respecting the origins and early history of their nation—the patriarchal period, and the times of Moses and Joshua—were probably first cast into a written form in the 10th or 9th century B.C. by a prophet living in Judah, who, from the almost exclusive use in his narrative of the sacred name “Jahveh” (“Jehovah”),—or, as we now commonly write it, Yahweh,—is referred to among scholars by the abbreviation “J.” This writer, who is characterized by a singularly bright and picturesque style, and also by deep religious feeling and insight, begins his narrative with the account of the creation of man from the dust, and tells of the first sin and its consequences (Gen. ii. 4th–iii. 24); then he gives an account of the early growth of civilization (Gen. iv.), of the Flood (parts of Gen. vi.–viii.), and the origin of different languages (xi. 1-9); afterwards in a series of vivid pictures he gives the story, as tradition told it, of the patriarchs, of Moses and the Exodus, of the journey through the wilderness, and the conquest of Canaan. It would occupy too much space to give here a complete list of the passages belonging to “J”; but examples of his narrative (with the exception here and there of a verse or two belonging to one of the other sources described below) are to be found, for instance, in Gen. xii., xiii., xviii.–xix. (the visit of the three angels to Abraham, and the judgment on Sodom and Gomorrah), xxiv. (Abraham’s servant sent to find a wife for Isaac), xxvii. 1-45 (Jacob obtaining his father’s blessing), xxviii., xxviii., 1-15 (parts of the history of Joseph); Ex. iv.–v. (mostly), viii. 20–ix. 7, x. 1-11, xxxiii. 12–xxxiv. 26 (including, in xxxiv. 17-26,

a group of regulations, of a simple, undeveloped character, on various religious observances); Num. x. 29-36, and most of Num. xi.

Somewhat later than “J,” another writer, commonly referred to as “E,” from his preference for the name *Elohim* (“God”) rather than “Jehovah,” living apparently in the northern kingdom, wrote down the traditions of the past as they were current in northern Israel, in a style resembling generally that of “J,” but not quite as bright and vivid, and marked by small differences of expression and representation. The first traces of “E” are found in the life of Abraham, in parts of Gen. xv.; examples of other passages belonging to this source are:—Gen. xi. 1-17, xxi. 8-32, xxii. 1-14, xl.–xlii. and xlv. (except a few isolated passages); Ex. xviii., xx.–xxiii. (including the decalogue—in its original, terser form, without the explanatory additions now attached to several of the commandments—and the collection of laws, known as the “Book of the Covenant,” in xxi.–xxiii.), xxxii., xxxiii. 7-11; Num. xii., most of Num. xxii.–xxiv. (the history of Balaam); Josh. xxiv. “E” thus covers substantially the same ground as “J,” and gives often a parallel, though somewhat divergent, version of the same events. The laws contained in Ex. xx. 23–xxiii. 19 were no doubt taken by “E” from a pre-existing source; with the regulations referred to above as incorporated in “J” (Ex. xxxiv. 17-26), they form the oldest legislation of the Hebrews that we possess; they consist principally of *civil* ordinances, suited to regulate the life of a community living under simple conditions of society, and chiefly occupied in agriculture, but partly also of elementary regulations respecting religious observances (altars, sacrifices, festivals, &c.).

Not long, probably, after the fall of the northern kingdom in 722 B.C., a prophet of Judah conceived the plan of compiling a comprehensive history of the traditions of his people. For this purpose he selected extracts from the two narratives, “J” and “E,” and combined them together into a single narrative, introducing in some places additions of his own. This combined narrative is commonly known as “JE.” As distinguished from the Priestly Narrative (to be mentioned presently), it has a distinctly *prophetic* character; it treats the history from the standpoint of the prophets, and the religious ideas characteristic of the prophets often find expression in it. Most of the best-known narratives of the patriarchal and Mosaic ages belong to “JE.” His style, especially in the parts belonging to “J,” is graphic and picturesque, the descriptions are vivid and abound in detail and colloquy, and both emotion and religious feeling are warmly and sympathetically expressed in it.

Deuteronomy.—In the 7th century B.C., during the reign of either Manasseh or Josiah, the narrative of “JE” was enlarged by the addition of the *discourses of Deuteronomy*. These discourses purport to be addresses delivered by Moses to the assembled people, shortly before his death, in the land of Moab, opposite to Jericho. There was probably some tradition of a farewell address delivered by Moses, and the writer of Deuteronomy gave this tradition form and substance. In impressive and persuasive oratory he sets before Israel, in a form adapted to the needs of the age in which he lived, the fundamental principles which Moses had taught. Yahweh was Israel’s only god, who tolerated no other god beside Himself, and who claimed to be the sole object of the Israelite’s reverence. This is the fundamental thought which is insisted on and developed in Deuteronomy with great eloquence and power. The truths on which the writer loves to dwell are the sole godhead of Yahweh, His spirituality (ch. iv.), His choice of Israel, and the love and faithfulness which He had shown towards it, by redeeming it from slavery in Egypt, and planting it in a free and fertile land; from which are deduced the great practical duties of loyal and loving devotion to Him, an uncompromising repudiation of all false gods, the rejection of all heathen practices, a cheerful and ready obedience to His will, and a warm-hearted and generous attitude towards man. Love of God is the primary spring of human duty (vi. 5). In the course of his argument (especially in chs. xii.–xxvi.), the writer takes up most of the laws, both civil

and ceremonial, which (see above) had been incorporated before in "J" and "E," together with many besides which were current in Israel; these, as a rule, he expands, applies or enforces with motives; for obedience to them is not to be rendered merely in deference to external authority, it is to be prompted by right moral and religious motives. The ideal of Deuteronomy is a community of which every member is full of love and reverence towards his God, and of sympathy and regard for his fellow-men. The "Song" (Deut. xxxii.) and "Blessing" (Deut. xxxiii.) of Moses are not by the author of the discourses; and the latter, though not Mosaic, is of considerably earlier date.

The influence of Deuteronomy upon subsequent books of the Old Testament is very perceptible. Upon its promulgation it speedily became the book which both gave the religious ideals of the age, and moulded the phraseology in which these ideals were expressed. The style of Deuteronomy, when once it had been formed, lent itself readily to imitation; and thus a school of writers, imbued with its spirit, and using its expressions, quickly arose, who have left their mark upon many parts of the Old Testament. In particular, the parts of the combined narrative "JE," which are now included in the book of Joshua, passed through the hands of a Deuteronomist editor, who made considerable additions to them—chiefly in the form of speeches placed, for instance, in the mouth of Joshua, or expansions of the history, all emphasizing principles inculcated in Deuteronomy and expressed in its characteristic phraseology (e.g. most of Josh. i., ii. 10-11, iii. 2-4, 6-9, x. 28-43, xi. 10-23, xii., xiii. 2-6, 8-12, xxxii.). From an historical point of view it is characteristic of these additions that they *generalise* Joshua's successes, and represent the conquest of Canaan, effected under his leadership, as far more complete than the earlier narratives allow us to suppose was the case. The compilers of Judges and Kings are also (see below) strongly influenced by Deuteronomy.

The *Priestly* sections of the Hexateuch (known as "P") remain still to be considered. That these are later than "JE," and even than Deut., is apparent—to mention but one feature—from the more complex ritual and hierarchical organization which they exhibit. They are to all appearance the work of a school of priests, who, after the destruction of the Temple in 586 B.C., began to write down and codify the ceremonial regulations of the pre-exilic times, combining them with an historical narrative extending from the Creation to the establishment of Israel in Canaan; and who completed their work during the century following the restoration in 537 B.C. The chief object of these sections is to describe in detail the leading institutions of the theocracy (Tabernacle, sacrifices, purifications, &c.), and to refer them to their traditional origin in the Mosaic age. The history as such is subordinate; and except at important epochs is given only in brief summaries (e.g. Gen. xix. 29, xli. 46). Statistical data (lists of names, genealogies, and precise chronological notes) are a conspicuous feature in it. The legislation of "P," though written down in or after the exile, must not, however, be supposed to be the *creation* of that period; many elements in it can be shown from the older literature to have been of great antiquity in Israel; it is, in fact, based upon *pre-exilic Temple usage*, though in some respects it is a development of it, and exhibits the form which the older and simpler ceremonial institutions of Israel ultimately assumed. In "P's" picture of the Mosaic age there are many *ideal* elements; it represents the priestly ideal of the past rather than the past as it actually was. The following examples of passages from "P" will illustrate what has been said:—Gen. i. 1-ii. 4^a, xvii. (institution of circumcision), xxiii. (purchase of the cave of Machpelah), xxv. 7-17, xvi. 6-27; Ex. vi. 2-vii. 13, xxv-xxxi. (directions for making the Tabernacle, its vessels, dress of the priests, &c.), xxxv-xl. (execution of these directions); Lev. (the whole); Num. i. 1-x. 28 (census of people, arrangement of camp, and duties of Levites, law of the Nazirite, &c.), xv., xviii., xix., xxvi.-xxxii., xxxiii.-xxxvii.; Josh. v. 10-12, the greater part of xv.-xix. (distribution of the land among the different tribes), xxi. 1-42. The style of "P" is strongly marked—as strongly marked, in

fact, as (in a different way) that of Deuteronomy is; numerous expressions not found elsewhere in the Hexateuch occur in it repeatedly. The section Lev. xvii.-xxvi. has a character of its own; for it consists of a substratum of older laws, partly moral (chs. xviii.-xx. mostly), partly ceremonial, with a hortatory conclusion (ch. xxvi.), with certain very marked characteristics (from one of which it has received the name of the "Law of Holiness"), which have been combined with elements belonging to, or conceived in the spirit of, the main body of "P."

Not long after "P" was completed, probably in the 5th century B.C., the whole, consisting of "JE" and Deuteronomy, was combined with it; and the existing Hexateuch was thus produced.

Judges, Samuel and Kings.—The structure of these books is simpler than that of the Hexateuch. The book of Judges consists substantially of a series of older narratives, arranged together by a compiler, and provided by him, where he deemed it necessary, with introductory and concluding comments (e.g. ii. 11-iii. 6, iii. 12-15^a, 30, iv. 1-3, 23, 24, v. 31^b). The compiler is strongly imbued with the spirit of Deuteronomy; and the object of his comments is partly to exhibit the chronology of the period as he conceived it, partly to state his theory of the religious history of the time. The compiler will not have written before c. 600 B.C.; the narratives incorporated by him will in most cases have been considerably earlier. The books of Samuel centre round the names of Samuel, Saul and David. They consist of a series of narratives, or groups of narratives, dealing with the lives of these three men, arranged by a compiler, who, however, unlike the compilers of Judges and Kings, rarely allows his own hand to appear. Some of these narratives are to all appearance nearly contemporary with the events that they describe (e.g. i Sam. ix. 1-x. 16, xi. 1-11, 15, xiii-xiv., xv.-xxxi.; 2 Sam. ix-xx.); others are later. In 1 Sam. the double (and discrepant) accounts of the appointment of Saul as king (ix. 1-x. 16, xi. 1-11, 15, and viii., x. 17-27, xii.), and of the introduction of David to the history (xvi. 14-23 and xvii. 1-xviii. 5) are noticeable; in ix. 1-x.16, xi. 1-11, 15, the monarchy is viewed as God's gracious gift to His people; in viii., x. 17-27, xii., which reflect the feeling of a much later date, the monarchy is viewed unfavourably, and represented as granted by God unwillingly. The structure of the book of Kings resembles that of Judges. A number of narratives, evidently written by prophets, and in many of which also (as those relating to Elijah, Elisha and Isaiah) prophets play a prominent part, and a series of short statistical notices, relating to political events, and derived probably from the official annals of the two kingdoms (which are usually cited at the end of a king's reign), have been arranged together, and sometimes expanded at the same time, in a framework supplied by the compiler. The framework is generally recognizable without difficulty. It comprises the chronological details, references to authorities, and judgments on the character of the various kings, especially as regards their attitude to the worship at the high places, all cast in the same literary mould, and marked by the same characteristic phraseology. Both in point of view and in phraseology the compiler shows himself to be strongly influenced by Deuteronomy. The two books appear to have been substantially completed before the exile; but short passages were probably introduced into them afterwards. Examples of passages due to the compiler: 1 Kings ii. 3-4, viii. 14-61 (the prayer of dedication put into Solomon's mouth), ix. 1-9, xi. 32^b-39, xiv. 7-11, 19-20, 21-24, 29-31, xv. 1-15, xxi. 20^b-26; 2 Kings ix. 7-10^a, xvii. 7-23.

The Latter Prophets.—Isaiah, Jeremiah, Ezekiel, the Twelve. The writings of the canonical prophets form another important element in the Old Testament, also, like the historical books, of gradual growth. Beginning with Amos and Hosea, they form a series which was not completed till more than three centuries had passed away. The activity of the prophets was largely called forth by crises in the national history. They were partly moral reformers, partly religious teachers, partly political advisers. They held up before a backsliding people the ideals of human duty, of religious truth and of national policy. They expanded and developed, and applied to new situations and

circumstances of the national life, the truths which in a more germinal form they had inherited from their ancestors. The nature and attributes of God; His gracious purposes towards man; the relation of man to God, with the practical consequences that follow from it; the true nature of religious service; the call to repentance as the condition of God's favour; the ideal of character and action which each man should set before himself; human duty under its various aspects; the responsibilities of office and position; the claims of mercy and philanthropy, justice and integrity; indignation against the oppression of the weak and the unprotected; ideals of a blissful future, when the troubles of the present will be over, and men will bask in the enjoyment of righteousness and felicity,—these, and such as these, are the themes which are ever in the prophets' mouths, and on which they enlarge with unwearied eloquence and power.

For the more special characteristics of the individual prophets, reference must be made to the separate articles devoted to each; it is impossible to do more here than summarize briefly the literary structure of their various books.

Isaiah.—The book of Isaiah falls into two clearly distinguished parts, viz. chs. i.-xxxix., and xl.-lxvi. Chs. xl.-lxvi., however, are not by Isaiah, but are the work of a prophet who wrote about 540 B.C., shortly before the conquest of Babylon by Cyrus, and whose aim was to encourage the Israelites in exile, and assure them of the certainty of their approaching restoration to Canaan. (According to many recent critics, this prophet wrote only chs. xl.-lv., chs. lvi.-lxvi. being added subsequently, some time after the return.) The genuine prophecies of Isaiah are contained in chs. i.-xiii., xiv. 24-xxxiii., xxxiii.-xxxviii., xxxvii. 22-32,—all written between 740 and 700 B.C. (or a little later), and all (except ch. vi.) having reference to the condition of Judah and Israel, and the movements of the Assyrians during the reigns of Ahaz and Hezekiah. The opinion has, however, latterly gained ground that parts even of these chapters are of later origin than Isaiah's own time. Of the rest of chs. i.-xxxix. this is generally admitted. Thus chs. xiii. 1-xiv. 23, xxi. 1-10, xxiv.-xxv. belong to the same age as chs. xl.-lxvi., xiii. 1-xiv. 23, and xxi. 1-10, looking forward similarly to the approaching fall of Babylon; chs. xxiv.-xxvii. have a character of their own, and form an apocalypse written not earlier than the 5th century B.C.; chs. xxxvi.-xxxix., describing incidents in which Isaiah took a part, consist of narratives excerpted from 2 Kings xviii. 13-xx. with the addition of Hezekiah's song (xxxvii. 9-20). It is evident from these facts that the book of Isaiah did not assume its present form till considerably after the return of the Jews from exile in 537, when a compiler, or series of compilers, arranged the genuine prophecies of Isaiah which had come to his hands, together with others which at the time were attributed to Isaiah, and gave the book its present form.

Jeremiah.—Jeremiah's first public appearance as a prophet was in the 13th year of Josiah (Jer. i. 2, xxv. 3), i.e. 626 B.C., and his latest prophecy (ch. xlv.) was delivered by him in Egypt, whither he was carried, against his will, by some of the Jews who had been left in Judah, shortly after the fall of Jerusalem in 586. Jeremiah was keenly conscious of his people's sin; and the aim of most of his earlier prophecies is to bring his countrymen, if possible, to a better mind, in the hope that thereby the doom which he sees impending may be averted—an end which eventually he saw clearly to be unattainable. Jeremiah's was a sensitive, tender nature; and he laments, with great pathos and emotion, his people's sins, the ruin to which he saw his country hastening, and the trials and persecutions which his predictions of disaster frequently brought upon him. A large part of his book is biographical, describing various incidents of his ministry. Prophecies of restoration are contained in chs. xxx.-xxxiii. The prophecies of the first twenty-three years of his ministry, as we are expressly told in ch. xxxvi., were first written down in 604 B.C. by his friend and amanuensis Baruch, and the roll thus formed must have formed the nucleus of the present book. Some of the reports of Jeremiah's pro-

phesies, and especially the biographical narratives, also probably have Baruch for their author. But the chronological disorder of the book, and other indications, show that Baruch could not have been the compiler of the book, but that the prophecies and narratives contained in it were collected together gradually, and that it reached its present form by a succession of stages, which were not finally completed till long after Israel's return from Babylon. The long prophecy (l. 1-li. 58), announcing the approaching fall of Babylon, is not by Jeremiah, and cannot have been written till shortly before 538 B.C.

Ezekiel.—Ezekiel was one of the captives who were carried with Jehoiachin in 597 B.C. to Bablyonia, and was settled with many other exiles at a place called Tel-abib (iii. 15). His prophecies (which are regularly dated) are assigned to various years from 592 to 570 B.C. The theme of the first twenty-four chapters of his book is the impending fall of Jerusalem, which took place actually in 586, and which Ezekiel foretells in a series of prophecies, distinguished by great variety of symbolism and imagery. Chs. xxv.-xxxii. are on various foreign nations, Edom, Tyre, Egypt, &c. Prophecies of Israel's future restoration follow in chs. xxxiii.-xlviii., chs. xl.-xlviii. being remarkable for the minuteness with which Ezekiel describes the organization of the restored community, as he would fain see it realized, including even such details as the measurements and other arrangements of the Temple, the sacrifices to be offered in it, the duties and revenues of the priests, and the redistribution of the country among the twelve tribes. The book of Ezekiel bears throughout the stamp of a single mind; the prophecies contained in it are arranged methodically; and to all appearance—in striking contrast to the books of Isaiah and Jeremiah—it received the form in which we still have it from the prophet himself.

The Twelve Minor Prophets.—These, as was stated above, were reckoned by the Jews as forming a single "book." The two earliest of the Minor Prophets, Amos and Hosea, prophesied in the northern kingdom, at about 760 and 740 B.C. respectively; both foresaw the approaching ruin of northern Israel at the hands of the Assyrians, which took place in fact when Sargon took Samaria in 722 B.C.; and both did their best to stir their people to better things. The dates of the other Minor Prophets (in some cases approximate) are: Micah, c. 725-c. 680 B.C. (some passages perhaps later); Zephaniah, c. 625; Nahum, shortly before the destruction of Nineveh by the Manda in 607; Habakkuk (on the rise and destiny of the Chaldaean empire) 605-600; Obadiah, after the destruction of Jerusalem by the Chaldeans in 586; Haggai, 520; Zechariah, i.-viii. (as in Haggai, promises and encouragements connected with the rebuilding of the Temple) 520 and 518; Malachi, c. 460-450; Joel, 5th century B.C.; Jonah, 4th century B.C. The latest prophecies in the book are, probably, those contained in Zech. ix.-xiv. which reflect entirely different historical conditions from Zech. i.-viii. (520 and 518 B.C.), and may be plausibly assigned to the period beginning with the conquests of Alexander the Great, between 332 and c. 300 B.C. Why these prophecies were attached to Zech. i.-viii. must remain matter of conjecture; but there are reasons for supposing that, together with the prophecy of Malachi, they came to the compiler of the "book" of the Twelve Prophets anonymously, and he simply attached them at the point which his collection had reached (i.e. at the end of Zech. viii.).

The Psalms.—The Psalter is that part of the Old Testament in which the devotional aspect of the religious character finds its completest expression; and in lyrics of exquisite tenderness and beauty the most varied emotions are poured forth by the psalmists to their God—despondency and distress, penitence and resignation, hope and confidence, jubilation and thankfulness, adoration and praise. The Psalter, it is clear from many indications, is not the work of a single compiler, but was formed gradually. A single compiler is not likely to have introduced double recensions of one and the same psalm (as Ps. liii. = Ps. xiv., Ps. lxx. = Ps. xl. 13-17, Ps. cviii. = Ps. lvii. 7-11 + lx. 5-12); in the Hebrew canon the Psalter is composed of five

books (i.-xii., xlii.-lxxii., lxxxii.-lxxxix., xc.-cvi., cvii.-cl.); and in many parts it is manifestly based upon independent smaller collections; for it contains groups of psalms headed "David," the "sons of Korah," "Asaph," "Songs of Ascents." Each of the five books of which it is composed contains psalms which show that its compilation cannot have been completed till after the return from the Captivity; and indeed, when the individual psalms are studied carefully it becomes apparent that in the great majority of cases they presuppose the historical conditions, or the religious experiences, of the ages that followed Jeremiah. Thus, though it is going too far to say that there are no pre-exilic psalms, the Psalter, as a whole, is the expression of the deeper spiritual feeling which marked the later stages of Israel's history. It has been not inaptly termed the Hymn-book of the second Temple. Its compilation can hardly have been finally completed before the 3rd century B.C.; if it is true, as many scholars think, that there are psalms dating from the time of the Maccabee struggle (Ps. xlii., lxxiv., lxxxix., lxxxiii., and perhaps others), it cannot have been completed till after 165 B.C.

The Book of Proverbs.—This is the first of the three books belonging to the "Wisdom-literature" of the Hebrews, the other two books being Job and Ecclesiastes. The Wisdom-literature of the Hebrews concerned itself with what we should call the philosophy of human nature, and sometimes also of physical nature as well; its writers observed human character, studied action in its consequences, laid down maxims for education and conduct, and reflected on the moral problems which human society presents. The book of Proverbs consists essentially of generalizations on human character and conduct, with (especially in chs. i.-ix.) moral exhortations addressed to an imagined "son" or pupil. The book consists of eight distinct portions, chs. i.-ix. being introductory, the proverbs, properly so called, beginning at x. 1 (with the title "The Proverbs of Solomon"), and other, shorter collections, beginning at xxii. 17, xxiv. 23, xxv. 1, xxx. 1, xxxi. 1, xxxi. 10 respectively. The book, it is evident, was formed gradually. A small nucleus of the proverbs may be Solomon's; but the great majority represent no doubt the generalizations of a long succession of "wise men." The introduction, or "Praise of Wisdom," as it has been called (chs. i.-ix.), commending the maxims of Wisdom as a guide to the young, will have been added after most of the rest of the book was already complete. The book will not have finally reached its present form before the 4th century B.C. Some scholars believe that it dates entirely from the Greek period (which began 332 B.C.); but it may be doubted whether there are sufficient grounds for this conclusion.

Job.—The book of Job deals with a problem of human life; in modern phraseology it is a work of religious philosophy. Job is a righteous man, overwhelmed with undeserved misfortune; and thus the question is raised, Why do the righteous suffer? Is their suffering consistent with the justice of God? The dominant theory at the time when Job was written was that all suffering was a punishment of sin; and the aim of the book is to controvert this theory. Job's friends argue that he must have been guilty of some grave sin; Job himself passionately maintains his innocence; and on the issue thus raised the dialogue of the book turns. The outline of Job's story was no doubt supplied by tradition; and a later poet has developed this outline, and made it a vehicle for expressing his new thoughts respecting a great moral problem which perplexed his contemporaries. A variety of indications (see Job) combine to show that the book of Job was not written till after the time of Jeremiah—probably, indeed, not till after the return from exile. The speeches of Elihu (chs. xxxii.-xxxvii.) are not part of the original poem, but were inserted in it afterwards.

There follow (in the Hebrew Bible) the five short books, which, as explained above, are now known by the Jews as the *Megilloth*, or "Rolls," viz. Song of Songs, Ruth, Lamentations, Ecclesiastes, and Esther. Of these, the *Song of Songs*, in exquisite poetry, extols the power and sweetness of pure and faithful human love. The date at which it was written is uncertain; there are features in it which point to its having been the work of a poet living

in north Israel, and writing at an early date; but most recent scholars, on account chiefly of certain late expressions occurring in it, think that it cannot have been written earlier than the 4th or 3rd century B.C. In the graceful and tender idyll of *Ruth*, it is told how Ruth, the Moabitess, and a native consequently of a country hostile theologically to Israel, adopted Israel's faith (i. 16), and was counted worthy to become an ancestress of David. The date of *Ruth* is disputed: Driver has defended a pre-exilic date for it, but the general opinion of modern scholars is that it belongs to the 5th century B.C. The *Lamentations* consist of five elegies on the fall of Jerusalem, and the sufferings which its people experienced in consequence; they must all have been composed not long after 586 B.C. *Ecclesiastes*, the third book belonging (see above) to the Wisdom-literature, consists of moralizings, prompted by the dark times in which the author's lot in life was cast, on the disappointments which seemed to him to be the reward of all human endeavour, and the inability of man to remedy the injustices and anomalies of society. If only upon linguistic grounds—for the Hebrew of the book resembles often that of the Mishnah more than the ordinary Hebrew of the Old Testament—*Ecclesiastes* must be one of the latest books in the Hebrew canon. It was most probably written during the Greek period towards the end of the 3rd century B.C. The book of *Esther*, which describes, with many legendary traits, how the beautiful Jewess succeeded in rescuing her people from the destruction which Haman had prepared for them, will not be earlier than the closing years of the 4th century B.C., and is thought by many scholars to be even later.

The Book of Daniel.—The aim of this book is to strengthen and encourage the pious Jews in their sufferings under the persecution of Antiochus Epiphanes, 168-165 B.C. Chs. i.-vi. consist of narratives, constructed no doubt upon a traditional basis, of the experiences of Daniel at the Babylonian court, between 605 and 538 B.C., with the design of illustrating how God, in times of trouble, defends and succours His faithful servants. Chs. vii.-xii. contain a series of visions, purporting to have been seen by Daniel, and describing, sometimes (especially in ch. xi.) with considerable minuteness, the course of events from Alexander the Great, through the two royal lines of the Ptolemies and the Seleucidae, to Antiochus Epiphanes, dwelling in particular on the persecuting measures adopted by Antiochus against the Jews, and promising the tyrant's speedy fall (see e.g. viii. 9-14, 23-25, xi. 21-45). Internal evidence shows clearly that the book cannot have been written by Daniel himself; and that it must in fact be a product of the period in which its interest culminates, and the circumstances of which it so accurately reflects, i.e. of 168-165 B.C.

Chronicles, Ezra and Nehemiah.—These books form the second series of historical books referred to above, *Ezra* and *Nehemiah* carrying on the narrative of *Chronicles*, and forming its direct sequel. 1 Chr. i.-ix. consists mostly of tribal genealogies, partly based upon data contained in the older books (Gen.-Kings), partly including materials found by the compiler elsewhere. 1 Chr. x.-2 Chr. xxxvi. consists of a series of excerpts from the books of Samuel and Kings—sometimes transcribed without substantial change, at other times materially altered in the process—combined with matter, in some cases limited to a verse or two, in others extending to several chapters, contributed by the compiler himself, and differing markedly from the excerpts from the older books both in phraseology and in point of view. The books of *Ezra* and *Nehemiah* are of similar structure; here the sources excerpted are the Memoirs of *Ezra* and *Nehemiah*, written by themselves in the first person; viz. *Ezra* vii. 12-1x. (including the decree of Artaxerxes, vii. 12-26); *Neh. i.* 1-vii. 73, xii. 31-41, xiii.; and a narrative written in Aramaic (*Ezra* iv. 8-vi. 18); *Ezra* x. and *Neh. viii.-x.* also are in all probability based pretty directly upon the Memoirs of *Ezra*; the remaining parts of the books are the composition of the compiler. The additions of the compiler, especially in the *Chronicles*, place the old history in a new light; he invests it with the associations of his own day; and pictures pre-exilic Judah as already possessing the fully developed ceremonial

system, under which he lived himself, and as ruled by the ideas and principles current among his contemporaries. There is much in his representation of the past which cannot be historical. For examples of narratives which are his composition see 1 Chr. xv. 1-24, xvi. 4-42, xvii. 2-xxix.; 2 Chr. xiii. 3-22, xiv. 6-xv. 15, xvi. 7-11, xvii., xix. 1-xx. 30, xxvi. 16-20, xxix. 3-xxxi. 21. On account of the interest shown by the compiler in the ecclesiastical aspects of the history, his work has been not inaptly called the "Ecclesiastical Chronicle of Jerusalem." From historical allusions in the book of Nehemiah, it may be inferred that the compiler wrote at about 300 B.C. (S. R. D.)

2. Texts and Versions.

Text.—The form in which the Hebrew text of the Old Testament is presented to us in all MSS. and printed editions is that of the Massoretic text, the date of which is usually placed somewhere between the 6th and 8th centuries of the Christian era. It is probable that the present text became fixed as early as the 2nd century A.D., but even this earlier date leaves a long interval between the original autographs of the Old Testament writers and our present text. Since the fixing of the Massoretic text the task of preserving and transmitting the sacred books has been carried out with the greatest care and fidelity, with the result that the text has undergone practically no change of any real importance; but before that date, owing to various causes, it is beyond dispute that a large number of corruptions were introduced into the Hebrew text. In dealing, therefore, with the textual criticism of the Old Testament it is necessary to determine the period at which the text assumed its present fixed form before considering the means at our disposal for controlling the text when it was, so to speak, in a less settled condition.

An examination of the extant MSS. of the Hebrew Old Testament reveals two facts which at first sight are somewhat remarkable.

The first is that the oldest dated MS., the *Codex Massoretic* *Babylonicus Petropolitanus*, only goes back to the year

A.D. 916, though it is probable that one or two MSS.

belong to the 9th century. The second fact is that all our Hebrew MSS. represent one and the same text, viz. the Massoretic. This text was the work of a special guild of trained scholars called Massoretes (מסורתיים) or "masters of tradition" (סופרים or less correctly מסריים),¹ whose aim was not only to preserve and transmit the consonantal text which had been handed down to them, but also to ensure its proper pronunciation. To this end they provided the text with a complete system of vowel points and accents.² Their labours further included the compilation of a number of notes, to which the term *Massorah* is now usually applied. These notes for the most part constitute a sort of index of the peculiarities of the text, and possess but little general interest. More important are those passages in which the Massoretes have definitely adopted a variation from the consonantal text. In these cases the vowel points attached to the written word (*Kethibb*) belong to the word which is to be substituted for it, the latter being placed in the margin with the initial letter of *Qere* (= to be read) prefixed to it. Many even of these readings merely relate to variations of spelling, pronunciation or grammatical forms; others substitute a more decent expression for the coarser phrase of the text, but in some instances the suggested reading really affects the sense of the passage. These last are to be regarded either as old textual

variants, or, more probably, as emendations corresponding to the *errata* or *corrigenda* of a modern printed book. They do not point to any critical editing of the text; for the aim of the Massoretes was essentially conservative. Their object was not to create a new text, but rather to ensure the accurate transmission of the traditional text which they themselves had received. Their work may be said to culminate in the vocalized text which resulted from the labours of Rabbi Aaron ben Asher in the 10th century.³ But the writings of Jerome in the 4th, and of Origen in the 3rd century both testify to a Hebrew text practically identical with that of the Massoretes. Similar evidence is furnished by the Mishna and the Gemara, the Targums, and lastly by the Greek version of Aquila,⁴ which dates from the first half of the 2nd century A.D. Hence it is hardly doubtful that the form in which we now possess the Hebrew text was already fixed by the beginning of the 2nd century. On the other hand, evidence such as that of the *Book of Jubilees* shows that the form of the text still fluctuated considerably as late as the 1st century A.D., so that we are forced to place the fixing of the text some time between the fall of Jerusalem and the production of Aquila's version. Nor is the occasion far to seek. After the fall of Jerusalem the new system of biblical exegesis founded by Rabbi Hillel reached its climax at Jamnia under the famous Rabbi Aqiba (d. c. 132). The latter's system of interpretation was based upon an extremely literal treatment of the text, according to which the smallest words or particles, and sometimes even the letters of scripture, were invested with divine authority. The inevitable result of such a system must have been the fixing of an officially recognized text, which could scarcely have differed materially from that which was finally adopted by the Massoretes. That the standard edition was not the result of the critical investigation of existing materials may be assumed with some certainty.⁵ Indeed, it is probable, as has been suggested,⁶ that the manuscript which was adopted as the standard text was an old and well-written copy, possibly one of those which were preserved in the Court of the Temple.

But if the evidence available points to the time of Hadrian as the period at which the Hebrew text assumed its present form, it is even more certain that prior to that date the various MSS. of the Old Testament differed very materially from one another. Sufficient proof of this statement is furnished by the Samaritan Pentateuch and the versions, more especially the Septuagint. Indications also are not wanting in the Hebrew text itself to show that in earlier times the text was treated with considerable freedom. Thus, according to Jewish tradition, there are eighteen⁷ passages in which the older scribes deliberately altered the text on the ground that the language employed was either irreverent or liable to misconception. Of a similar nature are the changes introduced into proper names, e.g. the substitution of *bosheth* (= shame) for *ba'al* in Ishbosheth (2 Sam. ii. 8) and Mephibosheth (2 Sam. ix. 6; cf. the older forms Eshbaal and Meribaal, 1 Chron. viii. 34, 35); the use of the verb "to bless" (ברך) in the sense of cursing (1 Kings xxi. 10, 13; Job i. 5, 11, ii. 5, 9; Ps. x. 3); and the insertion of "the enemies of" in 1 Sam. xxv. 2, 2 Sam. xii. 14. These intentional alterations, however, only affect a very limited portion of the text, and, though it is possible that other changes were introduced at different times, it is very

¹ This represents the Western tradition as opposed to the Eastern text of ben Naphtali. For the standard copies such as the *Codex Hillelis* referred to by later writers see H. L. Strack, *Proleg. Critica*, pp. 14 f.

² Cf. F. C. Burkitt, *Fragments of the Books of Kings according to the Translation of Aquila*.

³ The Talmudic story of the three MSS. preserved in the court of the temple (*Sopherim*, vi. 4) sufficiently illustrates the tentative efforts of the rabbis in this direction.

⁴ W. Robertson Smith, *Old Testament and the Jewish Church*, pp. 69 f.

⁵ For these *Tiqqun Sopherim* or "corrections of the scribes" see Geiger, *Urschriftl.*, pp. 308 f.; Strack, *Prolegomena Critica*, p. 87; Buhl, *Canon and Text of the Old Testament*, pp. 103 f. In the *Mekilta* (Exod. xv. 7) only eleven passages are mentioned. Less important are the *Iture Sopherim*, or five passages in which the scribes have omitted a *wa* from the text.

¹ For a discussion of this word see W. Bacher (*J.Q.R.*, vol. iii. pp. 785 f.), who maintains that the original pronunciation of these words was *סופרים* and *סופרים*.

² The actual date of the introduction of vowel points is not known, but it must in any case have been later than the time of Jerome, and is probably to be assigned to the 7th century. Of the systems of punctuation which are known to us, the more familiar is the Tiberian, or sublinear, which is found in all printed editions of the Hebrew Bible. The other system, the Babylonian or superlinear, is chiefly found in certain Yemen MSS. For yet a third system of vocalization see M. Friedländer, *J.Q.R.*, 1895, pp. 504 f., and P. Kahle in *Z.A.T.F.* xxi. (1901), pp. 273 f. Probably the idea of providing vowel points was borrowed from the Syrians.

unlikely that they were either more extensive in range or more important in character. At the same time it is clear both from internal and external evidence that the archetype from which our MSS. are descended was far from being a perfect representative of the original text. For a comparison of the different parallel passages which occur in the Old Testament (e.g. 1 and 2 Samuel, 1 and 2 Kings, and 1 and 2 Chronicles; 2 Kings xviii. 13-xx. 19 and Isaiah xxxvi-xxxix; 2 Sam. xxii. and Ps. xviii. 13. xv. and liii., &c.) reveals many variations which are obviously due to textual corruption, while there are many passages which in their present form are either ungrammatical, or inconsistent with the context or with other passages. Externally also the ancient versions, especially the Septuagint, frequently exhibit variations from the Hebrew which are not only intrinsically more probable, but often explain the difficulties presented by the Massoretic text. Our estimate of the value of these variant readings, moreover, is considerably heightened when we consider that the MSS. on which the versions are based are older by several centuries than those from which the Massoretic text was derived; hence the text which they presuppose has no slight claim to be regarded as an important witness for the original Hebrew. "But the use of the ancient versions" (to quote Prof. Driver)¹ "is not always such a simple matter as might be inferred. . . . In the use of the ancient versions for the purposes of textual criticism there are three precautions which must always be observed; we must reasonably assure ourselves that we possess the version itself in its original integrity; we must eliminate such variants as have the appearance of originating merely with the translator; the remainder, which will be those that are due to a difference of text in the MS. (or MSS.) used by the translator, we must then compare carefully, in the light of the considerations just stated, with the existing Hebrew text, in order to determine on which side the superiority lies."

Versions.—In point of age the Samaritan Pentateuch furnishes the earliest external witness to the Hebrew text. It is not a version, but merely that text of the Pentateuch which has been

Samaritan. preserved by the Samaritan community since the time of Nehemiah (Neh. xiii. 23-31), i.e. about 432 B.C.

It is written in the Samaritan script, which is closely allied to the old Hebrew as opposed to the later "square" character. We further possess a Samaritan Targum of the Pentateuch written in the Samaritan dialect, a variety of western Aramaic, and also an Arabic translation of the five books of the law; the latter dating perhaps from the 11th century A.D. or earlier. The Samaritan Pentateuch agrees with the Septuagint version in many passages, but its chief importance lies in the proof which it affords as to the substantial agreement of our present text of the Pentateuch, apart from certain intentional changes,² with that which was promulgated by Ezra. Its value for critical purposes is considerably discounted by the late date of the MSS., upon which the printed text is based.

The Targums, or Aramaic paraphrases of the books of the Old Testament (see TARGUM), date from the time when Hebrew had become superseded by Aramaic as the language spoken

Aramaic. by the Jews, i.e. during the period immediately preceding the Christian era. In their written form, however, the earlier Targums, viz. those on the Pentateuch and the prophetic books, cannot be earlier than the 4th or 5th century A.D. Since they were designed to meet the needs of the people and had a directly edificatory aim, they are naturally characterized by expansion and paraphrase, and thus afford invaluable illustrations of the methods of Jewish interpretation and of the development of Jewish thought. The text which they exhibit is virtually identical with the Massoretic text.

The earliest among the versions as well as the most important for the textual criticism of the Old Testament is the Septuagint.

Septuagint. This version probably arose out of the needs of the Greek-speaking Jews of Alexandria in the 3rd century B.C. According to tradition the law was translated into Greek during the reign of Ptolemy Philadelphus (284-247 B.C.), and, though the form (viz. the *Letter of Aristeas*) in which this tradition

¹ *Text of the Books of Samuel*, pp. xxxix. f.

² According to Josephus (*Ant. xi. 7. 8*) the temple on Mt. Gerizim was set up by Manasseh in the reign of Darius Codomannus, i.e. about 332 B.C. It is possible that he is correct in placing the building of the temple at the later date, but probably he errs in connecting it with the secession of Manasseh, which, according to Nehemiah, occurred a century earlier; it has been suggested that he has confused Darius Codomannus with his predecessor, Darius Nothus.

³ e.g. Ex. xx. 17. 19 ff.; Num. xx. f.; Deut. xxvii. 4.

has come down to us cannot be regarded as historical, yet it seems to have preserved correctly both the date and the locality of the version. The name Septuagint, strictly speaking, only applies to the translation of the Pentateuch, but it was afterwards extended to include the other books of the Old Testament as they were translated. That the interval which elapsed before the Prophets and the Hagiographa were also translated was no great one is shown by the prologue to Sirach, which speaks of "the Law, the Prophets, and the rest of the books," as already current in a translation by 132 B.C. The date at which the various books were combined into a single work is not known, but the existence of the Septuagint as a whole may be assumed for the 1st century A.D., at which period the Greek version was universally accepted by the Jews of the Dispersion as Scripture, and from them passed on to the Christian Church.

The position of the Septuagint, however, as the official Greek representative of the Old Testament did not long remain unchallenged. The opposition, as might be expected, came from the side of the Jews, and was due partly to the controversial use which was made of the version by the Christians, but chiefly to the fact that it was not sufficiently in agreement with the standard Hebrew text established by Rabbi Aqiba and his school. Hence arose in the 2nd century A.D. the three new versions of Aquila, Symmachus and Theodotion. Aquila was a Jewish proselyte of Pontus, and since he was a disciple of Rabbi Aqiba (i.e. A.D. 135), and (according to another Talmudic account) also of Rabbi Eliezer and Rabbi Joshua, the immediate predecessors of Aqiba, his version may be assigned to the first half of the 2nd century. It is characterized by extreme literalness, and clear reflections of the peculiar system of exegesis which was in vogue among the Jewish rabbis; its slavish adherence to the original caused the new translation to be received with favour by the Hellenistic Jews, among whom it quickly superseded the older Septuagint. For what remains of this version, which owing to its character is of the greatest value to the textual critic, we have until recently been indebted to Origen's *Hexapla* (see below); for, though Jerome mentions a *secunda editio*, no MS. of Aquila's translation has survived. Fragments,⁴ however, of two codices were discovered (1897) in the genizah at Cairo, which illustrate more fully the peculiar features of this version.

The account of Theodotion's secession is somewhat conflicting. Both Irenaeus and Epiphanius describe him as a Jewish proselyte, but while the former calls him an Ephesian and mentions his translation before that of Aquila, the latter states that he was a native of Pontus and a follower of Marcion, and further assigns his work to the reign of Commodus (A.D. 180-192); others, according to Jerome, describe him as an Ebionite. On the whole it is probable that Irenaeus has preserved the most trustworthy account.⁵ Theodotion's version differs from those of Aquila and Symmachus in that it was not an independent translation, but rather a revision of the Septuagint on the basis of the current Hebrew text. It retained, however, those passages of which there was no Hebrew equivalent, and added translations of the Hebrew where the latter was not represented in the Septuagint. A peculiar feature of his translation is his excessive use of transliteration, but, apart from this, his work has many points of contact with the Septuagint, which it closely resembles in style; hence it is not surprising to find that later MSS. of the Septuagint have been largely influenced by Theodotion's translation. In the case of the book of Daniel, as we learn from Jerome (*prolatio in Dan.*), the translation of Theodotion was definitely adopted by the Church, and is accordingly found in the place of the original Septuagint in all MSS. and editions.⁶ It is interesting to note in this connexion that renderings which agree in the most remarkable manner with Theodotion's version of Daniel are found not only in writers of the 2nd century but also in the New Testament. The most probable explanation of this phenomenon is that these renderings are derived from an early Greek translation, differing from the Septuagint proper, but closely allied to that which Theodotion used as the basis of his revision.

Symmachus, according to Eusebius and Jerome, was an Ebionite; Epiphanius represents him (very improbably) as a Samaritan who became a Jewish proselyte. He is not mentioned by Irenaeus and his date is uncertain, but probably his work is to be assigned to the

⁴ 1 Kings xx. 7-17; 2 Kings xxiii. 12-17, ed. by Mr (now Professor) F. C. Burkitt in *Fragments of the Books of Kings according to the Translation of Aquila* (Cambridge, 1897), and Ps. xc. 6-13; xci. 4-10, and Ps. xxiii. by Dr C. Taylor in *Sayings of the Jewish Fathers* (2nd ed., 1897).

⁵ On the question of Theodotion's date, Schrür (*Geschichte des jüdischen Volkes*, Bd. iii. p. 324) argues very plausibly for his priority to Aquila on the grounds, (1) that Irenaeus mentions him before Aquila, and (2) that, after Aquila's version had been adopted by the Greek Jews, a work such as that of Theodotion would have been somewhat superfluous. Theodotion's work, he suggests, formed the first stage towards the establishment of a Greek version which should correspond more closely with the Hebrew. Moreover, from theory affords the simplest explanation of its disappearance from Jewish tradition.

⁶ Only one MS. of the Septuagint version of Daniel has survived, the *Codex Chisianus*.

end of the 2nd century. His version was commended by Jerome as giving the sense of the original, and in that respect it forms a direct contrast with that of Aquila. Indeed Dr Swete¹ thinks it probable that "he wrote with Aquila's version before him, (and that) in his efforts to recast it he made free use both of the Septuagint and of Theodotion."

As in the case of Aquila, our knowledge of the works of Theodotion and Symmachus is practically limited to the fragments that have been preserved from the labors of Origen. This writer (*Origen's Hexapla.*) conceived the idea of collecting all the existing Greek versions of the Old Testament with a view to recovering the original text of the Septuagint, partly by their aid and partly by means of the current Hebrew text. He accordingly arranged the texts to be compared in six² parallel columns in the following order:—(1) the Hebrew text; (2) the Hebrew transliterated into Greek letters; (3) Aquila; (4) Symmachus; (5) the Septuagint; and (6) Theodotion. In the Septuagint column he drew attention to those passages for which there was no Hebrew equivalent by prefixing an obelus; but where the Septuagint had nothing corresponding to the Hebrew text he supplied the omissions, chiefly but not entirely from the translation of Theodotion, placing an asterisk at the beginning of the interpolation; the close of the passage to which the obelus or the asterisk was prefixed was denoted by the metobelus. That Origen did not succeed in his object of recovering the original Septuagint is due to the fact that he started with the false conception that the original text of the Septuagint must be that which coincided most nearly with the current Hebrew text. Indeed, the result of his monumental labours has been to impede rather than to promote the restoration of the genuine Septuagint. For the Hebrew text which he regarded as original or as the primary of the most characteristic features of the old version, but also exercised a prejudicial influence on the MSS. of that version.

The *Hexapla* as a whole was far too large to be copied, but the revised Septuagint text was published separately by Eusebius and Pamphilus, and was extensively used in Palestine during the 4th century. During the same period two other recensions made their appearance, that of Hesychius which was current in Egypt, and that of Lucian which became the accepted text of the Antiochene Church. Of Hesychius little is known. His revision is to be found in the Egyptian MSS. especially the *Codex Marchalianus*, and in the quotations of Cyril of Alexandria. Lucian was a priest of Antioch who was martyred at Nicomedia in A.D. 311 or 312. His revision (to quote Dr Swete) "was doubtless an attempt to revise the *κοινή* or 'common text' of the Septuagint in accordance with the principles of criticism which were accepted at Antioch." To Ceriani is due the discovery that the text preserved by codices 19, 82, 93, 108, really represents Lucian's recension; the same conclusion was reached independently by Lagarde, who combined codex 118 with the four mentioned above. Field (*Hexapla*, p. 87) has shown, this discovery is confirmed by the marginal readings of the *Hexapla*. The recension (see Driver, *Notes on the Hebrew Text of the Books of Samuel*, p. 52) is characterized by the substitution of synonyms for the words originally used by the Septuagint, and by the frequent occurrence of double renderings, but its chief claim to critical importance rests on the fact that "it embodies renderings not found in other MSS. of the Septuagint which presuppose a Hebrew original self-evidently superior in the passages concerned to the existing Massoretic text."

Latin Versions.—Of even greater importance in this respect is the Latin version which undoubtedly represents a Greek original prior to the *Hexapla*. "The earliest form of the version" (to quote Dr Kennedy³) "to which we can assign a definite date, namely, that used by Cyprian, plainly circulated in Africa." In the view of many authorities this version was first produced at Carthage, but recent writers are inclined to remark Antioch as its birthplace, a view which is supported by the remarkable agreement of its readings with the Lucianic recension and with the early Syriac MSS. Unfortunately the version is only extant in a fragmentary form, being preserved partly in MSS., partly in quotations of the Latin Fathers, and the non-canonical books of the Vulgate, however, which do not appear to have been revised by Jerome, still represent the older version. It was not until after the 6th century that the Old Latin was finally superseded by the Vulgate or Latin translation of the Old Testament made by Jerome during the last quarter of the 4th century. This new version was translated

from the Hebrew, but Jerome also made use of the Greek versions, more especially of Symmachus. His original intention was to revise the Old Latin, and his two revisions of the Psalter, the Roman and the Gallican, the latter modelled on the *Hexapla*, still survive. Of the other books which he revised according to the Hexaplar text, that of Job has alone come down to us. For textual purposes the Vulgate possesses but little value, since it presupposes a Hebrew original practically identical with the text stereotyped by the Massoretic.

Syriac Versions.—The Peshito (P'shitta) or "simple" revision of the Old Testament is a translation from the Hebrew, though certain books appear to have been influenced by the Septuagint. Its date is unknown, but it is usually assigned to the 2nd century A.D. Its value for textual purposes is not great, partly because the underlying text is the same as the Massoretic, partly because the Syriac text has at different times been harmonized with that of the Septuagint.

The Syro-Hexaplar version, on the other hand, is extremely valuable for critical purposes. This Syriac translation of the Septuagint column of the *Hexapla* was made by Paul, bishop of Tella, at Alexandria in A.D. 616-617. Its value consists *Syro-Hexaplar.* in the extreme literalness of the translation, which renders it possible to recover the Greek original with considerable certainty. It has further preserved the critical signs employed by Origen as well as many readings from the other Greek versions; hence it forms our chief authority for reconstructing the *Hexapla*. The greater part of this work is still extant; the poetical and prophetic books have been preserved in the *Codex Ambrosianus* at Milan (published in photolithography by Ceriani, *Mon. Sacr. et Prof.*), and the remaining portions of the other books have been collected by Lagarde in his *Bibliotheca Syriaca*, &c.

Of the remaining versions of the Old Testament the most important are the Egyptian, Ethiopic, Arabic, Gothic and Armenian, all of which, except a part of the Arabic, appear to have been made through the medium of the Septuagint.

AUTHORITIES.—Wellhausen-Bleek, *Einführung in das alte Testament* (4th ed., Berlin, 1878, pp. 571 ff., or 5th ed., Berlin, 1886, pp. 523 ff.); S. R. Driver, *Notes on Samuel* (Oxford, 1890), Introd. §§ 3, 4; W. Robertson Smith, *Old Testament in the Jewish Church* (2nd ed., London, 1892); F. G. Kenyon, *Our Bible and the Ancient MSS.* (London, 1892); T. H. Weir, *A Short History of the Hebrew Text* (London, 1896); H. B. Swete, *Introduction to the Old Testament in Greek* (Cambridge, 1900); F. Buhl, *Kanon u. Text des A.T.* (English trans., Edinburgh, 1892); E. Schröder, *Geschichte des jüdischen Volkes* (3rd ed., 1902), vol. iii. § 33; C. H. Cornill, *Einführung in das alte Testament* (4th ed., 1896), and *Prolegomena to Eschiel* (Leipzig, 1886); H. L. Strack, *Einführung in das alte Testament, Prolegomena Critica in Vet. Test.* (Leipzig, 1873); A. Loisy, *Histoire critique du texte et des versions de la bible* (Amiens, 1892); E. Nestle, *Urtext und Übersetzungen der Bibel* (Leipzig, 1897); Ed. König, *Einführung in das alte Testament* (Bonn, 1893); F. Field, *Origines Hexaplorum quae supersunt*, &c.; A. Dillmann and F. Buhl, article on "Bibeltext des A.T." in *P.R.E.* vol. ii.; Ch. D. Ginsburg, *Introduction to the Massoretic-critical edition of the Bible* (London, 1897), and *The Massorah* (London, 1880-1885). (J. F. St.)

3. Textual Criticism.

The aim of scientific Old Testament criticism is to obtain, through discrimination between truth and error, a full appreciation of the literature which constitutes the Old Testament, of the life out of which it grew, and the secret of the influence which these have exerted and still exert. For such an appreciation many things are needed; and the branches of Old Testament criticism are correspondingly numerous. It is necessary in the first instance to detect the errors which have crept into the text in the course of its transmission, and to recover, so far as possible, the text in its original form; this is the task of *Textual*, or as it is sometimes called in contradistinction to another branch, *Lower Criticism*. It then becomes the task of critical exegesis to interpret the text thus recovered so as to bring out the meaning intended by the original authors. This *Higher Criticism* partakes of two characters, literary and historical. One branch seeks to determine the scope, purpose and character of the various books of the Old Testament, the times in and conditions under which they were written, whether they are severally the work of a single author or of several, whether they embody earlier sources and, if so, the character of these, and the conditions under which they have reached us, whether altered and, if altered, how; this is *Literary Criticism*. A further task is to estimate the value of this literature as evidence for the history of Israel, to determine, as far as possible, whether such parts of the literature as are contemporary with the time described present correct, or whether

Distinction between Textual and Higher Criticism.

¹ *Introduction to the Old Testament in Greek*, p. 51.

² Hence the name *Hexapla*. In some books, especially the poetical, the columns were increased to eight by the addition of the *Quinta* and *Sexta*, but the *Octapla*, as the enlarged work was called, was not apparently a distinct work. The *Tetrapla*, on the other hand, was a separate edition which did not contain the first two columns of the *Hexapla*.

³ Lagarde's projected edition of the Lucianic recension was unfortunately never completed; the existing volume contains Genesis -2 Esdras, Esther. It may be noted here that the Complutensian Polyglot represents a Lucianic text.

⁴ Hastings's *Dict. of the Bible*, iii. pp. 54 ff.

in any respect one-sided or biased or otherwise incorrect, descriptions; and again, how far the literature that relates the story of long past periods has drawn upon trustworthy records, and how far it is possible to extract historical truth from traditions (such as those of the Pentateuch) that present, owing to the gradual accretions and modifications of intervening generations, a composite picture of the period described, or from a work such as Chronicles, which narrates the past under the influence of the conception that the institutions and ideas of the present must have been established and current in the past; all this falls under *Historical Criticism*, which, on its constructive side, must avail itself of all available and well-sifted evidence, whether derived from the Old Testament or elsewhere, for its presentation of the history of Israel—its ultimate purpose. Finally, by comparing the results of this criticism as a whole, we have to determine, by observing its growth and comparing it with others, the essential character of the religion of Israel.

In brief, then, the criticism of the Old Testament seeks to discover what the words written actually meant to the writers, what the events in Hebrew history actually were, what the religion actually was; and hence its aim differs from the dogmatic or homiletic treatments of the Old Testament, which have sought to discover in Scripture a given body of dogma or incentives to a particular type of life or the like.

Biblical criticism, and in some respects more especially Old Testament criticism, is, in all its branches, very largely of modern growth. This has been due in part to the removal of conditions unfavourable to the critical study of the evidence that existed, in part to the discovery in recent times of fresh evidence. The unfavourable conditions and the critical efforts which were made in spite of them can only be briefly indicated.

For a long time Biblical study lacked the first essential of sound critical method, viz. a critical text of the literature. Jewish study was exclusively based on the official Hebrew text, which was fixed, probably in the 2nd century A.D., and thereafter scrupulously preserved. This text, however, had suffered certain now obvious corruptions, and, probably enough, more corruption than can now, or perhaps ever will be, detected with certainty. The position of Christian (and Jewish Alexandrian) scholars was considerably worse; for, with rare exceptions, down to the 5th century, and practically without exception between the 5th and 15th centuries, their study was exclusively based on translations. Beneath the ancient Greek version, the Septuagint, there certainly underlay an earlier form of the Hebrew text than that perpetuated by Jewish tradition, and if Christian scholars could have worked through the version to the underlying Hebrew text, they would often have come nearer to the original meaning than their Jewish contemporaries. But this they could not do; and since the version, owing to the limitations of the translators, departs widely from the sense of the original, Christian scholars were on the whole kept much farther from the original meaning than their Jewish contemporaries, who used the Hebrew text; and later, after Jewish grammatical and philological study had been stimulated by intercourse with the Arabs, the relative disadvantages under which Christian scholarship laboured increased. Still there are not lacking in the early centuries A.D. important, if limited and imperfect, efforts in textual criticism. Origen, in his *Hexapla*, placed side by side the Hebrew text, the Septuagint, and certain later Greek versions, and drew attention to the variations; he thus brought together for comparison, an indispensable preliminary to criticism, the chief existing evidence to the text of the Old Testament. Unfortunately this great work proved too voluminous to be preserved entire; and in the form in which it was fragmentarily preserved, it even largely enhanced the critical task of later centuries. Jerome, perceiving the unsatisfactory position of Latin-speaking Christian scholars who studied the Old Testament at a *double remove* from the original—in Latin versions of the Greek—made a fresh Latin translation direct from the Hebrew text then received among the Jews. It is only in accordance with what constantly recurs in the history of Biblical criticism that this effort to approximate to the truth met at first

with considerable opposition, and was for a time regarded even by Augustine as dangerous. Subsequently, however, this version of Jerome (the Vulgate) became the basis of Western Biblical scholarship. Henceforth the Western Church suffered both from the corruptions in the official Hebrew text and also from the fact that it worked from a version and not from the original, for a knowledge of Hebrew was rare indeed among Christian scholars between the time of Jerome and the 16th century.

But if the use of versions, or of an uncritical text of the original, was one condition unfavourable to criticism, another that was not less serious was the dominance over both Jews and Christians of unsound methods of interpretation—legal or dogmatic or allegorical. The influence of these can be traced as early as the Greek version (3rd century B.C. and later); allegorical interpretation is conspicuous in the Alexandrian Jewish scholar Philo (*q.v.*); it may be seen in many New Testament interpretations of the Old Testament (e.g. Gal. iii. 16, iv. 21-31), found a classical exponent in Origen, and, in spite of the opposition of the school of Antioch, pre-eminently of Theodore (d. A.D. 428), maintained its power virtually unbroken down to the Reformation. It is true that even by the most thorough-going allegorists the literal sense of Scripture was not openly and entirely disregarded; but the very fact that the study of Hebrew was never more than exceptional, and so early ceased to be cultivated at all, is eloquent of indifference to the original literal sense, and the very principle of the many meanings inherent in the sacred writings was hostile to sound interpretation; greater importance was attached to the "deeper" or "hidden" senses, i.e. to the various unreal interpretations, and when the literal sense conflicted with the dogmas or tradition of the Church its validity was wholly denied. The extraordinary ambiguity and uncertainty which allegorical interpretation tacitly ascribed to Scripture, and the ease with which heretical as well as orthodox teaching could be represented as "hidden" under the literal sense, was early perceived, but instead of this leading to any real check on even wild subjectivity in interpretation and insistence on reaching the literal sense, it created an ominous principle that maintained much of its influence long after the supremacy of allegorism was overthrown. This is the principle that all interpretation of Scripture must be according to the *Regula fidei*—that all interpretation which makes Scripture contradict or offend the traditions of the Church is wrong.

The spirit and the age of humanism and the Reformation effected and witnessed important developments in the study of the Old Testament. It was still long before any considerable results were achieved; but in various ways the dogmatic and traditional treatment of Scripture was undermined; the way was opened for a more real and historical method. It must suffice to refer briefly to two points.

I. Ignorance gave place to knowledge of the languages in which the Old Testament was written. In 1506 the distinguished humanist, Johann Reuchlin, who had begun the study of Hebrew under a Jewish teacher about 1492, published a work entitled *De Rudimentis Hebraicis* containing a Hebrew lexicon and a Hebrew grammar. In 1504 Konrad Pellicanus (Pellicanus), whose study of Hebrew had profited from intercourse with Reuchlin, had published a brief introduction to the language. In 1514 the Complutensian Polyglott began to be printed and in 1522 was published. Various Jewish editions of the Hebrew Bible had already been printed—in part since 1477, entire since 1488; but this work contained the first Christian edition of the text. Certainly the editors did not intend hereby to exalt the original above the versions; for they placed the Vulgate in the centre of the page with the Hebrew on one side, the Greek on the other, i.e. as they themselves explained it, the Roman Church between the synagogue and the Greek Church, as Christ crucified between two thieves. Yet even so the publication of the Hebrew text by Christian scholars marks an important stage; henceforth the study of the original enters increasingly into Christian Biblical scholarship; it already underlay the translations which form so striking a feature of the 16th century. Luther's German version (Pentateuch, 1523) and Tyndale's English version (Pentateuch, 1530) were both made from the Hebrew. At first, and indeed down to the middle of the 17th century, Jewish traditions and methods in the study of Hebrew dominated Christian scholars; but in the 17th and 18th centuries the study of other Semitic languages opened up that comparative linguistic study which was systematized and brought nearer to perfection in the 19th century

(which also witnessed the opening up of the new study of Assyrian) by scholars such as Gesenius, Ewald, Olshausen, Renan, Noldeke, Stade and Driver. This has done much to render possible a more critical interpretation of the Old Testament.

2. An increasing stress was laid on the *literal* sense of Scripture. The leading Reformers—Luther, Zwingli, Melancthon—frequently expressed themselves against the prevailing view of the manifold sense of Scripture, and in particular questioned the legitimacy of allegorical interpretation—except for purposes of popular and practical exhortation. The effort to get at and abide by the literal sense is characteristic of Calvin's extensive exegetical works. True, practice did not always keep pace with theory, and the literal sense had to yield if it came into conflict with the "Faith": the allegorical method for long obscured the meaning of the *Song of Songs*, and any departure from it was severely condemned; just as Theodore of Mopsuestia drew down on himself for maintaining the literal sense of the *Song* the condemnation of the Second Council of Constantinople (A.D. 553), so Sebastian Castellio owed (in part) to the 16th and 17th centuries scholars like Grotius and Michaelis met with violent opposition for the same cause.

But, however slowly and irregularly, the new conditions and the new spirit affected the study of the Old Testament. It became subject to the same critical methods which since the Renaissance have been applied to other ancient literatures. Biblical criticism is part of a wider critical movement, but it is noticeable how, from stage to stage, Biblical scholars adopted the various critical methods which as applied to other literatures have been proved valid, rather than themselves initiated them. The textual criticism of the classical literatures made way before the textual criticism of the Old Testament; Bentley's *Phalaris* (1669) preceded any thorough or systematic application of Higher Criticism to any part of the Old Testament; Niebuhr's *History of Rome* (1811) preceded Ewald's *History of Israel* (1843-1859).

The fundamental principles of the Textual Criticism of the Old Testament are the same as those which apply to any other ancient text and need not be described here (see the article TEXTUAL CRITICISM). There are also, however, certain conditions peculiar to the text of the Old Testament. The significance of these and the extent to which they must govern the application of the general principles have even yet scarcely obtained full and general recognition. These, then, must be briefly described.

The earliest Hebrew MSS. of the Old Testament date from not earlier than the 9th century A.D., or nearly one thousand years after the latest parts of the Old Testament were written. These MSS., and the Hebrew Bibles as usually printed, contain in reality two perfectly distinct texts—the work of two different ages separated from one another by centuries: the one is a text of the Old Testament itself, the other a text of a later Jewish interpretation of the Old Testament. The text of the Old Testament consists of consonants only, for the alphabet of the ancient Hebrews, like that of their Moabite, Aramaean and Phoenician neighbours, contained no vowels; the text of the interpretation consists of vowels and accents only—for vowel signs and accents had been invented by Jewish scholars between the 5th and 9th centuries A.D.; the text of the Old Testament is complete in itself and intelligible, though ambiguous; but the text of the interpretation read by itself is unintelligible, and only becomes intelligible when read with the consonants (under, over, or in which they are inserted) of the text of the Old Testament. But the fact that the later text makes use of the earlier to make itself intelligible in no way destroys the fact that it is as entirely distinct a work from the earlier as is any commentary distinct from the work on which it comments. The first task of Old Testament textual criticism after the Reformation was to prove the independence of these two texts, to gain general recognition of the fact that vowels and accents formed no part of the original Hebrew text of the Old Testament. The conflict that arose over this question in the Christian Church was prolonged and bitter—in part because it unfortunately became inflamed by the contending interests of Roman Catholic and Protestant. The coeval origin of consonants and vowels had indeed been questioned or denied by the earliest reformers (Luther, Zwingli, Calvin), but later, in the period of Protestant scholasticism and under the influence of one school of Jewish Rabbis, Protestant scholars in particular, and especially those of the Swiss school, notably the Buxtorfs, had committed

themselves to the view that the vowels formed an integral and original part of the text of the Old Testament; and this they maintained with all the more fervency because the ambiguity of the consonants without the vowels was a troublesome fact in the way of the extreme Protestant doctrine of the inspiration, verbal infallibility and sufficiency of Scripture, while it was by no means unwelcome to Catholic theologians with their doctrine of the need for an authoritative interpretation. Still in the end it was due in large measure to the learning and argumentative power devoted to this subject by the French Protestant scholar, Louis Capell, and, amongst others, by the English Protestant scholar, Brian Walton, that by the end of the 17th century this particular controversy was practically at an end; criticism had triumphed, and the later origin of the vowels was admitted. Yet, as often happens, the influence of tradition lingered long after it had been proved to be false; thus the R.V., instead of being an independent translation of the Hebrew text, is intended (with rare exceptions, as e.g. in Is. lix. 19, where R.V. translates the Hebrew text and R.V. margin the Jewish interpretation) to be merely a translation of the Jewish interpretation; and to the present day it is usual, though obviously uncritical and wrong, to describe perfectly legitimate translations of the received consonantal text, if they happen to presuppose other vowels than those provided by Jewish tradition, as based on emendation; even in the English edition of Haupt's *Sacred Books of the Old Testament* (see below) the possibility of this unfortunate misunderstanding is not altogether removed.

But the original text of the Old Testament long before it was combined with the text of the Jewish or Massoretic interpretation had already undergone a somewhat similar change, the extent of which was indeed far less, but also less clearly discoverable. This change consisted in the insertion into the original text of certain consonants which had come to be also used to express vowel sounds: e.g. the Hebrew consonant corresponding to *w* also expressed the vowel *o* or *u*, the consonant *h* the vowel *a*, and so forth. For reasons suggested partly by the study of Semitic inscriptions, partly by comparison of passages occurring twice within the Old Testament, and partly by a comparison of the Hebrew text with the Septuagint, it is clear that the authors of the Old Testament (or at least most of them) themselves made some use of these vowel consonants, but that in a great number of cases the vowel consonants that stand in our present text were inserted by transcribers and editors of the texts. Again, and for similar reasons, it is probable that in many cases, if not in all, the original texts were written without any clear division of the consonants into words. In view of all this, the first requisite for a critical treatment of the text of the Old Testament is to consider the consonants by themselves, to treat every vowel-consonant as possibly not original, and the existing divisions of the text into words as original only in those cases where they yield a sense better than any other possible division (or, at least, as good). Certainly all this brings us face to face with much ambiguity and demands increased skill in interpretation, but anything short of it falls short also of strict critical method. A perception of this has only been gradually reached, and is even now none too general.

Apart from these changes in the history of the text, it has, like all ancient texts, suffered from accidents of transmission, from the unintentional mistakes of copyists. This fact was, naturally enough and under the same dogmatic stress, denied by those scholars who maintained that the vowels were an integral part of the text. Here again we may single out Capellus as a pioneer in criticism, in his *Critica sacra sive de variis quae in sacris V. T. libris occurrunt lectionibus*, written in 1634, much studied in MS. by scholars before its publication in 1650, and unavailingly criticized by Buxtorf the younger in his *Antieritica seu vindiciae veritatis hebraicae* (1653). Capellus drew conclusions from such important facts as the occurrence of variations in the two Hebrew texts of passages found twice in the Old Testament itself, and the variations brought to light by a comparison of the Jewish and Samaritan texts of the Pentateuch, the Hebrew

text and the Septuagint, the Hebrew text and New Testament quotations from the Old Testament.

In order that the principles already perceived by Capellus might be satisfactorily applied in establishing a critical text, many things were needed; for example, a complete collation of existing MSS. of the Jewish text and of the Samaritan text of the Pentateuch, the establishing of a critical text of the Septuagint, a careful study of the several versions directed to determining when real variants are implied and what they are. Some of this work has been accomplished: much of it remains to be done.

The Hebrew MSS. were collated by Kennicott and de Rossi at the close of the 18th century, with sufficient thoroughness to justify the important conclusion that all existing MSS. reproduce a single recension. The Samaritan MSS. are still very imperfectly collated; the same is true of the Syriac and other versions except the Septuagint. In regard to the Septuagint, though the work is by no means complete, much has been done. For collection of material the edition of Holmes and Parsons (Oxford, 1798-1827), with its magnificent critical apparatus, is pre-eminent; the preparation of a similar edition, on a rather smaller scale but embodying the results of fresh and more careful collation, was subsequently undertaken by Cambridge scholars.¹ These editions furnish the material, but neither attempts the actual construction of a critical text of the version. Some important contributions towards a right critical method of using the material collected have been made—in particular by Lagarde, who has also opened up a valuable line of critical work, along which much remains to be done, by his restoration of the Lucianic recension, one of the three great recensions of the Greek text of the Old Testament which obtained currency at the close of the 3rd and beginning of the 4th centuries A.D.

More especially since the time of Capellus the value of the Septuagint for correcting the Hebrew text has been recognized; and it has often been used uncritically, and the correctness of the Hebrew text underlying it in comparison with the text of the Hebrew MSS., though still perhaps most generally underestimated, has certainly at times been exaggerated.

It has only been possible here to indicate in the briefest way what is involved in the collection and critical sifting of the

Results of Criticism.

extant evidence for the text of the Old Testament, how much of the work has been done and how much remains; and with equal brevity it must suffice to indicate the position which faces the textual critic when all that can be done in this way has been done. In so far as it is possible to recover the Hebrew text from which the Greek version was made, it is possible to recover a form of the Hebrew text current about 280 B.C. in the case of the Pentateuch, some time before 100 B.C. in the case of most of the rest of the Old Testament. By comparison of the Hebrew MSS. it is not difficult to recover the recension which with few and unimportant variants they have perpetuated, and which may safely be regarded as differing but slightly from the text current and officially established before the end of the 2nd century A.D. By a comparison of these two lines of evidence we can approximate to a text current about 300 B.C. or later; but for any errors which had entered into the common source of these two forms of the text we possess no documentary means of detection whatsoever. The case then stands thus. Except by the obviously absurd assumption of the infallibility of copyists for the centuries before c. 300 B.C., we cannot escape the conclusion that *errors lurk even where no variants now exist, and that such errors can be corrected, if at all, only by conjectural emendation.* The dangers of conjectural emendation are well known and apparent; large numbers of such emendations have been ill-advised; but in the case of many passages the only alternative for the textual critic who is at once competent and honest is to offer such emendations or to indicate that such passages are corrupt and the means of restoring them lacking.

Conjectural emendations were offered by Capellus in the 17th, and by scholars such as C. F. Houbigant, Archbishop

¹ *The Old Testament in Greek*, by A. E. Brooke and N. McLean, vol. i. pt. 1 (1906).

Secker, Bishop Lowth and J. D. Michaelis in the 18th century. Some of these have approved themselves to successive generations of scholars, who have also added largely to the store of such suggestions; conjectural emendation has been carried furthest by upholders of particular metrical theories (such as Bickell and Duhm) which do not accommodate themselves well to the existing text, and by T. K. Cheyne (in *Critica Biblica*, 1903), whose restorations resting on a dubious theory of Hebrew history have met with little approval, though his negative criticism of the text is often keen and suggestive.

A model of the application of the various resources of Old Testament textual criticism to the restoration of the text is C. H. Cornill's *Das Buch des Propheten Ezechiel* (1886): outstanding examples of important systematic critical notes are J. Wellhausen's *Der Text der Bücher Samuels* (1871) and S. R. Driver's *Notes on the Hebrew Text of the Books of Samuel* (1890). Haupt's *Sacred Books of the Old Testament*, edited by various scholars, was designed to present, when complete, a critical text of the entire Old Testament with critical notes. The results of textual criticism, including a considerable number of conjectural emendations, are succinctly presented in Kittel's *Biblia Hebraica* (1906); but the text here printed is the ordinary Massoretic (vocalized) text. The valuable editions of the Old Testament by Baer and Delitzsch, and by Ginsburg, contain *critical texts* of the Jewish interpretation of Scripture, and therefore necessarily *uncritical* texts of the Hebrew Old Testament itself: it lies entirely outside their scope to give or even to consider the evidence which exists for correcting the obvious errors in the text of the Old Testament as received and perpetuated by the Jewish interpreters. See also the authorities mentioned in the following section. (G. B. G.*)

4. Higher Criticism.

We now pass on to consider the growth of literary and historic criticism, which constitute the *Higher Criticism* as already explained. Down to the Reformation conditions were unfavourable to such criticism; the prevailing dogmatic use of Scripture gave no occasion for inquiry into the human origins or into the real purport and character of the several books. Nevertheless we find some sporadic and tentative critical efforts or questions. The most remarkable of these was made *outside* the Church—a significant indication of the adverse effect of the conditions within; the Neo-platonist philosopher Porphyry² in the 3rd century A.D., untrammelled by church tradition and methods, anticipated one of the clearest and most important conclusions of modern criticism: he detected the incorrectness of the traditional ascription of Daniel to the Jewish captivity in Babylon and discerned that the real period of its composition was that of Antiochus Epiphanes, four centuries later. In the mind even of Augustine (*Locutio in Jos. vi. 25*) questions were raised by the occurrence of the formula "until this day" in Jos. iv. 9, but were stilled by a rather clever though wrong use of Jos. vi. 25; Abelard (*Heloissae Problema*, xli.) considers the problem whether the narrative of Moses's death in Deut. contains a prophecy by Moses or is the work of another and later writer, while the Jewish scholar Ibn Ezra (Abenezra), in a cryptic note on Deut. i. 1, which has been often quoted of late years, gathers together several indications that point, as he appears to perceive, to the post-Mosaic origin of the Pentateuch. Even rarer than these rare perceptions of the evidence of the quasi-historical books to their origin are such half-perceptions of the literary origin of the prophetic books as is betrayed by Ibn Ezra, who appears to question the Isaianic authorship of Is. xl-lxvi., and by Photius, patriarch of Constantinople in the 9th century, who, according to Diestel (*Gesch. des A. T.*, 160), raises the question why the sixth chapter of Isaiah, containing the inaugural vision, does not stand at the beginning of the book.

Even after the Renaissance and the Reformation tradition continued influential. For though the Reformers were critical of the authority of ecclesiastical tradition in the matter of

² His arguments are stated briefly (and in order to be refuted) by Jerome in his commentary on *Daniel*.

the interpretation and use of Scripture, they were not immediately interested in literary and historical criticism, nor concerned to challenge the whole body of traditional lore

The Reformers. on these matters. At the same time we can see from Luther's attitude how the doctrine of the Reformers (unlike that of the Protestant scholastics who came later) admitted considerable freedom, in particular with reference to the extent of the canon, but also to several questions of higher criticism. Thus it is to Luther a matter of indifference whether or not Moses wrote the Pentateuch; the books of *Chronicles* he definitely pronounces less credible than those of *Kings*, and he considers that the books of *Isaiah*, *Jeremiah* and *Hosea* probably owe their present form to later hands. Carlstadt again definitely denied the Mosaic authorship of the Pentateuch on the ground that Moses could not have written the account of his own death and yet that Deut. xxiv. cannot be separated from the rest of the Pentateuch. The later scholastic Protestant doctrine of verbal infallibility necessarily encouraged critical reaction and proved a widely extended retarding force far down into the 19th century. Nevertheless criticism advanced by slow degrees among individuals, now in the Roman Church, now in the number of those who sat loosely to the restrictions of either Roman or Protestant authority, and now among Protestant scholars and theologians.

It would be impossible to refer here even briefly to all these, and it may be more useful to select for somewhat full description, as showing what could be achieved by, and what limitations beset, even a critical spirit in the 17th century, the survey of the origin of the Old Testament given by one such individual—Thomas Hobbes in his *Leviathan*¹ (published 1651) c. xxxiii. As far as possible this survey shall be cited verbatim.—

"Who were the original writers of the several books of Holy Scripture was not made evident by any sufficient testimony of other history, which is the only proof of matter of fact; nor can be, by any argument of natural reason: for reason serves only to convince the truth, not of fact, but of consequence. The light therefore that must guide us in this question, must be that which is held out unto us from the books themselves: and this light, though it shew us not the author of every book, yet it is not unuseful to give us knowledge of the time wherein they were written."

"And first, for the Pentateuch. . . . We read (Deut. xxiv. 6) concerning the sepulchre of Moses, 'that no man knoweth of his sepulchre to this day'; that is, to the day wherein those words were written. It is therefore manifest that these words were written after his interment. For it were a strange interpretation to say Moses spake of his own sepulchre, though by prophecy, that it was not found to that day wherein he was yet living." The suggestion that the last chapter only, not the whole Pentateuch, was written later, is met by Hobbes by reference to Gen. xii. 6 ("the Canaanite was then in the land") and Num. xxi. 14 (citation from a book relating the acts of Moses at the Red Sea and in Moab) and the conclusion reached that "the five books of Moses were written after his time, though how long after is not so manifest."

"But though Moses did not compile those books entirely, and in the form we have them, yet he wrote all that which he is there said to have written: as, for example, the volume of the Law" contained "as it seemeth" in Deut. xi.-xxvii., "and this is that Law which . . . having been lost, was long time after found again by Hilkiah and sent to King Josiah (2 Kings xxii. 8)."

"The books of Joshua, Judges, Ruth, Samuel are proved much later than the times recorded in them by the numerous passages which speak of customs, conditions, &c., remaining 'unto this day,' and Judges in particular by xviii. 30, "where it is said that 'Jonathan and his sons were priests to the tribe of Dan, until the day of the captivity of the land.'"

"As for *Kings* and *Chronicles*, "besides the places which mention such monuments as, the writer saith, remained till his own days" (Hobbes here cites thirteen from *Kings*, two from *Chron.*), "it is argument sufficient that they were written after the captivity in Babylon, that the history of them is continued till that time. For the facts registered are always more ancient than the register; and much more ancient than such books as make mention of and quote the register, as these books do in divers places."

"Ezra and Nehemiah were written after, Esther during, or after, the captivity: Job, which is not a history but a philosophical poem, at an uncertain date. The Psalms were written mostly by David, but "some of them after the return from the captivity, as the 137th

and 126th, whereby it is manifest that the psalter was compiled and put into the form it now hath, after the return of the Jews from Babylon." The compilation of Proverbs is later than any of those whose proverbs are therein contained; but Ecclesiastes and Canticles are wholly Solomon's except the titles. There is little noticeable in Hobbes' dating of the prophets, though he considers it "not apparent" whether Amos wrote, as well as composed, his prophecy, or whether Jeremiah and the other prophets of the time of Josiah and Ezekiel, Daniel, Haggai and Zechariah, who lived in the captivity, edited the prophecies ascribed to them. He concludes: "But considering the inscriptions, or titles of their books, it is manifest enough that the whole Scripture of the Old Testament was set forth in the form we have it after the return of the Jews from their captivity in Babylon and before the time of Ptolemaeus Philadelphus."

Except in strangely making Zephaniah contemporary with Isaiah, Hobbes' conclusions, in so far as they differ from the traditional views, have been confirmed by the more thorough criticism of subsequent scholars. But apart from the special conclusions, the opening and closing considerations contain clear and important statements which still hold good. No fresh discoveries since the time of Hobbes have furnished any "testimony of other history" to the origin of the books of the Old Testament: this must still be determined by the statements and internal evidence of the Old Testament itself, and a deeper criticism has given to the final consideration that the Old Testament received its present form after the Exile a far greater significance than Hobbes perhaps guessed.

But the limitations of Hobbes' literary criticism judged from our present standpoint are great. The considerations from which he acutely and accurately draws far-reaching and important conclusions might be suggested by a very superficial examination of the literature; they involve, for example, no special philological knowledge. The effect of a deeper criticism has been (a) to give a more powerful support to some of Hobbes' conclusions; (b) to show that works (e.g. Ecclesiastes) whose traditional antiquity is left unquestioned by him are in reality of far more recent origin; (c) to eliminate the earlier sources or elements in the writings which Hobbes was content to date mainly or as a whole by their latest elements (e.g. *Pentateuch*, *Judges*, *Kings*), and thus to give to these earlier sources an historical value higher than that which would be safely attributed to them as indistinguishable parts of a late compilation.

Hobbes argues in the case of the *Pentateuch* that two authors are distinguishable—Moses and a much later compiler and editor. Spinoza, whose conclusions in his *Tractatus theologico-politicus* (1671), c. viii. ix., had in general much in common with Hobbes, drew attention in particular to the confused mixture of law and narrative in the Pentateuch, the occurrence of duplicate narratives and chronological incongruities. Father Simon in his *Histoire critique du Vieux Testament* (1682) also argues that the Pentateuch is the work of more than one author, and makes an important advance towards a systematic analysis of the separate elements by observing that the style varies, being sometimes very curt and sometimes very copious "although the variety of the matter does not require it." But none of these makes any attempt to carry through a continuous analysis.

The first attempt of this kind is that of a French Catholic physician, Jean Astruc. In a work published anonymously in 1753 under the title of *Conjectures sur les mémoires originaux dont il paroit que Moïse s'est servi pour composer le livre de la Genèse*, he argued that in Genesis and Ex. i. ii. Moses had used different documents, and that of these the two chief were distinguished by their use of different divine names—Elohim and Yahweh; by the use of this clue he gave a detailed analysis of the passages belonging to the several documents. Astruc's criteria were too slight to give to all the details of his analysis anything approaching a final analysis; but later criticism has shown that his criteria, so far as they went, were valid, and his results, broadly speaking, sound though incomplete: and, moreover, they have abundantly justified his really important fundamental theory that the documents used by the compiler of the *Pentateuch* have been incorporated so much as they lay before him that we can get

¹ In what follows the actual quotations are from his English work; some of the summaries take account of the brief expansions in his later Latin version.

behind the compiler to the earlier sources and thus push back the evidence of much of the Pentateuch beyond the date of its compilation to the earlier date of the sources. In identifying the compiler with Moses, Astruc failed to profit from some of his predecessors: and the fact that he held to the traditional (Mosaic) origin of the Pentateuch may have prevented him from seeing the similar facts which would have led him to continue his analysis into the remaining books of the Pentateuch.

For subsequent developments, and the fruitful results of documentary analysis as applied to the Pentateuch and other composite books, which cannot be dealt with in any detail here, reference must be made to the special articles on the books of the Old Testament.

The publication of the publication of Astruc's book saw also the publication of Bishop Lowth's *De sacra poesi Hebraeorum*: later Lowth. Lowth published a new translation of Isaiah with notes (1778). Lowth's contribution to a more critical appreciation of the Old Testament lies in his perception of the nature and significance of parallelism in Hebrew poetry, in his discernment of the extent to which the prophetic books are poetical in form, and in his treatment of the Old Testament as the expression of the thought and emotions of a people—in a word, as literature. Both Lowth's works were translated and became influential in Germany.

In spite of these earlier achievements, it is J. G. Eichhorn who has, not without reason, been termed the "founder of modern Old Testament criticism." Certainly the publication of his *Einleitung (Introduction to the Old Testament)*, in 1780-1783, is a landmark in the history of Old Testament criticism. An intimate friend of Herder, himself keenly interested in literature, he naturally enough treats the Old Testament as literature—like Lowth, but more thoroughly: and, as an Oriental scholar, he treats it as an Oriental literature. In both respects he was to be widely followed. His *Introduction*, consisting of three closely packed volumes dealing with textual as well as literary criticism, is the first comprehensive treatment of the entire Old Testament as literature. Much of the voluminous detailed work in this and other works is naturally enough provisional, but in the *Introduction* there emerge most of the broad conclusions of literary criticism (sometimes incomplete) which, after more than a century of keen examination by scholars unwilling to admit them, have passed by more or less general consent into the number of historical certainties or high probabilities. With his wide linguistic knowledge Eichhorn perceived that the language alone (though he also adduces other considerations) betrays the late origin of *Ecclesiastes*, which he places in the Persian Period (538-332 B.C.); *Canticles*, too, preserves linguistic features which are not of the Solomonic age. He analyses significant stylistic peculiarities such as occur, e.g., in *Isaiah* xxiv.-xxvii. For various reasons (here following Koppe, who just previously in additions to his translation of Lowth's *Isaiah* had shown himself the pioneer of the higher criticism of the book of *Isaiah*) he argues that "in our *Isaiah* are many oracles not the work of this prophet." In other directions the still powerful influence of tradition affects Eichhorn. He maintains the exilic origin of parts of *Daniel*, though he is convinced (here again in part by language) of the later origin of other parts. His Pentateuchal criticism is limited by the tradition of Mosaic authorship: but even within these limits he achieves much. He carries through, as Astruc had done, the analysis of *Genesis* into (primarily) two documents; he draws the distinction between the Priests' Code, of the middle books of the Pentateuch, and *Deuteronomy*, the people's law book; and admits that even the books that follow *Genesis* consist of different documents, many incomplete and fragmentary (whence the theory became known as the "Fragment-hypothesis"), but all the work of Moses and some of his contemporaries.

Other literary critics of the same period or a little later are Alex. Geddes, a Scottish Catholic priest, who projected, and in part carried out (1792-1800), a critically annotated new translation of the Old Testament, and argued therein that the Pentateuch ultimately rests on a variety of sources partly written, partly

oral, but was compiled in Canaan probably in the reign of Solomon; K. D. Ilgen, the discoverer (1798) that there were two distinct documents in *Genesis* using the divine name *Elohim*, and consequently that there were three main sources in the books, not two, as Astruc and Eichhorn had conjectured; and J. S. Vater, the elaborator of the "Fragment-hypothesis."

But the next distinct stage is reached when we come to De Wette, whose contributions to Biblical learning were many and varied, but who was pre-eminent in *historical criticism*. De Wette. He carried criticism beyond literary analysis and literary appreciation to the task of determining the worth of the documents as records, the validity of the evidence. His peculiar qualities were conspicuous in his early and exceedingly influential work—the *Beiträge zur Einleitung in das Alte Testament* (1806-1807). In the introduction to vol. ii. he carefully analyses the principles of sound historical method and the essentials of a trustworthy historical record. These principles he applied to the Old Testament, firstly to the *Books of Chronicles*, and then to the Pentateuch. The untrustworthiness of *Chronicles*—briefly admitted by Luther—he proved in detail, and so cleared the way for that truer view of the history and religion of Israel which the treatment of *Chronicles* as a trustworthy record of the past hopelessly obscured. In the criticism of the Pentateuch his most influential and enduring contributions to criticism are his proof that *Deuteronomy* is a work of the 7th century B.C., and his insistence that the theory of the Mosaic origin of all the institutions described in the Pentateuch is incompatible with the history of Israel as described in the historical books, *Judges*, *Samuel* and *Kings*.

Strong in historical criticism, De Wette was weak in historical construction. But what he failed to give, Ewald supplied, and if more of De Wette's than of Ewald's work still stands to-day, that is but an illustration of the melancholy fact that in history negative criticism is surer than positive construction. But Ewald's *History of the People of Israel* (1843-1859) was the first great attempt to synthesize the results of criticism and to present the history of Israel as a great reality of the past. By the force of his wide learning and even more of his personality, Ewald exercised for long an all-pervading and almost irresistible influence. He closes one epoch of Old Testament criticism; by his influence he retards the development of the next. Before passing to the new epoch it must suffice to make a simple reference to the philological work of Gesenius and Ewald, which assisted a sounder exegesis and so secured for later criticism a more stable basis.

The next stage brings us to the critical theories or conclusions which at first gradually and then rapidly, in spite of the keenest criticisms directed against them both by those who clung more or less completely to tradition and by the representatives of the earlier critical school, gained increasing acceptance, until to-day they dominate Old Testament study. The historic-critical starting-point of the movement was really furnished by De Wette: but it was Vatke who, in his *Biblische theologische wissenschaftlich dargestellt* (1835), first brought out its essential character. The fundamental peculiarity of the movement lies in the fact that it is a criticism of what is supreme in Israel—its religion, and that it has rendered possible a true appreciation of this by showing that, like all living and life-giving systems of thought, belief and practice, the religion of Israel was subject to development. It seized on the prophetic element, and not the ceremonial, as containing what is essential and unique in the religion of Israel. In literary criticism its fundamental thesis, stated independently of Vatke and in the same year by George in *Die älteren jüdischen Feste*, and in a measure anticipated by Reuss, who in 1832 was maintaining in his academic lectures that the prophets were older than the Law and the Psalms more recent than both, is that the chronological order of the three main sources of the Hexateuch is (1) the prophetic narratives (JE), (2) *Deuteronomy*, (3) the Priestly Code (P), the last being post-exilic. This entirely reversed the prevailing view that P with its exact details and developed ceremonial and sacerdotal system was at once the earliest portion

of the Pentateuch and the *Grundchrift* or foundation of the whole—a view that was maintained by Ewald and, though with very important modifications, to the last by A. Dillmann (d. 1894). Inherent in this view of religious development and the new critical position were far-reaching changes in the literary, historical and religious criticism of the Old Testament: these have been gradually rendered clear as the fundamental positions on which they rest have been secured by the manifold work of two generations of scholars.

Nearly a generation passed before Vatke's point of view gained any considerable number of adherents. This is significant. In

Graf: part it may fairly be attributed to the retarding
Kuenen: influence of the school of Ewald, but in large part also
Well- to the fact that Vatke, a pupil of Hegel, had developed
hausen: his theory on a *priori* grounds in accordance with the
Colenso. principles of Hegel's philosophy of history. It was only after a fresh and keener observation of facts that the new theory made rapid progress. For that, when it came, much was due to the work of Graf (a pupil of Reuss, whose *Geschichtliche Bücher des Alten Testaments* appeared in 1866); to the Dutch scholar Kuenen, who, starting from the earlier criticism, came over to the new, made it the basis of his *Religion of Israel* (1866-1870), a masterly work and a model of sound method, and continued to support it by a long series of critical essays in the *Theologisch Tijdschrift*; and to Wellhausen, who displayed an unrivalled combination of grasp of details and power of historical construction: his *Prolegomena zur Geschichte Israels* was published in 1878 and translated into English in 1885; the history itself, *Israelitische u. jüdische Geschichte*, followed twenty years later, after much further critical work had been done in the meantime. Not a little also was due to Colenso (*The Pentateuch . . . critically examined*, pt. i., 1862), who, though he never entirely accepted the new position, contributed by his searching analysis of the unreality of P's narrative to the formation (for example, in the mind of Kuenen) or ratification of the judgment on that work which is fundamental to the general theory.

This sketch of the critical movement has now been brought down to the point at which the comprehensive conclusions which still dominate Old Testament study gained clear expression and were shown to be drawn from the observation of a large body of facts. It does not fall within the scope of this article to examine the validity of these conclusions, nor even to notice the various subsidiary or consequential conclusions. Nor again is it possible to survey the more special developments of literary criticism which have later emerged, amongst which one of the most important has been the radical examination of the prophetic writings introduced and developed by (amongst others) Stade, Wellhausen, Duhm, Cheyne, Marti.¹ The starting-point of this newer criticism of the prophets is the clearer practical recognition of the fact that all pre-exilic prophecy has come down to us in the works of post-exilic editors, and that for the old statement of the problem of the prophetic books—What prophecies or elements in Isaiah, Jeremiah and the rest are later than these prophets?—is to be substituted the new critical question—From these post-exilic collections how are the pre-exilic elements to be extracted? Bound up with this question of literary criticism is the very important question of the origin and development of the Messianic idea.

But two things, the extent of the influence of criticism and the relation of archaeology and criticism, yet remain for consideration, in the course of which it will be possible just to indicate some other problems awaiting solution.

It is one thing for scholars to reach conclusions: it is another for these conclusions to exercise a wide influence in the Churches and over general culture. In the 16th century we find *abiter*

dicta of the Reformers challenging traditional opinions on the origin and character of the Old Testament; in the 17th century, among certain isolated scholars, elementary critical surveys of the whole field, which exercised, however, no extensive influence. Nor was it till late in the 18th century that criticism seriously challenged the dominance of the Protestant scholastic treatment of the Old Testament on the one hand, and the rough and ready, uncritical explanations or depreciations of the Rationalists on the other. But Eichhorn's *Introduction* appealed to more than technical scholars: its influence was great, and from that time forward criticism gradually or even rapidly extended its sway in Germany. Very different was the case in England; after Geddes and Lowth, at the close of the 18th, till far down into the 19th century, the attitude even of scholars (with rare exceptions) was hostile to critical developments, and no independent critical work was done. Pusey indeed studied under Eichhorn, and in his *Historical Enquiry into the probable causes of the Rationalist Character lately predominant in German Theology* (1828-1830) speaks sympathetically of the attitude of the Reformers on the question of Scripture and in condemnation of the later Protestant scholastic doctrine; but even in this book he shows no receptivity for any of the actual critical conclusions of Eichhorn and his successors, and subsequently threw the weight of his learning against critical conclusions—notably in his *Commentary on Daniel* (1864). Dean Stanley owed something to Ewald and spoke warmly of him, but the Preface to the *History of the Jewish Church* in which he does so bears eloquent testimony to the general attitude towards Old Testament criticism in 1862, of which we have further proof in the almost unanimous disapprobation and far-spread horror with which Colenso's *Pentateuch*, pt. i., was met on its publication in the same year.

From 1860 T. K. Cheyne worked indefatigably as a resourceful pioneer, but for many years, in view of the prevailing temper, with "extreme self-suppression" and "willingness to concede to tradition all that could with any plausibility be conceded" (Cheyne, *Origin of the Psalter*, p. 15); more especially is his influence observable after 1890, when he published his Bampton Lectures, *Origin of the Psalter*, a work of vast learning and keen penetration, without restraint on the freedom of his judgment—always stimulating to students and fellow-workers, though by no means always carrying large numbers with him. From about 1880 the prevailing temper had changed; within a decade of this date the change had become great; since then the influence of Old Testament criticism has grown with increased acceleration. The change in the former period with regard to a single point, which is however typical of many, is briefly summed up by Dr Cheyne: "In 1880 it was still a heresy to accept with all its consequences the plurality of authorship of the Book of Isaiah; in 1890 to a growing school of church-students this has become an indubitable fact" (*Origin of the Psalter*, xv.). By 1906 this plurality of authorship had become almost a commonplace of the market. Many, particularly of late, have contributed to the wide distribution, if not of the critical spirit itself, yet at least of a knowledge of its conclusions. To two only of the most influential is it possible to make more definite reference—to W. Robertson Smith and S. R. Driver. From 1875 onwards Smith contributed to the 9th edition of the *Encyclopædia Britannica* a long series of important articles, which, together with the articles of Cheyne, Wellhausen and others, made that work an important factor in the change which was to pass over English thought in regard to the Bible; in 1878, by his pleadings in the trial for heresy brought against him on the ground of these articles, he turned a personal defeat in the immediate issue into a notable victory for the cause which led to his condemnation; and subsequently (in 1880), in two series of lectures, afterwards published² and widely read, he gave a brilliant, and, as it proved, to a rapidly increasing number a convincing exposition of the criticism of the literature, history and religion of Israel, which was already represented in Germany

Influence of Criticism.

¹ See particularly B. Stade, *Geschichte des Volkes Israel* (1887-1888); J. Wellhausen, *Die Kleinen Propheten* (1892); B. I. Duhm, *Jesaja* (1892); T. K. Cheyne, *Introduction to the Book of Isaiah* (1895); K. Marti, *Jesaja* (1900), and *Das Dodekapropheten* (1904).

² *The Old Testament in the Jewish Church* (1881); *The Prophets of Israel* (1882).

by Wellhausen and in Holland by Kuenen. In 1891 Dr Driver published his *Introduction to the Literature of the Old Testament* (6th ed., 1897); less popular in form than Smith's lectures, it was a more systematic and comprehensive survey of the whole field of the literary criticism of the Old Testament. The position of the author as regius professor of Hebrew at Oxford and canon of Christ Church in succession to Pusey, and his well-established reputation as a profound Hebrew scholar, commanded wide attention; the qualities of the book itself—its marked sobriety, its careful discrimination between the differing degrees of probability attaching to various conclusions and suggestions, and in general its soundness of method—rapidly extended the understanding of what Old Testament criticism is and commanded acceptance of the well-established conclusions.

No less rapid has been the change in America during the same period, nor less numerous the scholars well equipped to pursue the detailed investigation involved in critical study or those who have shown ability in popular presentations of the critical standpoint.¹ Pre-eminent amongst these is C. A. Briggs, whose influence has been due in part to a large and varied body of work (*Biblical Study*, 1883, and many articles and volumes since) and in part to his organization of united critical, international and interconfessional labour, the chief fruits of which have been the *Hebrew Lexicon* (based on Gesenius, and edited by F. Brown, one of the most eminent of American scholars, S. R. Driver and himself), and the *International Critical Commentary*. Other important works in which English and American scholars have co-operated are the *Encyclopaedia Biblica* (1899-1903) and Hastings' *Bible Dictionary* (1898-1904)—the latter less radical, but yet on the whole based on acceptance of the fundamental positions of Vatke, Graf, Wellhausen. Between either of these and Smith's *Dictionary of the Bible* (1863) yawns a great gulf. Space forbids any attempt to sketch here the special growth of criticism in other countries, such as France, where the brilliant genius of Renan was in part devoted to the Old Testament, or within the Roman Catholic Church, which possesses in Père Lagrange, for example, a deservedly influential critical scholar, and in the *Revue Biblique* an organ which devotes much attention to the critical study of the Old Testament.

Rapid and extensive as has been the spread of critical methods, there have not been lacking *anticritica*. Many of these have been not only apologetic, but unscholarly; that is, however, not the case with all. In Dr James Orr's learned work, *The Problem of the Old Testament considered with reference to Recent Criticism* (1906), the author's chief aim is to prove insecure the fundamental positions of the now dominant school of criticism.

In view of extensive misconception occasioned by many of these *anticritica*, it needs to be pointed out that terms like "criticism," "higher criticism," "critics" are often loosely used: criticism is a method, its results are many. Again, many of the results or conclusions of criticism are mutually independent, while others are interrelated and depend for their validity on the validity of others. For example, among the generally or largely accepted critical conclusions are these: (1) Moses is not the author of the whole Pentateuch; (2) Isaiah is not the author of Is. xl.-lxvi.; (3) the book of Daniel was written in the 2nd century B.C.; (4) the Priestly Code is post-exilic; (5) most of the Psalms are post-exilic. Now 1, 2, 3 are absolutely independent—if 1 were proved false, 2 and 3 would still stand; and so with 2 and 3; so also 2 and 3 could be proved false without in any way affecting the validity of 4. On the other hand, if 1 were disproved, 4 would immediately fall through, and the strength of 5 would be weakened (as it would also by the disproof of 2), because the argument for the date of many Psalms is derived from religious ideas and the significance of these varies greatly according as the Priestly Code is held to be early or late. In view of the number of critical conclusions and the mutual independence of many of them, "higher criticism"

can only be overthrown by proving the application of criticism to the Old Testament to be in itself unlawful, or else by proving the falseness or inconclusiveness of all its mutually independent judgments one by one. On examination, the authors of *anticritica* are generally found to disown, tacitly or openly, the first of these alternatives; for example, Prof. Sayce, who frequently takes the field against the "higher criticism," and denies, without, however, disproving, the validity of the literary analysis of the Hexateuch, nevertheless himself asserts that "no one can study the Pentateuch . . . without perceiving that it is a compilation, and that its author, or authors, has made use of a large variety of older materials," and that "it has probably received its final shape at the hands of Ezra" (*Early History of the Hebrews*, 129 and 134). This is significant enough; Prof. Sayce, the most brilliant and distinguished of the "anti-critics," does not really recoupy the position of the "able and pious men" of the mid-19th century, to whom "even to speak of any portion of the Bible as a history" was "an outrage upon religion" (Stanley, *Jewish Church*, Preface); these may still have pious, but they have no longer scholarly successors. Prof. Sayce travels farther back, it is true, but on critical lines; he abandons the Pentateuchal criticism of the 20th century, to recoupy the critical position of Hobbes, Spinoza and Simon in the 17th century—whether reasonably or not must here be left an open question.

Briefly, in conclusion, it remains to consider the relation of Archaeology to Criticism, partly because it is frequently asserted in the loose language just discussed that Archaeology has overthrown Criticism, or in particular the "higher criticism," and partly because Archaeology has stimulated and forced to the front certain important critical questions.

More especially since the middle of the 19th century the decipherment of Egyptian and Assyrian inscriptions and systematic excavation in Palestine and other parts of the East have supplied a multitude of new facts bearing more or less directly on the Old Testament. What has been the general effect of these new facts on traditional theories or critical conclusions?

(1) *Literary Criticism*.—No discovery has yielded any direct testimony as to the authorship of any book of the Bible, or as to the mode or date of its composition. Any documentary analysis of the Pentateuch may be right or wrong; but archaeology contributes nothing either one way or another as to the answer. On the other hand, archaeology has in some cases greatly strengthened the critical judgment that certain writings (e.g. *Daniel*, the story of Joseph in *Genesis*) are not contemporary with the events described.

(2) *Historical Criticism*.—Here the gain has been more direct; e.g. the Assyrian inscriptions have furnished independent evidence of the relations of certain Hebrew kings (Ahab, Jehu, Ahaz) with the Assyrians, and thus supported more or less completely the evidence of the Old Testament on these points: they have also served to clear up in part the confused chronology of the Hebrews as given in the books of *Kings*. But above all archaeology has immensely increased our knowledge of the nations among which Israel was placed, and of the political powers which from time to time held Palestine in subjection. In this way archaeology has greatly helped to bring the history of Israel into relation with the history of the ancient East, and in so doing has raised important questions as to the origin of Hebrew culture. For example, the recent discovery of the Code of Hammurabi, which contains some remarkable resemblances to the Pentateuchal codes, raises the question of the relation of Hebrew to Babylonian law. On the other hand, there are certain great historical questions which have been greatly affected by criticism, but on which archaeology has hitherto shed no light. For example, such as archaeology has increased our knowledge of the conditions obtaining in Palestine before the Hebrew invasion, it has so far contributed nothing to our knowledge of the Hebrew nation before that time beyond the statement in the now famous stele of Merneptah (Mineptah) (c. 1270 B.C.), discovered in 1896, "Yisrael is desolated, its seed is not," and a few possible but vague and uncertain

¹ For details see an article in the *Zeitschr. für d. alttest. Wissenschaft* for 1889, pp. 246-302, on "Alttestamentliche Studien in Amerika," by G. F. Moore, who has himself since done much distinguished and influential critical work.

allusions to particular tribes. It has contributed nothing whatsoever to our knowledge of any Hebrew individual of this period,¹ and consequently what elements of history underlie the stories in Genesis, in so far as they relate to the Hebrew patriarchs, must still be determined, if at all, by a critical study of the Old Testament. The story in Gen. xiv. is no exception to this statement: archaeology has made probable the historic reality of Chedorlaamer, which some critics had previously divined; it has not proved the historical reality of the patriarch Abraham or the part played by him in the story, which some critics, whether rightly or wrongly, had questioned. The Dutch scholar Koster called in question the return of the Jews in the days of Cyrus; his view, adopted by many, has hardly obtained, as yet at all events, the weight of critical judgment: here again, unfortunately, archaeology at present is silent.

(3) *Criticism of Religion*.—Here, perhaps, archaeology has contributed most new material, with the result that religious terms, ideas, institutions, once supposed to be peculiar to Israel, are now seen to be common to them and other nations; in some cases, moreover, priority clearly does not lie with the Hebrews, as, for example, in the case of the materials (as distinct from the spirit in which they are worked up) of the stories of Creation and the Flood. Of late, too, it has been much argued, and often somewhat confidently maintained, that Hebrew monotheism is derivative from Babylonian monotheism.

This and similar questions, leading up to the ultimate and supreme question—Wherein does lie the uniqueness of Israel's religion?—are among those which will require in the future renewed examination in the light of a critical study alike of the Old Testament and of all the relevant material furnished by archaeology. Archaeology has not yet found the key to every unopened door; but it has already done enough to justify the surmise that if criticism had not already disintegrated the traditional theories of the Old Testament, archaeology in the latter half of the 19th century would itself have initiated the process.

LITERATURE.—Much of the details and results of criticism and the special literature will be found in the articles in the present work on the several books of the Old Testament. To the works already mentioned we may add L. Diestel, *Geschichte des Alten Testaments in der Christlichen Kirche* (1869); C. A. Briggs, *General Introduction to the Study of Holy Scripture* (1889); G. A. Smith, *Modern Criticism and the Preaching of the Old Testament* (1901)—these for the history of Criticism (or more generally of Old Testament study); T. K. Cheyne, *Founders of Old Testament Criticism* (pp. 1-247, biographical sketches of critical scholars since the middle of the 18th century; pp. 248-372, criticism of Driver's *Introduction*). As already indicated, the exposition of Literary Criticism in English is Driver's *Introduction to the Literature of the Old Testament*. For the general principles of Historical Criticism see Ch. V. Langlois and Ch. Seignobos, *Introduction to the Study of History* (Eng. trans., 1898), with which it is interesting to compare De Wette's brief discussion referred to in the article. (G. B. G.*)

5. Old Testament Chronology.

A sense of the importance of a fixed standard of chronology was only acquired gradually in the history of the world. Nations in a primitive state of civilization were not, and are not, conscious of the need. When the need began to be felt events were probably at first dated by the regnal years of kings; the reigns of successive kings were then arranged in order, and grouped, if necessary, in dynasties, and thus a fixed standard was gradually constructed. Particular states also not unfrequently introduced fixed eras, which obtained a more or less extensive currency, as the era of the first Olympiad (776 B.C.), of the foundation of Rome (753 B.C.), and of the Seleucidæ at Antioch (312 B.C.), which is followed by the Jewish author of the first book of Maccabees. Some of the earliest documents which we possess are dated by the year in which some noticeable event took place, as in contract-tablets of the age of Sargon of Agadé

¹ To avoid any possibility of overstating the case, it is necessary to refer here to the fact that Tethmosis (Thothmes) III. in the 16th century B.C. mentions two Palestinian places named respectively Jacobel and Josephel, and Sheshonk in the 10th century B.C. mentions another called "The field of Abram." From these names alone it is impossible to determine whether the places derived their names from individuals or tribes.

(Akkad) (3800 B.C., or, according to other authorities, 2800 B.C.), "In the year in which Sargon conquered the land of Amurru [the Amorites]"; or, "In the year in which Samsu-ditana [c. 1050 B.C.] made the statue of Marduk": Is. vi. 1 ("In the year of King Uzziah's death"), xiv. 28, xx. 1, are examples of this method of dating found even in the Old Testament. In process of time, however, the custom of dating by the regnal year of the king became general. The Babylonians and Assyrians were probably the first to construct and employ a fixed chronological standard; and the numerous contract-tablets, and list of kings and yearly officials, discovered within recent years, afford striking evidence of the precision with which they noted chronological details. Biblical chronology is, unfortunately, in many respects uncertain. Prior to the establishment of the monarchy the conditions for securing an exact and consecutive chronology did not exist; the dates in the earlier period of the history, though apparently in many cases precise, being in fact added long after the events described, and often (as will appear below) resting upon an artificial basis, so that the precision is in reality illusory. And after the establishment of the monarchy, though the conditions for an accurate chronology now existed, errors by some means or other found their way into the figures; so that the dates, as we now have them, are in many cases at fault by as much as two to three decades of years. The exact dates of events in Hebrew history can be determined only when the figures given in the Old Testament can be checked and, if necessary, corrected by the contemporary monuments of Assyria and Babylonia, or (as in the post-exilic period) by the knowledge which we independently possess of the chronology of the Persian kings. In the following parts of this article the chronological character of each successive period of the Old Testament history will be considered and explained as far as the limits of space at the writer's disposal permit.

1. *From the Creation of Man to the Exodus*.—In the whole of this period the chronology, in so far as it consists of definite figures, depends upon that part of the Pentateuch which is called by critics the "Priestly Narrative." The figures are in most, if not in all cases artificial, though the means now fail us of determining upon what principles they were calculated. It is also to be noted that in the Samaritan text of the Pentateuch, and in the LXX., the figures, especially in the period from the Creation to the birth of Abraham, differ considerably from those given in the Hebrew, yielding in Sam. a lower, but in the LXX. a much higher total. The following tables will make the details clear:—

(1) *From the Creation of Man to the Flood* (Gen. v. and vii. 11).

	Age of each at birth of next.		
	Heb.	Sam.	LXX.
Adam (930)	130	130	230
Seth (912)	105	105	205
Enosh (905)	90	90	190
Kenan (910)	70	70	170
Mahalalel (895)	65	65	165
Jared (962)	162	62	162
Enoch (365)	65	65	165
Methuselah (999)	187	67	187
Lamech (777)	182	53	188
Noah (950); age at Flood	600	600	600
Total from the Creation of Man to the Flood	1656	1307	2262

The figures in parentheses indicate the entire ages assigned to the several patriarchs; these are generally the same in the three texts. The Sam., however, it will be noticed, makes in three cases the father's age at the birth of his eldest son less than it is in the Heb. text, while the LXX. makes it in several cases as much as 100 years higher, the general result of these differences being that the total in the Sam. is 349 years less than in the Heb., while in the LXX. it is 606 years more. The names, it need hardly be remarked, belong to the prehistoric period, and equally with the figures are destitute of historical value.

² Or, according to some MSS., 167.

(2) From the Flood to the Call of Abraham (Gen. xi.).

	Age of each at birth of next.		
	Heb.	Sam.	LXX.
Arphaxad (438) ¹	35 ²	135	135
Canaan (460) [cf. Luke iii. 27]	30	130	130
Shelah (433)	30	130	130
Eber (464)	34	134	134
Peleg (239)	30	130	130
Reu (239)	32	132	132
Serug (230)	30	130	130
Nahor (148)	29	79	79
Terah (205)	70	70	70
Abraham (175); age at Call (Gen. xii. 4)	75	75	75
Total from the Flood to the Call of Abraham	365	1015	1145

The variations are analogous to those under (1), except that here the birth-years of the patriarchs in both Sam. and LXX. differ more consistently in one direction, being, viz., almost uniformly higher by 100 years. It has been much debated, in both cases, which of the three texts preserves the original figures. In (2) it is generally agreed that the Heb. does this, the figures in Sam. and LXX. having been arbitrarily increased for the purpose of lengthening the entire period. The majority of scholars hold the same view in regard also to (1); but Dillmann gives here the preference to the figures of the Sam. The figures, of course, in no case possess historical value: accepting even Ussher's date of the Exodus, 1401 B.C., which is earlier than is probable, we should obtain from them for the creation of man 4157 B.C., or (LXX.) 5328³ and for the confusion of tongues, which, according to Gen. xi. 1-9, immediately followed the Flood, 2501 B.C., or (LXX.) 3066 B.C. But the monuments of Egypt and Babylonia make it certain that man must have appeared upon the earth long before either 4157 B.C. or 5328 B.C.; and numerous inscriptions, written in three distinct languages—Egyptian, Sumerian and Babylonian—are preserved dating from an age considerably earlier than either 2501 B.C. or 3066 B.C.⁴ The figures of Gen. v. and xi. thus merely indicate the manner in which the author of the Priestly Narrative—and probably to some extent tradition before him—pictured the course of these early ages of the world's history. The ages assigned to the several patriarchs (except Enoch) in Gen. v. are much greater than those assigned to the patriarchs mentioned in Gen. xi., and similarly the ages in Gen. xi. 10-18 are higher than those in Gen. xi. 10-26; it is thus a collateral aim of the author to exemplify the supposed gradual diminution in the normal years of human life.

The Babylonians, according to Berossus, supposed that there were ten antediluvian kings, who they declared had reigned for the portentous period of 432,000 years (432,000 years, however, it has been ingeniously pointed out by Oppert (*Gött. Gel. Nachrichten*, 1877, p. 205 ff.)=86,400 *lustra*, while 1565 years (the Heb. date of the Flood)=86,400 *weeks* (1656=72×23; and 23 years being=8395 days+5 intercalary days=8400 days=12000 weeks); and hence the inference has been drawn that the two periods have in some way been developed from a common basis, the Hebrews taking as their unit a week, where the Babylonians took a *lustrum* of 5 years.

(3) From the Call of Abraham to the Exodus.

From the Call of Abraham to the birth of Isaac (Abraham being then aged 100, Gen. xxi. 5)	25 years
Age of Isaac at the birth of Esau and Jacob (Gen. xxv. 26)	60 "
Age of Jacob when he went down into Egypt (Gen. xlvii. 9)	130 "
The period of the Patriarchs' sojourn in Canaan was thus	215 "
But the period of the Israelites' sojourn in Egypt, according to Ex. xii. 40, 41, was	430 "

¹ Shem, the father of Arphaxad, is aged 100 at the time of the Flood, and lives for 600 years.

² Disregarding the "two years" of Gen. xi. 10; see v. 32, vii. 11.

³ Taking account of the reading of LXX. in Ex. xii. 40.

⁴ See further Driver's essay in Hogarth's *Authority and Archaeology* (1899), pp. 32-34; or his *Book of Genesis* (1904, 7th ed., 1909), p. xxxi. ff.

We thus get—

From the Call of Abraham to the Exodus (Heb. text)	215+430=645 years
From the Flood to the Call of Abraham (Heb. text)	365 "
From the Creation of Man to the Flood (Heb. text)	1656 "
From the Creation of Man to the Exodus (Heb. text)	2666 "

On these figures the following remarks may be made:—

(i.) In Genesis the chronology of the Priestly Narrative ("P") is not consistent with the chronology of the other parts of the book ("JE"). Three or four illustrations will suffice: (a) The author of Gen. xii. 10-20 evidently pictures Sarai as a comparatively young woman, yet according to P (xii. 4, xvii. 17) she was 65 years old. (b) In Gen. xxi. 15 it is clearly implied that Ishmael has been *carried* by his mother, yet according to xvi. 16, xxi. 5, 8, he must have been at least 15 years old. (c) In Gen. xxvii. Isaac is to all appearance on his deathbed (cf. ver. 2), yet according to P (xxv. 26, xxvi. 34, xxxv. 28) he survived for *eighty* years, dying at the age of 180. Ussher and others, arguing back from the dates in xvii. 9, xlv. 6, xli. 46, xxxi. 41, infer that Jacob's flight to Haran took place in his 77th year. This reduces the 80 years to 43 years, though that is scarcely less incredible. It involves, moreover, the incongruity of supposing that *thirty-seven* years elapsed between Esau's marrying his Hittite wives (xxvi. 34) and Rebekah's expressing her apprehensions (xxvii. 46) lest Jacob, then aged *seventy-seven*, should follow his brother's example. (d) In Gen. xlv. 20 Benjamin is described as a "little one"; in P, almost immediately afterwards (xvi. 21), he appears as the father of ten sons; for a similar anomaly in xlv. 12, see the *Oxford Hexateuch*, i, p. 25n. (ii.) The ages to which the various patriarchs lived (Abraham, 175; Isaac, 180; Jacob, 147), though not so extravagant as those of the antediluvian patriarchs, or (with one exception) as those of the patriarchs between Noah and Abraham, are much greater than is at all probable in view of the structure and constitution of the human body. (iii.) The plain intention of Ex. xii. 40, 41 is to describe the Israelites as having dwelt in Egypt for 430 years, which is also in substantial agreement with the earlier passage, Gen. xv. 13 ("shall sojourn in a land that is not theirs, . . . and they shall afflict them 400 years"). It does not, however, accord with other passages, which assign only four generations from Jacob's children to Moses (Ex. vi. 16-20; Num. xxvi. 5-9; cf. Gen. xv. 16), or five to Joshua (Josh. vii. 1); and for this reason, no doubt, the Sam. and LXX. read in Ex. xii. 40, "The sojourning of the children of Israel in the land of Egypt, and in the land of Canaan, was 430 years," reducing the period of the sojourn in Egypt to half of that stated in the Hebrew text, viz. 215 years. This computation attained currency among the later Jews (Josephus and others; cf. the "400 years" of Gal. iii. 17). The forced and unnatural rendering of Ex. xii. 40 in the A.V. (contrast R.V.), which was followed by Ussher, is intended for the purpose of making it possible. From the facts that have been here briefly noted it must be evident how precarious and, in parts, how impossible the Biblical chronology of this period is. (iv.) It has been observed as remarkable that 2666, the number of years (in the Hebrew text) from the Creation of Man to the Exodus, is, in round numbers, just two-thirds of 4000; and the fact has suggested the inference that the figure was reached by artificial computation.

The Date of the Exodus.—Is it possible to determine this, even approximately, upon the basis of external data? (i.) The correspondence between the Egyptian governors established in different parts of Palestine and the Egyptian kings Amenhotep (Amenophis) III. and IV. of the 18th dynasty, which was discovered in 1887 at Tel el-Amarna, makes it evident that Palestine could not yet have been in the occupation of the Israelites. It was still an Egyptian province, and the Babylonian language, in which the correspondence is written, shows that the country must have been for a considerable time past, before it came into the possession of Egypt, under Babylonian

influence. Now one of the kings, who corresponds with Amen-hötep IV., is Burnaburiash (Burna-buryas), king of Babylon, and Egyptologists and Assyriologists are agreed that the date of these monarchs was c. 1400 B.C. The conquest of Canaan, consequently, could not have taken place till after 1400 B.C. (ii.) It is stated in Ex. i. 11 that the Israelites built in Egypt for the Pharaoh two store-cities, Pithom and Rameses. The excavations of M. Naville have, however, shown that Rameses II. of the 19th dynasty was the builder of Pithom; and though the other city has not at present been certainly identified, its name is sufficient to show that he was its builder likewise. Hence the Pharaoh of the Exodus is commonly supposed to have been Rameses (Rameses) II.'s successor, Merenptah (Mincenptah). Egyptian chronology is unfortunately imperfect; but Professor Petrie, who has paid particular attention to the subject, and who assigns the reign of Amen-hötep IV. to 1383-1365 B.C., assigns Rameses II. to 1300-1234 B.C.¹ In Merenptah's fifth year the Delta was invaded by a formidable body of Libyans and other foes,² and it has been conjectured that the Israelites took the opportunity of escaping during the unsettlement that was thus occasioned.

Alternative dates for Rameses II.: Maspero, *The Struggle of the Nations* (1897), p. 449, c. 1320-1255; Breasted (1906), 1292-1225; Meyer (1909), 1310-1244. Attempts have been made to identify the Khabri, who are mentioned often in the Tel el-Amarna letters as foes, threatening to invade Palestine and bring the Egyptian supremacy over it to an end, with the Hebrews. The Exodus, it has been pointed out, might then be placed under Amen-hötep II. (1448-1420 B.C.; Breasted; 1440-1423, Petrie), the successor of Thothmes, and more time would be allowed for the events between the Exodus and the time of David (c. 1000), which, if the date given above be correct, have been thought to be unduly compressed (see Orr in the *Expositor*, March 1897, p. 161 ff.); but there are difficulties attaching to this view, and it has not been adopted generally by scholars. There may be some ultimate connexion between the Khabri and the Hebrews; but the Khabri of the Tel el-Amarna letters cannot be the Hebrews who invaded Canaan under Joshua.³

The mention of Israel on the stele of Merenptah, discovered by Petrie in 1896 ("Israel [Yisraël] is desolated; its seed [or fruit] is not"), is too vague and indefinite in its terms to throw any light on the question of the Exodus. The context speaks of places in or near Canaan; and it is possible that the reference is to Israelite clans who either had not gone down into Egypt at all, or had already found their way back to Palestine. See Hogarth's *Authority and Archaeology*, pp. 62-65.

2. *From the Exodus to the Foundation of the Temple* (in the fourth year of Solomon, 1 Kings vi. 1).—In the chronological note, 1 Kings vi. 1, this period is stated to have consisted of 480 (LXX. 440) years. Is this figure correct? If the years of the several periods of oppression and independence mentioned in the Book of Judges (Judges iii. 8, 11, 14, 30, iv. 3, v. 31, vi. 1, viii. 28, ix. 22, x. 2, 3, 8, xii. 7, 9, 11, 14, xiii. 1, xv. 20, xvi. 31) be added up, they will be found to amount to 410 years; to these must be added further, in order to gain the entire period from the Exodus to the foundation of the Temple, the 40 years in the wilderness, 2 years under Joshua and the elders (Judges ii. 7), the 40 (LXX. 20) years' judgeship of Eli (1 Sam. iv. 18), the 20 or more years of Samuel (1 Sam. vii. 2, 15), the 7 years of Saul (the two years of 1 Sam. xiii. 1 [R.V.] seem too few), the 40 years of David (1 Kings ii. 11), and the first four years of Solomon, i.e. 144+x+y years, in all 554 years, + two unknown periods denoted by x and y—in any case considerably more than the 480 years of 1 Kings vi. 1. This period might no doubt be reduced to 480 years by the supposition, in itself not improbable, that some of the judges were local and contemporaneous; the suggestion has also been made that, as is usual in Oriental chronologies, the years of foreign domination were not counted, the beginning of each judge's rule being reckoned, not from the victory which brought him into power, but from the death of his predecessor; we should in this case obtain for the period from the Exodus to the foundation of the Temple 440-x+y years, which if 30 years be assigned con-

jecturally to Joshua and the elders, and 10 years to Saul, would amount exactly to 480 years. The terms used, however ("and the land had rest forty years," iii. 11, similarly, iii. 30, v. 31, viii. 28), seem hardly to admit of the latter supposition; and even if they did, it would still be scarcely possible to maintain the correctness of the 480 years: it is difficult to harmonize with what, as we have seen, appears to be the most probable date of the Exodus; it is, moreover, open itself to the suspicion of having been formed artificially, upon the assumption that the period in question consisted of twelve generations⁴ of 40 years each. In the years assigned to the different judges, also, the frequency of the number 40 (which certainly appears to have been regarded by the Hebrews as a round number) is suspicious. On the whole no certain chronology of this period is at present attainable.⁵

3. *From the Fourth Year of Solomon to the Captivity of Judah*.—During this period the dates are both more abundant, and also, approximately, far more nearly correct, than in any of the earlier periods; nevertheless in details there is still much uncertainty and difficulty. The Books of Kings are a compilation made at about the beginning of the Exile, and one object of the compiler was to give a consecutive and complete chronology of the period embraced in his work. With this purpose in view, he not only notes carefully the length of the reign of each king in both kingdoms, but also (as long as the northern kingdom existed) brings the history of the two kingdoms into relation with one another by equating the commencement of each reign in either kingdom with the year of the reign of the contemporary king in the other kingdom.

The following are examples of the standing formulæ used by the compiler for the purpose:—"In the twentieth year of Jeroboam king of Israel began Asa to reign over Judah. And forty and one years reigned he in Jerusalem" (1 Kings xv. 9, 10). "In the third year of Asa king of Judah began Baasha the son of Ahijah to reign over all Israel in Tirzah (and reigned) twenty and four years" (*ibid.* ver. 33).

In these chronological notices the lengths of the reigns were derived, there is every reason to suppose, either from tradition or from the state annals—the "book of the chronicles of Israel" (or "Judah" ⁶), so constantly referred to by the compiler as his authority (e.g. 1 Kings xv. 23, 31, xvi. 5); but the "synchronisms"—i.e. the corresponding dates in the contemporary reigns in the other kingdom were derived, it is practically certain, by computation from the lengths of the successive reigns. Now in some cases, perhaps, in the lengths of the reigns themselves, in other cases in the computations based upon them, errors have crept in, which have vitiated more or less the entire chronology of the period. The existence of these errors can be demonstrated in two ways: (1) The chronology of the two kingdoms is not consistent with itself; (2) the dates of various events in the history, which are mentioned also in the Assyrian inscriptions, are in serious disagreement with the dates as fixed by the contemporary Assyrian chronology.

(1) That the chronology of the two kingdoms is inconsistent with itself is readily shown. After the division of the kingdom the first year of Jeroboam in Israel coincides, of course, with the first year of Rehoboam in Judah; and after the death of Jehoram of Israel and Ahaziah of Judah in battle with Jehu (2 Kings ix. 24, 27), the first year of Jehu in Israel coincides similarly with the first year of Athaliah in Judah: there are thus in the history of the two kingdoms two fixed and certain synchronisms. Now,

⁴ Namely, 40 years in the wilderness; Joshua and the elders (Judges ii. 7), 2 years; Othniel (iii. 11), 40 years; Ehud (iii. 30), 80 years; Barak (v. 31), 40 years; Gideon (viii. 28), 40 years; Jephthah and five minor judges (x. 2, 3, xii. 7, 9, 11, 14), 76 years; Samson (xvi. 31), 20 years; Eli (1 Sam. iv. 18), 40 years; Samuel (vii. 2), 20 years; Saul, 7 years; David, 40 years; and Solomon's first four years—in all 440-x+y years.

⁵ Namely, Moses (in the wilderness), Joshua, Othniel, Ehud, Deborah, Gideon, Jephthah, Samson, Eli, Samuel, Saul and David.

⁶ The "200 years" of Judges xi. 26 agrees very nearly with the sum of the years (namely, 316) given in the preceding chapters for the successive periods of oppression and independence. The verse occurs in a long insertion (xi. 12-28) in the original narrative; and the figure was most probably arrived at by computation upon the basis of the present chronology of the book.

CHRONOLOGICAL TABLE.

The dates printed in heavy type are certain, at least within a unit.

Chronology of Ussher.	Probable Real Dates.	Biblical Events.	Events in Contemporary History.		
			Babylonia.	Assyria.	Egypt. ²
4004 [4157 ¹]	Indeterminable, but much before 7000 B.C.	Creation of Man	7-6000. ² Temple of Bel at Nippur founded		4777. Menes, the first king of the First Egyptian Dynasty
			c. 4000. ² Lugal-zaggisi, king of Uruk (Erech, Gen. x. 10)		3998-3721. Fourth Dynasty
			3800. ⁴ Sargon of Agadē, who carries his arms as far as the Mediterranean Sea		3969-3908 Cheops. The Great Pyramid built
2348 [2501 ¹]		The Deluge	c. 2800. ⁴ Ur-bau and Dungi, kings of Uru (Ur, Gen. xi. 28, 31)	c. 2300. Ushpia, priest of Ashur, builder of temple in the city of Ashur	
1996-1821 [2211-2036 ¹]	c. 2100 (if, as is probable, the Amraphel of Gen. xiv. I is Khammurabi)	Abraham	c. B.C. 2130-2088. ⁷ Khammurabi unifies Babylonia and constructs in it many great works (see art. BABYLONIA)	c. 2225. Ilu-shūma, first king of Assyria at present known ⁸	2098-1587. Rule of the Hyksos
			c. 1400. Burnaburiash. Tel el-Amarna correspondence		1587-1328. Eighteenth Dynasty
				c. 1300. Shalmaneser I. (builder of Calah, Gen. x. 11)	1503-1449. Thothmes (Tethmosis) III. (leads victorious expeditions into Asia)
					1414-1383. Amen-hōtep (Amenophis) III.
					1383-1365. Amen-hōtep IV.
					1328-1202. Nineteenth Dynasty
1491	c. 1230	The Exodus	1300-1234. Ramses II. 1234-1214. Merenptah II.
1099-1058	c. 1025-1010 ⁹	Saul (2) ¹⁰	952-749 (al. 945-745). Twenty-second Dynasty
1058-1017	c. 1010-970	David (40)	952-930 ¹¹ (Breasted, 945-924). Sheshonq (Shishak). Shishak invades Judah in the fifth year of Rehoboam (1 Ki. xv. 25 f.)
1017-977	c. 970-933	Solomon (40)	
977	Judah.	Israel.	
959	933. Rehoboam (17)	933. Jeroboam I. (22)	
956	916. Abijah (3)		
956	913. Asa (41)	912. Nadab (2)	
954	..	911. Baasha (24)	

¹ The real Biblical date, Ussher in Gen. xi. 26 interpolating 60 years, because it is said in Acts vii. 4 that Abraham left Haran after his father Terah's death (Gen. xi. 32), and also (as explained above) interpreting wrongly Ex. xii. 40.

² Hilprecht's dates (*The Bab. Expedition of the University of Pennsylvania*, vol. i. pt. I. 1893, pp. 11, 12; pt. II. 1896, pp. 23, 24, 43, 44).

³ Petrie's dates, *Hist. of Egypt*, vol. i. (ed. 5, 1903), pp. 20, 30, 233, 251, 252; vol. III. (1905), pp. 2, 235, 281-7, 296-360. Other authorities, however, assign considerably lower dates for the dynasties prior to the 18th. Thus Breasted (*Hist. of Egypt*, 1906, pp. 22 ff., 221, 597) agrees with Ed. Meyer in giving, for reasons which cannot be here explained, for the beginning of the 1st dynasty c. B.C. 3400, for the 4th dynasty c. B.C. 2900-2750, and for the rule of the Hyksos c. B.C. 1680-1580; and in his *Researches in Sinai*, 1906, p. 175, Petrie proposes for Menes b.c. 5510, and for the 4th dynasty b.c. 4731-4454. See EGYPT (*Chronology*).

⁴ So Sayce, Rogers (*Hist. of Bab. and Ass.*, 1900, i. 318 f.) and others. The date rests upon a statement of Nabu-na'id's, that Sargon's son, Narām-Sin, reigned 3200 years before himself. Lehmann holds that there are reasons for believing that the engraver, by error, put a stroke too many, and that 2200 should be read instead of 3200.

⁵ Rogers, i. 373-375. Many monuments and inscriptions of other kings in Babylonia, between 4000 and 2000 B.C., are also known.

⁶ The lists of the Babylonian and Assyrian kings are not continuous; and before 1907, from the data then available (see the discussion in Rogers, *op. cit.* i. 312-348), Khammurabi, the sixth king of the first Babylonian dynasty, was commonly referred to such dates as 2376-2333 B.C. (Sayce) or 2285-2242 B.C. (Johns). But inscriptions recently discovered, by showing that the second dynasty was partly contemporaneous with the first and the third, have proved that these dates are too high; see L. W. King, *Chronicles Concerning Early Bab. Kings* (1907), i. 93-110; and the article BABYLONIA, *Chronology*. The date B.C. 2130-2088 is that adopted by Thureau-Dangin, after a discussion of the subject, in the *Journal des Savants*, 1908, p. 199; and by Ungnad in the *Orient. Lit.-zeitung*, 1908, p. 13, and in Gressmann's *Altorientalische Texte und Bilder zum A.T.* (1909), p. 103.

⁷ The dates of the kings are, in most cases, those given by Kautzsch in the table in his *Outline of the Hist. of the Literature of the O.T.* (tr. by Taylor, 1898), pp. 167 ff.; see also A. R. S. Kennedy, "Samuel" in the *Century Bible* (1905), p. 31. The dates given by other recent authorities seldom differ by more than three or four years.

⁸ The figures after a king's name indicate the number of years assigned to his reign in the O.T. For Saul, see 1 Sam. xiii. 1, R.V.

⁹ The date of Sheshonq depends on that fixed for Rehoboam. Petrie places the accession of Rehoboam in 937 B.C.

CHRONOLOGICAL TABLE—Continued.

Chronology of Ussher.	Probable Real Dates.	Biblical Events.	Events in Contemporary History.		
			Babylonia.	Assyria.	Egypt.
930	<i>Judah.</i>	<i>Israel.</i>			
929	..	888. Elah (2)	..	885-860. Assiur-nazir-abal	
929	..	887. Zimri (7 days)		860-825. Shalmaneser II.	
918	..	887. Omri (12)		..	
914	873. Jehoshaphat (25)	876. Ahab (22)		854. Ahab mentioned at the battle of Karkar	
898	..	854. Ahaziah (2)	
896	..	853. Jehoram (12)		..	
892	849. Jehoram (8)			..	
885	842. Ahaziah (1)			842. Jehu pays tribute to Shalmaneser II.	
884	842. Athaliah (6)	842. Jehu (28)	
878	836. Jehoash (40)			..	
856	..	814. Jehoahaz (17)	..	825-812. Shamshi-Adad (Hadad)	
841	..	798. Jehoash (16)		812-783. Adad-Nirāri IV.	
839	797. Amaziah (29)	
823	..	783. Jeroboam II. (41)		..	
810	779. Uziah (52) c. 750. Jotham (16), as regent (2 Ki. xv. 5)	
773	..	743. Zechariah (6 mo.)	747-733. Nabonassar	745-727. Tiglath-pileser IV.	
772	..	743. Shallum (1 mo.)		..	
772	..	743. Menahem (10)		..	
758	740. Jotham, sole ruler	
761	..	738. Pekahiah (2)	..	738. Menahem pays tribute to Tiglath-pileser IV. (cf. 2 Ki. xv. 19)	
759	..	737. Pekah (20)		..	
742	736. ¹ Ahaz (16)	..		733 (or 732). Assassination of Pekah, and succession of Hoshea, mentioned by Tiglath-pileser III.	
730	..	733 (or 732). Hoshea (9)		732. Capture of Damascus by Tiglath-pileser IV. (2 Ki. xvi. 9; cf. Is. viii. 4, xvii. 1)	
726	728. ¹ Hezekiah (29)	..	729-724. Tiglath-pileser, under the name of <i>Pulu</i> (cf. 2 Ki. xv. 19), king of Babylon	727-722. Shalmaneser IV.	
721	..	722. Fall of Samaria and end of the northern kingdom	721-710. The Chaldaean prince, Merodach-baladan, king of Babylon (cf. 2 Kings xx. 12 = Is. xxxix. 1)	722-705. Sargon 722. Capture of Samaria in Sargon's accession-year	
698	698. Manasseh (55)	711. Siege and capture of Ashdod (cf. Is. xx. 1)	715-663 <i>Twenty-fifth</i> (Ethiopian) <i>Dynasty</i> 715. ² Sabako (Shabaka)
				705-681. Sennacherib	707. ² Shabataka
				701. Campaign against Phoenicia, Philistia and Judah (2 Kings xviii. 13-xix. 35)	
				681-668. Esarhaddon	693. ³ Taharqa (Tirhakah, Is. xxxvii. 9)

¹ If these dates are correct, there must be some error in the ages assigned to Ahaz and Hezekiah at their accession, viz. 20 and 25 respectively, for it would otherwise follow from them that Ahaz, dying at the age of $20+8=28$, left a son aged 25! The date 728 for Hezekiah's accession rests upon the assumption that of the two inconsistent dates in 2 Kings xviii. 10, 13, the one in ver. 10 (which places the fall of Samaria in Hezekiah's 6th year) is correct; but some scholars (as Wellhausen, Kamphausen, and Stade) suppose that the date in ver. 10 (which places Sennacherib's invasion in Hezekiah's 14th year) is correct, and assign accordingly Hezekiah's accession to 715. This removes, or at least mitigates, the difficulty referred to, and leaves more room for the reigns of Jotham and Ahaz; but it requires, of course, a corresponding reduction in the reigns of the kings succeeding Ahaz.

² Breasted's dates for these three kings (*Hist. of Egypt*, 1906, p. 601) are: Shabaka 712-700; Shabataka 700-688; Taharqa 688-663.

CHRONOLOGICAL TABLE—Continued.

Chronology of Ussher.	Biblical Events.	Events in Contemporary History.		
		Babylonia.	Assyria.	Egypt.
			670. Esarhaddon conquers Egypt 668-626. Asshur-banipal (Assur-bani-pal)	664-525. <i>Twenty-sixth Dynasty</i> 664. Psammetichus I.
643	641. Amon (2)		663. Asshur-banipal invades Egypt, and sacks Thebes (Nah. iii. 8-10)	
641	639. Josiah (31)			
629	626. <i>Call of the prophet Jeremiah in Josiah's 13th year</i> (Jer. i. 2, xxv. 3)			
624	621. <i>Discovery of the Book of the Law</i> (Deuteronomy) in Josiah's 18th year (2 Kings xxiii. 3 ff.)	Chaldaeans Dynasty 625. Nabopolassar		
610	608. Jehoahaz (3 mo.)	610. Necho 608. <i>Battle of Megiddo</i> , and death of Josiah (2 Kings xxiii. 29)
610	608. Jehoiakim (11)		607. Destruction of Nineveh by the Medes, and end of the empire of Assyria	
		605. Defeat of Egyptians by Nebuchadnezzar (as his father's general) at Carchemish (Jer. xlvi. 2)		
		604. Nebuchadnezzar		
599	597. Jehoiachin (3 mo.) <i>First</i> deportation of captives (including Jehoiachin) to Babylonia, in the 8th year of Nebuchadnezzar (2 Kings xxiv. 12-16)			
599	597. Zedekiah (11)			
588	586. Destruction of Jerusalem by the Chaldaeans in the 19th year of Nebuchadnezzar (2 Kings xxv. 8). <i>Second</i> deportation of captives to Babylonia (2 Kings xxv. 4-21)	586. Nebuchadnezzar invades Egypt (cf. Jer. xliii. 8-13)		594. Psammetichus II. (Psammis) 589. Apries (Hophra, Jer. xlv. 30)
562	561. Jehoiachin released from prison by Evil-merodach in the 37th year of his captivity (2 Kings xxv. 27-30)	561. Amēl - marduk (Evil-merodach, 2 Ki. xxv. 27) 559. Nergal-sharuzur (Neriglissar) 555. (9 months) Lābashi-marduk (Laboriso-archod) 555. Nabu-na'id (Nabonēdus, Nabonidus) 539. Capture of Babylon by Cyrus <i>Persian Kings</i> 538. Cyrus		570. Amasis II. (jointly with Apries) 564. Amasis alone
536	<i>Judah a province of the Persian Empire</i> 538. Edict of Cyrus, permitting the Jews to return to Palestine. Many return under the leadership of Zerubbabel (Ezra i.-ii.)	529. Cambyses		
		522. (7 mo.) Gaumāta (Pseudo-Smerdis) 522. Darius Hystaspis		
515	516. Completion of the second Temple in the 6th year of Darius (Ezra vi. 15)	490. <i>Battle of Marathon</i> 485. Xerxes 480. <i>Battles of Thermopylae and Salamis</i> 465. Artaxerxes		526. Psammetichus III. 525. Conquest of Egypt by Cambyses
457	458. Return of exiles with Ezra, in the 7th year of Artaxerxes (Ezra vii. 7)			
445	445. Nehemiah's first visit to Jerusalem (Neh. i. 1, ii. 1)			

CHRONOLOGICAL TABLE—Continued.

Chronology of Ussher.	Biblical Events.	Events in Contemporary History.		
		Babylonia.	Assyria.	Egypt.
434	432. Nehemiah's second visit to Jerusalem (Neh. xiii. 6) c. 350. Many Jews carried away captive to Hyrcania and Babylonia, probably on account of a revolt against the Persians	423. Darius II. (Nothus) 404. Artaxerxes II. (Mnemon) 359. Artaxerxes III. (Ochus) 338. Arsēs 336. Darius III. (Codomannus) 333. Persian Empire overthrown by Alexander the Great		

Palestine now becomes a province, first of the empire of Alexander, and afterwards of that of one or other of Alexander's successors.

332. The Jews submit to Alexander the Great.
323. Death of Alexander in Babylon.
322. Alexander's general, Ptolemy Lagi, becomes Satrap of Egypt.
320. Ptolemy Lagi gains possession of Palestine, which, with short interruptions, continues in the hands of the Ptolemies till 198.
312. Beginning of the era of the Seleucidae (reckoned from the time when Seleucus Nicator, Alexander's former heavy cavalry officer, finally established himself in the satrapy of Babylonia. He founded Antioch as his capital, 300 B.C.).
305. Ptolemy Lagi assumes the title of king.
198. Antiochus the Great, king of Syria (223-187), defeats Ptolemy Epiphanes at Panias (Bānīyas, near the sources of the Jordan), and obtains possession of Palestine.
175-164. Antiochus Epiphanes, king of Syria (Dan. xi. 21-45).
168. Antiochus's attempt to suppress the religion of the Jews (1 Macc. i. 41-63; cf. Dan. vii. 8, 21, 24-26, viii. 9-14, xiii. 10-12). Public worship suspended in the Temple for three years.
167. Rise of the Maccabees (1 Macc. ii.).
160-165. Victories of Judas Maccabaeus over the generals of Antiochus (1 Macc. iii.-iv.).
165. Re-dedication of the Temple on 25th Chisleu (December), 1 Macc. iv. 52-61.
160. Death of Judas Maccabaeus (1 Macc. ix. 1-22).
160-142. Jonathan, younger brother of Judas, leader of the loyal Jews (1 Macc. ix. 23-xiii. 53).
142-135. Simon, elder brother of Judas (1 Macc. xiii.-xvi.).
135-105. John Hyrcanus, son of Simon.
105-104. Aristobulus I. (son of Hyrcanus), king.
104-78. Alexander Jannaeus (brother of Aristobulus), king.
78-69. Salome (Alexandra), widow of Alexander Jannaeus.
69. Aristobulus II. (son of Alexandra).
65. Capture of Jerusalem by Pompey. Palestine becomes a part of the Roman province of Syria.

if the regal years of the kings of Israel from Jeroboam to Jehoram be added together, they will be found to amount to 98, while if those of the kings of Judah for the same period (viz. from Rehoboam to Ahaziah) be added together, they amount only to 95. This discrepancy, if it stood alone, would not, however, be serious. But when we proceed to add up similarly the regal years in the two kingdoms from the division after Solomon's death to the fall of Samaria in the sixth year of Hezekiah (2 Kings xviii. 10), we find in the southern kingdom 260 years, and in the northern kingdom only 241 years 7 months. This is a formidable discrepancy. Ussher, in order to remove it, has recourse to the doubtful expedient of artificially lengthening the northern series of years, by assuming (without any authority in the text) an "interregnum of 11 years" after the death of Jeroboam II., and an "anarchy for some years" after the death of Pekah and Hoshea (see the margin of A.V. at 2 Kings xiv. 29; xv. 8, 29).

(2) As we now know, the methods of chronological computation adopted by the Assyrians were particularly exact. Every year a special officer was appointed, who held office for that year, and gave his name to the year; and "canons," or lists, of these officers have been discovered, extending from 893 to

666 B.C.¹ The accuracy of these canons can in many cases be checked by the full annals which we now possess of the reigns of many of the kings—as of Asshur-nazir-abal or Assur-nasir-pal (885-860 B.C.), Shalmaneser II. (860-825), Tiglath-pileser IV. (745-727), Sargon (722-705), Sennacherib (704-781), Esarhaddon (681-668), and Assurbanipal or Assur-bani-pal (668-626). Thus from 893 B.C. the Assyrian chronology is certain and precise. Reducing now both the Assyrian and Biblical dates to a common standard,² and adopting for the latter the computations of Ussher, we obtain the following singular series of discrepancies:—

	Dates according to Ussher's Chronology.		Dates according to Assyrian Inscription.	
	B.C.	B.C.	B.C.	B.C.
Reign of Ahab		918-897		
Ahab mentioned at the battle of Karkar				854
Reign of Jehu		884-856		
Jehu pays tribute to Shalmaneser II.				842
Reign of Menahem		772-761		
Menahem mentioned by Tiglath-pileser IV.				738
Reign of Pekah		759-739		
Reign of Hoshea		739-721		
Assassination of Pekah and succession of Hoshea, mentioned by Tiglath-pileser IV.				733 (or 732) ³
Capture of Samaria by Sargon in Hezekiah's sixth year (2 Kings xviii. 10)		721		722
Invasion of Judah by Sennacherib in Hezekiah's fourteenth year (<i>ibid.</i> ver. 13)		713		701

Manifestly all the Biblical dates earlier than 733-732 B.C. are too high, and must be considerably reduced; the two events, also, in Hezekiah's reign—the fall of Samaria and the invasion of Sennacherib—which the compiler of the book of Kings treats as separated by an interval of eight years, were separated in reality by an interval of twenty-one years.⁴

¹ See George Smith, *The Assyrian Epitome Canon* (1875), pp. 29 ff., 57 ff.; Schrader, *Keilschriftliche Bibliothek* (transcriptions and translations of Assyrian and Babylonian inscriptions), i. (1880), pp. 204 ff.

² It may be explained here that the dates of the Assyrian and Babylonian kings can be reduced to years B.C. by means of the so-called "Canon of Ptolemy," which is a list of the Babylonian and Persian kings, with the lengths of their reigns, extending from Nabonassar, 747 B.C., to Alexander the Great, drawn up in the 2nd century A.D. by the celebrated Egyptian mathematician and geographer Ptolemy; as the dates B.C. of the Persian kings are known independently, from Greek sources, the dates B.C. of the preceding Babylonian kings can, of course, be at once calculated by means of the Canon. The recently-discovered overtemporal monuments have fully established the accuracy of the Canon.

³ Or, in any case, between 734 and 732; see Rost, *Die Keilschrifttexte Tiglath-pileser's III.*, 1893, pp. xiii., 39, 81, with the discussion, pp. xxxii.-xxxiv., xxxv.-xxxvi.

⁴ This interval does not depend upon a mere list of Egyptian years; we have in the annals of Sargon and Sennacherib full particulars of the events in all the intervening years.

Much has been written on the chronology of the kings and many endeavours have been made to readjust the Biblical figures so as to bring them into consistency with themselves and at the same time into conformity with the Assyrian dates. But, though the fact of there being errors in the Biblical figures is patent, it is not equally clear at what points the error lies, or how the available years ought to be redistributed between the various reigns. It is in any case evident that the accession of Jehu and Athaliah must be brought down from 884 to 842 B.C.; and this will involve, naturally, a corresponding reduction of the dates of the previous kings of both kingdoms, and of course, at the same time, of those of Solomon, David and Saul. The difficulty is, however, greatest in the 8th century. Here, in Judah, from the accession of Athaliah to the accession of Ahaz, tradition gives 143 years, whereas, in fact, there were but 106 years (842-736); and in Israel, from the death of Menahem to the fall of Samaria, it gives 31 years, whereas from 738 (assuming that Menahem died in that year) to 722 there are actually only 16 years. The years assigned by tradition to the reigns in both kingdoms in the middle part of the 8th century B.C. have thus to be materially reduced. But in the following period, from the fall of Samaria in 722 to the capture of Jerusalem by the Chaldeans in 586, the Biblical dates, so far as we can judge, are substantially correct. (See further the table above.)

4. *From the Destruction of Jerusalem in 586 to the close of the Old Testament History.*—Here, though it is true that there are events in the Biblical history which are not fully or unambiguously dated, there is otherwise no difficulty. The lengths of the reigns of Nebuchadrezzar and his successors on the throne of Babylon, and also, after the conquest of Babylon, of Cyrus and the following Persian kings, are known from the "Canon of Ptolemy," referred to above, the particulars in which, for the earlier part of this period, are also confirmed by the testimony of the monuments.

See, for further information on the subject, the article CHRONOLOGY, and the same heading in the *Encyclopædia Biblica*, cols. 773-799, with the literature referred to on col. 819 (especially the writings of Noldeke, Wellhausen, and Kamphausen there mentioned).

(S. R. D.)

(B) NEW TESTAMENT

1. Canon.

The New Testament is the collection of the Sacred Books of Christians. It forms in the Bible the distinctive possession of Christians, just as the Old Testament is the collection of Sacred Books which Christians share with Jews. Every term in the definition is significant and has a history. There are, first, the Books; then, the Collection; then, the Sacred Volume, complete as such in idea, though not as yet complete in its actual contents; and, lastly, the Sacred Volume in its full dimensions, as it has come down to us.

There is a double development, of quality and of quantity; of quality, as to the estimate formed of the books, their increasing recognition as sacred; and of quantity, by which the books so recognized were gradually brought up to their present number. Our duty will be to describe this double process, and we shall do so under the four heads: (a) The Growth of a specifically Christian Literature; (β) The Collection of the Books into a single volume, made up of ordered groups; (γ) The investing of this volume with the character of a Sacred Book; and (δ) The gradual settlement by which the volume assumed its present dimensions, neither less nor more.

The model throughout was the Old Testament. The result was attained when there was a definite volume called the New Testament by the side of the earlier volume called the Old Testament, complete like it, and like it endowed with the attributes of a Sacred Book. This is the consummation towards which events had been steadily moving—not at first consciously, for it was some time before the tendencies at work were consciously realized—but ending at last in the complete equation of Old Testament and New, and in the bracketing together of both as the first and second volumes of a single Bible. This is the process that we shall have to describe. And because the process

before us is the gradual assimilation of New Testament and Old Testament, we shall have to include at each step all that bears upon this. For instance, at starting, it will not be enough for us simply to tell the story how the Books of the New Testament came to be written, but we shall have to point out what there was about them which fitted them to be what they afterwards became, what inherent qualities they possessed which suggested the estimate ultimately put upon them; in other words, how they came to be not only a collection of Christian books, but a collection of Christian sacred books, or part of a Bible.

(a) *The Growth of a Christian Literature.* 1. *The Pauline Epistles.*—The Bible of Jesus and His disciples was the Old Testament. And both Jesus and His disciples were to all appearance content with this. It was probably two full decades after the death of Christ before there were any specifically Christian writings at all. The first generation of Christians was not given to writing. There was not only no obvious reason why it should write, but there was a positive reason why it should not write. This reason lay in the dominant attitude of Christians, which was what we call "eschatological." The first generation of Christians lived in the daily expectation that Christ would return from heaven. The truth is, that not only were Christians expecting (as we say) the Second Coming of the Messiah, but what they expected was *the* Coming. The Messiah, as all Jews conceived of Him, was a superhuman being; and His First Coming as a man among men did not count as really Messianic. The whole first generation of Christians looked intently for His Coming in power and great glory, which they believed to be near at hand. In such a state of mind as this there was no motive for seeking permanence by writing. Men who imagined that they might at any moment be caught up to meet the Lord in the air were not likely to take steps for the instruction of the generations that might come after them.

Hence the first Christian writings were no deliberate product of theologians who supposed themselves to be laying the foundation of a sacred volume. They were not an outcome of the dominant tendencies of the time, but they arose rather in spite of them, in the simplest way, just from the practical needs of the moment.

It was thus that St Paul came to write his two epistles to the Thessalonians, the oldest Christian documents that we possess. By this time he was launched on his missionary labours; he had founded a number of churches, and he was going on to found others. And these earliest epistles are just the substitute for his personal presence, advice which he took occasion to send to his converts after he had left them. There are a few indications that he had sent similar communications to other churches before, but these have not been preserved. Indeed the wonder is—and it is a testimony to the strength of the impression which St Paul left upon all with whom he came into contact—that these missionary letters of his should have begun to be preserved so soon.

Both Epistles to the Thessalonians have for their object to calm somewhat the excited expectations of which we have spoken.

The first Epistle hits exactly the prominent features in the situation, when it reminds the Thessalonians how they had "turned unto God from idols, to serve a living and true God, and to wait for his Son from heaven," who would deliver them from the wrath to come (1 Thess. i. 9, 10). The turning from idols was of course peculiar to the Gentile communities, but the waiting for the Messiah from heaven was common to all Christians, whatever their origin. In this we may take the epistle as typical of the state of the whole Church at the time. And there is another important passage which shows why, in spite of its natural and occasional character, the epistle exhibits the germs of that essential quality which caused all the books of the New Testament to be so highly estimated. The apostle again reminds his readers how they had received his preaching "not as the word of men, but as it is in truth, the word of God," which showed its power by the way in which it took hold of those who believed in it (1 Thess. ii. 12). The reference is of

course primarily to the spoken word, but the written word had the same qualities as the spoken. It was the deep impression made by these which prepared Christians generally to accept the apostolic writings as inspired, and therefore sacred. There is no greater mistake than to suppose that the estimate formed by the early Church of its Bible was a merely arbitrary verdict imposed by an external authority; it was the expression, and the natural expression (though following certain prescribed lines), of its real sense of the value and fundamentally divine origin of the writings which it treasured.

Nearest in character to the Thessalonian Epistles are the two to Corinth, which have perhaps an interval of a year and a half between them. When 1 Corinthians was written, the attitude of the Church was still strongly eschatological (1 Cor. i. 7, 8, iii. 13-15, vii. 26, 29-31, xv. 25, 26, 51-54, xvi. 23). The thoughts of men were still set upon the near approach of the end, the troublous times that would issue in the break-up of the existing order and the return of Christ to introduce a new era. There was no idea of constructing a systematic theology; Christ was still the Jewish Messiah, and His Coming was conceived of as the Jews conceived of the coming of the Messiah, as a great supernatural event transforming the face of things and inaugurating the reign of God. In view of this approaching revolution, both the Church and the world were regarded as living from hand to mouth. It was useless to attempt to found permanent institutions; everything was provisional and for the moment. And yet, even under these conditions, some practical arrangements had to be made. The epistle is taken up with matters of this kind; either the apostle is reproving disorders and abuses actually existing in the Church, and almost sure to exist in a young community that had just adopted a novel method of life and had as yet no settled understanding of the principles involved in it; or else he is replying to definite questions put to him by his converts. In all this the epistle is still a genuine letter, and not a treatise. It only rises from time to time above the level of a letter, through the extraordinary penetration, force, enthusiasm and elevation of feeling that the apostle throws into his treatment of more or less ordinary topics. He can never rest until he has carried up the question of the moment to some higher ground of faith or conduct. It is in this incidental and digressive way that we get the description of the Gospel in i. 18-ii. 16; of the Christian ministry in chs. iii., iv.; of the principle of consideration for others in ch. ix.; of the Sacrament of the Lord's Supper in chs. x., xi.; of Christian love in ch. xiii.; of the Resurrection and its consequences in ch. xv.

2 Corinthians is even more a product of the situation: it is even more taken up with personal relations. No epistle sheds more light on St Paul's character as a man—so mobile, so tactful, so tender and affectionate, and yet so statesmanlike and so commanding. If doctrinal utterances occur from time to time, they are in every case incidental and unpremeditated.

The development of doctrine in St Paul's epistles is due in part to the gradual subsiding of the eschatological temper, but even more to the growth of controversy. A crisis had arisen in Galatia owing to the invasion of the churches, which St Paul had founded there, by reactionary Jews. This called forth a letter¹ from St Paul, who felt himself compelled to grapple at close quarters with teaching which he saw cut at the very root of his own. He was thus led both to clear up for himself and to state for the sake of others his whole conception of soteriology—his answer to the question how was man to be set right before God. That was a large part, and at the moment the most crucial part, of the whole problem of religion.

Two or three years later (c. A.D. 55-56) St Paul was bent on paying a visit to Rome. He was not going there straight, but to Jerusalem first. He knew that he could only do this at the

¹ The date of this epistle is rather uncertain. Something depends upon the vexed question as to the identity of the Galatian churches. The epistle may be placed conjecturally early in the stay at Ephesus (c. A.D. 52-53). It is to be noted that the chronological grouping of the epistles by minute comparison of style is apt to be deceptive; resemblances of this kind are due more to similarity of subject than to proximity in date.

imminent peril of his life. It seemed very doubtful whether he would accomplish his desire. And therefore he took the opportunity to send to the Romans what is really a summing up, not of the whole of Christianity, but of that side of Christianity which the preceding controversy had brought into special relief. He states his case as part of a larger question still—a question that inevitably became pressing at that particular time—as to the entire religious relation of Jew and Gentile.

These years of shock and conflict could not fail to have marked effect upon the shaping of definite Christian doctrine. They drew attention away from the future to the present, and to the past as leading up to the present. They compelled a man like St Paul to theorize: thought was driven inward; it was made to search for foundations, to organize itself and knit together part with part. And the impulse thus given continued. It showed itself strongly in the epistles of the next group, especially Ephesians and Colossians. These epistles took their form at once from a natural progression of thought and from a new phase of controversy, a sort of Gnosticizing theory, or theories, which perverted Christian practice and impaired the supremacy of Christ by placing other beings or entities by His side. The apostle meets this by renewed emphasis on the central position of Christ; and he at the same time carries a step farther his conception of the unity of the Church, as embracing both Jew and Gentile. The predominance of this somewhat recedite teaching gave to these epistles even more the character of treatises, which in the case of Ephesians is further enlanced by the fact that it is probably a circular letter addressed not to a single church but to a group of churches. Philemon is of course a pure letter, and Philippians mainly so, the Pastorals, as their name implies, contain advice and instructions to the apostle's lieutenants, Timothy and Titus, in the temporary charge committed to them of churches that the apostle could not visit himself.

The Epistle to the Hebrews is an epistolary treatise of uncertain date, on the Pauline model, and by a disciple of St Paul or at least a writer strongly influenced by him, though influenced also in no small degree by the Jewish school of Alexandria represented by Philo. Of the many theories as to the address, the most plausible are perhaps those which would apply to a single congregation of Hebrew Christians in Rome, or to a local church or group of local churches in Palestine, perhaps like that of which the centre would be at Caesarea. It is not probable that the epistle was addressed to the mother church at Jerusalem.

The above sketch of the growth and general character of the Pauline Epistles is based upon the hypothesis that all thirteen are genuine. But some discrimination should be made in detail. The scepticism which challenges the whole collection may be set aside as radically perverse and unreasonable. Apart from this, the keen criticism of modern times has fastened especially upon two groups:—2 Thessalonians; Colossians with Philemon, Ephesians and the Pastorals. The present writer would accept without any real hesitation the first of these classes; and the second he would also himself accept, though in regard to this class he would think it right to speak with rather more reserve. This may be said to be the position generally taken up by the leading English scholars; it differs slightly in a conservative direction, but not widely, from that of Harnack, a little more from that of Jülicher, and again a little more from that of von Soden.

2 Thessalonians is still questioned by scholars of some note; but when Jülicher can say that no question could be raised if it were not for the existence of 1 Thessalonians (assumed to be genuine), this is practically giving up the whole case, because the objections drawn from 1 Thessalonians are, at least to the present writer, only an example of faulty criticism. Still less is there any valid argument against Philemon. It is a mark of the improved methods now current in Germany that, whereas in 1886 this epistle was rejected by a scholar as able and sober as Weizsäcker, Jülicher now pronounces it "among the most assured possessions of the apostle" (*Einh.* 5th ed., p. 112).

But there is an arguable case of some real weight against Colossians, Ephesians, Pastorals—least against Colossians and perhaps most against the Pastorals. Colossians is strongly vouched for by its connexion with Philemon. And the objections to Ephesians are considerably reduced when it is taken as a circular letter. But it should be admitted that, especially in regard to Ephesians and Pastorals, there is a perceptible difference, (a) in style, and (b) in characteristic subject matter, from the standard epistles. If these

later epistles are really the work of St Paul, the difference must be accounted for (a) by a somewhat unusual range of variation in style and thought on his part, and (b) by different environment and different purpose. The question is whether these explanations are adequate. The writer of this is inclined to think that they are. St Paul was in any case an unusual writer, by no means facile or with ready command of expression; still, he could by an effort express what he wanted, and new situations called up new words and new minor ideas. He was also a writer in whom the physical wear and tear must have been enormous. It might well be believed that the change in the so-called Epistles of the Imprisonment from the earlier epistles was due in part to the physical effects of prolonged confinement, as compared with the free, varied and open life and exciting controversies of earlier years. There is also the uncertain element that may possibly be due to the use of different amanuenses. An argument in favour of the genuineness of the epistles may be derived from the fact that both of the doubtful epistles is connected with others that are not doubtful by subtle links both of style and thought. If the reasons suggested above are not adequate, then we must set down the questioned epistles to some disciple of St Paul, who has carried the ideas and principles of his master a step further or has applied them to a different set of problems and conditions.

2. *The Gospels and Acts*.—The Gospels and Acts arose in a way very similar to the Pauline Epistles. Here too there was no deliberate intention of writing a series of books that should be at once accepted as sacred and authoritative. Here too the expectation of the near return of Christ doubtless delayed for a number of years the desire and need for written compositions. Here too the first steps were taken as the exigencies of the moment dictated. We are again driven to fill up the gaps in our knowledge by conjectures; but some such outline as the following has much to commend it.

When the enterprise of Christian missionaries had gone on for some little time, especially in the regions outside Palestine where there was little or no previous knowledge of Christ and of Christian ideals, the wandering prophets and apostles by whom the missions were mainly conducted must have soon begun to feel the need for some sort of written manual to supplement their own personal teaching. It was one of the characteristics of the early Christian teachers that they rarely stayed for any length of time in a place; they moved on, and the little congregation was left to wait for another visitor, who might be some time in coming. How was this interval to be filled? There would be every degree of preparation, or want of preparation, for the reception of Christian teaching. Some Jews, like those who are described in the Gospel as "waiting for the kingdom of God," would be pious men and women carefully trained in the Old Testament, who would be almost fit for the kingdom even before they had heard of Christ. Other Gentile converts would require instruction in the very rudiments of ethical and monotheistic religion. Between these extremes there would be many shades and degrees of ignorance and knowledge. How could these various cases be met at once most simply and most effectually? We remember that the Christian preachers were preaching before all things a Person, but a Person whose interest for these new converts lay chiefly in the fact that He was about to come and establish a supernatural kingdom for which they had to fit themselves. The best way therefore of helping them to do this was to provide them with an outline of the characteristic teaching of Christ, which should be at the same time a clear statement of His moral demands. It is probable that these requirements suggested the form of the first Christian Gospel, which the writer believes to be rightly identified with the so-called *Logia* of St Matthew, now often designated by the symbol Q. It did not aim at being a history, and still less a complete history, but it was mainly a collection of sayings or discourses suited to supply a rule of life.

It would be somewhat later than this, and not until the eschatological outlook became weaker, and men began to turn their regard to the past rather than to the future, that there would gradually arise a more strictly historical interest. There is reason to think that in the Christian Church this interest did not begin to be active much before the decade A.D. 60-70. Its first conspicuous product was our present Gospel of St Mark, which was probably composed at Rome within the years 64-70. We say advisedly "our present Gospel of St Mark," because

there does not seem to us to be any sufficient reason for presupposing an *Ur-Marcus*, or older form of this Gospel.

These two works, the *Logia* (or, as some prefer to call it, the Non-Marcian document common to Matthew and Luke) and the Mark-Gospel, were the prime factors in all the subsequent composition of Gospels. Our Matthew and our Luke are just combinations, differently constructed, of these two documents, with a certain amount of additional matter which the editors had collected for themselves. And it is probable that other Gospels of which only fragments have come down to us, like the Gospel according to the Hebrews and the Gospel of Peter, have been built up out of the same materials.

St Luke was the first to write, as we may see from his preface, definitely in the spirit of a historian. He addresses his work to Theophilus, apparently an official person, who had already been taught the main outlines of Christianity. He had planned his work on a large scale; and in Acts we have its second volume. It is an event of no small importance for criticism that so eminent a scholar as Prof. Harnack should have come round to the view, almost universally prevalent in England, that St Luke himself was the final editor and author of both the Third Gospel and the Acts. It is a very secondary question what is their exact date.

The reasons which converge upon the conclusion just expressed as to the origin and nature of the fundamental documents worked up in our present Synoptic Gospels are as follows:—(i.) The literary analysis of the Synoptic Gospels brings out a number of sections common to Matthew and Luke which probably at one time existed as an independent document. (ii.) This document consisted, in the main though not entirely, of a collection of Sayings of the Lord, which set in strong relief at once His character and the moral and religious ideal that He desired to commend. (iii.) We have an express statement, which must have been originally made before the end of the first century, that the apostle Matthew composed in Hebrew a work described as *Logia*. This word need not mean, but may quite well and pointedly mean, a collection specially of Sayings, and would still more aptly denote a collection of divine or authoritative sayings (*λόγια* = prop. "oracles"). (iv.) We know further that the conditions of early Christian missionary teaching were such as have been described. We learn this especially from the *Didaché*; and the first part of that work, the so-called "Two-Ways," is commonly thought to have been in the first instance a Jewish manual put into the hands of proselytes. On our hypothesis the *Logia* would have been a sort of Christian manual used with a similar object. (v.) We are confirmed in this opinion by the fact that the epistles of St Paul furnish many indications that Christians in general, including those who had not been much in contact with the original Twelve, were well acquainted with the leading features in the character of Christ and in the Christian ideal, although there is little corresponding evidence for their knowledge of details in the life of Christ.

There is a similar statement to the one mentioned above, that like it must have been originally made before the end of the first century, as to a Gospel composed by St Mark on the basis mainly of the preaching of St Peter, though this need not exclude personal experience (as, e.g., perhaps in Mark xiv. 51-52) or information derived from other sources. Only raw materials came from St Peter, and those probably not checked or revised by him; the arrangement is due to Mark himself, and is more successful than might have been expected in the circumstances—indeed so successful as to suggest advice from some good quarter. According to Irenaeus (c. A.D. 185), who is more precise than Clement of Alexandria, the Gospel was not published until after the death of Peter, which would place its composition between the limits A.D. 65 and 70. The phenomena which are sometimes supposed to require the hypothesis of an *Ur-Marcus* are more simply and satisfactorily explained as incidents in the transmission of the Marcan text.

The matter peculiar to Matthew and Luke raises a number of interesting questions which are still too much *sub judice* to

be answered decidedly or dogmatically, though approximate and provisional answers may before long be forthcoming. All parts of the problem have been greatly forwarded by the recent publication of important works by Wellhausen and Harnack (see below). The date of the completed Luke depends (a) on whether or not we believe Luke himself or a later disciple to be the author, and (b) whether or not we believe that the author of Acts had seen Josephus' *Antiquities*, published in A.D. 93 or 94. Professor Burkitt takes an original line in maintaining that Luke was the author of both works, and yet that he had seen *Antiq.* The present writer is inclined to think the latter hypothesis not proven. The date of Matthew cannot be fixed more nearly than 70-100.

3. *The Catholic Epistles.*—The Catholic Epistles were so called in the first instance from their wider and more indefinite address; they were intended for Christians generally, or over some wide area, rather than for a particular church or individual. 2 and 3 John are exceptions, but probably came in under the wing of the larger epistle, which is strictly "catholic." As applied to a class of epistles, the title dates from Eusebius, early in the 4th century; the epithet is given to single epistles by Origen, and is found as far back as the end of the 2nd century. In later Latin usage "catholic" came to mean much the same as "canonical," another name that was also given.

This group of epistles practically continues and supplements the work of the epistles of St Paul. 1 Peter, if genuine, must date from the end of the apostle's career (for the early composition claimed for it by B. Weiss is a paradox that may be disregarded). It was written to instruct and encourage the Christians of Asia Minor at a time of persecution, which on the hypothesis of genuineness, would be the Neronian, *i.e.* a secondary outbreak perhaps loosely connected with the onslaught in Rome. The Epistle of James (also, if genuine) must be placed late in the lifetime of the brother of the Lord. In that case it was probably not written with any direct polemic against writings of St Paul, but against hearsay versions of his teaching that had reached Jerusalem. Controversy of this kind is not always conducted with complete understanding of that which is being opposed. The Epistle of Jude cannot be either dated or localized with any certainty. It seems on the whole most probable that 2 Peter is not a genuine work, but that it came from the same factory of pseudonymous Petrine writings as the Apocalypse which bears the same name, though the one has, and the other has not, obtained a place within the Canon. This epistle was questioned from the first, and only gained its place with much hesitation, and rather through slackness of opposition than any conclusiveness of proof. The three Johannine epistles may be more conveniently treated under the next head.

Even in the case of the two more important epistles, 1 Peter and James, we have to add the qualification "if genuine" but rather perhaps because of the persistence with which they are challenged than because of inherent defect of attestation. The evidence for 1 Peter is both early in date and wide in range, and the book was one of those that passed as "acknowledged" in antiquity. The evidence for James is not so widely diffused but is found in early writings. Perhaps the position of these two epistles might be described as not unlike that of Colossians and Ephesians. Instead of casting doubt upon them, we should prefer to say that they are both probably genuine, but that there are features about them that are not as yet fully explained. The chief of these features is their relation to the writings of St Paul. There is indeed so much that is Pauline in 1 Peter as to give distinct attractiveness to the hypothesis, which is most elaborately maintained by Zahn, that a larger share than usual in the composition of the letter was left to Silvanus (1 Peter v. 12). Nor does it appear to us that the objections to this theory brought by Dr Chase in his excellent article on the epistle in *Hastings' Dictionary* are really so fatal as he supposes. The epistle is more the work of a companion of St Paul of long standing than of one who, with quite different and independent antecedents, had only been influenced by the perusal of one or

two of St Paul's letters. In the Epistle of James we have a really distinct type; and it seems to us that the degree to which the epistle misses its mark as a polemic may be easily and naturally accounted for in more ways than one.

4. *The Johannine Writings.*—The Gospel and Epistles that bear the name of John, and the Apocalypse, form a group of writings that stand very much by themselves and are still the subject of active discussion. The points in regard to them that would unite the greatest number of suffrages would seem to be these:—(i.) That, except 2 Peter, they are probably the latest of the New Testament writings, and that they form a group closely connected among themselves, though it is not clear how many hands have been at work in them. (ii.) That they arose not far from each other towards the end of the 1st century. The Apocalypse is plausibly dated by Reinach and Harnack near to the precise year 93, and the other writings may be referred to the reign of Domitian (81-96), though many critics would extend the limit to some two decades later. (iii.) The writings are to be connected, either more or less closely, with John of Ephesus, who was a prominent figure towards the end of the 1st century. On the other hand, the greatest differences would be:—(i.) As to the personal identity of this John—is he himself "the beloved disciple"? Is he the apostle, the son of Zebedee or another? Can the writer of the Apocalypse be the same as the writer of the Gospel and Epistles? (ii.) What is the exact relation of John of Ephesus to the Gospel? Is he its author or only the authority behind it? (iii.) How far is the Gospel intended to be, and how far is it, in the strict sense historical? This last question is beginning to overshadow all the rest.

Whatever may be the ultimate decision on these intricate questions, the Fourth Gospel in any case played a very important part in the history of the Church and of Christian theology. It drew together and gathered up into itself the forces at work in the apostolic age; and, by reaching out a hand as it were (through the preface) towards Greek philosophy, it succeeded in so formulating the leading doctrines of Christianity as to make it more acceptable than it had as yet been to the Gentile world, and in securing for the Gospel a place in the main stream of European thought. It is probably true to say that no other primitive Christian writing has had so marked an effect on all later attempts to systematize the Christian creed.

The situation as to the Fourth Gospel has been altered in recent years by the statement attributed to Papias that the two sons of Zebedee (and not only one) were slain by the Jews—a statement which becomes more difficult to put aside as the evidence for it increases (full details in Burkitt, *Gosp. Hist.* pp. 252-255; E. Schwartz, *Über d. Tod d. Söhne Zebedai*, Berlin, 1904). But this statement does not affect the historical character of John of Ephesus, who is also expressly described by Papias as "a disciple of the Lord" (Eus. *H.E.* iii. 39. 4). On the other hand, the theory that the Gospel is a thorough-going allegory must be hard to maintain in view of the frequent appeals to "witness" which is several times defined as eye-witness (John i. 15, 32, iii. 11, xix. 35, xxi. 24; 1 John i. 1-3; cf. John v. 36, x. 25). This is borne out by Ignatius with his strong emphasis on the reality of the Gospel history (*Epist.* xx. 2; *Tract.* x; *Smyrn.* i. 1, 2; ii. iii. 1-3, v. 2). If the writer of the Gospel were simply inventing his facts, they would be no proof of his thesis (John xx. 31). It is a paradox that he should be invoked "to prove the reality of Jesus Christ" (as against Docetism), and yet that it should be contended at the same time that for him "ideas, and not events, were the true realities."

5. *Other Literature not included in the New Testament.*—It must not be thought that the primitive Christian literature came abruptly to an end with the writings that are included in our present New Testament. On the contrary, all round there was a broad fringe of writings more or less approximating to them in character. Most nearly on the lines of the New Testament are the so-called Apostolic (really Sub-Apostolic) Fathers (Clement of Rome to the Corinthians, *Didachē*, Barnabas, the letters of Ignatius and the single letter of Polycarp, the *Shepherd* of Hermas, the homily commonly known as the Second Epistle of Clement). These are in most cases the writings of leading persons in the Church who took up and continued the tradition of the apostles. Barnabas and 2 Clement are more

eccentric, but the writers must have been persons of some note. Outside this group would come what are called the Apocryphal Gospels and Acts (Gospel according to Hebrews, according to Egyptians, of Peter, of Truth, of the Twelve [or Ebionite Gospel], the recently recovered so-called *Logia*; the Gospel of Nicodemus, the Protevangelium of James, the Gospel of Thomas, the Acts of Pilate, Acts of Paul, Peter, John, Andrew, Thomas; the Preaching of Peter, the Apocalypse of Peter). As the 2nd century wears on, we come to controversial or philosophical works by Agrippa, Castor, Quadratus, Aristides. With the middle of the century we reach a considerable writer in Justin Martyr. With him the twilight period which succeeds to the apostolic age is over, and we enter upon the main course of ecclesiastical history. At this point, therefore, our survey may end.

(β) *The Process of Discrimination and Collection.* 1. *Discrimination.*—Throughout the apostolic age Christians were conscious of being carried forward in a great movement, the origin and motive-power of which they regarded as supernatural. It began on the Day of Pentecost, but continued in full tide almost to the end of the 1st century, and, even when it began to subside, it did so quite gradually. The moment of transition is clearly marked in the *Didaché*, where the *charismatic* ministry of "apostles and prophets" is beginning to give place to permanent local officials of the Church, bishops, presbyters and deacons. The literature that we now call the New Testament held its place because it was regarded as a product of the palmy days of that great movement. It was considered to be the work of inspired men, of men whom the Holy Spirit, at that time specially active in the Church, had chosen as its organs. We have seen how St Paul, for instance, fully believed that his own preaching had a force behind it which vindicated for it the claim to be "the word of God" (1 Thess. ii. 13); and it was inevitable that the other preachers and teachers should have had in different degrees something of the same consciousness. This consciousness receives perhaps its strongest expression in the Apocalypse.

There is really no contradiction between this sense of a high calling and mission, with a special endowment corresponding to it, and the other fact that the writings from this age that have come down to us are all (except perhaps the Apocalypse, and even the Apocalypse, in some degree, as we see by the letters to the Seven Churches) strictly occasional and natural in their origin. The lives and actions of apostles and prophets were in their general tenor like those of other men; it was only that, for the particular purpose of their mission, they found themselves carried beyond and above themselves. St Paul himself knew when he was speaking by the Spirit, and when he was not; and we too can recognize to some extent when the *afflatus* comes upon him. It is fortunate that this should be so clearly marked in his epistles, because it enables us to argue by analogy to the other writers. When we come to historical books like the third Gospel and the Acts, we find the writer just pursuing the ordinary methods of history, and not claiming to do anything more (Luke i. 1-4). With the methods of history, these writers were naturally exposed to the risks and chances of error attendant upon those methods. There was not at first among the writers any idea that they were composing an infallible narrative. The freedom with which they used each other's work, and with which the early texts were transmitted, excludes this. But there was the idea that the whole movement of the Church to which they gave expression was in a special sense divine. And this belief was the fundamental principle that determined the marking off of the writings of the first, or apostolic, age from the rest.

At the same time it must not be supposed that a hard and fast line can be drawn beyond which the spiritual stimulus of this first age ceased. The writings of Clement of Rome (A.D. 97) and of Ignatius (c. A.D. 110) mark the transition. Ignatius, for instance, clearly distinguishes between his own position and that of the apostles: "I do not enjoy you, as Peter and Paul did. They were Apostles, I am a convict; they were free, but I am a slave to this very hour" (Rom. iv. 3). And yet, none the less, Ignatius is conscious of acting and speaking at times from a

kind of inspiration. "Even though certain persons desired to deceive me after the flesh, yet the spirit is not deceived, being from God; for it knoweth whence it cometh and where it goeth, and it searcheth out the hidden things. I cried out, when I was among you; I spake with a loud voice, with God's own voice, give ye heed to the bishops, and the presbyters and deacons" (*Philadelph.* vii. 1). In like manner Clement, in two places (lix. 1, lxiii. 2), writes as though God were speaking through him.

2. *Collection.*—Concurrently with the tendency to discriminate between the higher authority of certain writings and the lower authority of others, there was also a tendency to collect and group together writings of the first class. The earliest example of this tendency is in the case of the Pauline Epistles. Marcion, we know (c. A.D. 140), had a collection of ten out of thirteen, in the order, Gal., 1 and 2 Cor., Rom., 1 and 2 Thess., Laodic. (= Eph.), Col., Phil., Philem. We observe that the Pastorals are omitted. But it is highly probable that the collection went back a full generation before Marcion. The short Epistle of Polycarp contains references or allusions to no less than nine out of the thirteen epistles, including 2 Thess., Eph., 1 and 2 Tim. Ignatius, writing just before, gives clear indications of six, including 1 Tim. and Titus. The inference lies near at hand that both writers had access to the full collection of thirteen, not omitting the Pastorals. Polycarp (*ad Phil.* xiii. 2) shows how strong was the interest in collecting the writings of eminent men.

It of course did not follow that, because the letters of St Paul were collected, they were therefore regarded as sacred. The feeling towards them at first would be simply an instinct of respect and deference; but we have seen above that the essential conditions of the higher estimate were present all along, and were only waiting to be recognized as soon as reflective thought was turned upon them. This process appears to have been going on throughout the middle years of the 2nd century.

The famous passage of Irenaeus (*Adv. Haer.* iii. 15, 8) assumes the possession by the Church of four authoritative Gospels and no more. This is the general view of the Church of his time, except the little clique known as the Alogi who rejected the Fourth Gospel, and Marcion who only recognized St Luke. But here again, we may go back some way farther. Irenaeus writes (c. A.D. 185) as though the Four Gospels had held the field as far back as he can remember. About A.D. 170 Tatian, the disciple of Justin, composed out of these Gospels his *Diatessaron*. If Justin used any other Gospel, his use of it was very subordinate. Practically we may say that the estimate of the Four to which Tatian and Irenaeus testify must have been well established by the middle of the century, though sporadic instances may be found of the use of other Gospels that did not become canonical. The sifting out of these was proceeding steadily and gradually, and by the end of the century it may be regarded as complete.

We must make allowance for the existence of this margin, and for the blurring of the boundary-line that goes along with it. We cannot claim for the Church absolute sureness of judgment as to what falls on one side of the line and what on the other. It is possible, e.g., that a mistake has been made in the case of 2 Peter, which, however, is edifying enough. It is not less possible that writings like 1 Clem. and Epp. Ignat. are not inferior in real religious value to the Epistle of Jude. But, broadly speaking, the judgment of the early Church has been endorsed by that of after ages.

Harnack raises an interesting question (*Reden u. Aufsätze.* ii. 239 ff.), how it came about that Four Gospels were recognized, and not only one. There are many indications early in the 2nd century of a tendency towards the recognition of a single Gospel; for instance, there are the local Gospels according to Hebrews, according to Egyptians; Marcion had but one Gospel, St Luke, the Valentinians preferred St John and so on; Tatian reduced the Four Gospels to one by means of a Harmony, and it is possible that something of the kind may have existed before he did this. There is probably some truth in the view that the Church clung to its Four Gospels as a weapon against Gnosticism; it could not afford to reduce the number of its documents. But, over and above this, there was probably something in the circumstances in which the

canonical Gospels were composed, and in their early history, which gave them a special prestige in the eyes of the faithful. The story which Eusebius quotes from Clement of Alexandria (*H.E.* vi. 14) seems to point to something of the kind.

3. *Influences at work.*—The whole process of the formation of the New Testament was steady and gradual. The critical period, during which the conception grew up of the New Covenant with its sacred book by the side of the Old Covenant, which in its written embodiment we call the Old Testament, extends roughly over the 2nd century. By the last decades of that century a preliminary list of these new Sacred Books had been formed and placed by the side of the Old with substantially the same attributes. We must briefly sketch the process by which this came about, tracing the causes which led to the result and indicating the manner in which they operated.

We have seen that the ultimate cause was the consciousness on the part of the Church that the first age of its own history was characterized by spiritual workings more intense than other times. This feeling had been instinctive, and it found expression in several ways, each one of them partial, when taken alone, but obtaining their full effect in combination. It should be understood that the goal towards which events were moving all the time was the equalizing of the New Testament with the Old Testament.

(a) *Public Reading.*—From the first way in which the Epistles of Paul were brought to the knowledge of the churches to which they were addressed was by reading in the public assemblies for worship. This was done by the direction of the apostle himself (1 Thess. v. 27; Col. iv. 16). At first any writing that was felt to be useful for edification was read in this way, especially if it had local associations (cf. Dionysius of Corinth, *ap. Eus. H.E.* iv. 23. 11). But, as worship became more thoroughly organized, it was involved with increasing solemnity; the freedom of choice was gradually restricted; and inasmuch as lessons were regularly taken from the Old Testament, it was only natural that other lessons read alongside of them should gradually be placed upon the same footing.

(b) *Authority of Christ and the Apostles.*—As the words of prophets and lawyers had from the first carried their own authority with them under the Old Covenant, so from the first the words of Christ needed no commendation to them nor under the New. And what applied to words of Christ soon came also to apply in their degree to words of the apostles. The only difference was that an authority at first instinctively assumed came to be consciously recognized and formally defined. There was also a natural tendency towards leveling up the different parts of books and groups of books. In other words, the somewhat vague sense of spiritual power and impressiveness hardened into the conception of sacred books united in a sacred volume.

(c) *Controversy.*—The process was accelerated by the demand for a standard or rule of faith and practice. At an early date in the 2nd century this demand was met by the composition of the oldest form of what we call the Apostles' Creed. But the Creed was but the condensed essence of the New Testament scriptures, and behind it there lay an appeal to these scriptures, which was especially necessary where (as in the case of the Valentinian Gnostics) the dissident bodies professed to accept the common belief of Christians. It is its conflict with Gnostics, Marcionites and Montanists the Church was led to insist more and more upon its Bible, its own Bible, just as its older controversy with the Jews it had to insist on the Bible which it inherited from them. This was a yet further cause of the equating of the two parts of the sacred volume, which went on with an imperceptible *crescendo* through the first three quarters of the 2nd century, and by the last quarter was fairly complete.

(γ) *Provisional Canon of New Testament* (end of 2nd century).—By the last quarter of the 2nd century the conception of a Christian Bible in two parts, Old Testament and New Testament, may be said to be definitely established. Already at the beginning of this period Melito had drawn up a list of the twenty-two Books of the Old Covenant, *i.e.* of the documents to which the Old Covenant made its appeal. It was a very short step to the compiling of a similar list for the New Covenant, which by another very short step becomes the New Testament, by the side of the Old Testament. It is therefore not surprising, though a piece of great good fortune, that there should be still extant a list of the New Testament books that may be roughly dated from the end of the century. This list published by Muratori in 1740, and called after him "the Muratorian Fragment on the Canon," is commonly believed to be of Roman origin and to be a translation from the Greek, though there are a few dissentients on

both heads. The list recognized four Gospels, Acts, thirteen epistles of Paul, two epistles of John, Jude, Apocalypse of John and (as the text stands) of Peter; there is no mention of Hebrews or (apparently) of 3 John or Epistles of Peter, where it is possible—we cannot say more—that the silence as to 1 Peter is accidental; the *Shepherd* of Hermas on account of its date is admitted to private, but not public, reading; various writings associated with Marcion, Valentinus, Basilides and Montanus are condemned.

There are many interesting points about this list, which still shows considerable freshness of judgment. (i) There are traces of earlier discussions about the Gospels, both in disparagement of the Synoptics as compared with St. John, and in criticism of the latter as differing from the former. (ii) There is a healthy tendency to lay stress on the historical value of narratives which proceed from eye-witnesses. (iii) An over-ruling and uniting influence is ascribed to the Holy Spirit. (iv) The writer is concerned to point out that letters addressed to a single church and even to an individual may yet have a wider use for the Church as a whole. (v) The sense is not yet lost that the appeal of the Old Testament is as coming from men of prophetic gifts, and that of the New Testament as coming from apostles. (vi) It is in accordance with this that a time limit is placed upon the books included in the New Testament. (vii) Christians are to be on their guard against writings put forth in the interest of heretical sects.

When the data of *Fragm. Murat.* are compared with those supplied by the writers of the last quarter of the 2nd and first of the 3rd centuries (Tatian, *Theoph. Ant.*, *Iren.*, *Clem. Alex.*, *Tert.*, *Hippol.*), it is seen that there is a fixed nucleus of writings that is acknowledged, with one exception, over all parts of the Christian world. The exception is the Syriac-speaking Church of Edessa and Mesopotamia. This Church at first acknowledged only the Gospel (in the form of Tatian's *Diataxaron*), Acts and the Epistles of Paul. These seem to have been the only books translated immediately upon the foundation of the Edessan Church, though an edition of the separate Gospels must have followed either before or very soon afterwards. In all other churches the four Gospels, Acts and Epistles of Paul are fixed, with the addition in nearly all of 1 Peter, 1 John. The Apocalypse was generally accepted in the West. Hebrews and James were largely accepted in the East.

In the 3rd century the conspicuous figure is Origen (*ob. 253*), whose principal service was, through the vast range of his knowledge, his travels and his respect for tradition wherever he found it, to keep open the wider limits of the Canon. There is not one of our present books that he does not show himself inclined to accept, though he notes the doubts in regard to 2 Peter and 2 and 3 John. Later in the century Dionysius of Alexandria applies some acute criticism to justify the Alexandrian dislike of the Apocalypse.

(δ) *The Final Canon* (4th century).—Early in the 4th century Eusebius, as a historian reviews the situation (*H.E.* iii. 25. 1). He makes three classes; the first, including the Gospels, Acts, Epistles of Paul, 1 Peter, 1 John, is acknowledged; to these, if one likes, one may add the Apocalypse. The second class is questioned, but accepted by the majority; viz. James, Jude, 2 Peter, 2 and 3 John. The third class, of works to be decidedly rejected, contains the Acts of Paul, Hermas, Apocalypse of Peter, Barnabas, *Didaché*; to these some would add Apoc. of John, and others *Ev. sec. Hebr.* About the same time another line of tradition is represented by Lucian and the school of Antioch. The vernacular Church of Syria represented yet a third. In Egypt the uncertainty and laxity of usage was still greater. This state of things the great Athanasius set himself to correct, and he did so by laying down a list identical with our New Testament as we have it now. It was very largely the influence of Athanasius that finally turned the scale. He was peculiarly qualified for exercising this influence, as his long exile in the West made him familiar with Western usage, while he was also able to bring to the West the usage that he was trying to establish in the East. His efforts would be helped by Westerns, like Hilary and Lucifer, who were exiled to the East. The triumph of the Athanasian Canon, indeed, went along with the triumph of Nicene Christianity. And while the movement

received its impulse from Athanasius, the power by which it was carried through and established was largely that of his powerful ally, the Church of Rome.

The final victory was no doubt a little delayed. Asia Minor and Syria were for most of the 4th century in doubt between the following of Eusebius (Cyril of Jerusalem in A.D. 348, Gregory of Nazianzus, the list of *Act. Can.* 85, that attached to *Can.* 50 of the Council of Laodicea, c. A.D. 363) and the school of Antioch. The leading members of that school adopted 3 Epp. Cath. (James, 1 Peter, 1 John), Theod. Mops. omitting this group altogether, and the whole school omitting Apoc. Amphilocheus of Iconium (c. 380) gives the two lists, Eusebian and Antiochene, as alternatives. The Eusebian list only wanted the complete admission of the Apocalypse to be identical with the Athanasian; and Athanasius had one stalwart supporter in Epiphanius (*ob.* 403).

The original Syria list, as we have seen, had neither Epp. Cath. nor Apoc. The Peshito version, in regard to which Professor Burkitt's view is now pretty generally accepted, that it was the work of Rabballa, bishop of Edessa, 411-433, added the 3 Epp. Cath. The remaining 4 Epp. Cath. and Apoc. were supplied in the Philoxenian version of 508, and retained in the Harklean revision of 616. But both these were Monophysite and of limited use, and the Nestorians still went on using the Peshito.

Meantime, in the West, an important Synod was held by Damasus at Rome in 382 which, under the dominant influence of Jerome and the Athanasian tradition, drew up a list corresponding to the present Canon. This was ratified by Pope Gelasius (402-406), and independently confirmed for the province of Africa by a series of Synods held at Hippo Regius in 393, and at Carthage in 397 and 419, under the lead of Augustine. The formal completion of the whole process in East and West was reserved for the Quinisextine Council (Council in Trullo) of 602. But even after that date irregularities occur from time to time, especially in the East.

In the fixing of the Canon, as in the fixing of doctrine, the decisive influence proceeded from the bishops and the theologians of the period 325-450. But behind these was the practice of the greater churches; and behind that again was not only the lead of a few distinguished individuals, but the instinctive judgment of the main body of the faithful. It was really this instinct that told in the end more than any process of quasi-scientific criticism. And it was well that it should be so, because the methods of criticism are apt to be, and certainly would have been when the Canon was formed, both faulty and inadequate, whereas instinct brings into play the religious sense as a whole; with spirit speaking to spirit rests the last word. Even this is not infallible; and it cannot be claimed that the Canon of the Christian Sacred Books is infallible. But experience has shown that the mistakes, so far as there have been mistakes; are unimportant; and in practice even these are rectified by the natural gravitation of the mind of man to that which it finds most nourishing and most elevating.

BIBLIOGRAPHY.—The separate articles on the various books of the New Testament may be consulted for detailed bibliographies. The object of the above sketch has been to embrace in constructive outline the ground usually covered analytically and on a far larger scale by Introductions to the New Testament, and by Histories of the New Testament Canon. In English there is a standard work of the latter class in Westcott's *General Survey of the History of the Canon of the New Testament* (first published in 1855, important revision and additions in 2nd ed. 1874, 7th ed. 1896), with valuable appendix of documents at the end. There was also a useful collection of texts by Prof. Charteris of Edinburgh, *Canonicity* (1880), based on Kirchofer, *Quellensammlung* (1844), but with improvements. The leading documents are to be had in the handy and reliable *Kleine Texte* (ed. Lietzmann, from 1902). On Introduction the latest older English work was Salmon, *Historical Introduction to the Study of N.T.* (1st ed. 1885, 5th ed. 1891); but,

although still possessing value as argument, this has been more distinctly left behind by the progress of recent years. England has made many weighty contributions both to Introduction and Canon, especially Lightfoot, *Essays on Supernatural Religion* (collected in 1899); editions of Books of the New Testament and Apostolic Fathers; Westcott, editions; Hort, especially *Romans and Ephesians* (posthumous, 1895); Swete, editions; Knowling and others. The Oxford Society of Historical Theology put out a useful *New Testament in the Apostolic Fathers* in 1905, and Prof. Stanton of Cambridge, *The Gospels as Historical Documents* (part i. in 1902). Prof. Burkitt's *Gospel History and its Transmission* appeared in 1906. For introductory matter the student will do well to consult the *Dictionary of the Bible* (ed. Hastings, 5 vols., 1898-1904) and *Encyclopædia Biblica* (ed. Cheyne and Black, 4 vols., 1899-1903). Dr Hastings and his contributors belong more to the right wing of criticism, and Dr Cheyne and his to the left. The systematic Introduction is a characteristic production of Germany and has done excellent service in its day, though there are signs that the analytic method hitherto mainly practised is beginning to give place to something more synthetic or constructive. The pioneer work in this latter direction is Weizsäcker's skilful and artistic *Apostolisches Zeitalter* (1st ed. 1886, 3rd ed. 1901; Eng. trans. 1894-1895); somewhat similar on a smaller scale is von Soden, *History of Early Christian Literature* (trans., 1906). Special mention should be made of Wellhausen on the Synoptic Gospels (1903-1905), and Harnack, *Beiträge z. Einleitung in d. N.T.* (part i. 1906, part ii. 1907). The most important recent works on Introduction and Canon have been those of H. J. Holtzmann (1st ed. 1885, 3rd ed. 1902); B. Weiss (1st ed. 1886, 3rd ed. 1897); a series of works by Th. Zahn, almost colossal in scale and exhaustive in detail, embracing *Gesch. d. neut. Kanons* (2 vols., 1888-1892, third to follow), *Forschungen z. Gesch. d. neut. Kan.* (7 parts, 1881-1907), *Einleitung* (2 vols., 1897-1899), *Grundriss d. Gesch. d. neut. Kan.* (1st ed. 1901, 2nd ed. 1904); A. Jülicher, *Einleitung* (1st and 2nd ed. 1894, 5th and 6th ed. 1906; Eng. trans. by Miss Janet Ward, 1904). Zahn and Jülicher may be said to supplement and correct each other, as they write from very different points of view, and on Jülicher's side there is no lack of criticism of his great opponent. Zahn's side is monumental in its way, and his *Grundriss* is very handy and full of closely packed and (in statements of facts) trustworthy matter. Jülicher's work is also highly practical, very complete and well proportioned in scale, and up to a certain point its matter is also excellent. The *History of the Canon*, by the Egyptologist Joh. Leipoldt (Leipzig, 1907), may also be warmly recommended; it is clear and methodical, and does not make the common mistake of assigning too much to secondary causes; the author does not forget that he is dealing with a sacred book, and that he has to show why it was held sacred. (W. SA.)

2. Texts and Versions.

The apparatus criticus of the New Testament consists, from one point of view, entirely of MSS.; but these MSS. may be divided into three groups: (A) Greek MSS., which in practice are known as "The MSS.," (B) MSS. of versions in other languages representing translations from the Greek, (C) MSS. of other writings whether in Greek or other languages which contain quotations from the New Testament.

(A) *Greek MSS.*—These may be divided into classes according to style of writing, material, or contents. The first method distinguishes between uncial or majuscule, and cursive or minuscule; the second between papyrus, vellum or parchment, and paper (for further details see MANUSCRIPT and PALAEOGRAPHY); and the third distinguishes mainly between Gospels, Acts and Epistles (with or without the Apocalypse), New Testaments (the word in this connexion being somewhat broadly interpreted), lectionaries and commentaries.

Quite accurate statistics on this subject are scarcely attainable. Von Soden's analysis of numbers, contents and date may be tabulated as follows, but it must be remembered that it reckons many small fragments as separate MSS., especially in the earlier centuries. It is also necessary to add that there is one small scrap of papyrus of the 3rd century containing a few verses of the 4th Gospel.

Century	IV.	V.	VI.	VII.	VIII.	IX.	X.	XI.	XII.	XIII.	XIV.	XV.	XVII.	Total.
New Testaments	2	2	1	..	1	2	2	16	24	44	47	19	7	167
Gospels	3	10	26	10	19	26	82	188	282	260	218	107	46	1277
Acts and Epistles, Acts and Catholic Epp.	1	1	..	1	..	4	19	55	49	56	56	31	8	278
Pauline Epp.	1	4	2	..	3	2	5	25
Apocalypse	..	4	7	1	..	5	4	..	1	..	4	3	3	32
	1	2	3	5	5	5	21	6	43

13. ΥΜΙΝ ΔΕ ΙΚΝΥΜΕΘΑΝΤΙ-
 ΓΛΩΣΣΑΙΣ ΤΩΝ ΑΝΘΡΩ-
 ΠΩΝ ΛΑΛΩ ΚΑΙ ΤΩΝ ΑΓΓ-
 ΛΩΝ ΑΓΑΠΗΝ ΔΕ ΜΗ ΕΧΩ-
 ΓΕ ΤΟΝ ΑΧΑΛΚΟΣ Η ΧΩΗ
 ΗΚΥΜΒΑΔΟΝ ΑΔΑΛΑΖΟΝ
 ΚΑΙ ΕΑΝ ΕΧΩ ΠΡΟΦΗΤΗ
 ΑΝΚΑΙ ΕΙΔΩΤΑ ΜΥΣΤΗ-
 ΡΙΑ ΠΑΝΤΑ ΚΑΙ ΠΡΑΞΑΝΤΗ
 Η ΨΟΙΝ ΚΑΝ ΕΧΩ ΠΑΡΑ-
 ΤΗΝ ΠΙΣΤΙΝ ΩΣΤΕ ΟΡΗ
 ΜΕΘΙΣΤΑΝΑΙ ΑΓΑΠΗΝ
 ΔΕ ΜΗ ΕΧΩ ΟΥΘΕΝ ΕΤΙΜΙ-
 ΚΑΝ ΨΩΜΙΣ ΠΑΝΤΑ
 ΨΑΡΧΟΝΤΑ ΜΟΥ ΚΑΙ ΑΝ
 ΠΑΡΑΔΩΤΟΣ ΩΜΑΜΟΥ

FIG. 1.—Codex Vaticanus. (From facsimile ed. by J. Cozza-Luzi, 1889-1890.)

ΕΥΝΟΥΧΩΝ ΚΑΙ
 ΟΥΘΕΝ ΟΜΟΥΧΑΙ-
 ΕΤΕΡΟΤΟΜΕΒΑΣΙΛΕ
 ΑΚΝ ΤΟΥΣ ΑΡΧΟΝ
 ΓΑΡ ΟΥΤΟΝ ΒΑΣΙΛΕ
 ΑΜΟΝΟΝ ΗΔΙΚΗ-
 ΑΣΤΙΝ Η ΒΑΣΙΛΙΣΣΑ
 ΑΛΛΑ ΚΑΙ ΠΑΝΤΑ
 ΤΟΥΣ ΑΡΧΟΝΤΑΣ ΚΝ
 ΤΟΥΣ ΗΓΟΥΜΕΝΟΥ
 ΤΟΥ ΒΑΣΙΛΕΩΣ ΚΑΙ
 ΕΤΕΡΑΙ ΗΣ ΑΙ ΤΟΥ
 ΤΟΙΣΤΑΡΗΜΑΤΑ ΤΗ-
 ΒΑΣΙΛΕΩΣ ΚΑΙ Ω

FIG. 2.—Codex Sinaiticus. (From facsimile published by Palaeographical Soc., 1873.)

ΑΠΟΣΤΟΛΟΓ ΜΗ ΠΑΝΤΕ ΟΡΗ
 ΜΗ ΠΑΡΤΕΟΧΙΧΑΚΑΛΟΙ
 ΜΗ ΠΑΡΤΕΟΧΥΝΑΜΣΙΟ ΜΗ ΠΑ
 ΓΕΟΧΑΡΙΟΜΧΙΧΕΧΟΥΣΙΝ ΑΜΑΙ
 ΜΗ ΠΑΝΤΕΟΡΜΟΝΟΧΑΛΟΥΣΙ
 ΜΗ ΠΑΝΤΕΟΚΙΡΜΗΝΕΟΥΣΙΝ
 ΖΗΛΟΥ ΙΧΙΧΑΡΙΟΜΧΙΧΑΙΟΙ
 ΖΟΝΑ ΚΑΙ ΕΤΙΧΑΟΥΣΙΝ ΕΡΒΟΧΙΝ
 ΟΧΟΥΜΗΝΑΙ ΝΥΜΙ
 13. ΣΑΝΤΙ ΧΙΣΤΑΩΣ ΧΙΣΤΩΝ ΑΝΘΡΩ-
 ΠΩΝ ΚΑΙ ΤΩΝ ΑΓΓΕΛΩΝ ΑΓΑΠΗ-
 ΔΕ ΜΗ ΕΧΩ ΗΓΕΟΝ ΑΧΑΛΚΟΣ Η ΧΩ-
 ΗΚΥΜΒΑΔΟΝ ΑΔΑΛΑΖΟΝ
 ΚΑΝ ΕΧΩ ΠΡΟΦΗΤΗ ΙΧΝΚΑΙ ΧΑ-
 ΡΑΜΥΣΤΗΡΙΑ ΠΑΝΤΑ ΚΑΙ ΠΡΑΞΑΝΤΗ
 Η ΨΟΙΝ ΚΑΝ ΕΧΩ ΠΑΡΑ ΤΗΝ ΠΙ-
 ΣΤΙΝ ΩΣΤΕ ΟΡΗ ΜΕΘΙΣΤΑΝΑΙ ΑΓΑ-
 ΠΗΝ ΔΕ ΜΗ ΕΧΩ ΟΥΘΕΝ ΕΤΙΜΙ-
 ΚΑΙ ΨΩΜΙΣ ΠΑΝΤΑ
 ΨΑΡΧΟΝΤΑ ΜΟΥ ΚΑΙ ΑΝ ΠΑΡΑ-
 ΔΩΤΟΣ ΩΜΑΜΟΥ ΙΝΑΙ ΟΥΧΙ ΨΩΜΙ-
 ΝΑΤΗΝ ΗΔΕ ΜΗ ΕΧΩ ΟΥΘΕΝ ΕΤΙΜΙ

FIG. 3.—Codex Alexandrinus. (British Museum.)

ERANT UT EUOUCIANT IN CRO
 V PRACHENDENS Q. ABHAPALLICIS
 SUO VNOUEN QUO COOPERIUS
 ERAT SCIDI IN DUODECIM PARTES
 ET AT VHEROBOLD TOLLE TIBI
 DECEM SERRAS
 HACC ENI DICIT DNS OS ISRAEL
 ECCE ECO SCINDAM REC NUDS
 DE MANUSA LOMONS
 ET DABO TIBI DECEM VIBUS
 PORRO UNX TRIB RE MANEBIT

FIG. 4.—From a probable Northumbrian Copy of the Codex Amiatinus. (British Museum.)

תנה חטאתם ליתוח
 ודע חטאתכם אשר
 תמצאו אתכם בנר
 לכם ערש שלטפכם
 וידתלנאכם

FIG. 5.—Pentateuch in Hebrew, 9th Century. (British Museum.)

interpretantur. xviii
 muslimum autem carismata meli-
 ora: & adhuc excellentiorem vitam vobis
 demonstro. Si linguis hominum loquar
 & angeloy caritatem au non habeam:
 factus sum velut es sonans aut cymba-
 lum tinniens. Et si habuero prophetiam
 & nouerim omnia mysteria & omnem

FIG. 6.—Vulgate. (From M.S. written for the monastery of Ste Marie de Parco, Louvain, A.D. 1148. British Museum.)

This table says nothing about style of writing or material, but it may be taken as a general rule that MSS. earlier than the 13th century are on vellum and later than the 14th century are on paper, and that MSS. earlier than the 9th century are uncial and later than the 10th are minuscule. There are said to be 129 uncials MSS. of the New Testament (Kenyon, *Textual Criticism of the New Testament*, p. 45), but it is not easy to be quite accurate on the point.

Besides the MSS. mentioned in the table above, there are 281 MSS. containing commentaries on the Gospels, 169 on Acts and Epistles, 66 on the Apocalypse, 1072 lectionaries of the Gospels and 287 of Acts and Epistles, making a grand total of 3608 MSS. It must be remembered that the dating of the MSS., especially of minuscules, is by no means certain: Greek Palaeography is a difficult subject, and not all the MSS. have been investigated by competent palaeographers.

The notation of this mass of MSS. is very complicated. There are at present two main systems: (1) Since the time of Wetstein it has been customary to employ capital letters, at first of the Latin and latterly also of the Greek and Hebrew alphabets, to designate the uncials, and Arabic figures to designate the minuscules. Of this system there are two chief representatives, Gregory and Scrivener. These agree in the main, but differ for the more recently discovered minuscules. Gregory's notation is more generally used, and Scrivener's, though still followed by a few English scholars, is likely to become obsolete. This method of notation has various disadvantages. There are not enough letters to cover the uncials, the same letter has to serve for various fragments which are quite unconnected except by the accident of simultaneous discovery, and no information is given about the MS. referred to. (2) To remedy these drawbacks an entirely new system was introduced in 1902 by von Soden in his *Die Schriften des neuen Testaments*, Bd. 1, Abt. 1, pp. 33-40. He abandons the practice of making a distinction between uncial and minuscule, on the ground that for textual criticism the style of writing is less important than the date and contents of a MS. To indicate these he divided MSS. into three classes. (1) New Testaments (the Apocalypse being not regarded as a necessary part), (2) Gospels, and (3) Acts, Epistles and Apocalypse (the latter again being loosely regarded). These three classes he distinguished as δ (= δ - α β γ δ ϵ ζ η θ ι κ λ μ ν ξ \omicron π ρ σ τ υφ χ ψ ω), ϵ (= ϵ - ν α γ γ ϵ λιου) and α (= α - α πόστολος). To these letters he attaches numbers arranged on a principle showing the century to which the MS. belongs and defining its contents more precisely. The number is determined thus:—MSS. of the δ and α classes from the earliest period to the 9th century inclusive are numbered 1 to 49; those of the 10th century 50 to 99; for the later centuries numbers of three figures are used, and the choice is made so that the figure in the hundreds' place indicates the century, 1 meaning 11th century, 2 meaning 12th century, and so on; to all these numbers the appropriate letter, if it be δ or α , must be always prefixed, but if it be ϵ , only when there is any chance of ambiguity. In δ MSS. a distinction is made for those of the 11th and subsequent centuries by reserving 1 to 49 in each hundred for MSS. containing the Apocalypse, 50 to 99 for those which omit it. Similarly, in a MSS. a distinction is made according to their contents; the three-figure numbers are reserved for MSS. which contain Acts, Catholic Epistles and Pauline Epistles with or without the Apocalypse, the presence or absence of which is indicated as in the δ MSS.; but when a MS. consists of only one part a "1" is prefixed, thus making a four-figure number, and the precise part is indicated by the two last of the four figures; 00-10 means Acts and Catholic Epistles, 20-60 means Pauline Epistles and 70-99 means Apocalypse. In the case of ϵ MSS. 1-09 is used for the earliest MSS. up to the 9th century, and as this is insufficient, the available numbers are increased by prefixing a 0, and reckoning a second hundred from 01 to 099; 100 to 1099 are MSS. of the 10th century; 100 to 109 are MSS. of the 11th century, 200-299 of the 12th century, and so on; as this is insufficient, the range of numbers is increased by prefixing a 1, and so obtaining another hundred, e.g. 1100 to 1199, and in the 12th and subsequent centuries, where even this is not enough,

by passing on to the thousands and using 2000-2999 for the 12th century, 3000-3999 for the 13th and so on. In each case ϵ is prefixed whenever there is any chance of ambiguity. It is claimed that this system gives the maximum of information about a MS., and that it leaves room for the addition of any number of MSS. which are likely to be discovered. At present it has not seriously threatened the hold of Gregory's notation on the critical world, but it will probably have to be adopted, at least to a large extent, when von Soden's text is published.

[The full details of this subject can be found in E. Miller's edition of Scrivener's *Introduction to the Criticism of the New Testament* (George Bell, 1894); C. R. Gregory's *Prolegomena to Tischendorf's Novum Testamentum Graece*, Ed. VIII. critica major (Leipzig, 1894); C. R. Gregory's *Textkritik* (Leipzig, 1900); H. von Soden's *Die Schriften des neuen Testaments* (Berlin, Band i., 1902-1907); F. G. Kenyon's *Handbook to the Textual Criticism of the New Testament* (London, 1901), especially valuable for a clear account of the Papyri fragments.]

It is neither possible nor desirable to give any description of most of these MSS., but the following are, critically, the most important.

UNCIALS.—*Codex Vaticanus* (Vat. Gr. 1209), Greg. B, v. Soden δ 1; an uncial MS. of the 4th century. It is written in three columns and has forty-two lines to the column. It originally contained the whole Bible, but in the New Testament *Codex Vaticanus*. Heb. ix. 14, xiii. 25, 1 and 2 Tim., Tit., Philemon, Apoc., are now missing. It was written by three scribes of whom the writer of the New Testament was identified by Tischendorf as the scribe D of a *cod. Sinaiticus*. The text has been corrected by two scribes, one (the δ ω β α ρ τ α ν) contemporary with the original writer, the other belonging to the 10th or 11th century. The latter probably also re-linked the whole of the MS. and introduced a few changes in the text, though some critics think that this was done by a monk of the 15th century who supplied the text of the lacuna in Heb. and of the Apocalypse from a MS. belonging to Bessarion. The text is the best example of the so-called Neutral Text, except in the Pauline epistles, where it has a strong "Western" element. How this MS. came to be in the Vatican is not known. It first appears in the catalogue of 1481 (Bibl. Vat. MS. Lat. 3952 f. 50), and is not in the catalogue of 1475, as is often erroneously stated on the authority of Vercellone. It was, therefore, probably acquired between the years 1475 and 1481. The problem of its earlier history is so entangled with the similar questions raised by κ that the two cannot well be discussed separately. [Phototypic editions have been issued in Rome in 1889-1890 and in 1905.]

Codex Sinaiticus (St Petersburg, Imperial library), Greg. κ , von Soden δ 2; an uncial MS. of the 4th century. It was found in 1844 by C. Tischendorf (p.p.) in the monastery of St Catherine on Mt. Sinai, and finally acquired by the *Sinaiticus*. It is written on thin vellum in four columns of forty-eight lines each to a page. It contained originally the whole Bible, and the New Testament is still complete. At the end it also contains the Ep. of Barnabas and the *Shepherd of Hermas*, unfortunately incomplete, and there was probably originally some other document between these two. The text was written, according to Tischendorf, by four scribes, of whom he identified one as also the scribe of *cod. Vaticanus*. It was corrected many times, especially in the 6th century, by a scribe known as κ^2 and in the 7th by κ^3 . It has, in the main, a Neutral text, less mixed in the Epistles than that of B, but not so pure in the Gospels. The corrections of κ^2 are important, as they are based (according to a note by that scribe, at the end of Esther) on an early copy which had been corrected by Pamphilus, the disciple of Origen, friend of Eusebius and founder of a library at Caesarea.

[The text of κ was published in Tischendorf's *Bibliorum codex Sinaiticus Petropolitanus* (vol. iv., 1862), and separately in his *Novum Testamentum Sinaiticum* (1863); in 1909 it was published in collotype by the Clarendon Press, Oxford. The relations of κ^2 to Pamphilus are studied by Bousset in "Textkritische Studien zum N.T.," in *Texte u. Untersuchungen*, xi. 4.]

It is Tischendorf's right in identifying the scribe of B with that of part of κ , it is obvious that these MSS. probably come from the same place. He was probably wrong, but there are some indications of relationship to justify the same view. The two most probable places seem to be Caesarea and Alexandria. The case for Caesarea is that the colophon written by κ^2 at the end of Esther, and also of Ezra, shows that κ was then in the library of Caesarea, and that a chapter division in Acts found both in κ and B can also be traced to the same library. This is a fairly strong case, but it falls short of demonstration because it cannot be shown that the MS. corrected by Pamphilus was still at Caesarea when it was used by κ , and because it is not certain either that the chapter divisions in Acts were added by the original scribes, or that κ and B were at that time in their original home, or that the chapter divisions were necessarily only to be found at Caesarea. The case for Alexandria depends partly on the orthography of B, which resembles

Græco-Coptic papyri, partly on the order of the Pauline epistles. At present, both in * and B, Hebrews is placed after 2 Thess., but in B there is also a continuous numeration of sections throughout the epistles, according to which 1 to 58 cover Romans to Galatians, but Ephesians, the next epistle, begins with 70 instead of 59, and the omitted section numbers are found in Hebrews. Obviously, the archetype placed Hebrews between Galatians and Ephesians, but the scribe altered the order and put it between 2 Thess. and 1 Tim., though without changing the section numbers. This order of the epistles is only found elsewhere in the Sahidic version of the New Testament, and it was probably therefore the old Egyptian or Alexandrian order. Moreover, we know from the Festal letter of A.D. 367 (according to the Greek and Syriac texts, but not the Sahidic), that Athanasius then introduced the order of the epistles which is now given in * B. This is strong evidence for the view that the archetype of B came from Alexandria or the neighbourhood, and was older than the time of Athanasius, but it scarcely proves that B itself is Alexandrian, for the order of epistles which it gives is also that adopted by the council of Laodicea in A.D. 363, and may have been introduced elsewhere, perhaps in Caesarea. A further argument, sometimes based upon and sometimes in turn used to support the foregoing, is that the text of * B represents that of Hesychius; but this is extremely doubtful (see the section *Textual Criticism* below).

[The question of the provenance of * and B may best be studied in J. Rendel Harris, *Stichometry* (Cambridge, 1893), pp. 71-89; J. Armitage Robinson, "Euthaliana," *Texts and Studies*, iii. 3 (Cambridge, 1895), esp. pp. 34-43 (these more especially for the connection with the *Antiphona* of A. Heimgartner, *Heimat der vatikanischen Bibelhandschrift in den Nachrichten der Gesellschaft der Wiss. zu Göttingen* (1899), vol. i. pp. 72-79; and O. von Gebhardt in a review of the last named in the *Theologische Literaturzeitung* (1899), col. 556.]

Codex Bezae (Cambridge Univ. Nu. 2, 41), Greg. D, von Soden δ 5; an uncial Græco-Latin MS. not later than the 6th century and probably considerably earlier. The text is written in one

column to a page, the Greek on the left hand page and the Latin on the right. It was given to the university of Cambridge in 1581, but its early history is doubtful. Beza stated that it came from Lyons and had been always preserved in the monastery of St. Irenæus there. There is no reason to question Beza's bona fides, or that the MS. was obtained by him after the sack of Lyons in 1562 by des Adrets, but there is room for doubt as to the accuracy of his belief that it had been for a long time in the same monastery. His information on this point would necessarily be derived from Protestant sources, which would not be of the highest value, and there are two pieces of evidence which show that just previously the MS. was in Italy. In the first place it is certainly identical with the MS. called *p* which is quoted in the margin of the 1550 edition of the *Antiphona* by Robert Greuter. A study of the preface of Stephanus' preface was collated for him by friends in Italy. In the second place it was probably used at the council of Trent in 1546 by Gul. a Prato, bishop of Clermont in Auvergne, and in the last edition of the *Annotations* Beza quotes his MS. as *Claramontanus*, and not as *Lugdunensis*. These points suggest that the MS. had only been a short time at Lyons when Beza obtained it. The still earlier history of the MS. is equally doubtful. H. Quentin has produced some interesting but not convincing evidence to show that the MS. was used in Lyons in the 12th century, and Rendel Harris at one time thought that there were traces of Gallicism in the Latin, but the latter's more recent researches go to show that the corrections and annotations varying in date between the 7th and 12th centuries point to a district which was at first predominantly Greek and afterwards became Latin. This would suit South Italy, but not Lyons. The text of this MS. is important as the oldest and best witness in a Greek MS. to the so-called "Western" text. (See the section *Textual Criticism* below.)

[The following books and articles are important for the history, as apart from the text of the MS. *Codex Bezae* . . . *phototypic representations* (Cambridge, 1899); Scrivener, *Codex Bezae*, (Cambridge, 1864); Rendel Harris, "A Study of *Codex Bezae*," *Texts and Studies*, i. 1 (Cambridge, 1891); J. Rendel Harris, *The Annotations of Cod. Bezae* (London, 1901); F. E. Brightman and K. Lake, "The Italian Origin of *Codex Bezae*," in *Journal of Theol. Studies*, April 1900, pp. 441 ff.; F. C. Burkitt, "The Date of *Codex Bezae*," in the *Journal of Theol. Studies*, July 1902, pp. 501 ff.; D. H. Quentin, "Le Codex Bezae à Lyon, &c.," *Revue Bénédictine*, xxxiii. 1, 1906.]

Codex Alexandrinus (G. M. reg. ID v.-viii.), Greg. A, von Soden α 4; an uncial MS. of the 5th century. It was given by Cyril Lucar, patriarch of Constantinople to Charles I. in 1621. It appears probable that Cyril Lucar had brought it with him from Alexandria, of which he had formerly been patriarch. A note by Cyril Lucar states that it was written by Thecla, a noble lady of Egypt, but this is probably merely his interpretation of an Arabic note of the 14th century which states that the MS. was written by Thecla, the martyr, an obviously absurd legend; another Arabic note by Athanasius (probably Athanasius III., patriarch c. 1208) states that it was given to the patriarchate of Alexandria, and a Latin note of a later period dates the presenta-

tion in 1098. So far back as it can be traced it is, therefore, an Alexandrian MS., and palaeographical arguments point in the same direction. Originally, the MS. contained the whole of the Old and New Testaments, including the Psalms of Solomon in the former and 1 and 2 Clement in the latter. It has, however, suffered mutilation in a few places. Its text in the Old Testament is thought by some scholars to show signs of representing the Hesyrian recension, but this view seems latterly to have lost favour with students of the Septuagint. If it be true, it falls in with the palaeographic indications and suggests an Alexandrian provenance. In the New Testament it has in the gospels a late text of Westcott and Hort's "Syrian" type, but in the epistles there is a strongly marked "Alexandrian" element. [Cod. A was published in photographic facsimile in 1879-1880.]

Codex Ephraemi Syri Rescriptus (Paris Nat. Gr. 9), Greg. C, von Soden ϵ 3; an uncial palimpsest (the top writing being that of Ephraem) of the 5th century. It was formerly the property of Catherine de' Medici, and was probably brought from the east to Italy in the 16th century. Hort (*Introductio*, p. 268) has shown from a consideration of displacements in the text of the Apocalypse that it was copied from a very small MS., but this, of course, only holds good of the Apocalypse. It is usually said that this MS., like A, came originally from Egypt, but this is merely a palaeographical guess, for which there is no real evidence. Originally, it contained the whole Bible, but only sixty-four leaves of the Old Testament remain, and 145 (giving about two-thirds of the whole) of the New Testament. The character of the text is mixed with a strong "Alexandrian" element. [Published in facsimile by Tischendorf (1843). Discussed by Lagarde in his *Ges. Abhandlungen*, p. 94.]

Codex Claramontanus (Paris Nat. Gr. 107), Greg. D^{msl}, von Soden α 1026; an uncial Græco-Latin MS. of the 6th century. This MS. also belonged to Beza, who "acquired" it from the monastery of Clermont, near Beauvais. After his death it passed through various private hands and was finally bought for the French royal library before 1656. It contains the whole of the Pauline epistles with a few lacunae, and has a famous stichometric list of books prefixed in another hand to Hebrews. It is probably the best extant witness to the type of Greek text which was current in Italy as early as the 5th century. It is closely connected with *cod. Sangermanensis* (a direct copy) at St. Petersburg. Greg. E^{msl}, von Soden α 1027; *cod. Augienses* (Cambridge, Trin. Coll. xvii. 1), Greg. F^{msl}, von Soden α 1029; and *cod. Boernerianus* (Dresden, K. Bibl.), Greg. G^{msl}, von Soden α 1028. [The text is published in Tischendorf's *Codex Claramontanus*, 1857. Its relations to EFG are best discussed in Westcott and Hort's *Introduction*, §§ 335-337.]

There are no other uncials equal in importance to the above. The next most valuable are probably *cod. Regius* of the 8th century at Paris, Greg. L, von Soden α 86, containing the Gospels; *cod. Laudianus* of the 9th century at Oxford, Greg. M, von Soden α 1001, a Latino-Greek MS. containing the Acts; *cod. Constantianus* of the 6th century in Paris, Turin, Kiev, Moscow and Mt. Athos, Greg. H^{msl}, von Soden α 1022, containing fragments of the Pauline epistles; and *cod. Augiensis* of the 9th century in Trinity College, Cambridge, Greg. F^{msl}, von Soden α 1029, a Græco-Latin MS. closely related to *cod. Claramontanus*. [Further details as to these MSS. with bibliographies can be found in Gregory's *Prolegomena* to Tischendorf's *N.T. ed. maj.*, viii.]

Most uncials have very few ϕ 's; these are of real importance. The most valuable are the following:

1. *The Ferrar Group*: a group of eight MSS. known in Gregory's notation as 13, 69, 124, 346, 543, 788, 826, 828, or in von Soden's as α 368, δ 505, ϵ 1211, ϵ 226, ϵ 257, ϵ 1033, ϵ 218, ϵ 219, all which, except 69, in spite of the dating implied by von Soden's notation were probably written in the 12th century in Calabria. They have a most peculiar text of a mainly "Western" type, with some special affinities to the Old Syriac and perhaps to the Diatessaron. They are known as the Ferrar group in memory of the scholar who first published their text, and are sometimes quoted as ϕ (which, however, properly is the symbol for *Codex Bezae* of the Gospels), and sometimes as *fam.*¹

2. *Cod. 1 and its Allies*: a group of four MSS. known in Gregory's notation as 1, 118, 131, 209, and in von Soden's as δ 59, α 346, δ 467 and δ 457. The dating implied by the latter notation is wrong, as 1 certainly belongs to the 12th, not to the 10th century, and 118 is probably later than 209. It is sometimes quoted as *fam.*¹ *Fam.*¹ and *fam.*¹ probably have a common archetype in Mark which is also represented by *cod.* 28 (ϵ 168), 565 (ϵ 93), quoted by Tischendorf and others as 2^{msl} and 700 (ϵ 133), quoted by Scrivener and others as 60. Most uncials have many points of agreement with which the Old Syriac, but it is impossible to identify the locality to which it belonged. Other minuscules of importance are *cod.* 33 (δ 8) at Paris, which often agrees with * B1 and is the best minuscule representative of the "Neutral" and "Alexandrian" types of text in the gospels; *cod.* 137 (α 364) at Milan, a valuable "Western" text of the Acts; α 78 (not in Gregory) in the Laura on Mt. Athos, a MS. of the Acts and epistles, with an early (mixed) type of text and textual comments and notes from Origen.

[The text of the Ferrar group was published after Ferrar's death

by T. K. Abbott, *A Collation of Four Important MSS. of the Gospels* (Dublin, 1877). It is best discussed by Rendel Harris's books, *The Origin of the Leicester Codex* (1887), *The Origin of the Ferrar Group* (1893), and *The Ferrar Group* (1900), all published at Cambridge; the text of *fam.*¹ with a discussion of its textual relations is given in K. Lake's "Codex I and its Allies" (*Texts and Studies*, vii, 3, 1902); 505 was edited by J. Belsham in *Das Evangelium des Marcus nach d. griech. Cod. Theodorici, Sc.* (Christiana, 1885), many quotations to which are published in the appendix to H. S. Cronin's "Codex Purpurus," *Texts and Studies*, v, 4; 700 was published by H. C. Hoskier in his collation of cod. Evan. 604, London, 1890; *g* 78 is edited by E. von der Goltz in *Texte und Untersuchungen*, N.F. ii, 4.]

(B) *The Versions*.—These are generally divided into (a) primary and (β) secondary; the former being those which represent translation made at an early period directly from Greek originals, and the latter being those which were made either from other versions or from late and unimportant Greek texts.

(a) *The primary versions are three*—Latin, Syriac and Egyptian. *Latin Versions*.—1. The Old Latin. According to Jerome's letter to Pope Damasus in A.D. 384, there was in the 4th century *Old Latin*, a great variety of text in the Latin version, "Tot enim exemplaria pene quot codices." This verdict is confirmed by examination of the MSS, which have pre-Hieronymian texts. It is customary to quote these by simple letters of the Latin alphabet, but there is a regrettable absence of unanimity in the details of the notation. We can distinguish two main types, African and European. The African version is best represented in the gospels by *cod. Bobiensis* (k) of the 5th (some say 6th) century at Turin, and *cod. Palatinus* (e) of the 5th century at Vienna, both of which are imperfect, especially k, which, however, is far the superior in quality; in the Acts and Catholic epistles by *cod. Floriacensis* (f, h, or reg.) of the 6th century, a palimpsest which once belonged to the monks of Fleury, and by the so-called *speculum* (m) or collection of quotations formerly attributed to Augustine but probably connected with Spain. This scanty evidence is dated and localized as African by the quotations of Cyprian, of Augustine (not from the gospels), and of Primasius, bishop of Hadrumetum (d. c. 560), from the Apocalypse. It is still a disputed point whether Tertullian's quotations may be regarded as evidence for a Latin version or as independent translations from the Greek, nor is it certain that this version is African in an exclusive sense; it was undoubtedly used in Africa and there is no evidence that it was known elsewhere originally, but on the other hand there is no proof that it was not. The European version is best represented in the gospels by *cod. Vulgatenus* (a) of the 5th century and *cod. Veronensis* (b) of the same date (the latter being the better), and by others of less importance. It is possible that a later variety of it is found in *cod. Monacensis* (g) of the 7th century, and *cod. Brixianus* (f) of the 6th century, and this used to be called the Italic version, owing (as F. C. Burkitt has shown) to a misunderstanding of a remark of Augustine about the "Itala" which really refers to the Vulgate. In the Acts the European text is found in *cod. Gigas* (g or gig) of the 13th century at Stockholm, in a Pergipann MS. of the 12th century at Paris, and by S. Berger, and probably in *cod. Laudianus* (c) of the 7th century at Oxford. In the Catholic epistles it is found in *cod. Corbeiensis* (f or f) of the 10th century at St Petersburg. In the Pauline epistles it is doubtful whether it is extant at all, though some have found it in the *cod. Claramontanus* (d) and its allies. In the Apocalypse it is found in *cod. Gigas*.

The main problem in connexion with the history of the two or African and European versions is whether they were originally one or two. As they stand at present they are undoubtedly two, and can be distinguished both by the readings which they imply in the underlying Greek, and by the renderings which they have adopted. But there is also a greater degree of similarity between them than can be explained by accidental coincidence, and there is thus an *a priori* case for the theory that one of the two is a revision of the other, or that there was an older version, now lost, which was the original of both. If one of the two is the original it is probably the African, for which there is older evidence, and of which the style both in reading and rendering seems purer. The chief argument against this is that it seems paradoxical to think of Africa rather than Rome as the home of the first Latin version; but it must be remembered that the Roman Church was originally Greek, and that the beginnings of a Latin church in Rome seem to be surprisingly late.

Editions of Old Latin MSS. are to be found in *Old Latin Biblical Texts*, i-iv. (Oxford); in Migne's *Patrologia Latina*, tom. xii.; and their history is treated especially in F. C. Burkitt's "Old Latin and the Itala" (*Texts and Studies*, iv, 3), as well as in all books dealing with Textual Criticism generally; other important books are Rönisch's *Itala und Vulgata* (1875); Corssen's *Der cyprische Text der Acta Apostolorum* (Berlin, 1892); Wordsworth and Sanday on the "Corbey S. James" in *Studia Biblica*, i. (1885); the article

on the "Old Latin Version," in Hastings' *Dictionary of the Bible*. For the textual character and importance of these versions see the section *Textual Criticism* below.]

2. The Vulgate or Hieronymian version. To remedy the confusion produced by the variations of the Latin text Pope Damasus asked Jerome to undertake a revision, and the latter *Vulgata* published a new text of the New Testament in A.D. 384, and the rest of the Bible probably within two years. This version gradually became accepted as the standard text, and after a time was called the "Vulgata," the first to use this name as a title being, it is said, Roger Bacon. In the Old Testament Jerome made a new translation directly from the Hebrew, as the Old Latin was based on the LXX., but in the New Testament he revised the existing version. He did this fully and carefully in the gospels, but somewhat superficially in the epistles. He seems to have taken as the basis of his work the European version as it existed in his time, perhaps best represented by *cod. Monacensis* (g) of the 7th century, and by the quotations in *Ambroscostatus*, to which *cod. Brixianus* (f) of the 6th century would be added if it were not probable that it is merely a Vulgate MS. with intrusive elements. This type of text revised with the help of Greek MSS. of a type which does not seem to correspond exactly to any now extant, but to resemble B more closely than any others.

Of Jerome's revision we possess at least 800 MSS., of which the earliest may be divided (in the gospels at all events) into groups connected with various countries; the most important are the Northumbrian, Irish, Anglo-Irish and Spanish, but the first named might also be called the Italian, as it represents the text of good MS. brought from Italy in the 7th century and copied in the great schools of Wearmouth and Jarrow. One of the most important, *cod. Amiatinus*, was copied in this way in the time of Ceolfrid, Benedict Biscop's successor, as a present for Pope Gregory in 716. From these MSS. the original Hieronymian text may be reconstructed with considerable certainty. The later history of the version is complicated, but fairly well known. The text soon began to deteriorate by admixture with the Old Latin, as well from the process of transcription, and several attempts at a revision were made before the invention of printing. Of these the earliest of note were undertaken in France in the 9th century by Alcuin in 801, and almost at the same time in the British Isles by Ceolfrid (807-821). In the 11th century a similar task was undertaken by the monks of the bishop of Canterbury (1066-1089); in the 12th century by Stephen Harding (1109), third abbot of Cîteaux, and by Cardinal Nicolaus Maniacoria (1150), whose corrected Bible is preserved in the public library at Dijon. But these were not successful, and in the 13th century, instead of revisions, attempts were made to fix the text by providing *correctoria*, or lists of correct readings, which were the equivalent of critical editions; of these the chief are the Parisian, Macbrough (prepared under Hugo de S. Caro about 1240), and the Vatican. In the history of the printed Vulgates the earliest is the Mentz edition of 1467-1469, the *Vulgata* or "42-line" Bible), but the earliest of a critical nature were those of Robert Étienne in 1528 and 1538-1540. In 1546 the council of Trent decided that the Vulgate should be held as *authentica*, and in 1590 Pope Sixtus V. published a new and authoritative edition, which was, probably at the instigation of the Jesuits, recalled by Pope Clement VIII. in 1592. In the same year, however, the same pope published another edition under the name of Sixtus. This is, according to the Bull of 1592, the authoritative edition, and has since that time been accepted as the Latin Church. The critical edition by J. Wordsworth (bishop of Salisbury) in 1871, which probably restores the text almost to the state in which Jerome left it.

[The text of the Vulgate may be studied in Wordsworth and White, *Novum Testamentum Latine*; Corssen, *Epistula ad Galatas*. Its history is best given in S. Berger's *Histoire de la Vulgate* (Paris, 1893), in which a good bibliography is given on pp. xxiii-xxvii. The section in Kenyon's handbook to the *Textual Criticism of the New Testament* is particularly clear and full.]

Syriac Versions.—The Old Syriac. This is only known to us at present through two MSS. of the gospels, containing the *Evangelium da-Mepharreshe*, or separated gospel, probably the so-called in distinction to Tatian's *Diatessaron*. These *Old Syriac* MSS. are known as the Curetian and Sinaitic. The *Syriac* Curetian is a MS. of the 5th century. The fragments of it which we possess are MS. Brit. Mus. addit. 14,451, which was brought in 1842 from the monastery of St Mary in the Nitrian desert, and was edited by Cureton in 1858; and three leaves in Berlin (MS. Orient. Quart. 528) which were brought in Egypt by H. Brugsch and published by A. Roodiger in 1872. It was given to the monastery of St. Mary in the 10th century, but its earlier history is unknown. It contained originally the four gospels in the order Mt., Mk., Jo., Lc. It is generally quoted as Syr⁶⁶ or Syr C. The Sinaitic was discovered in 1892 by Mrs Lewis and Mrs Gibson in the library of St Catherine's monastery on Mt. Sinai, where it still remains, and was published in 1894 by R. L. Bensly, J. Rendel Harris and F. C. Burkitt, with an introduction by Mrs Lewis. It is a palimpsest MS., and the upper writing (lives of saints), dated A.D. 778, is the work of "John, the anchorite of Beth Mari Qanon, a monastery of Ma'arath Meqrén city in the district of Antioch." This town is

between Antioch and Aleppo; though the monastery is otherwise unknown, it seems probable that it was the source of many of the MSS. now at Sinai. The under writing seems to be a little earlier than that of the Curetician; it contains the gospels in the order Mt., Mc., Lc., Jo. with a few lacunae. There is no evidence that this version was ever used in the Church services: the Diatessaron was always the normal Syrian text of the gospels until the introduction of the Peshito. But the quotations and references in Aphraates, Ephraem and the Acts of Judas Thomas show that it was known, even if not often used. It seems certain that the Old Syrian version also contained the Acts and Pauline epistles, as Aphraates and Ephraem agree in quoting a text which differs from the Peshito, but no MSS. containing this text are at present known to exist. — [The text of this version is best given, with a literal English translation, in F. C. Burkitt's *Evangelion da Mepharreshe* (Cambridge, 1904).]

2. The Peshito (Simple) Version. This is represented by many MSS. dating from the 5th century. It has been proved almost to demonstration by F. C. Burkitt that the portion containing the gospels was made by Rabbula, bishop of Edessa (411), to take the place of the Diatessaron, and was based on the Greek text which was at that time in current use at Antioch. The Old Testament Peshito is a much older and quite separate version. The exact limits of Rabbula's work are difficult to define. It seems probable that the Old Syrian version did not contain the Catholic epistles, and as these are found in the Peshito they were presumably added by Rabbula. But he never added 2 Peter, Jude, 2 and 3 John, or the Apocalypse, and the text of these books, which is sometimes brought up with the Peshito, really is that of the Philoxenian or of the Harklean version. A comparison of the Peshito with quotations in Aphraates and Ephraem shows that Rabbula revised the text of the Acts and Pauline epistles, but in the absence of MSS. of the Old Syrian for these books, it is difficult to define the extent or character of his work. The Peshito is quoted as Syr P, Pesh., and Syrsc (because Tischendorf followed the edition of Schaaf).

[The best text of the Peshito is by G. H. Williams, *Tetraevangelium Sanctum* (Oxford, 1901); its relations to Rabbula's revision are shown by F. C. Burkitt, *Syrph*; its relations to quotations from the Gospel *in* *Matthaei*, vii. 2, Cambridge, 1901, which depends out of date F. H. Woods's article on the same subject in *Studia Biblica*, iii. pp. 105-138.]

3. The Philoxenian Version. This is known, from a note extant in MSS. of the Harklean version, to have been made in A.D. 508 for Philoxenus, bishop of Hierapolis, by Polycarpus, a chorepiscopus. No MSS. of it have survived except in 2 Peter, Jude, 2 and 3 John and the Apocalypse. The four former are found in some MSS. of the Peshito, as the Philoxenian was used to supply these epistles, which were not in the earlier version and the Apocalypse was published in 1892 by Dr Gwynn from a MS. belonging to Lord Crawford.

[This version may be studied in Isaac H. Hall's *Williams MS.* (Baltimore, 1886); in the European editions of the Syrian Bible so far as the minor Catholic epistles are concerned; in *Hermathena*, vol. vii. (1890), pp. 281-314 (article by Gwynn); in *Zeitschrift für Assyriologie*, xii. and xiii. (series of articles by Merx); in Gwynn's *The Apocalypse of St John in a Syriac Version* (Dublin, 1897).]

4. The Harklean Version. This is a revision of the Philoxenian made in 616 by Thomas of Harkel (Heraclea), bishop of Hierapolis. It was apparently an attempt to replace the literary freedom of the Philoxenian by a more literal rendering. It represents in the main the text of the later Greek MSS., but it has important textual notes, and has adopted a system of asterisks and obeli from the Hexaplar LXX. The source of these notes seems to have been old MSS. from the library of the Enaton near Alexandria. The marginal readings are therefore valuable evidence for the Old Alexandrian text. This version is quoted as Syr H (and when necessary Syr He* or Syr Hm*) and by Tischendorf as Syrp (=Syrph posterior). It should be noted that when Tischendorf speaks of Syrph he means the Peshito and the Harklean. [There is no satisfactory critical edition of this version, nor have the Philoxenian and the Harklean been disentangled from each other. The printed text is that published in 1778-1803 by J. White at Oxford under the title *Versio Philoxenica*; for the marginal notes see esp. Westcott and Hort, *Introduction*, and for Acts, Pott's *Abendländische Text der Apostelgesch.* (Leipzig, 1900).]

5. The Palestinian or Jerusalem Version. This is a lectionary which was once thought to have come from the neighbourhood of Jerusalem, but has been shown by Burkitt to come from that of Antioch. It was probably made in the 6th century in connection with the attempts of Justinian to abolish Judaism. Usually quoted as SyrPa and by Tischendorf as Syrp^{ant}. [The text may be found in Lewis and Gibson's *The Palestinian Syriac Lectionary* (London, 1899), (Gospcls), and in *Studia Sinaitica*, part vi. (Acts and Epistles); its origin is discussed best by F. C. Burkitt in the *Journal of Theological Studies*, vol. ii. (1901), pp. 174-183.]

6. The Karkaphensian. This is not a version, but a Syriac "Massorah" of the New Testament, i.e. a collection of notes on the texts. Probably emanates from the monastery of the Skull. Little is known of it and it is unimportant.

[See Gwilliam's "Materials for the Criticism of the Peshito N.T." in *Studia Biblica*, iii. esp. pp. 60-63.]

7. Tatian's Diatessaron. This is something more than a version. It was originally a harmony of the four gospels made by Tatian, the pupil of Justin Martyr, towards the end of the 2nd century. In its original form it is no longer extant, but Tatian's exists in Arabic (published by Casca) and Latin (*cod. Eusebianus*) translations, in both of which the text has unfortunately been almost entirely reformed to the ordinary type. These authorities are, therefore, only available for the reconstruction of the order of the selections from the gospels, not for textual criticism properly so called. For the latter purpose, however, we can use an Armenian translation of a commentary on the Diatessaron by Ephraem, and the quotations in Aphraates. The Diatessaron appears to have been the usual form in which the gospels were read until the beginning of the 5th century, when the Peshito was put in its place, and a systematic destruction of copies of the Diatessaron was undertaken.

The Diatessaron may be studied in Zahn, "Evangelienharmonie" article in the *Protestantische Realencyklopädie* (1898); J. H. Hill, *The Earliest Life of Christ* (Edinburgh, 1893); J. Rendel Harris, *Fragments of the Commentary of Ephraem the Syrian* (London, 1895); F. C. Burkitt, *Evangelion da Mepharreshe* (Cambridge, 1904, vol. ii.).

Inter-relation of Syriac Versions.—The relations which subsist between the various Syriac versions remain to be discussed. There is little room for doubt that the Harklean was based on the Philoxenian, and the Philoxenian was based on the Peshito, the revision being made in each case by the aid of the Greek MSS. of the day, but the relations which subsist between the Old Syrian, the Diatessaron and the Peshito are a more difficult question. There are now but few, if any, scholars who think that the Peshito is an entirely separate version, and the majority have been convinced by Burkitt and recognize (1) that the Peshito is based on a knowledge of the Old Syrian and the Diatessaron; (2) that it was made by Rabbula with the help of the contemporary Greek text of the Antiochene Church. But there is not yet the same degree of consensus as to the relations between the Old Syrian and the Diatessaron. Here it is especially difficult to distinguish between the original text of the Old Syrian and the existing MSS. of it—Cur., and it is a question that many passages in these show signs of Diatessaron influence, but this is only to be expected if we consider that from the end of the 2nd to the beginning of the 5th century the Diatessaron was the popular form of the gospels. A large discount has therefore to be made from the agreements between Diatessaron and Syr S and C. Still, it is improbable that this will explain everything, and it is generally conceded that the original Diatessaron and the original Old Syrian were in some way connected. This may be variously explained, and efforts have been made to show on which side the decision is to be given. The most probable theory is that of Burkitt. He thinks that the first Syriac translation was that of Tatian (c. A.D. 175), who brought the Diatessaron from Rome and translated it into Syriac. There, in the last days of the 2nd century, when Serapion was bishop of Antioch (A.D. 190-203), a new start was made, and a translation of the "separated Gospels" (*Evangelion da Mepharreshe*) was made from the MSS. which was in use at Antioch. Probably the maker of this version was partly guided, especially in his choice of renderings, by his knowledge of the Diatessaron. Nevertheless, the Diatessaron remained the more popular and was only given up by Theodoros and Rabbula in the 5th century, when it was replaced by the Peshito. If this theory be correct the Syriac versions represent three distinct Greek texts:—(1) the 2nd-century Greek text from Rome, used by Tatian; (2) the 2nd-century Greek text from Antioch, used for the Old Syrian; (3) the 2nd-century Greek text from Antioch, used by Rabbula for the Peshito.

[The best discussion of this point is in vol. ii. of Burkitt's *Evangelion da Mepharreshe*.]

Egyptian Versions.—Much less is known at present about the history of the Egyptian versions. They are found in various dialects of Coptic, the mutual relations of which are not yet certain, but the only ones which are preserved with any completeness are the Bohairic, or Lower Egyptian, and Sahidic, or Upper Egyptian, though it is certain that fragments of intermediate dialects such as Middle Egyptian, Fayumic, Akhmimic and Memphitic also exist. The Bohairic has been edited by G. Horner. It is well represented, as it became the official version of the Coptic Church; its history is unknown, but from internal evidence it seems to have been made from good Greek MSS. of the type of the date to which this points depends largely on the general view taken of the history of the text of the New Testament. It need not, but may be earlier than the 4th century. The Sahidic is not so well preserved. G. Horner's researches tend to show that the Greek text on which it was based was different from that represented by the Bohairic, and probably was akin to the "Western" text, perhaps of the type used by Clement of Alexandria. Unfortunately none of the MSS. seems to be good, and at present it is impossible to make very definite use of the version. It is possible that this is the oldest Coptic version, and this view is supported by the general probabilities of the spread of Christianity in Egypt.

which suggest that the native church and native literature had their strength at first chiefly in the southern parts of the country. It must be noted that Westcott and Hort called the Bohairic Memphitic, and the Sahidic Thebaic, and Tischendorf called the Bohairic Coptic.

[See G. Horner's *The Coptic Version of the New Testament in the Northern Dialect* (Oxford); Scrivener's *Introduction* (ed. Miller), vol. ii, pp. 91-144; and especially an article on "Egyptian Versions" in Hastings' *Dictionary of the Bible*, vol. i, by Forbes Robinson.]

(8) Among the secondary versions the only one of real importance is the *Armenian Version*.—The early history of this version is obscure, but it seems probable that there were two translations made in the 4th century: (1) by Mesrop with the help of Hrofnos (Rufinus?) based on a Greek text; (2) by Sahak, based on Syriac. After the council of Ephesus (A. D. 430) Mesrop and Sahak compared and revised their work with the help of MSS. from Constantinople. The general character of the version is late, but there are many places in which the Old Syriac basis can be recognized, and in the Acts and Epistles, where the Old Syriac is no longer extant, this is sometimes very valuable evidence.

[See Scrivener (ed. Miller) vol. ii, p. 154; Hastings' *Dictionary of the Bible*, article on "The Armenian Versions of the New Testament," by F. C. Conybeare; J. A. Robinson, "Euthaliana" (*Texts and Studies*, iii, 3), cap. 5; on the supposed connexion of Mark xvi, 8 ff. with Aristion mentioned in this version, see esp. Swete's *The Gospel according to St Mark* (London, 1902), p. xxi.]

Other secondary versions which are sometimes quoted are the Gothic, Ethiopic, Georgian, Arabic, Anglo-Saxon, Frankish and Persian. None has any real critical importance; details are given in Gregory's *Prolegomena* and in Scrivener's *Introduction*.

(C) *Quotations in Patristic Writings*.—The value of this source of evidence lies in the power which it gives us to date and localize texts. Its limitations are found in the inaccuracy of quotation of the writers, and often in the corrupt condition of their text. This latter point especially affects quotations which later scribes frequently forced into accord with the text they preferred.

All writers earlier than the 5th century are valuable, but particularly important are the following groups:—(1) Greek writers in the West, especially Justin Martyr, Tatian, Marcion, Irenaeus and Hippolytus; (2) Latin writers in Italy, especially Novatian, the author of the *Rehabilitatio* and Ambrosiaster; (3) Latin writers in Africa, especially Tertullian and Cyprian; (4) Greek writers in Alexandria, especially Clement of Alexandria, Origen, Athanasius and Cyril; (5) Greek writers in the East, especially Methodius of Lycia and Eusebius of Caesarea; (6) Syriac writers, especially Aphraates and Ephraem; it is doubtful whether the Diatessaron of Tatian ought to be reckoned in this group or in (1). None of these groups bears witness to quite the same text, nor can all of them be identified with the texts found in existing MSS. or versions, but it may be said with some truth that group 2 used the European Latin version, group 3 the African Latin, and group 6 the Diatessaron in the gospels and the Old Syriac elsewhere, while group 1 has much in common with *cod. Bezae*, though the difference is here somewhat greater. In group 4 the situation is more complex; Clement used a text which has most in common with *cod. Bezae*, but is clearly far from identical; Origen in the main has the text of δB ; Athanasius a somewhat later variety of the same type, while Cyril has a peculiar text which cannot be identified with any definite group of MSS. For further treatment of the importance of this evidence see the section *Textual Criticism* below.

[There is as yet but little satisfactory literature on this subject. Outstanding work is P. M. Barnard's "Clement of Alexandria's Biblical Text" (*Texts and Studies*, v, 5), 1899; Harraek's "Eligium Novatianum" in *Texte und Untersuchungen*, xiii, 1; Souter's "Ambrosiaster" in *Texts and Studies*, vii, 4; the Society of Historical Theology's *New Testament in the Apostolic Fathers*; an article by Kotschan, "Bibliciteit bei Origenes," in the *Zeitschrift f. wissenschaftliche Theologie* (1900), pp. 321-378; and on the general subject especially Nestle's *Einführung in das griechische Neue Testament* (Göttingen, 1909), pp. 159-167.] (K. L.)

3. Textual Criticism.

The problem which faces the textual critic of the New Testament is to reconstruct the original text from the materials supplied by the MSS., versions, and quotations in early writers, which have been described in the preceding section on the *apparatus criticus*. His object, therefore, is to discover and remove the various corruptions which have crept into the text, by the usual methods of the textual critic—the collection of material, the grouping of MSS. and other authorities, the reconstruction of archetypes, and the consideration of tran-

scriptional and intrinsic probability. No book, however, presents such a complicated problem or such a wealth of material for the textual critic.

In a certain wide sense the textual criticism of the New Testament began as soon as men consciously made recensions and versions, and in this sense Origen, Jerome, Augustine and many other ecclesiastical writers might be regarded as textual critics. But in practice it is general, and certainly convenient, to regard their work rather as material for criticism, and to begin the history of textual criticism with the earliest printed editions which sought to establish a standard Greek Text. It is, of course, impossible here to give an account of all these, but the following may fairly be regarded as the epoch-making books from the beginning to the present time.

The Complutensian.—The first printed text of the Greek Testament is known as the Complutensian, because it was made under the direction of Cardinal Ximenes of Alcalá (*Lat. Complutensium*). It was printed in 1514, and thus the first printed text, but is not the first published, as it was not issued until 1522. It is not known what MSS. Ximenes used, but it is plain from the character of the text that they were not of great value. His text was reprinted in 1569 by Chr. Plantin at Antwerp.

Erasmus.—The first published text was that of Erasmus. It was undertaken at the request of Joannes Froben (Frobenius), the printer of Basel, who had heard of Cardinal Ximenes' project and wished to forestall it. In this he was successful, as it was issued in 1516. It was based chiefly on MSS. at Basel, of which the only really good one (*cod. Euar.* 1) was seldom followed. Erasmus issued new editions in 1519, 1522, 1527 and 1535, and the Aldine Greek Testament, printed at Venice in 1518, is a reproduction of the first edition.

Stephanus.—Perhaps the most important of all early editions were those of Robert Etienne, or Stephanus, of Paris and afterwards of Geneva. His two first editions (1546, 1549) were based on Erasmus, the Complutensian, and collations of fifteen Greek MSS. These are 16mo volumes, but the third and most important edition (1550) was a folio with a revised text. It is this edition which is usually referred to as the text of Stephanus. A fourth edition (in 16mo) published at Geneva in 1551 is remarkable for giving the division of the text into verses which has since been generally adopted.

Beza.—Stephanus' work was continued by Theodore Beza, who published ten editions between 1565 and 1611. They did not greatly differ from the 1550 edition of Stephanus, but historically are important for the great part they played in spreading a knowledge of the Greek text, and as supplying the text which the Elzevirs made the standard on the continent.

Elzevir.—The two brothers, Bonaventura and Abraham Elzevir, published two editions at Leiden in 1624 and 1633, based chiefly on Beza's text. In the preface to the second edition the first is referred to as "textum . . . nunc ab omnibus receptum," and this is the origin of the name "Textus Receptus" (or T.R.), often given to the ordinary Greek Text. The Elzevir text has formed the basis of all non-critical editions on the continent, but in England the 1550 edition of Stephanus has been more generally followed. The importance of both the Stephanus and Elzevir editions is that they formed a definite text for the purposes of comparison, and so prepared the way for the next stage, in which scholars studied themselves with the investigation and collation of other MSS.

Walton's Polyglot.—The first to begin this work was Brian Walton, bishop of Chester, who published in 1657 in the 5th and 6th volumes of his "polyglot" Bible the text of Stephanus (1550) with the readings of fifteen new MSS. besides those employed by Stephanus himself. The collations were made for him by Archbishop Usher.

John Fell.—In 1675 John Fell, dean of Christ Church, published the Elzevir text with an enlarged apparatus, but even more important was the help and advice which he gave to the next important editor—Mill.

John Mill, of Queen's College, Oxford, influenced by the advice, and supported by the purse of John Fell until the latter's death, published in 1707 a critical edition of the New Testament which has still a considerable value for the scholar. It gives the text of Stephanus (1550) with collations of 78 MSS., besides those of Stephanus, the readings of the Old Latin, so far as was then known, the Vulgate and Peshito, together with full and valuable prolegomena.

Bentley.—A little later Richard Bentley conceived the idea that it would be possible to reconstruct the original text of the New Testament by a comparison of the earliest Greek and Latin sources; he began to collect material for this purpose, and issued a scheme entitled "Proposals for Printing" in 1720, but though he amassed many notes nothing was ever printed.

W. Mace.—Fairness forbids us to omit the name of William (or Daniel?) Mace, a Presbyterian minister who published *The New Testament in Greek and English*, in 2 vols. in 1729, and really anticipated many of the verdicts of later critics. He was, however, not in a position to obtain recognition, and his work has been generally overlooked.

J. J. Wetstein, one of Bentley's assistants, when living in Basel in 1730, published "Prolegomena" to the Text, and in 1751-1752 (at Amsterdam) the text of Stephanus with enlarged Prolegomena and apparatus criticus. His textual views were peculiar; he preferred to follow late MSS. on the ground that all the earlier copies had been contaminated by the Latin—almost reversing the teaching of Bentley. His edition is historically very important as it introduced the system of notation which, in the amplified form given to it by Gregory, is still in general use.

J. A. Bengel, abbot of Alpirsbach (a Lutheran community), published in 1734, at Tübingen, an edition of the New Testament with the beginning of a new era. For the first time an attempt was made to group the MSS., which were divided into African and Asiatic. The former group contained the few old MSS., the latter the many late MSS., and preference was given to the African. This innovation has been followed by almost all critics since Bengel's time, and it was developed by Griesbach.

J. J. Griesbach, a pupil at Halle of J. S. Semler (who in 1764 reprinted Wetstein's Prolegomena, and in comments of his own took over and expounded Bengel's views), collated many MSS., and distinguished three main groups:—the Alexandrian or Origenian (which roughly corresponded to Bengel's African), found in ABCL, the Egyptian or Origenian, and the Western, found in D and Latin authorities; and the Constantinopolitan (Bengel's Asiatic), found in the later MSS. and in Byzantine writers. His view was that the last group was the least valuable; but, except when internal evidence forbade (and he thought that it frequently did so), he followed the text found in any two groups against the third. His first edition was published in 1774-1775, his second and improved edition in 1796 (vol. I.) and 1806. For the second edition he had the advantage not merely of his own collection of material (published chiefly in his *Synbale Criticæ*, 1785-1793), but also of many collations by Birch, Matthæi and Adler, and an edition with new collations by F. K. Altr.

L. Hug, Roman Catholic professor of theology at Freiburg, published (Stuttgart and Origen) his *Einführung in die Schriften des N. T.* (1808), which is chiefly remarkable for the curious way in which he introduced many critical ideas which were not appreciated at the time but have since been revived. He accepted Griesbach's views as a whole, but starting from the known recensions of the LXX, he identified Griesbach's Alexandrian text with the work of Hesychius, and the Constantinopolitan with that of Lucian, while he described Griesbach's Western text as the *κοινή βιβλος*.

J. M. A. Scholz, a pupil of Hug, inspected and partially collated nearly a thousand MSS. and assigned numbers to them which have since been generally adopted. His work is for this reason important, but is unfortunately inaccessible.

Lachmann, the famous classical scholar, opened a new era in textual criticism in 1842-1850, in his *N.T. Græce et Latine*. In this great book a break was made for the first time with the traditional text and the evidence of the late MSS., and an attempt was made to reconstruct the text according to the oldest authorities. This was a great step forward, but unfortunately it was accompanied by a retrogression to the pre-Griesbachian (or rather pre-Bengelian) days; for Lachmann rejected the idea of grouping MSS., and having selected a small number of the oldest authorities undertook always to follow the reading of the majority.

C. Tischendorf, the most famous follower of Lachmann, besides editions of many MSS., and a collation of many of them published between 1841 and 1869-1872 eight editions of the New Testament with full critical notes. The eighth edition, which for the first time contained the readings of \mathbf{A} , has not yet been equalled, and together with the Prolegomena, supplied by C. R. Gregory after Tischendorf's death, is the standard critical edition which is used by scholars all over the world. At the same time it must be admitted that it gradually became antiquated. Fresh collations of MSS., and especially fresh discoveries and investigations into the text of the versions and Fathers, have given much new information which entirely changed the character of the evidence for many readings, and rendered a new edition necessary (see SOHN, H. von). As a collector and publisher of evidence Tischendorf was marvellous, but as an editor of the text he added little to the principles of Lachmann, and like Lachmann does not seem to have appreciated the value of the Griesbachian system of grouping MSS.

S. P. Tregelles, an English scholar, like Tischendorf, spent almost his whole life in the collection of material, and published a critical edition, based on the earliest authorities, at intervals between 1857 and 1872. His work was eclipsed by Tischendorf's, and his critical principles were almost the same as the German scholar's, so that his work has obtained less recognition than would otherwise have been the case. Tischendorf and Tregelles finished the work which Lachmann began. They finally exploded the pretensions of the *Textus Receptus* to be the original text; but neither of them, however, gave any explanation of the relations of the later text to the earlier, nor developed Griesbach's system of dealing with groups of MSS., rather than with single copies.

B. F. Westcott and F. J. A. Hort (commonly quoted as WH), the Cambridge scholars, supplied the deficiencies of Lachmann, and without giving up the advantages of his system, and its development by Tischendorf, brought back the study of the text of the

New Testament to the methods of Griesbach. Their great work was published in 1881 under the title of *The New Testament in the Original Greek*. Their view of the history of the text is that a comparison of the evidence shows that, while we can distinguish more than one type of text, the most clearly discernible of all the varieties is first recognizable in the quotations of Chrysostom, and is preserved in almost all the later MSS. Though found in so great a number of witnesses, this type of text is shown not to be the earliest or best by the evidence of all the oldest MS. versions and Fathers, as well as by internal evidence. Moreover, a comparison with the earlier sources of evidence shows that it was built up out of previously existing texts. This is proved by the "conflations" which are found in it. For instance in Mark ix. 38 the later MSS. read $\delta\epsilon\ \sigma\kappa\ \alpha\lambda\omega\theta\upsilon\sigma\epsilon\ \eta\mu\acute{\iota}\nu\ \delta\tau\iota\ \epsilon\kappa\omega\lambda\upsilon\sigma\alpha\mu\epsilon\ \alpha\upsilon\tau\acute{\omega}\nu\ \delta\tau\iota\ \sigma\kappa\ \alpha\lambda\omega\theta\upsilon\sigma\epsilon\ \eta\mu\acute{\iota}\nu$, a clumsy sentence which is clearly made up out of two earlier readings, $\delta\tau\iota\ \epsilon\kappa\omega\lambda\upsilon\sigma\alpha\mu\epsilon\ \alpha\upsilon\tau\acute{\omega}\nu\ \delta\tau\iota\ \sigma\kappa\ \eta\lambda\omega\theta\upsilon\sigma\epsilon\ \eta\mu\acute{\iota}\nu$, found in \mathbf{B} BCL boh., and $\delta\epsilon\ \sigma\kappa\ \alpha\lambda\omega\theta\upsilon\sigma\epsilon\ \mu\epsilon\theta\ \eta\mu\acute{\iota}\nu$, and $\delta\tau\iota\ \epsilon\kappa\omega\lambda\upsilon\sigma\alpha\mu\epsilon\ \alpha\upsilon\tau\acute{\omega}\nu$, found in DX Jam.¹, Jam.² 28 latt. It is impossible, in face of the fact that the evidence of the oldest witnesses of all sorts is constantly opposed to the longer readings, to doubt that WH were right in arguing that these phenomena prove that the later text was made up by a process of revision and conflation of the earlier forms. Influenced by the evidence of the later text, by Chrysostom, WH called this the Syrian or Antiochene text, and refer to the revision which produced it as the Syrian revision. They suggested that it might perhaps be attributed to Lucian, who is known to have made a revision of the text of the LXX. The earlier texts which were used for the Syrian revision may, according to WH, be divided into three:—(1) the Western text, used especially by Latin writers, and found also in *cod. Bezae* and in Syr C; (2) the Alexandrine text used by Cyril of Alexandria and found especially in CL $\mathbf{\Xi}$ 33; and (3) a text which differs from both the above mentioned and is therefore called by WH the Neutral text, found especially in \mathbf{A} B and the quotations of Origen. Of these three types WH thought that the Neutral was decidedly the best. The Alexandrian was clearly a literary recension of it, and WH strove to show that the Western was merely due to the non-literary efforts of scribes in other parts to improve the narrative. The only exception which they allowed to this general rule was in the case of certain passages, especially in the last chapters of Luke, where the "Western" authorities omit words which are found in the Neutral and Alexandrian texts. Their reason was that omission seems to be contrary to the genius of the Western text, and that it is therefore probable that these passages represent interpolations made in the text on the Neutral side after the division between it and the Western. They might be called Neutral interpolations, but WH preferred the more clumsy expression "Western non-interpolations." Having thus decided that the Neutral text was almost everywhere, it only remained for WH to choose between the various authorities which preserved this type. They decided that the two best authorities were \mathbf{A} and \mathbf{B} , and that when these differed the reading of \mathbf{B} , except when obviously an accidental blunder, was probably right. The great importance of this work of WH lies in the facts that it not merely condemns but explains the late Antiochene text, and that it attempts to consider in an objective manner all the existing evidence and to explain it historically and genealogically. Opinions differ as to the correctness of the results reached by WH, but there is scarcely room for doubt that as an example of method their work is quite unrivalled at present and is the necessary starting-point for all modern investigations.

Since Westcott and Hort no work of the same importance appeared up till 1909. Various useful texts have been issued, among which those of Nestle (*Novum Testamentum Græce*, Stuttgart, 1904), based on a comparison of the texts of Tischendorf, WH and Weiss, and of Baljon (*Novum Testamentum Græce*, Groningen, 1898), are the best. The only serious attempt as yet published to print a complete text independently of other editors is that of B. Weiss (*Das Neue Testament*, Leipzig, 1894-1900), but the method followed in this is so subjective and pays so little attention to the evidence of the versions that it is not likely to be permanently important. The text reached is not widely different from that of WH. The work in course of preparation by von Soden at Berlin, which promises to take the place of Tischendorf's edition, must certainly do this so far as Greek MSS. are concerned, for the whole field has been reinvestigated by a band of assistants who have grouped and collated specimens of all known MSS.

Besides these works the chief efforts of textual critics since WH have been directed towards the elucidation of minor problems, and the promulgation of certain hypotheses to explain the characteristics of individual MSS. or of groups of MSS. Among these the works of Sanday, Corsen, Wordsworth, White, Burkitt and Harris on the history of the Old Latin and Vulgate, and especially the work of Burkitt on the Old Syriac, have given most light on the subject. These lines of research have been described in the preceding section on the *apparatus criticus*. Other noteworthy and interesting, though in the end probably less important, work has been done by Blass, Bousset, Schmüdke, Rendel Harris and Chase. The outline of the chief works is as follows:—

F. Blass.—In his various books on the Acts and third gospel Blass has propounded a new theory as to the "Western" text. He was

struck by the fact that neither the Western can be shown to be derived from the Neutral, nor the Neutral from the Western. He therefore conceived the idea that perhaps both texts were Lucan, and represented two recensions by the original writer, and he reconstructed the history as follows. Luke wrote the first edition of the Gospel for Theophilus from Caesarea; this is the Neutral text of the Gospel. Afterwards he went to Rome and there revised the text of the Gospel and reissued it for the Church in that city; this is the Western (or, as Blass calls it, Roman) text of the Gospel. At the same time he continued his narrative for the benefit of the Roman Church, and published the Western text of the Acts. Finally he revised the Acts and sent a copy to Theophilus; this is the Neutral text of the Acts. This ingenious theory met with considerable approval when it was first advanced, but it has gradually been seen that "Western" text does not possess the unity which Blass's theory requires it to have. Still, Blass's textual notes are very important, and there is a mass of material in his books.

Bousset and Schmidtke.—These two scholars have done much work in trying to identify smaller groups of MSS. with local texts. Bousset has argued that the readings in the Pauline epistles found in κ H and a few minuscules represent the text used by Pamphilus, and on the whole this view seems to be highly probable. Another group which Bousset has tried to identify is that headed by B, which he connects with the recension of Hesychius, but this theory, though widely accepted in Germany, does not seem to rest on a very solid basis. To some extent influenced by and using Bousset's results, Schmidtke has tried to show that certain small lines in the margin of B point to a connexion between that MS. and a Gospel harmony, which, by assuming that the text of B is Hesychian, he connects with that of Ammonius. If true, this is an exceedingly important. Nestle, however, and other scholars think that the lines in B are merely indications of a division of the text into sense-paragraphs and have nothing to do with any harmony.

Rendel Harris and Chase.—Two investigations, which attracted much notice when they were published, tried to explain the phenomena of the Western text as due to retranslation from early versions into Greek. Rendel Harris argued for the influence of Latin, and Chase for that of Syriac. While both threw valuable light on obscure points, it seems probable that they exaggerated the extent to which retranslation cut its traces in the text of the *Gospel* so much, and went too highly as the best witness to the "Western" text; and that some of their work was rendered defective by their failure to recognize quite clearly that the "Western" text is not a unity. At the same time, however little Rendel Harris's results may ultimately be accepted by the textual critics of the future, his work will always remain historically of the first importance as having done more than anything else to stimulate thought and open new lines of research in textual criticism in the last decade of the 19th century.

The time has not yet come when any final attempt can be made to bring all the separate recensions of the *Gospel* into two texts, or when their necessitate serious modification of the views of Westcott and Hort; but a tentative and provisional judgment would probably have to be on somewhat the following lines. The work of WH may be summed up into two theorems:—(1) The text preserved in the later MSS. is not primitive, but built up out of earlier texts; (2) these earlier texts may be classified as Western, Alexandrian and Neutral, of which the Neutral is the primitive form. The former of these theorems has been generally accepted and may be taken as proved, but the second has been closely criticized and probably must be modified. It has been approached from two sides, and versions which have considered the Western or the Neutral and Alexandrian texts.

The Western Text.—This was regarded by WH as a definite text, found in D, the Old Latin and the Old Syriac; and it is an essential part of their theory that in the main these three witnesses represent one text. On the evidence which they had WH were undoubtedly justified, but discoveries and investigation have gone far to make it impossible to hold this view any longer. We now know more about the Old Latin, and, thanks to Mrs Lewis' discovery, much more about the Old Syriac. The result is that the authorities on which WH relied for their Western text are seen to bear witness to two texts, not one. The Old Latin, if we take the African form as the oldest, as compared with the Neutral text has a series of interpolations and a series of omissions. The Old Syriac, if we take the Sinaitic MS. as the purest form, compared in the same way, has a similar double series of interpolations and omissions, but neither the omissions nor the interpolations are the same in the Old Latin as in the Old Syriac. Such a line of research suggests that instead of being able, as WH thought, to set the Western against the Neutral text (the Alexandrian being merely a development of the latter), we must consider the problem as the comparison of at least three texts, the Western (geographically), an Eastern and the Neutral. This makes the matter much more difficult; and an answer is demanded to the problem afforded by the agreement of two of these texts against the third. The obvious solution would be to say that where two agree their reading is probably correct, but the followers of WH maintain that the agreement of the Western and Eastern is often an agreement in error. It is difficult to see how texts, geographically so wide apart as the Old Latin and Old Syriac would seem to be, are likely to agree in error, but it is certainly

true that some readings found in both texts seem to have little probability. Sanday, followed by Chase and a few other English scholars, has suggested that the Old Latin may have been made originally in Antioch, but this paradoxical view has met with little support. A more probable suggestion is Burkitt's, who thinks that many readings in our present Old Syriac MSS. are due to the Diatessaron, which was a geographically Western text. It may be that this suggestion will solve the difficulty, but at present it is impossible to say.

The Neutral and Alexandrian Texts.—WH made it plain that the Alexandrian text was a literary development of the Neutral, but they always maintained that the latter text was not confined to, though chiefly used in Alexandria. More recent investigations have confirmed their view as to the relation of the Alexandrian to the Neutral text, but have thrown doubt on the age and widespread use of the latter. Whatever view be taken of the provenance of *Codex Vaticanus* it is plain that its archetype had the Pauline epistles in a peculiar order which is only found in Egypt, and so far as one has been able to discover any non-Alexandrian writer who used the Neutral text. Moreover, Barnard's researches into the Biblical text of Clement of Alexandria show that there is reason to doubt whether even in Alexandria the Neutral text was used in the earliest times. We have no evidence earlier than Clement, and the text of the New Testament which he quotes has more in common with the Old Latin or "geographically Western" text than with the Neutral, though it definitely agrees with no known type preserved in MSS. or versions. This discovery has put the Neutral text in a different light. It would seem as though we could roughly divide this history of the text in Alexandria into three periods: the earliest is that which is represented by the quotations in Clement, and must have been in use in Alexandria at the end of the 2nd and beginning of the 3rd century. It is unfortunately not found in any extant MS. The second stage is that found in the quotations of Origen which is fairly well represented in κ B, though Origen seems at times to have used MSS. of the earlier type. The third stage is WH's Alexandrian, found in the quotations of Cyril of Alexandria and a few MSS. (see *CL* Σ Ψ). It is clearly a revision of the second stage, as WH saw, but we can now add that it was not merely a literary revision but was influenced by the tendency to alter readings which are found in the first stage but rejected in the second.

It thus seems probable that WH's theory must be modified, both as regards the "Western" text, which is seen not to be a single text at all, and as regards the "Neutral" text, which seems to be nothing more than the second stage of the development of the text in Alexandria. But the importance of these modifications is something more than the doubt which they have thrown on WH's theories: they have really shifted the centre of gravity of the textual problem.

As regards the Greek uncials, which go back to the 4th century, were regarded as the most important source of evidence, and were supposed to have the decisive vote; but now it is becoming plain that still more important, though unfortunately much less complete, is the evidence of the versions and of quotations by early writers. Both of these point to the existence in the 3rd and even 2nd century of types of text which differ in very many points from anything preserved in Greek MSS. Yet there is no doubt that both of them ultimately represent Greek MSS. which are no longer extant. The question, therefore, is whether we ought not to base our text on the versions and ecclesiastical quotations rather than on the extant Greek MSS. readings; or, if we prefer to stick to the latter, to base our text on the best existing Greek MSS. by the argument that these represent the text which was approved by competent judges in the 4th century, and would be found to exist in earlier MSS. if we possessed them. The weak point of this argument is the lack of evidence in support of the second part. The only possible sources of evidence, apart from the discovery of fresh MSS., are the versions, and they do not point to existence in the 2nd or 3rd century of texts agreeing with the great uncials. It is also possible to argue, as WH did, on the same side, that the purest form of text was preserved in Alexandria, from which the oldest uncials are directly or indirectly derived, but this argument has been weakened if not finally disposed of by the evidence of Clement of Alexandria. It is, of course, conceivable that Clement merely used bad MSS., and that there were other MSS. which he might have used, agreeing with the great uncials, but there is no evidence for this view. (2) If we reject this position we must accept the evidence as giving the great uncials much the same secondary importance as Westcott and Hort gave to the later MSS., and make an attempt to reconstruct a text on the basis of versions and Fathers. The adoption of this view sets textual criticism a peculiarly difficult task. The first stage in their work must be the establishment of the earliest and best version, and the collection and examination of the quotations in all the early writers. This has not yet been done, but enough has been accomplished to point to the probability that the result will be the establishment of at least three main types of texts, represented by the Old Syriac, the Old Latin and Clement's quotations, while it is doubtful how far Tatian's Diatessaron, the quotations in Justin and a few other sources may be used to reconstruct the type of Greek text used in Rome in the 2nd century when Rome was still

primarily a Greek church. The second stage must be the comparison of these results and the attempt to reconstruct from them a Greek text from which they all arose.

BIBLIOGRAPHY.—The literature of textual criticism of the New Testament is so great that only a few of the more important modern books can be mentioned here: H. von Soden, *Die Schriften des Neuen Testaments* (i. 1902-1907); E. Nestle, *Einführung in das griechische Neue Testament* (Göttingen, 1909); F. G. Kenyon, *Handbook to the Textual Criticism of the New Testament* (London, 1901); C. R. Gregory, *Textkritik des Neuen Testament* (Leipzig, 1900-1902), and *Die griech. Handschr. des N. T.* (Leipzig, 1908); Westcott and Hort, *Introduction* (vol. II. of their *New Testament in Greek*, Cambridge, 1882). The history of criticism is dealt with in all the above-mentioned books, and also in F. H. Scrivener, *Introduction to the Criticism of the New Testament* (London, 1894). For other points especially important (besides books mentioned in the preceding section) see F. Blass, *Acta Apostolorum* (Göttingen, 1895); and an editio minor, with a valuable preface, Leipzig, 1896); Rendel Harris, *Four Lectures on the Western Text* (Cambridge, 1894); F. Chase, *The Syro-Latin Text* (London, 1895); W. Bousset, *Textkritische Studien* (Leipzig, 1894); B. Weiss, *Der Codex D in der Apostelgeschichte* (Leipzig, 1897); A. Pott, *Der abendländische Text d. Apostelgeschichte* (Leipzig, 1900); G. Salmon, *Some Thoughts on Textual Criticism of the New Testament* (London, 1897); Schmidtke, *Die Evangelien eines alten Unzialcodex* (Leipzig, 1903).

4. Higher Criticism.

The New Testament is a series of early Christian writings which the Church came to regard as canonical, i.e. they were placed in the same category as the Old Testament, the writings which the Christian had inherited from the Jewish Church. Just as the ancient Scriptures were considered to be the Word of God, so that what they contained was necessarily the true and inspired doctrine, so also the New Testament was available for proving the Church's dogma. The assured canonicity of the whole New Testament resulted in its use by the medieval theologians, the Schoolmen, as a storehouse of proof-texts. Thus the New Testament seemed to exist in order to prove the Church's conclusions, not to tell its own tale.

The *Novum Instrumentum* published by Erasmus in 1516 (see above, *Textual Criticism*) contained more than the mere *Erasmus*. Edition Principles of the Greek text: Erasmus accompanied it with a Latin rendering of his own, in which he aimed at giving the meaning of the Greek without blindly following the conventional phraseology of the Latin Vulgate, which was the only form in which the New Testament had been current in western Europe for centuries. This rendering of Erasmus, together with his annotations and prefaces to the several books, make his editions the first great monument of modern Biblical study. Medieval Bibles contain short prefaces by St Jerome and others. The stereotyped information supplied in these prefaces was drawn from various sources: Erasmus distinguishes, e.g., between the direct statements in the Acts and the inferences which may be drawn from incidental allusions in the Pauline Epistles, or from the statements of ancient non-canonical writers.¹ This discrimination of sources is the starting-point of scientific criticism.

The early champions of Church reform in the beginning of the 16th century found in the Bible their most trustworthy weapon. The picture of Apostolical Christianity found in the New Testament offered indeed a glaring contrast to the papal system of the later middle ages. Moreover, some of the "authorities" used by the Schoolmen had been discovered by the New Learning of the Renaissance to be no authorities at all, such as the writings falsely attributed to Dionysius the Areopagite. When, therefore, the breach came, and the struggle between reformers and conservatives within the undivided Church was transformed into a struggle between Protestants and Romanists, it was inevitable that the authority which in the previous centuries had been ascribed to the Church

¹ E.g. from the preface to the Acts: "Dionysius, bishop of the Corinthians, a very ancient writer, quoted by Eusebius, writes that Peter and Paul obtained the crown of martyrdom by the command of Nero on the same day." And again: "Some industrious critics have added (to the narrative of Acts) that Paul was acquitted at his first trial by Nero. . . . This conjecture they make from the 2nd Ep. to Timothy. . . ."

should be transferred by the Reformed Churches to the Bible. "The Bible, the Bible alone, is the religion of Protestants"² did really express the watchword of the anti-Romanist parties, especially towards the close of the acuter struggle. At the beginning of the movement the New Testament itself had been freely criticized. Luther, like his countrymen of to-day, judged the contents of the New Testament by the light of his leading convictions; and in his German translation, which occupies the same place in Germany as the Authorized Version of 1611 does in English-speaking lands, he even placed four of the books (Hebrews, James, Jude, Apocalypse) in an appendix at the end, with prefaces explanatory of this drastic act of criticism. But though we may trace a real affiliation between the principles of Luther and modern German critical study—notably in the doctrines of the Gospel within the Gospel and of the residual Essence of Christianity—Luther's discriminations were in the 17th century ignored in practice.

From cover to cover the whole New Testament was regarded at the beginning of the 18th century by almost all Protestants as the infallible revelation of the true religion. The doctrines of Christianity, and in many communities the customs of the Church, were held to be inferences from the inspired text of the Scriptures. The first serious blow to this view came from the study of textual criticism. The editions of Mill (1707) and of Wetstein (1751) proved once for all that variations in the text, many of them serious, had existed from the earliest times. It was evident, therefore, that the true authority of the New Testament could not be that of a legal code which is definite in all its parts. More important still was the growing perception of the general uniformity of nature, which had forced itself with increasing insistence upon men's minds as the study of the natural sciences progressed in the 17th and 18th centuries. The miracles of the New Testament, which had formerly been received as bulwarks of Christianity, now appeared as difficulties needing explanation. Furthermore, the prevailing philosophies of the 18th century tended to demand that a real divine revelation should be one which expressed itself in a form convincing to the reason of the average plain man, whatever his predispositions might be; it was obvious that the New Testament did not wholly conform to this standard.

But if the New Testament be not itself the direct divine revelation in the sense of the 18th century, the question still remains, how we are to picture the true history of the rise of Christianity, and what its true meaning is. This is the question which has occupied the theologians of the 19th and 20th centuries. Perhaps the most significant event from which to date the modern period is the publication by Lessing in 1774-1777 of the "Wolfenbüttel Fragments," i.e. H. S. Reimarus's posthumous attack on Christianity, a work which showed that the mere study of the New Testament is not enough to compel belief in an unwilling reader. Lessing's publication also helped to demonstrate the weakness of the older rationalist position, a position which really belongs to the 18th century, though its best-remembered exponent, Dr H. E. G. Paulus, only died in 1851. The characteristic of the rationalists was the attempt to explain away the New Testament miracles as coincidences or naturally occurring events, while at the same time they held as tenaciously as possible to the accuracy of the letter of the New Testament narratives. The opposite swing of the pendulum appears in D. F. Strauss: in his *Leben Jesu* (1833) he abandons the shifts and expedients by which the rationalists eliminated the miraculous from the Gospel stories, but he abandons also their historical character. According to Strauss the fulfillments of prophecy in the New Testament arise from the Christians' belief that the Christian Messiah must have fulfilled the predictions of the prophets, and the miracles of Jesus in the New Testament either originate in the same way or are purely mythical embodiments of Christian doctrines.

² The phrase is Chillingworth's (1637), who may be described as a Broad High-churchman.

Influence of textual criticism.

Rationalists.

Strauss.

The main objection to this presentation, as also to that of the rationalists, is that it is very largely based not upon the historical data, but upon a pre-determined theory.

Tübingen school. Granted the philosophical basis, the criticism practised upon the New Testament by Paulus and Strauss follows almost automatically. Herein lies the permanent importance of the work of Ferdinand Christian Baur, professor of theology at Tübingen from 1826 to 1860. The corner-stone of his reconstruction of early Christian history is derived not so much from philosophical principles as from a fresh study of the documents. Starting from Galatians and 1 Corinthians, which are obviously the genuine letters of a Christian leader called Paul to his converts, Baur accepted 2 Corinthians and Romans as the work of the same hand. From the study of these contemporary and genuine documents, he elaborated the theory that the earliest Christianity, the Christianity of Jesus and the original apostles, was wholly Judaistic in tone and practice. Paul, converted to belief in Jesus as Messiah after the Crucifixion, was the first to perceive that for Christians Judaism had ceased to be binding. Between him and the older apostles arose a long and fierce controversy, which was healed only when at last his disciples and the Judaizing disciples of the apostles coalesced into the Catholic Church. This only occurred, according to Baur, early in the 2nd century, when the strife was finally allayed and forgotten. The various documents which make up the New Testament were to be dated mainly by their relation to the great dispute. The Apocalypse was a genuine work of John the son of Zebedee, one of the leaders of the Judaistic party, but most of the books were late, at least in their present form. The Acts, Baur thought, were written about A.D. 140, after the memory of the great controversy had almost passed away. All four Gospels also were to be placed in the 2nd century, though that according to Matthew retained many features unaltered from the Judaistic original upon which it was based.

The Tübingen school founded by Baur dominated the theological criticism of the New Testament during a great part of the 19th century and it still finds some support. The main position was not so much erroneous as one-sided. **Later views.** The quarrel between St Paul and his opponents did not last so long as Baur supposed, and the great catastrophe of the fall of Jerusalem effectually reduced thorough-going Judaistic Christianity into insignificance from A.D. 70 onwards. Moreover, St Paul's converts do not seem to have adopted consistent "Paulinism" as a religious philosophy. St Paul was an emancipated Jew, but his converts were mostly Greeks, and the permanent significance of St Paul's theories of law and faith only began to be perceived after his letters had been collected together and had been received into the Church's canon. All these considerations tend to make the late dates proposed by Baur for the greater part of the New Testament books unnecessary; the latest investigators, notably Professor A. Harnack of Berlin, accept dates that are not far removed from the ancient Christian literary tradition.

Literary criticism of the Gospels points to a similar conclusion. A hundred years' study of the synoptic problem, i.e. the causes which make the Gospels according to Matthew, Mark and Luke at once so much alike and so different, has resulted in the demonstration of the priority of Mark, which "was known to Matthew and Luke in the same state and with the same contents as we have it now."¹ This Gospel may be dated a very few years after A.D. 70. Luke and Matthew appear to have been published between 80 and 100.² Besides the Gospel of Mark these Evangelists made use of another document, now lost, which contained many sayings of Jesus and some narratives not found in Mark. This document is by many scholars identified with the "Logia," mentioned by Papias (Eusebius, *Ch. Hist.* iii. 39) as being the work of Matthew the Apostle, but the identification is not certain.

The Johannine writings, i.e. the Fourth Gospel and the three Epistles of John, represent the view of Christ and Christianity taken by a Christian teacher, who seems to have lived and written in Asia Minor at the close of the 1st century A.D. The value of the Fourth Gospel as a narrative of events is a matter of dispute, but the view of the personality of Jesus Christ set forth in it is unquestionably that which the Church has accepted.

The discoveries of papyri in Upper Egypt during recent years, containing original letters written by persons of various classes and in some cases contemporary with the Epistles of the New Testament, have immensely increased our knowledge of the Greek of the period, and have cleared up not a few difficulties of language and expression. More important still is the application of Semitic study to elucidate the Gospels. It is idle indeed to rewrite the Gospel narratives in the Aramaic dialect spoken by Christ and the apostles, but the main watchwords of the Gospel theology—phrases like "the Kingdom of God," "the World to come," "the Father in Heaven," "the Son of Man,"—can be more or less surely reconstructed from Jewish writings, and their meaning gauged apart from the special significance which they received in Christian hands. This line of investigation has been specially followed by Professor G. Dalman in his *Worte Jesu*. The study of the Semitic elements in early Christianity is less advanced than the study of the Greek elements, so that it is doubtless from the Semitic side that further progress in the criticism of the New Testament may be expected.

BIBLIOGRAPHY.—See the separate bibliographies to the separate articles on the books of the New Testament. The selection here given of the vast literature of the subject has been drawn up with the idea of setting the student on his way. 1. *General and Historical.*—Jerome's *Prefaces* (to be found in any R. C. edition of the Vulgate); Luther's *Prefaces* (to be found in German-printed editions of Luther's Bible); F. Seehörm, *The Oxford Reformers* (3rd ed., London, 1887)—for Erasmus; M. Creighton, "Chillingworth" in the *Dict. of Nat. Biogr.*; Chr. Schrempf, *Lessing als Philosoph* (Stuttgart, 1906); J. Estlin Carpenter, *The Bible in the 19th Century* (London, 1903); A. Schweitzer, *Von Reimarus zu Wrede* (Tübingen, 1906). 2. *For the Synoptic Gospels.*—W. G. Rushbrooke, *Synoptic Gospels* (1880), (trans. in *The Common Tradition of the Synoptic Gospels* by E. A. Abbott and W. G. Rushbrooke, London, 1884), Sir J. C. Hawkins, *Horae Synopticae* (Oxford, 1899); Prof. Julius Wellhausen, *Einkleitung in die drei ersten Evangelien* (Berlin, 1905), *Das Evangelium Marci* (1902), *Das Ev. Matthaei* (1904), *Das Ev. Luciae* (1904)—these four books make one work; Prof. A. Harnack, *Lukas der Arzt* (Berlin, 1905). 3. *For the Fourth Gospel.*—K. G. Bretschneider, *Probabilia* (Leipzig, 1820); Matthew Arnold's *God and the Bible*, chaps. v., vi. (still the best defence in English of a Johannine kernel, new ed., 1884); W. Sanday, *Criticism of the Fourth Gospel* (Oxford, 1905); A. Loisy, *Le Quatrième Évangile* (Paris, 1903); Prof. P. W. Schmiedel, *Das vierte Evangelium gegenüber den drei ersten* (Halle, 1906). 4. *For the Semitic Elements in the N.T.*—Prof. G. Dalman, *Die Worte Jesu* (Leipzig, 1898), (Eng. trans., *The Words of Jesus*, 1905); Prof. Johannes Weiss, *Die Predigt Jesu vom Reiche Gottes* (1st ed., 1892, 2nd ed., 1900). 5. *The Protestant view of the New Testament in Prof. A. Harnack, Das Wesen des Christentums* (Berlin, 1900), (Eng. trans., *What is Christianity?*, London, 1901) may be compared with the Liberal Catholic view in A. Loisy, *L'Évangile et l'Église* (2nd ed., 1903). (F. C. B.)

5. New Testament Chronology.

The subject of the chronology of the New Testament falls naturally into two distinct sections—the chronology of the Gospels, that is, of the life of Christ; and the chronology of the Acts, that is, of the apostolic age.

The Chronology of the Gospels.

The data group themselves round three definite points and the intervals between them: the definite points are the Nativity, the Baptism and the Crucifixion; the age of Christ at the time of the Baptism connects the first two points, and the duration of his public ministry connects the second and third. The results obtained under the different heads serve mutually to test, and thereby to correct or confirm, one another.

1. The date of the Nativity as fixed according to our common computation of Anni Domini (first put forward by Dionysius Exiguus at Rome early in the 6th century) has long been recognized to be too late. The fathers of the primitive church had been

¹ J. Wellhausen, *Einl. in die drei ersten Evangelien* (1905), p. 57.

² If Luke used Josephus, as F. C. Burkitt and others believe, the later date must be taken; otherwise the earlier date is more probable, as in any case it must fall within the lifetime of a companion of St Paul.

nearer the truth with the years 3 or 2 B.C. (see Irenaeus, *Haer.* iii. xxi. 3 [xxiv. 2]; Clement of Alexandria, *Strom.* i. 21, p. 147; Hippolytus, in *Danidem*, iv. ed. Bonwetsch, p. 242; [Tertullian], *adv. Iudaeos*, 8). What may be called the received chronology during the last two centuries has pushed the date farther back to 4 B.C. But the considerations now to be adduced make it probable that the true date is earlier still.

(a) *Evidence of St Matthew's Gospel* (i. 18-ii. 22).—The birth of Christ took place before the death of Herod, and the evidence of Josephus fixes the death of Herod, with some approach to certainty, in the early spring of 4 B.C. Josephus, indeed, while he tells us that Herod died not long before Passover, nowhere names the exact year; but he gives four calculations which serve to connect Herod's death with more or less known points, namely, the length of Herod's own reign, both from his *de jure* and from his *de facto* accession, and the length of the reigns of two of his successors, Archelaus and Herod Philip, to the date of their deposition and death respectively. The various calculations are not quite easy to harmonize, but the extent of choice for the year of Herod's death is limited to the years 4 and 3 B.C., with a very great preponderance of probability in favour of the former. How long before this the Nativity should be placed the Gospel does not enable us to say precisely, but as Herod's decree of extermination included all infants up to two years of age, and as a sojourn of the Holy Family in Egypt of unknown length intervened between the massacre and Herod's death, it is clear that it is at least possible, so far as the evidence of this Gospel goes, that the birth of Christ preceded Herod's death by as much as two or three years. What is thus shown to be possible would, of course, be necessary if we went on, with the astronomer Kepler, to identify the star of the Magi with the conjunction of the planets Jupiter and Saturn which occurred, in the constellation Pisces, in May, October and December of 7 B.C.¹

(b) *Evidence of St Luke's Gospel* (ii. 1-8).—The birth of Christ took place at the time of a general census of the empire ordered by Augustus: "it was the first census, and was made at the time when Quirinius was governor of Syria." Against this account it has been urged that we know that the againstship of Syria from 10 or 9 B.C. down to and after Herod's death was held successively by M. Titius, C. Sentius Saturninus, and P. Quintilius Varus; and further, that when Judaea became a Roman province on the deposition of Archelaus in A.D. 6, Quirinius was governor of Syria, and did carry out an elaborate census. The notice in the Gospel, it is suggested, grew out of a confused recollection of the later (and only historical) census, and is devoid of any value whatever. At the other extreme Sir W. M. Ramsay (*Was Christ Born at Bethlehem?*, 1898, pp. 149 ff.) defends the exact accuracy of St Luke's "first census" as witnessing to the (otherwise of course unknown) introduction into Syria of the periodic fourteen years' census which the evidence of papyri has lately established for Egypt, at least from A.D. 20 onwards. Reckoning back from A.D. 20, the periodic census should fall in 9 B.C., but Ramsay alleges various causes for delay, which would have postponed the actual execution of the census till 7 B.C., and supposes that Quirinius was an imperial commissioner specially appointed to carry it out. The truth seems to rest midway between these extremes. St Luke's statement of a general census is in all probability erroneous, and the introduction of the name Quirinius appears to be due to confusion with the census of A.D. 6. But the confusion in question would only be possible, or at any rate likely, if there really was a census at the time of the Nativity; and it is no more improbable that Herod should have held, or permitted to be held, a local census than that Archelaus of Cappadocia in the reign of Tiberius (Tacitus, *Ann.* vi. 41) should have taken a census of his own native state "after the Roman manner."

But St Luke's account, when the name of Quirinius is subtracted from it, ceases to contain any chronological evidence.

(c) *Evidence of Tertullian*.—Strangely enough, however, the missing name of the governor under whom the census of the Nativity was carried out appears to be supplied by an author who wrote more than a century after St Luke, and has by no means a good reputation for historical trustworthiness. Tertullian, in fact (*adv. Marcionem*, iv. 19), employs against Marcion's denial of the true humanity of Christ the argument that it was well known that Sentius Saturninus carried out a census under Augustus in Judaea, by consulting which the family and relationships of Christ could have been discovered. This Saturninus was the middle one of the three governors of Syria named above, and as his successor Varus must have arrived by the middle of 6 B.C. at latest (for coins of Varus are extant of the twenty-fifth year of the era of Actium), his own tenure must have fallen about 8 and 7 B.C., and his census cannot be placed later than 7 or 7-6 B.C. The independence of Tertullian's information about this census is guaranteed by the mere fact of his knowledge of the governor's name; and if there was a census about that date, it would be unreasonable not to identify it with St Luke's census of the Nativity.

The traditional Western day for the Christmas festival, 25th December, goes back as far as Hippolytus, *loc. cit.*; the traditional Eastern day, 6th January, as far as the Basilidian Gnostics (but in their case only as a celebration of the Baptism), mentioned by Clement of Alexandria, *loc. cit.*

2. The interval between the Nativity and the Baptism.

Evidence of St Luke's Gospel (iii. 23).—At the time of his baptism Jesus was ἀρχόμενος ὡσεὶ ἑτῶν τριάκοντα, of which words two opposite misinterpretations must be avoided: (i) ἀρχόμενος does not mean (as Valentinian interpreters thought, *Iren.* ii. xxii. 5 [xxxiii. 3]; so also Epiphanius, *Haer.* li. 16) "beginning to be thirty years" in the sense of "not yet quite thirty," but "at the beginning of his ministry," as in Luke xxiii. 5; Acts i. 22, x. 37; (ii) ὡσεὶ ἑτῶν τριάκοντα does not mean "on attaining the full age of thirty, before which he could not have publicly taught," for if there was by Jewish custom or tradition any minimum age for a teacher, it was not thirty, but forty (*Bab. Talm.* ed. 1715, fol. 19 b; *Iren. loc. cit.*). St Luke's phrase is a general one, "about thirty years old," and cannot be so pressed as to exclude some latitude in either direction.

3. The date of the Baptism.

(a) *Evidence of St Luke's Gospel* (iii. 1).—A *terminus a quo* for the Baptism is the synchronism of the commencement of the Baptist's public ministry with the fifteenth year of the rule (ἡγεμονία) of Tiberius. Augustus died on 19th August A.D. 14, and reckoned from that point, Tiberius's fifteenth year might be, according to different methods of calculation, either A.D. 28, or 28-29, or 29. But any such result would be difficult to reconcile with the results yielded by other lines of investigation in this article; among alternative views the choice seems to lie between the following:—(i) The years of Tiberius are here reckoned from some earlier starting-point than the death of his predecessor—probably from the grant to him of co-ordinate authority with Augustus over the provinces made in A.D. 11 (see, for the parallel with the case of Vespasian and Titus, Ramsay, *St Paul the Roman Traveller*, p. 387); so that the fifteenth year would be roughly A.D. 25; or (ii) St Luke has made here a second error in chronology, caused perhaps in this case by reckoning back from the Crucifixion, and only allowing one year to the ministry of Christ.

(b) *Evidence of St John's Gospel* (ii. 13, 20).—A *terminus ad quem* for the Baptism is the synchronism of the first Passover mentioned after it with the forty-sixth year of the building of Herod's Temple. Herod began the Temple in the eighteenth year of his reign, probably 20-19 B.C., and the Passover of the forty-sixth year is probably that of A.D. 27. While too much stress must not be laid on a chain of reasoning open to some uncertainty at several points, it is difficult to suppose with Loisy, *Quatrième Évangile*, 1903, p. 293, that the number was intended

¹ It is a curious coincidence that a medieval Jew, R. Abarbanel (Abarabanel), records that the conjunction of these particular planets in this particular constellation was to be a sign of Messiah's coming. It is just conceivable that his statement may ultimately depend on some such ancient tradition as may have been known to Chaldaean magi.

by the evangelist as purely figurative, and is therefore destitute of all historical meaning.

On the whole, the Baptism of Christ should probably be placed in A.D. 26-27; and as the Nativity was placed in 7-6 B.C. (at latest), this would make the age of Christ at his Baptism to be about thirty-two, which tallies well enough with St Luke's general estimate.

4. The interval between the Baptism and the Crucifixion, or, in other words, the duration of the public ministry of Christ.

(a) *Evidence of the Synoptic Tradition and of St Mark's Gospel* (ii. 23, vi. 39, xiv. 1).—The order of events in the primitive synoptic tradition appears to be faithfully reproduced in St Mark; and if this order is chronological, Christ's ministry lasted at least two years, since the plucking of the ears of corn (April-June) marks a first spring; the feeding of the five thousand when the grass was fresh green ($\chi\lambda\omega\rho\acute{o}s$: about March), a second; and the Passover of the Crucifixion a third; and these three points are so far removed from one another in the narrative that the conclusion would hold, even if the general arrangement in St Mark were only roughly, and not minutely, chronological. On the other hand, it may be true that an impression of a briefer period of ministry naturally results, and in early generations did actually result, from the synoptic account considered as a whole.

(b) *Evidence of St Luke's Gospel* (ix. 51-xix. 28 compared with iv. 14-ix. 50; iv. 10).—Still stronger is the impression of brevity suggested by St Luke. The second and larger half of the narrative of the ministry is introduced at ix. 51 with the words, "It came to pass as the days of His assumption were coming to the full, He set His face firmly to go to Jerusalem," under which phrase the evangelist cannot have meant to include more than a few months, perhaps not more than a few weeks; so that even if the earlier and shorter half of the account, which describes a purely Galilean ministry ("Judaea" in iv. 44, if it is the true reading, means Judaea in the sense of Palestine), is to be spread over a longer period of time, the combined narrative can hardly have been planned on the scale of more than a single year. St Luke himself may have understood literally, like so many of his readers in ancient times, the reference which he records to the "acceptable year of the Lord" (iv. 19=Isaiah lxi. 2): see, too, above, 3 (a) *ad fin.*

(c) *Evidence of St John's Gospel* (ii. 13, "the Passover of the Jews was near"; and 23, "He was in Jerusalem at the Passover at the feast"; v. 1, "after these things was a feast [or 'the feast'] of the Jews"; vi. 4, "and the Passover, the feast of the Jews, was near"; vii. 2, "and the feast of the Jews, the Tabernacles, was near"; x. 22, "at that time the feast of dedication took place at Jerusalem"; xi. 55, "and the Passover of the Jews was near"; besides iv. 35, "say ye not that there is yet a period of four months and harvest cometh? behold, I tell you, lift up your eyes and see the fields that they are white to harvest"). This catena of time-references is of course unique in the Gospels as a basis for a chronology of the ministry; and it is not reasonable to doubt (with Loisy, *loc. cit.*), who suggests that the aim was to produce an artificial correspondence of a three and a half years' ministry with the half-week of Daniel; but many and diverse as are the early interpretations of Daniel's seventy weeks, no one before Eusebius thought of connecting the half-week with the ministry; that the evangelist intended these notices as definite historical data, possibly for the correction of the looser synoptic narratives and of the erroneous impressions to which they had given rise. Unfortunately, difficulties, either (i.) of reading, or (ii.) of interpretation, or (iii.) of arrangement, have been raised with regard to nearly all of them; and these difficulties must be briefly noticed here.

(i.) *Readings* (a) v. 1, $\beta\omicron\rho\eta$ A B D, Origen, Epiphanius, Chrysostom, *Paschal Chronicle*; η $\beta\omicron\rho\eta$ Σ CLD 1-118, 33, the Egyptian versions, Eusebius, Cyril-Alex. (Irenaeus?). The balance of internal evidence—copyists being more likely to accentuate than to diminish the precision of a note of time—inclines, like the balance of external evidence, against the article. (b) vi. 4, $\tau\omicron$ $\sigma\alpha\alpha\chi\alpha$ is read by all known MSS. and versions; but it has been argued by Hort (in Westcott's and Hort's *New Testament in Greek*, appendix, pp. 77-81) that four ancient authorities omitted the words, and that their omission

simplifies the whole chronology, since "the feast" which was "near" in vi. 4 would then be identical with the feast of Tabernacles mentioned in vii. 2, and all the time-notices of the Gospel could be arranged to fall within the space of a single year, between the Passover of ii. 13 and the Passover of xi. 55. But of the four authorities alleged, Irenaeus (ii. xxiii. 3 [xxxiii. 1]) and the Alogi (*ap. Epiphanius, Haer.* li. 22) were giving catalogues of Passovers "observed" by Christ (at Jerusalem), and therefore naturally omitted a mere Chronological reference like vi. 4; Cyril of Alexandria, in so far as his evidence is adverse to the words, appears to be incorporating a passage from the *Commentary* of Origen, not extant *in loc.*; and the only writer who perhaps really did omit the words—with the view, no doubt, of reconciling the witness of the fourth Gospel with the then widely spread tradition of the single-year ministry—is Origen himself.

(ii.) *Interpretation* (a) iv. 35: which is to be taken literally, the "four months to harvest" (about January), or the "fields white to harvest" (about May)? It does not seem possible to rule out either interpretation; the choice between them will follow from the view taken of the general chronological arrangement of the Gospel. (b) v. i.: if "the feast" is read, a choice remains between Passover and Tabernacles (the definite article would not be very definite after all); if the more probable "a feast," the greater feasts are presumably excluded, but a choice remains between, at any rate, Pentecost (May), Trumpets (September), Dedication (December) and Purim (February). Here again the decision will follow on the general chronological arrangement which may be adopted.

(iii.) *Arrangement*.—So far the amount of possible latitude left is not great as to obscure the main outline of the chronology. For a first (ii. 13, 20), second (vi. 4), and third (xi. 55) Passover are established, with two indeterminate notices (iv. 35, v. 1) between the first and second, and two determinate notices (vii. 2 Tabernacles in October, x. 22 Dedication in December) between the second and third. But of late years an increasing desire has been manifested, especially in Germany and America, to manipulate the fourth Gospel on grounds of internal evidence, at first only in the way of particular transpositions of more or less attractiveness, but latterly also by schemes of thorough-going rearrangement. The former class of proposals will, as a rule hardly affect the chronology of the Gospel; the latter will affect it vitally. The distinction here drawn may be illustrated from the earliest instance of the former and one of the latest of the latter. In 1871 Archdeacon J. P. Norris (*Journal of Philology*) wished to transpose chapters v. and vi.—ch. vi. was, like ch. xxi., a Galilean appendix, and was inserted by mistake at somewhat too late a point in the body of the Gospel—and to read "the feast" in v. 1, identifying it with the Passover which was near in vi. 4; in any case, whether "the feast" = Passover, or "a feast" = Pentecost, were read in v. 1, the transposition would not affect the two years' ministry. In 1900 Professor B. W. Bacon (*American Journal of Theology*, p. 770) proposed a rearrangement of the whole Gospel, according to which the time-notices would occur in the following order: vi. 4, Passover is near; iv. 35, the fields white to harvest = May; v. 1, "a feast" = Pentecost; vii. 2, Tabernacles; x. 22, Dedication; xi. 55, Passover is near; xii. 1, Jesus at Bethany six days before Passover; ii. 13, Passover is near and Jesus goes up to Jerusalem (ii. 23, an interpolation) for the Passover of the Crucifixion; and the ministry would thus be reduced to a single year. Such a scheme does not lend itself to discussion here; but as far as evidence is at present obtainable, the conclusion that the fourth evangelist drew up his narrative on the basis of a two years' rather than a one year's ministry appears to be irrefragable.

Not only do the fourth and second Gospels thus agree in indications of a two years' ministry, but the notes of the middle spring of the three (John vi. 4; Mark vi. 39) both belong to the feeding of the 5000, one of the few points of actual contact between the two Gospels.

The question, however, may still be raised, whether these time-indications of the two Gospels are exhaustive, whether (that is) two years, and two years only, are to be allotted to the ministry. Irenaeus (ii. xxii. 3-6 [xxxiii. 1-4]), in favour of a ministry of not less than ten years, appeals (1.) to the tradition of Asia Minor; (2.) to the record in St John that Christ, who was thirty years old at the time of his baptism, was addressed by the Jews as "not yet [i.e. nearly] fifty years old"; but both his arguments are probably derived from a single source, Papias's interpretation of John viii. 57. With this exception, however, all ancient writers, whether they enumerated two or three or four Passovers in the Gospel history, believed that the enumeration was exhaustive; and their belief appears correctly to represent the mind of the author of the Fourth Gospel, seeing that his various notes of time were probably in intentional contrast to the looser synoptic accounts. Moreover, the wide currency in early times of the tradition of the single-year ministry (Ptolemaeus,

ap. Iren, *loc. cit.*; *Clementine Homilies*, xvii. 19; Clem. Alex. *Strom.* i. 145, vi. 279; Julius Africanus, *ap. Routh, Rel. Sacr.* ii. 240, 306; Hippolytus, *Paschal Cycle and Chronicle*; Origen, in *Levit. Hom.* ix. 5, *de Principiis*, iv. 5) becomes more difficult to account for the farther it is removed from the actual facts.

5. The date of the Crucifixion.

(a) *The Roman Governor.*—Pontius Pilate was on his way back to Rome, after ten years of office, when Tiberius died on the 16th March A.D. 37 (Josephus, *Ant.* xviii. ii. 2, iv. 2). Luke xiii. 1, xxiii. 12, show that he was not a newcomer at the time of the Crucifixion. For the Crucifixion "under Pontius Pilate" the Passover of A.D. 28 is therefore the earliest possible and the Passover of A.D. 36 the latest.

(b) *The Jewish High-Priest.*—Caiaphas was appointed before Pilate's arrival, and was deposed at a Passover apparently not later than that of the year of Herod Philip's death, A.D. 34 (Josephus, *Ant.* xviii. ii. 2, iv. 3-v. 3). The Crucifixion at some previous Passover would then fall not later than A.D. 33.

(c) *The Day of the Week.*—The Resurrection on "the first day of the week" (Sunday) was "on the third day" after the Crucifixion; and that "the third day" implies an interval of only two days hardly needed to be shown, but has been shown to demonstration in Field's *Notes on the Translation of the New Testament* (on Matt. xvi. 21). The Crucifixion was therefore on a Friday in some year between A.D. 28 and 33 inclusive.

(d) *The Day of the Jewish Month Nisan.*—The Passover was kept at the full moon of the lunar month Nisan, the first of the Jewish ecclesiastical year; the Paschal lambs were slain on the afternoon of the 14th Nisan, and the Passover was eaten after sunset the same day—which, however, as the Jewish day began at sunset, was by their reckoning the early hours of the 15th Nisan; the first fruits (of the barley harvest) were solemnly offered on the 16th. The synoptic Gospels appear to place the Crucifixion on the 15th, since they speak of the Last Supper as a Passover;¹ St John's Gospel, on the other hand (xiii. 1, 29, xviii. 28), distinctly implies that the feast had not yet taken place, and thus makes the Crucifixion fall on the 14th. Early Christian tradition is unanimous on this side; either the 14th is mentioned, or the Crucifixion is made the antitype of the slaughter of the Paschal Lamb (and the Resurrection of the first fruits), in the following authorities anterior to A.D. 235: St Paul, 1 Cor. v. 7, xv. 20; Quartodecimans of Asia Minor, who observed the Christian Pascha on the "14th," no matter on what day of the week it fell; Claudius Apollinaris, Clement of Alexandria, Hippolytus, all three quoted in the *Paschal Chronicle*; Irenaeus (apparently) iv. x. 1 [xx. 1]; [Tertullian] *adv. Iudaeos*, 8; Africanus, in *Routh, Rel. Sacr.* ii. 297. The Crucifixion, then, should be placed rather on the 14th than on the 15th of Nisan.

These four lines of inquiry have shown that the Crucifixion fell on Friday, Nisan 14 (rather than 15), in one of the six years 28-33 A.D.; and therefore, if it is possible to discover (i.) exactly which moon or month was reckoned each year as the moon or month of Nisan, and (ii.) exactly on what day that particular moon or month was reckoned as beginning, it will, of course, be possible to tell in which of these years Nisan 14 fell on a Friday. To neither question can an answer be given in terms so precise as to exclude some latitude, but to both with sufficient exactness to rule out at once three of the six years. (i.) The difficulty with regard to the month is to know how the commencement of the Jewish year was fixed—in what years an extra month was intercalated before Nisan. If the Paschal full moon was, as in later Christian times, the first after the spring equinox, the difficulty would be reduced to the question on what day the equinox was reckoned. If, on the other hand, it was, as in ancient Jewish times, the first after the earliest ears of the barley harvest would be ripe, it would have varied with the forwardness or backward-

ness of the season from year to year. (ii.) The difficulty with regard to the day is, quite similarly, to know what precise relation the first day of the Jewish month bore to the astronomical new moon. In later Christian times the Paschal month was calculated from the astronomical new moon; in earlier Jewish times all months were reckoned to begin at the first sunset when the new moon was visible, which in the most favourable circumstances would be some hours, and in the most unfavourable three days, later than the astronomical new moon.

Direct material for answering the question when and how far astronomical calculations replaced simple observations as the basis of the Jewish calendar is not forthcoming. Jewish traditions represented the Sanhedrin as retaining to the end its plenary power over the calendar, and as still fixing the first day of every month and the first month of every year. But as it is quite inconceivable that the Jews of the Dispersion should not have known beforehand at what full moon they were to present themselves at Jerusalem for the Passover, it must be assumed as true in fact, whether or no it was true in theory, that the old empirical methods must have been qualified, at least partially, by permanent, that is in effect by astronomical rules. Exactly what modifications were first made in the system under which each month began by simple observation of the new moon we do not know, and opinions are not agreed as to the historical value of the rabbinical traditions; but probably the first step in the direction of astronomical precision would be the rule that no month could consist of less than twenty-nine or more than thirty days—to which appears to have been added, but at what date is uncertain, the further rule that Adar, the month preceding Nisan, was always to be limited to twenty-nine. In the same way the beginning of the Jewish year according to the state of the harvest was supplanted by some more fixed relation to the solar year. But this relation was not, it would seem, regulated by the date, real or supposed, of the equinox. Christian controversialists from Anatolius of Laodicea (A.D. 277) onwards accused the Jews of disregarding the (Christian) equinoctial limit, and of sometimes placing the Paschal full moon before it; and it is possible that in the time of Christ the 14th of Nisan might have fallen as far back as the 17th of March. In the following table the first column gives the *terminus paschalis*, or 14th of the Paschal moon, according to the Christian calendar; the second gives the 14th, reckoned from the time of the astronomical new moon of Nisan; the third the 14th, reckoned from the probable first appearance of the new moon at sunset. Alternative moons are given for A.D. 29, according as the full moon falling about the 18th of March is or is not reckoned the proper Paschal moon.

A.D. 28	Sat. Mar. 27	Mar. 28	Mar. 30
" 29	Th. Mar. 17	Mar. 17	Mar. 19
	F. Ap. 15	Ap. 16	Ap. 18
" 30	Tu. Ap. 4	Ap. 5	Ap. 7
" 31	Sat. Mar. 24	Mar. 25	Mar. 27
" 32	Sat. Ap. 12	Ap. 12	Ap. 14
" 33	W. Ap. 1	Ap. 1-2	Ap. 3 or 4.

It will be seen at once that Friday cannot have fallen on Nisan 14th in any of the three years A.D. 28, 31 and 32. The choice is narrowed down to A.D. 29, Friday, 18th March (Friday, 15th April, would no doubt be too early even for the 14th of Nisan); A.D. 30, Friday 7th April; and A.D. 33, Friday, 3rd April.

(e) *The Civil Year* (consuls, or regnal years of Tiberius) in early Christian tradition. It is not *a priori* improbable that the year of the central event from which the Christian Church dated her own existence should have been noted in the apostolic age and handed down to the memory of succeeding generations; and the evidence does go some way to suggest that we have in favour of A.D. 29, the consulate of the two Gemini (15th or 16th year of Tiberius), a body of tradition independent of the Gospels and ancient, if not primitive, in origin.

The earliest witness, indeed, who can be cited for a definite date for the crucifixion gave not 29, but 33 A.D. The pagan chronicler, Phlegon, writing in the reign of Hadrian, noted under Olympiad 202.4 (= A.D. 32-33), besides a great earthquake in Bithynia, an eclipse so remarkable that it became night

¹ If the Passover celebration could be anticipated by one day in a private Jewish family (and we know perhaps too little of Jewish rules in the time of Christ to be able to exclude this possibility), the evidence of the synoptic Gospels would no longer conflict with that of St John.

"at the sixth hour of the day." The eclipse meant is, presumably, that of the Crucifixion (so Origen, *contra Celsum*, ii. 33 [but see in *Matt.* 13.41, Delarue iii. 922], Eusebius's *Chronicle* Tib. 19 [= A.D. 33], Anon. in Cramer's *Catena in Matt.* p. 237), but as the notice of it was clearly derived by Phlegon, pagan as he was, directly or indirectly from the Gospel narrative, there is no reason at all to ascribe any independent value to the date. Phlegon may have had grounds for dating the Bithynian earthquake in that year, and have brought the dateless portent into connexion with the dated one. Eusebius adopted and popularized this date, which fell in with his own system of Gospel chronology, but of the year 33 as the date of the Passion there is no vestige in Christian tradition before the 4th century.

The only date, in fact, which has any real claim to represent Christian tradition independent of the Gospels, is the year 29. Tiberius 15 is given by Clem. Alex. *Strom.* i. 147; Origen, *Hom. in Jerem.* xiv. 13; cf. *c. Cels.* iv. 22. Tiberius 16 by Julius Africanus (Routh, *Rel. Sac.* ii. 301-304), and pseudo-Cyprian *de pascha computus* (A.D. 243), § 20. The consulship of the two Gemini by Lactantius, *Div. Inst.* iv. x. 18, and (Lactantius?) *de morte pers.* § 2; the consulship of the two Gemini = Tiberius 18 by Hippolytus, *Comm. in Daniele*, iv. (ed. Bonwetsch, p. 242); the consulship of the two Gemini = Tiberius 15 by [Tertullian] *adv. Iudaeos*, § 8; the consulship of the two Gemini = Tiberius 15 (*al.* 18 or 19) = Ol. 202.4 [this last is a later interpolation from Eusebius] in the *Acts of Pilate*. Other methods of expressing the year 29 appear in Hippolytus's *Paschal Cycle and Chronicle*, and in the Abgar legend (*ap. Eusebius, H.E.* i. 13). No doubt it would be possible to explain Tiberius 16 as a combination of Luke iii. 1 with a one-year ministry, and even to treat Tiberius 15 as an unintelligent repetition from St Luke—though the omission to allow a single year for the ministry would be so strange as to be almost unintelligible—but the date by the consuls has an independent look about it, and of its extreme antiquity the evidence gives two indications: (i.) Hippolytus's Commentary on Daniel (now generally dated c. A.D. 200) combines it with an apparently inconsistent date, Tiberius 18; the latter is clearly his own combination of the length of the ministry (he says in the same passage that Christ suffered in his 33rd year) with Luke iii. 1—the consulship must have been taken from tradition without regard to consistency; (ii.) the names of the Gemini are divergently given in our oldest authorities; in [Tert.] *adv. Iudaeos* correctly as Rubellius Geminus and Fufius (or Rufus) Geminus, but in Hippolytus and the *Acts of Pilate* as Rufus and Rubellio. But if the tradition of the consulship was thus, it would seem, already an old one about the year 200, there is at least some reason to conclude that trustworthy information in early Christian circles pointed, independently of the Gospels, to the year 29 as that of the Crucifixion.

(f) *The Civil Month and Day.*—The earliest known calculations, by Basilidian Gnostics, quoted in Clem. Alex. *Strom.* i. 147, gave alternative dates, Phamenoth 25, Pharmuthi 25, Pharmuthi 19; that is, according to the fixed Alexandrine calendar of B.C. 26, 21st March, 20th April, 14th April; in the older, not wholly superseded, Egyptian calendar the equivalents with Roman days varied from year to year. But in all probability these dates were only one development of those speculations in the region of numbers to which Gnosticism was so prone; and in any case to look for genuine traditions among Egyptian Gnostics, or even in the church of Alexandria, would be to misread the history of Christianity in the 2nd century. Such traditions must be found, if anywhere, in Palestine and Syria, in Asia Minor, in Rome, not in Egypt; within the Church, not among the Gnostics. The date which makes the most obvious claim to satisfy these conditions would be the 25th of March, as given by Hippolytus, [Tert.] *adv. Iudaeos*, and the *Acts of Pilate* (according to all extant MSS. and versions, but see below), *loc. cit.*—the same three authorities who bear the earliest witness for the consuls of the year of the Crucifixion—and by many later writers. It cannot be correct, since no full moon occurs near it in any of the possible years; yet it must be

very early, too early to be explained with Dr Salmon (*Dictionary of Christian Biography*, iii. 92b), as originated by Hippolytus's Paschal cycle of A.D. 221. Now Epiphanius (*Haer.* i. 1) had seen copies of the *Acts of Pilate* in which the day given was not 25th March, but *a.d. xv. kal. Apr.* (=18th March); and if this was the primitive form of the tradition, it is easy to see how 25th March could have grown out of it, since the 18th would from comparatively early times, in the East at any rate, have been thought impossible as falling before the equinox, and no substitution would be so natural as that of the day week, Friday, 25th March. But Friday, 18th March, A.D. 29, was one of the three alternative dates for the Crucifixion which on astronomical and calendar grounds were found (see above, *sd*) to be possible.

Thus A.D. 29 is the year, the 18th of March is the day, to which Christian tradition (whatever value, whether much or little, be ascribed to it) appears to point. Further, the Baptism was tentatively placed in A.D. 26-27; the length of the ministry was fixed, with some approach to certainty, at between two and three years, and here too the resultant date for the Crucifixion would be the Passover of A.D. 29.

To sum up: the various dates and intervals, to the approximate determination of which this article has been devoted, do not claim separately more than a tentative and probable value. But it is submitted that their harmony and convergence give them some additional claim to acceptance, and at any rate do something to secure each one of them singly—the Nativity in 7-6 B.C., the Baptism in A.D. 26-27, the Crucifixion in A.D. 29—from being to any wide extent in error.

The Chronology of the Apostolic Age.

The chronology of the New Testament outside the Gospels may be defined for the purposes of this article as that of the period between the Crucifixion in A.D. 29 (30) on the one hand, and on the other the persecution of Nero in A.D. 64 and the fall of Jerusalem in A.D. 70. Of the events in Christian history which fall between these limits it must be admitted that there are many which with our present information we cannot date with exactness. But the book of Acts, our only continuous authority for the period, contains two synchronisms with secular history which can be dated with some pretence to exactness and constitute fixed points by help of which a more or less complete chronology can be constructed for at least the latter half of the apostolic age. These are the death of Herod Agrippa I. (xii. 23) and the replacement of Felix by Festus (xxiv. 27).

1. The death of Herod Agrippa I. This prince, son of Aristobulus and grandson of Herod the Great, was made (i.) king over the tetrarchy which had been Herod Philip's, "not many days" after the accession of Gaius, 16th of March A.D. 37; (ii.) ruler of the tetrarchy of Antipas, in A.D. 39-40; (iii.) ruler of the whole of Palestine (with Abilene), on the accession of Claudius at the beginning of A.D. 41. Josephus's *Jewish Wars* and *Antiquities* differ by one in the number of years they allot to his reign over the tetrarchies (the former work says three years, the latter four), but agree in the more important *datum* that he reigned three years more after the grant from Claudius, which would make the latest limit of his death the spring of A.D. 44. The *Antiquities* also place his death in the seventh year of his reign, which would be A.D. 43-44. On the other hand, coins whose genuineness there is no apparent reason to doubt are extant of Agrippa's ninth year; and this can only be reconciled even with A.D. 44 by supposing that he commenced reckoning a second year of his reign on Nisan 1, A.D. 37, so that his ninth would run from Nisan 1, A.D. 44. On the balance of evidence the only year which can possibly reconcile all the data appears to be A.D. 44 after Nisan, so that it will have been at the Passover of that year that St Peter's arrest and deliverance took place.

After Agrippa's death Judaea was once more governed by procurators, of whom Cuspius Fadus and Tiberius Alexander ruled from A.D. 44 to 48; the third, Cumanus, was appointed in A.D. 48; and the fourth, Felix, in A.D. 52. Under Tiberius

Alexander, *i.e.* in A.D. 46 or 47, occurred the great famine which Agabus had foretold, and in which the Antiochene church sent help to that of Jerusalem by the ministry of Barnabas and Saul (Acts xi. 30. xii. 25). Thus the earliest date at which the commencement of the first missionary journey (Acts xiii. 4) can be placed is the spring of A.D. 47. The journey extended from Salamis "throughout the whole island" of Cyprus as far as Paphos, and on the mainland from Pamphylia to Pisidian Antioch, Iconium, Lystra and Derbe, at each of which places indications are given of a prolonged visit (xiii. 49, xiv. 3, 6, 7, 21). The same places were visited in reverse order on the return journey, as far as Perga on the Pamphylia coast; but instead of revisiting Cyprus the voyage to Syria was this time made direct. In estimating the length of time occupied by this first missionary journey, it must be remembered that a sea voyage could never have been undertaken, and land travel only rarely, during the winter months, say November to March; and as the amount of the work accomplished is obviously more than could fall within the travelling season of a single year, the winter of 47-48 must have been spent in the interior, and return to the coast and to Syria made only some time before the end of autumn A.D. 48. The succeeding winter, at least, was spent again at Antioch of Syria (xiv. 28). The council at Jerusalem of Acts xv. will fall at earliest in the spring of A.D. 49, and as only "certain days" were spent at Antioch after it (xv. 36) the start on the second missionary journey might have been made in the (late) summer of the same year. The "confirmation" of the existing churches of Syria and Cilicia, and of those of the first journey beginning with Derbe (xv. 41, xvi. 5), cannot have been completed under several months, nor would the Apostle have commenced the strictly missionary part of the journey in districts not previously visited, before the opening of the travelling season of A.D. 50. No delay was then made on the Asiatic side; it may still have been in spring when St Paul crossed to Europe and began the course of preaching at Philippi, Thessalonica, Berea and Athens which finally brought him to Corinth. The stay of eighteen months at the last-named place (xviii. 11) will naturally begin at the end of one travelling season and end at the beginning of another, *i.e.* from the autumn of A.D. 50 to the spring of A.D. 52. From Corinth the Apostle went to Jerusalem to "salute the church," and then again to Antioch in Syria, where he stayed only for "a time" (xviii. 22), and soon left—on the third missionary journey, as conventionally reckoned—"proceeding "in order" through the churches of the interior of Asia Minor. These journeys and the intervening halts must have occupied seven or eight months, and it must have been about the end of the year when St Paul established his new headquarters at Ephesus. The stay there lasted between two and three years (xix. 8, 10, xx. 31), and cannot have terminated before the spring of A.D. 55. From Ephesus he went into Europe, and after "much teaching" given to the churches of Macedonia (xx. 2), spent the three winter months at Corinth, returning to Philippi in time for the Passover (xx. 3, 6) of A.D. 56. Pentecost of the same year was spent at Jerusalem, and there St Paul was arrested, and kept in prison at Caesarea for two full years, until Festus succeeded Felix as governor (xx. 16, xxiv. 27), an event which, on this arrangement of the chronology of the missionary journeys, would therefore fall in A.D. 58.

Care, however, must be taken to remember exactly what this line of argument amounts to—what it can fairly be said to have proved, and what it still leaves open. It has been shown, firstly, that the missionary journeys cannot have commenced before the spring of A.D. 47, and, secondly, that between their commencement and the end of the two years' imprisonment at Caesarea not less than eleven full years must have elapsed. Consequently A.D. 58 appears to be the earliest date possible for the arrival of Festus. On the other hand, a later date for Festus is not absolutely excluded. It is possible that the first missionary journey should be placed in A.D. 48 instead of A.D. 47; and it is possible, though not probable, that the missionary journeys should be spread over one year more than has been suggested above. At any rate, then, the alternative is open that every

date given above, from A.D. 47 to A.D. 58, should be moved on one year, with the result of placing Festus's arrival in A.D. 59.

It is now time to run to the direct evidence for the date of Festus's arrival as procurator, in order to test by it the result already tentatively obtained.

2. The replacement of Felix by Festus. This is the pivot date of St Paul's later life, but unfortunately two schools of critics date it as differently as A.D. 55 and A.D. 60 (or 61). The former are represented by Harnack, the latter by Wieseler, whom Lightfoot follows. It can be said confidently that the truth is between these two extremes (though in what exact year it is not easy to say), as will be evident from a consideration of the arguments urged, which in each case appear less to prove one extreme than to disprove its opposite.

Arguments for the Later Date, A.D. 60 or 61.—(a) St Paul, at the time of his arrest, two years before Felix's recall, addresses him as "for many years past a judge for this nation" (Acts xxiv. 10, 27). It is certain that Felix succeeded Cumanus in A.D. 52, for Tacitus mentions Cumanus's recall under that year, Josephus immediately before the notice of the completion of Claudius's twelfth year [January, A.D. 53], Eusebius probably under Claudius II, that is, between 52 and September 52 (for the meaning of the regnal years in the *Chronica* of Eusebius see the present writer's article in *Journal of Theological Studies*, January 1900, pp. 188-192). It is argued that "many years" cannot mean less than six or seven, so that St Paul must have been speaking at earliest in 58 or 59, and Felix will have left Judaea at earliest in 60 or 61. But this argument overlooks the fact that Felix had been in some position which might properly be described as that of "judge for this nation" before he became governor of all Palestine in A.D. 52. In the words of Tacitus, Felix was at the time of that appointment *isampridem Iudaea impositus* (*Annals*, xii. 54); he certainly supposes Felix to have been already governor of Samaria, and apparently of Judaea too, and only recognizes Cumanus as governor of Galilee; and Josephus, though he says nothing of this, and treats Cumanus as the sole procurator down to A.D. 52, implies that Felix had been in some position where the Jewish authorities could judge of his fitness when he tells us that the high priest Jonathan used to press on Felix, as a reason for urging him to govern well, the fact he that had asked for his appointment to the procuratorship (*Ant. xx. vii. 5*). If Felix had acted in some position of responsibility in Palestine before 52 (perhaps for some time before), St Paul could well have spoken of "many years" at least as early as 56 or 57.

(b) Josephus enumerates at the accession of Nero (October 54) a long catalogue of events which all took place under the procuratorship of Felix, including the revolt of "the Egyptian" which was already "before these days" at the time of St Paul's arrest, two years from the end of Felix's tenure. This suggests, no doubt, that the Egyptian rebelled at earliest in 54-55, and makes it probable that St Paul's arrest did not take place before (the Pentecost of) A.D. 56; and it implies certainly that the main or most important part of Felix's governorship fell, in Josephus's view, under Nero. But as two years only of Felix's rule (52-54) fell under Claudius, this procedure would be quite natural on Josephus's part if his recall were dated in 58 or 59, so that four or five years fell under Nero. And there is no need at all to suppose that all the incidents which the historian masses under his account of Felix were successive: events in Emesa, Chalchis, Caesarea and Jerusalem may easily have been synchronous.

The arguments, then, brought forward in favour of A.D. 60 or 61 do not do more than bring the rule of Felix down to 58 or 59.

Arguments for an Early Date, A.D. 55 or 56.—(a) Eusebius's *Chronica* places the arrival of Festus in Nero 2, October 55-56, and Eusebius's chronology of the procurators goes back probably through Julius Africanus (himself a Palestinian) to contemporary authorities like the *Jewish kings* of Justus of Tiberias. But (i.) Nero 2 is really September 56-September 57; (ii.) it is doubtful whether Eusebius had any authority to depend on here other than Josephus, who gives no precise year for Festus—Julius Africanus is hardly probable, since we know that his chronicle was very jejune for the Christian period—and if so, Eusebius had to find a year as best he could.¹

(b) Felix, on his return to Rome, was prosecuted by the Jews for misgovernment, but was acquitted through the influence of his brother Pallas. Pallas had been minister and favourite of Claudius,

¹ Dr C. Erbes (*Texte und Untersuchungen*, new series, iv. 1) attempts to interpret the evidence of Eusebius in favour of the later date for Festus as follows: Eusebius's date for Festus is to be found in Nero 1, by striking a mean between the Armenian, Claudius 12, and the Latin, Nero 2; it is really to be understood as reckoned, not by years of Nero, but by years of Agrippa; and as Eusebius erroneously antedated Agrippa's reign by five years, commencing it with A.D. 43 instead of A.D. 50, his date for Festus is five years earlier, and should be moved to Nero 6, A.D. 59-60. The whole of this theory appears to the present writer to be a gigantic mare's nest: see *Journal of Theological Studies* (October 1901), pp. 120-123.

but was removed from office in the winter following Nero's accession, 54-55. Felix must therefore have been tried at the very beginning of Nero's reign. But this argument would make Felix's recall—if Festus came in summer, as Acts xxv. 1, xxvii. 1, 9, seem to prove—fall actually under Claudius. And, in fact, it would be a mistake to look upon Pallas's retirement as a disgrace. He stipulated that no inquiry should be made into his conduct in office, and was left for another seven years unmolested in the enjoyment of the fortune he had amassed. There is, therefore, every likelihood that he retained for some years enough influence to shield his brother.

Of these arguments, then, the first, so far as it is valid, is an argument for the summer, not of A.D. 55 or 56, but of A.D. 57 as that of the recall, while the second will apply to any of the earlier years of Nero's reign.

In the result, then, the arguments brought forward in favour of each extreme fail to prove their case, but at the same time prove something against the opposite view. Thus the point that Josephus catalogues the events of Felix's procuratorship under Nero cannot be pressed to bring down Felix's tenure as far as 60 or 61, but it does seem to exclude as early a termination as 56, or even 57. Conversely, the influence of Pallas at court need not be terminated by his ceasing to be minister early in 55; but it would have been overshadowed not later than the year 60 by the influence of Poppaea, who in the summer of that year¹ enabled the Jews to win their cause in the matter of the Temple wall, and would certainly have supported them against Felix. Thus the choice again appears to lie between the years 58 and 59 for the recall of Felix and arrival of Festus.

If St Paul was arrested in 56 or 57, and appealed to Caesar on the arrival of Festus in 58 or 59, then, as he reached Rome in the early part of the year following, and remained there a prisoner for two full years, we are brought down to the early spring of either 61 or 62 for the close of the period recorded in the Acts. That after these two years he was released and visited Spain in the west, and in the east Ephesus, Macedonia, Crete, Troas, Miletus, and perhaps Achaëa and Epirus, is probable, in the one case, from the evidence of Romans xv. 28, Clem. *ad Cor.* v. and the Muratorian canon, and, in the other, from the Pastoral Epistles. These journeys certainly cannot have occupied less than two years, and it is more natural to allow three for them, which takes us down to 64-65.

Early evidence is unanimous in pointing to St Peter and St Paul as victims of the persecution of Nero (Clem. *ad Cor.* v. vi., Dionysius of Corinth *ap. Eus. H. E.* ii. 25, &c., combined with what we know from Tacitus of the course of the persecution, and from Gaius of Rome, *ap. Eus. H. E.* ii. 25, of the burial-places of the two apostles); and tradition clearly distinguished the fierce outbreak at Rome that followed on the fire of the city in July 64 from any permanent disabilities of the Christians in the eye of the law which the persecution may have initiated. There is, therefore, no reason at all to doubt that both apostles were martyred in 64-65, and the date serves as a confirmation of the chronology adopted above of the imprisonment, release and subsequent journeys of St Paul.

Investigation, then, of that part of the book of Acts which follows the death of Agrippa, recorded in chap. xii.—*i. e.* of that part of the apostolic age which follows the year 44—has shown that apparent difficulties can be to a large extent set aside, and that there is nowhere room between A.D. 44 and 64 for doubt extending to more than a single year. The first missionary journey may have begun in 47 or 48; the arrival of Festus may have taken place in the summer of 58 or of 59; the two years of the Roman imprisonment recorded in the last chapter of Acts may have ended in the spring of 61 or 62; and the dates which fall in between these extremes are liable to the same variation. The present writer leans to the earlier alternative in each case, 47, 58, 61; but he willingly concedes that the evidence, as he understands it, is not inconsistent with the later alternative.

But if the events of A.D. 44-64 can thus be fixed with a fair approximation to certainty, it is unfortunately otherwise with the events of A.D. 29-44. Here we are dependent (*i.*) on general

indications given in the Acts; (*ii.*) on the evidence of the Epistle to the Galatians, which, though in appearance more precise, can be and is interpreted in very different ways.

(*i.*) The book of Acts is divided, by general summaries from time to time inserted in the narrative, into six periods: 1. i-vi. 7, vi. 8-ix. 31, ix. 32-xii. 24, xii. 25-xvi. 5, xvi. 6-xix. 20, xix. 21-xxviii. 31. Of these the three last extend respectively from the death of Herod to the start for Europe in the second missionary journey (A.D. 44 to the spring of 50 [51]), from the start for Europe to the end of the long stay at Ephesus (A.D. 50 [51] to the spring of A.D. 55 [56]), and from the departure from Ephesus to the end of the two years' captivity at Rome (A.D. 55 [56] to the beginning of A.D. 61 [62]). It will be seen that these periods are of more or less the same length, namely, six (or seven) years, five years, six years. There is, therefore, some slight presumption that the three earlier periods, which together cover about fifteen years, were intended by so artistic a writer as St Luke to mark each some similar lapse of time. If that were so, the preaching of the apostles at Jerusalem and organization of the Church at the capital—the preaching of the seven and the extension of the Church all over Palestine—the extension of the Church to Antioch and the commencement of St Paul's work—might each occupy five years more or less, that is to say, roughly, A.D. 29-34, 34-39, 39-44. The conversion of St Paul, which falls within the second period, would on this arrangement fall somewhere between five and ten years after the Crucifixion. Such conclusions are, however, of course general in the extreme.

(*ii.*) A nearer attempt to date at least the chronology of St Paul's earlier years as a Christian could be made by the help of the Galatian Epistle if we could be sure from what point and to what point its reckonings are made. The apostle tells us that on his conversion he retired from Damascus into Arabia, and thence returned to Damascus; then after three years (from his conversion) he went up to Jerusalem, but stayed only a fortnight, and went to the regions of Syria and Cilicia. Then after fourteen years (from his conversion? or from his last visit?) he went up to Jerusalem again to confer with the elder apostles. Now, if either of these visits to Jerusalem could be identified with any of the visits whose dates have been approximately settled in the chronology of A.D. 44-64, we should have a fixed point from which to argue back. Unfortunately, even less agreement exists on this head than on the question whether the fourteen years of the last-mentioned visit are to be reckoned from the conversion or from the previous visit. Most critics, indeed, are now agreed that the fourteen years are to be calculated from the conversion; and most of them still hold that the visit of Galatians ii. is the same as the council of Acts xv., partly, no doubt, on the ground that the latter visit was too important and decisive for St Paul to have omitted in giving even the most summary description of his relations with the twelve. This ground would, however, be cut away from their feet if it were possible to hold (with J. V. Bartlet, *Apostolic Age*, 1900, and V. Weber, *Die Abfassung des Galaterbriefs vor dem Apostelkonzil*, Ravensburg, 1900) that the epistle was actually written just before the council, *i. e.* in the winter of 48-49 [49-50]. In that case, of course, the two visits of Galatians i. and ii. would be those of Acts ix. 26 and xi. 30. The fourteen years reckoned back from the latter (*c. A. D.* 46) would bring us to A.D. 32-33 as the latest possible date for the conversion. With the older view, on the other hand, the fourteen years reckoned from the council in A.D. 49 [50] would allow us to bring down the conversion to A.D. 36. The new view clears away some manifest difficulties in the reconciliation of the Epistle and the Acts, and the early date for Galatians in relation to the other Pauline epistles is not so improbable as it may seem; but the chronology still appears more satisfactory on the older view, which enables the conversion to be placed at least three years later than on the alternative theory. But it is clear that the last word has not been said, and that definite results for this period cannot yet be looked for.

To sum up: an attempt has been made, it is hoped with some success, to provide a framework of history equipped with dates from the time of St Peter's arrest by Herod Agrippa I. at the

¹ This date appears to be satisfactorily established by Ramsay, "A Second Fixed Point in the Pauline Chronology," *Expositor*, August 1900.

Passover of A.D. 44 down to the martyrdom of St Peter and St Paul in the persecution of Nero, A.D. 64-65. For the previous period, on the other hand, from A.D. 20 to A.D. 44, it appeared impossible in our present state of knowledge to state conclusions other than in the most general form.

AUTHORITIES.—The views stated in this article are in general (though with some modifications) the same as those which the present writer worked out with more fulness of detail in Hastings' *Dictionary of the Bible*, i. (1898) 403-424. Of older books should be mentioned:—*Idele, Handbuch der mathematischen und technischen Chronologie* (2 vols., 1825); Wieseler, *Chronologie des apostolischen Zeitalters* (1848); Lewin's *Fasti Sacri* (1865). Important modern contributions are to be found in Prof. (Sir) W. M. Ramsay's various works, and in Harnack's *Chronologie der altchristlichen Literatur bis Eusebius*, i. 233-244. Mention should also be made of an article, containing much useful astronomical and Talmudical information, by Mr J. K. Fotheringham, "The Date of the Crucifixion," in the *Journal of Philology*, xxix. 100-118 (1904). Mr Fotheringham is of opinion that the evidence from Christian sources is too uncertain, and that the statements of the Mishnah must be the starting-point of the inquiry; taking then the phase of the new moon as the true beginning of Nisan, he concludes that Friday cannot have coincided with Nisan 14 in any year, within the period A. D. 28-35, other than A. D. 33 (April 3rd). But in one of the two empirical tests of the value of these calculations that he was able to obtain (*loc. cit.* p. 106, n. 2), the new moon was seen a day earlier than his rules allowed. This being so, it would be premature to disregard the convergent lines of historical evidence which tell against A.D. 33. Among the latest German works may be cited the chapter on New Testament chronology in the *Neutestamentliche Zeitgeschichte* of Dr Oscar Holtzmann (2nd ed., 1906), pp. 117-147; regarded as a collection of historical material this deserves every praise, but the mass is undigested and the treatment of the evidence arbitrary. As might be expected, Dr Holtzmann's conclusions are clear-cut, and alternatives are rigidly excluded: the Crucifixion is dated on the 7th of April A.D. 30, and St Paul's arrest (with the older writers) at Pentecost A.D. 58. (C. H. T.)

BIBLE, ENGLISH. The history of the vernacular Bible of the English race resolves itself into two distinctly marked periods—the one being that of Manuscript Bibles, which were direct translations from the Latin Vulgate, the other that of Printed Bibles, which were, more or less completely, translations from the original Hebrew and Greek of the Old and New Testaments.

1. *The Manuscript Bible.*—The first essays in Biblical translation, or rather paraphrasing, assumed in English, as in many other languages, a poetical form. Even in the 7th century, according to the testimony of Bede (*Hist. Eccl.* iv. 24), *Cædmon* sang "de creatione mundi et origine humani generis, et tota Genesis historia, de egressu Israel ex Aegypto et ingressu in terram reprobationis, de aliis plurimis sacrae Scripturae historis, de incarnatione Dominica, passione, resurrectione et ascensione in coelum, de Spiritu Sancti adventu, et apostolorum doctrina." It is, however, doubtful whether any of the poetry which has been ascribed to him can claim to be regarded as his genuine work.

The first prose rendering of any part of the Bible—and with these we are mainly concerned in the present inquiry—originated in all probability in the 8th century, when Bede, the eminent scholar and churchman, translated the first portion (chs. i.-vi. 9) of the Gospel of St John into the vernacular, but no part of this rendering is extant. His pupil Cuthbert recorded this fact in a letter to a fellow-student; Cuthwinc: "a capite sancti evangelii Johannis usque ad eum locum in quo dicitur, 'sed haec quid sunt inter tantos?' in nostram linguam ad utilitatem ecclesiae Dei convertit" (Mayor and Lumby, *Bede's Hist. Eccl.* p. 178).

The 9th century is characterized by *interlinear glosses on the Book of Psalms*, and towards its close by a few attempts at independent translation. Of these "glossed Psalters" twelve MSS. are known to exist, and they may be ranged into two groups according to the Latin text they represent. The *Roman Psalter* is glossed in the following MSS.: (1) Cotton Vesp. A. 1 (*Vespasian Psalter*); (2) Bodl. Junius 27; (3) Univ. Libr. Camb. Ff. i. 23; (4) Brit. Mus. Reg. 2. B. 5; (5) Trin. Coll. Camb. R. 17. 1 (*Eadwinc's Psalter*); (6) Brit. Mus. Add. 37517. The *Gallican Psalter* in the following: (1) Brit. Mus. Stowe 2 (Spelman's text); (2) Cotton

Vitell. E. 18; (3) Cotton Tib. C. 16; (4) Lambeth 48; (5) Arundel 60; (6) Salisbury Cath. 150.¹

The oldest and most important of these MSS. is the so-called *Vespasian Psalter*, which was written in Mercia in the first half of the 9th century. It was in all probability the original from which all the above-mentioned Old English glosses were derived, though in several instances changes and modifications were introduced by successive scribes. The first verse of Psalm c. (Vulg. xcix. 2) may serve as a specimen of these glosses.

<i>Roman Text.</i>	<i>Gallican Text.</i>
MS. Vespasian. A. 1.	MS. Stowe. 2.
Wynsumia gode, all eorðe ðrowia Dryhtne in blisse; ingað in geseðe his in wynsumnisse.	Drymað drihtne, eall eorðe; ðrowia drihtne on laetitia; inlarað on geseðe his on blifnesse.
<i>Jubilate Deo, omnis terra; servite Domino in laetitia; intrate in conspectu eius in exultatione.</i>	<i>Jubilate Domino, omnis terra; servite Domino in laetitia; intrate in conspectu eius in exultatione.</i>

To the late 9th or early 10th century a work may be assigned which is in so far an advance upon preceding efforts as to be a real translation, not a mere gloss corresponding word for word with the Latin original. This is the famous *Paris Psalter*,² a rendering of the first fifty Psalms (Vulg. i.-l. 10), contained in the unique MS. lat. 8824 in the Bibliothèque Nationale, Paris. The authorship of this version is doubtful, being by some scholars attributed to King Alfred (d. 901), of whom William of Malmesbury writes (*Gesta Regum Anglorum*, ii. 123), "Psalterium transerre aggressus vix prima parte explicata vivendi finem fecit." This view is, however, denied by others.

In the course of the 10th century the Gospels were glossed and translated. The earliest in date is a *Northumbrian Gloss on the Gospels*, contained in a beautiful and highly interesting MS. variously known as the *Durham Lindisfarne Book*, the *Lindisfarne Gospels*, or the *Book of St Cuthbert* (MS. Cotton, Nero. D. 4). The Latin text dates from the close of the 7th century, and is the work of Eadfrith, bishop of Lindisfarne (668-721). The English gloss was added about a century and a half later (c. 950) by one Aldred, whom Dr Charles O'Connor (*Bibl. Stowensis*, 1818-1819, ii. 180) supposes to have been the bishop of Durham of that name. The Lord's Prayer is glossed in the following way:—

Lindisfarne Gospels.

- Matthew vi. 9. Suae ðonne iuih gie bidde fader ure ðu ær
sic ergo nos orabis + Pater noster qui es
þu bist in heofonum † in heofnas; sic gehalgad noma ðin;
in caelis; † sanctificetur nomen tuum.
(10) to-cymeð ric ðin. sic uillat ðin suae is in heofne
aduentat regnum tuum fiat uoluntas tua sicut in caelo
‡ in eorþe.
et in terra.
(11) hlaf userne oferwistic sel us to dæg.
panem nostrum super-substantiale[m] dā nobis hodie.
(12) J forgef us scylda usra suae uoe forgefom scyldigum
et demitte nobis debita nostra sicut nos dimittimus debitoribus
uisum.
nostris.
(13) J ne inlæd usih in costunge ah gefrig usich from yfe
et ne inducas nos in temptationem sed libera nos a malo.³

¹ See A. S. Cook, *Biblical Quotations in Old English Prose Writers*, with an introduction on *Old English Biblical Versions* (London, 1898-1903), vol. i. pp. xxvi. ff.; H. Sweet, *The Vespasian Psalter in "Oldest English Texts"* (E.E.T.S., No. 83, London, 1885); F. Harsley, *Eadwinc's Canterbury Psalter* (E.E.T.S., No. 92, London, 1892); John Spelman, *Psalterium Davidis Latino-Saxonicum Vetus* (London, 1640); Fr. Roeder, *Der altengl. Regius Psalter* (Reg. II. B. 5), Halle, 1904).

² Benjamin Thorpe, *Libri Psalmorum versio Antiqua Latina cum paraphrasi Anglo-Saxonica* (Oxford, 1835); cf. J. D. Bruce, *The Anglo-Saxon Version of the Book of Psalms* (cf. known as the *Paris Psalter* (Baltimore, 1894).

³ K. W. Bouterwek, *Die vier Evangelien in alt-norð. Sprache* (Gütersloh, 1857); id. *Screadunga* (Elberfeld, 1858, prefaces to the Gospels); J. Stevenson and E. Waring, *The Lindisfarne and Rushworth Gospels* (Surtees Soc., 1854-1865); W. W. Skeat, *The Holy Gospels in Anglo-Saxon, Northumbrian and Old Mercian Versions* (Cambridge, 1871-1887).

Of a somewhat later date is the celebrated *Rushworth Version of the Gospels* (MS. Bodl. Auct. D. ii. 9), which contains an independent translation of the Gospel of St Matthew, and a gloss on those of St Mark, St Luke and St John, founded upon the Lindisfarne glosses. From a note in the manuscript we learn that two men, Færman and Owun, made the version. Færman was a priest at Harewood, or Harwood, in the West Riding of Yorkshire, and to him the best part of the work is due. He translated the whole of St Matthew, and wrote the gloss of St Mark i-ii. 15, and St John xviii. 1-3. The remaining part, a mere transcript, is Owun's work. The dialect of the translation of St Matthew is Mercian.¹

A further testimony to the activity which prevailed in the field of Biblical lore is the fact that at the close of the century—probably about the year 1000—the Gospels were rendered anew for the first time in the south of England. Of this version—the so-called *West-Saxon Gospels*—not less than seven manuscripts have come down to us. A note in one of these, MS. Corpus Christi College, Cambridge, 140, states, *eg Ælfricus scripsi hunc librum in Monasterio Baþenio et deað Britwoldo prepositio*, but of this Ælfric and his superior nothing further is known.²

The Lord's Prayer is rendered in the following way in these gospels:—

West-Saxon Gospels.—MS. Corpus 140.

Matthew vi. 9. Eornustlice gebiddað eow ðus; Fæder ðre þu fe. eart on heofonum; si þin nama gehalgod (10) to-becume þin rice; gewurþe þin willa on eorþan swa swa on heofonum. (11) ðine gedæghwamlican hlaf syle us to dæg, (12) ȝ forgif us ðine gyltas swa swa we forgyfað ðrum gyltendum. (13) ȝ ne gelaed þu us on costnunge ac alyc us of yfele soþlice.

Towards the close of the century the Old Testament found a translator in Ælfric (q.v.), the most eminent scholar in the close of the 10th and the opening decades of the 11th century.

Ælfric. According to his own statement in *De veteri testamento*, written about 1010, he had at that period translated the Pentateuch, Joshua, Judges, Kings, Job, Esther, Judith and the Maccabees.³ His rendering is clear and idiomatic, and though he frequently abridges, the omissions never obscure the meaning or hinder the easy flow of the narrative.

Diétrich, Ælfric's most competent biographer (Niedner's, *Zeitschrift für historische Theologie*, 1855-1856), looks upon the Pentateuch, Joshua and Judges as a continuation of his *Lives of Saints*, including as they do in a series of narratives the Old Testament saints. Genesis is but slightly abridged, but Job, Kings, Judges, Esther and Judith as well as the Maccabees are mere homilies epitomized from the corresponding Old Testament books. Judith is metrical in form.

The 11th century, with its political convulsions, resulting in the establishment of an alien rule and the partial suppression of the language of the conquered race, was unfavourable to literary efforts of any kind in the vernacular. With the exception of Ælfric's late works at the very dawn of the century, we can only record two transcripts of the West-Saxon Gospels as coming at all within the scope of our inquiry.

In the 12th century the same gospels were again copied by pious hands into the Kentish dialect of the period.

The 13th century, from the point of view of Biblical renderings into the vernacular, is an absolute blank. French—or rather the Anglo-Norman dialect of the period—reigned supreme amongst the upper classes, in schools, in parliament, in the courts of law and in the palace of the king. English lurked in farms and hovels, amongst villeins and serfs, in the outlying country-districts, in the distant

monasteries, amongst the lower clergy, amongst the humble and lowly and ignorant. There were certainly renderings of the Bible during the 12th, 13th and early 14th centuries, but they were all in French. Some of these translations were made in England, some were brought over to England and copied and recopied. Amongst the latter was the magnificently illuminated Norman Commentary on the Apocalypse, some of the earliest copies of which were written in an English hand. In fact before the middle of the 14th century the entire Old Testament and the greater part of the New Testament had been translated into the Anglo-Norman dialect of the period. (MSS. Bibl. Nat. fr. i. 9562, Brit. Mus. Reg. I.C. iii. Cf. S. Berger, *La Bible française au moyen âge*, Paris, 1884, pp. 78 ff.)

When English finally emerged victorious, towards the middle and latter half of the 14th century, it was for all practical purposes a new language, largely intermixed with French, differing from the language of the older period in sound, flexion and structure. It is evident that any Old English versions which might have survived the ravages of time would now be unintelligible, it was equally natural that as soon as French came to be looked upon as an alien tongue, the French versions hitherto in use would fail to fulfil their purpose, and that attempts should again be made to render the Bible into the only language intelligible to the greater part of the nation—into English. It was also natural that these attempts should be made where the need was most pressing, where French had gained least footing, where parliament and court were remote, where intercourse with France was difficult. In fact in the Northern Midlands, and in the North even before the middle of the 14th century, the book of Psalms had been twice rendered into English, and before the end of the same century, probably before the great Wycliffite versions had spread over the country, the whole of the New Testament had been translated by different hands into one or other of the dialects of this part of the country.

14th-century renderings.

At the same time we can record only a single rendering during the whole century which originated in the south of England, namely the text of James, Peter, 1 John and the Pauline Epistles (edited by A. C. Paves, Cambridge, 1904).

Of these pre-Wycliffite versions possibly the earliest is the *West Midland Psalter*, once erroneously ascribed to William of Shoreham.⁴ It occurs in three MSS., the earliest of which, Brit. Mus. Add. 17376, was probably written between 1340 and 1350. It contains a complete version of the book of Psalms, followed by the usual eleven canticles and the Athanasian Creed. The Latin original is a glossed version of the Vulgate, and in the English translation the words of the gloss are often substituted for the strong and picturesque expressions of the Biblical text; in other respects the rendering is faithful and idiomatic. The following two verses of the first psalm may exemplify this:—

MS. British Mus. Add. 17376.

(1.) *Beatus uir, qui non abiit in consilio impiorum, & in uia peccatorum non stetit, at in caltropo .i. iudicio pestiferente .i. falsitatis non sedit.* Blessed be man þat sede nouit in be counsel of wickked, ne stode nouit in þe waic of sinȝeres, ne sat nouit in fals iugement. (2.) *Stet in lege domini uoluntas eius, & in lege eius meditabitur die ac nocte.* Ac hijs wulle be in þe wyll of oure Lord, and he schal þenche in hijs lawe boþe daye and nyȝt.

Before the middle of the century Richard Rolle (q.v.), the hermit of Hampole (+ 1349), turned into English, with certain additions and omissions, the famous *Commentary on the Psalms* by Peter Lombard. The work was undertaken, as the metrical prologue of one of the copies tells us (MS. Laud. misc. 286), "At a worthy reclus prayer, cold dame Merget Kyrkby." The Commentary gained immediate and lasting popularity, and spread in numerous copies throughout the country, the peculiarities of the hermit's vigorous northern dialect being either modified or wholly removed in the more

Richard Rolle.

¹ See Stevenson, Waring and Skeat, *op. cit.*

² W. W. Skeat, *The Holy Gospels in Anglo-Saxon, &c.* (Cambridge, 1871-1887); J. W. Bright, *The Gospel of Saint Luke in Anglo-Saxon* (Oxford, 1893); for earlier editions see Cook, *op. cit.*, p. lx.

³ C. W. M. Grein, *Ælfric de veteri et nouo Testamento, &c.*—Bibl. d. Angels. Prosa (Cassel and Göttingen, 1872), p. 6; E. Thwaites, *Heptaetichus. Liber Job, et Euangelium Nicodemii; Anglo-Saxonice* (Oxon., 1698).

⁴ K. D. Bältring, *The Earliest Complete English Prose Psalter* (E.E.T.S., No. 97), part i. (London, 1891); cf. A. C. Paves, *A Fourteenth-Century Engl. Bibl. Version* (Upsala Diss.) (Cambridge, 1902), p. lvi.

southerly transcripts. The translation, however, is stiff and literal to a fault, violating idiomatic usage and the proper order of words in its strict adherence to the Latin. The following brief extracts may exemplify the hermit's rendering and the change the text underwent in later copies.¹

MS. Univ. Coll. 64.

(i. 1.) Niglit man þe whilk
oway þed blouht in þe counsaile
of wicked, and in þe way of
synful stode nocht, & in þe
chaire of pestilens he nocht
sate. (2) Bot in laghe of lord þe
will of him; and in his laghe
he sall thynke day & nyght.

MS. Reg. 18 B. 21.

Blessed is þat man þat
not gone in þe counsell of wicked
men, and in þe weye of synful
men heþ not stonde, and in þe
chaire of pestilence sat not.
2. But in þe lawe of our lorde
is þe will of him; and [in] his
lawe we shall þinke day and
nyght.

Approximately to the same period as these early renderings of the Psalter belongs a version of the *Apocalypse with a Commentary*, the earliest MS. of which (Harleian 874) is written in the dialect of the North Midlands. This Commentary, for a long time attributed to Wycliffe, is really nothing but a verbal rendering of the popular and widely-spread Norman Commentary on the Apocalypse (Paul Meyer and L. Delisle, *L'Apocalypse en Français au XIII^e siècle*, Paris, 1901), which dates back as far as the first half of the 13th century, and in its general tenor represents the height of orthodoxy. The English apocalypse, to judge from the number of MSS. remaining, must have enjoyed great and lasting popularity. Several revisions of the text exist, the later of which present such striking agreement with the later Wycliffite version that we shall not be far wrong if we assume that they were made use of to a considerable extent by the revisers of this version.

To the North Midlands or the North belongs further a complete version of the *Pauline Epistles* found in the unique MS. 32, Corpus Christi College, Cambridge, of the 15th century.

Commentaries on the Gospels of St Matthew, St Mark and St Luke, we are told by the heading in one of the MSS. (Univ. Libr. Camb. II. 2. 12), were also translated into English by "a man of þe north centre." The translation of these Gospels as well as of the Epistles referred to above is stiff and awkward, the translator being evidently afraid of any departure from the Latin text of his original. The accompanying commentary is based on the Fathers of the Church and entirely devoid of any original matter. The opening lines of the third chapter of Matthew are rendered in the following way:—

MS. Camb. Univ. Libr. II. 2. 12.

(iii. 1.) In þo dayes come Iþone baptist prechand in desert of þe Jewry, & seyand, (2) Do þe penaunce; forþwe þe kyngdome of heuene sal come negh. (3) Þis is he of whome it was seide þe Isay þe prophete, sayand, "þe voice of þe cryand in þe desert, reþone 3e þe way of God, right made 3e þe lityl wayes of him." (4) & Iþone his kleþing of þe hoeris of camels, & a gyrdyl of a skyn about his lendys; & his mete was þe locust & hony of þe wode.

A version of the *Acts* and the *Catholic Epistles* completes the number of the New Testament books translated in the northern parts of England. It is found in several MSS. either separately or in conjunction with a fragmentary *Southern Version of the Pauline Epistles*, Peter, James and 1 John in a curiously compiled volume, evidently made, as the prologue tells us, by a brother superior for the use and edification of an ignorant "sister," or woman vowed to religion.² The translation of this, our only southern text, surpasses all previous efforts from the point of view of clearness of expression and idiomatic use of English, and, though less exact, it may be even said in these respects to rank equal with the later or revised Wycliffite version.

Apart from these more or less complete versions of separate books of the Bible, there existed also numerous renderings of the Lord's Prayer, the Ten Commandments, accounts of the Life, Passion and Resurrection of our Lord, translations of the

epistles and gospels used in divine service, and other means of familiarizing the people with Holy Scripture. It was the custom of the medieval preachers and writers to give their own English version of any text which they quoted, not resorting as in later times to a commonly received translation. This explains the fact that in collections of medieval homilies that have come down to us, no two renderings of the Biblical text used are ever alike, not even Wycliffe himself making use of the text of the commonly accepted versions that went under his name.

It is noteworthy that these early versions from Anglo-Saxon times onwards were perfectly orthodox, executed by and for good and faithful sons of the church, and, generally speaking, with the object of assisting those whose knowledge of Latin proved too scanty for a proper interpretation and understanding of the holy text. Thus Richard Rolle's version of the Psalms was executed for a nun; so was in all likelihood the southern version of the epistles referred to above. Again the earliest MS. (Harl. 874) of the Commentary on the Apocalypse gives the owner's name in a coeval hand as "Richard Shepard, presbiter," and the Catholic Epistles of MS. Douce 250³ were probably glossed for the benefit of men in religious orders, if one may judge from a short Commentary to James ii. 2, " & þerfore if any man come into þoure site, þat is, into þoure cumþenye þat beþ Godes religiouse men in what degre so 3e be." Nor do any of the remaining works contain anything but what is strictly orthodox.

It is first with the appearance of Wycliffe (*q.v.*) and his followers on the arena of religious controversy that the Bible in English came to be looked upon with suspicion by the orthodox party within the Church. For it is a well-known fact that Wycliffe proclaimed the Bible, not the Church or Catholic tradition, as a man's supreme spiritual authority, and that he sought in consequence by every means in his power to spread the knowledge of it among the people. It is, therefore, in all likelihood to the zeal of Wycliffe and his followers that we owe the two noble 14th-century translations of the Bible which tradition has always associated with his name, and which are the earliest complete renderings that we possess of the Holy Scriptures into English.⁴

The first of these, the so-called *Early Version*, was probably completed about 1382, at all events before 1384, the year of Wycliffe's death. The second, or *Later Version*, being a thorough revision of the first, is ascribed to the year 1388 by Sir Frederic Madden and the Rev. Joshua Forshall in their edition of these two versions.⁵

It is a matter of uncertainty what part, if any, Wycliffe himself took in the work. The editors of the Wycliffite versions say in the Preface, pp. xv. ff.—"The New Testament was naturally the first object. The text of the Gospels was extracted from the Commentary upon them by Wycliffe, and to these were added the Epistles, the Acts and the Apocalypse, all now translated anew. This translation might probably be the work of Wycliffe himself; at least the similarity of style between the Gospels and the other parts favours the supposition." The Wycliffite authorship of the Commentaries on the Gospels, on which the learned editors base their argument, is, however, unsupported by any evidence beyond the fact that the writer of the Prologue to Matthew urges in strong language "the propriety of translating Scripture for the use of the laity." The Biblical text found in these Commentaries is in fact so far removed from the original type of the *Early Version* as to be transitional to the *Late*, and, what is still more convincing, passages from the *Early Version*, from both the Old Testament and the New Testament, are actually quoted in the Commentary. Under such circumstances it would be folly to look upon them as anything but late productions, at all events later than the *Early Version*, and equal folly to assign these bulky volumes to the last two years of Wycliffe's

¹ See Paues, *op. cit.* p. 210.

² For a different view as to the authorship of the Wycliffite versions, see A. Gasquet, *The Old English Bible and Other Essays* (London, 1897), pp. 102 ff.

³ Sir F. Madden and Rev. J. Forshall, *The Holy Bible . . . made from the Latin Vulgate by John Wycliffe and His Followers* (4 vols., Oxford, 1850), pp. xix., xxiv.

life merely because the text used in them happens to be that of the Early Version. It is therefore at present impossible to say what part of the Early Version of the New Testament was translated by Wycliffe.¹

The Old Testament of the Early Version was, according to the editors (Preface, p. xvii.), taken in hand by one of Wycliffe's coadjutors, Nicholas de Herford. The translator's original copy and a coeval transcript of it are still extant in the Bodleian library (Bodl. 959, Douce 366). Both break off abruptly at Baruch iii. 10, the latter having at this place a note inserted to the following effect: *Explicit translatiōem Nicholay de herford.* There is consequently but little doubt that Nicholas de Herford took part in the translation of the Old Testament, though it is uncertain to what extent. The translator's copy is written in not less than five hands, differing in orthography and dialect. The note may therefore be taken to refer either to the portion translated by the last or fifth hand, or to the whole of the Old Testament up to Baruch iii. 19. Judging from uniformity of style and mode of translation the editors of the Bible are inclined to take the latter view; they add that the remaining part of the Old Testament was completed by a different hand, the one which also translated the New Testament. This statement is, however, not supported by sufficient evidence. In view of the magnitude of the undertaking it is on the contrary highly probable that other translators besides Wycliffe and Nicholas de Herford took part in the work, and that already existing versions, with changes when necessary, were incorporated or made use of by the translators.

The Early Version, apart from its completeness, shows but little advance upon preceding efforts. It is true that the translation is more careful and correct than some of the renderings noticed above, but on the other hand it shares all their faults. The translation of the Old Testament as far as Baruch iii. 19 is stiff and awkward, sometimes unintelligible, even nonsensical, from a too close adherence to the Latin text (e.g. Judges x. 25). In the remaining parts the translation is somewhat easier and more skilful, though even here Latinisms and un-English renderings abound.

It is small wonder, therefore, if a revision was soon found necessary and actually taken in hand within a few years of the completion of the Earlier Version. The principles of work adopted by the revisers are laid down in the general prologue to their edition, the so-called "Later Version."

For these reasons and others . . . a symple creature hath translated the bible out of Latyn into English. First, this symple creature hadde myche trauaile, with diuers felawis and helpis, to gedere manie elde biblis, and othere doctouris, and comune glosis, and to make oo Latyn bible sumdel trewe; and thanne to studie it of the newe, the text with the glose, and othere doctouris, as he miste gete, and speciali Lire on the elde testament, that helpeful myche in this worke; the thridde tyme to counseile with elde gramariens, and elde duyynis, of harde wordis, and harde sentencis, hou tho misten best of vnderstonde and translated; the iijij tyme to translate as cleerli as he coude to the sentence, and to haue manie gode felawis and kunnyng to the correctyng of the translatioun.

It is uncertain who the revisers were; John Purvey, the leader of the Lollard party after Wycliffe's death, is generally assumed to have taken a prominent part in the work, but the evidence of this is extremely slight (cf. Wycl. Bible, Preface, pp. xxv. f.). The exact date of the revision is also doubtful: the editors of the Wycliffe Bible, judging from the internal evidence of the Prologue, assume it to have been finished about 1388. This Revised or Later Version is in every way a readable, correct rendering of the Scriptures, it is far more idiomatic than the Earlier, having been freed from the greater number of its Latinisms; its vocabulary is less archaic. Its popularity admits of no doubt, for even now in spite of neglect and persecution, in spite of the ravages of fire and time, over 150 copies remain to testify to this fact. The following specimens of the Early and Late Versions will afford a comparison with preceding renderings:—

Early Version.

(Psalm i. 1.) Blisful the man, that went not awei in the counsell of vnpiouse, and in the wei off sinful stod not; and in the chaier of pestilence sat not. (2) But in the lawe of the Lord his wil; and in the lawe of hym he shal sweteli thenke dai and ny3t.

(Matthew iii. 1.) In thilke days came loon Baptist, prechynge in the desert of Iude, sayyng, (2) Do 3e penances, for the kyngdom of heuens shal nei; or come nise. (3) Forsothe this is he of whome it is said by Ysaie the prophet, A voice of a cryyng in desert, Make 3e redy the wayes of the Lord; make 3e ritiful the pathes of hym. (4) Forsothe that ilk loon hadde cloth of the heeris of camelis, and a girdil of skyn aboute his lendis; sothely his mete were locustis, and hony of the wode.

Later Version.

(i. 1.) Blessid is the man, that sede not in the counceil of wickid men; and stood not in the wei of synneris, and sat not in the chaier of pestilence. (2) But his wille is in the lawe of the Lord; and he schal bitenke in the lawe of hym dai and ny3t.

(iii. 1.) In the daies loon Baptist cam, and prechide in the desert of Iudee, and seide, (2) Do 3e penance, for the kyngdom of heuens shal neie. (3) For this is he, of whom it is seid by Ysaie, the prophete, sayyng, A vois of a crier in desert, Make 3e redi the weies of the Lord; make 3e rit the pathis of hym. (4) And this loon hadde clothing of camels heeris, and a girdil of skynne aboute his lendis; and his mete was honysoukis and hony of the wode.

The 13th century may well be described as the *via dolorosa* of the English Bible as well as of its chief advocates and supporters, the Lollards. After the death of Wycliffe violence and anarchy set in, and the Lollards came gradually to be looked upon as enemies of order and disturbers of society. Stern measures of suppression were directed not only against them but against "Goddis Lawe," the book for which they pleaded with such passionate earnestness. The bishops' registers bear sufficient testimony to this fact.² It would appear, however, as if at first at all events the persecution was directed not so much against the Biblical text itself as against the Lollard interpretations which accompanied it. In a convocation held at Oxford under Archbishop Arundel in 1408 it was enacted "that no man hereafter by his own authority translate any text of the Scripture into English or any other tongue, by way of a book, booklet, or tract; and that no man read any such book, booklet, or tract, nor lately composed in the time of John Wycliffe or since, or hereafter to be set forth in part or in whole, publicly or privately, upon pain of greater excommunication, until the said translation be approved by the ordinary of the place, or, if the case so require, by the council provincial. He that shall do contrary to this shall likewise be punished as a favourer of heresy and error."³

It must be allowed that an enactment of this kind was not without justification. The Lollards, for the instance, did not hesitate to introduce into certain copies of the pious and orthodox Commentary on the Psalms by the hermit of Hampole interpolations of their own of the most virulently controversial kind (MSS. Trin. Coll. Camb. B.V. 25, Brit. Mus. Reg. 18. C. 26, &c.), and although the text of their Biblical versions was faithful and true, the General Prologue of the Later Version was interlarded with controversial matter. It is small wonder if the prelates and priests sought to repress such trenchant criticism of their lives and doctrines as appeared more especially in the former work, and probably in many others which since have perished in "faggots and burning."

For all this, manuscripts of Purvey's Revision were copied and re-copied during this century, the text itself being evidently approved by the ecclesiastical authorities, when in the hands of the right people and if unaccompanied by controversial matter.

Of the Lollard movement in Scotland but little is known, but a curious relic has come down to our times in the shape of a New Testament of Purvey's Revision in the Scottish dialect of the early 16th century. The transcriber was in all probability a certain Murdoch Nisbet, who also showed his reforming tendencies by adding to it a rendering of Luther's Prologue to the New Testament.⁴

¹ See Foxe, *Acts and Monuments*, iv. 135 ff. (ed. Townsend, 1846).

² Wilkin's *Concilia*, iii. 317.

³ T. G. Law, *The New Testament in Scots*, being Purvey's Revision of Wycliffe's version turned into Scots by Murdoch Nisbet, c. 1520 (Scot. T. S., Edinburgh, 1901-1905).

⁴ Cf. A. C. Paues, *The English Bible in the Fourteenth Century*.

2. *The Printed Bible.*—It is singular that while France, Spain, Italy, Bohemia and Holland possessed the Bible in the vernacular before the accession of Henry VIII., and in Germany the Scriptures were printed in 1466 and seventeen times reprinted before Luther began his great work, yet no English printer attempted to put the familiar English Bible into type. No part of the English Bible was printed before 1525, no complete Bible before 1535, and none in England before 1538.

Versions of the Scriptures so far noticed were all secondary renderings of the Vulgate, translations of a translation. It was only with the advent of the "new learning" in England that a direct rendering from the originals became possible. Erasmus in 1516 published the New Testament in Greek, with a new Latin version of his own; the Hebrew text of the Old Testament had been published as early as 1488.

The first to take advantage of these altered conditions was William Tyndale (*q.v.*), "to whom," as Dr Westcott says, "it has been allowed more than to any other man to give its characteristic shape to the English Bible." Of Tyndale's early life but little is known. Be it enough for our purpose to say that he thoroughly saturated his mind with the "new learning," first at Oxford, where in 1515 he was admitted to the degree of M.A., and then in Cambridge, where the fame of Erasmus still lingered. Before the beginning of 1522 we find Tyndale as chaplain and tutor in the family of Sir John Walsh of Old Sodbury in Gloucestershire. He was there constantly involved in theological controversies with the surrounding clergy, and it was owing to their hostility that he had to leave Gloucestershire. He then resolved to open their eyes to the serious corruptions and decline of the church by translating the New Testament into the vernacular. In order to carry out this purpose he repaired in July or August 1523 to London, and to the famous protector of scholars and scholarship, Bishop Cuthbert Tunstall. His reception was, however, cold, the bishop advising him to seek a livelihood in the town. During a year of anxious waiting, it became clear to him "not only that there was no room in my lorde of londons palace to translate the new testament, but also that there was no place to do it in all englonde."² In May 1524 he consequently betook himself to Hamburg, his resolution to carry out his great work never for a moment flagging, and it was probably during his stay in this free city and in Wittenberg, where he may have been stimulated by Luther, that his translation of the New Testament was actually made. At all events there is no doubt that in 1525 he was in Cologne, engaged in printing at the press of Peter Quentel a quarto edition of the New Testament. This edition was provided with prefaces and marginal glosses. He had advanced as far as the tenth sheet, bearing the signature K, when his work was discovered by Johann Cochlaeus (*q.v.*), a famous controversialist and implacable enemy of the Reformation, who not only caused the Senate of Cologne to prohibit the continuation of the printing, but also communicated with Henry VIII. and Wolsey, warning them to stop the importation of the work at the English seaports. Tyndale and his assistant, William Roze, managed, however, to escape higher up the Rhine to Worms, and they succeeded in carrying with them some or all of the sheets which had been printed. Instead of completing Quentel's work, Peter Schoeffer, the Worms printer, was employed to print another impression of 3000 in a small octavo size, without prefaces to the books or annotations in the margin, and only having an address "To the Reder" at the end in addition to the New Testament itself. Two impressions, the quarto having possibly been completed by Schoeffer, arrived in England early in the summer of 1526, and were eagerly welcomed and bought. Such strong measures of suppression were, however, at once adopted against these perilous volumes, that of the quarto only a single fragment remains (Matt. i. xxii. 12), now preserved in the British Museum (Grenville, 12179).³

of the octavo only one perfect copy (the title-page missing) in the Baptist College at Bristol,⁴ and one imperfect in the library of St. Paul's cathedral.

But Tyndale continued his labours undaunted. In 1520 the manuscript translation of Deuteronomy is mentioned as having perished with his other books and papers in a shipwreck which he suffered on the coast of Holland, on his way to Hamburg. In 1530, however, the whole of the *Pentateuch* was printed in Marburg by Hans Luft; it is provided with prefaces and marginal annotations of a strongly controversial character. The only perfect copy is preserved in the Grenville library of the British Museum.⁵ It was reissued in 1534 with a new preface and certain corrections and emendations in Genesis, and again in London in 1551.

In 1531 the *Book of Jonah* appeared with an important and highly interesting prologue, the only copy known of which is in the British Museum.⁶

Meanwhile the demand for New Testaments, for reading or for the flames, steadily increased, and the printers found it to their advantage to issue the Worms edition of the New Testament in not less than three surreptitious reprints before 1534. This is testified by George Joye in his *Apology*, who himself brought out a fourth edition of Tyndale's New Testament in August 1534, freed from many of the errors which, through the carelessness of the Flemish printers, had crept into the text, but with such alterations and new renderings as to arouse the indignation of Tyndale. The only remaining copy, a 16mo, is in the Grenville library. To counteract and supersede all these unauthorized editions, Tyndale himself brought out his own revision of the New Testament with translations added of all the *Epistles of the Old Testament* after the use of Salisbury. It was published in November 1534 at Antwerp by Martin Emperour. Prologues were added to all books except the Acts and the Apocalypse, and new marginal glosses were introduced. Three copies of this edition are in the British Museum, and it was reprinted in 1841 in Bagster's *Hexapla*. In the following year Tyndale once more set forth a revised edition, "fynnesed in the yere of oure Lorde God A.M.D. and XXXV.," and printed at Antwerp by Godfried van der Haghen.⁷ In this headings were added to the chapters in the Gospels and the Acts, and the marginal notes of the edition of 1534 were omitted. It is chiefly noted for the peculiarities of its orthography. Of this edition one copy is in the University library, Cambridge, a second in Exeter College, Oxford, and a fragment in the British Museum. It is supposed to have been revised by Tyndale while in prison in the castle of Vilvorde, being the last of his labours in connexion with the English Bible. His execution took place on the 6th of October 1536, and about the same time a small folio reprint of his revised edition of 1534 was brought out in England, the first volume of Scripture printed in this country, probably by T. Berthelot.⁸ A perfect copy is found in the Bodleian library. In later years, between 1536 and 1550, numerous editions of Tyndale's New Testament were printed, twenty-one of which have been enumerated and fully described by Francis Fry.⁹

"The history of our English Bible begins with the work of Tyndale and not with that of Wycliffe," says Dr Westcott in his *History of the English Bible*, p. 316, and it is true that one of the most striking features of the work of Tyndale is its independence. Attempts have been made to show that especially in the Old Testament he based a great deal of his work on the Wycliffite translations, but in face of this we have his own explicit

⁴ Reprinted by G. Offor (London, 1836); reproduced in facsimile by Francis Fry (Bristol, 1862).

⁵ Reprinted with an introduction by J. T. Mombert (New York, 1884).

⁶ Reproduced in facsimile by Francis Fry (1863).

⁷ Cf. H. Bradshaw, *Bibliographer* (1882-1881), i. 3 ff. (reprinted 1886).

⁸ See F. Jenkinson, *Early English Printed Books in the Univ. Libr. Cambridge*, iii. (1730).

⁹ See *Biographical Description of the Editions of the New Testament, Tyndale's Version, in English* (1878).

¹ B. F. Westcott, *History of the English Bible* (3rd ed.), revised by W. Aldis Wright (London, 1905), p. 25.

² *Pref. to Genesis*, p. 396 (Parker Soc.).

³ Photo lithographed by Edw. Arber (London, 1871).

statement, "I had no man to counterfet, nether was holpe with englyshe of eny that had interpreted the same (i.e. the New Testament), or soche lyke thige if the scripture beforetyme."¹¹

He translated straight from the Hebrew and Greek originals, although the Vulgate and more especially Erasmus's Latin version were on occasion consulted. For his prefaces and marginal notes he used Luther's Bible freely, even to paraphrasing or verbally translating long passages from it.

Apart from certain blemishes and awkward and even incorrect renderings, Tyndale's translation may be described as a truly noble work, faithful and scholarly, though couched in simple and popular language. Surely no higher praise can be accorded to it than that it should have been taken as a basis by the translators of the Authorized Version, and thus have lived on through the centuries up to the present day.

The following specimens may prove of interest:—

The thyrde Chapter.

(Matthew iii. 1-4.) In those dayes Ihon the baptyscr cam and preached in the wyldernes of Iury, saynge, Repent, the kyngdom of heven ys at hande. Thus ys he of whom it ys spoken be the prophet Esay, which sayeth: the voice of a cryer in wyldernes, prepare ye the lordes waye, and make hys pathes strayght. Thus Ihon had hys garment of camelles heere, and a gyrdyll of a skynne about hys loynes. Hys meate was locustes * and wyldhe ony.

* Locustes are more then oware gresspoppers, soche men vse to eate in divres parties of the est" (marginal note).

(Matthew vi. 9-13.) O our father which art in heven, hallowed be thy name. Let thy kyngdom come. Thy will be fulfilled, as well in erth, as hit ys in heven. Geve vs this daye our dayly breade. And forgeve vs oure trespasses, even as we forgeve them which trespass vs. Lede vs nott in to temptacion, but delyvre vs from yvell. Amen. (Grenville 12179.)

Meanwhile a complete English Bible was being prepared by Miles Coverdale (q.v.), an Augustinian friar who was afterwards for a few years (1551-1553) bishop of Exeter. As the printing was finished on the 4th of October 1535 it is evident that Coverdale must have been engaged on the preparation of the work for the press at almost as early a date as Tyndale. Foxe states (*op. cit.* v. 120) that Coverdale was with Tyndale at Hamburg in 1520, and it is probable that most of his time before 1535 was spent abroad, and that his translation, like that of Tyndale, was done out of England.

In 1877 Henry Stevens, in his catalogue of the Caxton Exhibition, pointed out a statement by a certain Simeon Ruytynck in his life of Emanuel van Meteren, appended to the latter's *Nederlandsche Historie* (1614), that Jacob van Meteren, the father of Emanuel, had manifested great zeal in producing at Antwerp a translation of the Bible into English, and had employed for that purpose a certain learned scholar named Miles Conerdale (*sic*).

In 1884 further evidence was adduced by W. J. C. Moens, who reprinted an affidavit signed by Emanuel van Meteren, 28 May 1609, to the effect that "he was brought to England anno 1550 . . . by his father, a furtherer of reformed religion, and he that caused the first Bible at his costes to be Englished by Mr Myles Coverdal in Andwarp, the w'h his father, with Mr Edward Whytchurch, printed both in Paris and London" (*Registers of the Duich Reformed Church, Austin Friars*, 1884, p. xiv.). Apart from the reference to Whytchurch and the place of printing, this statement agrees with that of Simeon Ruytynck, and it is possible that van Meteren showed his zeal in the matter by undertaking the cost of printing the work as well as that of remunerating the translator. Mr W. Aldis Wright, however, judging from the facts that the name of Whytchurch was introduced, that the places of printing were given as London and Paris, not Antwerp, and lastly that Emanuel van Meteren being born in 1535 could only have derived his knowledge from hearsay, is inclined to think that the Bible in which J. van Meteren was interested "was Matthew's of 1537 or the Great Bible of 1539, and not Coverdale's of 1535."²

It is highly probable that the printer of Coverdale's Bible was

¹ *Epistle to the Reader* in the New Testament of 1526, reprinted by G. Offor; cf. *Parker Soc.* (1848), p. 390.

² Westcott, *op. cit.* p. 57 note.

Christopher Froschouer of Zürich,³ who printed the edition of 1550, and that the sheets were sent for binding and distribution to James Nicolson, the Southwark printer.⁴ This first of all printed English Bibles is a small folio in German black letter, bearing the title: "*Biblia, The Bible*"; that is, the Holy Scripture of the Olde and New Testament, faithfully and truly translated out of Douche (German) and Latyn into Englyshe, M.D.XXXV." The volume is provided with woodcuts and initials, the title-page and preliminary matter in the only two remaining copies (British Museum and Holkam Hall) being in the same type as the body of the book. A second issue of the same date, 1535, has the title-page and the preliminary matter in English type, and omits the words "out of Douche and Latyn"; a third issue bears the date 1536. A second edition in folio, "newly oversene and corrected," was printed by Nicolson, with English type, in 1537; and also in the same year, a third edition in quarto. On the title-page of the latter were added the significant words, "set forth with the Kynges moost gracious licence."

Coverdale, however, was no independent translator. Indeed, he disavows any such claim by stating expressly, in his dedication to the king, "I have with a cleare conscience purely & faythfully translated this out of fyve sundry interpreters, hauyng only the manyfest truth of the scripture before myne eyes," and in the Prologue he refers to his indebtedness to "the Douche (German) interpreters: whom (because of theyr synguler gyftes and special diligence in The Bible) I have ben the more glad to folowe for the most parte, accordynge as I was required."⁵ These "fyve interpreters" Dr Westcott (*ibid.* p. 163) identifies as Luther, the Zürich Bible, the Latin version of Pagninus, the Vulgate, and, in all likelihood, the English translation of Tyndale.

Though not endowed with the strength and originality of mind that characterized Tyndale's work, Coverdale showed great discrimination in the handling and use of his authorities, and moreover a certain delicacy and happy ease in his rendering of the Biblical text, to which we owe not a few of the beautiful expressions of our present Bible.

The following extracts from the edition of 1535 may serve as examples of his rendering:—

The first psalme.

(i. 1-2.) Blessed is þe man, þe goeth not in the counsell of þe ungodly: þe abydeþ not in the waye off synners, & sytþeth not in þe seate of the scornfull. But delyteth in the lawe of þe Lorde, & exerceyeth hymself in his lawe both daye and night.

The gospell of S. Mathew.

(iii. 1-4.) In those dayes Ihon the Baptist came and preached in the wyldernes of Iury, saynge: Amende yure selues, the kyngdome of heuen is at hande. This is he, of whom it is spoken by the prophet Esay, which sayeth: The voice of a cryer in þe wyldernes, prepare the Lordes waye, and make his pathes straight. This Ihon had hys garment of camels heere, and a lethern gerdell aboute his loynes. Hys meate was locustes and wyldhe ony.

It should be added that Coverdale's Bible was the first in which the non-canonical books were left out of the body of the Old Testament and placed by themselves at the end of it under the title *Apocripha*.

The large sale of the New Testaments of Tyndale, and the success of Coverdale's Bible, showed the London booksellers that a new and profitable branch of business was opened out to them, and they soon began to avail themselves of its advantages. Richard Grafton and Edward Whytchurch were the first in the field, bringing out a fine and full-sized folio in 1537, "truly and purely translated into English by Thomas Matthew." Thomas Matthew, is, however, in all probability, an alias for John Rogers, a friend and fellow-worker of Tyndale, and the volume is in reality no new translation at all, but a compilation from the renderings of Tyndale and Coverdale. Thus the Pentateuch and the New Testament were reprinted from Tyndale's translations of 1530 and 1535 respectively, with very slight variations;

³ See Dr Ginsburg's information to Mr Tedder, *D.N.B.* xii. 365.

⁴ Cf. H. Stevens, *Catalogue of the Caxton Exhibition* (1877), p. 88.

⁵ *Remains*, Parker Soc., pp. 11 f.

Matthew's Bible.

the books from Joshua to the end of Chronicles are traditionally, and lately also by external evidence,¹ assigned to Tyndale and were probably left by him in the hands of Rogers. From Ezra to Malachi the translation is taken from Coverdale, as is also that of the Apocryphal books. John Roger's own work appears in a marginal commentary distributed through the Old and New Testaments and chiefly taken from Olivetan's French Bible of 1535. The volume was printed in black letter in double columns, and three copies are preserved in the British Museum. In 1538 a second edition in folio appeared; it was reprinted twice in 1549, and again in 1551. It is significant that this Bible, like Coverdale's second edition, was "set forth with the kinges most graciously lycence," probably with the concurrence of Cranmer, since he, in a letter to Cromwell, begged him to "exhibit the book unto the king's highness, and to obtain of his grace . . . a licence that the same may be sold and read of every person, without danger of any act, proclamation or ordinance, heretofore granted to the contrary."² And thus it came to pass, as Dr Westcott strikingly puts it, that "by Cranmer's petition, by Cromwell's influence, and by Henry's authority, without any formal ecclesiastical decision, the book was given to the English people, which is the foundation of the text of our present Bible. From Matthew's Bible—itsself a combination of the labours of Tyndale and Coverdale—all later revisions have been successively formed" (*op. cit.* p. 71).

Meanwhile the successful sale of Matthew's Bible, the private venture of the two printers Grafton and Whitchurch, was threatened by a rival edition published in 1539 in folio and quarto by "John Byddell for Thomas Barthlet" with Richard Taverner as editor. This was, in fact, what would now be called "piracy," being Grafton's *Matthew Bible* revised by Taverner, a learned member of the Inner Temple and famous Greek scholar. He made many alterations in the Matthew Bible, characterized by critical acumen and a happy choice of strong and idiomatic expressions. He is, perhaps, the first purist among the Biblical translators, endeavouring, whenever possible, to substitute a word of native origin for the foreign expression of his predecessors.³ His revision seems, however, to have had little or no influence on subsequent translators, and was only once, in 1549, reprinted in its entirety. Quarto and octavo editions of the New Testament alone were published in the same year, 1539, as the original edition, and in the following year, 1540, the New Testament in duodecimo. The Old Testament was reprinted as part of a Bible in 1551, but no other editions are known than those named.

It will have been observed that the translations of Holy Scripture which had been printed during these years (1525-1539) were all made by private men and printed without any public authority. Some of them had indeed been set forth by the king's licence, but the object of this is shown by the above-quoted letter of Archbishop Cranmer to Cromwell, touching Matthew's Bible. It is "that the same may be sold and read of every person . . . until such time that we, the bishops, shall set forth a better translation, which I think will not be till a day after doomsday." This letter was written on the 4th of August 1537, and the impatient words at the end refer to an authorized version which had been projected several years before, and which was, in fact, at that very time in preparation, though not proceeding quickly enough to satisfy Cranmer. In the year 1530, Henry VIII. had issued a commission of inquiry respecting the expediency and necessity of having "in the English tongue both the New Testament and the Old" (Wilkins' *Concilia*, iii. 737). This commission reported against the expediency of setting forth a vernacular translation until there was a more settled state of religious opinion, but states that the king "intended to provide that the Holy Scripture shall be, by great, learned and Catholic persons, translated into the English tongue if it shall then seem to His Grace convenient to be" (*ib.* 740). The Convocation of Canterbury refreshed the

royal memory on the subject by petitioning the king on the 19th of December 1534 "that His Majesty would vouchsafe to decree, that the Scriptures should be translated into the vulgar tongue . . . and . . . delivered to the people according to their learning" (*ibid.* 770). The subject was again before Convocation in 1536,⁴ but the detailed history is lost to us—all that is known being that Cromwell had placed Coverdale at the head of the enterprise, and that the result was an entirely new revision, based on Matthew's Bible.⁵ Coverdale consulted in his revision the Latin version of the Old Testament with the Hebrew text by Sebastian Münster, the Vulgate and Erasmus's editions of the Greek text for the New Testament.

Concerning the printing of this authorized Bible more details are known. Cromwell had planned the work on a large scale, too large evidently for the resources of the English presses, for it was determined that the printing should be entrusted to Francis Regnault, a famous Paris printer. At the request of Henry VIII., a licence was granted to Regnault for this purpose by Francis I., while Coverdale and Grafton were sent over in 1538 to superintend the work as it passed through the press. The work was pressed forward with all speed, for, as Coverdale writes to Cromwell, they were "dayly threatened" and ever feared "to be spoken withall."⁶ Indeed, when the printing was far advanced, on the 17th of December 1538, its further progress was interdicted by the Inquisitor-general for France, and orders were given to seize the whole of the impression. Coverdale and Grafton left Paris quickly, but soon returned, rescued a great number of the finished sheets, "four great dryvats" full of them having been sold to a haberdasher instead of being burnt—and conveyed types, printing-presses and workmen to England. Thus the volume which had been begun in Paris in 1538 was completed in London, the colophon stating that it was "Fynished in Apryll, Anno M.CCCC.XXXIX." It is a splendid folio Bible of the largest volume, and was distinguished from its predecessors by the name of *The Great Bible*. The title-page represents Henry VIII. giving the "Word of God" to Cromwell and Cranmer, who, in their order, distribute it to laymen and clerics, and describes the volume as "truly translated after the verite of the Hebreue and Greke texts by þe dylygent studeye of dyverse excellent learned men, expert in the forsayde tongues. Prynnt by Rychard Grafton and Edward Whitchurch." "Certain godly annotations," which Coverdale promised in the Prologue, did not, however, appear in the first issue, nor in any of the following. This was the first of seven editions of this noble Bible which issued from the press during the years 1539-1541,—the second of them, that of 1540, called *Cranmer's Bible* from the fact that it contained a long Preface by Archbishop Cranmer, having the important addition "This is the Byble apoynted to the vse of the churches" on the title-page. Seventy years afterwards it assumed the form ever since known as the *Authorized Version*, but its Psalter is still embedded, without any alteration, in the Book of Common Prayer.

For the sake of comparison the following extracts from St Matthew are given, according to the edition of 1539.

(Matthew iii. 1-4.) In those dayes came Iohn the Baptyst, preaching in the wyldernes of Iewry, saying, Repent of the life that is past, for the kyngdome of heauen is at hande. For thys is he, of whom the prophet Esay spake, which sayeth, the voyce of a cryer in the wyldernes, prepare ye the waye of the lorde: make hys pathes straight. Thys Iohn had hys garment of camels heer: And a girdell of a skynne aboute hys loynes. His meate was locustes and wyldy hony.

(Matthew vi. 9-13.) Oure father which art in heauen, halowed be thy name. Let thy kyngdome come. Thy will be fulfilled, as well in erth, as it is in heuen. Geue vs thys daye oure dayly bred. And forgeue vs oure detters, as we forgeue oure detters. And leade vs not into temptation: but deluey vs from euyl. For thyn is the kyngdom and the power, and the glorye for euer. Amen.

Meanwhile the closing years of Henry VIII.'s reign were characterized by restrictive measures as to the reading and use of the Bible. Tyndale Version was prohibited by an act of

⁴ Burnet's *Ref.*, ed. Pococke, 1865.

⁵ Westcott, *op. cit.* pp. 180 f.

⁶ *Remains* (Parker Soc.), p. 493; cf. J. A. Kingdon, *Incidents in the Lives of Thomas Poyntz and Richard Grafton* (1895).

¹ Westcott, *op. cit.* p. 172 note.

² Cranmer's *Works*, letter 194 (Parker Soc.).

³ See examples in Westcott, *op. cit.* pp. 208 f.

parliament, 1543; at the same time it was enacted that all notes and marginal commentaries in other copies should be obliterated, and that "no woman (unless she be a noble or gentle woman), no artificers, apprentices, journeymen, servingmen, under the degree of yeomen . . . husbandmen or labourers" should read or use any part of the Bible under pain of fines and imprisonment.¹

In 1546 Coverdale's Bible was included in the proscription, the *Great Bible* being the only translation not interdicted.

During Edward VI.'s reign there was a brief respite, but with the accession of Mary the persecutions of the English Bible and its friends were renewed. Cramer suffered martyrdom at the stake, as John Rogers had done before him. Other prominent reformers, amongst them Coverdale, sought refuge in Geneva, the town of Calvin and Beza, where they employed their enforced leisure in planning and carrying out a new revision of the Bible. The first fruits of these labours was a New Testament issued in June 1557, with an introduction by Calvin, probably the work of William Whittingham.² The volume, in a convenient quarto size, printed in clear Roman type, and provided with marginal annotations, gained immediate popularity in England, where a Bible suited for household demands had long been needed. It was the first Bible which had the text divided into "verses and sections according to the best editions in other languages."³

Whittingham's enterprise was, however, soon superseded by an issue of the whole Bible, which appeared in 1560, the so-called

Genevan Bible, popularly also known as the *Breaches Bible*, from its rendering of Gen. iii. 7, "They sewed fig leaves together and made themselves breeches."

This edition was mainly due to the combined efforts of William Whittingham, Anthony Gilby and Thomas Sampson, and the expenses towards printing and publication were borne by members of the congregation at Geneva. It represented in the Old Testament a thorough and independent revision of the text of the *Great Bible* with the help of the Hebrew original, the Latin versions of Leo Juda (1543), Pagninus (1528), Sebastian Münster (1534-1535), and the French versions of Olivetan. The New Testament consisted of Tyndale's latest text revised to a great extent in accordance with Beza's translation and commentary. The changes introduced by the Genevan translators were, as a rule, a great improvement, and the version received a ready welcome and immediate popularity, not only on account of its intrinsic merits, but because of its handy size, usually that of a small quarto, and of its being printed, like Whittingham's New Testament, in a readable Roman type instead of black letter. Like this earlier publication, it had the division of the chapters into verses, and a marginal commentary which proved a great attraction to the Puritans. The popularity of the Genevan Bible was so great that between 1560 and 1644 at least 140 editions of it were published,⁴ and this in spite of its not being allowed for use in the churches.

In 1576 the New Testament of the Genevan Bible was again revised by Lawrence Tomson and provided with a new commentary mainly translated from Beza. It soon became popular and even replaced the Genevan New Testament in later editions of this Bible.

Some time after the accession of Queen Elizabeth an attempt was made to improve the authorized *Great Bible*, and in this way to challenge the ever growing popularity of the Calvinistic *Genevan Bible*. The initiative was taken by Archbishop Parker, about 1563-1565, who, according to Strype (Parker i. 414) "took upon him the labour to contrive and set the whole work a going . . . by sorting out the whole Bible into parcels . . . and distributing these

parcels to able bishops and other learned men, to peruse and collate each the book or books allotted them . . . and they to add some short marginal notes for the illustration or correction of the text."

The rules upon which they proceeded were these:—

1. "To follow the common English translation used in the churches, and not to recede from it, but where it varieth manifestly from the Hebrew or Greek original. 2. To use sections and divisions in the text as Pagnine in his translation useth, and for the verity of the Hebrew to follow the said Pagnine and Münster specially, and generally others learned in the tongues. 3. To make no bitter notes upon any text, or yet to set down any determination in places of controversy. 4. To note such chapters and places as contain matters of genealogies, or other such places not edifying, with some strike or note, that the reader may eschew them in his public reading. 5. That all such words as sound in the old translation to any offence of lightness or obscenity be expressed with more convenient terms and phrases."

The work was pushed forward with energy, and on the 5th of October 1568 the volume was ready for publication. It was a magnificent folio, generally known as the *Bishops' Bible*, since not less than eight of these dignitaries took part in the revision. But the detached and piecemeal way in which the revision had been carried out naturally caused certain inequalities in the execution of the work. The different parts of the Bible vary considerably in merit, the alterations in the New Testament, for instance, showing freshness and vigour, whereas most of the changes introduced in the Old Testament have been condemned as "arbitrary and at variance with the exact sense of the Hebrew text" (Westcott, *op. cit.* p. 237). Several editions of the *Bishops' Bible* were afterwards published, but it is doubtful whether the ecclesiastical authorities in spite of repeated enactments (Cardwell, *Synodalia*, pp. 115, 123, 210, 292) ever succeeded in entirely enforcing its public use in the churches. After 1569 the *Great Bible* ceased, however, to be reprinted. But in the homes the Genevan version still maintained its supremacy. One thing is certain, that the book of Psalms of the new revision had fairly soon to give way before the well-known and smooth rendering of the *Great Bible*. In the second edition of the *Bishops' Bible*, 1572, the two texts were actually printed side by side; in all later editions except one (1585) the older Psalter alone remained.

From the time of Tyndale onwards the translation of the Scriptures into English had been more or less an outcome of the great reformatory movements within the church.

It was not until Queen Elizabeth's reign that members of the Romanist party found it expedient to translate the Bible into the vernacular "for the more speedy abolishing of a number of false and impious translations put forth by sundry sectes, and for the better preseruacion or reclaiming of many good soules endangered thereby" (*Preface to the Rhemish Version*).

According to the title-page the New Testament was "translated faithfully into English out of the authentical Latin, according to the best corrected copies of the same, diligently conferred with the Greeke and other editions in diuers languages. . . . In the English Colledge of Rhemes, 1582." The Old Testament had been "long since" completed, but "for lacke of good meanes" (1600-1610, the New Testament), its appearance was delayed till 1609-1610, when it was published at Douai. The complete work, known as the *Rhemes and Douay Version*, was reprinted in Rouen in 1635, and after a considerable time revised by Dr Challoner (1749-1750). The translation is really anonymous, but there seems to be little doubt that it was carried out by some of the Romanist refugees connected with the Seminary at Douai and the English college at Reims, the chief amongst them being Gregory Martin, William Allen, Richard Bristow and J. Reynolds. Like the Wycliffite Versions it is merely a secondary rendering from the Latin Vulgate, and it suffered from many of the defects which characterized these versions, extreme literalness, often stilted, ambiguous renderings, at times unintelligible except by a reference to the Latin original, as in Luke xxii. 18, "I will not drink of the generation of the vine," or Phil. ii. 7, "But he exaninated himself."

The Reims and Douay Version.

¹ Cf. Burnet's *Ref. i.* 584.

² Printed in Bagster's *Hexapla*, 1841, reprinted separately in 1842.

³ See "Address to the Reader." The division into verses of the New Testament was first found in R. Stephanus' Greek-Latin New Testament (4th ed., 1551), whereas these divisions already existed in the Hebrew Old Testament.

⁴ See T. H. Darlow and H. F. Moule, *Historical Catal. of the Printed Editions of Holy Scripture in the Libr. of the Brit. and Foreign Bible Soc.* (London, 1903).

As further examples of this rendering we print the same passages from St Matthew:—

(Matthew iii. 1-4.) And in those dayes cometh John the Baptist preaching in the desert of Ievrie, saying, Doe penance: for the Kingdom of heauen is at hand. For this is he that vvas spoken of by Esay the Prophet, saying, A voyce of one crying in the desert, prepare ye the way of our Lord, make straight his pathes. And the sayd Iohn had his garment of camels haire, & a girdle of a skinne about his loynes: and his meate was locustes & vvlde honie.

(Matthew vi. 9-13.) Ovr Father which art in heauen, sanctified be thy name. Let thy Kingdom come. Thy will be done, as in heauen, in earth also. Giue vs to day our supersubstantial bread. And forgiue vs our dettes, as we also forgiue our detters. And leade vs not into tentation. But deliuer vs from evil. Amen.

The strongly Latinized vocabulary of this version was not without its influence on the next great venture in English translations of the Bible, the *Authorized Version*.¹

The English Bible, which is now recognized as the *Authorized Version* wherever the English language is spoken, is a revision of the Bishops' Bible, begun in 1604, and published in 1611. It arose incidentally out of a Conference between the High Church and the Low Church parties convened by James I. at Hampton Court Palace in January 1604, for the purpose of determining "things pretended to be amiss in the church," and was originally proposed by Dr Reynolds, president of Corpus Christi College, Oxford, the leader and spokesman of the Low Church party, and subsequently on the committee which revised the translation of the Prophets.

No real opposition was offered to the proposal, and the king cleverly sketched out on the moment a plan to be adopted. He "wished that some special pains should be taken in that behalf for one uniform translation—professing that he could never yet see a Bible well translated in English—and this to be done by the best learned in both the Universities; after them to be reviewed by the bishops and the chief learned of the Church; from them to be presented to the privy council; and lastly to be ratified by his royal authority; and so this whole church to be bound unto it and none other."² He also particularly desired that no notes should be added by way of comment in the margin, since some of those in the Geneva Bible appeared to him "very partial, untrue, seditious and savouring too much of dangerous and traitorous conceits."

The appointment of the revisers was a work of much responsibility and labour, and five months elapsed before they were selected and their respective portions assigned to them; but the list of those who began the work, and who, with some few changes in consequence of deaths, brought it to a happy conclusion, shows how large an amount of scholarship was enlisted. It includes Dr Andrews, afterwards bishop of Winchester, who was familiar with Hebrew, Chaldee, Syriac, Greek, Latin and at least ten other languages, while his knowledge of patristic literature was unrivalled; Dr Overall, regius professor of theology and afterwards bishop of Norwich; Bedwell, the greatest Arabic scholar of Europe; Sir Henry Savile, the most learned layman of his time; and, to say nothing of others well known to later generations, nine who were then or afterwards professors of Hebrew or of Greek at Oxford or Cambridge. It is observable also that they were chosen without reference to party, at least as many of the Puritan clergy as of the opposite party being placed on the committees.

The following list³ is drawn up in such a way as to show the academical or other position which each of them occupied, and the particular part of the work on which they were engaged.

¹ See J. G. Carleton, *The Part of Rheims in the Making of the English Bible* (Oxford, 1902).

² Barlow, *Sum and Substance of the Conference . . . in Cardwell's History of Conferences*, pp. 187 f.

³ Compiled chiefly from the list found in Cardwell's *Synodalia* (ed. 1844), ii. 145-146, a reprint from Burnet's *Doc. Annals*, i. 106 ff., "who himself took his list from a copy belonging originally to Bishop Ravis." The list is correct for the year 1604; cf. Westcott, *op. cit.* pp. 112 f.

Kings.	Dr Lancelot Andrewes, dean of Westminster.	Westminster.
	Dr John Overall, dean of St Paul's.	
	Dr Hadrian de Saravia, canon of Canterbury.	
	Dr Richard Clark, fellow of Christ's Coll., Camb.	
Genesis—	Dr John Layfield, fellow of Trin. Coll., Camb.	Westminster.
	Dr Robert Teigh, archdeacon of Middlesex.	
	Mr Francis Bureleigh, Pemb. Hall, Camb., D.D., 1607.	
	Mr Geoffrey King, fellow of King's Coll., Camb.	
I Chron.—Eccles.	Mr Thompson, Clare Hall, Camb.	Cambridge.
	Mr William Bedwell, St John's Coll., Camb.	
	Mr Edward Lively, fellow of Trin. Coll.	
	Mr John Richardson, afterwards master of Trin. Coll.	
Isaiah—Malachi.	Mr Laurence Chatterton, master of Emm. Coll.	Cambridge.
	Mr Francis Dillingham, fellow of Christ's Coll.	
	Mr Thomas Harrison, vice-master of Trin. Coll.	
	Mr Roger Andrews, afterwards master of Jesus Coll.	
The Four Gospels, Acts, Apocrypha.	Mr Robert Spalding, fellow of St John's.	Cambridge.
	Mr Andrew Byng, fellow of St Peter's Coll.	
	Dr John Harding, pres. of Magd. Coll.	
	Dr John Reynolds, pres. of Corpus Christi Coll.	
The Apocrypha.	Dr Thomas Holland, afterwards rector of Ex. Coll.	Oxford.
	Dr Richard Kibbe, rector of Lincoln Coll.	
	Dr Miles Smith, Brasenose Coll., Ox.	
	Dr Richard Brett, fellow of Lincoln Coll.	
The Four Gospels, Acts, Apocrypha.	Mr Richard Fairclough, fellow of New Coll.	Oxford.
	Dr John Dupont, master of Jesus Coll.	
	Dr William Branthwait, master of Caius Coll.	
	Dr Jeremiah Radcliffe, fellow of Trin. Coll.	
The Four Gospels, Acts, Apocrypha.	Dr Samuel Ward, afterwards master of Sid. Coll.	Cambridge.
	Mr Andrew Downes, fellow of St John's Coll.	
	Mr John Bois, fellow of St John's Coll.	
	Mr Robert Ward, fellow of King's Coll.	
The Four Gospels, Acts, Apocrypha.	Dr Thomas Ravis, dean of Christ Church.	Oxford.
	Dr George Abbot, dean of Winchester.	
	Dr Richard Eedes, dean of Worcester.	
	Dr Giles Thompson, dean of Windsor.	
The Four Gospels, Acts, Apocrypha.	Dr (Sir Henry) Savile, provost of Eton.	Westminster.
	Dr John Perin, fellow of St. John's Coll.	
	Dr Ravens [fellow of St John's Coll.]	
	Dr John Harmer, fellow of New Coll.	
The Four Gospels, Acts, Apocrypha.	Dr William Barlow, dean of Chester.	Westminster.
	Dr William Hutchinson, archdeacon of St Albans.	
	Dr John Spencer, pres. of Corp. Chr. Coll., Ox.	
	Dr Roger Fenton, fellow of Pemb. Hall, Camb.	
The Four Gospels, Acts, Apocrypha.	Mr Michael Rabbett, Trin. Coll., Camb.	Westminster.
	Mr Thomas Sanderson, Balliol Coll., Oxford, D.D., 1605.	
	Mr William Dakins, fellow of Trin. Coll., Camb.	

When this large body of scholars were set down to their task, an elaborate set of rules was drawn up for their guidance, which contained a scheme of revision as well as general directions for the execution of their work. This is one of the very few records that remain of their undertaking.⁴

"(1) The ordinary Bible read in the Church, commonly called 'the Bishop's Bible,' the following, and as little altered as the truth of the original will permit. (2) The names of the prophets and the holy writers, with the other names of the text to be retained as high as may be, accordingly as they were vulgarly used. (3) The old ecclesiastical words to be kept, viz. the word *Church* not to be translated *Congregation*, &c. (4) When a word hath divers significations, that to be kept which hath been most commonly used by the most of the ancient fathers, being agreeable to the propriety of the place and the analogy of the faith. (5) The division of the chapters to be altered either not at all or as little as may be, if necessity so require. (6) No marginal notes at all to be added, but only for the explanation of the Hebrew or Greek words which cannot, without some circumlocution, so briefly and fitly be expressed in the text. (7) Such quotations of places to be marginally set down as shall serve for the fit reference of one Scripture to another. (8) Every particular man of each company to take the same chapter or chapters; and having translated or amended them severally by himself where he thinketh good, all to meet together, confer what they have done, and agree for their parts what shall stand. (9) As any one company hath dispatched any one book in this manner, they shall send it to the rest to be examined and seriously, and judiciously, for his majesty is very careful in this point. (10) If any company, upon the review of the book so sent, doubt or differ upon any place, to send them word thereof, note the place, and withal send the reasons; to which if they consent not, the difference to be compounded at the general meeting, which is to be of the chief persons of each company at the end of the work. (11) When any place of special obscurity is doubted of, letters to be directed by authority to send to any learned man in the land for his judgment of such a place. (12) Letters to be sent from every bishop to the rest of his clergy, admonishing them of his

⁴ Quoted from G. Burnet's *Hist. of Reformation*, ii. p. 368 (1861).

translation in hand, and to move and charge as many as being skilful in the tongues and having taken pains in that kind, to send his particular observations to the company either at Westminster, Cambridge or Oxford. (13) The directors in each company to the deans of Westminster and Chester for that place; and the king's professors in the Hebrew or Greek in either university. (14) These translations to be used when they agree better with the text than the Bishops' Bible; viz. Tyndale's, Matthew's, Coverdale's, Whitchurch's, Geneva. (15) Besides the said directors before mentioned, three or four of the most ancient and grave divines in either of the universities, not employed in translating, to be assigned by the vice-chancellor upon conference with [the] rest of the heads to be overseers of the translations, as well Hebrew as Greek, for the better observation of the fourth rule above specified."

It is not possible to determine in how far all these rules were adhered to. All we know of the way this noble work was carried out is contained in the Preface, where Dr Miles Smith, in 1612 bishop of Gloucester, in the name of his fellow-workers gives an account of the manner and spirit in which it was done:—

"Neither did we run over the worke with that posting haste that the *Septuagint* did, if that be true which is reported of them, that they finished it in 72 dayes. . . . The worke hath . . . cost the workemen, as light as it seemeth, the paines of twice seven times seuentie two dayes and more . . . Truly (good Christian Reader), we neuer thought from the beginning, that we should neede to make a new Translation, nor yet to make of a bad one a good one . . . but to make a good one better, or out of many good ones, one principally good one, not justly to be excepted against. . . . To that purpose there were many chosen, that were greater in other mens eyes than in their owne, and that sought the truth rather than their own praise. . . . Neither did we thinke much to consult the Translators or Commentators, *Chaldee, Hebrew, Syrian, Greeke, or Latine*, no nor the *Spanish, French, Italian or Dutch* [German]; neither did we disdain to reuse that which we had done, and to bring back to the anull that which we had hammered: but hauing and vsing as great helpe as were needfull, and fearing no reproch for slownesse, nor coueting praise for expedition, we haue at the length, through the good hand of the Lord vpon vs, brought the worke to that passe that you see."

From the above it appears that the actual work of revision occupied about two years and nine months, an additional nine months being required for the final preparation for press. The edition appeared at length in 1611, the full title being as follows: *The Holy Bible, conteyning the Old Testament, and the New: Newly Translated out of the Originall tongues, & with the former Translations diligently compared and reuised, by his Maiesties speciall cōmandement. Appointed to be read in Churches.* Imprinted at London by Robert Barker, Printer to the Kings most Excellent Maiestie. *Anno Dom. 1611.* Since that time many millions of this revised translation have been printed, and the general acceptance of it by all English-speaking people of whatever denomination is a testimony to its excellence.

Still the work of improving and correcting went on through the centuries, and a modern copy of the Authorized Version shows no inconsiderable departures from the standard edition of 1611. Dr Scrivener imputes some of those differences "to oversight and negligence . . . but much the greater part of them" he holds to be "deliberate changes, introduced silently and without authority by men whose very names are often unknown." (A. C. P.)

More ambitious attempts at amending the new version were not lacking, but they all proved fruitless, until in February 1870 the Convocation of Canterbury appointed a committee to consider the subject of revision. The report of this committee, presented in May, was adopted, to the effect "that Convocation should nominate a body of its own members to undertake the work of revision, who shall be at liberty to invite the co-operation of any eminent for scholarship, to whatever nation or religious body they may belong"; and shortly afterwards two companies were formed for the revision of the Authorized Version of the Old and New Testaments.

These companies consisted of the following:—1. For the Old Testament:—(a) *Appointed by Convocation.*—Connon Thirlwall, bishop of St David's (d. 1875); Alfred Ollivant (1798-1882), bishop of Landaff; E. Harold Browne (1811-1891), bishop of Ely; Christopher Wordsworth, bishop of Lincoln; and Lord Arthur Hervey (1808-

1894), bishop of Bath and Wells; Archdeacon H. J. Rose (d. 1873); William Selwyn (1806-1875), canon of Ely and Lady Margaret professor at Cambridge; Dr John Jebb (1805-1886), canon of Hereford; and Dr William Kay (1820-1886). (b) *Invited.*—Dr William Lindsay Alexander (1808-1884), congregational minister; Thomas Chenery (1826-1884), professor of Arabic at Oxford, and afterwards (1877) editor of *The Times*; Frederick Charles Cook (1810-1889), canon of Exeter; Professor A. B. Davidson; Dr Benjamin Davies (1814-1875), professor of oriental and classical languages at Stepney Baptist College; the Rev. A. M. Fairbairn, congregationalist; the Rev. Frederick Field (1801-1885), fellow of Trinity, Cambridge; Dr C. D. Ginsburg; the Rev. Dr Gotch of Bristol; Archdeacon Benjamin Harrison (1808-1887), Hebraist; the Rev. Stanley Leathes (1830-1900), professor of Hebrew at King's College, London; Professor M'Gill; Canon Robert Payne Smith (1810-1895), regius professor of divinity at Oxford, dean of Canterbury (1870); Professor J. J. S. Perowne, afterwards bishop of Worcester; the Rev. Edward Hayes Plumtree (1821-1891), professor of exegesis at King's College, London, afterwards dean of Wells; Canon E. Bouverie Pusey; William Wright (1830-1889), the orientalist; W. Aldis Wright, Cambridge. Of these Canons Cook and Pusey declined to serve, and ten members died during the progress of the work. The secretary of the company was Mr W. Aldis Wright, fellow of Trinity, Cambridge.

2. For the New Testament:—(a) *Appointed by Convocation.*—Samuel Wilberforce, bishop of Winchester; Charles J. Ellicott, bishop of Gloucester and Bristol; and George Moberly, bishop of Salisbury; Dr Edward Bickersteth (1814-1892), prolocutor of the lower house of convocation; Henry Alford, dean of Canterbury, and Arthur Penrhyn Stanley, dean of Westminster; Joseph Williams Bikesley (1808-1885), canon of Canterbury, and (1872) dean of Lincoln. (b) *Invited.*—The Rev. Dr Joseph Angus, president of the Stepney Baptist College; Dr David Brown; Richard Chenevix Trench, archbishop of Dublin; the Rev. Dr John Eadie (1810-1876), Presbyterian; the Rev. F. J. A. Hort; the Rev. W. G. Humphry (1815-1886), vicar of St Martin-in-the-Fields, London; the Rev. Benjamin Hall Kennedy, canon of Ely; William Lee (1815-1883), archdeacon of Dublin, and professor of ecclesiastical history in the university; J. B. Lightfoot, afterwards bishop of Durham; Professor William Milligan; the Rev. William Fieldian Moulton (1835-1898), Wesleyan biblical scholar; Dr J. H. Newman; the Rev. Samuel Newth (1821-1898), congregationalist, professor of ecclesiastical history at, and afterwards president of, New College, London; Dr A. Roberts; the Rev. G. Vance Smith; Dr Robert Scott; the Rev. F. H. A. Scrivener (1813-1891), rector of St Germans, Cornwall; Charles Wordsworth, bishop of St Andrews; Dr W. H. Thompson; Dr S. P. Tregelles; Dr C. J. Vaughan; Canon Westcott. Of these, Dr Thompson and Dr Newman declined to serve. Dean Alford, Dr Tregelles, Bishop Wilberforce and Dr Eadie were removed by death. Only the first vacancy was filled up. Dean Merivale was co-opted, and on his resignation Professor, afterwards Archdeacon, Edwin Palmer. The Rev. J. Troutbeck, minor canon of Westminster, acted as secretary.

Negotiations were opened with the leading scholars of the Protestant denominations in America, with the result that similar companies were formed in the United States. The work of the English revisers was regularly submitted to their consideration; their comments were carefully considered and largely adopted, and their divergences from the version ultimately agreed upon were printed in an appendix to the published work. Thus the Revised Version was the achievement of English-speaking Christendom as a whole; only the Roman Catholic Church, of the great English-speaking denominations, refused to take part in the undertaking. The Church of England, which had put forth the version of 1611, fitly initiated the work, but for its performance most wisely invited the help of the sister churches. The delegates of the Clarendon Press in Oxford, and the syndics of the Pitt Press in Cambridge, entered into a liberal arrangement with the revisers, by which the necessary funds were provided for all their expenses. On the completion of its work the New Testament company divided itself into three committees, working at London, Westminster and Cambridge, for the purpose of revising the Apocrypha.

The work of the Old Testament company was different in some important respects from that which engaged the attention of the New Testament company. The received Hebrew text has undergone but little emendation, and the revisers had before them substantially the same Massoretic text which was in the hands of the translators of 1611. It was felt that there was no sufficient justification to make any attempt at an entire reconstruction of the text on the authority of the versions. The Old Testament revisers were therefore spared much of the

1 A reprint of this edition has been published by the Clarendon Press (Oxford, 1833).

labour of deciding between different readings, which formed one of the most important duties of the New Testament company. But the advance in the study of Hebrew since the early part of the 17th century enabled them to give a more faithful translation of the received text. The value of their work is evident, especially in Job, Ecclesiastes and the prophetic books.

It is the work of the New Testament committee which has attracted most attention, whether for blame or praise. The critical resources at the disposal of scholars in 1611 were very meagre, and the few early manuscripts with which they were acquainted failed to receive the attention they deserved. The results of modern critical methods could not fail to make the incompleteness of the "Received Text," and of the "Authorized Version," which was based on it, obvious. It had long been the opinion of all competent scholars that a thorough revision was necessary. A proposal in favour of this course was made in Convocation in 1756, but it was not until fourteen years later that the committee was appointed to undertake the work. The revisers' first task was to reconstruct the Greek text, as the necessary foundation of their work. In this difficult duty they were no doubt influenced by Westcott and Hort's edition of the New Testament. These two scholars were members of the committee which prepared the Revised Version, and on the question of various readings they appear to have exercised a predominating influence. The revisers were privately supplied with instalments of Westcott and Hort's text as their work required them. But it is scarcely necessary to say that the Revised Version is not the work of one or two scholars. Different schools of criticism were represented on the committee, and the most careful discussion took place before any decision was formed. Every precaution was taken to ensure that the version should represent the result of the best scholarship of the time, applied to the work before it with constant devotion and with the highest sense of responsibility. The changes in the Greek text of the Authorized Version when compared with the *textus receptus* are numerous, but the contrast between the English versions of 1611 and 1881 is all the more striking because of the difference in the method of translation which was adopted. The revisers aimed at the most scrupulous faithfulness. They adopted the plan—deliberately rejected by the translators of 1611—of always using the same English word for the same Greek word. "They endeavoured to enable the English reader to follow the correspondences of the original with the closest exactness, to catch the solemn repetition of words and phrases, to mark the subtleties of expression, to feel even the strangeness of unusual forms of speech."

The revision of the New Testament was completed in 407 meetings, distributed over more than ten years. It was formally presented to Convocation on May 17, 1881. The revision of the Old Testament occupied 792 days, and was finished on June 20, 1884. The revised Apocrypha did not make its appearance until 1895.

The text of the Revised Version is printed in paragraphs, the old division of books into chapters and verses being retained for convenience of reference. By this arrangement the capricious divisions of some books is avoided. Various editions of the New Version have been published, the most complete being the edition of the whole Bible with marginal references. These references had their origin in the work of two small sub-committees of the revisers, but they received their present form at the hands of a specially appointed committee. The marginal references given in the original edition of the Authorized Version of 1611 have been retained as far as possible.

The work of the revisers was received without enthusiasm. It was too thorough for the majority of religious people. Partisans found that havoc had been played with their profane texts. Ecclesiastical conservatives were scandalized by the freedom with which the traditional text was treated. The advocates of change were disinterested with the hesitating acceptance which their principles had obtained. The most vulnerable side of the revision was that on which the mass of English readers thought itself capable of forming a judgment. The general effect of so many small alterations was to spoil the

familiar sonorous style of the Authorized Version. The changes were freely denounced as equally petty and vexatious; they were, moreover, too often inconsistent with the avowed principles of the revisers. The method of determining readings and renderings by vote was not favourable to the consistency and literary character of the Version. A whole literature of criticism and apology made its appearance, and the achievement of so many years of patient labour seemed destined to perish in a storm of resentments. On the whole, the Revised Version weathered the storm more successfully than might have been expected. Its considerable excellences were better realized by students than stated by apologists. The hue and cry of the critics largely died away, and was replaced by a calmer and juster appreciation.

The work of the revisers has been sharply criticized from the standpoint of specialists in New Testament Greek. Dr Rutherford stated the case briefly and pointedly in the preface to his translation of the Epistle to the Romans (London, 1900). He maintains that "the Greek of the New Testament may never be understood as classical Greek is understood," and accuses the revisers of distorting the meaning "by translating in accordance with Attic idiom phrases that convey in later Greek a wholly different sense, the sense which the earlier translators in happy ignorance had recognized that the context demanded."

The use of the new Version has become general. Familiarity has mitigated the harshness of the revisers' renderings; scholarship, on the whole, has confirmed their readings. The Version has been publicly read in parish churches both in London and in the country. In Canterbury cathedral and Westminster Abbey it has definitely displaced the older Version. Bishops have acquiesced and congregations approved. It is no longer possible to maintain the plausible and damaging contention that the Revised Bible is ill suited for public use. The Upper House of the Convocation of Canterbury in May 1898 appointed a committee to consider the expediency of "permitting or encouraging" the use of the Revised Version in the public services of the Church. (H. H. H.)*

BIBLIOGRAPHY.—The principal works dealing with the separate versions have been referred to in the text of the article. The following authorities may also be cited:

For the version as a whole: J. R. Dore, *Old Bibles* (2nd ed., 1888); J. Eadie, *The English Bible: an External and Critical History of the various English Translations of Scripture* (2 vols., 1876; the most complete account); A. Edgar, *The Bibles of England* (1889); H. W. Hoare, *The Evolution of the English Bible* (2nd ed., 1902; gives historical setting of the Versions); F. G. Kenyon, *Our Bible and the Ancient Manuscripts* (1895); J. H. Lupton, article on "English Versions," in Hastings' *Dict. of the Bible* (extra vol.); R. Lovett, *The Printed English Bible, 1525-1885* (1894); G. Milligan, *The English Bible, a Sketch of its History* (1895); J. I. Mombert, *English Versions of the Bible* (1883); F. Moulton, *The History of the English Bible* (2nd ed., 1884); T. H. Pattison, *History of the English Bible* (1894); J. Stoughton, *Our English Bible, its Translations and Translators* [1878].

For the earlier history: J. Lewis, *History of English Translations of the Bible* (1818); the historical accounts prefixed to Bagster's issue of *The English Hexapla* and of Forshall and Madden's edition of the *Wycliffe Versions* (Oxford, 1850). These are all to a great extent antiquated, their errors being repeated in almost all subsequent accounts of the subject. The only trustworthy authority on the Anglo-Saxon Bible is A. S. Cook's "Introduction on Old English Translations of the Bible," in *Biblical Quotations in Old English Prose-versions*.

For the 14th and 15th centuries: See A. C. Paus, *The Bible in the Fourteenth Century*.

For the early printed Bibles: H. Cotton, *List of Editions of the Bible* (1852); Rhemes and Douay (1855); F. Fry, *The Bible by Coverdale* (1867); *Description of the Great Bible, 1539* (1865); *Bibliographical Descriptions of the Editions of the New Testament* (1878); N. Poyce, "On the Bishops' and Geneva Bible," (*Bibliographer*, vols. 1-iv.); Prime Wendell, *Fifteenth-Century Bibles* (1888); John Wright, *Early Bibles of America* (1893).

For the Authorized Version: F. H. A. Scrivener, *The Authorized Edition of the English Bible* (1884). See also R. Gell, *Essay toward the Amendment of the Authorized Version* (1659); W. Kilburne, *Dangerous Errors in . . . Bibles* (1659); R. C. Trench, *On the Authorized Version of the New Testament in connexion with some recent proposals for its revision* (2nd ed., 1859).

For the Revised Version: J. B. Lightfoot, *On a Fresh Revision of the English New Testament* (London, 1871; 3rd ed. 1891); Westcott, *Some Lessons of the Revised Version* (London, 1897); Kennedy,

Ely Lectures on the Revised Version (London, 1882). The Revisers fully explained their principles and methods in the Preface. The American Committee of Revision issued an historical account of their work (New York, 1885). The case against the Revisers is ably stated in *The Revision Revised*, by Dean Burgon (London, 1883). The literary defects of the Version are elaborately exhibited by G. Washington Moon in two works: *The Revisers' English* (London, 1882), and *Ecclesiastical English* (London, 1886). See also *Some Thoughts on the Textual Criticism of the New Testament*, by G. Salmon D.D. (London, 1897); Bishop Ellicott's *Charge* (1901). The Greek Text of the New Testament adopted by the Revisers was edited for the Clarendon Press by Archdeacon Palmer (Oxford, 1881). Parallel editions of the Bible, showing both the Authorized and Revised Versions, a large-type edition for public use, a reference edition, and (1900) a "Two Version" edition, have been issued by one or both the University Presses. (A. C. P.; H. H. H.)*

BIBLE CHRISTIANS, one of the denominations now merged in the United Methodist Church (see UNITED METHODISTS), so called because its early preachers appealed solely to the Bible in confirmation of their doctrines. The denomination arose in the agricultural districts and fishing villages of north Cornwall and Devon; a district only slightly influenced by John Wesley and the original Methodist movement. The founder was William O'Bryan (afterwards Bryant), a Methodist lay preacher of Lullinian, Cornwall. Finding that the people had no evangelical preaching he began an itinerary to supply the need. The coastmen were expert smugglers and wreckers, the agriculturists were ignorant and drunken, the parish clergy were slothful, in many cases intemperate, and largely given to fox-hunting. Only in a parish or two was there any approach to religious ministry. O'Bryan commenced his labours in north Devon, and in 1815 a small society was formed at Lake Farm, Shebbear. The movement had the seeds of great vitality in it. In 1819 the first conference was held at Launceston. There were present besides O'Bryan one accepted minister—James Thorne—fourteen ministers on trial and fifteen women preachers, a class that was always conspicuous in the denomination. At that conference the work had spread from Ring's Ash in Devon to Morrah, a lonely and desolate parish in west Cornwall. In 1820–1821 Kent, Northumberland, the Scilly and Norman (i.e. Channel) Islands appeared on the list of stations. Then came a serious break. In 1829 there was a severance between the larger part of the new-body and O'Bryan, who had claimed to be perpetual president, and to have all property vested in him personally. He tried to establish a separate conference, but failed, and in 1836 there was a re-union. O'Bryan left England for America, where he remained for the rest of his life, and his contingent (numbering 565 members and 4 ministers) returned to the original conference. The growth continued. In 1831 agents were sent to Canada and Prince Edward's Island, in 1850 to South Australia, in 1855 to Victoria, in 1866 to Queensland, in 1877 to New Zealand and in 1885 to China, so that the original O'Bryan tradition of fervid evangelism was amply maintained.

On O'Bryan's departure, James Thorne, the first fully recognized minister, at whose father's farm the connexion started, became its leader. Although reared as an ordinary farm lad, he proved to be a man of singular devotion and spiritual genius. He laid the foundations broadly in evangelism, finance, temperance and education, founding in the latter connexion a middle-class school at Shebbear, at which generations of ministers' sons and numerous students for the ministry have been educated. James Thorne was five times president of the conference and fifteen times secretary. He died in 1872. In this period there was much persecution. Landowners refused sites, and in the Isle of Wight the people worshipped for many months in a quarry. The preachers were sometimes imprisoned and many times assaulted. The old Methodist body even excommunicated persons for attending "Bryanite" meetings. Partly co-operative with James Thorne and at his death independently, the Church was favoured with the influence of Frederick William Bourne. He was a minister for fifty-five years, and served the Bible Christians as editor, missionary treasurer, book steward and three times president of conference. With him will always be associated the name of Billy Bray, an illiterate but inimitable Cornish evangelist, a memoir of whom, written by Bourne,

exerted a great influence in the religious life of the denomination.

In doctrine the Bible Christians did not differ from the other Methodists. In constitution they differed only slightly. There was an annual conference with full legislative power, and ability to hold and dispose of property, composed of an equal number of lay and ministerial representatives meeting together. The local churches were grouped into circuits governed representatively by a quarterly meeting. The quarterly or circuit meetings were in turn organized into twelve districts, eleven in England and one in China. In 1906 the statistics showed 218 ministers, 32,540 members and 652 chapels, with 47,301 scholars in Sunday-schools. These figures include nearly 1400 full and probationary members in the China mission, the first-fruits of two years' labour amongst the Miao tribe. In the various colonial Methodist unions the Bible Christians have contributed a total of 159 ministers, 14,925 members and 660 chapels.

The community supported a regular ministry from the beginning. Its members have been keen evangelists, trusting largely to "revivals" for their success, staunch Radicals in politics and total abstainers to a man. Both ministers and people entered with interest and sympathy into the scheme for union between themselves, the Methodist New Connexion and the United Methodist Free Church, which was successfully accomplished in 1906. See METHODISM.

BIBLE SOCIETIES, associations for translating and circulating the Holy Scriptures. This object has engaged the attention of the leaders of Christendom from early times. In an extant letter, dated A.D. 331, the emperor Constantine requested Eusebius, bishop of Caesarea, to provide him with fifty copies of the Old and New Testaments for use in the principal churches in Constantinople. In 797 Charlemagne commissioned Alcuin to prepare an emended text of the Vulgate; copies of this text were multiplied, not always accurately, in the famous writing-schools at Tours. The first book printed in Europe was the Latin Bible, and Copinger estimates that 124 editions of the Vulgate had been issued by the end of the 15th century. The Italian Bible was printed a dozen times before A.D. 1500, and eighteen editions of the German Bible had already been published before Luther's version appeared.

The Reformation quickened men's interest in the Scriptures to an extraordinary degree, so that, notwithstanding the adverse attitude adopted by the Roman Church at and after the council of Trent, the translation and circulation of the Bible were taken in hand with fresh zeal, and continued in more systematic fashion.

Thus, the Revised French Geneva Bible of 1588, which was issued in folio, quarto and octavo, and became a standard text, bears the following note on the verso of the title: "*Les frais de cet ouvrage, imprimé en trois diverses formes en mesme temps, pour la commodité et contentement de toutes sortes de personnes, ont esté libéralement fournis par plusieurs gens de bien, qui n'ont cherché qu'un seul pour leur particulier, mais seulement de servir à Dieu et à son Eglise.*" The Corporation for the Promoting and Propagating of the Gospel of Jesus Christ in New England (founded in 1649) bore the expense of printing both the New Testament and the Bible as a whole (Cambridge, Mass., 1663—the earliest Bible printed in America), which John Eliot, one of the Pilgrim Fathers, translated into "the language of the Massachusetts Indians," whom he evangelized. In Arnauld's *Défence* (1669) of the famous Port Royal version of the New Testament in French (issued, 1667), he states that it had been printed in many forms and sizes, including very cheap editions for the poor, and goes on to describe how its circulation was promoted by "*les sociétés qui se simoient les pieux solitaires pour faire participer les plus indigents au bienfait de leur entreprise. Dès que leur traduction fut prête, ils envoyèrent de Paris un grand nombre de colporteurs chargés de la vendre au prix de revient et même, dans certaines circonstances, à des prix réduits; et ils couvrirent la dépense par des dons volontaires*" (E. Pétavel, *La Bible en France*, p. 152).

To meet the cost of publishing the Finn Bible in 1685, the editor, J. Gezelius, bishop of Abo, obtained an order from the Swedish government for the appropriation of certain corn-tithes, still known as "*Gezelius' Trösk-Taxer*." When the Finnish Bible Society began to publish editions of the Scriptures, the tsar Alexander I. contributed 5000 roubles from his private purse, and ordered that these corn-tithes should again be appropriated to this purpose for five years from 1812. In 1701 at Frankfort-on-Main there appeared a quarto edition of the Ethiopic Psalter, whose editor, H. Ludolf, writes in his preface: "*Quomodo enim nullum gratis officium Christiane hinc nationi a me preceat: posse putavi, quam si Psalterium Aethiopicum, quod apud illos non aliter quam in membrana manuscriptum habetur, et caro solis venditur, typis mandari, et usque Africam exemplaria nostrorum societas in His nationibus gratis distribuere.*"

In 1719 appeared the first of numerous editions of the French

New Testament, connected with the name of the Abbé de Barneville, a priest of the Oratory at Paris. Impressed by the popular ignorance of the Scriptures, he himself translated, or caused others to translate, the New Testament into French from the Vulgate, and formed an association to distribute copies systematically at low prices. The prefaces to his various editions contain details as to the methods of this association, and repeatedly insist on the importance of reading the Scriptures. (On this *Société biblique catholique française* see O. Douen, *Histoire de la société biblique protestante de Paris*, Paris, 1868, pp. 46-51.)

Christian missionaries to non-Christian lands have naturally been among the most skilful translators and the most assiduous distributors of the Bible. The earliest complete Arabic Bible was produced at Rome in 1671, by the *Congregatio de Propaganda Fide*. Protestant missionary societies have engaged energetically in the task not only of translating, but of printing, publishing and distributing the Scriptures. Thus the Society for Promoting Christian Knowledge (founded 1698), besides its other activities, has done much to cheapen and multiply copies of the Scriptures, not only in English and Welsh, but in many foreign languages. Early in the 18th century it printed editions in Arabic, and promoted the first versions of the Bible in Tamil and Telugu, made by the Danish Lutheran missionaries whom it then supported in south India. The earliest New Testament (1767) and Old Testament (1783-1801) in Gaelic were published by the Society in Scotland for Propagating Christian Knowledge (founded 1700). The S.P.C.K. now publishes versions of the Scriptures (either complete, or in part) in 38 different languages (without reckoning versions of the Prayer Book in 45 other languages); and during 1905-1906 the S.P.C.K. issued in England 116,126 Bibles and 17,853 New Testaments.

The earliest noteworthy organization, formed for the specific purpose of circulating the Scriptures, was the Canstein Bible Institute (*Bibelanstalt*), founded in 1710 at Halle in Saxony, by Karl Hildebrand, baron von Canstein (1667-1719), who was associated with P. J. Spener and other leaders of Pietism in Germany. He invented a method of printing, perhaps somewhat akin to stereotyping—though the details are not clearly known,—whereby the Institute could produce Bibles and Testaments in Luther's version at a very low cost, and sell them, in small size, at prices equivalent to 10d. and 3d. per copy, respectively. In 1722 editions of the Scriptures were also issued in Bohemian and Polish. At von Canstein's death he left the Institute to the care of his friend August Hermann Francke, founder in 1698 of the famous *Waisenhaus* (orphanage) at Halle. The Canstein Institute has issued some 6,000,000 copies of the Scriptures.

In England various Christian organizations, which arose out of the Evangelical movement in the 18th century, took part in the work. Among such may be mentioned the Society for Promoting Christian Knowledge among the Poor (1750); and the Society for the Support and Encouragement of Sunday Schools (1785). An institution was founded in 1740 under the name of the Bible Society, but as its sphere was restricted to soldiers and seamen the title was afterwards changed to the Naval and Military Bible Society. The first ship among whose crew it distributed the Scriptures was the "Royal George," which had 400 of this society's Bibles on board when it foundered at Spithead on the 20th of August 1782. The French Bible Society, instituted in 1792, came to an end in 1803, owing to the Revolution.

The British and Foreign Bible Society.—In 1804 was founded in London the British and Foreign Bible Society, the most important association of its kind. It originated in a proposal made to the committee of the Religious Tract Society, by the Rev. Thomas Charles of Bala, who found that his evangelistic and philanthropic labours in Wales were sorely hindered by the dearth of Welsh Bibles. His colleagues in the Religious Tract Society united with other earnest evangelical leaders to establish a new society, which should have for its sole object "to encourage a wider circulation of the Holy Scriptures, without note or comment." This simplicity of aim is combined with a catholicity of constitution which admits the co-operation of all persons interested in the society's object. The committee of management consists of thirty-six laymen, six of them being

foreigners resident in or near London, while of the remaining thirty, half are members of the Church of England, and half are members of other Christian denominations.

Supported by representative Christian leaders, such as Granville Sharp, Zachary Macaulay, William Wilberforce, Charles Grant and Henry Thornton, with Lord Teignmouth, ex-governor-general of India, as its first president, and Dr Porteus, bishop of London, as its friendly counsellor, the new society made rapid progress. It spread throughout Great Britain, mainly by means of auxiliaries, *i.e.* local societies, affiliated but self-controlled, with subsidiary branches and associations (these last being often managed by women). Up to 1816-1817 the parent society had received from its auxiliaries altogether £420,000. This system continues to flourish. In 1905-1906 the society had about 5800 auxiliaries, branches and associations in England and Wales, and more than 2000 auxiliaries abroad, mainly in the British Colonies, many of which undertake vigorous local work, besides remitting contributions to London.

The society's advance was chequered by several controversies. (a) Its fundamental law to circulate the Bible alone, without note or comment, was vehemently attacked by Bishop Marsh and other divines of the Church of England, who insisted that the Prayer Book ought to accompany the Bible. (b) Another more serious controversy related to the circulation—chiefly through affiliated societies on the continent—of Bibles containing the Deutero-canonical books of the Old Testament. In 1826 the society finally resolved that its fundamental law be fully and distinctly recognized as excluding the circulation "of those Books, or parts of Books, which are usually termed Apocryphal." This step, however, failed to satisfy most of the society's supporters in Scotland, who proceeded to form themselves into independent organizations, grouped for the most part round centres at Edinburgh and Glasgow. These were finally amalgamated in 1861 into the National Bible Society of Scotland. (c) A third dispute turned upon the admissibility of non-Trinitarians to the privilege of co-operation. The refusal of the society to alter its constitution so as formally to exclude such persons led to the formation (1831) of the Trinitarian Bible Society, which is still in existence. (d) A fourth controversy arose out of the restrictive renderings of the term "baptize" and its cognate terms, adopted by William Carey and his colleagues in their famous "Serampore Version" of the Bible, which the society had contributed up to 1830 nearly £30,000. Protests from other Indian missionaries led the society to determine that it could circulate only such versions as gave neutral renderings for the terms in question. As a sequel, the Bible Translation Society was founded in 1839 to issue versions embodying distinctively Baptist renderings.

By one of its original laws the British and Foreign Bible Society could circulate no copies of the Scriptures in English other than King James's Version of 1611. In 1901 this law was widened to include the Revised English Version of 1881-1885.

From its foundation the society has successfully laboured to promote new and improved versions of the Scriptures. In 1804 the Bible, or some part of it, had been printed in about fifty-five different tongues. By the year 1906 versions, more or less complete, had been published in more than 530 distinct languages and dialects, and in 400 of these the work of translation, printing or distribution had been promoted by the society. Translations or revisions in scores of languages are still being carried on by companies of scholars and representative missionaries in different parts of the world, organized under the society's auspices and largely at its expense. New versions are made, wherever practicable, from the original Hebrew or Greek text, and the results thus obtained have a high philological value and interest. The society's interdenominational character has commonly secured—what could hardly otherwise have been attained—the acceptance of the same version by missions of different churches working side by side. The society supplies the Scriptures to missions of every Reformed Communion on such terms that, as a rule, the books distributed by the missions involve no charge on their funds. Except under special circumstances, the society does not encourage wholesale free distribution, but provides cheap editions at prices which the poorest can pay. On the whole it receives from sales about 40% of what it expends in preparing, printing and circulating the books.

During the year 1905-1906 the society's circulation reached the unprecedented total of 5,977,453 copies, including 968,683 Bibles and 1,326,475 Testaments. Of the whole 1,921,000 volumes were issued from the Bible House of London, and 1,331,000 were in English or Welsh, circulating chiefly in England and the British colonies. The other main fields of distribution were as follows:—France, 205,000 copies; Central Europe, 679,000; Italy, 117,000; Spain and Portugal, 120,000; the Russian empire, 595,000; India, Burma and Ceylon, 768,000; Japan, 286,000; and China, 1,075,000 (most of these last being separate gospels).

The society spends £10,000 a year in grants to religious and philanthropic agencies at home. Outside the United Kingdom

it has its own agencies or secretaries in twenty-seven of the chief cities of the world, and maintains depots in 200 other centres. It employs 930 Christian colporteurs abroad, who sold in 1905-1906 over 2,250,000 volumes. It supports 670 native Christian Biblewomen in the East, in connexion with forty different missionary organizations. The centenary festival in 1904 was celebrated with enthusiasm by the Reformed Churches and their foreign missions throughout the world. Messages of congratulation came from the rulers of every Protestant nation in Christendom, and a centenary thanksgiving fund of 250,000 guineas was raised for extending the society's work. During the year 1905-1906 the society expended £238,652, while its income was £231,964 (of which £98,204 represented receipts from sales). Up to the 31st of March 1906 the society had expended altogether £14,686,072, and had issued 198,515,199 copies of the Scriptures—of which more than 78,000,000 were in English.

In Scotland the Edinburgh Bible Society (1809), the Glasgow Bible Society (1812), and other Scottish auxiliaries, many of which had dissociated themselves from the British and Foreign Bible Society after 1826, were finally incorporated (1861) with the National Bible Society of Scotland, which has carried on vigorous work all over the world, especially in China. During 1905, with an income of £27,108, it issued 1,590,881 copies, 907,000 of which were circulated in China. Its total issues from 1861 to 1906 were 26,106,265 volumes.

In Ireland the Hibernian Bible Society (originally known as the Dublin Bible Society) was founded in 1806, and with it were federated kindred Irish associations formed at Cork, Belfast, Derry, &c. The Hibernian Bible Society, whose centenary was celebrated in 1906, had then issued a total of 5,713,837 copies. It sends an annual subsidy to aid the foreign work of the British and Foreign Bible Society.

Other European Societies.—The impulse which founded the British and Foreign Bible Society in 1804 soon spread over Europe, and, notwithstanding the turmoils of the Napoleonic wars, kindred organizations on similar lines quickly sprang up, promoted and subsidized by the British and Foreign Bible Society. Many of these secured royal and aristocratic patronage and encouragement—the tsar of Russia, the kings of Prussia, Bavaria, Sweden, Denmark and Württemberg all lending their influence to the enterprise.

Within fourteen years the following Bible societies were in active operation: the Basel Bible Society (founded at Nuremberg, 1804), the Prussian Bible Society (founded as the Berlin Bible Society, 1805), the Revel Bible Society (1807), the Swedish Evangelical Society (1808), the Dorpat Bible Society (1811), the Riga Bible Society (1812), the Finnish Bible Society (1812), the Hungarian Bible Institution (Pressburg, 1812), the Württemberg Bible Society (Stuttgart, 1812), the Swedish Bible Society (1814), the Danish Bible Society (1814), the Saxon Bible Society (Dresden, 1814), the Thuringian Bible Society (Erfurt, 1814), the Berg Bible Society (Eberfeld, 1814), the Hanover Bible Society (1814), the Hamburg-Altona Bible Society (1814), the Lübeck Bible Society (1814), the Netherlands Bible Society (Amsterdam, 1814). These were increased in 1815 by the Brunswick, Bremen, Schleswig-Holstein, Strassburg and Eichsfeld (Saxony) Bible Societies, and the Icelandic Bible Society. In 1816-1817 came the Norwegian Bible Society, the Polish Bible Society and ten minor German Bible Societies. Twelve cantonal societies had also been formed in Switzerland.

Up to 1816-1817 these societies had printed altogether 436,000 copies of the Scriptures, and had received from the British and Foreign Bible Society gifts amounting to over £62,000. The decision of the British and Foreign Bible Society in 1826 with regard to circulating the Apocrypha (see above) modified its relations with the most influential of these continental societies. Some of them were ultimately dissolved or suppressed through political or ecclesiastical opposition, the Roman Church proving especially hostile. But many of them still flourish, and are actively engaged in their original task.

The circulation of the Scriptures by German Bible Societies during 1905 was estimated as follows:—The Prussian Bible Society (Berlin), 182,000 copies; the Württemberg Bible Institute (Stuttgart), 247,000; the Berg Bible Society (Eberfeld), 142,000; the Saxon Bible Society (Dresden), 44,000; the Central Bible Association (Nuremberg), 14,000; the Canstein Bible Institute (Halle), the

Schleswig-Holstein Bible Society, the Hamburg-Altona Bible Society and others, together, 56,000.

During 1905, nine cantonal Bible societies in Switzerland circulated altogether 71,000 copies; the Netherlands Bible Society reported a circulation of 54,544 volumes, 48,137 of which were in Dutch; the Danish Bible Society circulated 45,289 copies; the Norwegian Bible Society circulated 67,082 copies; and in Sweden the Evangelical National Society distributed about 11,000 copies.

In Italy, by a departure from the traditional policy of the Roman Church, the newly formed "Pious Society of St Jerome for the Dissemination of the Holy Gospels" issued in 1901 from the Vatican press a new Italian version of the Four Gospels and *Acts*. By the end of 1905 the society announced that over 400,000 copies of this volume had been sold at 2d. a copy.

In France, the *Société biblique protestante de Paris*, founded in 1818, with generous aid from the British and Foreign Bible Society, had a somewhat restricted basis and scope. In 1833 the *Société biblique française et étrangère* was formed on wider lines; after its dissolution in 1863, many of its supporters joined the *Société biblique de France*, which dates from 1864, and represents chiefly members of the *Eglise libre*, and kindred French Evangelicals. During 1905 its issues were 34,475 copies, while the *Société biblique protestante de Paris* issued 8061 copies.

Of these non-British societies the most noteworthy was established in Russia. In December 1812, while "the last shattered remnants of Napoleon's Grand Army struggled across the ice of the Niemen," the tsar Alexander I. sanctioned plans for a Bible society, which was promptly inaugurated at St Petersburg under the presidency of Prince Galitzin. Through the personal favour of the tsar, it made rapid and remarkable progress. Nobles and ministers of state, with the chief ecclesiastics not only of the Russian Church but of the Roman, the Uniat, the Armenian, the Greek, the Georgian and the Lutheran Churches, found themselves constrained to serve on its committees. By the close of 1823 the Russian Bible Society had formed 289 auxiliaries, extending eastwards to Yakutsk and beyond Okhotsk; and had received altogether £145,640. In 1824, however, Prince Galitzin ceased to be procurator of the Holy Synod, and Seraphim, metropolitan of St Petersburg, became president of the Russian Bible Society. And in 1826, soon after his accession, the tsar Nicholas I. issued a *ukase* suspending the society's operations—after it had printed the Scriptures in thirty different languages, seventeen of which were new tongues, and had circulated 600,000 volumes in French and German to Kamchatka. In 1828 Nicholas I. sanctioned the establishment of a Protestant Bible Society, which still exists, to supply the Scriptures only to Protestant subjects of the tsar (cf. Th. Schieman, *Geschichte Russlands unter Nikolaus I.* vol. i. chap. ix.). In 1839 St Petersburg became the headquarters of an agency of the British and Foreign Bible Society, which enjoys special facilities in Russia, and now annually circulates about 600,000 copies of the Scriptures, in fifty different languages, within the Russian empire.

In America the earliest Bible society was founded at Philadelphia in 1808. Six more societies—including those of New York and of Massachusetts—were formed during 1809, and other societies, auxiliaries and associations quickly followed. In 1816 a convention of delegates representing 31 of these institutions met at New York and established the American Bible Society, with Elias Boudinot as president. All kindred organizations in the states gradually became amalgamated with this national body, and the federation was completed in 1830 by the adhesion of the Philadelphia Society (which now changed its name to the Pennsylvania Bible Society). Not a few noteworthy versions of the Bible, such as those in Arabic, 15 dialects of Chinese, Armenian, and Zulu, and many American Indian, Philippine, and African languages have appeared under the auspices of the American Bible Society. Turkish, classical Chinese, and Korean versions have been made by the American and British societies jointly. The society's foreign agencies extend to China, Japan, Korea, the Turkish empire, Bulgaria, Egypt, Micronesia, Siam, Mexico, Central America, the South American republics, Cuba and the Philippines. In the year ending March 31st 1906 the income of the Society was \$502,345, and it issued 2,153,028 copies of the Scriptures, nearly half of which went to readers outside the United States. The total distribution effected by the American Bible Society and its federated societies had in 1906 exceeded 84,000,000 volumes, in over a hundred different languages.

AUTHORITIES.—Besides the published reports of the societies in question, the following works may be mentioned: J. Owen, *History of the Bible Societies of the British and Foreign Bible Society* (London, 1816-1820); G. Browne, *History of the Bible Society* (London, 1859); Bertram, *Geschichte der Cansteinischen Bibelanstalt* (Halle, 1863); E. Pétavel, *La Bible en France* (Paris, 1864); O. Douen, *Histoire de la société biblique protestante de Paris* (Paris, 1868); G. Borrow,

The Bible in Spain (London, 1849); W. Canton, *The History of the British and Foreign Bible Society* (London, 1904 [oll.]); J. Ballinger, *The Bible in Wales* (London, 1906); T. H. Darlow and H. F. Moule, *Historical Catalogue of the Printed Editions of Holy Scripture* (London, vol. i. 1903, vol. ii. 1908). (T. H. D.)

BIBLIOGRAPHY AND BIBLIOLOGY. The word βιβλιογραφία was used in post-classical Greek for the writing of books, and as late as 1761, in Fenning's *English Dictionary*, a bibliographer is defined as "one who writes or copies books." The transition from the meaning "a writing of books" to that of "a writing about books," was accomplished in France in the 18th century—witness the publication in 1763 of the *Bibliographie instructive* of de Bure. In England the new meaning seems to have been popularized by the Rev. Thomas Frognal Dibdin early in the 19th century, while Southey preferred the rival form *bibliology*, which is now hardly used. Present custom inclines to restrict the province of bibliography to printed books as opposed to manuscripts, and on the other hand recognizes as coming within its scope almost everything in which a book-loving antiquary can be interested, including the history of printing (see TYPOGRAPHY), book-binding (*q.v.*), book-illustration (see ILLUSTRATION) and book-collecting (*q.v.*). The present article is only concerned with bibliography as the art of the examination, collation and description of books, their enumeration and arrangement in lists for purposes of information, and further with the literature of this subject, *i.e.* with the bibliography of bibliography.

Examination and Collation.—Books are submitted to examination in order to discover their origin, or to test statements concerning it which there is reason to doubt, or to ascertain if they are perfect, and if perfect whether they are in their original condition or have been "made up" from other copies. The discovery of where, when and by whom a book, or fragment of a book, was printed, is the most difficult of these tasks, though as regards books printed in the 15th century it has been much facilitated by the numerous facsimiles enumerated under INCUNABULA (*q.v.*). In the article BOOK (*q.v.*) a sketch is given of the chief external characteristics of books in each century since the invention of printing. Familiarity with books of different ages and countries soon creates a series of general ideas as to the dates and places with which any combination of these characteristics may be connected, and an experienced bibliographer, more especially if he knows something of the history of paper, will quickly narrow down the field of inquiry sufficiently to make special search possible.

As regards the correction of mis-statements in early books as to their place and origin, glaring piracies such as the Lyonnese counterfeiters of the octavo editions of the classics printed by Aldus at Venice, and the numerous unauthorized editions of works by Luther, professing to be printed at Wittenberg, have long ago been exposed. A different variety of the same kind of puzzle arises from the existence of numerous original editions with fictitious imprints. As early as 1499 a Brescia printer, in order to evade the privilege granted to Aldus, gave to an edition of Politian the spurious imprint "Florentinae," and in the 16th century many controversial books printed in England purported to have been issued in German towns, or with pleasant humour, "at Rome before the castle of S. Angel at the sign of S. Peter." Only a knowledge of the general characteristics which a book printed at such a place and such a time should possess will secure avoidance of these traps, but when suspicion has been aroused the whole story will often be found in such books as Weller's *Die maskierte Literatur der älteren und neueren Sprachen* (1856-1867), and *Die falschen und fingierten Drucke* (1864), Brunet's *Imprimeurs imaginaires et libraires supposés* (1866), de Broullant's *La Liberté de la Presse en France; Histoire de Pierre du Marteau, imprimeur à Cologne, &c.* (1888); in the various bibliographies of Erotica and in Brunet's *Manuel de l'Amateur* and other handbooks for the use of collectors. A special case of this problem of piracies and spurious imprints is that of the modern photographic or type-facsimile forgery of small books possessing a high commercial value, such as the early editions of the letter of Columbus announcing his discovery

of the New World. Bad forgeries of this kind can be detected by the tendency of all photographic processes of reproduction to thicken letters and exaggerate every kind of defect, but the best of these imitations when printed on old paper require a specific knowledge of the originals and often cause great trouble. The type-facsimile forgeries are mostly of short pieces by Tennyson, George Eliot and A. C. Swinburne, printed (or supposed to have been printed—for it is doubtful if some of these "forgeries" ever had any originals) for circulation among friends. These trifles should never be purchased without a written guarantee.

When the edition to which a book belongs is known, further examination is needed to ascertain if it is perfect and in its original state. Where no standard collation is available, this can only be ascertained by a detailed examination of the quires or gatherings of which it is made up (see below). In the earliest books these are often very irregular. A large book was usually printed simultaneously in four or six sections on as many different presses, and the several compositors, if unable to end their sections at the end of a complete quire, would insert a single leaf to give more space, or sometimes leave a blank page, or half page, for lack of matter, occasionally adding the note "*Hic nullus est defectus.*" A careful examination of the text, a task from which bibliographers often shrink, and a comparison with other editions, are the only remedies in these cases.

If a copy contains the right number of leaves, the further question arises as to whether any of these have been supplied from other copies, or are in facsimile. Few collectors even now are educated enough to prefer copies in the condition in which the ravages of time have left them to those which have been "completed" by dealers; hence many old books have been "made up" with leaves from other copies, or not infrequently from other editions. These meddlings often defy detection, but proof of them may be found in differences in the height and colour of the paper, in the two corresponding leaves at either end of a folio quire both possessing a watermark, or in their wiremarks not corresponding, or (in very early books) by the ornamentation added by hand being in a different style.

When it has been ascertained that a copy contains the right number of leaves and that all these leaves are original, the last point to be settled is as to whether it differs in any respect from the standard collation. Owing to the extreme slowness of the presswork for the first two centuries after the invention of printing, there were more opportunities for making small corrections while an old book was passing through the press than there are in the case of modern ones, and on the other hand the balls used for inking the type sometimes caught up words or individual letters and these were replaced by the compositors as best they could. The small variations in the text noticed in different copies of the First Folio edition of Shakespeare, and again of Milton's *Paradise Lost*, are probably to be explained by a mixture of these two causes. Where a serious error was discovered after a sheet had been printed off, the leaf on which it occurred was sometimes cut out and a new leaf (called a "cancel") printed to replace it and pasted on to the rest of the sheet. Variations between different copies of the first edition of Herrick's *Hesperides* which have puzzled all his editors are due to the presence of several of such cancels. Lastly, a printer when he had printed part of a book might wish to increase the size of the edition, and the leaves already printed off would have to be reprinted, thus causing a combination of identical and different leaves in different copies. The famous 42-line Bible of c. 1455, variously attributed to Gutenberg and to Fust and Schoeffer, and the *Valerius Maximus* printed by Schoeffer in 1471, are instances of editions being thus enlarged while passing through the press. As each book was set up simultaneously on several different presses, the reprinted leaves occur at the beginning of each of the sections.

It should be mentioned that there are books of which it is difficult to find two copies in exact agreement. Either to quicken presswork or to comply with trade-regulations made in the interest of compositors, in some books of which large

numbers were required, e.g. the *Paraphrases of Erasmus*, the *First Prayer-book of Edward VI.*, and the "Songs and Sonnets" known as *Tottell's Miscellany*, each forme was set up two or more different times. The formes were then used at haphazard for printing, and both at this stage and when the printed sheets came to be stitched almost any number of different combinations might be made. The books named were all printed in the middle of the 16th century, but probably later instances could be produced.

Description.—The ideal towards which all bibliographical work should be directed is the provision in an accessible form of a standard description of a perfect copy of every book of literary, historical or typographical interest as it first issued from the press, and of all the variant issues and editions of it. When such standard descriptions shall have been made, adequately checked and printed, it will be possible to describe every individual copy by a simple reference to them, with a statement of its differences, if any, and an insistence on the points bearing on the special object with which it is being re-described. Only in a few cases has any approach been made to a collection of such standard descriptions. One instance which may be cited is that of the entries of the 15th century books in the *Repertorium Bibliographicum* of Ludwig Hain (1826-1838), which the addition of an asterisk marks as having been examined by Hain himself in the copies in the Royal library at Munich. The high standard of accuracy of these asterisked entries (save for the omission to note blank leaves at the beginning or end) has been so well established, and the *Repertorium* is so widely known, that in many catalogues of incunabula the short title of the book together with the number of Hain's entry has been usefully substituted for a long description. Books printed at Oxford up to 1640 can be equally well described by their short titles and a reference to Mr Falconer Madan's *Early Oxford Press* published in 1895. At present the number of works which can thus be taken as a standard is only small, owing partly to the greater and more accurate detail now demanded, partly to the absence of any system of co-operation among libraries, each of which is only willing to pay for catalogues relating exclusively to its own collections. It may be hoped that through the foundation of bibliographical institutes more work of this kind may be done.

A standard description of any book must, as a rule, consist of the following sections, though in the case of works which have no typographical interest, some of the details may be advantageously omitted:—(a) A literal transcript of the title-page, also of the colophon, if any, and of any headings or other portions of the book serving to distinguish it from other issues; (b) Statements as to the size or form of the book, the gatherings or quires of which it is made up, with the total number of leaves, the measurement of an uncut copy or of the type-page, a note of the types in which different parts of the book are printed, and a reference to any trustworthy information already in print; (c) A statement of the literary contents of the book and of the points at which they respectively begin; (d) A note giving any additional information which may be needed.

(a) In transcribing the title-page and other parts of the book it is desirable not to omit intermediate words; if an omission is made it should be indicated by three dots placed close together. The end of a line should be indicated by an upright stroke.¹ It is a considerable gain to indicate to the eye in what types the words transcribed are printed, i.e. whether in roman, gothic letter, or italic, and in each case whether in majuscules or minuscules ("upper or lower case"). To do this, however, adds greatly not only to the cost of printing, but also to the liability of error. If roman minuscules are used throughout, or roman for the text and italic for the imprint of colophon, the method of transliteration which the printer himself would have used should be adopted. Many of the best modern catalogues and bibliographies are disfigured by the occurrence in them of such forms as "qvinque," "queen," "Evrope," due to an unintelligent transliteration of the forms QVINQVE, QUEEN, EVROPE, as they occur on title-pages at a date when "V" was the majuscule form of both "v" and "u." If it is de-

¹ Some bibliographers prefer to use double strokes to avoid confusion with the old-fashioned long commas. Others use a single stroke to indicate the space between two lines and increase the number of strokes where the space left is wider than this.

sired to retain the V forms the words should be printed in majuscules. If minuscules are used, the words should be transliterated as quinque, queen, Europe, according to the practice of the old printers themselves.

A troublesome question often arises as to what notice should be taken of the misprints which frequently occur in the original titles. Bibliographers who have satisfied themselves (and their readers) of their own accuracy may reproduce them in silence, though it will need constant watchfulness to prevent the printer from "setting them right." Transcribers of only average accuracy will consult their happiness by indicating the misprint in some way, and the frequent use of (*sic*), more especially when printed in italics, or of the German (j), being ugly, probably the simplest plan is to add a note at the end stating that the misprints in question occur in the original.

(b) The "size" of a book is a technical expression for the relation of the individual leaves to the sheet of paper of which they form a part. A book in-folio means one in which the paper has been folded once, so that each sheet has made two leaves. In a book in-quarto, each sheet has been folded twice so as to make four leaves. In an octavo another fold has produced eight leaves, and so on for books in 16mo, 32mo and 64mo. For books in twelves, twenty-fours, &c., the paper has at some stage to be folded in three instead of two, and there will be some difference in form according to the way in which this is done. The size of a book printed on handmade paper "is very simply recognized by holding up a page to the light." Certain white lines, called wire-lines, will be noticed, occurring at regular intervals, one inch apart, and running at right angles to the fine lines. These wire-lines are perpendicular in a folio, octavo, 32 mo, and horizontal in a quarto and 16mo. In a 12mo, as the name implies, the sheet is folded in twelve; and in the earlier part at least of the 16th century this was done in such a way that the wire-lines are perpendicular, the height of the sheet forming two pages, as is the case in an octavo, while the width is divided into six instead of into four as in an octavo. The latter habit has been to fold the sheet differently, the height of the sheet forming the width of four pages, and the width of the sheet the height of three pages, consequently, the wire-lines are horizontal" (E. G. Duff, *Early Printed Books*, pp. 206-207).

The recognition of what is meant by the size of a book has been obscured by the erroneous idea that the quires or gatherings of which books are made up necessarily consist of single sheets.² If this were so all folios would be in gatherings of two leaves each; all quartos in gatherings of four leaves; all octavos in gatherings of eight. In the earlier printed books, however, the paper was in general true of octavos, but to reduce the amount of sewing the earliest folios were usually arranged in tens, i.e. in gatherings of five sheets or ten leaves, while in Shakespeare's time English folios were mostly in sixes. In the same way quartos are often found made up in eights, and on the other hand the use of a half-sheet produces a gathering of only two leaves.

When a manuscript or early printed book was being prepared for binding, it was usual for the order in which the quires or gatherings were to be arranged to be indicated by signing them with the letters of the alphabet in their order, the alphabet generally used being the Latin, in which I stands for both I and J; V for both U and V, and there is no W. If more than twenty-three letters were needed the contractions for *et*, *con*, *rum* and (less often) that for *us*, were used as additional signs, and for large books minuscules were used as well as majuscules, and the letters were doubled. In 1472 printed signatures came into use. If the quires or gatherings in the book to be described are signed in print, the signatures used should be quoted without brackets. If they are not signed, the order of the gatherings should be noted by the letters of the alphabet in square brackets. In each case the number of leaves in each gathering should be shown by index-figures. Thus, six gatherings of eight leaves followed by one of four should be represented by the symbols A-F⁸ G⁴. The "make-up" of an old book in original binding is usually sufficiently shown by the strings in the middle of each quire. In books which have been rebound help may sometimes be obtained from the fact that between (roughly) 1750 and 1850, a period during which there was much rebinding of early books, the gatherings before being put into their new quires were mostly separately pressed, with the result that the outer pages of each gathering are much smoother than the rest. But the only safe guide to the make-up of an old book without printed signatures is a collation by means of the watermarks, i.e. the devices with which the papermaker as a rule marked each sheet (see PAPER). In a folio book one of every four leaves should have a watermark in the middle of the paper. In a quarto some pairs of leaves will have no watermark; in others it will be found divided by the fold of the paper. As the great majority of books without printed signatures are in folio or quarto,

² It may be noted that some confusion is caused in descriptions of books by the word "sheet," which should be restricted to the original sheet of paper, which in twelves, folio, quarto, &c., being applied also to the double-fold of four pages. A word specially appropriated to this is greatly needed, and as gatherings of two, three, four, &c., of such double-leaves are known technically as duenns, ternions, quaternions, &c., the double-fold itself might well be called a "unit."

the sequence of watermarked and un-watermarked leaves, if carefully worked out, will mostly reveal the "make-up" of the successive gatherings.

After the size and sequence of the gatherings has been stated, the total number of leaves should be noted, with a mention of any numeration of them given in the book. Any discrepancy between the total of the leaves assigned to the successive gatherings and the total as separately counted of course points to an error, and the reckonings must be repeated till they tally. Errors in the printed enumeration of the leaves of old books are common, and it is seldom necessary to note them out. When a reference has to be made to a particular page of an old book, the printed signatures offer the readiest means, an index number placed below the letter indicating the number of the leaf in the gathering and the addition of "recto" or "verso" marking the upper or under page of the leaf. Thus "X₄ recto" (some bibliographers prefer the rather clumsier form "X 4 recto") stands for the first page of the fourth leaf of the gathering signed X. Where there are no printed signatures the leaf-number may be given, the letters "a" and "b" above the numeral taking the place of "recto" and "verso" (leaf 99^r). Where some leaves of a book are numbered and others not, if the reference is to the printed numeration this should be stated. Printed leaf numeration is found as early as 1470, and became common about ten years later. Printed pagination did not become common till nearly the middle of the 16th century.

The foregoing details are all directed to showing which leaves of a book would be printed by the same pull of the press, how it was made up for binding, and how imperfections in any copy may be detected. They give little or no indication of the dimensions of the book. In the case of modern editions this may be done by adding one of the trade epithets, pott, foolscap, crown, &c., to the name of the size, which when thus qualified denotes paper of a particular measurement (see PAPER). As, however, these measurements are not easily remembered, it is better to give the actual measurements in inches or millimetres of a page of an uncut copy. In old books uncut copies are not easily found, and it is useful instead of this to give the measurement in millimetres of the printed portion of the page (technically called the "type-page"), although this is subject to a variation of about 3% in different copies, according to the degree to which they were damped for printing. To this is added a statement of the number of lines in the page measured. The character of the type (roman, gothic or italic) is next mentioned, and in the case of 15th-century books, its number in the sequence of founts used by the printer (see INCUNABULA). Finally a reference to any authoritative description already printed completes this portion of the entry. Thus the description of the collation of the first dated book printed at Augsburg, the *Arithmetica* of S. Behr, Venice, printed by Günther Zainer in 1468, should read: Folic (a^r, b^d, e^g, h²) 72 leaves. Type-page (t) 202 X 120 mm.; 35 lines. Type 1 (gothic letter). Hain 3557.

(c) While many books, and this is especially true of early ones, contain little or nothing beyond the bare text of a well-known work, others are well provided, not only with commentaries which are almost sure to be mentioned on the title-page, or in the colophon (which the editor himself often wrote), but also with dedicatory letters, prefaces, complimentary verses, indexes and other accessories, the presence of which it is desirable to indicate. In these cases it is often convenient to show the entire contents of the book in the order in which they occur, noting the leaves or pages on which each begins. Thus in the first edition (1590) of the first three books of Spenser's *Faerie Queene*, the literary contents, their order, and the space they occupy can be concisely noted by taking the successive gatherings according to their signatures and showing what comes on each page. Thus: A₁, recto, title; verso, dedication, "To the Most Mightie and Magnificent Empresse Elizabeth"; A₂-O₀₈, text of books i.-iii.; P₁, letter dated the 23rd of January 1589 [1590] to Sir Walter Raleigh expounding the intention of the work; P₂, verso, commendatory verses signed W. Raleigh, Hobyonll (Gabriel Harvey), R.S., H.B., W.L. and Ignato; P₃-8, complimentary sonnets severally inscribed to Sir W. Hatton, the earls of Essex, Oxford, Northumberland and Ormond, Lord Ch. Howard, Lord Grey of Wilton and Sir W. Raleigh, and to Lady Carew and to the Ladies in the Court; and "4 Faults escaped in the print"; Q₉-9, fifteen other sonnets.

Some bibliographers prefer to reverse the order of notation, (title, A₁, recto; dedication, A₁, verso, &c.), and no principle is sacrificed in doing so, though the order suggested usually works out the more nearly.

Enumeration and Arrangement.—In the 18th and early 19th centuries there was a tendency, especially among French writers, to exaggerate the scope of bibliography, on the ground that it was the duty of the bibliographer to appraise the value of all the books he recorded, and to indicate the exact place which each work should occupy in a logical classification of all literature based on a previous classification of all knowledge. Bibliographers are now more modest. They recognize that the

classification of human knowledge is a question for philosophers and men of science, that the knowledge of chemistry and of its history needed to make a good bibliography of chemistry is altogether extrinsic to bibliography itself; that all, in fact, to which bibliography can pretend is to suggest certain general principles of arrangement and to point out to some extent how they may be applied. The principles are neither numerous nor recondite. To illustrate the history of printing, books may be arranged according to the places and printing-houses where they were produced. For the glorification of a province or county, they are sometimes grouped under the places where their authors were born or resided. For special purposes, they may be arranged according to the language or dialect in which they are written. But, speaking generally, the choice for a basis of arrangement rests between the alphabetical order of authors and titles, a chronological order according to date of publication, a "logical" or alphabetical order according to subjects, and some combination of these methods. In exercising the choice the essential requisite is a really clear idea of the use to which the bibliography, when made, is to be put. If its chief object be to give detailed information about individual books, a strictly alphabetical arrangement "by authors and titles" (*i.e.* by the names of authors in their alphabetical order, and the titles of their books in alphabetical sequence under the names) will be the most useful, because it enables the student to obtain the information he seeks with the greatest ease. But while such an alphabetical arrangement offers the speediest access to individual entries, it has no other merit, unless the main object of the bibliography be to show what each author has written. If it is desired to illustrate the history and development of a subject, or the literary biography of an author, the books should be entered chronologically. If direction in reading is to be given, this can best be offered by a subject-index, in which the subjects are arranged alphabetically for speedy reference, and the books chronologically under the subject, so that the newest are always at the end. Lastly if the object is to show how far the whole field has been covered and what gaps remain to be filled, a class catalogue arranged according to what are considered the logical subdivisions of the subject has its advantages. It is important, however, to remember that, if the bulk of the bibliography is very large, a principle of arrangement which would be clear and useful on a small scale may be lost in the quantity of pages over which it extends. An arrangement which cannot be quickly grasped, whatever satisfaction it may give its author, is useless to readers, the measure of its inutilty being the worn condition of the alphabetical index to which those who cannot carry a complicated "logical" arrangement in their heads are obliged to turn, in the first instance, to find what they want. It should be obvious that any system which necessitates a preliminary reference to a key or index rests under grave suspicion, and needs some clear counterbalancing gain to justify the loss of time which it entails. The main classification should always be that which will be most immediately useful to readers of the books. To throw light on the history of a subject and to indicate how far the field is covered are honourable objects for compilers, but should mostly be held subordinate to practical use. It is noteworthy also that they may often be better forwarded by means of an index or table than by the main arrangement. The history of Hain's *Repertorium Bibliographicum*, which enumerates in an alphabetical arrangement of authors and titles some 16,000 books printed in the 15th century, is a good example of this. For sixty-five years it was of the utmost use for its accurate descriptions of individual books, but threw practically no light on the history of printing. In 1891 Dr Konrad Burger published an appendix to it containing an *Index of Printers*, since greatly enlarged in his index to Dr Copinger's *Supplement to Hain* (1902). The form of the index enables each printer's work to be seen at a glance, and the impetus given to the study of the history of printing was very great. But if the book had originally been arranged under Printers instead of Authors, it would have been far more difficult to use; its literary value would have been halved, and the record of the output of each press, now instantly

¹ Here specify the page measured.

visible, would have been obscured by the fuller entries causing it to extend over many pages.

The Bibliography of Bibliography.—The zeal of students of early printing has provided the material for an almost exhaustive list (see INCUNABULA) of the books printed in the 15th century still extant. Of those printed in the years 1501–1535 there is a tentative enumeration in the continuation of Panzer's *Annales Typographici* (1803), and materials are gradually being collected for improving and extending this. But the projects once formed for a universal bibliography have dwindled in proportion as the output of the press has increased, and the nearest approaches to such a work are the printed catalogue of the library of the British Museum, and that of the Bibliothèque Nationale at Paris, now in progress. Of books of great rarity unrepresented in these catalogues a fairly sufficient record exists in Brunet's *Manuel du libraire*, the bibliographical collections of Mr W. C. Hazlitt, the *Bibliographer's Manual* by Lowndes, and the other bibliographical works enumerated in the article on book-collecting (*q.v.*). When a universal bibliography was recognized as an impossibility, patriotism suggested the compilation of national bibliographies, and the *Bibliotheca Britannica* of Robert Watt (Edinburgh, 1824) remains an extraordinary example of what the zeal of a single man could accomplish in this direction. Quérard's *La France littéraire* (Paris, 1827–1839), while it gives fuller titles, is much less comprehensive, embracing mainly books of the 18th and early 19th centuries, and only such of these as appeared to the compiler to be written by "savants, historiens, et gens de lettres." In the works of Heinsius (*Allgemeines Bücherlexikon, 1700–1815*, Leipzig, 1812–1817), and Kayser (*Bücherlexikon, 1750, &c.*, Leipzig, 1834, &c.) Germany possesses a fine record of her output of books during the last two centuries, and since the organization of the book-trade, contemporary lists of books, with *résumés* and indexes issued at intervals, exist for most European countries. For the period before these became of importance in England much bibliographical material has been collected in the Catalogues of English Books printed up to the end of the year 1640, issued by the British Museum in 1884, by the John Rylands library, Manchester, in 1805, and by the University library, Cambridge, in 1900–1906. A similar record of the rich English collections in the Bodleian library, Oxford, remains a great desideratum. While these substitutes for a universal author catalogue have gradually been provided, similar contributions to a universal subject catalogue have been made in the form of innumerable special bibliographies compiled by students or bookmen interested in special subjects or departments of literature. The most important of these are enumerated in the bibliographical notes appended to articles in this Encyclopædia, but many attempts have been made to compile separate catalogues of them.

The most recent of these bibliographies of bibliographies naturally take over all that is of any value in their predecessors, and it may suffice therefore to make special mention of the following:—*Bibliotheca bibliographica. Kritisches Verzeichniss der in- und Ausländischen der Bibliographie betreffenden Literatur des In- und Auslandes, in systematischer Ordnung bearbeitet von Dr Julius Petzholdt. Mit alphabetischen Namen und Sachregister* (Leipzig, 1866), 8vo, pp. xii, 940; *Manuel de bibliographie générale*, par Henri Stein (Paris, 1898), 8vo, pp. xx, 896; *Manuel de bibliographie historique*, par Ch. V. Langlois (Paris, 1901), 12mo, pp. xi, 623; *A Register of National Bibliographies*. With a selection of the chief bibliographical works and articles printed in other Countries, by W. P. Courtney (London, 1905), 8vo, pp. viii, 631.

It should also be noted that the *Lists of Books of Reference in the Reading-Room of the British Museum*, first published in 1889, and the *Subject-index of the Modern Works added to the Library of the British Museum in the years 1881–1900*, edited by G. K. Fortescue (supplements published every five years), include entries of a vast number of bibliographical works, and that an eclectic list, with a valuable introduction, will be found in Professor Ferguson's *Some Aspects of Bibliography* (Edinburgh, 1900). (A. W. Po.)

BIBLIOMANCY (from the Gr. βιβλίον, a book, and μαντεία, prophecy), a form of divination (*q.v.*) by means of the Bible or other books. The method employed is to open the Bible haphazard and be guided by the first verse which catches the eye. Among the Greeks and Romans the practice was known under

the name of *sortes Homericae* or *sortes Virgilianae*, the books consulted being those of Homer or Virgil.

BIBRACTE, an ancient Gaulish town, the modern Mont Beuvray, near Autun in France. Here, on a hilltop 2500 ft. above sea-level, excavation has revealed a vast area of 330 acres, girt with a stone and wood rampart 3 m. long, and containing the remains of dwelling-houses, a temple of Bibractis, and the workshops of iron and bronze workers and enamellers. It was the capital of the Aedui in the time of Julius Caesar. Later on Augustus removed the inhabitants to his new town Augustodunum (Autun), to destroy the free native traditions. Another far more obscure town in Gaul, near Reims, also bore the name.

See Bulliot, *Fouilles de Beuvray*; Déchelette, *Oppidum de Bibracte*; also references *s.v.* AEDUI.

BIBULUS, a surname of the Roman gens Calpurnia. The best-known of those who bore it was Marcus Calpurnius Bibulus, consul with Julius Caesar, 59 B.C. He was the candidate put forward by the aristocratic party in opposition to L. Lucceius, who was of the party of Caesar; and bribery was freely used, with the approval of even the rigid Cato (Suetonius, *Caesar*, 9), to secure his election. But he proved no match for his able colleague. He made an attempt to oppose the agrarian law introduced by Caesar for distributing the lands of Campania, but was overpowered and even personally ill-treated by the mob. After making vain complaints in the senate, he shut himself up in his own house during the remaining eight months of his consulship, taking no part in public business beyond fulminating edicts against Caesar's proceedings, which only provoked an attack upon his house by a mob of Caesar's partisans. His conduct gave rise to the jest, that Julius and Caesar were consuls during that year. When the relations of Caesar and Pompey became strained, Bibulus supported Pompey (Plutarch, *Cato Minor*, 41) and joined in proposing his election as sole consul (52 B.C.). Next year he went to Syria as proconsul and claimed credit for a victory gained by one of his officers over the Parthians, before his own arrival in the province. After the expiration of his term of office, Pompey gave him command of his fleet in the Ionian Sea. He proved himself utterly incapable; his chief exploit was the burning of thirty transports on their return from Epirus whither they had succeeded in conveying Caesar and some troops from Brundisium. He died soon afterwards (48) of fatigue and mortification (Caesar, *Bell. Civi.* iii. 5–18; Dio Cassius xii. 48). Although not a man of great importance, Bibulus showed great persistency as the enemy of Caesar. Cicero says of him that he was no orator, but a careful writer. By his wife Porcia, daughter of Cato, afterwards married to Brutus, he had three sons. The two eldest were murdered in Egypt by some of the soldiery of Gabinus; the youngest, Lucius Calpurnius Bibulus, fought on the side of the republic at the battle of Philippi, but surrendered to Antony soon afterwards, and was by him appointed to the command of his fleet. He died (about 32) while governor of Syria under Augustus. He wrote a short memoir of his step-father Brutus, which was used by Plutarch (*Appian*, B.C. iv. 136; Plutarch, *Brutus*, 13, 23).

BICE (from Fr. *bis*, a word of doubtful origin, meaning dark-coloured), a term erroneously applied in English to various shades of green or blue pigments from the French terms *vert bis* and *azur bis*, dark green or blue. These colours are generally prepared from basic copper carbonates, but sometimes from ultramarine and other pigments.

BICESTER, a market town in the Woodstock parliamentary division of Oxfordshire, England, 12 m. N.N.E. of Oxford by a branch of the London & North-Western railway. Pop. of urban district (1901) 3023. It lies near the northern edge of the flat open plain of Ot Moor, in a pastoral country. The church of St Eadburg, the virgin of Aylesbury, is cruciform, with a western tower, and contains examples of Norman and each succeeding style. There is, moreover, in the nave a single rude angular arch considered to be Saxon. Incorporated with a farm-house, scanty Perpendicular remains are seen of an

Augustinian priory founded at the close of the 12th century. Bicester has considerable agricultural trade and a brewing industry. It is a favourite hunting centre.

The termination *cester*, commonly indicating Roman origin, does not do so here, and is perhaps copied from Alchester and Chesterton, 2 m. west of Bicester, where there is a small Roman site, probably a wayside village, at the meeting of roads from the south (Dorchester), west, north-east and east.

Bicester (Bernestre, Burencestre, Bissiter), according to the Domesday survey, was held by Robert d'Oily. In 1182 Gilbert Basset founded here an Augustinian priory, which from that date until its dissolution in 1538 became the centre of the industrial life and development of the town. In 1253 William Longspey obtained a grant of a fair at the feast of St Edburg, and a Friday market is mentioned in the 14th century. Richard II. granted a Monday market and a fair at the feast of St James the Apostle, and in 1440 an additional market was granted to be held in that part of the town called Bury-End, from this date known as Market-End. Bicester never possessed any manufactures of importance, but the fairs and markets were much frequented, and in the 16th century the cattle market was especially famous.

See J. C. Blomfield, *History of the Deanery of Bicester* (London, 1882-1894); John Dunkin, *History of Bicester* (London, 1816).

BICHAT, MARIE FRANÇOIS XAVIER (1771-1802), French anatomist and physiologist, was born at Thoirette (Jura) on the 14th of November 1771. His father, a physician, was his first instructor. He entered the college of Nantua, and afterwards studied at Lyons. In mathematics and the physical sciences he made rapid progress, but ultimately devoted himself to the study of anatomy and surgery, under the guidance of M. A. Petit (1766-1811), chief surgeon to the Hôtel Dieu at Lyons. The revolutionary disturbances compelled him to fly from Lyons and take refuge in Paris in 1793. He there became a pupil of P. J. Desault, who was so strongly impressed with his genius that he took him into his house and treated him as his adopted son. For two years he actively participated in all the labours of Desault, prosecuting at the same time his own researches in anatomy and physiology. The sudden death of Desault in 1795 was a severe blow to Bichat. His first care was to acquit himself of the obligations he owed his benefactor, by contributing to the support of his widow and her son, and by conducting to a close the fourth volume of Desault's *Journal de Chirurgie*, to which he added a biographical memoir of its author. His next object was to reunite and digest in one body the surgical doctrines which Desault had published in various periodical works. Of these he composed *Œuvres chirurgicales de Desault, ou tableau de sa doctrine, et de sa pratique dans le traitement des maladies externes* (1798-1799), a work in which, although he professes only to set forth the ideas of another, he develops them with the clearness of one who is a master of the subject. In 1797 he began a course of anatomical demonstrations, and his success encouraged him to extend the plan of his lectures, and boldly to announce a course of operative surgery. In the following year, 1798, he gave in addition a separate course of physiology. A dangerous attack of hæmoptysis interrupted his labours for a time; but the danger was no sooner past than he plunged into new engagements with the same ardour as before. He had now scope in his physiological lectures for a fuller exposition of his original views on the animal economy, which excited much attention in the medical schools at Paris. Sketches of these doctrines were given by him in three papers contained in the *Memoirs of the Société Médicale d'Émulation*, which he founded in 1796, and they were afterwards more fully developed in his *Traité sur les membranes* (1800). His next publication was the *Recherches physiologiques sur la vie et sur la mort* (1800), and it was quickly followed by his *Anatomie générale* (1801), the work which contains the fruits of his most profound and original researches. He began another work, under the title *Anatomie descriptive* (1801-1803), in which the organs were arranged according to his peculiar classification of their functions, but lived to publish only the first two volumes.

It was completed on the same plan by his pupils, M. F. R. Buisson (1776-1805) and P. J. Roux (1780-1854).

Before Bichat had attained the age of eight-and-twenty he was appointed physician to the Hôtel Dieu, a situation which opened an immense field to his ardent spirit of inquiry. In the investigation of diseases he pursued the same method of observation and experiment which had characterized his researches in physiology. He learned their history by studying them at the bedside of his patients, and by accurate dissection of their bodies after death. He engaged in a series of examinations, with a view to ascertain the changes induced in the various organs by disease, and in less than six months he had opened above six hundred bodies. He was anxious also to determine with more precision than had been attempted before, the effects of remedial agents, and instituted with this view a series of direct experiments which yielded a vast store of valuable material. Towards the end of his life he was also engaged on a new classification of diseases. A fall from a staircase at the Hôtel Dieu resulted in a fever, and, exhausted by his excessive labours and by constantly breathing the tainted air of the dissecting-room, he died on the 22nd of July 1802. His bust, together with that of Desault, was placed in the Hôtel Dieu by order of Napoleon.

BICHROMATES AND CHROMATES. Chromium trioxide dissolves readily in water, and the solution is supposed to contain chromic acid, H_2CrO_4 ; the salts of this acid are known as the chromates. In addition to these normal salts, others exist, namely bichromates, trichromates, &c., which may be regarded as combinations of one molecular proportion of the normal salt with one or more molecular proportions of chromium trioxide. The series will thus possess the following general formulæ:—

$$M_2CrO_4, M_2Cr_2O_7, M_3Cr_3O_{10} \text{ \&c. } (M = \text{one atom of a normal chromate bichromate trichromate monovalent metal}).$$

Chromates.—The alkaline chromates are usually obtained by fusion of a chromium compound with an alkaline carbonate and an oxidizing agent, such for example as potassium nitrate or chlorate. The native chrome-ironstone ($Cr_2O_3 \cdot FeO$) may be used in this way as a source of such compounds, being fused in a reverberatory furnace, along with soda-ash and lime, the oxidizing agent in this case being atmospheric oxygen. They may also be prepared by oxidizing chromium salts (in alkaline solution) with hydrogenc peroxide, chlorine, bleaching powder, potassium permanganate and manganese dioxide. The majority of the chromates are yellow in colour, and many of them are isomorphous with the corresponding sulphates. The alkaline chromates are soluble in water, those of most other metals being insoluble. By the addition of mineral acids, they are converted rapidly into bichromates. They are easily reduced in acid solution by sulphuretted hydrogen, and also by sulphur dioxide to chromium salts. The chromates are stable towards heat; they are poisonous, and may be recognized by the yellow precipitates they give with soluble barium and lead salts.

Potassium chromate, K_2CrO_4 , may be prepared by neutralizing a solution of potassium bichromate with potassium carbonate or with caustic potash. It crystallizes in yellow rhombic prisms, and is readily soluble in water, the solution having a bitter taste and an alkaline reaction. When heated in a current of sulphuretted hydrogen, or carbon bisulphide, it yields a mixture of chromium sesquioxide and sulphide. When heated with sulphur it yields chromium sesquioxide. Sodium chromate, $Na_2CrO_4 \cdot 10H_2O$, forms pale yellow crystals isomorphous with hydrated sodium sulphate, $Na_2SO_4 \cdot 10H_2O$. It is deliquescent, and melts at 23° C. (M. Berthelot). By evaporation of its aqueous solution at temperatures above 30° C. it may be obtained in the anhydrous condition. Lead chromate, $PbCrO_4$, occurs native as the mineral crocoisite, and may be obtained as an amorphous pale yellow solid by precipitating a soluble lead salt by an alkaline chromate. It is used as a pigment under the name "chrome yellow." When digested for some time with a caustic alkali it is converted into a basic salt, $PbCrO_4 \cdot PbO$, a pigment known as "chrome red." It melts readily, and on cooling resolidifies to a brown mass, which at moderately high temperatures gives off oxygen and leaves a residue of a basic lead salt; for this reason fused lead chromate is sometimes made use of in the analysis of organic compounds. Silver chromate, Ag_2CrO_4 , is a dark red amorphous powder obtained when silver nitrate is precipitated by an alkaline chromate. It is decomposed by the addition of caustic alkalis, forming silver oxide and an alkaline chromate.

Bichromates.—The bichromates are usually of a red or reddish-brown colour, those of the alkali metals being readily soluble in water. They are readily decomposed by heat, leaving a residue of the normal chromate and chromium sesquioxide, and liberating oxygen; ammonium bichromate, however, is completely decomposed

into chromium sesquioxide, water and nitrogen. Sulphuretted hydrogen and sulphur dioxide reduce them in acid solution to the condition of chromium salts.

Potassium bichromate, $K_2Cr_2O_7$, is obtained by fusing chrome ironstone with soda ash and lime (see above), the calcium chromate formed in the process being decomposed by a hot solution of potassium sulphate. After the calcium sulphate has settled, the potassium chromate solution is converted into bichromate by the action of sulphuric acid, and the salt is allowed to crystallize. It forms large triclinic prisms of specific gravity 2.6-2.7, which are moderately soluble in cold water and readily soluble in hot water. The solution is strongly acid in reaction and is very poisonous. Potassium bichromate finds extensive application in organic chemistry as an oxidizing agent, being used for this purpose in dilute sulphuric acid solution, $K_2Cr_2O_7 + 4H_2SO_4 = K_2SO_4 + Cr_2(SO_4)_3 + 4H_2SO_4 + 3O$. On the addition of concentrated sulphuric acid to a cold saturated solution of the salt, red crystals of chromium trioxide, CrO_3 , separate (see CHROMIUM), whilst when warmed with concentrated hydrochloric acid and a little water, potassium chlorochromate is produced. When heated with phosphorus trichloride in a sealed tube to $165^\circ C$., potassium chlorochromate, phosphorus oxychloride, potassium chloride, and a complex chromium oxide (possibly Cr_2O_3) are produced (A. Michaelis, *Jour. prak. Chem.*, 1871, ii. 4, p. 452). Potassium bichromate finds application in photography, in calico-printing, and in the preparation of bichromate cells. Sodium bichromate, $Na_2Cr_2O_7 \cdot 2H_2O$, may be obtained by the addition of the requisite quantity of chromium trioxide to a solution of sodium chromate. It crystallizes in hyacinth-red prisms, which are very hygroscopic and melt at $320^\circ C$.

Trichromates.—The trichromates are obtained by the addition of nitric acid (of specific gravity about 1.2) to solutions of the bichromates. They form rhombic crystals of a red or brown red colour and are readily decomposed by warm water, with formation of the bichromate.

Perochromic Acid.—By the addition of hydrogen peroxide to a solution of chromic acid, a fine blue coloration due to a perchromic acid is produced which is readily absorbed by shaking out with ether. The following formulæ have been assigned to the compound:— $H_2O_2 \cdot CrO_3$ (H. Moissan, *Comptes rendus*, 1883, 97, p. 96); $H_2O_2 \cdot 2HCrO_4$ (M. Berthelot, *Comptes rendus*, 1889, 108, p. 25); $Cr_2O_3 \cdot xH_2O$ (L. C. A. Barreswil, *Ann. chim. et phys.*, 1847 [3], 20, p. 364), and $CrO_3 \cdot 3H_2O$ (T. Fairley, *Chem. News*, 1876, 33, p. 237). The more recent investigations of H. G. Byers and E. E. Reed (*Amer. Chem. Jour.*, 1904, 32, p. 528) show that if metallic potassium is added to an ethereal solution of the blue compound at $-20^\circ C$., hydrogen is liberated and a purple black precipitate of the perchromate, of composition $KCrO_4$ or $K_2Cr_2O_8$, is produced; this compound is very unstable, and readily decomposes into oxygen and potassium bichromate. Similar sodium, ammonium, lithium, magnesium, calcium, barium and zinc salts have been obtained. It is shown that the blue solution most probably contains the acid of composition, $H_2Cr_2O_8$, whilst in the presence of an excess of hydrogen peroxide more highly oxidized products probably exist.

BICKER (connected by Skeat with *bike*, to thrust or strike), an Old English word (traced from the 13th century) implying conflict or disputation. A poetical use, from the noise, is seen in Tennyson's *Brook*, "to bicker down the valley."

BICKERSTAFFE, ISAAC (c. 1735-c. 1812), English dramatist, was born in Ireland about 1735. At the age of eleven he was appointed a page to Lord Chesterfield, then lord lieutenant of Ireland, and subsequently held a commission in the Marines, but was dismissed the service under discreditable circumstances. He was the author of a large number of plays and burlesque farces interspersed with songs, produced between 1760 and 1771. The best-known are *Maid of the Mill* (founded on Richardson's *Pamela*), *The Padlock*, *He Would if he Could*, *Love in a Village*, *The Hypocrite* and *The Captive*. In 1772 Bickerstaffe, suspected of a capital offence, fled to the continent. The exact date of his death is unknown, but he is stated to have been still living in abject misery in 1812.

A full account of his dramatic productions is given in *Biographia Dramatica*, edited by Stephen Jones (1812).

BICKERSTETH, EDWARD (1786-1850), English evangelical divine, brother of Henry, Baron Langdale, master of the rolls (1836-1851), and uncle of Robert Bickersteth, bishop of Ripon (1857-1884), was born at Kirby Lonsdale, and practised as a solicitor at Norwich from 1812 to 1815. In 1816 he took orders, and was made one of the secretaries of the Church Missionary Society. On receiving the living of Watton, Hertfordshire, in 1830, he resigned his secretaryship, but continued to lecture and preach, both for the Church Missionary Society and the Society for the Conversion of the Jews. His works include *A Scripture*

Help (London, 1816), which has been translated into many European languages, and *Christian Psalmody* (London, 1833), a collection of over 700 hymns, which forms the basis of the *Hymnal Companion* (London, 1870), compiled by his son, E. H. Bickersteth, bishop of Exeter (1885-1890). He was active in promoting the Evangelical Alliance of 1845, strongly opposed the Tractarian Movement, and was one of the founders of the Irish Church Missions, and Parker, Societies.

EDWARD BICKERSTETH (1814-1892), dean of Lichfield, was his nephew, and EDWARD BICKERSTETH (1850-1897), bishop of South Tokyo, his grandson.

BICYCLE (from prefix *bi*=twice, and Gr. *κίκλος*, a circle, wheel). The modern bicycle, as developed from the old velocipede (see CYCLING), consists essentially of two wheels placed one behind the other and mounted on a frame which carries a saddle for the rider. Between the wheels is a crank-axle which the rider drives by means of the cranks and pedals, and its motion is transmitted to the rear or driving wheel either by a chain which passes over two chain wheels, one fixed on the crank-axle and the other on the hub of the rear wheel, or, in the chainless bicycle, by a tubular shaft and two pairs of bevel-wheels. The rear wheel is usually so arranged that it can turn, when the bicycle is running by its own momentum, independently of the chain and pedals ("free-wheel"), and a variable speed gear is often provided so that the rider may at will alter the ratio between the rate of revolution of the crank-axle and the driving wheel. The front, or steering wheel, is mounted in a fork having its two upper ends brazed into the "crown," to which also the lower end of the steering tube is brazed. The steering tube is mounted by ball bearings in the socket tube, which forms the forward portion of the rear-frame.

The highest quality of materials and the most accurate workmanship are required to produce a first-class bicycle. Steel of 75 to 100 tons per sq. in. tensile strength is used in chains, spokes, &c. In balls and ball-races, hardness without brittleness, and homogeneity are of primary importance. Broken balls, or even traces of wear in bearings, are now seldom heard of in a first-class bicycle. The process of case-hardening, whereby an extremely hard outer skin is combined with a tough interior, has been brought to a high degree of perfection, and is applied to many parts of the bicycle, particularly chains, free-wheels and toothed-wheel variable speed gears. Interchangeability of parts is secured by working to the smallest possible limits of error of workmanship.

Frames.—Fig. 1 represents a road-racer. A full roadster would have the handles a little higher relatively to the saddle, and would be provided with mud-guards, free-wheel and sometimes a gear-case

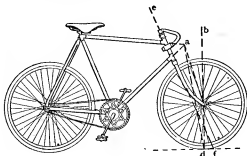

FIG. 1.

and variable speed gear. Fig. 2 shows a lady's bicycle with gear-case and dress-guard. The rear frame of the "diamond" type (fig. 1) is subjected to very small stresses due to vertical load. The front fork and steering post are subject to bending moment due to the reaction from the ground in the direction *abc*. A slight amount of elasticity in the front fork adds considerably to the comfort in riding over rough roads. When the brake is applied lightly to the front wheel, the reaction from the ground falls more closely along the axis of the front fork, and the bending moment at the crown is diminished. If the front brake is applied harder the reaction from the ground at *d* may pass through the crown, in which case the bending moment at the crown is zero. Still harder application of the brake causes a bending moment in the opposite direction. In fig. 1 the axes of the top and bottom tubes of the rear frame are produced to meet at *a*.

If the reaction from the ground is in the direction da , the top and bottom tubes are subjected to pure compressive and tensile stresses respectively. When no brake pressure is applied a bending moment due to the overhang ab is superimposed on these tubes. Thus a short socket head with top tube sloping downwards towards the head gives a stronger frame than a horizontal top tube. The steering axis ef is arranged so as to cut the ground at f , a little in front of the point of contact d of the wheel with the ground, giving a slight castor action, and making steering possible without use of the handle-bar. The rake of the steering head (that is the angle between ef and bd) and the set of the fork (that is the displacement of the wheel centre c from the axis ef) may be varied within tolerably large limits without much affecting the easy steering properties of the bicycle. The transverse stresses on the rear frame due to the action of pedalling are more severe than those due to the



FIG. 2.

vertical load. The pedal pressure is applied at a considerable distance from the central plane of the bicycle, and the pedal pin, cranks and crank-axle are subjected to a bending moment which is transmitted by the ball bearings to the frame. The down-tube from the seat lug to the crank-bracket and the bottom tube from the foot to the steering socket tube to the crank-bracket are made fairly stout to resist this bending moment. Further, the pull of the chain causes a transverse bending moment in the plane of the chain-stays, which must be stiff enough under heavy pedal pressure.

The tubular portions of the frame are made of weldless cold-drawn steel tube. The junctions or lugs are usually of malleable cast iron, bored to fit the outside of the tube, the final union being effected by brazing. In very light bicycles the tubes are kept thin, 22 or 24 W.G. (·028 in. or ·022 in. thickness) at the middle, and are strengthened at the ends by internal liners. Or butt-ended tubes are employed, the tubes being drawn thicker at the ends than in the middle. The steering post and fork sides especially should be thus strengthened at their junction with the crown. Some of the best makers use sheet steel stampings instead of cast lugs, greater lightness and strength being secured, and in some cases the sheet steel lugs are inside the tubes, so that the joints are all flush on the outside. The front fork blades are best made of sheet steel stamped to shape and with the edges brazed together to form a hollow tube. The sheet steel that can be thus employed has a much higher elastic limit than a weldless steel tube.

Bearings.—Ball bearings are universally used. Each row of balls runs between two ball-races of hardened steel, one on the stationary member, the other on the rotating member. The outer is called the "cup," and the inner the "cone." One of the four ball-races is

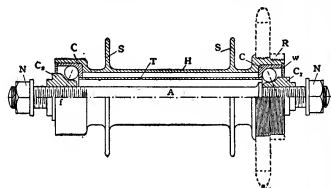

FIG. 3.

adjustable axially so that the bearing may run without any shake. The ball-races are often made of separate pieces of steel, but the crank-axle usually has the cones formed integral with it, the necessary hardness being obtained by case-hardening. According as the two cups face outwards or inwards the bearing is said to have outward or inward cups, and according as the adjustable ball race is the cone or cup, the bearing is said to be cone-adjusting or cup-

adjusting. Fig. 3 shows a ball-bearing hub with outward cups. The hub-shell H is turned out of mild steel, and the cups C are forced into the ends of the hub-shell and soldered thereto. A thin washer W is then spun into the end, for the purpose of retaining oil, and a thin internal tube T unites the two cups, and guides the oil fed in at the middle of the hub to the balls. The projecting flanges S are for the attachment of the tangent spokes used to build the hub into the wheel. The spindle A has the two cones screwed on it, one C₁ against a shoulder, the other C₂ adjustable. The spindle ends are passed through the back-fork ends and are there adjusted in position by the chain-tension adjusters. After adjustment the nuts N clamp the spindle securely between the fork-ends. The chain-wheel or free-wheel clutch is screwed on the end of the hub-shell, with a right-hand thread. The chain being at the right-hand side of the bicycle (as the rider is seated) the driving pull of the chain tends to screw the chain-wheel tight against the shoulder. A locking-ring R with a left-hand thread, screwed right against the chain-wheel, prevents the latter from being unscrewed by back-peddalling. With a free-wheel clutch screwed on the hub, the locking-ring may be omitted.

Fig. 4 shows one end of the cup-adjusting hub, with inward bearings. The cones are formed of one piece with the spindles, and the adjusting cup C is screwed in the end of the hub shell, and locked in position by the screwed locking-ring R. The figure also illustrates a divided spindle for facilitating the removal of the tire for repair when required without disturbing the wheel, bearings, chain or gear-

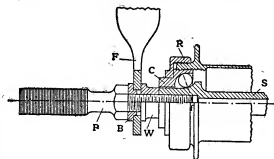

FIG. 4.

case. The chain side of the hub-spindle, not shown in the figure, is secured to the frame in the usual way; on the left side the spindle S projects very little beyond the adjusting cup. A distance washer W is placed between the end of the spindle S and the fork-end F. A detachable screw-pin, or the footstep, P, passes through the chain-adjusting draw-bolt B, the fork-end F, and the distance washer W, and is screwed into the end of the spindle S, the hexagon head of the detachable pin drawing all the parts securely together. On unscrewing the detachable pin, the distance washer W drops out of place, leaving a clear space for removing the tire without disturbing any other part.

The inward-cups bearing retains more oil than the other form. The pressure on a ball being normal to the surface of contact with the ball race, and each ball touching two ball races, the two points of contact must be in line with the centre of the ball. All the lines of pressure on the balls of a row meet at a point f on the axis of the spindle. The distance between the two points f (fig. 5) may be called the virtual length of the bearing. Other things being equal, the outward-cups bearing has a greater virtual length than the inward-cups bearing. In hubs and pedals where the actual distance between the two rows of balls is sufficient, this point is of little importance. At the crank-axle bearing, however, where the pedal pressure which produces pressure on the axle bearings is applied at a considerable overhang beyond the ball-races, the greater virtual length of the outward-cups is an advantage.

Fig. 5 shows diagrammatically the usual form of crank-axle bearing which has inward-cups and is cup-adjusting. The end of the bracket is split and the cup after adjustment is clamped in position by the clamping screw S. The usual mode of fastening the cranks to the axle is by round cotters C with a flat surface at a slight angle to the axis, thus forming a wedge, which is driven in tight. The small end of the cotter projects through the crank, and is screwed and held in place by a nut. The chain-wheel at the crank-axle is usually detachably fastened to the right-hand crank.

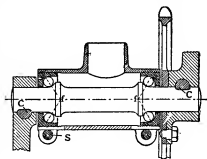

FIG. 5.

The Rudge-Whitworth crank-bracket has outward cups and is cup-adjusting. The cranks are cotterless. Fig. 6 is a sectional view. The left crank and axle are forged in one piece. The fastening of the right crank and chain-wheel is by multiple grooves and teeth, this fastening being better mechanically than the cotter type.

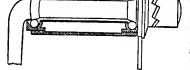

FIG. 6.

Pedals.—The pedal consists of a pedal body, on which the foot of the rider rests, mounted by ball-bearings on a pedal-pin, which is secured to the end of the crank and turns with it. The pedal body is made in many forms, but usually the bearing-cups are contained in a tube from the ends of which project plates, carrying rubber blocks, or serrated plates (rat-rapet pedals), on which the foot of the rider rests. Cone adjustment is most used. The fastening of the pedal pin to the crank is best effected by screwing it up against a shoulder, the right and left crank eyes being tapped with right and left hand screws respectively. With this arrangement, if the pedal pin screw is a slack fit in the crank eye, the pressure on the pedal tends to screw it up against the shoulder.

Wheels.—Bicycle and tricycle wheels are made on the "suspension" principle, the spokes being of high-tensacity steel wire, screwed up to a certain initial tension, thus putting a circumferential compression on the rim. In the artillery wheel, the wooden spokes are in compression, and the rim is under tension. The rims, which are made to a section suitable for pneumatic tires (see Tires), may be of sheet steel or aluminium alloy rolled to the required section, either without joint or jointed by brazing or riveting. Wood rims are used on racing bicycles, but in England are not popular for roadster bicycles. Holes are drilled at or near the central plane of the rim for the spoke nipples, which have shoulders resting on the outer surface of the rim and shanks projecting through the rim towards the hub. The spoke ends are screwed to fit the nipples. The shank of the spoke has a square cut on its outside surface by which it can be screwed up. The spoke flanges on the hub are placed far apart and the spread of the spokes gives the wheel lateral stability. Tangential rigidity under driving and braking is obtained by fastening the spokes to the hub tangentially (figs. 1 and 2). The hub fastening of the spoke is simply obtained by forming a hook and head on the spoke end, and passing it through a hole in the hub flange. The best spokes are butted at the ends, i.e. made of larger diameter than at the middle, to allow for screwing at one end and the hook bend at the other.

Chains.—There are two widely used types of chains. The "block" chain (fig. 7) consists of a series of central blocks connected

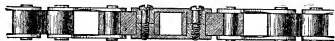

FIG. 7.

by side plates. The "roller" chain (fig. 8) consists of a series of outside and inside links. The outside link A is made up of two steel side plates P united by two shouldered rivets R. The inside link B consists of two side plates P united by two tubular pieces T, which form bushings for the rivets R and pivots for the rollers L. The rivets, bushes and rollers are case-hardened.

Roller chains for cycles are made in two pitches, $\frac{3}{4}$ in. and $\frac{1}{2}$ in. and in widths from $\frac{1}{2}$ in. to $\frac{1}{4}$ in. between the side plates of the inside links. The weight of 4 ft. length (96 links) of a $\frac{1}{2}$ in. pitch $\frac{1}{4}$ in. wide roller chain is about 12½ oz., and its breaking load is about 2000 lb. In a block chain the ends of the blocks engage with the teeth of the chain-wheels, and the same surfaces continually coming into contact, the wear may become excessive, especially when exposed to mud and grit. In the roller chain the outer surfaces of the rollers engage with the teeth of the chain-wheels, and during the engagement and disengagement may roll slightly on the tubular rivets. The surface of contact of the roller and tubular rivet is not directly exposed to the dust and grit from the road. The rollers therefore serve the double purpose of (1) transferring the relative motion of the parts to a pair of surfaces under better conditions as regards lubrication, and (2) presenting a new part of the outside surface of the roller for the next engagement with the chain-wheel. The durability of roller

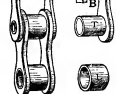

FIG. 8.

presenting a new part of the outside surface of the roller for the next engagement with the chain-wheel. The durability of roller

chains is thus much greater than that of block chains, under the usual conditions of cycling.

Chain-conditions.—The pitch line of the chain-wheel is polygonal (fig. 9), a, b, c, d being centres of adjacent joints of the chain when

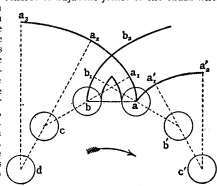

FIG. 9.

lying in contact with the wheel. The path of the joint a of the chain, relative to the chain-wheel as it enters on to and leaves the chain-wheel, is evidently the curve $a_1 a_2 a_1 a' a' a_1$, made up of a series of circular arcs having centres d, c, b, b', c', respectively. Similarly for the path of the adjacent joint b. The fullest possible form of the tooth is that between the two parallel curves, of radii less by an amount equal to the radius of the roller, as indicated in fig. 9. But since it is neither necessary nor desirable that the roller should roll along the whole length of the tooth, the radii of curvature of the tooth outline may be less than shown in fig. 9. A good arrangement of tooth form is shown in fig. 10.

Owing to the polygonal pitch surfaces of the chain-wheels a chain does not transmit motion with constant speed-ratio of the shafts. The variation of speed-ratio in a chain with links of equal pitch is approximately inversely proportional to the square of the number of teeth in the smaller chain-wheel, as shown in the table annexed, in which the percentage variation is—

$$\frac{\text{maximum speed-ratio} - \text{minimum speed-ratio}}{\text{average speed-ratio}} \times 100.$$

Number of teeth on hub chain-wheel	10	12	14	16	18	20	24	28
Percentage variation	5.1	3.5	2.7	2.1	1.6	1.3	0.9	0.7

The rollers as they come in contact with the chain-wheel strike it with a speed proportional to the angular speed of the chain-wheel and to the pitch of the chain, causing a certain amount of noise.

Chain Adjustment.—To keep the chain running at correct tension, it is necessary to have some adjustment of the distance between the crank-axle and hub. This is obtained either by an eccentric adjustment at the crank-bracket, an eccentric adjustment at the hub-spindle or by draw-bolts at the fork-ends, the last method being most common.

Gear-case.—The modern roller chain by makers of repute is so durable that the necessity for a gear-case is not so great as when chains were of inferior quality. But if the bicycle is to require the minimum amount of care and attention a gear-case should be fitted. The Sunbeam gear-case is built into the frame and is oil-retaining, and the chain, chain-wheels, free-wheel and two-speed gear are continually lubricated by an oil-bath. A detachable gear-case is not usually oil-retaining, but serves to exclude grit and mud from the chain.

Gear and Crank-length.—The "gear" of a bicycle is given by the formula Dn_1/n_2 , where D is the diameter of the driving wheel in inches, n_1 and n_2 the numbers of teeth on the crank-axle and hub chain-wheels respectively. At each revolution of the crank-axle, the bicycle is moved forward a distance equal to the circumference of the circle of diameter equal to the gear. Thus with a 28 in. diameter driving-wheel, 18 teeth on the hub chain-wheel, 45 teeth on the crank-axle chain-wheel, the bicycle is geared to 70 in. The usual crank-length is 6½ to 7 in. Cranks of 7½, 8 and 9 in. length can be had, but require a bicycle frame of special design. The gear should be roughly proportional to the crank-length. The gear 10 times the crank-length is a good proportion for an average rider.

Free-wheel.—A free-wheel clutch transmits the drive in one direction only, allowing the pedals to remain at rest at the will of the rider, while the bicycle runs on. With a free-wheel, chain breakages are reduced or nearly eliminated, as should the chain get accidentally caught the free-wheel comes into play. There are three principal types of free-wheel clutches—roller, ratchet and friction cone. The roller type was the earliest in use, but has fallen into disfavour. A sectional view of a ball-bearing ratchet free-wheel, with outer cover removed, is shown in fig. 11. The ring on which the three pawls and springs are carried is screwed on the end of the hub; the chain-wheel is combined with an inner ratchet wheel and is mounted by two rows of ball bearings on the pawl ring. The friction cone type of free-wheel clutch is usually combined with a brake

inside the hub, the whole combination being termed a coaster hub. Fig. 12 shows a sectional view of the Eadie two-speed coaster, in which the free-wheel clutch and brake are combined with a two-speed gear. The free-wheel clutch action is as follows: A forward pressure of the pedals turns the externally threaded driving cone H in the internally threaded cone F, the latter being thus forced to the right into engagement with the hub-shell, thus forming a friction driving clutch. The pedals being held stationary the driving cone H is stationary, and the hub running on the ball bearings G, the cone F travels towards the left until released from the cup J, when it also remains at rest. In this type of free-wheel clutch it is essential that there be

little or no friction between the screwed surfaces of H and F, else on beginning to pedal the cone F may remain stationary relative to the driving cone H, and no engagement between F and J may take place. If F be prevented from turning faster than the hub-shell, as is sometimes done by a light spring between the two, the engagement of the friction clutch must take place as soon as

the pedals tend to move faster than the speed corresponding to that of the hub-shell.

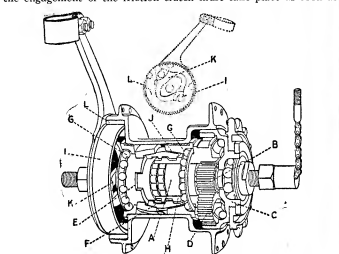

FIG. 12.—Eadie Two-speed Coaster Hub.

the pedals tend to move faster than the speed corresponding to that of the hub-shell.

Brakes of many types are used, differing in the place and mode of application. The tire brake has fallen into disuse, rim brakes and internal hub brakes being usual. The retarding force that can be applied by a brake is limited by the possibility of skidding the wheel. In riding at uniform speed, without acceleration, the greater part of the load is on the rear-wheel; but as soon as the brake is applied to cause retardation the wheel load distribution is altered, more load being thrown on the front wheel. Thus the most powerful brake is one applied to the front wheel. On the other hand, a front-wheel brake often sets up an unpleasant vibration of the front fork. On a greasy road too powerful pressure on the front-wheel brake may cause a side-slip with no chance of recovery; while with the back-wheel brake recovery is possible. The Bowden system of transmission, which is largely used for cycle brake work, consists of a steel stranded cable inside a flexible tube formed by a closely wound spiral of steel wire, the cable being practically inextensible and the spiral tube practically incompressible; if the ends of the latter be fastened it forms a guide tube for the cable, any movement given to one end of the cable being transmitted to the other end. The spiral tube may be led round any corner, but the frictional resistance of the cable inside the spiral tube increases with the total angle of curvature of the guide tube; the laws of friction of a rope passing over a drum apply. In fitting the Bowden system the total curvature should therefore be kept as small as possible. With a back-peddaling rim brake the cycle cannot be wheeled backwards unless a special device is used to throw the operating clutch out of action. A back-peddaling brake is most conveniently applied inside the hub, as in the coaster hub. In the Eadie two-speed coaster (fig. 12) the braking action is obtained by the expansion of the steel band I against a phosphor bronze ring L carried by the rotating hub-shell. The steel band I is mounted on a disk with a projecting arm, the end of which is clipped to the frame tube. The expansion of the steel band is effected by the movement of the lever K fixed to the cone E. On moving the pedals backward the screw driving ring H forces the cone nut F with which it engages to the left into contact with the cone E. The backward movement of the

pedals being continued sets up the required movement of the lever K, and applies the brake.

Variable Speed Gears.—The effort required to propel a bicycle varies greatly, according to the conditions of road surface, gradient up or down hill, wind against or behind. To meet these variable conditions, a variable speed-gear is an advantage. The action of the human motor is, however, so entirely different from that of a mechanical motor that it is easy, without practical experience, to over-estimate the value of a variable speed gear. Probably from 50 in. to 80 in. represents the greatest useful range of gear for an average rider. With a gear lower than 50 in., the speed of climbing a steep gradient is so slow that balancing difficulties begin, and it is better to walk up. With 80 in. gear and 7 in. cranks, the speed of pedalling, even at 25 miles an hour, is not irksome, provided the conditions are favourable. For those who have not cultivated the art of quick pedalling the useful range of gear under favourable conditions may be extended to say 90 in. or 100 in. The gear-ratio of a two-speed gear is the ratio of the high to the low gear. The most suitable gear-ratio for any rider will depend upon his personal physique and the nature of the country in which he rides. For a middle-aged rider of average physique a gear-ratio of 125; 100 is suitable, for those of weaker physique the gear-ratio may with advantage be greater, say 137.5; 100; while for road racing it may be smaller, say 117; 100. With a three-speed gear the low and high gears should be chosen respectively below and above the single gear which suits the rider, the middle gear being about the same as the rider's usual single gear.

All the variable speed gears at present made consist of toothed wheel mechanism either at the hub or crank-bracket, and nearly all are based on the same epicyclic train of toothed wheels. At one speed there is no relative motion of the toothed wheels, the whole mechanism revolving as one solid piece; this is called the "normal" speed. At the other speed one part of the mechanism is held stationary and the driven part revolves faster or slower than the driver, according to whether the gearing is up or down. In some two-speed gears the normal is the high speed; in others the low. In expressing the gear-ratio, the normal speed will be denoted by 100. At the normal gear there is of course no additional friction. The type of two-speed gear used practically settles whether the normal gear is at high or low speed; but it seems best, other things being equal, to have the low speed the normal gear, as then the conditions are worst. If the high speed is at normal gear, then at low speed the chain gears up and the two-speed gear gears down; which is, to say the least, a roundabout transmission.

Fig. 13 is a sectional view of the Sunbeam two-speed gear which is arranged in the crank-axle, and clearly shows the relative disposition of the toothed wheel mechanism common to nearly all cycle speed gears. The chain-wheel is fixed to the annular wheel A; the planet carrier C is fixed to the crank; and when the sun-wheel D is held stationary, the chain-wheel is driven faster than the cranks. When the sun-wheel D is released, the planet carrier C drives the annular wheel A by the ratchet free-wheel clutch; the part thus revolves as a solid piece, and gives the normal or low speed. The gear-ratio is 133.3; 100.

Fig. 14 is a sectional view of the "Hub" two-speed gear, the chain-wheel or free-wheel clutch being omitted. In this the annular wheel of the driver, and the planet carrier is part of the hub-shell, when the central pinion is held stationary the hub is driven at a less speed than the chain-wheel; the gear-ratio is 100; 76.2.

In the Fagan two-speed gear, shown combined with the Eadie coaster hub in fig. 12, the sun-wheel B can be moved laterally by the striking gear, so as to engage with the chain-wheel centre C, giving normal gear, or with an internally toothed wheel A fixed to the spindle. The chain-wheel centre C carries the annular wheel, and the four planet pinions D are mounted on the driving cone H. Thus the gear gives a reduction of speed, the gear-ratio being 100; 75.

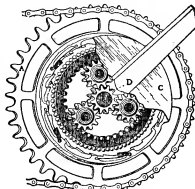

FIG. 13.—Sunbeam Two-Speed Gear.

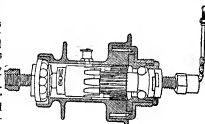

FIG. 14.

The Sturmey-Archer three-speed hub (fig. 15) has gear-ratios 125 : 100 : 80. In the high gear position the epicyclic toothed wheels are to the extreme left position. The chain-wheel is mounted by a free-wheel on a drive-ring, with which the ends of the spindles of the planet wheels engage at high gear. The sun-wheel, not shown in the figure, is held stationary, and the annular wheel engages with a ring screwed to the hub-shell, by means of keys engaging in notches. The hub is thus driven at a higher speed than the chain-wheel. For normal gear, the striking gear draws the internal mechanism of the hub towards a central position, compressing a spring, disengaging the sun-wheel and locking the drive-ring hub and annular wheel together. At low gear, the internal mechanism

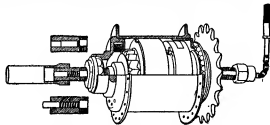

FIG. 15.

is drawn to the right-hand side, where the planet carrier engages with the end plate of the hub by means of claw-clutches. The annular wheel is still engaged with the drive-ring, and the sun-wheel is again locked to the spindle. The hub is thus driven at a lower speed.

Tandem Bicycles.—The weight of a roadster tandem is about the same as, or a trifle less than, that of two single roadster bicycles, but the frictional resistance of the mechanism, the rolling resistance of the tires, and the air resistance at a given speed are much less than twice the values for a single bicycle. Consequently, much higher speeds are attained on the level, and free-wheeling down hill is much faster. On the other hand for riding up hill on a moderate gradient, the effort required is about the same as on a single, while on very steep gradient the tandem is at a slight disadvantage. For the full enjoyment of tandem riding, therefore, a two-speed gear is a necessity, while a three-speed gear is better. In the Raleigh tandem (fig. 16) the frame design is such that it can be ridden by two ladies, and the strength and rigidity is sufficient for two heavy-weight riders. The steering and control of the brakes is done by the front rider. Connected steering is employed in some tandems, allowing the rear rider to steer if necessary. For two expert tandem riders, connected steering is slightly more pleasurable than fixed handle grips for the rear rider, but on the other hand, divided control may lead to disaster at a critical moment. Most passengers on a tandem with connected steering unconsciously give the steering

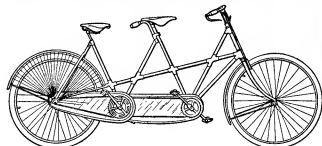

FIG. 16.

a bias in one direction or the other, putting a nervous strain on the steersman which becomes almost intolerable towards the end of a long ride.

Motor Bicycles.—Fig. 17 shows a touring motor bicycle, fitted with luggage carrier and stand, the latter for supporting the bicycle while at rest. The average speed of a motor bicycle being much greater than that of a pedal bicycle the stresses on the frame due to moving over rough roads are greater. This necessitates greater strength and weight in all parts—frame, wheels and tires. To take this increased weight up steep gradients requires increased engine power. The weight of a touring motor bicycle may be from 150 to 200 lb. The drive is usually by a V belt of leather, or of canvas and rubber, the angle of the V being 28°. The engine speed at maximum power is from 1500 to 2000 revolutions a minute, and the belt gears down in a ratio varying between $\frac{3}{4}$ and $\frac{2}{3}$ according to the cylinder capacity of the engine. The possibility of the belt slipping slightly is conducive to smoothness of drive; chain-driving, except in combination with a slipping clutch, is too harsh. The principal defect of the belt drive is that the belt stretches, and on coming to a steep hill may have to be tightened before the bicycle can be driven up. The control of the speed and power of the engine is effected by the throttle, extra air valve and spark advance, the

levers for which are all placed within convenient reach of the driver. As the engine is almost invariably air-cooled, the skilful manipulation of these three levers is essential for satisfactory results. On a good level road when the engine may be working at a small fraction of its maximum power, the proportion of air mixed with the petrol vapour from the carburettor may be great, giving a "weak" mixture, yet one rich enough to be ignited in the cylinder. The throttle valve may be fully open and the spark advanced for high speed; the throttle partially closed and spark retarded for slow speed. Under these conditions the engine will run for an indefinite period without overheating. Up a steep gradient, the mixture may have to be made "richer" by partial closing of the extra air opening, and as more heat is evolved, the cylinder walls may become overheated, unless the engine power is sufficient to keep the bicycle moving through the air at a good speed. As the engine cannot run steadily at low speed, pedalling is resorted to for starting and for riding slowly through traffic. For this purpose, an "exhaust valve lifter" is usually fitted, by means of which the exhaust can be kept

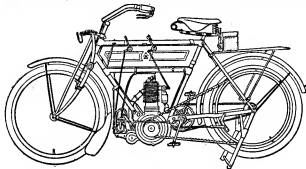

FIG. 17.

permanently open, in order to relieve the resistance to pedalling which the compression stroke would otherwise offer.

The nominal rating of the horse-power of a motor cycle engine is rather vague and indefinite. A 3-H.P. engine may have a cylinder of 76-80 mm. diameter and 76-80 mm. stroke. Twin-cylinder engines, with one crank, are largely used, and some excellent 4-cylinder motor bicycles are made with bevel gear transmission. The chief advantage of the multicylinder engine is the smoother drive obtained.

A "trailer" with two wheels for carrying a passenger can be attached to a motor bicycle, but the element of risk is increased. A side-car, with one additional wheel, forms a safer passenger carrier. (A. Sp.)

BIDA, a town and administrative district in the British protectorate of Northern Nigeria. Bida town, situated in 9° 5' N., 6° E., 25 m. N. by E. of Muraji on the Niger, is the capital of the province of Nupe. It was founded in 1859 when Fula rule was established in Nupe, is walled and of considerable size. In 1909 it was connected by railway with Baro, 40 m. S.S.E., the river terminus of the Northern Nigeria railway. The inhabitants, mostly Hausa, carry on an extensive trade and are especially noted for their embossed brass and copper work. The Bida goblets, in which brass and copper are beautifully blended, are of extremely elegant design. The town also boasts a glass factory. The preparation of indigo and the dyeing of cloths are other flourishing industries. The streets are planted with huge shade-trees, so that as Bida is approached it looks like a forest.

In 1897 there was a two-days' fight outside the walls of Bida between the forces of the emir of Nupe and those of the Royal Niger Company, ending in the defeat of the Fula army (mostly cavalry). The victory was not followed at the time by a British occupation, and the defeated king returned after the withdrawal of the company's troops and re-established himself upon the throne. In 1900 he allied himself with other hostile chiefs and adopted an openly antagonistic attitude to the British government. In 1901 it became necessary for British troops to march on Bida. The emir fled, without fighting, to Kano. Another emir was appointed in his place, and the province of Nupe was placed under British administrative control. Since that date the town has been peaceful and very prosperous. A mission school has been established, and is attended by the sons of the emir and of the principal chiefs, who are desirous of learning to read and write English. The administrative district of Bida includes the town and is the western division of the province of Nupe (q.v.). (See also NIGERIA: *History*.)

BIDDEFORD, a city of York county, Maine, U.S.A., on the Saco river, opposite Saco, and on the Atlantic Ocean, 15 m. S.W. of Portland. Pop. (1890) 14,443; (1900) 16,145, of whom 7,149 were foreign-born (mostly French Canadians); (census, 1910) 17,079. Biddeford is served by the Boston & Maine railway, and is connected by electric lines with Portland and with Old Orchard Beach, a popular summer resort north of the Saco river. The climate and the scenery in and about Biddeford attract summer visitors and there are two resorts, Biddeford Pool and Fortune Rocks within the municipal limits; but the city is chiefly a manufacturing centre (third in rank among the cities of the state in 1905)—good water-power being furnished by the river—and cotton goods, foundry and machine shop products and lumber are the principal products, the first being by far the most important. The value of the factory products increased from \$5,472,254 in 1900 to \$6,048,722 in 1905, or 27%. There are large quarries of granite of excellent quality. A permanent settlement was established on both sides of the river about 1630 under the leadership of Richard Vines (1585-1651) and was named Saco. In 1718 the present name was adopted. In 1762 that portion of Biddeford which lay east of the river was incorporated as the town of Pepperellborough, for which name Saco was substituted in 1805. Biddeford was incorporated as a city in 1855.

BIDDER, GEORGE PARKER (1806-1878), English engineer, was born at Moreton Hampstead, in Devonshire, on the 14th of June 1806. From a very early age he manifested an extraordinary natural aptitude for calculation, which induced his father, who was a stone-mason, to exhibit him as a "calculating boy." In this way his talent was turned to profitable account, but his general education was in danger of being completely neglected. Interest, however, was taken in him by some of those who happened to witness his performances, among them being Sir John Herschel, and it was arranged that he should be sent to school in Camberwell. There he did not remain long, being removed by his father, who wished to exhibit him again, but he was saved from this misfortune and enabled to attend classes at Edinburgh University, largely through the kindness of Sir Henry Jardine, to whom he subsequently showed his gratitude by founding a "Jardine Bursary" at the university. On leaving college in 1824 he received a post in the ordnance survey, but gradually drifted into engineering work. In 1834 Robert Stephenson, whose acquaintance he had made in Edinburgh, offered him an appointment on the London & Birmingham railway, and in the succeeding year or two he began to assist George Stephenson in his parliamentary work, which at that time included schemes for railways between London and Brighton and between Manchester and Rugby via the Potteries. In this way he was introduced to engineering and parliamentary practice at a period of great activity which saw the establishment of the main features and principles that have since governed English railway construction. He is said to have been the best witness that ever entered a committee-room. He was quick to discover and take advantage of the weak points in an opponent's case, and his powers of mental calculation frequently stood him in good stead, as when, for example, an apparently casual glance at the plans of a railway enabled him to point out errors in the engineering data that were sufficient to secure rejection of the scheme to which he was opposed. In consequence there was scarcely an engineering proposal of any importance brought before parliament in connexion with which his services were not secured by one party or the other.

On the constructive side of his profession he was also busily occupied. In 1837 he was engaged with R. Stephenson in building the Blackwall railway, and it was he who designed the peculiar method of disconnecting a carriage at each station while the rest of the train went on without stopping, which was employed in the early days of that line when it was worked by means of a cable. Another series of railways with which he had much to do were those in the eastern counties which afterwards became the Great Eastern system. He also advised on the construction of the Belgian railways; with R.

Stephenson he made the first railway in Norway, from Christiania to Eidsvold; he was engineer-in-chief of the Danish railways; and he was largely concerned with railways in India, where he strongly and successfully opposed break of gauge on through-routes. But though he sometimes spoke of himself as a mere "railway-engineer," he was in reality very much more; there was indeed no branch of engineering in which he did not take an interest, as was shown by the assiduity with which for half a century he attended the weekly meetings of the Institution of Civil Engineers, of which he was elected president in 1860. He was one of the first to recognize the value of the electric telegraph. That invention was in its infancy when, in 1837, jointly with R. Stephenson he recommended its introduction on a portion of the London & Birmingham and on the Blackwall lines, while three years later he advised that it should be adopted to facilitate the working of the single line between Norwich and Yarmouth. He was also one of the founders of the Electric Telegraph Company, which enabled the public generally to enjoy the benefits of telegraphic communication. In hydraulic engineering, he was the designer of the Victoria Docks (London), being responsible not only for their construction, but also for what was regarded by some people at the time as the foolish idea of utilizing the Essex marshes for dock accommodation on a large scale. His advice was frequently sought by the government on points both of naval and military engineering. He died at Dartmouth on the 28th of September 1878.

His son, **GEORGE PARKER BIDDER, JUNR.** (1836-1896), who inherited much of his father's calculating power, was a successful parliamentary counsel and an authority on cryptography.

BIDDERY, or **BIDRI** (an Indian word, from Bedar or Bidar, a town in the Nizam's Dominions), an alloy of copper, lead, tin and zinc used in making various articles and ornaments which are inlaid with gold and silver.

BIDDING-PRAYER (O. Eng. *biddan*, to pray, cf. Ger. *beten*), the formula of prayer or exhortation to prayer said in England before the sermon in cathedrals, at university sermons, in the Inns of Court and elsewhere on special occasions. Such formulae are found in the ancient Greek liturgies, e.g. that of St Chrysostom, in the Gallican liturgy, and in the pre-Reformation liturgies of England. The form varies, but in all the characteristic feature is that the minister tells the people what to pray for. Thus in England in the 16th century it took the form of a direction to the people what to remember in "bidding their beads." In course of time the word "bid" in the sense of "pray" became obsolete and was confused with "bid" in the sense of "command" (from O. Eng. *beodan*, to offer, present, and hence to announce, or command; cf. Ger. *bieten*, to offer, *gebieten*, to command), and the bidding-prayer has come practically to mean the exhortation itself. A form of exhortation which "preachers and ministers shall move the people to join with them in prayer" is given in the 53th canon of the Church of England (1603).

BIDDLE, JOHN (1615-1662), frequently called the father of English Unitarianism, was born on the 14th of January 1615, at Wotton-under-Edge, in Gloucestershire. He was educated at the grammar school of his native town and at Magdalen Hall, Oxford. He graduated B.A. in 1638 and proceeded M.A. in 1641, and was then appointed to the mastership of the free school in the city of Gloucester, where "he was much esteemed for his diligence in his profession, serenity of manners and sanctity of life." He also diligently prosecuted theological studies, and the results he arrived at were of such a nature as to draw down upon him the reprobation of the civic authorities. A treacherous friend obtained the manuscript of his *Twelve Arguments drawn out of Scripture, wherein the commonly received opinion touching the deity of the Holy Spirit is clearly and fully refuted*; and in December 1645 he was summoned before the parliamentary committee then sitting at Gloucester. By them he was committed to prison, though he was at the time labouring under a dangerous fever. He was released on bail after a short imprisonment, but was in July 1647 called before parliament, which

desired to inquire into his views. After tedious proceedings, during which Sir Henry Vane befriended him, Biddle was committed to custody and his *Twelve Arguments*, which he had now published, was ordered by parliament to be seized and burned by the hangman. Notwithstanding this and the ordinance of the 2nd of May 1648, visiting denial of the doctrine of the Trinity with death, Biddle issued two tracts, one a *Confession of Faith touching the Holy Trinity*, and the other *The Testimonies of Irenaeus, &c., concerning the one God and the Persons of the Trinity* (1648). These were suppressed by government, and the Westminster assembly of divines eagerly pressed for the passing of an act by which heretics like Biddle could be put to death. This, however, was resisted by the army, and by many of the Independent parliamentarians; and after the death of the king, Biddle was allowed to reside in Staffordshire under surveillance. He engaged in preaching and in literary work, particularly an edition of the Septuagint, published by Roger Daniel. In February 1652 the general act of oblivion gave him complete freedom, and his adherents soon began to meet regularly for worship on Sundays. They were called Biddellians, or Socinians, or Unitarians, the name which has now become associated with their opinions. Biddle was not left long in peace. He translated some Socinian books, among others the *Life of Socinus*, and published two catechisms which excited a fury of indignation. He was summoned before the parliament in December 1654, and imprisoned. The dissolution of that body again set him at liberty for a short time, but he was presently brought up for some expressions used by him in a discussion with John Griffin, an illiterate Baptist pastor, who invoked the law against his superior opponent. He was put upon trial, and was only rescued by Cromwell, who sent him (October 1655) out of the way to one of the Scilly Islands, allowed him 100 crowns a year, and in 1658, on the solicitation of many friends, released him. For a few years he lived and taught quietly in the country, but returning to London he was in June 1662 again arrested, and fined £100. As he was unable to pay this sum, he was at once committed to prison, where fever, caused by the pestilential atmosphere, carried him off on the 22nd of September 1662.

BIDDLE, NICHOLAS (1786–1844), American financier, was born in Philadelphia on the 8th of January 1786. He was the nephew of a naval officer, Captain Nicholas Biddle (1750–1778), who lost his life while fighting on the American side, during the War of American Independence. After almost finishing the prescribed course at the university of Pennsylvania, the boy went to Princeton, where he graduated with high honours in 1801. During 1804–1807 he was the secretary, first of John Armstrong, minister to France, and then of James Monroe, minister to Great Britain. After his return to America he practised law for several years in Philadelphia, was an associate editor of Dennie's *Portfolio*, to which he contributed both prose and verse, and, with much literary skill, prepared for the press from the explorers' own journals a *History of the Expedition under the Command of Captains Lewis and Clark* (1814). He was a prominent member of the Pennsylvania House of Representatives in 1810–1811 and of the Senate in 1814–1817, and in 1819 became, by President Monroe's appointment, one of the five government directors of the Bank of the United States. In 1823 he replaced Langdon Cheves as its president. In general he followed a conservative policy and showed marked ability in the management of the bank, but during President Andrew Jackson's warfare upon that institution, his character and his policy were violently assailed by the president and his followers. The bank's national charter lapsed in 1836, but it was immediately chartered by Pennsylvania as the "Bank of the United States, of Pennsylvania"; and Biddle remained president until 1839, two years before the bank failed. As president of the board of trustees appointed for the purpose, he took a prominent part in the establishment of Girard College, in accordance with the will of Stephen Girard (*q.v.*). He died in Philadelphia on the 27th of February 1844.

His son, CHARLES JOHN BIDDLE (1819–1873), served in the

Mexican War as a captain of infantry, earning the brevet of major at Chapultepec; practised law in Philadelphia; was a representative in Congress in 1861–1863; was long editor-in-chief of the *Philadelphia Age*; and published "The Case of Major André, with a Review of the Statement of it in Lord Mahon's *History of England*," in the *Memoirs of the Historical Society of Pennsylvania* (1858).

The best account of Nicholas Biddle's administration of the bank may be found in an excellent work, by Ralph C. H. Cattrall, *The Second Bank of the United States* (Chicago, 1903).

BIDEFORD, a seaport, market town and municipal borough in the Barnstaple parliamentary division of Devonshire, England, 8½ m. S.W. of Barnstaple. Pop. (1901) 8754. It is served by the London & South-Western and the Bideford, Westward Ho & Appledore railways. It is picturesquely situated on two hills rising from the banks of the river Torridge, 3 m. above its junction with the estuary of the Taw. Many of the houses are built with timber framework in Elizabethan style, and the two parts of the town are united by a bridge of 24 arches, originally erected in the 14th century, when the revenue of certain lands was set apart for its upkeep. The church of St Mary, with the exception of the tower, is a modern reconstruction. A stone chancel screen and a Norman font are also preserved. Industries include the manufacture of earthenware, leather goods, sails, ropes and linen, and ironfounding. The small harbour has about 17 ft. of water at high tide, but is dry at low tide. Anthracite and a coarse potter's clay are found near the town. The borough is under a mayor, 4 aldermen and 12 councillors. Area, 3398 acres.

Bideford (Bedeford, Bydyford, Budeford, Bytheford) is not mentioned in pre-Conquest records, but according to Domesday it renders tithes for three hides to the king. From the time of the Conquest down to the 18th century, Bideford remained in the possession of the Grenville family, and it first appears as a borough in an undated charter (probably of the reign of Edward I.) from Richard de Grenville, confirming a charter from his grandfather, Richard de Grenville, fixing the rent and services due from the burgesses and granting them liberties similar to those in use at Breteuil and a market every Monday. Another charter, dated 1271, confirms to Richard de Grenville and his heirs a market every Monday and five days' fair yearly at the feast of St Margaret (20th of July). In 1573 Elizabeth granted a charter creating Bideford a free borough corporate, with a common council consisting of a mayor, 5 aldermen and 7 chief burgesses, together with a recorder, town-clerk and 2 sergeants-at-mace. This charter also granted the Tuesday market, which is still held, and three annual fairs in February, July and November, now discontinued. A later charter from James I. in 1610 added the right to have a town seal, 7 aldermen instead of 5, and 10 chief burgesses instead of 7, and continued in force until the Municipal Corporations Act of 1873, which established 4 aldermen and 12 common councillors. In the 16th century Sir Richard Grenville, the famous Virginian settler, did much to stimulate the commercial development of Bideford, which long maintained a very considerable trade with America, Spain and the Mediterranean ports, the import of tobacco from Maryland and Virginia being especially noteworthy. From the beginning of the 18th century this gradually declined and gave place to a coasting trade in timber and coal, chiefly with Wales and Ireland. The silk industry which flourished in the 17th century is extinct.

See John Watkins, *History of Bideford* (Exeter, 1792).

BIDPAI (or PILEPA), **FABLES OF**, the name given in the middle ages (from Sanskrit *Vidya-pati*, chief scholar) to a famous collection of Hindu stories. The origin of them is undoubtedly to be found in the *Pancha Tantra*, or Five Sections, an extensive body of early fables or apologues. A second collection, called the *Hitopadesa*, has become more widely known in Europe than the first, on which it is apparently founded. In the 6th century A.D., a translation into Pahlavi of a number of these old fables was made by a physician at the court of Chosroes I. Anushirvan, king of Persia. No traces of this Persian translation can now be found, but nearly two centuries later, Abdallah-ibn-Mokaffa translated the Persian into Arabic; and his version, which is known as the "Book of Kalilah and Dimna," from the two jackals in the first story, became the channel through which a knowledge of the fables was transmitted to Europe. It was translated into Greek by Simeon Sethus towards the close of the 11th century; his version, however, does not appear to have been retranslated into any other European language. But the

Hebrew version of Rabbi Joel, made somewhat later, was translated in the 13th century into Latin by John of Capua, a converted Jew, in his *Directorium vitae humanae* (first published in 1480), and in that form became widely known. Since then the fables have been translated into nearly every European tongue. There are also versions of them in the modern Persian, Malay, Mongol and Afghan languages.

See Wilson's analysis of the Pancha Tantra, in the *Mem. of the Royal Asiatic Soc.* i.; Silvestre de Sacy's introduction to his edition of the *Kalilah and Dimnah* (1816); articles by the same in *Notices et Extr. des MSS. de la Bib. du Roi*, vols. ix. and x.; German translation by Philipp Wolff, *Bidpai's Fabeln* (2 vols., 2d. ed., Stuttgart, 1839); the *Amor-i Sukeini*, Persian version of the Fables, translated by E. B. Eastwick (Hertford, 1854); Benefy, *Pancha Tantra*, German translation with important introduction (2 vols., Leipzig, 1859); other editions, by L. Fritze (ib. 1884) and R. Schmidt (ib. 1901); Max Müller, *Essays* (Leipzig, 1872), vol. iii. pp. 303, &c.; J. Jacob's edition of Sir T. North's *Moral Philosophie von Doni*, the earliest English version of the fables (London, 1888); J. G. N. Keith-Falconer, *Kalilah and Dimnah, or the Fables of Bidpai* (Cambridge, 1895), their history, with a translation of the later Syriac version and notes; Léopold Herveux, *Les Fables des Latins*, &c. v. *Jeune de Capoue et ses dérivés* (1899); E. G. Browne, *Persian Literat.* (1906), ii. 350.

BIEBKICH, a town of Germany, in the Prussian province of Hesse-Nassau, on the right bank of the Rhine, 3 m. S. from Wiesbaden, of which it is the river port, and on the main line of railway from Cologne to Frankfurt-on-Main. Pop. (1900) 15,048; (1905) 20,137. The palace of the former dukes of Nassau occupies a fine position on the river bank, and the shady gardens and groves attract large numbers of visitors during the summer. It is an important steambat station for both passenger and cargo traffic, and besides manufactures of cement, dyes and soap, has a considerable trade in the wines of the district.

BIEDERMANN, FRIEDRICH KARL (1812-1901), German publicist and historian, was born at Leipzig on the 25th of September 1812, and after studying at Leipzig and Heidelberg became professor in the university of his native town in 1838. His early writings show him as an ardent advocate of German unity, and he was a member of the national parliament which met at Frankfurt in 1848. Becoming a member of the Upper House of the parliament of Saxony, he advocated union under the leadership of Prussia; and, subsequently losing his professorship, he retired to Weimar, where he edited the *Weimarer Zeitung*. Returning to Leipzig in 1863 he edited the *Deutsche Allgemeine Zeitung*, and regained his professorship in 1865. He was again a member of the Saxon Upper House, and from 1871 to 1874 a member of the German Reichstag. He died at Leipzig on the 5th of March 1901. Biedermann's chief works are: *Erinnerungen aus der Paulskirche* (Leipzig, 1849); *Deutschland im 18. Jahrhundert* (Leipzig, 1854-1880); *Friedrich der Grosse und sein Verhältnis zur Entwicklung des deutschen Geisteslebens* (Brunswick, 1850); *Geschichte Deutschlands 1815-1871* (Berlin, 1891); *Deutsche Volks- und Kulturgeschichte* (Wiesbaden, 1901). He also wrote the dramas, *Kaiser Heinrich IV.* (Weimar, 1861); *Kaiser Otto III.* (Leipzig, 1862); and *Der letzte Bürgermeister von Strassburg* (Leipzig, 1870).

BIEL, GABRIEL (c. 1425-1495), scholastic philosopher, was born at Spires (Speier). He was the first professor of theology at the newly founded (1477) university of Tübingen, of which he was twice rector. Some years before his death he entered a religious fraternity. His work consists in the systematic development of the views of his master, William of Occam. His *Epitome et Collectorium ex Occamo super libros quatuor Sententiarum* (1508, 1512, and various dates) is a clear and consistent account of the nominalist doctrine, and presents the complete system of scholastic thought from that point of view. The empirical individualism of the work, tending necessarily to limit the province of reason and extend that of faith, together with scattered utterances on special points, which gained for Biel the title of *Papista Antipapista*, had considerable influence in giving form to the doctrines of Luther and Melancthon. It is the best specimen of the final aspect of scholasticism. His other works also have been frequently reprinted. The title *Ultimus Scholasticorum* is often wrongly bestowed on Biel; scholasticism

did not cease with him, even in Germany, and continued to flourish long after his time in the universities of Spain.

See Linsenmann, in *Theologischen Quartalschrift* (Tübingen, 1865); Seckel, *Phil.* ii. § 209; H. Plitt, *Gabriel Biel als Prediger* (Erlangen, 1879); art. 320, by P. Tschackert in Herzog-Hauck, *Realencyklopädie*, vol. iii. (1897); W. Roscher, *Ges. d. Nationalökonomik* (Munich, 1874), pp. 21-28; and works quoted under SCHOLASTICISM.

BIELEFELD, a town of Germany, in the Prussian province of Westphalia, 68 m. S.W. from Hanover on the main line to Cologne. Pop. (1885) 34,931; (1905) 71,797. It is situated at the foot of the Teutoburger Wald, and consists of two portions, separated by the river Lutter, which were first united into one town in 1520. Among its public buildings and institutions are the old town church, with a curious carved altar-piece, the town hall, the gymnasium and the provincial industrial school. On the height above the town is the old castle of Sparenburg, built in the 12th century by Bernhard, count of Lippe. It was for a long time employed as a prison, but was restored after its destruction by fire in 1877 and now contains a historical museum. Bielefeld is the centre of the Westphalian linen industry. It has also important plush, silk and hosiery manufactures, as well as extensive bleaching works, and does a very large export trade to all parts of the world in these branches. Engines, automobiles, biscuits, glass, pianos, furniture and paper are also manufactured.

Bielefeld is mentioned as early as the 9th century, as *Belanfelde*, but its first recorded mention as a town is in 1233. It belonged at this time to the counts of Ravensberg, who often resided in the Sparenburg. It joined the Hanseatic league in 1270, and about the same time began to engage in the linen manufacture, which was greatly extended during the 16th and 17th centuries by a number of refugees from the Netherlands. In 1347 the town passed with the county of Ravensberg to the duchy of Jülich, and in 1666 to that of Brandenburg.

BIELITZ (Czech *Bilsko*, Polish *Bielsko*), a town of Austria, in Silesia, 80 m. S.E. of Troppau by rail. Pop. (1900) 16,885, chiefly German. It is situated on the Biala river, just opposite the Galician town of Biala and possesses a fine castle belonging to the Sulzkowsky family, in favour of whom the lordship of Bielitiz was raised to a duchy in 1752. It has an important woolen and linen industry, and manufactures of jute and machinery, as well as an active trade, especially of woollens, to the East. The town was founded in the 13th century, and in the 15th and 16th was a fortified place.

BIELLA, a town and episcopal see of Piedmont, Italy, in the province of Novara, 55 m. N.E. of Turin by rail, and 38 m. direct, situated on the S. edge of the lower Alps. Pop. (1901) town, 34,54; commune, 19,267. The old town (1,558 ft.) lies on a hill above the new town, and is reached from it by a cable tramway. It has fine palaces with decorations in terra-cotta; and a modern bath establishment is situated here. The new town contains the 15th-century cathedral and the fine Renaissance church of S. Sebastiano; near the former is a baptistry of the 9th century. It is a considerable manufacturing centre for woollens, silks and cottons, electric power being furnished by the torrents descending from the mountains at the foot of which it lies. It is frequented as a tourist centre, and several hydrographic establishments and mountain resorts lie in the vicinity.

BIENNE, or BIEL, an industrial town in the Swiss canton of Bern. It is built between the N.E. end of the lake of the same name and the point at which the river Suze or Scheuss (on the right bank of which it is situated) issues from a deep cleft (called the Taubenloch) in the Jura range. Biemme is 10 m. by rail N.E. of Neuchâtel, and 21 m. N.W. of Bern. Its industrial importance is shown by the fact that it is the site of the West Swiss technical institute, which has departments for instruction in watch-making, in electricity, in engraving and chasing, and in subjects relating to railway, postal and telegraph matters. Its chief industries are watch-making, chain-making, the manufacture of machines and other objects for use on railways, &c. Its rapidly increasing commercial activity accounts no doubt for the rapid rise in its population, which in 1850 was but 3580, rose in 1870 to 8165, and in 1900 was 22,016, mainly Protestant,

and two-thirds German-speaking. The parish church of St Benedict dates from 1451, but was restored in 1775—it has some fine 15th-century painted glass in the choir. In the town is the Schwab museum, which is chiefly notable for its fine collection of objects from the lake-dwellings. To the north-west of Biemme two funicular railways lead up to Évilard (or Leubringen) and Macolin (or Magglingen), both situated on the slope of the Jura.

First mentioned in the 12th century, Biemme continued for centuries to be under the jurisdiction of the prince-bishop of Basel. In 1279 (permanently in 1352) it made an alliance with Bern, in 1344 with Soleure, and in 1382 with Fribourg. But its attempts to be admitted into the Swiss Confederation were fruitless, though after it adopted the Reformation in 1525, it was closely associated with the Protestant cantons. In 1798 it was seized by the French, but in 1815, with the greater part of the bishopric of Basel, it became part of the canton of Bern.

See C. A. Bloesch, *Geschichte der Stadt Biel* (to 1854), (3 vols., Biel, 1855-1856). (W. A. B. C.)

BIENNE, LAKE OF, or **BIELERSEE**, a lake in Switzerland, S.W. of the town of Biemme, and extending along the southern foot of the Jura range. It is $\frac{7}{8}$ m. in length, $\frac{2}{3}$ m. broad and 240 ft. in depth, while its surface is 1424 ft. above the sea-level, and its area 16 sq. m. In it is the Île de St Pierre, where Rousseau resided for a short time in 1765. Many traces of lake-dwellings have been discovered on the shores of the lake. It receives the river Suze or Scheuss at its north-east end, while the Hagneck canal leads the waters of the Aar into the lake, as that of Nidau conducts them out again. At the south-western end the river Thiële or Zihl flows into this lake from that of Neuchâtel. (W. A. B. C.)

BIERSTADT, ALBERT (1830-1902), American landscape painter, was born in Solingen, Westphalia, Germany, on the 7th of January 1830, and was taken to the United States when about a year old. In 1853-1856 he studied painting at Düsseldorf. His pictures of the western part of the United States, and particularly the Rocky Mountains, made him widely popular. His "Estes Park, Colorado," is in the collection of the Earl of Dunraven; his "Sierra Nevada" (1878) is in the Corcoran Gallery in Washington, and "The Valley of Yosemite" in the James Lenox collection in New York. He received many German and Austrian decorations, and was a chevalier of the French Legion of Honour. He rendered panoramic views with a certain ability, though his work was rather topographically correct and impressive than artistic in conception and execution. He was a member of the National Academy of Design of New York, and is represented by two historical paintings, "The Discovery of the Hudson River," and "The Settlement of California," in the Capitol in Washington, D.C. He died in New York City on the 18th of February 1902.

BIFROST, in Old Norse mythology, the rainbow, which was supposed to form the bridge by which the gods passed between heaven and earth. It was guarded by Heimdal, god of light.

BIGAMY (from Lat. *bis*, twice, and Gr. *γάμος*, marriage), in English law, according to the statute now in force (24 and 25 Vict. c. 100, § 57), the offence committed by a person who "being married shall marry any other person during the life of the former husband or wife." In the canon law the word had a rather wider meaning, and the marriage of a clerk in minor orders with a widow came within its scope. At the council of Lyons (A.D. 1274) bigamists were stripped of their privilege of clergy. This canon was adopted and explained by an English statute of 1276; and bigamy, therefore, became a usual counterplea to the claim of *benefit of clergy*. However, by an act of 1547 every person entitled to the benefit of clergy is to be allowed the same, "although he hath been divers times married to any single woman or single women, or to any widow or widows, or to two wives or more."

A bigamous marriage, by the ecclesiastical law of England, is simply void. By a statute of 1604 the offence was made a felony. This statute, after being repealed in 1828, was re-enacted and reproduced in the Offences against the Person Act 1861. It is immaterial whether the second marriage has taken place within

England and Ireland or elsewhere, and the offence may be dealt with in any county or place where the defendant shall be apprehended or be in custody. The following clause embodies the necessary exceptions to the very general language used in the definition of the offence:—"Provided that nothing in this section contained shall extend to any second marriage contracted elsewhere than in England and Ireland by any other than a British subject, or to any person marrying a second time whose husband or wife shall have been continuously absent from such person for the space of seven years then last past, and shall not have been known by such person to be living within that time, or shall extend to any person who at the time of such second marriage shall have been divorced from the bond of the first marriage, or to any person whose former marriage shall have been declared void by any court of competent jurisdiction." The punishment is penal servitude for not more than seven nor less than five years, or imprisonment with or without hard labour, not exceeding two years.

A valid marriage must be proved in the first instance in order to support a charge of bigamy. A *voidable* marriage, such as were marriages between persons within the prohibited degrees before the Marriage Act 1836, will be sufficient, but a marriage which is absolutely *void* as all such marriages now are, will not. For example, if a woman marry B during the lifetime of her husband A, and after A's death marry C during the lifetime of B, her marriage with C is not bigamous, because her marriage with B was a nullity. In regard to the second marriage (which constitutes the offence) the English courts have held that it is immaterial whether, but for the bigamy, it would have been a valid marriage or not. An uncle, for example, cannot marry his niece; but if being already married he goes through the ceremony of marriage with her he is guilty of bigamy. In an Irish case, however, it has been held that to constitute the offence the second marriage must be one which, but for the existence of the former marriage, would have been valid. With reference to the case in which the parties to the first marriage have been divorced, it may be observed that no sentence or act of any foreign country dissolving a *vinculo* a marriage contracted in England by persons continuing to be domiciled in England, for grounds on which it is not liable to be dissolved a *vinculo* in England will be recognized as a divorce (*R. v. Lolley* 1812, R. & R. 237). Hence, a divorce *a vinculo* for adultery, in a Scottish court, of persons married in England, is not within the statute. But if a person charged with bigamy in England can prove that he has been legally divorced by the law of the country where the divorced parties were domiciled at the time (even though the ground on which the divorce was granted was not one that would justify a divorce in England) it will be good defence to the charge. Criminal jurisdiction is always regarded as purely territorial, but bigamy (together with homicide and treason) is an exception to this rule. A British subject committing bigamy in any country may be tried for the same in the United Kingdom (Earl Russell's case, 1901).

In Scotland, at the date of the only statute respecting bigamy, that of 1551, cap. 10, the offence seems to have been chiefly considered in a religious point of view, as a sort of perjury, or violation of the solemn vow or oath which was then used in contracting marriage; and, accordingly, it was ordained to be punished with the *pro* and *pena* of perjury.

Bigamy was punished in England until the reign of William III. by death, then the penalty changed to life imprisonment and branding of the right hand. An act of George I. still in force lessened the penalty to deportation for seven years or imprisonment for two years with or without hard labour. The Offences against the Person Act 1861 changed deportation to penal servitude.

In the United States the law in regard to bigamy is practically founded on the English statute of 1604, with the exception that imprisonment and a fine, varying in the different states, were substituted instead of making the offence a felony. Congress has passed a statute declaring bigamy within the territories and places within the exclusive jurisdiction of the United

States to be a misdemeanour (U.S. Rev. Stat. § 5352). By statute in some states, upon absence of one spouse from the state for five years without being heard of, the other may marry again without committing bigamy, in other states the period is seven years. In most of the states, prosecutions for bigamy are barred after the lapse of a certain number of years. The marriage wherever solemnized must be a valid marriage according to the law of the place of solemnization; if void there, no prosecution for bigamy can be founded upon it. In some jurisdictions, an honest belief that a prior divorce of one of the parties was valid would be a defence to a prosecution for bigamy, in others the contrary is held.

On the continent of Europe, bigamy is punishable in most countries with varying terms of imprisonment, with or without hard labour, according to the circumstances of the case.

See Stephen, *History of Criminal Law*; Dicey, *Conflict of Laws*; *Report of the Royal Commission on Marriage Laws* (1868).

BIGELOW, JOHN (1817-), American journalist and diplomat, was born at Malden, New York, on the 25th of November 1817. He graduated at Union College in 1835, practised law in New York for several years after 1839; took up journalistic work; was joint owner (with William Cullen Bryant) and managing editor of the *New York Evening Post* (1849-1861); was United States consul at Paris in 1861-1864, and was minister to France in 1864-1867. While consul, Bigelow wrote *Les États-Unis d'Amérique en 1863* in order to counteract the apparent desire of the French people for a dissolution of the American Union, by showing them the relative importance of the commerce of the northern and southern states. On discovering in 1863 that a French shipbuilder, with the connivance of Napoleon III., was constructing two formidable iron-clads and two corvettes for the use of the Confederacy, he devoted his energies to thwarting this scheme, and succeeded in preventing the delivery of all but one of these vessels to the Confederate agents. In his work entitled *France and the Confederate Navy* (New York, 1888) he gives an account of this episode. In 1865-1866, he devolved upon Bigelow, as minister to France, to represent his government in its delicate negotiations concerning the French occupation of Mexico, and he discharged this difficult task with credit. From 1875 to 1877 he served as secretary of state of New York. He wrote books of travel, of popular biography, or of historical or political discussion, &c., from time to time; but his principal literary achievements were editions, between 1868 and 1888, of Franklin's autobiography and autobiographical writings, copiously annotated; and of the complete works of Franklin, in ten octavo volumes (New York, 1887-1889). These editions were based in part upon the editor's personal investigations of manuscript sources in France and elsewhere, and supplanted the well-known, long serviceable, but less accurate edition of Jared Sparks (Boston, 1836-1840); they have in turn been supplanted by the edition of A. M. Smythe (10 vols., 1905-1907). Mr Bigelow was a close friend of Samuel J. Tilden, and became his literary executor, editing his speeches and other political writings (1885), publishing a biography in 1895, and editing a two-volume collection of Tilden's letters and literary memorials (1908). He also wrote a biography of William Cullen Bryant (1890). In 1897 he published a volume entitled *The Mystery of Sleep* (2nd ed., 1903). In 1909 he published *Retrospections of an Active Life*.

BIGGAR, a police burgh of Lanarkshire, Scotland. Pop. (1901) 1366. It is situated about 10 m. S.E. of Carstairs Junction (Caledonian railway), where the lines from Edinburgh and Glasgow connect. Lying on Biggar Water and near the Clyde, in a bracing, picturesque, upland country, Biggar enjoys great vogue as a health and holiday resort. It was the birthplace of Dr John Brown, author of *Rab and his Friends*, whose father was secession minister in the town. It was created a burgh of barony in 1451 and a police burgh in 1863. St Mary's church was founded in 1545 by Lord Fleming, the head of the ruling family in the district, whose seat, Boghall Castle, however, is now a ruin. John Gledstanes, great-grandfather of W. E. Gladstone, was a Burgess of Biggar, and lies in the churchyard.

Easter Gledstanes, the seat of the family from the 13th to the 17th century, and the estate of Arthursheils, occupied by them for nearly a hundred years more, are situated about $\frac{3}{4}$ m. to the north-west of the burgh. On the top of Quothquan Law (1097 ft.), about 3 m. west is a rock called Wallace's Chair, from the tradition that he held a council there prior to the battle of Biggar in 1207. Lamington, nearly 6 m. south-west, is well situated on the Clyde. It is principally associated with the family of the Baillies, of whom the most notable were Cuthbert Baillie (d. 1514), lord high treasurer of Scotland, William Baillie, Lord Provand (d. 1593), the judge, and William Baillie (fl. 1648), the general whose strategy in opposition to the marquis of Montrose was so diligently studied by the committee of estates. The ancient church of St Ninian's has a fine Norman doorway. Lamington Tower was reduced to its present fragmentary condition in the time of Edward I, when William Heselrig, the sheriff, laid siege to it. The defenders, Hugh de Bradute and his son, were slain, and his daughter Marion—the betrothed, or, as some say, the wife of William Wallace—was conveyed to Lanark, where she was barbarously executed because she refused to reveal the whereabouts of her lover. Wallace exacted swift vengeance. He burnt out the English garrison and killed the sheriff.

BIGGLESWADE, a market town in the Biggleswade parliamentary division of Bedfordshire, England, 41 m. N. by W. of London by the Great Northern railway. Pop. of urban district (1901) 5120. It lies on the east bank of the Ivel, a tributary of the Ouse, in a flat plain in which vegetables are largely grown for the London markets. The town is a centre of this trade.

Biggleswade (Bichelswade, Beckelswade, Bickleswade) is an ancient borough by prescription which has never returned representatives to parliament. The borough court was held by the lord of the manor. At the time of Edward the Confessor, Archbishop Stigand owned the manor, which according to Domesday passed to Ralf de Insula. Henry I. granted it to the bishop of Lincoln, under whose protection the borough evidently grew up. In 1547 the bishop surrendered his rights to the king, and in the 17th century Biggleswade formed part of the jointure of the queens of England. Owing to its important position on the Roman road to the north the town became an agricultural centre for the surrounding district. In 1335 Edward III. renewed the bishop's licence to hold a Monday market, and annual fairs were held here from very early times. Those for horses are mentioned as famous by Camden. In addition to agriculture, Biggleswade was formerly engaged in straw-plaiting and lace manufacture.

BIGHT (O. Eng. *bight*, bend; cf. Ger. *Bucht*, a bay, and *beigen*, to bend), a nautical term for the loop or bent part of a rope, as distinguished from the ends; also a geographical term for a bay between two distant headlands, or with a shallow curve, e.g. the Bight of Benin, the Great Bight of Australia.

BIGNON, JÉRÔME (1589-1656), French lawyer, was born at Paris in 1589. He was uncommonly precocious, and under his father's tuition had acquired an immense mass of knowledge before he was ten years of age. In 1600 was published a work by him entitled *Chorographie, ou description de la Terre Sainte*. The great reputation gained by this book introduced the author to Henry IV., who placed him for some time as a companion to the duc de Vendôme, and made him tutor to the dauphin, afterwards Louis XIII. In 1604 he wrote his *Discours de la ville de Rome*, and in the following year his *Traité sommaire de l'élection du pape*. He then devoted himself to the study of law, wrote in 1610 a treatise on the precedence of the kings of France, which gave great satisfaction to Henry IV., and in 1613 edited, with learned notes, the *Formulae* of the jurist Marculfé. In 1620 he was made advocate-general to the grand council, and shortly afterwards a councillor of state, and in 1626 he became advocate-general to the parlement of Paris. In 1641 he resigned his official dignity, and in 1642 was appointed by Richelieu to the charge of the royal library. He died in 1656.

BIGNON, LOUIS PIERRE ÉDOUARD, BARON (1771-1841), French diplomatist and historian, born on the 3rd of January 1771, was the son of a dyer at Rouen. Though he had received a good education, he served throughout the early part of the revolutionary wars without rising above the rank of private. In 1797, however, the attention of Talleyrand, then minister of foreign affairs, was called to his exceptional abilities by General

Huet, and he was attached to the diplomatic service. After serving in the legations in Switzerland and the Cisalpine republic, he was appointed in 1799 attaché to the French legation at Berlin, of which three years later he became chargé d'affaires. As minister-plenipotentiary at Cassel, between the years 1804 and 1806, he took a prominent share in the formation of the confederation of the Rhine; and after the battle of Jena he returned to Prussia as administrator of the public domains and finances. He filled a similar function in Austria after the battle of Wagram. At the end of 1810 he became French resident at Warsaw and was for a couple of years supreme in the affairs of the grand duchy.

The preparation of a constitution for Poland, on which he was engaged, was, however, interrupted by the events of 1812. Bignon, after a short imprisonment at the hands of the allies, returned to France in time to witness the downfall of Napoleon. During the Hundred Days he once more entered Napoleon's service, and, after Waterloo, as minister of foreign affairs under the executive commission, it was he who signed the convention of the 3rd of July 1815, by which Paris was handed over to the allies. Bignon did not re-enter public life until 1817, when he was elected to the chamber of deputies, in which he sat until 1830, consistent in his opposition to the reactionary policy of successive governments. His great reputation and his diplomatic experience gave a special weight to the attacks which he published on the policy of the continental allies, two of his works attracting special attention, *Du Congrès de Troppan ou Examen des prétentions des monarchies absolues à l'égard de la monarchie constitutionnelle de Naples* (Paris, 1821), and *Les Cabinets et les peuples depuis 1815 jusqu'à la fin de 1822* (Paris, 1822).

The revolution of 1830, which brought his party into power, only led to a very temporary resumption of office by Bignon. He was for a few weeks minister of foreign affairs in the first government of Louis Philippe, and again for a few weeks minister of public instruction. But the idea of making him responsible for the foreign policy of France could not be realized owing to the necessity under which Louis Philippe lay of courting the goodwill of the powers, whom Bignon had offended by his outspoken writings. Elected deputy in 1831 and member of the chamber of peers in 1839, he withdrew for the most part from politics, to devote himself to his great work, the *Histoire de France sous Napoléon* (10 vols. 1829-1838, then 4 posthumous vols., 1847-1850). This history, while suffering from the limitations of all contemporaneous narratives, contains much that does not exist elsewhere, and is one of the best-known sources for the later histories of Napoleon's reign.

See Mignet, *Notice historique sur la vie et les ouvrages de M. Bignon* (1848).

BIGOD, HUGH (d. 1177), earl of Norfolk, was the second son of Roger Bigod (d. 1107), the founder of the English family of this name. Hugh inherited large estates in East Anglia on the death of his brother William in 1120, and enjoyed the favour of Henry I. At first a supporter of Stephen during this king's struggle with the empress Matilda, Hugh was rewarded with the earldom of Norfolk before 1141. After having fought for the king at the battle of Lincoln the earl deserted him, assumed a position of armed neutrality during the general anarchy, and then assisted Henry II. in his efforts to obtain the throne. This king confirmed him in the possession of his earldom; but becoming restless under the rule of law initiated by Henry, he participated in the revolt of 1173, which so far as England was concerned centred round his possessions. Though defeated and compelled to surrender his castles, Bigod kept his lands and his earldom, and lived at peace with Henry II. until his death, which probably took place in Palestine.

His son ROGER (d. 1221), who succeeded to the earldom of Norfolk, was confirmed in his earldom and other honours by Richard I., after he had fallen under the displeasure of Henry II. He took part in the negotiations for the release of Richard from prison, and after the king's return to England became justiciar. The earl was one of the leaders of the baronial party which obtained John's assent to Magna Carta, and his name appears among the signatories to this document.

Roger was succeeded as 3rd earl by his son, Hugh, who died in 1225, leaving a son, ROGER (d. 1270), who became 4th earl of Norfolk. Through his mother, Matilda, a daughter of William Marshal, earl of Pembroke, Roger obtained the office of marshal of England in 1246. He was prominent among the barons who wrested the control of the government from the hands of Henry III., and assisted Simon de Montfort. The earl married Isabella, daughter of William the Lion, king of Scotland, but left no sons.

Hugh, the 3rd earl, left a younger son, HUGH (d. 1266), who was chief justiciar of England from 1258 to 1260, and who fought for Henry III. at the battle of Lewes. The latter's son, ROGER, succeeded his uncle Roger as 5th earl of Norfolk in 1270. This earl is the hero of a famous altercation with Edward I. in 1297, which arose out of the king's command that Bigod should serve against the king of France in Gascony, while he went to Flanders. The earl asserted that by the tenure of his lands he was only compelled to serve across the seas in the company of the king himself, whereupon Edward said, "By God, earl, you shall either go or hang," to which Bigod replied, "By the same oath, O king, I will neither go nor hang." The earl gained his point, and after Edward had left for France he and Humphrey Bohun, earl of Hereford, prevented the collection of an aid for the war and forced Edward to confirm the charters in this year and again in 1301. Stubbs says Bigod and Bohun "are but degenerate sons of mighty fathers; greater in their opportunities than in their patriotism." The earl died without issue in December 1306, when his title became extinct, and his estates reverted to the crown. The Bigods held the hereditary office of steward (*dapifer*) of the royal household, and their chief castle was at Framingham in Suffolk.

See W. Stubbs, *Constitutional History*, vols. i. and ii. (1866-1897); J. R. Planché, "The Earls of East Anglia" (*Brit. Arch. Ass.*, vol. xxi., 1865); and E. C. Cokayne, *Complete Peerage*, vol. vi. (1895).

BIGOT, one obstinately and intolerantly holding particular religious opinions, who refuses to listen to reason and is ready to force others to agree with him; hence also applied to one who holds similar views on any subject. The early meaning of the word in English, at the end of the 16th century, was that of a religious hypocrite. The origin is obscure; it appears in French, in the forms *bigot* or *bigos*, in the 12th century romance of Girard of Roussillon, where it is applied to certain tribes of southern Gaul, and in the *Roman du Rou* of Wace (d. 1175?) as an abusive name given by the French to the Normans:

"Moult on Franchois Normans laidis
et de meffais et de mesdis.
Souvent lor dient reprovers,
et claiment Bigos et Draschiers."

To this use has been attached the absurd origin from "*ne se, bi god*," the words in which, according to the 12th century chronicle, Rollo, duke of the Normans, refused to kiss the foot of Charles III., the Simple, king of the West Franks. The word may have some connexion with a corruption of *visigoth*, a suggestion to which the use in the Girard romance lends colour. The meaning changed in French to that of "religious hypocrite" through the application, in the feminine *bigote*, to the members of the religious sisterhoods called Beguines (*q.v.*).

BIG RAPIDS, a city and the county-seat of Mecosta county, Michigan, U.S.A., on both sides of the Muskegon river, 56 m. N. by E. of Grand Rapids, in the west central portion of the lower peninsula. Pop. (1890) 5303; (1900) 4686, of whom 881 were foreign-born; (1910, U. S. census) 4510. It is served by the Père Marquette and the Grand Rapids & Indiana railways. Big Rapids is the seat of the Ferris Institute (opened 1884, incorporated 1894), a large private co-educational school, founded by W. N. Ferris. The river, which falls 16 ft. within the city limits, is dammed a short distance south of the city, and 16,000-horse-power is generated, part of which is transmitted to the city. The principal manufactures are lumber and furniture, and saw-filing and filing-room machinery. Big Rapids, named from the falls of the Muskegon here, was settled in 1854, was platted in 1859 and was chartered as a city in 1869.

BIGSBY, JOHN JEREMIAH (1792-1881), English geologist and physician, the son of Dr John Bigsby, was born at Nottingham on the 14th of August 1792. Educated at Edinburgh, where he took the degree of M.D., he joined the army medical service and was stationed at the Cape of Good Hope in 1817. About a year later he went to Canada as medical officer to a regiment, and having developed much interest in geology he was commissioned in 1819 to report on the geology of Upper Canada. In 1822 he was appointed British secretary and medical officer to the Boundary Commission, and for several years he made extensive and important geological researches, contributing papers to the *American Journal of Science* and other scientific journals; and later embodying an account of his travels in a book entitled *The Shoe and Canoe* (1850). Returning to England in 1827 he practised medicine at Newark until 1846 when he removed to London, where he remained until the end of his life. He now took an active interest in the Geological Society of London, of which he had been elected a fellow in 1823. In 1869 he was elected a fellow of the Royal Society, and in 1874 he was awarded the Murchison medal by the council of the Geological Society. During the last twenty years of his long life he was continually at work preparing, after the most painstaking research, tabulated lists of the fossils of the Palaeozoic rocks. His *Thesaurus Silaricus* was published with the aid of the Royal Society in 1868; and the *Thesaurus Devonico-Carboniferus* in 1878. In 1877 he founded the Bigsby medal to be awarded by the Geological Society of London, with the stipulation that the receiver should not be more than forty-five years old. He died in London on the 10th of February 1881.

BIHARI (properly *Bihārī*), the name of the most western of the four forms of speech which comprise the Eastern Group of modern Indo-Aryan Languages (*q.v.*). The other members are Bengali, Oriya and Assamese (see **BENGALI**). The number of speakers of Bihari in 1901 was 34,579,844 in British India, out of a total of 90,242,167 for the whole group. It is also the language of the inhabitants of the neighbouring Tarai districts of Nepal. In the present article it is throughout assumed that the reader is in possession of the facts described under the heads of **INDO-ARYAN LANGUAGES** and **PRAKRIT**. The article **BENGALI** may also be studied with advantage.

"Bihārī" means the language of the province of "Bihār," and to a certain extent this is a true description. It is the direct descendant of the old Māgadhī Prakrit (see **PRAKRIT**), of which the headquarters were South Bihar, or the present districts of Patna and Gaya. It is, however, also spoken considerably beyond the limits of this province. To the west it extends over the province of Agra so far as the longitude of Benares, and to the south it covers nearly the whole of the province of Chota Nagpur. Allowing for the speakers in Nepal, its area extends over about 90,000 sq. m., and the total number of people who claim it as a vernacular is about the same as the population of France. Bihari has been looked upon as a separate language only during the past twenty-five years. Before that it was grouped with all the other languages spoken between Bengal and the Punjab, under the general term "Hindi."

The usual character employed for writing Bihari is that known as *Kāshī*, a cursive form of the well-known Nagari character of Upper India. The name of the character is derived from the *Kāyath* or *Kāyasth* caste, whose profession is that of scribes. *Kāithi* is widely spread, under various names, all over northern India, and is the official character of Gujarati. The Nagari character is commonly employed for printed books, while the Brahmans of Tirhut have a character of their own, akin to that used for writing Bengali and Assamese. In the south of the Bihari tract the Oriya character belonging to the neighbouring Orissa is also found.

Bihari has to its east Bengali, also a language of the Outer Band. To its west it has Eastern Hindi, a language of the Intermediate Band (see **INDO-ARYAN LANGUAGES**). While it must decidedly be classed as an Outer language, it nevertheless shows, as might be expected, some points of contact with the Intermediate ones. Nothing is so characteristic of Bengali as

its pronunciation of the vowel *a* and of the consonant *s*. The first is sounded like the *o* in "hot" (transliterated *o*). In Eastern Bihari the same vowel has a broad sound, but not so broad as in Bengali. As we go westwards this broad sound is gradually lost, till it entirely disappears in the most western dialect, Bhojpuri. As regards *s*, the Māgadhī Prakrit pronounced it as *ś*, like the *sh* in "shin." The Prakrits of the West preserved its dental sound, like that of the *s* in "sin." Here Bengali and Eastern Hindi exactly represent the ancient state of affairs. The former has the *ś*-sound and the latter the *s*-sound. At the present day Bihari has abandoned the practice of the old Māgadhī Prakrit in this respect, and pronounces its *s*'s as clearly as in the West. There are political reasons for this. The pronunciation of *s* is a literal shibboleth between Bengal and Upper India. For centuries Bihar has been connected politically with the West, and has in the course of generations rid itself of the typical pronunciation of the East. On the other hand, a witness as to the former pronunciation of the letter is present in the fact that, in the *Kāithi* character, *s* is always written *ś*. In the declension of nouns, Bihari follows Bengali more closely than it follows Eastern Hindi, and its conjugation is based on the same principles as those which obtain in the former language.

The age of Bihari as an independent language is unknown. We have songs written in it dating from the 15th century, and at that time it had received considerable literary culture. Bihari has three main dialects, which fall into two divisions, an eastern and a western. The eastern division includes *Maithilī* or *Tirhutī* and *Magahī*. *Magahī* is the dialect of the country corresponding to the ancient Magadha, and may therefore be taken as the modern representative of the purest Māgadhī Prakrit. Its northern boundary is generally the river Ganges, and its western the river Son. To the south it has overlapped into the northern half of Chota Nagpur. It is nearly related to *Maithilī*, but it is quite uncultivated and has no literature, although it is the vernacular of the birthplace of Buddhism. Nowadays, it is often referred to by natives of other parts of the country as the typically boorish language of India. *Maithilī* faces *Magahī* across the Ganges. It is the dialect of the old country of *Mithilā* or *Tirhut*, famous from ancient times for its learning. Historically and politically it has long been closely connected with Oudh, the home of the hero Rāma-candra, and its people are amongst the most conservative in India. Their language bears the national stamp. It has retained numerous antiquated forms, and parts of its grammar are extraordinarily complex. It has a small literature which has helped to preserve these peculiarities in full play, so that though *Magahī* shares them, it has lost many which are still extant in the everyday talk of *Mithilā*. The western division consists of the Bhojpuri dialect, spoken on both sides of the Gangetic valley, from near Patna to Benares. It has extended south-east into the southern half of Chota Nagpur, and is spoken by at least twenty millions of people who are as free from prejudice as the inhabitants of *Mithilā* are conservative. The Bhojpuris are a fighting race, and their language is a practical one, made for everyday use, as simple and straightforward as *Maithilī* and *Magahī* are complex. In fact, it might almost be classed as a separate language, had it any literature worthy of the name.

(Abbreviations: Mth. = *Maithilī*, Mg. = *Magahī*, Bh. = *Bhojpuri*, B. = *Bihari*, Bg. = *Bengali*, Skr. = *Sanskrit*, Pr. = *Prakrit*, Pr. = *Magadhī Prakrit*.)

Vocabulary.—The Bihari vocabulary calls for few remarks. *Tatsamas*, or words borrowed in modern times from Sanskrit (see **INDO-ARYAN LANGUAGES**), are few in number, while all the dialects are replete with honest home-born *labdhas*, used (unlike Bengali) both in the literary and in the colloquial language. Very few words are borrowed from Persian, Arabic or other languages.

Phonetics.—The stress-accent of Bihari follows the usual rules of modern Indo-Aryan vernaculars. In words of more than one syllable it cannot fall on the last, whether the vowel of that syllable be long or short, pronounced, half-pronounced, or not pronounced. With this exception, the accent always falls on the last long syllable. If there are no long syllables in the word, the accent is thrown back as far as possible, but never farther than the syllable before the antepenultimate. Thus, *kī-sā-n(a)* (final *a* not pronounced); *pā-nī*; *hā-mā-rā*; *dē-kī-lā-hē*. In the last word there is a secondary

accent on the penultimate, owing to the following imperfect vowel (see below). When the first syllable of a word has not the main stress-accent, it also takes a secondary one, as in *dē-kh-rī-ai-nh̄*. When the letter *a* follows a syllable which has the accent (secondary or primary) it is only half pronounced, and is here denoted by a small *a* above the line. In Mth. (but not in Mg. or Bh.) a final short *ṛ* or *ṛ* is often similarly very lightly pronounced, and is here represented by a small *ṛ* above the line. The syllable *ai* and *ai* fact "i" or "e" the preceding syllable has a secondary accent, if it has not already got the main one.

When a word ends in *a* preceded by a single uncompound consonant, the *a* is not pronounced; thus, *kisāna*, sounded *kisān*. This vowel is sometimes pronounced with a drawl, like the *a* in "ball", and is then transliterated *ā*. When *a* has this sound it can end a word, and in this position is common in the second person of verbs; thus, *dekāhā*, see thou. This sound is very frequently heard in Bhojpurī, and gives a peculiar tone to the whole dialect, which at once strikes the casual hearer. The usual short form of the letter *ā* is *a*, but when this would lead to confusion it is shortened in Mth. and Mg. to a sound like that of *a* in the German *Mann*, and is then transliterated *ā*. In Bh. it is always shortened to *a*. As an example, from *pāni*, water, is formed the word *pāniyā*, (but in Mth. and Mg.) from the word *nārab*, to strike, we have Mth. *mārāṅṅ*, Mg. *mārāṅ*, I struck, because *mārāṅ* would mean "I died." In Bh. *mārāṅ* actually has both these meanings. The letters *e* and *o* may be either long (*ē, ō*) or short (*e, o*). In Skr. the diphthongs *ai* and *au* there transliterated *ai* and *au* longer than in the Biharī and Mg. and *ai* and *au* are contractions of only *a-i* and *a-u* respectively. We may compare the Sanskrit, or *tatsama*, *ai* with the English "eye," and the *taddhava* *ai* with the English "I." In counting syllables in Biharī, *ai* and *au* count each as two syllables, not each as one long syllable. The Skr. *r* appears only in *tatsamas*. Nasalization of vowels is extremely frequent. In this article it is represented by the sign *~* over the vowel, as in *māh̄*, *mārāṅh̄*, and *dekāhāṅh̄*.

As regards consonants, *ṭ* and *ḍ*, when medial, are pronounced as strongly both *r* and *ḍ*, and are then transliterated as here shown. There is a constant tendency to change these to an ordinary dental *r* and *ḍ*; thus, *ghōḍā*, pronounced *ghōṛ* or *ghōṛ*. The semi-vowels *y* and *v* are always pronounced like *j* and *b* respectively, unless they are simply euphonic letters put in to bridge the hiatus between two concurrent vowels; thus *yāvanā* pronounced *yāvan*, and *malīyā* for *malī-ā*, *ghor-wā* for *ghor-ā*. The sibilants *ś* and *ṣ* are both pronounced as a dental *s*, but (a relic of the old Mg. Pr.) are both invariably written as a palatal *ś* in the Kaithī character. Thus, the English word *session* (*śēsan*) is written *śēsan* and pronounced *śēsan*. The cerebral *ṣ*, when un-compounded, is pronounced *ṣ*. When compounded, it generally has its proper sound. Thus, *ṣaṣṭha*, sixth, is pronounced *ṣaṣṭh*. As a general statement we may say that Biharī spelling is not fixed, and that there are often many ways of writing, and sometimes two or three ways of pronouncing, the same word.

The main typical characteristics of Mg. Pr. are that western *Pr. s* becomes *ś*, and that western *Pr. r* becomes *l*. We have seen that the change of *s* to *ś* occurs in Bengali but not in Biharī, and have given reasons for the change back to *s* in the latter language, although the Mg. Pr. *ś* is retained in writing. In both Bengali and Biharī, a western *r* is not now represented by *l*, but is represented by *r*. This deviation from the Mg. Pr. rule is only apparent, and is due to the letter *r* representing two distinct sounds. In Skr., in the western Prakrits, and in the modern western languages, *r* is a cerebral letter, with a cerebral sound. In the modern eastern languages, *r* is a dental letter, with a dental sound. Everywhere, both in old times and at the present day, *l* was and is a dental letter. The meaning, therefore, of the change of western *Pr. r* to Mg. Pr. *r* is that the western *r* lost its cerebral sound, and became a dental letter, like *l*. That dental character is preserved in the *r* of the modern eastern languages. In fact, in Biharī *r* and *l* are frequently compounded together, or with *n*, another dental letter. Thus, we have *kāṛ* or *kārī*, black; *phar* or *phal*, fruit; Skr. *rājju-*, B. *leja-rī*, a string; *Lakṣnaur*, the name of a town, quite commonly pronounced *Nakṣhaur*; and the English names Kelly and Currie both pronounced indifferently *kārī* or *kālī*. Compare Assamese *śarī* for Skr. *śarīra-*.

The genius of the Biharī language is adverse to the existence of a long vowel in a *taddhava* word, when it would occupy a position more than two syllables from the end. Thus, *ghōṛ*, but *ghōṛ-wā*; *mārā*, but *mārāṅ*. This is subject to various subsidiary rules which will be found in the grammars. The principle is a most important one, and, indeed, pervades all Indo-Aryan vernaculars of the present day, but it is carried out with the greatest thoroughness and consistency in Biharī. The whole system of declension and conjugation is subject to it. When *ā* preceding *i* or *e* is shortened, the two together become *ai*, and similarly a shortened *ā-i* or *ā-e* become *au*. The *au* position in Biharī has a stronger sense of gender than the other languages of the Eastern Group. In the modern language the distinction is in the main confined to animate beings, but in the older poetry the system of grammatical, as distinct from sexual, gender is in full swing. Except in the case of the interrogative pronoun, there is no neuter gender—words which in Skr. and Pr. were neuter being generally, but not always, treated as masculine. The plural

can everywhere be formed by the addition of some noun of multitude to the singular, and this is the universal rule in Mth., but in Mg. and Bh. it is generally made by adding *n* or (in Bh.) *nā* or *nī* to the singular, before all of which a final vowel is shortened. Thus *ghōṛ*, a horse, *ghōṛān*, horses.

As for cases, the Apabhraṃśa locative *-hi* (*-hi*) and the ablative *-ha* (see PRAKRIT) terminations have survived in poetry, probably in the Biharī, and each of them can now be used for any oblique case; but in ordinary language and in literature *-hi* and *-hi* have become contracted to *ē* and *ē*, the former of which is employed for the instrumental and the latter for the locative case. Thus, *ghar*, house; *gharē*, by a house; *gharē*, in a house. The old termination *-ha* has also survived in sporadic instances, under the form *ō*, with an ablative sense. Cases are, however, usually formed, as elsewhere, by suffixing postpositions to a general oblique case (see INDO-ARYAN LANGUAGES). The oblique case in Biharī is generally the same as the nominative, but nouns ending in *r*, *b*, *l*, or *r*, and some others, form it by adding *ā* (a relic of the old Mg. Pr. genitive in *-āha*). Thus, *mārā*, the act of striking, obl. *mārāā* (Mg. Pr. *mārī-ālāha*). Another set of verbal nouns forms the oblique case in *ai*, *e* or *i*; thus, Bh. *mār*, the act of striking, *mārē-lā*, for striking, to strike. In Mg. every noun ending in a consonant may have its oblique form in *e*; thus, *ghar*, a house, *ghar-ke* or *gharē-ke*, of a house. The *ai-* or *e-* termination is another relic of the Apabhraṃśa *-hi*, and the *ā* is a survival of the Ap. *-ha*.

The usual genitive postposition is *k*, which has become a suffix, and the forms part of the word to which it is attached, a final *ā* and preceding vowel being frequently shortened. Thus, *ghōṛ*, gen. *ghōṛk*. Other genitive postpositions are *ke*, *kar* and *kēr*. These, and all other postpositions, are still separate words, and have not yet become suffixes. The more common postpositions are: Acc. Dat. *ke*; Instr.-Abl. *sā*, *sē*; Loc. *mā*, *mē*. The genitive does not change to agree with the gender of the governing noun, as in Hindostani, but in Bh. (not in Mth. or Mg.), when the governing noun is not in the nominative singular, the genitive postposition takes the oblique form *kē*; thus, *rājū-ke mānār*, the palace of the king; but *rājū-kā mānār-ke* in the palace of the king. In Mth. and Mg. pronouns have a similar oblique genitive in *ā*. There is no case of the agent, as in Hindostani; the subject of all tenses of all verbs being always in the nominative case.

Every noun can have three forms, a short, a long and a redundant. The short form is sometimes weak and sometimes strong. Occasionally both weak and strong forms occur for the same word; thus, short weak, *ghōṛ*; short strong, *ghōṛā*; long, *ghōṛ-wā*; redundant, *ghōṛ-wā-wā*. This superfluity of forms is due to the existence of the pleonastic suffix *-ā* in the Prakrit stage of the language (see PRAKRIT). In that stage the *k* of the suffix was already *ā*, and so that we have the stages—Skr. *ghōṛa-ka-s*, Pr. *ghōṛ-a-u*, B. *ghōṛ* (by contraction) or *ghōṛ-wā* (with insertion of a euphonic *w*). The redundant form is a result of the reduplication of the suffix, which was allowed in Pr. Thus, Skr. *ghōṛa-ka-ka-s*, Pr. *ghōṛ-a-a-u*, B. *ghōṛ-wā-wā* (contracted from *ghōṛ-wā-wā-a*). The long and redundant forms are mainly used in conversation. They are familiar and often contemptuous. Sometimes they give a definite force to the word, as *ghōṛ-wā*, the horse. In the feminine they are much used to form diminutives.

As in other languages of the Eastern Group, the singulars of the personal pronouns have fallen into disuse. The plurals are used politely for the singulars, and new forms are made from these old plurals, to make new plurals. The old singulars survive in poetry and in the speech of villagers, but even here the nominative has disappeared and new nominatives have been formed from the oblique bases. All the pronouns have numerous optional forms. As a specimen of pronominal declension, we may give the most common forms of the first personal pronoun.

	Maithili.	Magahi.	Bhojpurī.
Sing. Noun.	<i>ham</i>	<i>ham</i>	<i>ham</i>
Gen.	<i>hamār</i>	<i>hamār</i>	<i>hamār</i>
Obl.	<i>hamārā</i>	<i>hamārā</i>	<i>hamārā</i>
Plur. Noun.	<i>hamārāṅ sakh</i>	<i>hamārāṅ</i>	<i>hamārāṅ-kū</i>
Gen.	<i>hamārāṅ sakhak</i>	<i>hamārāṅ-ke</i>	<i>hamārāṅ-ke</i>
Obl.	<i>hamārāṅ sakh</i>	<i>hamārāṅ</i>	<i>hamārāṅ</i>

The important point to note in the above is that the oblique form singular is formed from the genitive. It is the oblique form of that case which is also used when agreeing with another noun in an oblique case. Thus, *hamār ghar*, my house; *hamārā ghar-mē*, in my house; *hamārā-kē*, to me. In Mth. the nominative plural is also the oblique form of the genitive singular, and in Bh. and Mg. it is the oblique form of the genitive plural. In Bengali the nominative plural of nouns substantive is formed in the same way from the genitive singular (see BENGALI). The usual forms of the pronouns are *ham*, I; *tū*, thū; thou; Mth. *apnāṅ*, Bh. *raoṛ*, Your Honour; *tū*, this; *ō*, that; *he*; *ṛē*, who; *sē*; *he*; *kē*, you? Mth. *ki*, Mg.,

¹The origin of the postpositions is discussed in the article HINDOSTANI.

Bh. *hā*, what? *keo, keu*, any one; Mth. *kichh**, Mg. *kuchu*, Bh. *kachu*, anything. The oblique forms of these vary greatly, and must be learned from the grammars.

Conjugation in Maithili and Magahi.—It is in the conjugation of the verb that the amazing complexity of the Mth. and Mg. grammars appears. The conjugation of the Bhojpuri verb is quite simple, and will be treated separately. In all three dialects the verb makes little or no distinction of number, but instead there is a distinction between non-honorific and honorific forms. In Mth. and Mg. this distinction applies not only to the subject but also to the object, so that for each person there are, in the first place, four groups of forms, viz. —

- I. Subject non-honorific, object non-honorific.
- II. Subject honorific, object non-honorific.
- III. Subject non-honorific, object honorific.
- IV. Subject honorific, object honorific.

Person.	Object: non-honorific.				Object: honorific.			
	Short Form.		Long Form.		Redundant Form.		Object: honorific.	
	Group I. (Subject: non-honorific.)	Group II. (Subject: honorific.)	Group I. (Subject: non-honorific.)	Group II. (Subject: honorific.)	Group I. (Subject: non-honorific.)	Group II. (Subject: honorific.)	Group III. (Subject: non-honorific.)	Group IV. (Subject: honorific.)
1	<i>mārāi</i> or <i>mārālah</i> ^h		Or (with object in 2nd person) <i>mārāliāi</i> <i>mārāliāu</i>		Or (with object in 2nd person) <i>mārāliāik</i> <i>mārāliāuk</i>		<i>mārāliāinh</i> ⁱ	
2	<i>mārālē</i>	Same as 1st person.	<i>mārālah</i>	Same as 1st person, but no forms for object in 2nd person.	<i>mārālahāik</i>	Same as 1st person, but no forms for object in 2nd person.	<i>mārālahāinh</i> ⁱ	Same as 1st person.
3	<i>mārālak</i>	<i>mārālanh</i> ⁱ	<i>mārālahai</i> Or (with object in 2nd person) <i>mārālahau</i>	Wanting	<i>mārālahāik</i> Or (with object in 2nd person) <i>mārālahāuk</i>	Wanting	<i>mārālahāinh</i> ⁱ	<i>mārālahāinh</i> ⁱ

In Mth. all the forms in which the object is honorific end in *-nh*. Mg. closely follows this, but the forms are more abraded.

Forms in which the object is non-honorific may be, as in the case of nouns, short, long or redundant. The long forms are made by adding *ai* (or in the second person *-āh*) to the short forms, and the redundant forms by adding *ē* to the long forms. Again, if the object is in the second person, the *ai* of the long and redundant forms is changed to *au*. Finally, in the first person the non-honorific and honorific forms depending on the subject are the same, and are also identical with those forms of the second person in which the subject is honorific. We thus get the following paradigm of the Mth. past tense of the verb *mārāb*, to strike. The Mg. forms are very similar. Besides the above there are numerous optional forms. Moreover, these are only masculine forms. The feminine gender of the subject introduces new complications. It is impossible here to go into all these *minutiae*, interesting as they are to philologists. They must be learnt from the regular grammars. On the present occasion we shall confine ourselves to describing the formation of the principal parts of the verb.

In Mth. the usual verb substantive and auxiliary verb is, as in Bengali, based on the root *ach* (Skr. *rechati*), the initial vowel being generally dropped, as in *chī*, I am; *chalah**, I was; but *ach*,ⁱ he is. In Mg. we have *hī* or *hiki*, I am; *halū*, I was. The finite verb has three verbal nouns or infinitives, viz. (from the root *mār*, strike), Mth. *mārā* or Mg. *mār*; *mārāb*; and *mārāl*. All three are fully declined as nouns, the oblique forms being *mārāi* or *mārē*, *mārābē*, and *mārālē*, respectively. There are two participles, a present (Mth. *mārāi* = Pr. *mārentu*) and a past (Mth. *mārāl* = Pr. *mārālāu*). The Mg. forms are very similar. The old Mg. Pr. present and imperative have survived, but all other tenses were made from verbal nouns or participles. The past tense (of which the conjugation for a Maithili transitive verb is given above) is formed by adding pronominal suffixes to the past participle. Thus, *mārāl* + *i*, struck + by-me, becomes *mārāli*, I struck. In the case of intransitive verbs, the suffixes may represent the nominative and not the instrumental case of the pronoun, and hence the conjugation is somewhat different. The future is a mixed tense. Generally speaking, the first two persons are formed from the verbal noun in *b*, which is by origin a future passive participle, and the third person is formed from the present participle. Thus, *mārāb* + *ah**, about-to-be struck + by-me, becomes *mārābāh*, I shall strike, and *mārāi* + *ah**, striking + be-i, becomes *mārāihā*, he will strike (compare the English "he is also going" for "he is on the point of going"). A past conditional is also formed by adding similar suffixes to the present participle, as in *mārāliāh*, (if) I had struck. This use of the present participle already existed in the Pr. age (cf. Héma-candra's *Grammar*, iii. 180). In Mth. the present definite and the imperfect are formed by conjugating the present or past tense respectively of the auxiliary verb with the present participle; thus *mārāi chī*, I am striking. Mg. (like vulgar

English) substitutes the oblique form of the verbal noun for the present participle, as in *mārē hī*, I am striking. The perfect is usually formed by adding the word for "is" to the past; thus, Mth. *mārāli āch*, I have struck, lit. struck-by-me it-is. A pluperfect is similarly formed with the past tense of the auxiliary verb.

There are numerous irregular verbs. Most of the irregularities are due to the root ending in a vowel or in a weak consonant such as *b* (= Pr. *v*). Thus, root *pāb*, obtain, past participle *pāol*, first singular, past tense, *pāul*. More definitely irregular are a few roots like *hār*, do, past participle *kāi*. These last instances are cases in which the past participle is independently derived from a Skr. past participle, and is not formed as usual by adding the pleonastic suffix *-ai* or *-i* (Skr., Pr., *-alla*, *-illa*, see PRAKRTI to the Bihari root. Thus, Skr. *kṛta-s*, Pr. *kāa-u*, *ka-il-u*, B. *kāi*, instead of *kar-ol*).

There is a long series of transitive verbs formed from intransitives and of causal verbs formed from transitives, generally by adding

āb (Skr. *āpaya*, Pr. *āvē*). Compound verbs are numerous. Noteworthy is the desiderative compound formed by adding the root *cāh*, wish, to the dative of a verbal noun. Thus, *ham dēkhā-kē cāhāi-chī*, I am wishing for the seeing, I wish to see.

Conjugation in Bhojpuri.—The Bh. conjugation is as simple as that of Mth. and Mg. is complex. In the first and second persons the plural is generally employed for the singular, but there is no change in the verb corresponding to the person or honour of the object. The usual verb substantive and auxiliary verb is derived in the present from the root *bāṭ* or *bār*, be, as in *bāṭē* or *bāṭē* (Skr. *varāte*, Pr. *vattai*), he is. The past is derived from the root *rah* (Skr. *rahati*, Pr. *rahai*), as in *rahāl* or (contracted) *rahī*, I was. The verbal nouns and participles are nearly the same as in Mth.-Mg., the first verbal noun and the present participle being *mār* and *mārāl*, as in Mg. The old present and imperative, derived from the Mg. Pr. forms, are also employed in Bh. Thus, *mārē* (Pr. *mārēi*), he strikes. This tense is often used as a present conditional. When it is wished to emphasize the sense of a present indicative, the syllable *-lā* is suffixed. The same suffix is employed in Rajasthanī, Naipālī and Marathī to form the future, and in Bh. it is often also used with a future sense. The past tense is formed, as in Mth.-Mg., by adding pronominal suffixes to the past participle; thus, *mārālē* (*mārā* + *lē*) I struck, as explained above. Similarly, for the first and second persons of the future we have *mārālē*, I shall strike, and so on, but the third person is *mārē* (Pr. *mārēhi*), he will strike, *mārēhen* (Pr. *mārēhinī*), they will strike. The periphrastic tenses are formed on the same principles as in Mth. As an example of Bh. conjugation we give the present, past and future tenses in all persons. There are a few additional optional forms, but nothing like the multiplicity of meanings which we find in Mth. and Mg.

	Present.	Past.	Future.
Sing. 1	Not used	Not used	Not used
2	<i>mārē-lē</i>	<i>mārālās</i>	<i>mārābē</i>
3	<i>mārē-lē</i>	<i>mārālē</i>	<i>mārē</i>
Plur. 1	<i>mārē-lā</i>	<i>mārālī</i>	<i>mārābē</i>
2	<i>mārē-lā</i>	<i>mārālī</i>	<i>mārābē</i>
3	<i>mārē-lē</i>	<i>mārālēn</i>	<i>mārēhen</i>

It will be observed that the termination of the present changes in sympathy with the old present to which it is attached. In some parts of the Bh. area, especially in the district of Sāran, *u* is substituted for *ī* in the past. Thus, *mārāl*, I struck. The *mārū-* is merely the past participle without the pleonastic termination *-alla* which is used in Bihari, as explained under the Mth.-Mg. conjugation.

Irregular verbs, the formation of transitive and causal verbs, and the treatment of compound verbs, are on the same lines as in Mth.

Bihārī Literature.—In all three dialects there are numerous folk-epics transmitted by word of mouth. Several have been published at various times in the *Journal of the Asiatic Literature*.

Literature. Society of Bengal and in the *Zeitschrift der deutschen morgenländischen Gesellschaft*. The only dialect which has any real literature is Maithili. The earliest writer of whom we have any record is Vidyapati Ṭhakkura (Bidyāpati Ṭhakur), who lived at the court of Rājā Śiva Śimha of Sugaonā in Tirhut in the 15th century. He was a voluminous Sanskrit writer, but his fame rests chiefly on his dainty lyrics in Maithili dealing with the loves of Rādhā and Krishna. These have exercised an important influence on the religious history of eastern India. They were adopted and enthusiastically recited by the reformer Caitanya (16th century), and through him became the home-poetry of the Bengali-speaking Lower Provinces. Their language was transformed (we can hardly say translated) into Bengali, and in that shape they have had numerous imitators. A collection of poems by the old Master-singer in their Maithili dress has been published by the present writer in his *Chrestomathy* of that language. The most admired of Vidyāpati's successors is Manbōdh Jhā, who died in 1788. He composed a *Haribans*, or poetical life of Krishna, which has great popularity. Many dramas have been composed in Mithila. The fashion is to write the body of the work in Sanskrit and Prakrit, but the songs in Maithili. Two dramas, the *Parijāta-haraṇa* and the *Rukmīṇī-pariṇaya*, are attributed to Vidyāpati. Among modern writers in the dialect, we may mention Harṣanātha, an elegant lyric poet and author of a drama entitled *Uṣā-haraṇa*, and Candra Jhā, whose version of the *Rāmāyana* and translation of Vidyāpati's Sanskrit *Purusa-parīkṣā* are deservedly popular.

AUTHORITIES.—The *Linguistic Survey of India*, vol. v. part ii. (Calcutta, 1903), gives a complete conspectus of Bihārī in all its dialects and sub-dialects. See also G. A. Grierson, *Seven Grammars of the Dialects and Sub-dialects of the Bihārī Language*, parts i. to viii. (Calcutta, 1883-1887)—these deal with every form of Bihārī except standard Maithili; and S. H. Kellogg, *A Grammar of the Hindi Language, in which are treated High Hindi* . . . also the *Colloquial Dialects of* . . . *Bhojpur, Magadhā, Maithilā, &c.* (2nd ed., London, 1893).

For Maithili, see G. A. Grierson, *An Introduction to the Maithilī Language of North Bihār, containing a Grammar, Chrestomathy and Vocabulary*; part i. *Grammar* (Calcutta, 1881; 2nd ed., 1909); part ii. *Chrestomathy and Vocabulary* (Calcutta, 1882). For Vidyāpati Ṭhakura, see J. Beames, "The Early Vaishnava Poets of Bengal," in *Indian Antiquary*, ii. (1873), pp. 37 ff.; the same, "On the Age and Country of Vidyāpati," *ibid.* iv. (1875), pp. 299 ff.; anon. article in the *Banga Darśana*, vol. iv. (1282 B.S.), pp. 75 ff.; Śāradācāra Maitra, *Introduction to Vidyāpatir Padāvālī* (2nd ed., Calcutta, 1285 B.S.); G. A. Grierson, *Chrestomathy*, as above; "Vidyāpati and his Contemporaries," *Indian Antiquary*, vol. xiv. (1885), pp. 182 ff.; "On some Mediaeval Kings of Mithilā," *ibid.* vol. xxvii. (1899), pp. 57 ff.

For Bhojpur, see J. Beames, "Notes on the Bhojpur Dialect of Hindi spoken in Western Bihār," in *Journal of the Royal Asiatic Society*, vol. iii. N.S., 1868, pp. 483 ff.; A. F. R. Hoernle, *A Grammar of the Eastern Hindi compared with the other Gauḍian Languages* (here "Eastern Hindi" means "Western Bhojpur"), (London, 1880); J. R. Reid, *Report on the Settlement Operations in the District of Azamgarh* (Allahabad, 1881)—contains in appendices full grammar and vocabulary of Western Bhojpur.

No special works have been written about Magahī. (G. A. GR.)

BIHĀRĪ-LĀL, a name famous in Hīndustāni literature as the author of the *Sat-saī*, a collection of approximately seven hundred distichs, which is perhaps the most celebrated Hindi work of poetic art, as distinguished from narrative and simpler styles. The language is the form of Hindi called *Braj-bhāṣā*, spoken in the country about Mathura, where the poet lived. The couplets are inspired by the Krishna side of Vishnu-worship, and the majority of them take the shape of amorous utterances of Rādhā, the chief of the Gopīs or cowherd maidens of Braj, and her divine lover, the son of Vasudēva. Each couplet is independent and complete in itself, and is a triumph of skill in compression of language, felicity of description and rhetorical artifice. The distichs, in their collected form, are arranged, not in any sequence of narrative or dialogue, but according to the technical classification of the sentiments which they convey as set forth in the treatises on Indian rhetoric.

Little is known of the author beyond what he himself tells us. He was born in Gwālior, spent his boyhood in Bundēlkhand,

and on his marriage settled in his father-in-law's household in Mathurā. His father was named Kēṣab Rāy; he was a twice-born (*Dvija*) by caste, which is generally understood to mean that he was a Brāhman, though some assert that he belonged to the mixed caste, now called Rāy, sprung from the offspring of a Brāhman father by a Kshatriya mother. A couplet in the *Sat-saī* states that it was completed in A.D. 1662. It is certain that his patron, whom he calls Jai Shāh, was the Rājā of Amber or Jaipur, known as Mirzā Jai Singh, who ruled from 1617 to 1667 during the reigns of the emperors Jahāngir, Shāh Jahān and Aurangzēb. A couplet (No. 705) appears to refer to an event which occurred in 1665, and in which Rājā Jai Singh was concerned. For this prince the couplets were composed, and for each *dōhā* the poet is said to have received a gold piece worth sixteen rupees.

The collection very soon became celebrated. As the couplets are independent one of another, and were put together fortuitously as composed, many different recensions exist; but the standard is that settled by an assembly of poets under the direction of Prince A'zam Shāh, the third son of the emperor Aurangzēb (1653-1707), and hence called the A'zam-shāhī; it comprises 726 couplets. The estimation in which the work is held may be measured by the number of commentators who have devoted themselves to its elucidation, of whom Dr Grierson mentions seventeen. Two of them were Musalmān, and two other commentaries were composed for Musalmān patrons. The collection has also twice been translated into Sanskrit.

The best-known commentary is that of Lallū-jī-Lāl, entitled the *Lālā-chandrikā*. The author was employed by Dr Gilchrist in the College of Fort William, where he finished his commentary in 1818. A critical edition of it has been published by Dr G. A. Grierson (Calcutta, government of India Press, 1896). (C. J. L.)

BIJAPUR, an ancient city and modern district of British India in the southern division of Bombay. It is a station on the Southern Mahratta railway, 60 m. S. of Sholapur. The ancient city was supplied with water by an elaborate underground system of reservoirs and aqueducts, which has been restored in part as a famine relief work. The population in 1901 was 23,811. The city used to be the extensive, splendid and opulent capital of an independent sovereignty of the same name, but now retains only the vestiges of its former grandeur. It is still, however, the most picturesque collection of ruins in India. The city of Bijapur owed its greatness to Yusuf Adil Shah, the founder of the independent state of Bijapur. It consists of three distinct portions—the citadel, the fort and the remains of the city. The citadel, built by Yusuf Adil Shah, a mile in circuit, is of great strength, well built of the most massive materials, and encompassed by a ditch 100 yds. wide, formerly supplied with water, but now nearly filled up with rubbish, so that its original depth cannot be discovered. Within the citadel are the remains of Hindu temples, which prove that Bijapur was an important town in pre-Mahomedan times. The fort, which was completed by Ali Adil Shah in 1566, is surrounded by a wall 6 m. in circumference. This wall is from 30 to 50 ft. high, and is strengthened with ninety-six massive bastions of various designs. In addition there are ten others at the various gateways. The width is about 25 ft.; from bastion to bastion runs a battlemented curtain wall about 10 ft. high. The whole is surrounded by a deep moat 30 to 40 ft. broad. Inside these walls the Bijapur kings bade defiance to all comers. Outside the walls are the remains of a vast city, now for the most part in ruins, but the innumerable tombs, mosques, caravanserais and other edifices, which have resisted the havoc of time, afford abundant evidence of the ancient splendour of the place. Among its many buildings three are specially worthy of mention. The Gol Gumbaz, or tomb of Sultan Mahomed Adil Shah, which was built 1626-1656, is one of the most interesting buildings in the world. It is a square building, 135 ft. each way, which is surmounted by a great circular dome 108 ft. high. The inside area (18,360 ft.) is greater than the Pantheon at Rome (15,833 sq. ft.). When first built the dome was covered by gold leaf, and the outer walls were adorned with stucco work picked out in gold and blue, but to-day there are very few traces of this

ornamentation. Of late years this mosque has been thoroughly restored, and one portion is now used as a museum in which all objects of interest discovered in the surrounding country are exhibited. Next to this comes the Ibrahim Roza, or tomb and mosque of Ibrahim Adil Shah II., which was completed about 1620 and is supposed to be one of the most exquisite buildings in the world after the Taj at Agra. It is said to have cost £1,700,000 and to have occupied thirty-six years in its construction. The Gagan Mahal, or ancient audience hall, is now a mass of ruins, but when complete must have been a beautiful building. The archway remains. It is over 60 ft. span and about 90 ft. high. Through this arch Sikandar Adil Shah, the last king of Bijapur, was brought bound with silver chains, while on a raised platform sat Aurangzeb, the Mogul emperor, who had left Delhi three years previously to conquer the Deccan. This magnificent palace, where so many scenes historic in the Bijapur dynasty occurred, is now the abode of hundreds of pigeons. Their cooing is the only sound that breaks the silence of the old halls.

History.—The founder of the Bijapur dynasty, Yusuf Adil Shah, is said by Ferishta to have been a son of the Ottoman sultan Murad II. When on his accession Mahommed II. gave orders for the strangling of all his brothers, Yusuf was saved by a stratagem of his mother. He went to India, where he took service under the Bahmani king of the Deccan, and ultimately became a person of great importance at the court of Mahmud II. In 1489 he took advantage of the break-up of the Bahmani power to establish himself as an independent sultan at Bijapur, his dominions including Goa on the west coast. He died in 1511 (Goa had been taken by the Portuguese a few months before), and was succeeded by his son Ismail, who reigned prosperously till 1534. The next king worth mentioning is Ali Adil Shah I., who reigned from 1557 to 1579 and, besides the fort, built the Jama Masjid or great mosque, the aqueducts and other notable works in the city. His son Ibrahim (d. 1626) maintained the prosperity of the state; but under his successor, Mahommed Adil Shah (d. 1656), the rise of the Mahratta power under Sivaji began to make inroads upon it, and it was exposed to the yet more formidable ambition of Shah Jahan. On the death of Mahommed the succession passed to Ali Adil Shah II., and on his death in 1672 to his infant son, Sikandar Adil Shah, the last of the race. The kingdom had been for some time rapidly falling to ruin, and in 1686 the Mogul emperor Aurangzeb, who as Shah Jahan's general had unsuccessfully besieged the city under Mahommed Adil Shah, took Bijapur and annexed the kingdom to the Delhi empire. Among the curiosities of the capital is the celebrated monster gun (Malik-i-Maidan), stated to be the largest piece of cast bronze ordnance in the world. It was captured from the king of Ahmednagar by the king of Bijapur about the middle of the 17th century. An inscription on the gun recording that fact was erased by Aurangzeb, who substituted the present inscription stating that he conquered Bijapur in 1686. The city and territory of Bijapur remained annexed to Delhi till 1724, when the nizam established his independence in the Deccan, and included Bijapur within his dominions. His sway over this portion of his acquisitions, however, was of brief duration; for, being defeated by the Peshwa in 1760, he was compelled to purchase peace by its cession to the Mahrattas. Upon the fall of the Peshwa in 1818 Bijapur passed into the hands of the British, and was by them included in the territory assigned to the raja of Satara. In 1848 the territory of Satara was escheated through the failure of heirs. The city was made the administrative headquarters of the district in 1885.

The district of Bijapur, formerly called Kaladgi, occupies a barren plain, sloping eastward from a string of feudatory Mahratta states to the nizam's dominions. It contains an area of 5666 sq. m., and its population in 1901 was 735,435, showing a decrease of 8% compared with an increase of 27% in the preceding decade, and a decrease of 21% in the period between 1872 and 1881. These changes in population reveal the effects of famine, which was very severely felt in 1876-1878 and again in 1899-1900. There is very little irrigation in the district.

The principal crops are millet, wheat, pulse, oil-seeds and cotton. There are considerable manufactures of cotton and silk goods and blankets, and several factories for ginning and pressing cotton. The East Deccan line of the Southern Mahratta railway traverses the district from north to south.

BIJAWAR, a native state of central India, in the Bundelkhand agency. Area, 973 sq. m.; pop. (1901) 110,500; revenue, £10,000. Forests cover nearly half the total area of the state, which is believed to be rich in minerals, but lack of transport facilities has hindered the development of its resources.

The state takes its name from the chief town, Bijawar (pop. in 1901, 5200), which was founded by Bijai Singh, one of the Gond chiefs of Garha Mandla, in the 17th century. It was conquered in the 18th century by Chhatarsal, the founder of Panna, a Rajput of the Bundela clan, by whose descendants it is still held. It was confirmed to Ratan Singh in 1811 by the British government for the usual deed of allegiance. In 1857 Bhan Pratap Singh rendered signal services to the British during the Mutiny, being rewarded with certain privileges and a hereditary salute of eleven guns. In 1866 he received the title of maharaja, and the prefix *sawai* in 1877. Bhan Pratap was succeeded on his death in 1899 by his adopted son, Sanwant Singh, a son of the maharaja of Orchha.

BIJNOR, or BIJNAUR, a town and district of British India in the Bareilly division of the United Provinces. The town is about 3 m. from the left bank of the Ganges. The population in 1901 was 17,583. There is a large trade in sugar. The American Methodists have a mission, which maintains some aided schools, and there is an English high school for boys.

The DISTRICT OF BIJNOR has an area of 1791 sq. m. The aspect of the country is generally a level plain, but the northern part of it rises towards the Himalayas, the greatest elevation being 1342 ft. above the sea-level. The Koh and Ramganga are the principal rivers that flow through the district, and the Ganges forms its western boundary. In 1901 the population was 770,451, showing a decrease of 2% in the decade. The country is watered in most parts by streams from the hills, but a series of small canals has been constructed. Sugar is largely exported. A line of the Oudh & Rohilkhand railway from Moradabad to Saharanpur runs through the district.

History.—Of the early history of Bijnor even after it passed under Mahomedan rule little is known with any certainty. The district was ravaged by Timur in 1399, and thenceforward nothing is heard of it till the time of Akbar, when it formed part of the Delhi empire and so continued undisturbed, save for occasional raids, so long as the power of the Moguls survived intact. In the early part of the 18th century, however, the Rohilla Pathans established their independence in the country called by them Rohilkhand; and about 1748 the Rohilla chief Ali Mahommed made his first annexations in Bijnor, the rest of which soon fell under the Rohilla domination. The northern districts were granted by Ali Mahommed to Najib Khan, who gradually extended his influence west of the Ganges and at Delhi, receiving the title of Najib-ud-daula and becoming paymaster of the royal forces. His success, however, raised up powerful enemies against him, and at their instigation the Mahrattas invaded Bijnor. This was the beginning of a feud which continued for years. Najib, indeed, held his own, and for the part played by him in the victory of Panipat was made vazier of the empire. After his death in 1770, however, his son Zabita Khan was defeated by the Mahrattas, who overran all Rohilkhand. In 1772 the nawab of Oudh made a treaty with the Rohillas, covenanting to expel the Mahrattas in return for a money payment. He carried out his part of the bargain; but the Rohilla chieftains refused to pay. In 1774 the nawab concluded with the government of Calcutta a treaty of alliance, and he now called upon the British, in accordance with its terms, to supply a brigade to assist him in enforcing his claims against the Rohillas. This was done; the Rohillas were driven beyond the Ganges, and Bijnor was incorporated in the territories of the nawab, who in 1801 ceded it to the East India Company. From this time the history of Bijnor is uneventful, until the Mutiny of 1857, when

(on the 1st of June) it was occupied by the nawab of Najibabad, a grandson of Zabita Khan. In spite of fighting between the Hindus and the Mohammedan Pathans the nawab succeeded in maintaining his position until the 21st of April 1858, when he was defeated by the British at Nagina; whereupon British authority was restored.

BIKANIR, a native state of India, in the Rajputana agency, with an area of 23,311 sq. m. The natural aspect of the country is one desolate tract, without a single permanently running stream. Its surface is overspread with undulating sand-hills, of from 20 to 100 ft. above the average level, and so loose that men and quadrupeds stepping off the beaten track sink as if in snow. Two streams, the Katli and Ghaggar, attempt to flow through this dismal region, but are lost in its sands. Water is very scarce, and is raised from wells of from 250 to 340 ft. in depth. A few shallow salt lakes are filled by rain water, but they dry up on the setting in of the hot weather, leaving a thick crust of salt on their beds, which is used for commercial and domestic purposes. The inhabitants are very poor. They live chiefly by pasturage—rearing camels, of which their chief agricultural stock consists, and horses of a fine breed, which fetch good prices. From the wool which their sheep yield they manufacture every article of native dress and good blankets. The other industries are leather work, sugar-refining, goldsmith's work, ivory carving, iron, brass, copper, stone masonry, tanning, weaving, dyeing and carpentry. The principal towns are Bikanir, the capital, Churu, Rajgarh, Ratangarh and Reni. In 1901 the population was 584,627, showing a decrease of 30% due to the results of famine. The revenue is £141,000. The military force consists of 500 men, besides the Imperial Service Corps of the same strength. The schools include a high school affiliated to the university of Allahabad, a school for the sons of nobles, and a girls' school called after Lady Elgin. The railway from Jodhpur has been extended towards Bhatinda in the Punjab; on the northern border, the Ghaggar canal in the Punjab irrigates about 5000 acres. Drought is of common occurrence. The famine of 1890-1900 was severely felt. The city of Bikanir has a railway station. The city is surrounded by a stone wall, 6 ft. thick, 15 to 30 ft. high and $\frac{3}{2}$ m. in circuit, with five gates and three sally-ports. The citadel is half a mile north-east of the city, and is surrounded by a rampart with bastions. The population in 1901 was 53,075. There are manufactures of fine blankets and sugar-candy.

History.—In the 15th century the territory which now forms the state of Bikanir was occupied by Rajput clans, partly Jats, partly Mahomedans. About 1465 Bika, a Rathor Rajput, sixth son of Rao Jodha, chief of Marwar, started out to conquer the country. By taking advantage of the rivalries of the clans he succeeded; in 1485 he built the small fort at the capital which still bears his name, and in 1488 began the building of the city itself. He died in 1504, and his successors gradually extended their possessions. In the reign of Akbar the chiefs of Bikanir were esteemed among the most loyal adherents of the Delhi empire, and in 1570 Akbar married a daughter of Kalyan Singh. Kalyan's son, Rai Singh, who succeeded him in 1571, was one of Akbar's most distinguished generals and the first raja of Bikanir; his daughter married Selim, afterwards the emperor Jahangir. Two other distinguished chiefs of the house were Karan Singh (1631-1669), who in the struggle of the sons of Shah Jahan for the throne threw in his lot with Aurangzeb, and his eldest son, Anup Singh (1669-1698), who fought with distinction in the Deccan, was conspicuous in the capture of Golconda, and earned the title of maharaja. From this time forward the history of Bikanir was mainly that of the wars with Jodhpur, which raged intermittently throughout the 18th century. In 1802, during one of these wars, Elphinstone passed through Bikanir on his way to Kabul; and the maharaja, Surat Singh (1788-1828), applied to him for British protection, which was, however, refused. In 1815 Surat Singh's tyranny led to a general rising of his *thakurs*, and in 1816 the maharaja again applied for British protection. On the 9th of May 1818 a treaty was concluded, and order was restored in the country by British

troops. Ratan Singh, who succeeded his father in 1828, applied in vain in 1830 to the British government for aid against a fresh outbreak of his *thakurs*; but during the next five years dacoity became so rife on the borders that the government raised a special force to deal with it (the Shakhawati Brigade), and of this for seven years Bikanir contributed part of the cost. Henceforth the relations of the maharajas with the British government were increasingly cordial. In 1842 Ratan Singh supplied camels for the Afghan expedition; in 1844 he reduced the dues on goods passing through his country, and he gave assistance in both Sikh campaigns. His son, Sardar Singh (1851-1872), was rewarded for help given during the Mutiny by an increase of territory. In 1868 a rising of the *thakurs* against his extortions led to the despatch of a British political officer, by whom affairs were adjusted. Sardar Singh had no son, and on his death in 1872 his widow and principal ministers selected Dugar Singh as his successor, with the approval of the British government. The principal event of his reign was the rebellion of the *thakurs* in 1883, owing to an attempt to increase the dues payable in lieu of military service; this led to the permanent location at Bikanir of a British political agent. Dugar Singh died in 1887 without a son; but he had adopted his brother, Ganga Singh (b. 1880), who succeeded as 21st chief of Bikanir with the approval of the government. He was educated at the Mayo College at Ajmere, and was invested with full powers in 1898. He attended King Edward's coronation in 1902, and accompanied the British army in person in the Chinese campaign of 1901 in command of the Bikanir Camel Corps, which also did good service in Somaliland in 1904. The state owes to this ruler the opening up of new railways across the great desert, which was formerly passable only by camels, and the tapping of the valuable coal deposits that occur in the territory. For his conspicuous services he was given the Kaiser-i-Hind medal of the first class, made an honorary major in the Indian army, a G.C.I.E., a K.C.S.I., and A.D.C. to the prince of Wales.

BILASPUR, a town and district of British India in the Chhattisgarh division of the Central Provinces. The town is situated on the right bank of the river Arpa. It is said to have been founded by a fisherman named Bilasa in the 17th century, and it still retains her name. The place, however, came into note only after 1741, the year of the Marhatta invasion (see below), when a Marhatta official took up his abode there and began to build a fort which was never completed. In 1862 it was made the headquarters of the district. The population in 1901 was 18,937. It is an important junction on the Bengal-Nagpur railway, where the two lines from the west meet on their way to Calcutta, 255 m. from Nagpur.

The DISTRICT OF BILASPUR has an area of 7602 sq. m. It forms the upper half of the basin of the river Mahanadi. It is almost enclosed on the north, west and east by ranges of hills, while its southern boundary is generally open and accessible, well cultivated, and closely dotted with villages embedded in groups of fruit trees. The principal hills are—(1) the Maikal range, situated in the north-western extremity of the district; (2) a chain of hills forming part of the Vindhyan range, on the north; (3) the Korba hills, an off-shoot of the Vindhyan, on the eastern boundary; and (4) the Sonakhan block of hills, in the vicinity of the Mahanadi river. The Mahanadi is the principal river of the district, and governs the whole drainage and river system of the surrounding country. It takes its rise in a mountainous region which is described as the wildest of all wild parts of the Central Provinces, crosses the Bilaspur boundary near Seorinarain, and after a course of 25 m. in the south-eastern extremity of the district enters Sambalpur district. Within Bilaspur the river is everywhere navigable for six months in the year. Minor rivers are the Sakri, Hamp, Tesua, Agar, Maniari, Arpa, Kharod, Lilagar, Jonk and Barpi. The most important affluents of the Mahanadi are the Seonath and Hasdu. Besides the natural water supply afforded by the rivers, Bilaspur abounds in tanks. There are large forest areas, those belonging to the government covering over 600 sq. m. Sal (*Shorea robusta*) is the chief timber tree.

Bilaspur, which was formerly a very isolated tract, is now traversed in three directions by lines of the Bengal-Nagpur railway. It suffered severely from the famine of 1866-1867. In 1807 the general death-rate was as high as 90 per thousand, rising to 207 in Bilaspur town. It suffered no less severely in 1900, when in May the number of persons relieved rose to one-fourth of the total population.

In 1901 the population was 1,012,972, showing a decrease of 13 %, compared with an increase of 14 % in the preceding decade. In 1906, however, the new district of Drug was formed, which took away 730 sq. m. from Bilaspur; the population on this reduced area of Bilaspur in 1901 was 917,240.

Among the Hindu inhabitants of the district, the Chamars and Pankas deserve particular notice. The former, who form the shoemaker and leather-dealing caste of the Hindu community, had always been held in utter contempt by the other Hindu castes. But between 1820 and 1830 a religious movement, having for its object their freedom from the trammels of caste, was inaugurated by a member of the caste, named Ghasi Das, who preached the unity of God and the equality of men. Ghasi Das gave himself out as a messenger of God; he prohibited the adoration of idols, and enjoined the worship of the Supreme Being without any visible sign or representation. The followers of the new faith call themselves *Satnamis*, or the worshippers of *Satnam* or God. They do not keep the Hindu festivals and they defy the contempt of the Brahmans. Ghasi Das, the founder of the faith, was their first high priest. He died in 1830; his son succeeded him, but was assassinated (it was said by the Hindus), and the grandson succeeded him. The Pankas, who form about a sixth of the population, are all Kabirpanthis, or followers of Kabir, a religious reformer of the 15th century. There is no great difference between the Kabir Pankas and the *Satnamis*. They both abstain from meat and liquor, marry at the age of puberty, ordinarily celebrate their ceremonies through the agency of the elders of their own caste and bury their dead. The Pankas worship the Supreme Being under the name of *Kabir*, and the Chamars under the name of *Satnam*; while each community has a high priest to whom reverence is paid. At present the majority of the Pankas are cultivators, though formerly all were weavers. The Gonds are the most numerous among the aboriginal tribes, but so great an intermixture has taken place between them and the Hindu races that they have lost their language and most of their ethnical characteristics, such as the flat forehead, squat nose, prominent nostril, dark skin, &c., and are scarcely distinguishable from the other classes of the Hindu labouring population. In addition to some of the Hindu deities which they worship, the Gonds have their own gods—*Bara Deva* and *Dula Deva*. The *Kanwars* are the next largest section of the aboriginal population. The upper class among them claim to be Rajputs, and are divided into numerous septs. Although an aboriginal tribe, the census returns them as a Hindu caste. All the northern landholders of Bilaspur belong to this tribe, which consequently occupies an influential position.

The chief wealth of the district consists in its agricultural produce. Rice, wheat, pulses, millet, mustard, oil-seeds and cotton are the chief crops. Rice, the chief export, is sent to Bombay, Berar and northern India. The tussur silk industry is of considerable importance, and the silk is reputed the best in the Central Provinces. Sal and other timber is exported. Lac is sent in large quantities to Calcutta and Mirzapur. Coal and iron are the chief minerals; sandstone for building purposes is quarried near Bilaspur and Seorinarain. Among local industries the most important is the weaving trade.

The early history of the district is very obscure. From remote ages it was governed by kings of the Haihai dynasty of Ratanpur and Raipur, known as the Chhattisgarh rajyas, on account of thirty-six forts (*garhs*), of which they were the lords. A genealogical list of kings of this dynasty was carefully kept up to the fifty-fifth representative in the year 1741, when the country was seized without a struggle by the Maharrattas of Nagpur. From 1818 to 1830 Bilaspur came under the management of the British

government, the Maharratta chief of Nagpur being then a minor. In 1854 the country finally lapsed to the British government, the chief having died without issue. During the Sepoy mutiny a hill chief of the district gave some trouble, but he was speedily captured and executed.

BILBAO, formerly sometimes written **BILBOA**, the capital of the Province of Biscay, in northern Spain; in 43° 15' N. and 2° 45' W.; on the river Nervion on Ansa (in Basque *Ibaibabal*), and about 8 m. inland from the Bay of Biscay. Pop. (1900) 83,306. Bilbao is one of the principal seaports of Spain, and the greatest of Basque towns. It occupies a small but fertile and beautiful valley, shut in by mountains on every side except towards the sea, and containing the fortified haven of Portugalete, the industrial town of Baracaldo (*q.v.*), and the villages of Santurce and Las Arenas, where the Nervion broadens to form the Bay of Bilbao at its mouth. Bilbao comprises two distinct parts, ancient and modern. The new town lies on the left bank, while the old town rises on the right in terraces. Communication across the river is afforded by five bridges, of which the oldest, San Antonio, is of stone, and dates from the 14th century. The houses in the principal streets are built of hewn stone, and are several storeys high, with projecting eaves that give shelter from both sun and rain. Many of the streets in the old town are very narrow, and have an appearance of cleanliness and quiet. For a long time no carts or carriages were permitted to enter the city for fear of polluting and injuring the pavement, and the transport of goods was carried on in hand-carts. But after 1876 entirely new districts were mapped out on the left bank of the Nervion. Fine broad streets, splendid squares and public gardens, hotels, villas, palatial new public buildings and numerous schools came into existence. The part of the town on the right bank is, however, still the great centre of business, the narrow streets containing the best shops. There, too, are the banks, the town hall, the theatre, the principal clubs, and the principal churches, including that of Santiago, which dates from the 14th century. In and around Bilbao there are more than thirty convents and monasteries, and at Olaveaga, about a mile off, is the Jesuit university, attended by 850 students. Public education is not, however, entirely in the hands of the priesthood and nuns; there are an institute, a normal school to train teachers, a school of arts and handicrafts, a nautical school and numerous public primary schools for both sexes.

Few Spanish cities grew so rapidly in size, importance and wealth as Bilbao in the latter half of the 19th century. Its first bank was founded in 1857; its first railway (Bilbao-Tudela) opened in 1863. Thenceforward, despite the check it received from the Carlist rebellion of 1870-1876, and the contemporaneous decline of its wool and shipbuilding industries, its prosperity increased steadily. The population, 17,649 in 1870, rose to 50,734 in 1887, 74,076 in 1897, and 83,306 in 1900. This development was due principally to the growth of the mining and metallurgical industries. From a very early period, as the Old English word *bilbo*, "a sword," attests, Bilbao was celebrated for the excellent quality of its steel blades; in modern times it was the natural headquarters of the important steel and iron trades of the Basque Provinces. Hence it became the centre of a network of railway lines unsurpassed in Spain. The harbour works bar, constituted in 1877, improved the river channel and the bar; made wharves and embankments; lighted the lower reaches of the river by electricity, so as to allow vessels to enter by night; and constructed a breakwater and counter-mole outside the bar of the river Nervion, between Santurce, Portugalete and the opposite headland at the village of Algorta, so as to secure deep anchorage and easy access to the river. The first dry dock was constructed in 1896; in 1905 it was supplemented by another, the largest in Spain. The exports are chiefly iron; the imports coal; large quantities of wine from Navarre and the Ebro valley are also sent abroad, and the importation of timber of all kinds from Scandinavia and Finland, and coastwise from Asturias, is of great importance. In the coasting trade the exports are mostly pig-iron, codfish and some products of local industries and agriculture. The shipping

at Bilbao is mainly Spanish, owing to the multitude of small vessels employed in the coasting trade; but from 1880 onwards the majority of foreign ships were British. In 1904, 3319 vessels of 2,267,957 tons were accommodated at Bilbao; more than 2000 were Spanish and nearly 700 British. In the same year new harbour works and lighting arrangements were undertaken on a large scale, and a movement was initiated for the revival of shipbuilding. Besides the mining and metallurgical industries, Bilbao has breweries, tanneries, flour mills, glass works, brandy distilleries, and paper, soap, cotton and mosaic factories.

Bilbao, or Belva, as it was often called, was founded by Don Pedro Lopez de Haro about 1300, and soon rose into importance. It was occupied by the French in 1795, and from 1808 to 1813; and in 1835 and 1874 it was unavailingly besieged by the Carlists.

BILBEIS, or **BELBES**, a town of lower Egypt, on the eastern arm of the Nile, 36 m. N.N.E. of Cairo by rail. Pop. (1907) 13,485. The Coptic name, *Phelbes*, seems to have been derived from Egyptian, but nothing is known of the place before medieval times. Considered the bulwark of the kingdom on that side, Bilbeis was by the Moslems defended with strong fortifications. In 1163-1164 it was besieged for three months by the crusaders under Amalric, and in 1168 was captured and pillaged by another army of crusaders. Napoleon in 1798 ordered the restoration of the fortifications, but they have again fallen into decay. Bilbeis was the first halting-place of the English cavalry in their march on Cairo after the fight at Tel-el-Kebir on the 13th of September 1882.

BILBERRY, **BLAEBERRY** or **WHORTLEBERRY**, known botanically as *Vaccinium myrtillus* (natural order Ericaceae), a low-growing shrub, found in woods, copses and on heaths, chiefly in hilly districts. The stiff stems, from half a foot to two feet long, bear small ovate leaves with a serrate margin, and small, globose, rosary flowers tinged with green. The berries are dark blue, with a waxy bloom, and about one-third of an inch in diameter; they are used for jarts, preserves, &c. The plant is widely distributed throughout the north temperate and extends into the arctic zone. Cowberry is a closely allied species, *V. vitis-idaea*, growing in similar situations, but not found in the south-eastern portion of England, distinguished by its evergreen leaves and red acid berry.

BILBO (from the Spanish town Bilbao, formerly called in England "Bilboa," and famous, like Toledo, for its sword-blades), in the earliest English use, a sword, especially one of superior temper. In the plural form (as in Shakespeare's phrase "methought I lay worse than the mutines in the bilboes") it meant the irons into which offenders were put on board ship.

BILDERDIJK, WILLEM (1756-1831), Dutch poet, the son of an Amsterdam physician, was born on the 7th of September 1756. When he was six years old an accident to his foot incapacitated him for ten years, and he developed habits of continuous and concentrated study. His parents were ardent partisans of the house of Orange, and Bilderdijk grew up with strong monarchical and Calvinistic convictions. He was, says Da Costa, "anti-revolutionary, anti-Barneveldtian, anti-Loevesteinian, anti-liberal." After studying at Leiden University, he obtained his doctorate in law in 1782, and began to practise as an advocate at the Hague. Three years later he contracted an unhappy marriage with Rebecca Woesthoven. He refused in 1795 to take the oath to the new administration, and was consequently obliged to leave Holland. He went to Hamburg, and then to London, where his great learning procured him consideration. There he had as a pupil Katharina Wilhelmina Schweickhardt (1776-1830), the daughter of a Dutch painter and herself a poet. When he left London in June 1797 for Braunschweig, this lady followed him, and after he had formally divorced his first wife (1802) they were married. In 1806 he was persuaded by his friends to return to Holland. He was kindly received by Louis Napoleon, who made him his librarian, and a member and eventually president (1809-1811) of the Royal Institute. After the abdication of Louis Napoleon he suffered great poverty; on the accession of William of

Orange in 1813 he hoped to be made a professor, but was disappointed and became a history tutor at Leiden. He continued his vigorous campaign against liberal ideas to his death, which took place at Haarlem on the 18th of December 1831.

A picture of the Bilderdijk household is given in the letters (vol. v., 1850) of Robert Southey, who stayed some time with Bilderdijk in 1825. Madame Bilderdijk had translated *Roderick* into Dutch (1823-1824). For his work as a poet see **DUTCH LITERATURE**. His many-sided activity showed itself also in historical criticism—*Geschiedenis des Vaderlands* (1832-1851, 13 vols.), a conservative commentary on Wagenaar's *Vaderlandsche Historie*; in translations from Sophocles (1779 and 1789), of part of the *Iliad*, of the hymns and epigrams of Callimachus, and from the Latin poets; in philology—*Taal en Dichtkundige Verscheidenheden* (1820-1825, 4 vols.); and in drama—the tragedies, *Floris de Vijfde* (1808), *Willem I. van Holland* (1808), and others. His most important poetical works are the didactic poem, *De Ziekte der geleerden* ("The Disease of the Learned"), 2 vols., 1807; a descriptive poem in the manner of Delille in *Het Buitenleven* (1803); and his fragmentary epic, *De Ondergang der eerste wereld* (1820). Other volumes were *Mijne Verlosting* (Leiden, 1781), *Bloemtujsen* (1785), *Mengelpoëzij* (1790, 2 vols.), *Poëzij* (1803-1807, 4 vols.), *Mengelingen* (1804-1808, 4 vols.), *Nieuwe Mengelingen* (1806, 2 vols.), *Hollands Verlossing* (1813-1814, 2 vols.), *Vaderlandsche Uitboesemingen* (Leiden, 1815), *Winterbloemen* (1811, 2 vols.), &c., in some of which his wife collaborated.

His poetical works were collected by I. da Costa (Haarlem, 1856-1859, 16 vols.), with a biography of the poet. See also "Mijne Levensbeschrijving" in *Mengelingen en Fragmenten* . . . (1834); his *Brieven* (ed. 1836-1837) by I. da Costa and W. Messcher; Dr R. A. Kollé's *Bilderdijk, Zijn Leven en werken* . . . (2 vols., 1891).

BILEJK (Byzantine *Belocome*), chief town of the Ertoğrul sanjak of the Brusa vilayet in Asia Minor, altitude 1900 ft., situated on a hill $\frac{1}{2}$ m. from its station on the Ismid-Angora railway. Pop. 10,500 (Moslems, 7200; Christians, 3300). It is an important centre of the silk industry, and has several silk-spinning factories.

BILFINGER (**BÜLFINGER**), **GEORG BERNHARD** (1693-1750), German philosopher, mathematician and statesman, son of a Lutheran minister, was born on the 23rd of January 1693, at Kanstatt in Württemberg. As a boy he showed great aptitude for study, and at first devoted himself to theology, but under the influence of Wolff's writings he took up mathematics and philosophy on the lines of Wolff and Leibnitz. Returning to theology, he attempted to connect it with philosophy in a treatise, *Dilucidationes philosophicæ, de deo, anima humana, mundo* (Tübingen, 1725, 1746, 1768). This work, containing nothing original, but giving a clear representation of Wolff's philosophy, met with great success, and the author was appointed to the office of preacher at the castle of Tübingen and of reader in the school of theology. In 1721, after two years' study under Wolff, he became professor of philosophy at Halle, and in 1724 professor of mathematics. His friends at Tübingen disapproved his new views, and in 1725, on Wolff's recommendation, he was invited by Peter the Great to lecture in St Petersburg, where he was well received. His success in winning the prize of a thousand crowns offered for a dissertation on the cause of gravity by the Academy of Sciences of Paris secured his return to his native land in 1731. In 1735, largely on account of his knowledge of military engineering, Duke Charles Alexander (1733-1737) made him a privy councillor, but his hands were tied owing to the frivolous atmosphere of the court. On the death of the duke, however, he became a member of the Regency Council, and devoted himself with energy and success to the reorganization of the state. In the departments of education, state-religion, agriculture and commerce, his administration was uniformly successful, and he became in a real sense the head of the state. He died at Stuttgart on the 18th of February 1750. After his return from Russia, he won the highest respect at home and abroad, and Frederick the Great is recorded to have said of him, "He was a great man whom I shall ever remember with admiration."

Beside the *Dilucidationes*, he wrote:—*De harmonia animi et corporis humani commentatio* (Frankfort and Leipzig, 1735; Tübingen, 1741); *De origine et permissione mali* (1724), an account of the Leibnizian theodicy.

For his life and times see Tafinger, *Leichenrede* (Stuttgart, 1750); Prof. Abel in Moser's *Patriot. Archiv.*, 1788, 9, p. 369; Spittler, *Verm. Schriften*, 13, p. 421; G. Schwab in *Morgenblatt* (1830). For his philosophy, see R. Wahl, "Bilfinger's Monadologie" (*Zeitschrift für Philos.*, vol. 85, pp. 66-92, 202-231 (Leipzig, 1884); E. Zeller, *Geschichte d. deutsch. Philos. seit Leibniz*, pp. 283 foll., 294).

BIŁGE (a corruption of bulge, from Fr. *bulge*, Lat. *bulga*, a bag, deriving probably from an original Celtic word), the "belly" or widest part of a cask; the broad horizontal part of a ship's bottom above the keel; also the lowest interior part of the hull; hence "bilge-water," the foul water which collects in the bilge. "Bilge-keels" are pieces of timber fastened to the bottom of a ship to reduce rolling (see SHIPBUILDING).

BILHARZIOSIS. In various parts of Africa the inhabitants are liable to suffer from a form of endemic haematuria caused by the presence of a parasite in the mucous membrane of the urinary passages. This parasite was discovered in 1852 by Bilharz, and hence is generally known as Bilharzia, though it has been more scientifically named *Schistosoma haematobium*. The condition to which it gives rise is that of bilharziosis. (For description and life history of the parasite see TREMATODES.) In man the parasites and ova have been found in the minute veins of the bladder, ureter and pelvis of the kidney (more rarely in other organs), where they infest the mucous and submucous tissues. In an affected bladder the mucous membrane presents swollen vascular patches of varying size, or warty prominences on which the urinary salts may be deposited. The ova often serve as a nucleus for urinary calculi. Similar changes may take place in the ureter, and the consequent swelling lead to obstruction to the passage of urine, and if left untreated to pyelitis and pyonephrosis. If the rectum be affected the mucous membrane becomes thickened, polypoid growths form and large submucous haemorrhages may take place.

As to the mode of entrance of this parasite opinion is divided. Some authorities favour the view that the entrance is through the skin, urethra or rectum, the result of bathing in infected water; others that it is taken by the mouth in water or uncooked fish. The symptoms to which it gives rise are haematuria, pain in the perineal region and a greater or less degree of anaemia through loss of blood. If the disease continue, cystitis and its consequent train of symptoms ensue (see BLADDER AND PROSTATE DISEASES). If the rectum be affected there is considerable discharge of mucus, and later prolapsus ani may be the result. But the symptoms vary to a remarkable extent, from the slightest producing but little discomfort, to the most severe resulting in death. The liquid extract of male fern is the only drug used with much success. The symptoms caused by the parasite must be treated as they arise. Polypoid growths of the rectum must be surgically treated.

BILIN (Czech *Bilina*), a town of Bohemia, Austria, 90 m. N. of Prague by rail. Pop. (1900) 7871, chiefly German. It is a very old town situated on the Biela, and contains a 17th-century castle, belonging to Prince Lobkowitz. In the vicinity of the towns are extensive lignite mines. Bilin is famous for its mineral springs, the *Biliner Sauerbrunnen*. They have a temperature of 45-6° F., and contain a large proportion of bicarbonate of soda. About 4,000,000 bottles of water are exported annually, and another article of export is the salt recovered from the water by evaporation. About 5 m. to the S. of the Sauerbrunnen lies the Bofen or Biliner Stein (1763 ft.), a large mass of phonolite or clinkstone, with rare flora and fine view. The town is indeed surrounded by basaltic rocks, the largest of them being the Radelstein (2460 ft.), from which a fine view is obtained.

BILL. There are three words in English with distinct meanings and derivations. (1) A written, originally sealed, document. The word is derived from the Early English *bille*, Anglo-Latin *villa*, from Latin *villa*, in the medieval sense of "seal." It is a doublet, therefore, of "bull." (2) A common Teutonic word for a long-handled cutting weapon (O. Eng. *bil*, *billes*, sword or

falchion, O. Sax. *bill*, M.H.G. *Bil*, Mod. Ger. *Bille*, a pickaxe; no connexion with Ger. *Beil*, an axe), of which the name and shape is preserved in the hedging-bills used for pruning hedges and lopping the branches of trees. For an account of the weapon see (2) below. (3) The beak of a bird. This may be connected with (2), but it does not appear in any Teutonic language other than English.

(1) In the sense of a document the word is used in various connexions in law and commerce.

In the English parliament, and similar legislative bodies, a bill is a form of statute (*q.v.*) submitted to either house, which when finally passed becomes an act. The modern system of legislating by means of bill and statute appears to have been introduced in the reign of Henry VI., superseding the older mode of proceeding by petitions from the Commons, assented to by the king, and afterwards enrolled by the judges. A bill consists of a preamble, reciting the necessity for legislation, and clauses which contain the enactments. (For procedure see PARLIAMENT.)

A *Bill in Chancery*, in former days, in English law, was a written statement of the plaintiff's case whereby he complained of the wrong upon which the suit was based and prayed for relief. By the Judicature Acts 1873 and 1875 its place was taken by a writ and statement of claim (see PLEADING).

A *Bill of Indictment* is a presentment against a prisoner, charging him with an offence, and presented at quarter sessions or assizes to the grand jury (see INDICTMENT).

A *Bill of Costs* is an account setting forth the charges and disbursements incurred by a solicitor in the conduct of his client's business. The delivery of a bill of costs is by statute a condition necessary before the solicitor can sue upon it (see COSTS).

A *Bill of Exceptions* was formerly a statement in writing of objections to the ruling of a judge, who, at the trial, had mistaken the law, either in directing the jury, or in refusing or admitting evidence or otherwise. The bill of exceptions was tendered at a time before the verdict by counsel of the dissatisfied party, who required the judge to seal it. The case proceeded to the jury, and judgment being given, the point raised was brought before a court of error. Bills of exceptions were confined to civil cases. They were abolished by the Judicature Act 1875, and a "motion for a new trial" substituted (see TRIAL).

A *Bill of Health* is a document given to the master of a ship by the consul or other proper authority of the port from which he clears, describing the sanitary state of the place. A bill of health may be either "clean," "suspected" or "touched," or "foul." A "clean" bill imports that at the time the ship sailed, no disease of an infectious or contagious kind is known to exist, a "suspected" or "touched" bill, that no such disease has as yet appeared, but that there is reason to fear it; a "foul" bill, that such a disease actually exists at the time of the ship's departure. Bills of health are necessary where the destination of the ship is a country whose laws require the production of such a bill before the ship is allowed into port, and where, in default of such production, the ship is subjected to quarantine.

A *Bill of Mortality* in England was a weekly return issued under the supervision of the company of parish clerks showing the number of deaths in a parish. During the Tudor period England suffered much from plague, and various precautionary measures became necessary. Quarantine or isolation was the most important, but to carry it out successfully it was necessary to have early warning of the existence of plague in each parish or house. For this purpose searchers—usually women—were appointed, who reported to the clerk the cause of each death in the parish. He, in turn, sent a report to the parish clerks' hall, from whence was issued weekly a return of all the deaths from plague and other causes in the various parishes, as well as a list of those parishes which were free from plague. Bills of mortality are usually said to date from 1538, when parish registers were established by Cromwell (Lord Essex), but there is extant a bill which dates from August 1535, and one which is possibly even earlier than this. It is certain that they first began to be compiled in a recognized manner in December 1603, and they were continued regularly from that date down to 1842, when under the

Births and Deaths Registration Act 1836 they were superseded by the registrar-general's returns. It was not till 1728, when the *ages of the dead* were first introduced, that bills of mortality acquired any considerable statistical value. It was on the data thus furnished that the science of life insurance was founded.

A *Bill of Particulars* was, in law, a statement in writing, informing each party to a suit the precise nature of the case they had to meet. It contained the plaintiff's cause of action or the defendant's set-off. Particulars are now usually indorsed on the pleadings (see PLEADING).

A *Bill of Peace* is, in equity, a suit brought by a person to establish and perpetuate a right which he claims, and which from its nature may be controverted by different persons at different times and by different actions; or where several attempts have already been unsuccessfully made to overthrow the same right, and justice requires that the party should be quieted in the right if it is already sufficiently established. Bills of this nature were usually filed where there was one general right to be established against a great number of persons, or where one person claimed or defended a right against many, or where many claimed or defended a right against one. Thus, a bill might be filed by a parson for tithes against his parishioners; by parishioners against a parson to establish a *modus*; by a lord against tenants for an encroachment under colour of a common right; or by tenants against a lord for disturbance of a common right. Bills were also filed in cases where the plaintiff had, after repeated and satisfactory trials, established his right at law, and yet was in danger of further litigation and obstruction to his right from new attempts to controvert it. Actions in the nature of bills of peace are still maintainable.

A *Bill of Sight* is a document furnished to a collector of customs or other proper officer by an importer of goods in England, who, being unable for want of full information to make a perfect entry of goods consigned to him, describes the same to the best of his knowledge and information. The goods may then be provisionally landed, but perfect entry must be made within three days by indorsing on the bill of sight the necessary particulars. In default of perfect entry within three days the goods are taken to the king's warehouse, and if perfect entry is not made within one month and all duties and charges paid, they are sold for payment thereof. See the Customs Consolidation Act 1836.

A *Bill of Store* is a license granted by the custom-house to re-import British goods into the United Kingdom. All British goods re-imported into the United Kingdom are entered as foreign, unless re-imported within ten years after their exportation and unless the property in the goods continues and remains in the person by whom they were exported. But in such case they may be entered as British goods, by bill of store, with the exception of corn, grain, meal, flour and hops.

A *Bill of Victualling* or *Victualling Bill*, in its original meaning, is a list of all stores for shipment, but now an order from an export officer of the customs for the shipment from a bonded warehouse or for drawback of such stores as may be required and allowed with reference to the number of the crew and passengers on board a ship proceeding on an oversea voyage. It is made out by the master and countersigned by the collector of customs. Its object is to prevent frauds on the revenue. No such stores are supplied for the use of any ship nor any articles taken on board deemed to be stores unless they are borne upon the victualling bill, and any such stores relanded at any place in the United Kingdom without the sanction of the proper officers of the customs will be forfeited and the master and owner will each be liable to a penalty of treble the value of the stores or £100. A victualling bill serves as a certificate of clearance when there is nothing but stores on board the ship.

See also ADVENTURE, ATTAINDER, INDEMNITY, LETTER OF CREDIT, BILL OF EXCHANGE, BILL OF RIGHTS and BILL OF SALE; for a bill of lading see AFFREIGHTMENT. (T. A. L.)

(2) In the sense of a weapon, the primitive forms of a bill suggest short scythe-blades or hedgers' bill-hooks mounted on tall staves. In such shape it is found in the hands of the English before the Conquest. English medieval documents make much

confusion between the bill and the halbert and other forms of staved weapons with cutting heads. Before the 15th century the bill had been reinforced with a pike head above the curved blade and another jutting at a right angle from the blade's back. In this form it became a popular English weapon, the "brown bill" of many ballads. Billmen are not found in the king's host at Crécy and Calais, the bowmen carrying mallets or short swords, and Henry VII.'s contracts for troops do not name the bill, which may be regarded rather as the private man's weapon. But when, in the middle of the 15th century, Walter Strickland, a Westmorland squire, contracts to raise armed men, it is noticeable that more than half his horsemen carry the bill as their chief arm, while seventy-one bowmen are to march on foot with seventy-six billmen. In the 16th century the bill, with the halbert, fell out of use among regular troops, the pike taking their place on account of the longer staff, which made it a better defence against cavalry. It remained during the 17th century as a watchman or constable's weapon, although rudely-fashioned bills were seen in Sedgemoor fight. (O. B.A.)

BILLAUD-VARENNE, JACQUES NICOLAS (1756-1810), French revolutionist, was the son of an *avocat* at the parlement of Paris. He was badly brought up by a feeble father, a mother who combined immorality with religion, and a libertine abbé. At nineteen he donned the robe of an Oratorian, but did not take the vows, and busied himself with literature rather than with religion. In 1785 he left the Oratorian college where he was prefect of studies, came to Paris, married and bought a position as *avocat* in the parlement. Early in 1789 he published at Amsterdam a three-volume work on the *Despotisme des ministres de la France*, and he adopted with enthusiasm the principles of the Revolution.

At the Jacobin club he became from 1790 one of the most violent of the anti-royalist orators. After the flight of Louis XVI. to Varennes, he published a pamphlet, *L'Acéphalotie*, in which he demanded the establishment of a federal republic. On the 1st of July, in a speech at the Jacobin club he spoke of a republic, and the reference called out the stormy derision of the partisans of the constitutional monarchy; but repeating his demand for a republic on the 15th of the same month, the speech was ordered to be printed and to be sent to the branch societies throughout France. In the night of the 10th of August 1792 he was elected one of the "deputy-commissioners" of the sections who shortly afterwards became the general council of the commune. He was accused, though proof is lacking, of having been an accomplice in the massacres in the prison of the Abbaye. Elected a deputy of Paris to the National Convention, he at once spoke in favour of the immediate abolition of the monarchy, and the next day demanded that all acts be dated from the year 1 of the republic. At the trial of Louis XVI. he added new charges to the accusation, proposed to refuse counsel to the king, and voted for death "within 24 hours." On the 2nd of June 1793 he proposed a decree of accusation against the Girondists; on the 9th, at the Jacobin club, he outlined a programme which the Convention was destined gradually to realize: the expulsion of all foreigners not naturalized, the establishment of an impost on the rich, the deprivation of the rights of citizenship of all "anti-social" men, the creation of a revolutionary army, the licensing of all officers *ci-devant* nobles, the death penalty for unsuccessful generals. On the 15th of July he made a violent speech in the Convention in accusation of the Girondists. Sent in August as "representative on mission" to the departments of the Nord and of Pas-de-Calais, he showed himself inexorable to all suspects. On his return he was added to the Committee of Public Safety, which had decreed the arrest *en masse* of all suspects and the establishment of a revolutionary army, caused the extraordinary criminal tribunal to be named officially "Revolutionary Tribunal" (on the 29th of October 1793), demanded the execution of Marie Antoinette and then attacked Hébert and Danton. Meanwhile he published a book, *Les Éléments du républicanisme*, in which he demanded a division of property, if not equally, at least proportionally among the citizens. But he became uneasy for his own safety and turned

against Robespierre, whom he attacked on the 8th Thermidor as a "moderate" and a Dantonist. Surprised and menaced by the Thermidorian reaction, he denounced its partisans to the Jacobin club. He was then attacked himself in the Convention for his cruelty, and a commission was appointed to examine his conduct and that of some other members of the former Committee of Public Safety. He was arrested, and as a result of the insurrection of the 12th Germinal of the year 3 (the 1st of April 1795), the Convention decreed his immediate deportation to French Guiana. After the 18th Brumaire he refused the pardon offered by the First Consul. In 1816 he left Guiana and took refuge in Port-au-Prince (Haiti), where he died of dysentery.

In 1821 were published the *Mémoires de Billaud-Varenne écrits à Port-au-Prince* (Paris, 2 vols.), but they are probably forgeries. An interesting autobiographical sketch of his youth, *Tableau du premier âge*, composed in 1786, was published in 1888 in the review, *La Révolution française*. The facts of such a life need no comment. See, in addition to histories of the Revolution, F. A. Aulard, *Les Orateurs de la législatrice et de la convention* (2nd ed., 1906). (R. A. *)

BILLET. (1) (Like the Fr. *billet*, a diminutive of *bille*, a writing), a small paper or "note," commonly used in the 18th and early 19th centuries as a "billet of invitation." A particular use of the word in this sense is to denote an order issued to a soldier entitling him to quarters with a certain person (see **BILLETING**). From meaning the official order, the word *billet* came to be loosely used of the quarters thus obtained, giving rise to such colloquial expressions as "a good billet." Hence arises the sense of "billet" as the destination allotted to anything, for example in the saying of William III. "every billet has its billet." Another special sense of the word is that of a voting-paper, found in the 17th century, especially with reference to the Act of Billets passed by the Scottish parliament in 1662.

(2) (From the diminutive *billette* or *billos* of the Fr. *bille*, the trunk of a tree), a piece of wood roughly cylindrical, cut for use as fuel. In medieval England it was used of the club or bludgeon which was the weapon proper to the serf (Du Cange, s. *Billus*). The name has been transferred to various objects of a similar shape: to ingots of gold, for example, or bars of iron; and in heraldry, to a bearing of rectangular shape. The term is applied in architecture to a form of ornamental moulding much used in Norman and sometimes in Early English work. It bears a resemblance to small billets of wood arranged at regular intervals in a sunk moulding. In French architecture it is found in early work and there, sometimes, forms the decoration of a string-course under the gutter, with two or three rows of billets.

BILLETING, the providing of quarters (*i.e.* board and lodgings) for soldiers (see **BILLET**, 1). Troops have at all times made use of the shelter and local resources afforded by the villages on or near their line of march. The historical interest of billeting in England begins with the repeated petitions against it in the reigns of Elizabeth, James I. and Charles I., which culminated in the Petition of Right. The billeting of troops was superintended by a civil magistrate of the district to which the troops were sent or through which they passed. The magistrate, who acted under an order from the king, too often spared his friends at the expense of his political or personal opponents. Owing to the abuses to which the system led, it was declared illegal by the Petition of Right 1628, and again by an act of 1679. During the reign of James II., however, orders were frequently issued for billeting, and one of the grievances in the Bill of Rights was the quartering of soldiers contrary to law. On the organization of a standing army after the revolution it was necessary to make legal provision for billeting owing to the deficiency of barrack accommodation, which sufficed only for 5000 men. Accordingly, the Mutiny Act 1689 authorized billeting among the various innkeepers and victuallers throughout the kingdom. This statute was renewed annually from 1689 to 1879, when the Army Discipline Act, consolidating the provisions of the Mutiny Act, was passed. This statute was replaced by the Army Act 1881 (renewed annually by a

"commencement" act), which contains the provisions by which billeting is now regulated. But modern conditions have practically dispensed with the necessity for billeting; there is extensive barrack accommodation in most parts of the United Kingdom, and, moreover, troops are entrained or sent by sea when the distance to be covered is more than one day's march. In Scotland the provisions as to billeting were assimilated to those in England in 1857, and in Ireland in 1870. The Army (Annual) Act 1909 provided for the billeting of the Territorial forces in case of national emergency, on occupiers of any kind of house at the discretion of the chief officer of police.

BILLIARDS, an indoor game of skill, played on a rectangular table,¹ and consisting in the driving of small balls with a stick called a cue either against one another or into pockets according to the methods and rules described below. The name probably originated in the Fr. *bille* (connected with Eng. "billet") signifying a stick. Of the origin of the game comparatively little is known—Spain, Italy, France and Germany all being regarded as its original home by various authorities. In an American text-book, *Modern Billiards*, it is stated that Catrike More (Conn Cetchathach), king of Ireland in the 2nd century, left behind him "fifty-five billiard balls, of brass, with the pools and cues of the same materials." The same writer refers to the travels of Anacharsis through Greece, 400 B.C., during which he saw a game analogous to billiards. French writers differ as to whether their country can claim its origin, though the name suggests this. While it is generally asserted that Henrique Devigne, an artist, who lived in the reign of Charles IX., gave form and rule to the pastime, the *Dictionnaire universel* and the *Académie des jeux* ascribe its invention to the English. Bouillet in the first work says: "Billiards appear to be derived from the game of bowls. It was anciently known in England, where, perhaps, it was invented. It was brought into France by Louis XIV., whose physician recommended this exercise." In the other work mentioned we read: "It would seem that the game was invented in England." It was certainly known and played in France in the time of Louis XI. (1423-1483). Strutt, a rather doubtful authority, notwithstanding the reputation attained by his *Sports and Pastimes of the People of England*, considers it probable that it was the ancient game of Paille-maille (Pall Mall) on a table instead of on the ground or floor—an improvement, he says, "which answered two good purposes: it precluded the necessity of the player to kneel or stoop exceedingly when he struck the bowl, and accommodated the game to the limits of a chamber." Whatever its origin, and whatever the manner in which it was originally played, it is certain that it was known in the time of Shakespeare, who makes Cleopatra, in the absence of Anthony, invite her attendant to join in the pastime—

"Let us to billiards: come, Charmian."

Ant. and Cleo. Act ii. sc. 5.

In Cotton's *Compleat Gamester*, published in 1674, we are told that this "most gentle, cleanly and ingenious game" was first played in Italy, though in another page he mentions Spain as its birthplace. At that date billiards must have been well enough known, for we are told that "for the excellency of the recreation, it is much approved of and played by most nations of Europe, especially in England, there being few towns of note therein which hath not a public billiard table, neither are they wanting in many noble and private families in the country."

The game was at one time played on a lawn, like modern croquet.² Some authorities consider that in this form it was

¹ In 1907 an oval table was introduced in England by way of a change, but this variety is not here considered.

² A later form of "lawn-billiards" again enjoyed a brief popularity during the latter half of the 19th century. It was played on a lawn, in the centre of which was a metal ring about 5½ in. in diameter, planted upright in such a manner as to turn freely on its axis on a level with the ground. The players, two or more, were provided with implements resembling cues about 4 ft. long and ending in wire loops somewhat smaller in diameter than the wooden balls (one for each player), which were of such a size as barely to pass through the ring. In modern times such games as billiards have afforded scope for various imitations and modifications of this sort.

introduced into Europe from the Orient by the Crusaders. The ball was rolled or struck with a mallet or cue (with the latter, if Strutt's allusion to "inconveniences" is correct) through hoops or rings, and these were reproduced for indoor purposes on a billiard-table, as well as a "king" or pin which had to be struck. In the original tables, which were square, there was one pocket, a hole in the centre of the table, as on a bagatelle board, the hoop or ring being retained. Then came similar pockets along one of the side cushions sunk in the bed of the table; and eventually the modern table was evolved, a true oblong or double-square, with pockets opening in the cushions at each corner and in the middle of each long side. The English tables are of this type, small bags of netting being attached to the pockets. The French and American game of billiards is played on a pocketless table. We shall deal first with the English game.

ENGLISH BILLIARDS

The English table consists of a framework of mahogany or other hard wood, with six legs, and strong enough to bear the weight of five slabs of slate, each 2 3/4 ft. wide by 6 ft. 1 1/2 in., and about 2 in. thick. These having been fitted together with the utmost accuracy to form a level surface, and a green cloth of the finest texture having been tightly strained over it, the cushions are screwed on, and the pockets, for which provision has been made in the slates, are adjusted. As the inside edge of the cushion is not perpendicular to the bed of the table, but is bevelled away so that the top overhangs the base by about 1/2 of an in., the actual playing area of the table is 6 ft. wide but is 1 1/2 in. short of 12 ft. long. The height of the table is 2 ft. 8 in. measured from the floor to the cloth. The cloth is in the shape shown in the diagram.

The three spots are on the centre line of the table, and are usually marked by small circular pieces of black tissue paper or court plaster; sometimes they are specially marked for the occasion in chalk. The *baulk* line and the *D* are marked either with chalk, tailors' pipeclay, or an ordinary lead pencil; no other marks appear on the table. Smaller tables provide plenty of practice and amusement, provided that the relation of the length to the breadth be observed. On these tables full-sized balls may be used, the pockets being made slightly smaller than in the full-size table.

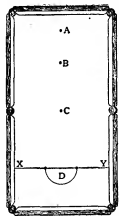

- A. The billiard spot measured from the nearest point of the baulk line.
- B. Pyramid spot.
- C. Centre spot.
- X, Y. Baulk line.
- D. Semicircle of 1 1/2 in. radius, known as the *D*.

In the early part of the 19th century the bed of the table was made of wood, occasionally of marble or stone; green baize was used to cover both the bed and the cushions, the latter made of layers of list. Then as now the cushions proper were glued to a wooden framework which is screwed on to the bed of the table. The old list cushions possessed so little resilience that about 1835 india-rubber was substituted, the value of the improvement being somewhat modified by the fact that in cold weather the rubber became hard and never recovered its elasticity. Vulcanite resisted the cold, but was not "fast" enough, i.e. did not permit the ball to rebound quickly; but eventually a substance was invented, practically proof against cold and sufficiently elastic for all purposes. Late in the 19th century pneumatic cushions were tried, tubes into which air could be pumped, but they did not become popular, though the so-called "vacuum" cushions give good results. The shape of the face of the cushion has gone through many modifications, owing to the difficulty experienced in the accurate striking of the ball when resting against the cushion with only a small fraction of its surface offered to the cue; but low cushions are now made which expose nearly half of the upper part of the ball.

On the size and shape of the pockets depends the ease with which the players score. The mouth of the pocket, known as the "fall" or "drop," is part of the arc of a circle, the circle being larger in the case of the corner pockets than in that of the middle pockets; the cushions are cut away to admit the passage of the ball. The corner pockets are measured by the length of the tangent drawn at the outside point of the arc to the cushion on either side. The middle pockets are measured at the points where the arc terminates in the cushions. The fall of the middle pockets, i.e. the outside point of the

arc, is on the line of the outside face of the cushion; that of the corner pockets is half way down the passage cut in the cushions.

From 1870 to 1885 matches for the championship were played on "Championship Tables," the pockets measuring only 3 in. at the "fall." The tables in ordinary use have 3 1/2-in. or 3 3/4-in. pockets, but in the "Standard Association Tables," introduced by the Billiard Association at the end of the 19th century, the 3 1/2-in. pocket was adopted for all matches, while the fall of the middle pocket was withdrawn slightly from the cushion-line. Further, as the shape of the shoulders of the cushion at the pockets affects the facility of scoring, the Association adopted a much rounder "shoulder" than that used in ordinary tables, thereby requiring greater accuracy on the part of the player. In the championship tables the baulk line was only 28 in. from the cushion, and the radius of the *D* was reduced to 9/2 and afterwards to 10 in., the spot being 12 1/2 in. from the top cushion.

The principal games are three in number,—*billiards proper*, *pyramids* and *pool*; and from these spring a variety of others. The object of the player in each game, however, is either to drive one or other of the balls into one or other of the pockets, or (only in billiards proper) to cause the striker's ball to come into successive contact with two other balls. The former stroke is known as a *hazard* (a term derived from the fact that the pockets used to be called hazards in old days), the latter as a *cannon*. When the ball is forced into a pocket the stroke is called a winning hazard; when the striker's ball falls into a pocket after contact with the object ball, the stroke is a losing hazard; "red hazards" mean that the red ball is the object-ball, "white hazards" the white.

Three balls are used in billiards proper, two white and one red. One of the white balls has a black spot at each end of an imaginary diameter, to distinguish it from the other, the white balls being known as spot-white (or "spot") and "plain." They should be theoretically perfect spheres, of identical size and weight, and of equal durability in all parts. The size that is generally used in matches has a diameter of 2 1/4 in., and the weight about 4 3/4 oz. It is exceedingly difficult to get three such ivory balls (the best substance for elasticity) except by cutting up many tusks, and when procured the balls soon lose their perfection, partly because ivory is softer in one part than another, partly because it is very susceptible to changes of weather and temperature, and unequally susceptible in different parts; it is also liable to slight injury in the ordinary course of play. Various substitutes have, therefore, been tried for ivory (*q.v.*), such as crystallate, or bonzoline (a celluloid compound), and even hollow steel; but their elasticity is inferior to that of ivory, so that the ball rebounds at a wider angle when it strikes. The price of a first-rate set of ivory balls is from four to six guineas; the composition balls cost about half a guinea apiece.

The cue is a rounded rod of seasoned ash about 4 ft. 9 in. in length, tapering from the butt, which is about 1 1/2 in. in diameter, to the tip, which varies in size according to the fancy of the player. The average tip is, however, 3/4 in. in diameter. The cue weighs generally between 14 and 18 oz. The tip of the cue is usually a leather cap or pad, which, being liable to slip along the surface of the ball in striking, is kept covered with chalk. To the left of the tip, the invention of a Frenchman named Mingin (about 1820), and to the right of which it gives the player over the ball, the science of modern play is entirely due. The butt of the cue is generally spliced with ebony or some other heavy wood, since a shaft of plain ash is too light for its purpose, and is furthermore liable to warp. At one time it was lawful to use the butt of the cue or even a special instrument with a squared spoon-shaped end called a mace (or mast), in making strokes or giving misses, but now all strokes must be made with the point. The cue is held in one hand, and with the other the player makes a "bridge" by placing wrist and finger-tips on the table, and extending his thumb so as to make a passage along which to slide his cue and to strike the ball. As it is not always possible to reach the ball in the way, longer cues (the "half-butt" and "long butt") are required; they are used with a rest, which is a shaft of wood at the end of which, perpendicular to the axis, is fastened an X of wood or metal, the cue being rested on the upper half while the lower is on the cloth. A "short rest," about 6 ft. long, is used with the long cues, the "short rest" (or "jigger") about 4 ft. long, with the ordinary cue. A marking-board and stands or racks for rests and butts, with iron and brush for the table, and a cover for the table when not in use, complete the billiard "furniture" of the room, apart from its seating accommodation.

The game of *billiards proper* consists of the making of winning and losing hazards and cannons. It is usually played between two opponents (or four, two against two) for 100 or more points, three being scored for each red hazard, two for each white hazard and two for each cannon. Certain forfeitures on the other hand score to the opponent: running your ball off the table or into a pocket without having hit another ball, 3 (a coup); ordinary

misses (not hitting an object-ball), i. All these forfeits involve the termination of the turn. There are also "foul strokes" which score nothing to the opponent, and only involve the termination of the turn: such as playing with the wrong ball, forcing a ball off the table, hitting a ball twice, &c. When the red ball is pocketed it is replaced on the billiard-spot; if that is occupied, on the pyramid-spot; if that too, on the centre-spot; but if the opponent's white ball is pocketed it remains out of play till his turn comes. Public matches between adepts are played for higher points, but the rules which govern them are the same. The players have alternate turns, each being "in play" and continuing his "break" until he falls to score.

The game commences by stringing for the lead and choice of balls. The players standing behind the baulk line, strike each a ball from the semicircle up to the top cushion, and he whose ball on its return stops nearest the bottom cushion has the choice of lead and balls. The red ball is placed on the spot at the commencement of the game, and the first player must "break the balls." The balls are said to be "broken" when the first player has struck the red or given a miss; and the opponent's ball when off the table is said to be "in hand." Breaking the balls takes place whenever the position, as at the beginning of the game, recurs. The first player, therefore, at any stage of the game when he plays after being "in hand" must place his own ball in any part of the D, or on the lines that form the D, and must play into the part of the table outside the baulk line, for he may not hit direct any ball that is "in baulk," i.e. on or behind the baulk-line; if he wishes to play at it he must first strike a cushion out of baulk (or, as it is called, *bricole*). If a player fails to score, the adversary plays, as soon as all the balls are at rest, either from baulk (if "in hand") or from the place where his own ball has stopped. If by the same stroke a player makes two scores, i.e. a cannon and a hazard for instance, or a winning and a losing hazard, he scores for each of them. Thus if he pockets the red ball and the cue-ball, he scores six, or if he makes a cannon and holes the red ball, five. In the case of a cannon and a losing hazard, made by the same stroke, the value of the hazard depends on the ball first struck. Thus if the cue-ball strikes the red, cannons on to the white, and runs into a pocket, the stroke counts five points, but only one cannon can be made by the same stroke, even if the cue-ball strikes each of the others twice. If both object-balls are struck simultaneously it is considered that the red is struck first. Ten points are the most that can be scored by a single stroke with the cue, namely by striking the red ball first and then the white, and holing it three times. If the white ball be struck first and the same series occurs, the value of the stroke is only five. When the cue-ball and object-ball are touching, whatever the position, the red ball is spotted, the white object-ball put on the centre-spot, and the player plays from baulk.

There are various subtleties in the art of striking, which may be indicated, though only practice can really teach them; the simple stroke being one delivered slightly above the centre of the ball.

The *side-stroke* is made by striking the object-ball on the side with the point of the cue. The effect of such a mode of striking the ball is to make it travel to the right or to the left, according as it is struck, with a winding or slightly circular motion; and its purpose is to cause the ball to proceed in a direction more or less slanting than is usual, or ordinary, when the ball is struck in or about the centre of its circumference. Many hazards and cannons, quite impossible to be made with the central stroke, are accomplished with ease and certainty by the side-stroke. It was the invention of the leather tip which made *side possible*. The *screw*, or twist, is made by striking the ball low down, with a sharp, sudden blow. According as the ball is struck nearer and nearer to the cushion, it stops dead at the point of concussion with the object-ball, or recoils by a series of reverse revolutions, in the manner familiar to the schoolboy in throwing forward a hoop, and causing it to return to his hand by the twist given to its first impetus.

The *follow* is made by striking the ball high, with a flowing or following motion of the cue. Just as the low stroke impedes the motion of the ball, the follow expedites it.

In the *drag* the ball is struck low without the sudden jerk of the screw, and with less than the onward push of the follow.

The *spot-stroke* is a series of winning hazards made by pocketing the red ball in one of the corners from the spot. The great art is, first, to make sure of the hazard, and next, to leave the striking ball in such a position as to enable the player to make a similar stroke in one or other of the corner pockets. To such perfection was the spot-stroke brought, that at the end of the 19th century it was necessary to bar it out of the professional matches, and the "spot-barred" game became the recognized one for all purposes. The leading English professionals so completely mastered the difficulties of the stroke and made such long successions of hazards that they practically killed all public interest in billiards, the game being little more than a monotonous series of spot-strokes. In 1888 W. J. Peall made 633 "spots" in succession, and in 1890 in a break of 3304—the longest record—no less than 3183 of the points were scored through spot-stroke breaks. J. G. Sala, by use of the screw-balk,

made 186 successive hazards in one pocket, but C. Memmott is said to have made as many as 423 such strokes in succession. The spot-stroke was known and used in 1825, when a run of twenty-two "spots" caused quite a sensation. The player, whose name was Carr, offered to play any man in England, but though challenged by Edwin Kentfield never met him, so the latter became champion. Kentfield, however, did not regard the spot-stroke as genuine billiards, rarely played it himself, and had the pocket of his tables reduced to 3 in., and the billiard-spot moved nearer to the top of the table, so as to make the stroke exceedingly difficult. John Roberts, sen., who succeeded Kentfield as champion in 1849, worked hard at the stroke, but never mastered it, in public, a longer run than 104 being made in succession. But W. Cook, John Roberts, jun., and others, assisted by the improvements made in the implements of the game, soon outdid Roberts, sen., only to be themselves outdone by W. Peall and W. Mitchell, who made such huge breaks by means of the stroke that it was finally barred, the Association rules providing that only two "spots" may be made in succession unless a cannon is combined with a hazard, and that after the second hazard the red ball be placed on the centre-spot.

Top-of-the-Table Play.—When the spot-stroke was dying, many leading players, headed by John Roberts, jun., assiduously cultivated another mode of play, known as "top-of-the-table-play," the first principle of which is to collect the balls at the top of the table near the spot. The balls are then manipulated by means of red winning hazards and cannons, the winning hazard not being made till the object-white can be left close to the spot.

The *Push-stroke*.—Long series of cannons were also made along the edge of the cushion, mainly by means of the "push-stroke," and with great rapidity, but eventually the push-stroke too was barred as unfair. It was usually employed when cue-ball and object-ball were very close together and the third ball was in a line, or nearly in a line with them; then by placing the tip of the cue very close to the cue-ball and pushing gently and carefully, not striking, the object-ball could be pushed aside and the cue-ball directed on ball.

Balls Jammed in Pockets.—If the two object-balls get jammed, either by accident or design, in the jaws of a corner pocket, an almost interminable series of cannons may be made by a skilful player. T. Taylor made as many as 729 cannons in 1891, but the American champion, Frank C. Ives, in a match with John Roberts, jun., easily beat this in 1893, by making 1267 cannons, before he deliberately broke up the balls. In Ives's case the balls, however, were just outside the jaws, which were skilfully used to keep the balls close together; but in this game, which was a compromise between English and American billiards, 24-in. balls and 34-in. pockets were used. Under the auspices of the Billiard Association a tacit understanding was arrived at that the position must be broken up, should it occur. A similar position came into discredit in 1907, in the case of the "cradle-double-kiss" or "anchor" cannon, where the balls were not actually jammed, but so close on each side of a pocket that a long series of cannons could be made without disturbing the position—a stroke introduced by Lovejoy and carried to extremes by him, T. Reece and others (see below).

The *Quill or Feather Stroke*.—This stroke was barred early in the game's history. It could only be made when the cue-ball was in hand and the object-ball just outside that part of the baulk-line that helps to form the D. The cue-ball was set so close to the object-ball as only to touch it, and was then pushed very gently into the pocket, grazing the other so slightly as just to shake it, and no more. A number of similar strokes could thus be made before the object-ball was out of position.

A *jenny* is a losing hazard into one of the (generally top) pockets when the object-ball is close to the cushion along which the pocket lies: it requires to be played with the *side* required to turn the ball into the pocket. Long jennies to the top pockets are a difficult and pretty stroke: short jennies are into the middle pockets.

Massé and Piqué.—A *massé* is a difficult stroke made by striking downwards on the upper surface of the cue-ball, the cue being held nearly at right angles to the table, and the point not being directed towards the centre of the ball. It is generally used to effect a cannon when the three balls are more or less in a line, the cue-ball and the object-ball being close together. The term *massé* often used irregularly for *piqué*, made when the object-ball is as close to the cue-ball as the latter to the cushion, or the third ball, or to make screwing impossible; the cue is then raised to an angle of almost 45° or 50° and its axis directed to the centre of the cue-ball, so that backward rotation is set up. Vignaux, the French player, says, "Le *massé est un piqué*." *Massé* is in fact *piqué* combined with *side*.

The perfection of billiards is to be found in the nice combination of the various strokes, in such fashion as to leave the balls in a favourable position, either for each individual hazard and cannon; and this perfection can only be attained by the most constant and unremitting practice. When the cue-ball is so played that its centre is aimed at the extreme edge of the object-ball, the cue-ball's course is diverted at what is called the "natural" or "half-ball" angle. If the balls were flat discs instead of spheres the edge of one ball would touch the centre of the other. The object-ball is struck at "three-quarter ball" or "quarter-ball" according as the edge of

the cue-ball appears to strike mid-way between the half-ball point and the centre or edge respectively of the object-ball. The half-ball angle is regarded as the standard angle for billiards, other angles being sometimes termed rather vaguely as "rather more or less than half-ball." The angle of the cue-ball's new course would be about 47° were the object-ball fixed, but as the object-ball moves immediately it is struck, the cue-ball is not actually diverted more than 33° from the prolongation of its original course, it being conventional among players to regard the prolongation of the course and not the original track when calculating the angle. The natural angle, and all angles, may be modified by side and screw; the use of strength also makes the ball go off at a wider angle.

Development in Billiard Play.—The modern development of English billiards is due mainly to the skill of such leading players as John Roberts, sen., and his son of the same name. Indeed, their careers form the history of modern billiards from 1849 when the elder Roberts challenged Kentfield (who declined to play) for the championship. No useful comparison can be made between the last-named men, and the change of cushions from list to india-rubber further complicates the question. Kentfield represented the best of the old style of play, and was a most skilful performer; but Roberts had a genius for the game, combined with great nerve and physical power. This capacity for endurance enabled him to practise single strokes till they became certainties, when weaker men would have failed from sheer fatigue; and that process applied to the acquisition of the spot-stroke was what placed him decisively in front of the players of his day until a younger generation taught by him came forward. In 1869 the younger generation had caught him up, and soon afterwards surpassed him at this stroke; both W. Cook and J. Roberts, jun., carried it to greater perfection, but they were in turn put entirely in the shade by W. Mitchell and W. J. Peall. It is curious to realize that John Roberts, sen., devalued the game chiefly by means of spot-play, whereas his son continued the process by abandoning it. The public, however, liked quick scoring and long breaks, and therefore a substitute had to be devised. This was provided chiefly by the younger Roberts, whose fertility of resource and manual dexterity eventually placed him by a very long way at the head of his profession. In exhibition matches he barred the spot-stroke and gave his attention chiefly to top-of-the-table play.

The next development was borrowed from the French game (see below), which consists entirely of cannons. Both French and American professors, giving undivided attention to cannons and not being permitted to use the *push-stroke*, arrived at a perfection in controlling or "nursing" the balls to which English players could not pretend; yet the principles involved in making a long series of cannons were applied, and leading professionals soon acquired the necessary delicacy of touch. The plan is to get the three balls close to each other, say within a space which a hand can cover, and not more than from 4 to 8 in. from a cushion. The striker's ball should be behind the other two, one of which is nearer the cushion, the other a little farther off and farther forward. The striker's ball is tapped quietly on the one next the cushion, and hits the third ball so as to drive it an inch or two in a line parallel to the cushion. The ball first struck rebounds from the cushion, and at the close of the stroke all three balls are at rest in a position exactly similar to that at starting, which is called by the French *position mère*. Thus each stroke is a repetition of the previous one, the positions of the balls being relatively the same, but actually forming a series of short advances along the cushion. With the push-stroke a great number of these cannons could be quickly made, say 50 in 3½ minutes; and, as that means 100 points, scoring was rapid. Most of the great spot-barred breaks contained long series of these cannons, and their value as records is correspondingly diminished, for in such hair's-breadth distances very often no one but the player, and sometimes not even he, could tell whether a stroke was made or missed or was foul. Push-barred, the cannons are played nearly as fast; but with most men the series is shorter, *massé* strokes being used when the cannon cannot be directly played.

Championship.—When Kentfield declined to play in 1849, John Roberts, sen., assumed the title, and held the position till

1870, when he was defeated by his pupil W. Cook. The following table gives particulars of championship matches up to 1885:—

Points.	Date.	Players.	Won by.
1200	Feb. 11, 1870	Cook <i>b.</i> Roberts, sen.	117
1000	April 14, 1870	Roberts, jun., <i>b.</i> Cook	478
1000	May 30, 1870	Roberts, jun., <i>b.</i> Bowles	246
1000	Nov. 28, 1870	Jos. Bennett <i>b.</i> Roberts, jun.	95
1000	Jan. 30, 1871	Roberts, jun., <i>b.</i> Bennett	363
1000	May 25, 1871	Cook <i>b.</i> Roberts, jun.	15
1000	Nov. 21, 1871	Cook <i>b.</i> Jos. Bennett	58
1000	Mar. 4, 1872	Cook <i>b.</i> Roberts, jun.	201
1000	Feb. 4, 1874	Cook <i>b.</i> Roberts, jun.	216
1000	May 24, 1875	Roberts, jun., <i>b.</i> Cook	163
1000	Dec. 20, 1875	Roberts, jun., <i>b.</i> Cook	135
1000	May 28, 1877	Roberts, jun., <i>b.</i> Cook	223
1000	Nov. 8, 1880	Jos. Bennett <i>b.</i> Taylor	91
1000	Jan. 12, 13, 1881	Jos. Bennett <i>b.</i> Taylor	50
3000	March 30, 31, and April 1, 1885	Roberts, jun., <i>b.</i> Cook	92
3000	June 1, 2, 3, 4, 1885	Roberts, jun., <i>b.</i> Jos. Bennett	1640

These games were played on three-inch-pocket tables, and John Roberts, jun., fairly contended that he remained champion till beaten on such a table under the rules in force when he won the title or under a new code to which he was a consenting party. A match was played for the championship between Roberts and Dawson in 1899 of 18,000 up, level. The main departure from a championship game lay in the table, which had ordinary, though not easy pockets, instead of three-inch pockets. The match excited much interest, because Dawson, who had already beaten North for the Billiard Association championship, was the first man for many years to play Roberts even; but Roberts secured the game by 1814 points. After this Dawson improved materially, and in 1899, for the second time, he won the Billiard Association championship. His position was challenged by Diggle and Stevenson, who contested a game of 9000 points. Stevenson won by 2900, but lost to Dawson by 2225 points; he beat him in January 1901, and though Dawson won a match before the close of the spring, Stevenson continued to establish his superiority, and at the beginning of 1907 was uncontestedly the English champion.

Records.—Record scores at billiards have greatly altered since W. Cook's break of 936, which included 292 spots, and was made in 1873. Big breaks are in some degree a measure of development; but 100 much weight must not be given to them, for tables vary considerably between easy and difficult ones, and comparisons are apt to mislead. Peall's break of 3304 (1890) is the largest "all-in" score on record; and in the modern spot-barred and push-barred game with a championship table, H. W. Stevenson in April 1904 made 788 against C. Dawson. In January 1905 John Roberts, however, made 821 in fifty minutes, in a match with J. Duncan, champion of Ireland; but this was not strictly a "record," since the table had not been measured officially by the Billiard Association. A break of 985 was made by Diggle in 1895 against Roberts, on a "standard table" (before the reduction in size of the pockets). On the 5th of March 1907 T. Reece began beating records by means of the "anchor" stroke, making 1269 (521 cannons), and he made an unfinished 4593 with the same stroke (2268 cannons) on the 23rd of March. Further large breaks followed, including 23,769 by Dawson on the 20th of April 1907, and even more by Reece; and towards the end of the year the Billiard Association ruled the stroke out.

Handicapping.—The obvious way of handicapping unequal players is for the stronger player to allow his opponent an agreed number of points by way of start. Or he may "owe" points, *i.e.* not begin to reckon his score till he has scored a certain number. A good plan is for the better player to agree to count no breaks that are below a certain figure. The giver of points scores all forfeits for misses, &c. If A can give B 20 points, and B can give C 25 points, the number of points that A can give C is calculated on the following formula, $20 + 25 - \frac{20 \times 25}{100} = 40$. The handicap of "barring" one or more pockets to the better player, he having only four or five pockets to play into, has been abolished in company with other methods that tended to make the game tedious.

Pyramids is played by two or four persons—in the latter case in sides, two and two. It is played with fifteen balls, placed close together by means of a frame in the form of a triangle or pyramid, with the apex towards the player, and a white striking ball. The centre of the apex ball covers the second or pyramid

spot, and the balls forming the pyramid should lie in a compact mass, the base in a straight line with the cushion.

Pyramids is a game entirely of winning hazards, and the who succeeds in pocketing the greatest number of balls wins. Usually the pyramid is made of fifteen red or coloured balls, with the striking ball white. This white ball is common to both players. Having decided on the lead, the first player, placing his ball in the baulk-semicolon, strikes it up to the pyramid, with a view either to lodge a ball in a pocket or to get the white safely back into baulk. Should he fail to pocket a red ball, the other player goes on and strikes the white ball from the place at which it stopped. When either succeeds in making a winning hazard, he plays at any other ball he chooses, and continues his break till he ceases to score; and so the game is continued by alternate breaks until the last red ball is pocketed. The game is commonly played for a stake upon the whole, and a proportionate sum upon each ball or life—as, for instance, 3s. game and 1s. balls. The player wins a life by pocketing a red ball or forcing it over the table; and loses a life by running his own, the white, ball into a pocket, missing the red balls, or intentionally giving a miss. In this game the baulk is no protection; that is to say, the player can pocket any ball wherever it lies, either within or without the baulk line, and whether the white be in hand or not. This liberty is a great and certain advantage under many circumstances, especially in the hands of a good player. It is not a very uncommon occurrence for an adept to pocket six or eight balls in a single break. Ben Cook and his partner are well known, indeed, to pocket the whole fifteen. If four persons play at pyramids, the rotation is decided by chance, and each plays alternately—partners, as in billiards, being allowed to advise each other, each going on and continuing to play as long as he can, and ceasing when he misses a hazard. Foul strokes are reckoned as in billiards, except as regards balls touching each other. If two balls touch, the player proceeds with his game and scores a point for every winning hazard. When all the red balls but one are pocketed, he who made the last hazard plays with the white and his opponent with the red; and so on alternately, till the game terminates by the holing of one or other ball. The pyramid balls are usually a little smaller than the billiard balls; the former are about 2 in. in diameter, the latter 2½ in. to 2½ in.

Lossing Pyramids, seldom played, is the reverse of the last-named game, and consists of losing hazards, each player using the same striking ball, and taking a ball from the pyramid for every losing hazard. As in the other game, the baulk is no protection. Another variety of pyramids is known as *Shell-out*, a game at which any number of persons may play. The pyramid is formed as before, and the same plan is followed. For each losing hazard the striker receives from each player a small stake, and for each losing hazard he pays a like sum, till the game is concluded, by pocketing the white or the last coloured ball.

Pool, a game which may be played by two or more persons, consists entirely of winning hazards. Each player subscribes a certain stake to form the pool, and at starting has three chances or lives. He is then provided with a coloured or numbered ball, and the game commences thus:—The white ball is placed on the spot and the red is played at it from the baulk semicircle. If the player pocket the white he receives the price of a life from the owner of the white; but if he fail, the next player, the yellow, plays on the red; and so on alternately till all have played, or till a ball be pocketed. When a ball is pocketed the striker plays on the ball nearest his own, and goes on playing as long as he can score.

The order of play is usually as follows:—The white ball is spotted; red plays upon white; yellow upon red; then blue, brown, green, black, and spot-white follow in the order of succession named, white playing on spot-white. The order is similar for a larger number, but it is not common for more than seven or eight to join in a pool. The player wins a life for every ball pocketed, and receives the sum agreed on for each life from the owner of the ball. He loses a life as the owner of the ball he plays on and misses; or by making a losing hazard after striking such ball; by playing at the wrong ball, by running a coup; or by forcing his ball over the table. Rules governing the game provide for many other incidents. A ball in baulk may be played at by the striker whose ball is in hand. If the striker's ball be angled—that is, so placed in the jaws of the pocket as not to allow him to strike the previously-played ball—he may have all the balls except his own and the object ball removed from the table to allow him to try to break from the cushion. In some of the common and public rooms an angle ball is allowed to be moved an inch or two from the corner; but with a ball so removed the player must not take a life. When the striker loses a life, the next in rotation plays at the ball nearest his own; but if the player's ball happen to be in hand, he plays at the ball nearest to the centre spot on the baulk line, whether it be in or out of baulk. In such a case the striker can play from any part of the semicircle. Any ball lying in the way of the striker's ball, and preventing him from taking fair aim and reaching the object-ball, must be removed, and replaced after the

stroke. If there be any doubt as to the nearest ball, the distance must be measured by the marker or umpire; and if the distance be equal, the ball to be played upon must be decided by chance. If the striker first pocket the ball he plays on and then runs his own into a pocket, he loses a life to the player whose ball he pocketed, which ball is then to be considered in hand. The first player who loses all his three lives can "star"; that is, by paying into the pool a sum equal to his original stake, he is entitled to as many lives as the lowest number on the marking board, and thus if the lowest number be 2, he stars 2; if 1, he stars 1. Only one star is allowed in a pool; and when there are only two players left in, no star can be purchased. The price of each life must be paid by the player losing it, immediately after the stroke is made; and the stake or pool is finally won by the player who remains longest in the game. In the event, however, of the two players last left in the pool having an equal number of lives, they may either play for the whole or divide the stake. The latter, the usual course, is followed except when the combatants agree to play out the game. When three players are left, each with one life, and the striker makes a miss, the two remaining divide the pool without a stroke—this rule being intended to meet the possible case of two players combining to take advantage of a third. When the striker has to play, he may ask which ball he has to play at, and if being wrongly informed he play at the wrong ball, he does not lose a life. In clubs and public rooms it is usual for the marker to call the order and rotation of play: "Red upon white, and yellow's your player"; and when a ball has been pocketed the fact is notified—"Brown upon blue, and green's your player, in hand"; and so on till there are only two or three players left in the pool.

There are some varieties of the game which need brief mention. **Single Pool** is the white winning hazard game, played for a stake and so much for each of three or more lives. Each person has a ball, usually white and spot-white. The white is spotted, and the other plays on it from the baulk semicircle; and then each plays alternately, spotting this ball after making a hazard. For each winning hazard the striker receives a life; for each losing hazard he pays a life; and the taker of the three lives wins the game. No star is allowed in single pool. The rules regulating pool are observed.

Nearest-Ball Pool is played by any number of persons with the ordinary colours, but with the order of play different. In all the rules of pool are followed, except that the baulk is a protection. The white is spotted, and the red plays on it; after that each striker plays upon the ball nearest the upper or outer side of the baulk-line; but if the balls lie within the baulk-line, and the striker's ball be in hand, he must play up to the top cushion, or place his ball on the spot. If his ball be not in hand, he plays at the nearest ball, wherever it may lie.

Black Pool.—In this game, which lasts for half-an-hour, there are no lives, the player whose ball is pocketed paying the stake to the pocketed ball. Each player receives a coloured ball, and plays in order as in Following Pool; the white ball being spotted on the centre-spot, in addition, however, a black ball, which is spotted on the centre-spot. When a player has taken a life he may—in some rooms and clubs *must*—play on the black ball. If he pockets it he receives a stake from each player, paying a stake all round if he misses it, or commits any of the errors for which he would have to pay at "Following Pool." The black ball cannot be taken in consecutive strokes. Sometimes a pink ball, spotted on the pyramid spot, is added and a single stake is paid all round to the man who pockets it, and a double stake on the black; it is also permitted in some rooms to take a black ball and pink alternately, by pocketing a coloured ball between the strokes. Again it is the custom in certain rooms to let a player, after the first round, play on any ball. The game is more amusing when as much freedom is allowed as possible, so that the taking of lives may be frequent. At the end of the half-hour the marker announces at the beginning of the round that it is the last round. White, who lost a stroke at the beginning by being spotted, has the last stroke. If a player wishes to enter the game during its progress his ball is put on the billiard-spot just before white plays, and he takes his first stroke at the end of the round.

Swooper Pool.—This is the name of many and elaborate rules. In principle it is a combination of pyramids and pool. The white ball is the cue-ball for all players. The pyramid balls, set up as in pyramids, count one point each, the yellow ball two points, green ball three, and so on. The black is put on the billiard-spot, the pink on the centre-spot, blue below the apex ball of the pyramid; brown, green and yellow on the diameter of the semicircle, brown on the middle spot, green on the right corner spot of the D, yellow on the left. The players, having decided the order of play, generally by distributing the pool balls from the basket, and playing in the order of colours as shown on the marking board, are obliged to strike a red ball first. If it is pocketed, the player scores one and is at liberty to play on any of the coloured balls; though in some clubs he is compelled to play on the yellow. If he pockets a coloured ball he scores the number of points which that ball is worth, and plays again on a red ball, the coloured ball being replaced on its spot, and so on; but a red ball must always be pocketed before a more valuable ball can be played at. When all the red balls have been pocketed—none are put back on the table as at pyramids—the remaining balls *must* be pocketed in the pool order and are not replaced. The

penalties for missing a ball, running into a pocket, &c., are deducted from the player's score; they correspond to the values of the balls, one point if the red be missed, two if the yellow be missed, &c. If, before hitting the proper ball, the player hits one of a higher value, the value of that ball is deducted from his score, but there is no further penalty. A player is "snookered" if his ball is so placed that he cannot hit a ball on which he is compelled to play. In this case he is allowed in some rooms to give a miss, but in such a way that the next player is not snookered; in other rooms he must make a *bona fide* attempt to hit the proper ball off the cushion, being liable to the usual penalty if in so doing he hits a ball of higher value. In some rooms it is considered fair and part of the game to snooker an opponent deliberately; in others the practice is condemned. The rules are so variable in different places that even the printed rules are not of much value, owing to local by-laws.

Among other games of minor importance, being played in a less serious spirit than those mentioned, are *Selling Pool*, *Nearest Ball Pool*, *Cork Pool* and *Skittle Pool*. The directions for playing them may be found in *Billiards* (Badminton Library series).

French and American Billiards.—French and American billiards is played on a pocketless table, the only kind of table that is used in France, though the English table with six pockets is also occasionally to be found in America. For match purposes the table used measures 10 ft. by 5 ft., but in private houses and clubs 9 ft. by 4½ ft. is the usual size, while tables 8 ft. by 4 ft. are not uncommon. The balls, three in number as in English billiards, measure from 2¼ to 2½ in., the latter being "match" size. Since they are both larger and heavier than the English balls, the cues are somewhat heavier and more powerful, so that better effects can be produced by means of "side," masses, &c. Only cannons (called in America "caroms," in French *caramboles*) are played, each counting one point.

The three-ball carom game is the recognized form of American billiards. The table is marked with a centre-spot, "red" spot and "white" spot. The first is on the centre of an imaginary line dividing the table longitudinally into halves; the red (for the red ball) and white spots are on the same line, half-way between the centre-spot and the end cushions, the white spot being on the string-line (corresponding to the English baulk-line). The right to play first is decided, as in England, by "stringing." The opponent's white ball and the red ball being spotted, the player plays from within the imaginary baulk-line. Each carom counts one point; a miss counts one to the opponent. A ball is re-spotted on its proper spot if it has been forced off the table. Should red be forced off the table and the red spot be occupied, it is placed on the white spot. White under similar conditions is set on the red spot. The centre spot is only used when, a ball having been forced off the table, both spots are occupied. If a carom be made, and the ball afterwards jumps off the table, it is spotted and the count allowed. If the striker moves a ball not his own before he strikes, he cannot count but may play for safety. If he does so after making a carom the carom does not count, he forfeits one, and his break is ended. If he touches his own ball before he plays, he forfeits a point, and cannot play the stroke. Should he, however, touch his ball a second time, the opponent has the option of having the ball replaced as exactly as possible, or of playing on them as they are left. It is a foul stroke to play with the wrong ball, but if the offence is not detected before a second stroke has been made, the player may continue.

Such long runs of caroms, chiefly "on the rail" along the cushion, have been made by professional players (H. Kerkau, the German champion, making 7156 caroms in 1901 at Zurich), that various schemes have been devised to make the game more difficult. One of these is known as the "continuous baulk-line." Lines are drawn, 8, 14 or even 22 in. from the rails, parallel to the side of the table, forming with them eight compartments. Of these 14 and 18 are the most general. Only one, two or three caroms, as previously arranged, are allowed to be made in every space, unless one at least of the object-balls is driven over a line. In the space left in the middle of the table any number of caroms may be made without restriction. In the case of the *Triangular Baulk-line*, lines are drawn at the four corners from the second "sight" on the side-rails to the first sight on the end-rails, forming four triangles within which only a limited number of caroms may be made, unless one object-ball at least be driven outside one of the lines. *Anchor Baulk-lines* were devised to checkmate the "anchor" shot, which consisted in getting the object-balls on the rail, one on either side of a baulk-line, and delicately manipulating them so as to make long series of caroms; each ball being in a different compartment, neither had to be driven over a line. The "anchor baulk-lines" form a tiny compartment, 6 in. by 3, and are drawn at the end of a baulk-line where it touches the rail and so divides the compartment into two squares. Only one shot is allowed in this "anchor-space," unless a ball be driven out of it. By these methods, "crocheting" (getting them jammed in a corner) of the balls, and "rods" of rail-caroms were abolished. The push-stroke is strictly forbidden.

The *Cushion Carom* game is a variety of the ordinary three-ball game, in which no carom counts unless the cue-ball touches a cushion before the carom is completed. There is also *Three-Cushion Carom*, which is explained by its title, and the *Bank-Shot* game, in which the cue-ball must touch a cushion before it strikes either ball. The cushion carom games are often used in handicapping, other methods of which are for the better player to make a certain number of caroms "on no count," and for the weaker to receive a number of points in the game.

In France billiards was played exclusively by the aristocracy and the richer middle class until the first part of the 17th century, when the privilege of keeping billiard-rooms was accorded to the *billiardiers paisiers*, and billiards became the principal betting game and remained so until the time of Louis Philippe. The most prominent French player of late years is Maurice Vignaux. The French game became the accepted one in the United States about 1870, and the best American players have proved themselves superior to the French masters with the exception of Vignaux. The best-known American masters have been M. Daly, Shaafer, Slosson, Carter, Sexton and Frank C. Ives, doubtless the most brilliant player who ever lived. His record for the 18-in. baulk-line game was an average of 50, with a high run of 290 points. In cushion-caroms he scored a run of 85.

The four-ball game, the original form of American billiards, is practically obsolete. It was formerly played on an English six-pocket table, with a dark-red and a light-red ball and two white ones. At present when played an ordinary table is used, the rules being identical with those of the three-ball game.

Pool is played in America on a six-pocket table with fifteen balls, each bearing a number. There are several varieties of the game, the most popular being *Continuous Pool*, an expanded form of *Fifteen-Ball Pool*, in which the balls are set up as in English pyramids, the game being won by the player pocketing the majority of the fifteen balls, each ball counting one point, the numbers being used only to distinguish them, as a player must always name, or "call," the ball he intends to pocket and the pocket into which he will drive it. The player who "breaks" (plays first) must send at least two balls to the cushion or forfeit three points. The usual method is to strike a corner on his right or left, the arrow pointing at the balls, to break up the balls, as in that case the second player would have too great an advantage. Balls pocketed by chance in the same play in which a called ball has been legitimately put down are counted; all others pocketed by accident are replaced on the table. In *Fifteen-Ball Pool* each frame (fifteen balls) constitutes a game. In *Continuous Pool* the game is for a series of points, generally 100, the balls being set up again after each frame and the player pocketing the last ball having the choice whether to break or cause his opponent to do so.

Three balls in *Fifteen-Ball Pool* are generally all of one colour, usually red. In *Pyramid Pool* they are parti-coloured as well as numbered, and the game, which usually consists of a single frame, is won by the player who, when all fifteen balls have been pocketed, has scored the greatest aggregate of the numbers on the balls. In *Chicago Pool* each frame constitutes a game and is won by the player scoring the highest aggregate of numbers on the balls, which are set up round the cushion opposite the diamond sights, the 1 being placed in the middle of the top cushion, opposite the player, with the odd-numbered balls on the player's left and those with even numbers on his right. The arrangement of the balls, however, varies and is not important. Each player must strike the lowest numbered ball still on the table, forfeiting the number of points represented by the ball should his ball first hit any other ball, or should he pocket his own ball. If he pockets the proper ball all others that fall into pockets on that play count for him also. Missing the ball played at forfeits three points (sometimes the number on the ball played at), as well as fouls of all kinds. *Bottle Pool* is played with a cue-ball, the 1 and 2 pool-balls and the leather pool-bottle, which is stood upon its mouth in the middle of the table. A carom on two balls counts 2 points; pocketing the 1-ball counts 1; pocketing the ball counts 2; upsetting bottle from carom counts 5; upsetting bottle to standing position counts 10, or, in many clubs, the game is won when this occurs. Otherwise the game is for 31 points, which number must be scored exactly, a player scoring more than that number being "burst," and having to begin over again. There are many penalties of one point, such as missing the object-ball, foul strokes, forcing a ball or the bottle off the table, pocketing one's own ball and upsetting the bottle without hitting a ball. The game of *Thirty-Four* is played without a bottle, the scoring being by caroms or pocketing the two object-balls. Exactly 34 must be scored or the player is "burst."

High-Low-Jack-Game is played with a set of pyramid balls by any number of players, the order of starting being determined by distributing the small balls from the pool-bottle. The 15-ball is High, the 1 Low, the 9 Jack, and the highest aggregate of numbers is the game, each of these four counting one point, the game consisting of seven points, and therefore lasting at least for two frames. The balls are set up with the three counting balls in the centre and broken as in pyramids, although balls accidentally falling into pockets count for the player, on which account the balls are sometimes broken as violently as possible. When two or more players

have the same score the High ball wins before the Low, &c., as in the card game of the same title.

Pin Pool is played with two white balls, one red and five small pins set up in diamond form in the centre of the table with the pin counting 5 (the king-pin) in the middle, the pins being 3 in. apart. Each player is given a small ball from the bottle and this he keeps secret until he is able to announce that his points, added to the number on his small ball, amount to exactly 31. The "bursts" he must begin again. Points are made only by knocking down pins, which are numbered 1 to 5. Should a player knock down with one stroke all four outside pins, leaving the 5-pin standing, it is a "natural" and he wins the game.

Besides these common varieties of pool there are many others which are played in different parts of America, many of them local in character.

BILIOGRAPHY.—The scientific features of billiards have been discussed at more or less length in several of the following older works:—E. White, *Practical Treatise on the Game of Billiards* (1807), this was partly a translation of a French treatise, published in 1801, and partly a compilation from the article in the *Académie universelle des jeux*, issued in the same year, and since frequently re-edited and reprinted; *Le Musée des jeux* (Paris, 1820); Monsieur Minguand, *The Noble Game of Billiards* (Paris, 1834); a translation of the same, by John Thurston (London, 1835); Kentfield, *On Billiards* (London, 1839), founded principally on the foregoing works; Edward Russell *Marion, Billiards, Game 500 sup* (London, 1849); Turner, *On Billiards, a series of diagrams with instructions* (Nottingham, 1849); Captain Crawley, *The Billiard Book* (London, 1866-1871); Roberts, *On Billiards* (1868); Fred. Hardy, *Practical Billiards*, edited by W. Dufton (1867); Joseph Bennett (ex-champion), *Billiards* (1873). These older books, however, are largely superseded by such modern authorities as the following:—J. Roberts, *The Game of Billiards* (London, 1898); W. Cook, *Billiards* (Burroughes & Watts); J. P. Buchanan, *Hints on Billiards* (Bell & Sons); *Modern Billiards* (The Brunswick - Balke - Collender Co., New York); Broadfoot, *Billiards*, Badminton Library (Longmans); Looock, *Side and Screw* (Longmans); M. Vignaux, *Le Billard* (Paris, 1883); A. Howard Cady, *Billiards and Pool* (Spalding's Home Library, New York); Thatcher, *Championship Billiards, Old and New* (Chicago, 1898). For those interested in the purely mathematical aspect of the game, Hemming, *Billiards Mathematically Treated*, (Macmillan).

BILLINGTON, ELIZABETH (1768?-1818), British opera-singer, was born in London, her father being a German musician named Weichsel, and her mother a popular vocalist. She was trained in music, and at fourteen sang at a concert in Oxford. In 1783 she married James Billington, a double-bass player. She had a voice of unusual compass, and as Rosetta in *Love in a Village* she had a great success at Covent Garden in 1786, being engaged for the season at a salary of £1,000, a large sum for those days. Her position as a singer in London was now assured. In 1794 she and her husband went to Italy, and Mrs Billington appeared at Naples (where she was the heroine of a new opera, *Inez di Castro*, written for her by F. Bianchi), at Florence, at Venice and at Milan. Her husband died suddenly during the tour, and in 1799 she married a Frenchman named Felissent, whom, however, she left in 1801. Returning to England she appeared alternately at Covent Garden and Drury Lane, her professional income during 1801 amounting to between £10,000 and £15,000. Henceforward she sang in Italian opera till the end of 1810, when ill-health forced her to abandon her profession. In 1817 she was reconciled to her husband, and went with him to live near Venice, where she died on the 25th of August 1818.

BILLITON (Dutch *Blitoeng*), an island of the Dutch East Indies, between Banka and Borneo, from which it is separated respectively by Gaspar and Karimata straits. Politically it is under an assistant resident. It is roughly circular in form, its extreme measurements being 55 m. by 43, and its area 1773 sq. m. In physical structure and in products it resembles Banka; its coasts are sandy or marshy; in the interior an extreme elevation of 1670 ft. is found. The geological formation is Devonian and granitic, with laterites. The mean annual rainfall is heavy, 102 to 126 in. The day temperature varies from 80° to 87° Fahr. The nights are very cool. Like Banka, Billiton is chiefly noted for its production of tin, the island forming the southern limit of the occurrence of this metal in this locality. There are upwards of 80 mines, which employ some 7500 workmen, and have produced more than 6500 tons of tin in a year. Iron is also worked. On the rocks along the coast are found tortoises, trepan and edible birds'-nests, which are articles of export. The forests supply wood of different kinds for boat-

building, in which the inhabitants are expert; and also provide trade in cocoa-nuts, sago, gum and other produce. The population is about 42,000, of whom some 12,000 are Chinese. The natives belong to two classes, the *Orang Darat*, the aborigines, thought to be akin to the Battas and other branches of the pre-Malayan or Indonesian race; and the *Orang Sekah*, people of Malayan stock who live in boats. The coast is as a rule difficult of access, being beset with rocks and coral banks, and the best harbour is that at the chief town of Tanjong Pandan on the west coast. The island was formerly under the sultan of Palembang, by whom it was ceded to the British in 1812. As no mention was made of it in the treaty between the British and Dutch in 1814, the former at first refused to renounce their possession, and only recognized the Dutch claim in 1824. Till 1852 Billiton was dependent on Banka.

BILL OF EXCHANGE, a form of negotiable instrument, defined below, the history of which, though somewhat obscure, was ably summed up by Lord Chief Justice Cockburn in his judgment in *Goodwin v. Roberts* (1875), L.R. 10 Ex. pp. 346-358. Bills of exchange were probably invented by Florentine Jews. They were well known in England in the middle ages, though there is no reported decision on a bill of exchange before the year 1603. At first their use seems to have been confined to foreign bills between English and foreign merchants. It was afterwards extended to domestic bills between traders, and finally to bills of all persons, whether traders or not. But for some time after they had come into general employment, bills were always alleged in legal proceedings to be drawn *secundum usum et consuetudinem mercatorum*. The foundations of modern English law were laid by Lord Mansfield with the aid of juries of London merchants. No better tribunal of commerce could have been devised. Subsequent judicial decisions have developed and systematized the principles thus laid down. Promissory notes are of more modern origin than bills of exchange, and their validity as negotiable instruments was doubtful until it was confirmed by a statute of Anne (1704). Cheques are the creation of the modern system of banking.

Before 1882 the English law was to be found in 17 statutes dealing with isolated points, and about 2600 cases scattered over some 300 volumes of reports. The Bills of Exchange Act 1882 codifies for the United Kingdom the law relating to bills of exchange, promissory notes and cheques. One peculiar Scottish rule is preserved, but in other respects uniform rules are laid down for England, Scotland and Ireland. After glancing briefly at the history of these instruments, it will probably be convenient to discuss the subject in the order followed by the act, namely, first, to treat of a bill of exchange, which is the original and typical negotiable instrument, and then to refer to the special provisions which apply to promissory notes and cheques. Two salient characteristics distinguish negotiable instruments from other engagements to pay money. In the first place, the assignee of a negotiable instrument, to whom it is transferred by indorsement or delivery according to its tenor, can sue thereon in his own name; and, secondly, he holds it by an independent title. If he takes it in good faith and for value, he takes it free from "all equities," that is to say, all defects of title or grounds of defence which may have attached to it in the hands of any previous party. These characteristic privileges were conferred by the law merchant, which is part of the common law, and are now confirmed by statute.

Definition.—By § 3 of the act a bill of exchange is defined to be "an unconditional order in writing, addressed by one person to another, signed by the person giving it, requiring the person to whom it is addressed to pay on demand or at a fixed or determinable future time a sum certain in money to or to the order of a specified person, or to bearer."¹ The person who gives the order is called the drawer. The person thereby required to pay is called the drawee. If he assents to the order, he is then called

¹ This is also the definition given in the United States, by § 126 of the general act relating to negotiable instruments, prepared by the conference of state commissioners on uniform legislation, and it has been adopted in the leading states.

of it, but he is not the mercantile owner, and he is not technically the holder or bearer. But to get the full advantages of mercantile ownership the holder must be a "holder in due course"—that is to say, he must satisfy three business conditions. First, he must have given value, or claim through some holder who has given value. Secondly, when he takes the bill, it must be regular on the face of it. In particular, the bill must not be overdue or known to be dishonoured. An overdue bill, or a bill which has been dishonoured, is still negotiable, but in a restricted sense. The transferee cannot acquire a better title than the party from whom he took it had (§ 36). Thirdly, he must take the bill honestly and without notice of any defect in the title of the transferor,—as, for instance, that the bill or acceptance had been obtained by fraud, or threats or for an illegal consideration. If he satisfies these conditions he obtains an indefeasible title, and can enforce the bill against all parties thereto. The act substitutes the expression "holder in due course" for the somewhat cumbersome older expression "bona fide holder for value without notice." The statutory term has the advantage of being positive instead of negative. The French equivalent "tiers porteur de bonne foi" is expressive. Forgery, of course, stands on a different footing from a mere defect of title. A forged signature, as a general rule, is a nullity. A person who claims through a forged signature has no title himself, and cannot give a title to any one else (§ 24). Two exceptions to this general rule require to be noted. First, a banker who in the ordinary course of business pays a demand draft held under a forged indorsement is protected (§ 60). Secondly, if a bill is issued with material blanks in it, any person in possession of it has prima facie authority to fill them up, and if the instrument when complete gets into the hands of a holder in due course the presumption becomes absolute. As between the immediate parties the transaction may amount to forgery, but the holder in due course is protected (§ 20).

Dishonour.—The holder of a bill has special duties which he must fulfil in order to preserve his rights against the drawers and indorsers. They are not absolute duties; they are duties to use reasonable diligence. When a bill is payable after sight, presentment for acceptance is necessary in order to fix the maturity of the bill. Accordingly the bill must be presented for acceptance within a reasonable time. When a bill is payable on demand it must be presented for payment within a reasonable time. When it is payable at a future time it must be presented on the day that it is due. If the bill is dishonoured the holder must notify promptly the fact of dishonour to any drawer and indorser he wishes to charge. If, for example, the holder only gives notice of dishonour to the last indorser, he could not sue the drawer unless the last indorser or some other party liable has duly sent notice to the drawer. When a foreign bill is dishonoured the holder must cause it to be protested by a notary public. The bill must be noted for protest on the day of its dishonour. If this be duly done, the protest, *i.e.* the formal notarial certificate attesting the dishonour, can be drawn up at any time as of the date of the noting. A dishonoured inland bill may be noted, and the holder can recover the expenses of noting, but no legal consequences attach thereto. In practice, however, noting is usually accepted as showing that a bill has been duly presented and has been dishonoured. Sometimes the drawer or indorser has reason to expect that the bill may be dishonoured by the drawee. In that case he may insert the name of a "referee in case of need." But whether he does so or not, when a bill has been duly noted for protest, any person may, with the consent of the holder, intervene for the honour of any party liable on the bill. If the bill has been dishonoured by non-acceptance it may be "accepted for honour *supra protest*." If it has been dishonoured by non-payment it may be paid *supra protest*. When a bill is thus paid and the proper formalities are complied with, the person who pays becomes invested with the rights and duties of the holder so far as regards the party for whose honour he has paid the bill, and all parties antecedent to him (§§ 65 to 68).

Discharge.—Normally a bill is discharged by payment in due

course, that is to say, by payment by the drawee or acceptor to the holder at or after maturity. But it may also be discharged in other ways, as for example by coincidence of right and liability (§ 61), voluntary renunciation (§ 62), cancellation (§ 63), or material alteration (§ 64).

Conflict of Laws.—A bill of exchange is the most cosmopolitan of all contracts. It may be drawn in one country, payable in another, and indorsed on its journey to its destination in two or three more. The laws of all these countries may differ. Provision for this conflict of laws is made by § 72, which lays down rules for determining by what law the rights and duties of the various parties are to be measured and regulated. Speaking broadly, these rules follow the maxim *Locus regit actum*. A man must be expected to know and follow the law of the place where he conducts his business, but no man can be expected to know the laws of every country through which a bill may travel. For safety of transmission from country to country bills are often made out in sets. The set usually consists of three counterparts, each part being numbered and containing a reference to the other parts. The whole set then constitutes one bill, and the drawee must be careful only to accept one part, otherwise if different accepted parts get into the hands of different holders, he may be liable to pay the bill twice (§ 71). Foreign bills circulating through different countries have given rise to many intricate questions of law. But the subject is perhaps one of diminishing importance, as in many trades the system of "cable transfers" is superseding the use of bills of exchange.

A cheque "is a bill of exchange drawn on a banker payable on demand" (§ 73). For the most part the rules of law applicable to bills payable on demand apply in their entirety to cheques. But there are certain peculiar rules relating to the latter which arise from the fact that the relationship of banker and customer subsists between the drawer and drawee of a cheque. For example, when a person has an account at a bank he is, as an inference of law, entitled to draw on it by means of cheques. A right to overdraw, can, of course, only arise from agreement. The drawer of a cheque is not absolutely discharged by the holder's omission to present it for payment within a reasonable time. He is only discharged to the extent of any actual damage he may have suffered through the delay (§ 74). Apart from any question of delay, a banker's authority to pay his customer's cheques is determined by countermand of payment or by notice of the customer's death (§ 75). Of recent years the use of cheques has enormously increased, and they have now become the normal machinery by which all but the smallest debts are discharged. To guard against fraud, and to facilitate the safe transmission of cheques by post, a system of crossing has been devised which makes crossed cheques payable only through certain channels. The first act which gave legislative recognition to the practice of crossing was the 19 and 20 Vict. c. 95. That act was amended in 1875, and a consolidating and amending act was passed in 1876. The act of 1876 is now repealed, and its provisions are re-enacted with slight modifications by §§ 76 to 82 of the Bills of Exchange Act 1883. A cheque may be crossed either "generally" or "specially." A cheque is crossed generally by drawing across it two parallel lines and writing between them the words "& Co." When a cheque is crossed generally it cannot be paid over the counter. It must be presented for payment by a banker. A cheque is crossed specially by adding the name of the banker, and then it can only be presented through that particular banker. A cheque, whether crossed generally or specially, may further be crossed with the words "not negotiable." A cheque crossed "not negotiable" is still transferable, but its negotiable quality is restricted. It is put on pretty much the same footing as an overdue bill. The person who takes it does not get, and cannot give a better title to it, than that which the person from whom he took it had. These provisions are supplemented by provisions for the protection of paying and collecting bankers who act in good faith and without negligence. Suppose that a cheque payable to bearer, which is crossed generally and with the words "not

negotiable," is stolen. The thief then gets a tradesman to cash it for him, and the tradesman gets the cheque paid on presentment through his banker. The banker who pays and the banker who receives the money for the tradesman are protected, but the tradesman would be liable to refund the money to the true owner. Again, assuming payment of the cheque to have been stopped, the tradesman could not maintain an action against the drawer.

A promissory note is defined by section 83 of the act to be an "unconditional promise in writing made by one person to another, signed by the maker, engaging to pay on demand, or at a fixed or determinable future time, a sum certain in money to or to the order of a specified person or to bearer." A promissory note may be made by two or more makers, and they may be liable either jointly, or jointly and severally, according to its tenor (§ 85). For the most part, rules of law applicable to a bill of exchange apply also to a promissory note, but they require adaptation. A note differs from a bill in this: it is a direct promise to pay, and not an order to pay. When it issues it bears on it the engagement of the principal debtor who is primarily liable thereon. The formula for applying to notes the rules as to bills is that "the maker of a note shall be deemed to correspond with the acceptor of a bill, and the first indorser of a note shall be deemed to correspond with the drawer of a bill payable to drawer's order" (§ 89). Rules relating to presentment for acceptance, acceptance, acceptance *supra* protest, and bills in a set, have no application to a note. Moreover, when a foreign note is dishonoured it is not necessary, for English purposes, to protest it. All promissory notes are, under the Stamp Act 1891, subject to an *ad valorem* stamp duty. Inland notes must be on impressed stamp paper. Foreign notes are stamped with adhesive stamps. For ordinary legal purposes a bank note may be regarded as a promissory note made by a banker payable to bearer on demand. It is, however, subject to special stamp regulations. It is not discharged by payment, but may be re-issued again and again. In the interests of the currency the issue of bank notes is subject to various statutory restrictions. A bank, other than the Bank of England, may not issue notes in England unless it had a lawful note issue in 1844. On the other hand, Bank of England notes are legal tender except by the bank itself.

In fundamental principles there is general agreement between the laws of all commercial nations regarding negotiable instruments. As Mr Justice Story, the great American lawyer, says: "The law respecting negotiable instruments may be truly declared, in the language of

Foreign laws.

Cicero, to be in a great measure not the law of a single country only, but of the whole commercial world. *Non erit lex alia Romæ, alia Athenis, alia nunc alia posthac, sed et apud omnes gentes et omni tempore, una eademque lex obtinebit*" (Swift v. Tyson, 16 Peters 1). But in matters of detail each nation has impressed its individuality on its own system. The English law has been summarized above. Perhaps its special characteristics may be best brought out by comparing it with the French code and noting some salient divergences. English law has been developed gradually by judicial decision founded on trade custom. French law was codified in the 17th century by the "Ordonnance de 1673." The existing "Code de Commerce" amplifies but substantially adopts the provisions of the "Ordonnance." The growth of French law was thus arrested at an early period of its development. The result is instructive. A reference to Marius' treatise on bills of exchange, published about 1670, or Beawes' *Lex Mercatoria*, published about 1740, shows that the law, or rather the practice, as to bills of exchange was even then fairly well defined. Comparing the practice of that time with the law as it now stands, it will be seen that it has been modified in some important respects. For the most part, where English law differs from French law, the latter is in strict accordance with the rules laid down by Beawes. The fact is that, when Beawes wrote, the law or practice of both nations on this subject was nearly uniform. But English law has gone on growing while French law has stood

still. A bill of exchange in its origin was an instrument by which a trade debt due in one place was transferred to another place. This theory French law rigidly keeps in view. In England bills have developed into a paper currency of perfect flexibility. In France a bill represents a trade transaction; in England it is merely an instrument of credit. English law affords full play to the system of accommodation paper; French law endeavours to stamp it out. A comparison of some of the main points of difference between English and French law will show how the two theories work. In England it is no longer necessary to express on a bill that value has been given for it, for the law raises a presumption to that effect. In France the nature of the consideration must be stated, and a false statement of value avoids the bill in the hands of all parties with notice. In England a bill may be drawn and payable in the same place. In France the place where a bill is drawn should be so far distant from the place where it is payable that there may be a possible rate of exchange between the two. This so-called rule of *distancia loci* is said to be disregarded now in practice, but the code is unaltered. As French lawyers put it, a bill of exchange necessarily presupposes a contract of exchange. In England since 1765 a bill may be drawn payable to bearer, though formerly it was otherwise. In France it must be payable to order; if it were not so it is clear that the rule requiring the consideration to be truly stated would be a nullity. In England a bill originally payable to order becomes payable to bearer when indorsed in blank. In France an indorsement in blank merely operates as a procurator. An indorsement, to operate as a negotiation, must be to order, and must state the consideration; in short, it must conform to the conditions of an original draft. In England, if a bill is dishonoured by non-acceptance, a right of action at once accrues to the holder. In France no cause of action arises unless the bill is again dishonoured at maturity; the holder in the meantime is only entitled to demand security from the drawer and indorsers. In England a sharp distinction is drawn between current and overdue bills. In France no such distinction is drawn. In England no protest is required in the case of the dishonour of an inland bill, notice of dishonour being sufficient. In France every dishonoured bill must be protested. Opinions may differ whether the English or the French system is better calculated to serve sound commerce and promote a healthy commercial morality. But an argument in favour of the English system may be derived from the fact that as the various continental codes are from time to time revised and re-enacted, they tend to depart from the French model and to approximate to the English rule. The effect upon English law of its codification has yet to be proved. A common objection to codification in England is that it deprives the law of its elastic character. But when principles are once settled common law has very little elasticity. On the other hand no code is final. Modern parliaments legislate very freely, and it is a much simpler task to alter statute law than to alter common law. Moreover, legislation is cheaper than litigation. One consequence of the codification of the English law relating to bills is clear gain. Nearly all the British colonies have adopted the act, and where countries are so closely connected as England and her colonies, it is an obvious advantage that their mercantile transactions should be governed by one and the same law expressed in the same words.

The ordinary text-books on the law of bills of exchange are constantly re-edited and brought up to date. The following among others may be consulted:—Byles, *Bills of Exchange*; Chalmers, *Bills of Exchange*; Daniel, *Law of Negotiable Instruments* (United States); Nouguier, *Des lettres de change et des effets de commerce* (France); Thorburn, *Bills of Exchange Act 1882* (Scotland); Story, *Bills of Exchange* (United States); Hodgins, *Bills of Exchange Act 1890* (Canada). (M. D. Ctt.)

BILL OF RIGHTS, an important statute in English constitutional history. On the 13th of February 1689 the Declaration of Right, a document drawn up by a committee of the commons, and embodying the fundamental principles of the constitution, was delivered by the lords and commons to the prince and princess of Orange, afterwards William III. and Mary. In

December 1689 the rights claimed by the declaration were enacted with some alterations by the Bill of Rights, next to Magna Carta the greatest landmark in the constitutional history of England and the nearest approach to the written constitutions of other countries. The act (the full name of which is An Act declaring the Rights and Liberties of the Subject, and settling the Succession of the Crown), after reciting the unconstitutional proceedings of James II., the abdication of that king, the consequent vacancy of the crown, and the summons of the convention parliament, declared, on the part of the lords and commons, "for the vindicating and asserting their ancient rights and liberties"—

"(1) That the pretended power of suspending of laws or the execution of laws by regal authority without consent of parliament is illegal. (2) That the pretended power of dispensing with laws or the execution of laws by regal authority, as it hath been assumed and exercised of late, is illegal. (3) That the commission for erecting the late court of commissioners for ecclesiastical causes, and all other commissions and courts of like nature, are illegal and pernicious. (4) That levying money for or to the use of the crown, by pretence of prerogative, without grant of parliament, for longer time or in other manner than the same is or shall be granted, is illegal. (5) That it is the right of the subjects to petition the king, and all commitments and prosecutions for such petitioning are illegal. (6) That the raising or keeping a standing army within the kingdom in time of peace, unless it be with consent of parliament, is against law. (7) That the subjects which are Protestants may have arms for their defence suitable to their conditions, and as allowed by law. (8) That elections of members of parliament ought to be free. (9) That the freedom of speech, and debates or proceedings in parliament, ought not to be impeached or questioned in any court or place out of parliament. (10) That excessive bail ought not to be required, nor excessive fines imposed, nor cruel and unusual punishments inflicted. (11) That jurors ought to be duly impanelled and returned and jurors which pass upon men in trials for high treason ought to be freeholders. (12) That all grants and promises of fines and forfeitures of particular persons before conviction are illegal and void. (13) And that for redress of all grievances, and for the amending, strengthening and preserving of the laws, parliament ought to be held frequently. And they do claim, demand and insist upon all and singular the premises, as their undoubted rights and liberties."

The further provisions of the act were concerned with the settlement of the crown upon the prince and princess of Orange, with the exception of § 12, which negatived the right of dispensation by *non obstante*¹ to or of any statute or any part thereof, unless a dispensation be allowed in the statute itself or by bill or bills to be passed during the then session of parliament.

It is to be noticed that the Declaration of Right and the Bill of Rights introduced no new principle into the English constitution; it was merely a declaration of the law as it stood. In the United States, the main provisions of the Bill of Rights, so far as they are applicable, have been adopted both in the constitution of the United States and in the state constitutions.

BILL OF SALE, in its original sense, a legal document assigning personal property, and still used in connexion with the transference of property in ships. The term has come to be applied to mortgages as well as to sales, and the expression "bill of sale" may now be understood to signify generally a document evidencing a sale or mortgage of personal chattels, unaccompanied by an actual transfer of possession to the purchaser or mortgagor.

The first English legislation on the subject was the Bills of Sale Act 1854, which, after reciting that "frauds were frequently committed upon creditors by secret bills of sale of personal chattels, whereby persons are enabled to keep up the appearance of being in good circumstances and possessed of property, and the grantees or holders of such bills of sale have the power of taking possession of the property of such person to the exclusion of the rest of their creditors," provided that all bills of sale, as defined in the act, should be void against execution creditors unless registered. This act was amended by the Bills of Sale Act 1866. These acts were repealed and a new act passed, the Bills of Sale Act 1878, which, in the main, followed the lines of the act of 1854. The scope of this legislation was very much widened by the Bills of Sale Act (1878) Amendment Act 1882, which was intended primarily "to prevent needy persons being entrapped into signing complicated documents which they might

often be unable to comprehend, and so being subjected by their creditors to the enforcement of harsh and unreasonable provisions" (*Manchester &c. Ry. Co. v. N.C. Wagon Co.*, 1888, 13 App. Ca. 554). The law is now regulated by these two acts, together with the Bills of Sale Acts of 1890 and 1891, which effected further small amendments by excluding from the operation of the principal acts instruments hypothecating, charging or declaring trusts on imported goods, during the interval between their unloading from a ship and their deposit in a warehouse, or re-shipping.

Under the acts of 1878 and 1882 bills of sale are of two kinds, *i.e.* *absolute bills of sale* (where chattels are sold absolutely to a purchaser), and *bills of sale by way of security for the payment of money*. The Bills of Sale Act 1878 governs both kinds and is the only act which applies to *absolute bills*. Bills of sale given by way of security for the payment of money on or after the 1st of November 1882 are governed by the act of 1882, which, however, does not apply to *absolute bills*. Section 4 of the act of 1878 defines a bill of sale as (1) including bills of sale, assignments, transfers, declarations of trust without transfer, inventories of goods with receipt thereto attached, or receipts for purchase moneys of goods and other assurances of personal chattels; the term assurance has been best explained as a document "on which the title of the transferee of the goods depends, either as the actual transfer of the property, or an agreement to transfer," *Marsden v. Mcadows*, 1881, 7 Q.B.D. 80; (2) powers of attorney, authorities or licences to take possession of personal chattels as security for any debt; these words would not include a power of distress for rent in an ordinary lease or bona fide hiring or hire purchase agreements; (3) any agreement, whether intended or not to be followed by the execution of any other instrument, by which a right in equity to any personal chattels, or to any charge or security thereon, shall be conferred; (4) any mode of disposition of trade machinery and attainments and other instruments giving powers of distress to secure a debt or advance. On the other hand, certain assurances and instruments are expressly exempt by statute from the definition: marriage settlements, assignments of ships, assignments for the benefit of creditors, bills of lading and dock warrants, and by the act of 1882, debentures and debenture stock of a company. The expression "personal chattels" is defined as goods, furniture and other articles capable of complete transfer by delivery, and (when separately assigned or charged) fixtures and growing crops.

Absolute Bills.—Absolute bills of sale must be duly attested by a solicitor, and the attestation must state that before execution the effect of it was explained to the grantor by the attesting solicitor. The consideration must be truly stated. The bill of sale, and all schedules and inventories annexed to or referred to in the bill, and also a true copy of the bill and of every schedule and inventory and of every attestation, together with an affidavit stating the time of making or giving the bill, its due execution and attestation and the residence and occupation of the grantor, and every attesting witness, must be presented to, and the copies filed by, the registrar within seven clear days. In the case of absolute bills the effect of non-compliance does not affect the validity of the bill as between the parties to it, but makes it void as against the trustee in bankruptcy and execution creditors of the grantor.

Bills by Way of Security.—All bills of sale given by way of security for the repayment of money must be made in accordance with the form given in the schedule to the act of 1882, and they must not depart from the statutory form in anything which is not merely a matter of verbal difference. The form given in the schedule to the act is as follows:—

This Indenture made the _____ day of _____ between A. B. of _____ of the one part and C. D. of _____ of the other part, witnesseth that in consideration of the sum of £ _____ now paid to A. B. by C. D., the receipt of which the said A. B. hereby acknowledges, he the said A. B. doth hereby assign unto C. D. his executors, administrators and assigns all and singular the several chattels and things specifically described in the schedule hereto annexed by way of security for the payment of the sum of £ _____ and interest thereon at the rate of _____ % per annum. And the said A. B. doth further agree and declare that he will duly pay to the said C. D. the principal sum aforesaid together with the interest then due, by equal payments of £ _____ on the _____ day of _____ And the said A. B. doth also agree with the said C. D. that he will (here insert terms as to insurance, payment of rent, &c.,

¹ *Non obstante* (notwithstanding) means a licence from the crown to do that which could not be lawfully done without it.

which the parties may agree to for the maintenance or defeasance of the security). Provided always that the chattels hereby assigned shall not be liable to seizure or to be taken possession of by the said C. D. for any cause other than those specified in § 7 of the Bills of Sale Act (1878) Amendment Act 1882.

In witness, &c.
Signed and sealed by the said A. B. in the presence of me E. F. (add witness's name, address and description).

Non-compliance with the requirement of the statute as to form renders a bill of sale void even as between the parties. The bill of sale must have annexed to it an inventory of the chattels comprised in it, and is void, except as against the grantor, in respect of any personal chattels not specifically described. It must be duly attested by one or more credible witnesses (not necessarily by a solicitor, as in the case of absolute bills). Every witness must sign his name, and add his address and description. It must be duly registered within seven clear days after the execution thereof, or if it is executed in any place out of England then within seven clear days after the time at which it would in the ordinary course of post arrive in England if posted immediately after the execution. It must truly set forth the consideration. The grantor must be the true owner of the goods described in the schedule; as to any personal chattels of which he is not the true owner, the bill is void, except as against the grantor. Every bill of sale made or given in consideration of any sum under £50 is void. By § 7 of the act personal chattels shall only be liable to be seized or taken possession of in the following cases—(1) if the grantor makes default in payment of the debt or in the performance of any covenant or agreement contained in the bill and necessary for maintaining the security; (2) if the grantor becomes a bankrupt or suffers the goods to be distrained for rent, rates or taxes; (3) if the grantor fraudulently removes the goods from the premises; (4) if the grantor does not, without reasonable excuse, upon demand in writing by the grantee, produce to him his last receipts for rent, rates or taxes; (5) if execution is levied against the goods of the grantor under any judgment. By § 13 personal chattels seized or taken possession of under a bill must not be removed or sold until after the expiration of five clear days from the date of seizure, and, if the goods have been wrongfully seized, the grantor may within the five days apply to the High Court or a judge in chambers for an order to restrain the grantee from removing or selling the goods. The Bills of Sale Acts 1878 and 1882 do not apply to Scotland or Ireland. According to Scots law no security or charge can be created over moveable property without delivery of possession. The Irish statutes corresponding to the English acts are the Bills of Sale (Ireland) Act 1879 and the Amendment Act 1883.

The stamp duties payable on an absolute bill of sale are 2s. 6d. on every £25 secured up to £300; over £300, 5s. 6d. on every £50. On bills of sale by way of security, 1s. 3d. for every £50 up to £300 secured; over £300, 2s. 6d. for every £100. The fees payable on filing a bill of sale are, where the consideration (including further advances) does not exceed £100; above £100 and not exceeding £200, 10s.; above £200, 11s.

The various trade protection papers always publish the registration of a bill of sale, and the usual effect is, therefore, to destroy the credit of any person giving one. (T. A. L.)

BILLROTH, ALBERT CHRISTIAN THEODOR (1829-1894), Viennese surgeon, was born on the 26th of April 1829 at Bergen, on the island of Rügen, his family being of Swedish origin. He studied at the universities of Greifswald, Göttingen and Berlin, and after taking his doctor's degree at the last in 1852, started on an educational tour, in the course of which he visited the medical schools of Vienna, Prague, Paris, Edinburgh and London. On his return to Berlin he acted as assistant to B. R. K. Langenbeck from 1853 to 1860, and then accepted the professorship of surgery at Zürich. In 1867 he was invited to fill the same position at Vienna, and in that city the remainder of his professional life was spent. In 1887 he received the distinction, rarely bestowed on members of his profession, of a seat in the Austrian *Herrnhaus*. He died at Abbazia, on the Adriatic, where he had a beautiful villa, on the 6th of February 1894. Billroth was one of the most distinguished surgeons of his day. His boldness as an operator was only equalled by his skill and resourcefulness; no accident or emergency could disturb his coolness and presence of mind, and his ability to invent or carry out any new procedure that might be demanded in the particular case with which he was dealing, gained for him the appellation of "surgeon of great initiatives." At the same time he was full of consideration for the comfort and well-being of his patient, and never forgot that he had before him a human being to be relieved, not a mere "case" for the display of technical dexterity. He was especially interested in military surgery, and during the Franco-German War volunteered to serve in the hospitals of

Mannheim and Weissenburg. His efforts did much to improve the arrangements for the transport and treatment of the wounded in war, and in a famous speech on the War Budget in 1891, he eloquently urged the necessity for an improved ambulance system, pointing out that the use of smokeless powder and the greater precision of the arms of modern warfare must tend to increase the number of men wounded, and that therefore more efficient means must be provided for removing them from the battlefield. Possessing a clear and graceful style, he was the author of numerous papers and books on medical subjects; his *Allgemeine chirurgische Pathologie und Therapie* (1863) ran through many editions, and was translated into many languages. He was of an exceedingly artistic disposition, and in particular was devoted to music. A good performer on the pianoforte and violin, he was an intimate friend and admirer of Brahms, many of whose compositions were privately performed at his house before they were published. His work on the physiology of music (*Wer ist musikalisch?*) was published after his death.

BILMA, or **KAWAR**, an oasis in the heart of the Sahara desert, some 60 m. long by 10 broad. The inhabitants are Tibbu and Kanuri. The name Bilma is properly confined to the southern part of this region, where is the chief settlement, called Bilma or Garu. This place is 800 m. due S. of the town of Tripoli and about 350 N. of the N.W. corner of Lake Chad. In the vicinity are a number of lakes, the waters of which on evaporation yield large quantities of very pure and fine salt, which is the object of an extensive trade with the countries of Central Africa. North of Bilma is the town of Dirki, said to date from the 11th century. Near Bilma is a small circular oasis, kept green by a fine spring, but immediately to the south begins the most dreary part of the Saharan desert, over which the caravans travel for fifteen days without discovering the slightest trace of vegetable life. Gustav Nachtigal, who visited Bilma in 1870, records that the temperature during the day rarely sank below 113° Fahr. By the Anglo-French Declaration of the 21st of March 1890 Bilma was included in the French sphere of influence in West Africa. Turkey claimed the oasis as part of the hinterland of Tripoli and garrisoned Bilma in 1902. In 1906, however, a French force from Zinder occupied the town, no opposition being offered by the Ottoman authorities. In 1907 the oasis and surrounding district was created a circle of the Military Territory of the Niger (see SAHARA).

BILNEY, THOMAS (d. 1531), English martyr, was born at or near Norwich. The exact date of his birth is uncertain, but at all events it was not before 1495. He was educated at Trinity Hall, Cambridge, graduating LL.B. and taking holy orders in 1519. Finding no satisfaction in the mechanical system of the schoolmen, he turned his attention to the edition of the New Testament published by Erasmus in 1516. "Immediately," he records, "I felt a marvellous comfort and quietness." The Scriptures now became his chief study, and his influence led other young Cambridge men to think along the same lines. Among his friends were Matthew Parker, the future archbishop of Canterbury, and Hugh Latimer. Latimer, previously a strenuous conservative, was completely won over, and a warm friendship sprang up between him and Bilney. "By his confession," said Latimer, "I learned more than in twenty years before." In 1525 Bilney obtained a licence to preach throughout the diocese of Ely. He denounced saint and relic worship, together with pilgrimages to Walsingham and Canterbury, and refused to accept the mediation of the saints. The diocesan authorities raised no objection, for, despite his reforming views in these directions, he was to the last perfectly orthodox on the power of the pope, the sacrifice of the mass, the doctrine of transubstantiation and the authority of the church. But Wolsey took a different view. In 1526 he appears to have summoned Bilney before him. On his taking an oath that he did not hold and would not disseminate the doctrines of Luther, Bilney was dismissed. But in the following year serious objection was taken to a series of sermons preached by him in and near London, and he was arrested and imprisoned in the Tower. Arraigned before Wolsey, Warham, archbishop of Canterbury,

and several bishops in the chapter-house at Westminster, he was convicted of heresy, sentence being deferred while efforts were made to induce him to recant, which eventually he did. After being kept for more than a year in the Tower, he was released in 1520, and went back to Cambridge. Here he was overcome with remorse for his apostasy, and after two years determined to preach again what he had held to be the truth. The churches being no longer open to him, he preached openly in the fields, finally arriving in Norwich, where the bishop, Richard Nix, caused him to be arrested. Articles were drawn up against him by Convocation, he was tried, degraded from his orders and handed over to the civil authorities to be burned. The sentence was carried out in London on the 10th of August 1531. A parliamentary inquiry was threatened in this case, not because parliament approved of Bilney's doctrine but because it was alleged that Bilney's execution had been obtained by the ecclesiastics without the proper authorization by the state. In 1534 Bishop Nix was condemned on this charge to the confiscation of his property. The significance of Bilney's execution lies in the fact that on essential points he was an orthodox Roman Catholic.

See *Letters and Papers of Henry VIII.* vols. iv.-v.; Foxe's *Acts and Monuments*; Gairdner's *History of the Church*; Pollard's *Henry VIII.* (A. F. P.)

BILOXI, a city of Harrison county, Mississippi, U.S.A., in the south part of the state, on Biloxi Bay, a branch of the Mississippi Sound, which is a part of the Gulf of Mexico. By rail it is 80 m. N.E. of New Orleans and 61 m. S.E. of Mobile, Alabama. Pop. (1880) 1540; (1890) 3234; (1900) 5467 (949 being negroes and 455 foreign-born); (1910) 7088. The city is served by a branch of the Louisville & Nashville railway, and by an electric railway extending to Bay St Louis, through Gulfport (pop., 1900, 2060; 1910, 6386), 13 m. S.W., the port of entry of the Pearl River customs district, whose exports, chiefly timber, lumber, naval stores and charcoal, were valued at \$8,392,271 in 1907. Biloxi is both a summer and a winter resort, particularly for the people of New Orleans and Mobile, and has a fine beach, extending for about 12 m. around its peninsula, and bordered by an automobile drive; along the beach are some attractive residences, hotels and boarding houses, and several sanatoriums. The city's principal industries are the canning of oysters, shrimp, fish, figs and vegetables, and the manufacture of fertilizers and flour. A beautiful thin faience with remarkable metallic glazes is made here. The municipality owns the water-works, the water being obtained from artesian wells. Pierre le Moyne d'Iberville (1661-1706) in 1699 built Fort Maurepas across the bay from the present city; and the settlement there, called Biloxi after the Biloxi Indians, was the first to be established by the French in this region. In 1702 this post, known as Old Biloxi, was abandoned, and the seat of government was removed to the Mobile river. In 1712 a settlement was made on the present site, being the first permanent settlement within what is now the state of Mississippi. Many of the early settlers were French Canadians, who came down the Mississippi to join the new colony. Biloxi was again the capital from 1719 until 1722. It was incorporated as a village in 1872, and was chartered as a city in 1896.

BILSTON, a market town of Staffordshire, England, 2½ m. S.E. of Wolverhampton and 124 N.W. of London, in the Black Country. Pop. of urban district (1901) 24,034. It is served by the Great Western railway, and by the London & North-Western at Ettingshall Road station. In the vicinity are very productive mines of coal and ironstone, as well as sand of fine quality for casting, and grinding-stones for cutlers. Bilston contains numerous furnaces, forges, rolling and slitting mills for the preparation of iron, and a great variety of factories for japanned and painted goods, brass-work and heavy iron goods. Though retaining no relics of antiquity, the town is very ancient, appearing in Domesday. The parish church of St Leonard, dating as it stands mainly from 1827, is on the site of a building of the 13th century. Bilston suffered severely from an outbreak of cholera in 1832. The town is within the parliamentary borough of Wolverhampton.

BILTONG, a South African Dutch word (from *bil*, buttock, and *long*, tongue), for sun-dried strips of antelope or buffalo meat.

BIMANA (Lat. "two-handed"), a word first used by the naturalist Johann Friedrich Blumenbach to distinguish the order of man from Quadrumana or other mammals. The term was popularized by Cuvier, and the majority of writers followed him in its adoption. In 1863, however, Huxley in his *Man's Place in Nature* demonstrated that the higher apes might fairly be included in Bimana. Again and again it has been proved that the human great toe can be by constant practice used as a thumb; artists exist who have painted pictures grasping the brush with their toes, and violinists have been known to play their instruments in the same manner. Among many savage races there is developed a remarkable power of foot-grasp, which in a lesser degree is often so noticeable among sailors. Haeckel calls attention to the fact that a baby can hold a spoon with the big-toe as with a thumb. Man, in a word, is potentially quadrumanous.

BIMETALLISM. The very general employment of both gold and silver for currency purposes (see MONEY) has given rise to serious practical difficulties which have in turn led to keen theoretical discussion as to the proper remedies to be employed. Though every arrangement under which two metals form the money of a region may be described as "bimetallism," the term—as often happens in economics—has received a specialized meaning. It denotes a system under which the two metals are freely received by the mint and are equally available as legal tender. The last clause implies the establishment of a definite ratio in value between the two metals (e.g. 1 oz. of gold = 15½ oz. of silver) so that the title "rated bimetallism" may be given to it, in contradistinction to the "unrated bimetallism" which exists wherever two metals circulate together, but have their relative values determined, not by law, but by "the higgling of the market." Further, the inventor of the term—H. Cernuschi in 1869—regarded it as properly applicable to an international arrangement by which a number of states agree to adopt the same ratio, rather than to the use of the two metals by a single country, which may be described as national bimetallism. International bimetallism is at all events the form which has attracted attention in recent times, and it is certainly the most important.

Regarded from the historical point of view it appears that the failure of separate countries to maintain the two metals in circulation was the cause which produced the idea of bimetallism as an international system. We find first the upholders of a national double standard, as in France and the United States, and these are followed by the advocates of bimetallism set up by a combination of countries. The theoretical considerations which underlie the controversy between the supporters and the opponents of bimetallism find their appropriate place in the article MONEY, as does also the earlier history of the double standard. The circumstances that have led to the prominence of the bimetallic question and the principal events that have marked the course of the movement form the subject of this article.

In the earlier years of the 19th century, when the monetary disturbances that resulted from the Revolutionary wars had ceased, we find France (1803) and the United States (1792) with the double standard legally established. England, on the other hand, had in 1816 accepted by law the gold standard, which had come into use in the 18th century. Silver formed the currency of the other European countries. The great discoveries of gold in California (1848) and Australia (1851) brought about the displacement of silver by gold in France, and the continuance of gold as the principal currency metal in the United States, where by the law of 1834 it had been somewhat over-rated (1:16), as compared with the ratio adopted in France (1:15½), and had therefore expelled most of the silver previously in circulation. Between 1848 and 1860 over £100,000,000 of gold was coined in France, while an equivalent amount of silver was exported, principally to the East.

At this time the weight of economic and official opinion was very decidedly in favour of the single gold standard as the best system. In 1865 the Latin Union was established, in which the French currency system was adopted and was followed by the

international conference of 1867 in Paris (see **MONEY CONFERENCES**), when gold was unanimously accepted as the standard for the proposed international system to be produced by co-ordinating the various currencies with that of the Latin Union.

A series of political and economic events speedily changed this situation. The Franco-German War (1870-71) deposed France from her leading position, and led to the establishment of a German gold currency with a different unit from the franc, accompanied by the demonetization of the silver currencies previously in use in the German states. The United States, where an inconvertible paper currency had been introduced during the Civil War, formally established the gold dollar as the standard coin (1873) and arranged for a return to specie payments (1878). At this time, too, the great production of gold which had marked the period 1850-1870 diminished, while very productive silver mines were discovered in the Pacific states of America. As a result of these combined influences the gold price of silver, which had risen a little during the height of the gold discoveries, began to fall rapidly, and the reverse process to that by which France had in the 'fifties acquired a gold currency came into operation. Silver, in accordance with *Gresham's Law*, was imported and offered for coinage. To obviate this the policy of limiting the coinage of silver (the *Limping Standard*) was adopted by the Latin Union. A further fall in the gold price of silver naturally resulted, and this made the position of Eastern trade and the finances of the Indian government insecure. American silver producers, and the German government, as holders of a large mass of demonetized silver, were also sufferers by the depreciation. The effect on public and official opinion was shown by the English parliamentary committee on the depreciation of silver (1876), the American silver commission of the same year, and the appearance of many works on the subject, most of them advocating the double standard. On the initiative of the United States an international monetary conference met in Paris in 1878, but though the necessity of keeping a place for silver in the money of the world was recognized, the proposal to adopt the double standard for general use was rejected by the European states. By the Bland-Allison Act (Feb. 1878) the United States had provided for the coinage of a certain amount of silver per month as a mode of keeping up the price of the metal, which notwithstanding fell to 48 pence per oz. in 1879. The prolonged depression of trade in America and Germany was attributed to the scarcity of money, due to what was described as "the outlawry of silver." By the joint action of France and the United States a fresh monetary conference was held in Paris in 1881, where the advocates of bimetalism were very strongly represented. After prolonged discussion no conclusion was reached, in consequence of the refusal of England and Germany to abandon the gold standard. Though an adjournment to the following year was resolved on, the conference did not reassemble, and the bimetallic movement took the form of agitation, carried on in each country. The English inquiry into the depression of trade (1885-1886) drew from the commission a recommendation for a fresh commission to investigate the relation of gold and silver. This latter body, appointed in 1886, obtained a great body of important evidence, and in 1888 closed its work by a report in which the views of the two sections of the commission were separately presented. Six members supported the existing gold standard and six were in favour of the bimetallic system. This inconclusive result was soon followed in the United States by the Sherman Act (1890), providing for a larger monthly coinage of silver. A temporary rise in the price of the metal was followed by a further fall, making the situation still more critical. A new monetary conference was summoned by the United States and met in Brussels in November 1892. To modify opposition the "desirability of increasing the use of silver" was the resolution proposed; the actual method being left open. This conference also proved abortive and adjourned to 1893, but like that of 1881 did not meet again.

International action having failed to secure any system of bimetalism, the United States and India sought to relieve their position by local legislation. The former repealed the Sherman

Act, and the latter closed its mints to the free coinage of silver (1893). As these measures were opposed to bimetalism in that they restricted the use of silver, and were followed by a lower price for that metal than had ever been known, the agitation in the United States and Europe continued. In America it took the form of advocating the free coinage of silver by the United States without waiting for other countries; and in this shape made the principal issue at the presidential elections of 1896 and 1900, in each of which it was emphatically rejected.

A further attempt at securing international bimetalism was made by Senator Wolcott's commission in 1897. The American envoys, in concert with the French government, proposed to England (1) the reopening of the Indian mints, and (2) the annual purchase by England of £10,000,000 of silver. The French minister claimed further concessions which were regarded as inadmissible by the English government; but the fate of the mission was settled by the refusal of the Indian government to reopen its mints.

After the American election of 1900, bimetalism as a popular cause disappeared from view. The silver issue was withdrawn from the democratic platform in 1904, and the bimetallic movement died out in England.

Amongst the causes of this collapse the most important are: (1) the adoption of the *gold standard* by so many countries—Austria-Hungary (1892), Russia and Japan (1897), India (1899), Mexico (1904)—a movement which pointed to the complete triumph of gold in the future; (2) the great increase in the output of gold. Australia and South Africa so developed their gold mines as to bring the yield for 1906 to £81,000,000 as contrasted with the less than £20,000,000 of 1883. This growing supply removed all that dread of a "gold famine" which served as a popular argument with bimetalists. To these may be added (3) the knowledge that experience had brought of the difficulties surrounding any attempt to establish a common ratio where the interests of different countries are so opposed; and (4) the great expansion of trade and industry, concomitantly with the wider adoption of the gold standard. Therefore, to quote the words of perhaps the ablest advocate of bimetalism, "The outcome of the prolonged controversy . . . appears to be that the commercial world will carry on its business principally and more and more on a gold basis, and that particular countries will endeavour in different ways to adjust their actual medium . . . to the gold standard" (Nicholson, *Money and Monetary Problems*, 6th ed.).

Perhaps the principal service rendered by the many able minds engaged in the movement will prove to be the fuller development of the more difficult parts of monetary theory and the additional light thrown on the course of monetary history.

A proposal, sometimes confounded with bimetalism, is that for a standard composed of both gold and silver, which is better described as the *Joint-standard* or as *Symmetlism*.

BIBLIOGRAPHY.—On the bimetallic side, Nicholson, *Money and Monetary Problems* (6th ed., 1903); F. A. Walker, *International Bimetalism* (1896); Barbour, *The Theory of Bimetalism* (1885); Lord Aldenham (H. H. Gibbs), *A Colloquy on Currency* (1900); and the numerous pamphlets and leaflets of the Bimetallic League. Opposed to bimetalism, Gilfen, *The Case against Bimetalism* (1892); Laughlin, *History of Bimetalism in the United States* (4th ed., 1897); Lord Farrer, *Studies in Currency* (1898); *The Gold Standard* (1898)—papers issued by the Gold Standard Defence Assoc. Leonard Darwin's *Bimetalism* aims at a judicial summary. See also **MONEY, MONETARY CONFERENCES**. (C. F. B.)

BIMLIPATAM, a town of British India, in the Vizagapatam district of Madras, on the sea-coast 18 m. N.E. of Vizagapatam. Pop. (1901) 10,212. It was formerly a Dutch factory, and is now the principal port of the district. The anchorage is an open roadstead protected to some extent by headlands with a lighthouse at Santapalli. Nearly half the sea-borne trade is conducted with foreign countries. The principal exports are oil-seeds, hides and jute.

BIN, a receptacle of various kinds, originally of wicker or basket work. The word appears in most European languages, cf. M.L. and Ital. *benna*, Ger. *Benne*, &c.; etymologists trace the word to a root meaning "to plait." It survives in various

connexions, e.g. dust-bin, wine-bin (for holding bottles), hop-bin, coal-bin, corn-bin.

BINAN, a town of the province of La Laguna, Luzon, Philippine Islands, on the W. shore of Laguna de Bay, about 20 m. S.S.E. of Manila. Pop. (1903) 9563. The town is surrounded by an extensive and extremely fertile plain which produces very large quantities of rice as well as a great variety of tropical fruits, and a ready market for these products is found in Manila whither they are shipped by boat. The language is Tagalog.

BINARY SYSTEM, in astronomy, a system composed of two stars revolving around each other under the influence of their mutual attraction. A distinction was formerly made between double stars of which the components were in revolution around each other, and those in which no relative motion was observed; but it is now considered that all double stars must really be binary systems.

BINCHOIS, EGIDIUS (d. 1466), an early 15th-century musical composer evidently named after his birthplace, Binche, near Mons. He was esteemed by contemporary and later theorists as second only to Dunstable and Dufay.

BINGEN (anc. *Vincum* or *Bingium*), a town of Germany, in the grand-duchy of Hesse-Darmstadt, 15 m. N.W. from Mainz, on the main line to Cologne. Pop. (1905) 9950. It is situated on the left bank of the Rhine opposite Rüdeshelm, at the confluence of the Nahe (or Nava), which is crossed near its mouth by a stone bridge, attributed to Drusus, and certainly of Roman origin, and an iron railway bridge. On a height immediately to the south-east is the ruined castle of Klopp, on the site of a fortress founded by Drusus, and higher still the celebrated chapel of St Roch (rebuilt in 1805 after a fire), where thousands of pilgrims gather on the first Sunday after the 16th of August. Apart from its situation, which renders it a convenient place of tourist resort, the town itself presents but few attractions. There are a Protestant and three Roman Catholic churches, among the latter the parish church with a crypt dating from the 11th century, and a medieval town hall. It has a considerable commerce in wine, grain and cattle, and, new quays and a harbour having been recently constructed, does an extensive transit trade in coal and iron. A short way down the Rhine is the Bingerloch, a famous whirlpool, while about halfway between it and the town rises on a rock in the middle of the stream the *Mäuseturm* (derived from *Muserie*, cannon), in which, according to legend, Archbishop Hatto II. of Mainz was in 960 eaten by mice (the legend being doubtless due to the erroneous derivation from *Mäuse*, mice). Another legend states that the Nibelung treasure is hidden hereabouts in the Rhine.

BINGERBRÜCK, a town of Germany, in the Prussian Rhine province, at the confluence of the Nahe and the Rhine, lying just below Bingen, and at the junction of the main lines of railway—Mainz-Coblenz and Bingerbrück-Metz. It has an extensive trade in the wines of the district. Pop. 2500.

BINGHAM, JOSEPH (1668-1723), English scholar and divine, was born at Wakefield in Yorkshire in September 1668. He was educated at University College, Oxford, of which he was made fellow in 1689 and tutor in 1691. A sermon preached by him from the university pulpit, St Mary's, on the meaning of the terms "Person" and "Substance" in the Fathers, brought upon him a most unjust accusation of heresy. He was compelled to give up his fellowship and leave the university; but he was immediately presented by Dr John Radcliffe to the rectory of Headbournworthy, near Winchester (1695). In this country retirement he began his laborious and valuable work entitled *Origines Ecclesiasticae*, or Antiquities of the Christian Church, the first volume of which appeared in 1708 and the tenth and last in 1722. His design, learnedly, exhaustively and impartially executed, was "to give such a methodical account of the antiquities of the Christian Church as others have done of the Greek and Roman and Jewish antiquities, by reducing the ancient customs, usages and practices of the church under certain proper heads, whereby the reader may take a view at once of any particular usage or custom of Christians for four or five centuries." Notwithstanding his learning and merit, Bingham received no

higher preferment than that of Headbournworthy till 1712, when he was collated to the rectory of Havant, near Portsmouth, by Sir Jonathan Trelawney, bishop of Winchester. Nearly all his little property was lost in the great South Sea Bubble of 1720. He died on the 17th of August 1723.

BINGHAMTON, a city and the county-seat of Broome county, New York, U.S.A., in the south part of the state, on both banks of the north branch of the Susquehanna river, at the mouth of the Chenango river. Pop. (1880) 17,317; (1890) 35,005; (1900) 39,647, of whom 4272 were foreign-born; (1910), 48,443. It is an important railway centre, being served by the Delaware & Hudson, the Erie, and the Delaware, Lackawanna & Western railways; and an extensive system of electric railways connects it with the suburbs and neighbouring towns. Binghamton is picturesquely situated and has a number of parks, the most attractive of which are Ross Park of 100 acres and Ely Park of 134 acres. Among the principal buildings are the city hall, the court-house, the post-office, the Binghamton city hospital, Stone opera-house, the Carnegie library (1904), the central high school, and a state armoury. Binghamton has also some fine office buildings. Among the city's educational and charitable institutions are the Lady Jane Grey school (for girls), St Joseph's academy, St Mary's home for orphans, the Susquehanna Valley orphan asylum, and a state hospital for the insane. Binghamton is a manufacturing centre of considerable importance, ranking twelfth in the state in 1905 in the value of factory products, \$13,907,403, which was an increase of 32.0% over the value of the factory products in 1900; among its manufactures are tobacco, cigars, chewing tobacco and snuff (value in 1905, \$2,879,217), patent medicines (value in 1905, \$2,133,198), sugar and grist mill products (\$1,089,910), men's clothing (\$833,835), and, of less importance, commercial and computing scales and time recorders, chemicals, distilled liquor, beer, fire-alarm apparatus, overalls, agricultural implements, wagons, electrical apparatus, refined oil, sheet metal, paper bags and envelopes, tacks and nails, window glass, glass-ware, clocks, whips and furniture (especially Morris chairs). In the village of Lestershire (pop. in 1910, 3775; incorporated in 1892), about 2 m. west, and in Endicott, another suburb, are large boot and shoe factories. The municipality owns and operates the water-works. When Binghamton was first settled, about 1787, it was known as Chenango Point. Its site was originally included in the so-called "Bingham Patent," a tract on both sides of the Susquehanna river owned by William Bingham (1751-1804), a Philadelphia merchant, who was a member of the Continental Congress in 1787-1788 and of the United States Senate in 1795-1801, being president *pro tempore* of the Senate from the 16th of February to the 3rd of March 1797. In 1800 a village was laid out by an agent of Mr Bingham, and was named Binghamton. In 1834 it was incorporated as a village, and in 1867 was chartered as a city.

BINGLEY, a market town in the Otley parliamentary division of the West Riding of Yorkshire, England, on the Aire, 5½ m. N.W. of Bradford, on the Midland railway. Pop. of urban district (1901) 18,449. The church of All Saints is good perpendicular, though considerably restored. The large industrial population is engaged principally in the worsted and cotton manufacture. The neighbourhood is populous, but the natural beauty of the Aire valley is not greatly impaired.

BINIOU, or **BIGNOU**, a species of cornemuse or bagpipe, still in use at the present day in Brittany. The binioù is a primitive kind of bagpipe consisting of a leather bag inflated by means of a short valved insufflation tube or blow-pipe, a chanter with conical bore furnished with a double reed concealed within the stock or socket (see BAG-PIPE), and seven holes, the first being duplicated to accommodate left- and right-handed players.

The scale of the binioù is usually 

¹ See Victor Mahillon, *Catalogue descriptif*, vol. II. (Ghent, 1896), p. 353, No. 1126; and Captain C. R. Day, *Descriptive Catalogue of Musical Instruments* (London, 1891), p. 62, No. 135.

and the single drone is tuned to the lower octave of the first hole 

The more primitive biniou, still occasionally found in the remote districts of Cornouailles and Morbihan, has a chaunter with but five holes,¹ giving part of the scale of D, the drone being also tuned to D. The drone of the biniou is of box-wood, handsomely inlaid with tin, and has a single or beating reed hidden within the stock.

The word biniou or bignou (a Gallicized form), often erroneously derived from *bigno*, *se renfler beaucoup*—an etymology not supported by Breton dictionaries—is the Breton plural form of *benek*, instrument, tool, i. e. *biniou*, *binvijou*.² The word is also found in the phrase, "*Sac'h ar biniou*" (a biniou bag), a bag used by weavers to hold their tools, spindles, &c. The biniou is still the traditional and popular instrument of the Breton peasants of Cornouailles and Morbihan, and is almost inseparable from the bombard (*q.v.*), which is no other than a survival of the medieval musette, hautbois or chalmé, formerly associated with the bag-pipe in western Europe (see *ONOE*). At all festivals, at the *pardons*, wedding feasts and threshing dances, the two traditional musicians or *sonneurs* give out in shrill penetrating tones the ancient Breton *rondes*³ and melodies.

BINMALEY, a town of the province of Pangasinán, Luzon, Philippine Islands, on the delta of the Agno river, about 5 m. W. of Dagupan, the north terminus of the Manila & Dagupan railway. Pop. (1903) 16,439. It has important fisheries, and manufactures salt, pottery, roofing (made of nipa leaves), and nipa wine. Rice and coconuts are the principal agricultural products of the town.

BINNACLE (before 18th century *bitacle*, through Span. *bitacula*, from Lat. *habituaculum*, a little dwelling), a case on the deck of a ship, generally in front of the steersman, in which is kept a compass, and a light by which the compass is read at night.

BINNEY, EDWARD WILLIAM (1812-1881), English geologist, was born at Morton, in Nottinghamshire, in 1812. He was articled to a solicitor in Chesterfield, and in 1836 settled at Manchester. He retired soon afterwards from legal practice and gave his chief attention to geological pursuits. He assisted in 1838 in founding the Manchester Geological Society, of which he was then chosen one of the honorary secretaries; he was elected president in 1857, and again in 1865. He was also successively secretary and president of the Literary and Philosophical Society of Manchester. Working especially at the Carboniferous and Permian rocks of the north of England, he studied also the Drift deposits of Lancashire, and made himself familiar with the geology of the country around Manchester. On the Coal Measures in particular he became an acknowledged authority, and his *Observations on the Structure of Fossil Plants found in the Carboniferous Strata* (1868-1875) formed one of the monographs of the Palaeontographical Society. His large collection of fossils was placed in Owens College. He was elected a fellow of the Royal Society in 1856. He died at Manchester on the 10th of December 1881.

BINNEY, HORACE (1780-1875), American lawyer, was born in Philadelphia, Pennsylvania, on the 4th of January 1780. He graduated at Harvard College in 1797, and studied law in the office of Jared Ingersoll (1740-1822), who had been a member of the Constitutional convention of 1787, and who from 1791 to 1800 and again from 1811 to 1816 was the attorney-general of Pennsylvania. Admitted to the bar in Philadelphia in 1800, Binney practised with great success for half a century, and was recognized as one of the leaders of the bar in the United States. He served in the Pennsylvania legislature in 1806-1807, and was a Whig member of the National House of Representatives from 1833 until 1835, ably defending the United States Bank, and in general opposing the policy of President Andrew Jackson. His

¹ See N. Quellien, *Chansons et danses des Bretons* (Paris, 1889), p. 39, and note, where the description of the instrument is not technical.

² See L. Gonidec, *Dictionnaire breton-français*, ed. by T. Hersart de la Villemarqué; and N. Quellien, *op. cit.* p. 37, note.

³ For examples of these see N. Quellien, *op. cit.* part ii.

most famous case, in which he was unsuccessfully opposed by Daniel Webster, was the case of *Bidal v. Girard's Executors*, which involved the disposition of the fortune of Stephen Girard (*q.v.*). Binney's argument in this case greatly influenced the interpretation of the law of charities. Binney made many public addresses, the most noteworthy of which, entitled *Life and Character of Chief Justice Marshall*, was published in 1835. He also published *Leaders of the Old Bar of Philadelphia* (1858), and an *Inquiry into the Formation of Washington's Farewell Address* (1850); and during the Civil War he issued three pamphlets (1861, 1862 and 1865), discussing the right of *habeas corpus* under the American Constitution, and justifying President Lincoln in his suspension of the writ.

See the *Life of Horace Binney* (Philadelphia, 1904), by his grandson, C. C. Binney.

BINNEY, THOMAS (1798-1874), English Congregationalist divine, was born of Presbyterian parents at Newcastle-on-Tyne in 1798, and educated at an ordinary day school. After spending seven years in the employment of a bookseller he entered the theological school at Wymondley, Herts, now incorporated in New College, Hampstead. In 1829, after short pastorates at Bedford (New Meeting) and Newport, Isle of Wight, he accepted a call to the historic Weigh House chapel, London. Here he became very popular, and it was found necessary to build a much larger chapel on Fish Street Hill, to which the congregation removed in 1834. An address delivered on the occasion of the laying of the foundation stone was published, with an appendix containing a strong attack on the influence of the Church of England, which gave rise to a long and bitter controversy. Throughout his whole career Binney was a vigorous opponent of the state church principle, but those who simply classified him as a narrow-minded political dissenter did him injustice. His liberality of view and breadth of ecclesiastical sympathy entitle him to rank on questions of Nonconformity among the most distinguished of the school of Richard Baxter; and he maintained friendly relations with many of the dignitaries of the Established Church. He continued to discharge the duties of the ministry until 1869, when he resigned. In 1845 he paid a visit to Canada and the United States, and in 1857-1859 to the Australian colonies. The university of Aberdeen conferred the LL.D. degree on him in 1852, and he was twice chairman of the Congregational Union of England and Wales.

Binney was the pioneer in a much-needed improvement of the forms of service in Nonconformist churches, and gave a special impulse to congregational psalmody by the publication of a book entitled *The Service of Song in the House of the Lord*. Of numerous other works the best-known is his *Is it Possible to Make the Best of Both Worlds?* an expansion of a lecture delivered to young men in Exeter Hall, which attained a circulation of 30,000 copies within a year of its publication. He wrote much devotional verse, including the well-known hymn "Eternal Light! Eternal Light!" His last sermon was preached in November 1873, and after some months of suffering he died on the 24th of February 1874. Dean Stanley assisted at his funeral service in Abney Park cemetery.

BINOCULAR INSTRUMENT, or briefly **BINOCULAR**,⁴ an apparatus through which objects are viewed with both eyes. In this article only those instruments will be considered in which solid objects or *objects in space* are viewed; reference should be made to the article **STEREOSCOPE** for the instruments in which *plane* representations are offered to both eyes. The natural vision is such that different central projections of the objects are communicated to both eyes; the difference of the two perspective representations arises from the fact that the projection centres are laterally separated by an interval about equal to the distance between the eyes (the inter-pupillary distance). Binocular instruments should aid the natural spatial or stereoscopic vision, or make it possible if the eyes fail. If the objects be so far

⁴ The term binocular (from the Lat. *binī*, two at a time, and *oculi*, eyes) was originally an adjective used to describe things adapted for the simultaneous use of both eyes, as in "binocular vision," "a binocular telescope or microscope"; now "a binocular" is used as a noun, meaning a binocular microscope, a field-glass, &c.

distant that the two perspectives formed by the naked eye are no more distinguished from each other, recourse may be had to binocular telescopes and range-finders; and if the objects be so small that, in order to observe details on them, we must bring our eyes so close to the objects that they cannot accommodate the images, recourse may be had to binocular microscopes and magnifying glasses.

The construction of binocular instruments dates back over several centuries, and has now been brought to great perfection. The subject of their theory and history has been exhaustively treated by M. von Rohr, *Die binokularen Instrumente* (Berlin, 1907), the first publication to present a complete account of these instruments.

Binocular Instruments for Observation only.—The first binocular telescope, consisting of two telescopes placed side by side, was constructed in 1608 by Johann Lipperhey, the inventor of the ordinary or Dutch telescope. The subject was next taken up by the monks. The Capuchin Antonius Maria Schyrliäus (Schyrl) de Rheita (1597–1660) described in 1645 the construction of double terrestrial telescopes. Greater success

attended the efforts of the Capuchin Chérubin d'Orléans, who flourished at about the same time, and constructed large double telescopes of the Dutch type of high magnification, for use in war, and smaller instruments of lower magnification; these instruments were provided with mechanism for adjusting to the interval between the eyes of the observer (fig. 1). After these discoveries the subject received no more attention until the 19th century; no improvements of these instruments are recorded in the literature of the second half of the 18th century.



FIG. 1.

who, in 1825, took out a French patent for an improvement of the Dutch double telescope. Lemière's instruments were furnished with a common focusing arrangement, and the adapting to the inter-pupillary distance was effected by

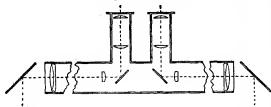

FIG. 2.

turning the two parallel telescopes round their common axis. The development of this instrument was studied by opticians for the remainder of the first half of the 19th century; the last improvement apparently was made by P. G. Bardou in 1854, and by H. Helmholtz in 1857 when he described the telescope (fig. 2) with telescopic magnification. By utilizing the telescope with prism-inversion, devised in 1851 by Ignazio Porro (1795–1875), A. A. Boulanger succeeded in producing a binocular of an entirely new type in 1859 (fig. 3). But he overlooked the possibility of increasing the distance between the objectives; Camille Nachat introduced this improvement in 1875, but his instruments did not meet with much popularity. This was probably due to the fact that, at this time,

the manufacture of the glass for the prisms was too difficult; this was overcome by E. Abbe, after the founding of the glass-works at Jena, who effected, independently of his predecessors, the wider separation of the objectives (fig. 4), and increased it in the telescope (fig. 5), or relief telescope, in a manner nearly approaching to Helmholtz's proposal.

The first binocular microscope was invented by the previously mentioned Father Chérubin, whose instrument consisted of two inverting systems, and consequently gave a totally wrong impression of depth, i.e. depressions appeared as elevations, and vice versa, or, as we must say after Charles Wheatstone, it presented a pseudoscopic impression; this quality, however, was not recognized by the microscopists of the time. The instrument subsequently fell into complete neglect for nearly two centuries, to be revived in 1852 by Charles Wheatstone, who has stated that he had previously studied the problem; the publication of his views in his second great paper "On Binocular Vision,"¹ in the *Phil. Trans.* for 1852, undoubtedly stimulated the investigation of this instrument, which was carried on with zeal and success more especially in England and the United States. In 1853 the American J. L. Riddell (1807–1867) devised his binocular microscope, which contained the essentials of Wheatstone's pseudoscope. F. H. Wenham, another constructor, did not at first succeed in avoiding the pseudoscopic effect, but, by the application of *refracting* dividing prisms, he subsequently arrived at orthoscopic representations and continued the development of the different methods for producing micro-photographic stereograms; this was effected in the first case by placing a diaphragm over one half of the objective for each exposure, and in the second case by a suitable direction of the illuminating pencil (fig. 6). Of greater benefit, however, for stimulating interest in binocular microscopes, was his invention of *reflecting* dividing prisms (fig. 7). Other experiments, begun by Powell and Lealand, and developed with greater skill by Wenham, were concerned with the binocular vision of identical images. Such an impression could not possibly be stereoscopic, and these experiments

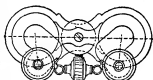
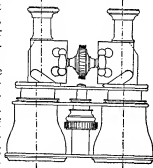

FIG. 3.

undoubtedly stimulated the investigation of this instrument, which was carried on with zeal and success more especially in England and the United States. In 1853 the American J. L. Riddell (1807–1867) devised his binocular microscope, which contained the essentials of Wheatstone's pseudoscope. F. H. Wenham, another constructor, did not at first succeed in avoiding the pseudoscopic effect, but, by the application of *refracting* dividing prisms, he subsequently arrived at orthoscopic representations and continued the development of the different methods for producing micro-photographic stereograms; this was effected in the first case by

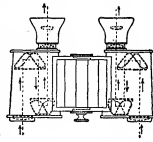

FIG. 4.

placing a diaphragm over one half of the objective for each exposure, and in the second case by a suitable direction of the illuminating pencil (fig. 6). Of greater benefit, however, for stimulating interest in binocular microscopes, was his invention of *reflecting* dividing prisms (fig. 7). Other experiments, begun by Powell and Lealand, and developed with greater skill by Wenham, were concerned with the binocular vision of identical images. Such an impression could not possibly be stereoscopic, and these experiments

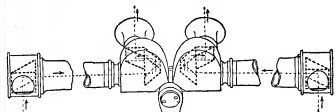

FIG. 5.

led to the construction of a non-stereoscopic binocular microscope. Of the other workers in this field mention may be made

¹ The first part appeared in 1838.

of Alfred Nacht, who in 1853, and subsequently in 1863, brought forward two forms of binocular microscope.

The earliest stages of the development of the binocular microscope had been always confined to those instruments with one objective, in the immediate neighbourhood of which the systems for dividing the pencil were placed. At a later date attempts were made to separate the two halves of the objective by modifying the eye-piece; this led to the construction of stereoscopic eye-pieces, initiated by R. B. Tolles, E. Abbe and A. Prazmowski. Of special importance is the work of Abbe; although, as he himself has stated, his methods accidentally led to the Wenham system, he certainly was far above his predecessors in his theoretical treatment of the problem, and in the perspicuity and clearness of his explanation. To him is also due the re-establishment of the instruments, which Wenham had abandoned by reason of too great technical difficulties (fig. 8). The newest form of the binocular microscope is very similar to the oldest form in which two completely separated

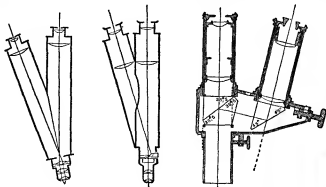

FIG. 6.

FIG. 7.

FIG. 8.

tubes were employed. The inventor, H. S. Greenough, employs two systems for setting up the image, in order to avoid the pseudoscopic effect. After experiments in the Zeiss works, the erecting of Porro's prisms simultaneously permitted a convenient adaptation to the eye-distance of the observer.

The first binocular magnifying glass or simple microscope (German, *Lupe*) was devised by J. L. Riddell in 1853; in this instrument (fig. 9) the pencil of light is transmitted to the eyes by means of two pairs of parallel mirrors.

Simple microscope.

Of the many different improvements mention may be made of A. Nacht's. H. Westien made use of two Chevalier-Brücke's simple microscopes with their long working distances in order to form an instrument in which the curvature

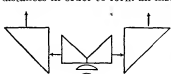

FIG. 9.

of the image was not entirely avoided. Mention may also be made of the binoculars of K. Fritsch (formerly Proschke) and E. Berger.

Binocular Instruments for Range-finding.—For measuring purposes binocular telescopes with parallel axes are

the only types employed. The measurement is effected by adjoining to the space or interval to be measured some means of measurement defined; for example, by a fixed scale which extends into the space, or by a movable point (*Wandermarke*). This instrument shows a transition to the stereoscope, inasmuch as the scale or means of measurement is not directly observed, but to each eye a plane representation is offered, just as in the stereoscope; the space to be measured, on the other hand, is portrayed in exactly the same way as in the double telescope. The method for superposing the two spaces on one another was deduced by Sir David Brewster in 1856, but he does not appear to have dealt with the problem of range-finding. The problem was attacked in 1861 by A. Rollet; later, in 1866, E. Mach published a promising idea, and finally—independently of the researches of his predecessors—Hektor de Groussillers, in

partnership with the Zeiss firm (E. Abbe and C. Pulfrich), constructed the first stereoscopic range-finder suitable for practical use. (O. Hr.)

BINOMIAL (from the Lat. *bi-*, *bis*, twice, and *nomen*, a name or term), in mathematics, a word first introduced by Robert Recorde (1557) to denote a quantity composed of the sum or difference to two terms; as $a+b$, $a-b$. The terms trinomial, quadrinomial, multinomial, &c., are applied to expressions composed similarly of three, four or many quantities.

The *binomial theorem* is a celebrated theorem, originally due to Sir Isaac Newton, by which any power of a binomial can be expressed as a series. In its modern form the theorem, which is true for all values of n , is written as $(x+a)^n = x^n + nax^{n-1} + \frac{n \cdot n-1}{1 \cdot 2} a^2 x^{n-2} + \frac{n \cdot n-1 \cdot n-2}{1 \cdot 2 \cdot 3} a^3 x^{n-3} \dots + a^n$. The reader is referred to the article ALGEBRA for the proof and applications of this theorem; here we shall only treat of the history of its discovery.

The original form of the theorem was first given in a letter, dated the 13th of June 1676, from Sir Isaac Newton to Henry Oldenbourg for communication to Wilhelm G. Leibnitz, although Newton had discovered it some years previously. Newton

there states that $(p+pq)^m = p^m + \frac{m}{n} aq + \frac{m \cdot n-1}{2n} a^2 q^2 + \frac{m \cdot n-2}{3n} a^3 q^3 \dots$, &c., where $p+pq$ is the quantity whose $\frac{m}{n}$ th power or root is required, p the first term of that quantity, and q the quotient of the rest divided by p ; $\frac{m}{n}$ the power, which may be a positive or negative integer or a fraction, and a , b , c , &c., the several terms in order, e.g. $a = p^{\frac{m}{n}}$, $b = \frac{m}{n} aq$, $c = \frac{m \cdot n-1}{2n} a^2 q^2$, and so on.

In a second letter, dated the 24th of October 1676, to Oldenbourg, Newton gave the train of reasoning by which he devised the theorem.

"In the beginning of my mathematical studies, when I was perusing the works of the celebrated Dr Wallis, and considering the series by the interpolation of which he exhibits the area of the circle and hyperbola (for instance, in this series of curves whose common base or axis is x , and the ordinates respectively $(1-xx)^{\frac{1}{2}}$, $(1-xx)^{\frac{1}{3}}$, $(1-xx)^{\frac{1}{4}}$, &c.) I perceived that if by the areas of the alternate curves, which are $x - \frac{1}{2}x^2$, $x - \frac{1}{3}x^3$, $x - \frac{1}{4}x^4$, $x - \frac{1}{5}x^5$, &c., could be interpolated, we should obtain the areas of the intermediate ones, the first of which $(1-xx)^{\frac{1}{2}}$ is the area of the circle. Now in order to [do] this, it appeared that in all the series the first term was x ; that the second terms $\frac{1}{2}x^2$, $\frac{1}{3}x^3$, $\frac{1}{4}x^4$, &c., were in arithmetical progression; and consequently that the first two terms of all the series to be interpolated would be $x - \frac{1}{3}x^3$, $x - \frac{1}{3}x^3$, $x - \frac{1}{3}x^3$, &c.

"Now for the interpolation of the rest, I considered that the denominators 1, 3, 5, &c., were in arithmetical progression; and that therefore only the numerical coefficients of the numerators were to be investigated. But these in the alternate areas, which are given, were the same with the figures with which the several powers of 11 consist, viz., of 1st, 1st, 1st, 1st, 1st, &c., that is, the first 1; the second, 1, 1; the third, 1, 2, 1; the fourth 1, 3, 3, 1; and so on. I enquired therefore how, in these series, the rest of the terms may be derived from the first two being given; and I found that by putting m for the second figure or term, the rest should be produced by the continued multiplication of the terms of this series $\frac{m-0}{1} \times \frac{m-1}{2} \times \frac{m-2}{3} \dots$, &c. . . This rule I therefore applied to the series to be interpolated.

And since, in the series for the circle, the second term was $\frac{1}{3}x^3$, I put $m = \frac{1}{2}$. . . And hence I found the required area of the circular segment to be $x - \frac{1}{3}x^3 + \frac{1}{5}x^5 - \frac{1}{7}x^7$, &c. . . And in the same manner might be produced the interpolated areas of other curves; as also the area of the hyperbola and the other alternates in this series $(1+xx)^{\frac{1}{2}}$, $(1+xx)^{\frac{1}{3}}$, $(1+xx)^{\frac{1}{4}}$, &c. . . Having proceeded so far, I considered that the terms $(1-xx)^{\frac{1}{2}}$, $(1-xx)^{\frac{1}{3}}$, $(1-xx)^{\frac{1}{4}}$, &c., that is 1, $1-x^2$, $1-2x^2+x^4$, $1-3x^2+3x^4-x^6$, &c., might be interpolated in the same manner as the areas generated by them, and for this, nothing more was required than to omit the denominators 1, 3, 5, 7, &c., in the terms expressing the areas; that is, the coefficients of the terms of the quantity to be interpolated $(1-xx)^{\frac{1}{2}}$ or $(1-xx)^{\frac{1}{3}}$, or generally $(1-xx)^{\frac{1}{n}}$ will

be produced by the continued multiplication of this series

$$m \times \frac{m-1}{3} \times \frac{m-2}{4} \times \frac{m-3}{4} \dots \&c."$$

The binomial theorem was thus discovered as a development of John Wallis's investigations in the method of *interpolation*. Newton gave no proof, and it was in the *Arx Conjectandi* (1713) that James Bernoulli's proof for positive integral values of the exponent was first published, although Bernoulli must have discovered it many years previously. A rigorous demonstration was wanting for many years, Leonhard Euler's proof for negative and fractional values being faulty, and was finally given by Niels Henrik Abel.

The *multi- (or poly-) nomial theorem* has for its object the expansion of any power of a multinomial and was discussed in 1697 by Abraham Demoivre (see COMBINATORIAL ANALYSIS).

REFERENCES.—For the history of the binomial theorem, see John Collins, *Commercium Epistolicum* (1712); S. P. Rigaud, *The Correspondence of Scientific Men of the 17th Century* (1841); M. Cantor, *Geschichte der Mathematik* (1894-1901).

BINTURONG (*Arctictis binturong*), the single species of the viverrine genus *Arctictis*, ranging from Nepal through the Malay Peninsula to Sumatra and Java. This animal, also called the bear-cat, is allied to the palm-civets, or paradoxoures, but differs from the rest of the family (*Viverridae*) by its tufted ears and long, bushy, prehensile tail, which is thick at the root and almost equals in length the head and body together (from 28 to 33 inches). The fur is long and coarse, of a dull black hue with a grey wash on the head and fore-limbs. In habits the binturong is nocturnal and arboreal, inhabiting forests, and living on small vertebrates, worms, insects and fruits. It is said to be naturally fierce, but when taken young is easily tamed and becomes gentle and playful.

BINYON, LAURENCE (1869-), English poet, born at Laneaster on the 10th of August 1869, was educated at St Paul's school, London, and Trinity College, Oxford, where he won the Newdigate prize in 1890 for his *Persephone*. He entered the department of printed books at the British Museum in 1893, and was transferred to the department of prints and drawings in 1895, the *Catalogue of English Drawings in the British Museum* (1898, &c.) being by him. As a poet he is represented by *Lyric Poems* (1894), *Poems* (Oxford, 1895), *London Visions* (2 vols., 1895-1898), *The Praise of Life* (1896), *Porphyron and other Poems* (1898), *Odes* (1900), *The Death of Adam* (1903), *Penthesilea* (1905), *Dream come true* (1905), *Paris and Oenone* (1906), a one-act tragedy, and *Attila*, a poetical drama (1907); as an art critic by monographs on the 17th-century Dutch etchers, on John Crome and John Sell Cotman, contributed to the *Portfolio*, &c. In 1906 he published the first volume of a series of reproductions from William Blake, with a critical introduction.

See also R. A. Streetfield, *Two Poets of the New Century* (1901), and W. Archer, *Poets of the Younger Generation* (1902).

BIO-BIO, a river of southern Chile, rising in the Pico Hachado pass across the Andes, 38° 45' S. lat., and flowing in a general north-westerly direction to the Pacific at Concepción, where it is 2 m. wide and forms an excellent harbour. It has a total length of about 225 m., nearly one half of which is navigable.

BIO-BIO, an inland province of southern Chile, bounded N., W. and S. respectively by the provinces of Concepción, Arauco and Malleco, and E. by Argentina. It has an area of 5246 sq. m. of well-wooded and mountainous country, and exports timber to a large extent. The great trunk railway from Santiago S. to Puerto Montt crosses the western part of the province and also connects it with the port of Concepción. The capital, Los Angeles (est. pop. 7777 in 1902) lies 15½ m. E. of this railway and is connected with it by a branch line.

BIOGENESIS (from the Gr. *bios*, life, and *genesis*, generation, birth), a biological term for the theory according to which each living organism, however simple, arises by a process of budding, fission, spore-formation of sexual reproduction from a parent organism. Under the heading of **ABIOTENESIS** (q.v.) is discussed the series of steps by which the modern acceptance of biogenesis and rejection of abiogenesis has been brought

about. No biological generalization rests on a wider series of observations, or has been subjected to a more critical scrutiny than that every living organism has come into existence from a living portion or portions of a pre-existing organism. In the articles **REPRODUCTION** and **HEREDITY** the details of the relations between parent and offspring are discussed. There remains for treatment here a curious collateral issue of the theory. It is within common observation that parent and offspring are alike: that the new organism resembles that from which it has come into existence; in fine, biogenesis is homogenesis. Every organism takes origin from a parent organism of the same kind. The conception of homogenesis, however, does not imply an absolute similarity between parent and organism. In the first place, the normal life-cycle of plants and animals exhibits what is known as alternation of generations, so that any individual in the chain may resemble its grand-parent and its grand-child, and differ markedly from its parent and child. Next, any organism may pass through a series of free-living larval stages, so that the new organism at first resembles its parent only very remotely, corresponding to an early stage in the life-history of that parent. (See **EMBRYOLOGY**, **LARVAL FORMS** and **REPRODUCTION**.) Finally, the conception of homogenesis does not exclude the differences between parent and offspring that continually occur, forming the material for the slow alteration of stocks in the course of evolution (see **VARIATION** and **SELECTION**). Homogenesis means simply that such organism comes into existence directly from a parent organism of the same race, and hence of the same species, sub-species, genus and so forth.

From time to time there have been observers who have maintained a belief in the opposite theory, to which the name heterogenesis has been given. According to the latter theory, the offspring of a given organism may be utterly different from itself, so that a known animal may give rise to another known animal of a different race, species, genus, or even family, or to a plant, or vice versa. The most extreme cases of this belief is the well-known fable of the "barnacle-geese," an illustrated account of which was printed in an early volume of the Royal Society of London. Buds of a particular tree growing near the sea were described as producing barnacles, and these, falling into the water, were supposed to develop into geese. The whole story was an imaginary embroidery of the facts that barnacles attach themselves to submerged timber and that a species of goose is known as the bernicle goose. In modern times the exponents of heterogenesis have limited themselves to cases of microscopic animals and plants, and in most cases, the observations that they have brought forward have been explained by minuter observation as cases of parasitism. No serious observer, acquainted with modern microscopic technical methods, has been able to confirm the explanation of their observations given by the few modern believers in heterogenesis. (P. C. M.)

BIOGRAPHY (from the Gr. *bios*, life, and *γραφία*, writing), that form of history which is applied, not to races or masses of men, but to an individual. The earliest use of the word *βιογραφία* is attributed to Damascius, a Greek writer of the beginning of the 6th century, and in Latin *biographia* was used, but in English no earlier employment of the word, "biography" has been traced than that of Dryden in 1683, who uses it to describe the literary work of Plutarch, "the history of particular men's lives." It is obvious that this definition is necessary, for biography is not the record of "life" in general, but of the life of a single person. The idea of the distinction between this and history is a modern thing; we speak of "antique biography," but it is doubtful whether any writer of antiquity, even Plutarch, clearly perceived its possible existence as an independent branch of literature. All of them, and Plutarch certainly, considered the writing of a man's life as an opportunity for celebrating, in his person, certain definite moral qualities. It was in these, and not in the individual characteristics of the man, that his interest as a subject of biography resided.

The true conception of biography, therefore, as the faithful portrait of a soul in its adventures through life, is very modern.

We may question whether it existed, save in rare and accidental instances, until the 17th century. The personage described was, in earlier times, treated either from the philosophical or from the historical point of view. In the former case, rhetoric inevitably clouded the definiteness of the picture; the object was to produce a grandiose moral effect, to clothe the subject with all the virtues or with all the vices; to make his career a splendid example or else a solemn warning. The consequence is that we have to piece together unconsidered incidents and the accidental record of features in order to obtain an approximate estimate. We may believe, for instance, that a faithful and unprejudiced study of the emperor Julian, from the life, would be a very different thing from the impression left upon us by the passions of Cyril or of Theodoret. In considering what biography, in its pure sense, ought to be, we must insist on what it is not. It is not a philosophical treatise nor a polemical pamphlet. It is not, even, a portion of the human contemporary chronicle. Broad views are entirely out of place in biography, and there is perhaps no greater literary mistake than to attempt what is called the "Life and Times" of a man. In an adequate record of the "times," the man is bound to sink into significance; even a "Life and Times" of Napoleon I. would be an impossible task. History deals with fragments of the vast roll of events; it must always begin abruptly and close in the middle of affairs; it must always deal, impartially, with a vast number of persons. Biography is a study sharply defined by two definite events, birth and death. It fills its canvas with one figure, and other personages, however great in themselves, must always be subsidiary to the central hero. The only remnant of the old rhetorical purpose of "lives" which clearer modern purpose can afford to retain is the relative light thrown on military or intellectual or social genius by the achievements of the selected subject. Even this must be watched with great care, lest the desire to illuminate that genius, and make it consistent, should lead the biographer to gloss over frailties or obscure irregularities. In the old "lives" of great men, this is precisely what was done. If the facts did not lend themselves to the great initial thesis, so much the worse for them. They must be ignored or falsified, since the whole object of the work was to "teach a lesson," to magnify a certain tendency of conduct. It was very difficult to persuade the literary world that, whatever biography is, it is not an opportunity for panegyric or invective, and the lack of this perception destroys our faith in most of the records of personal life in ancient and medieval times. It is impossible to avoid suspecting that Suetonius loaded his canvas with black in order to excite hatred against the Roman emperors; it is still more difficult to accept more than one page in three of the stories of the professional hagiographers. As long as it was a pious merit to deform the truth, biography could not hope to flourish. It appears to have originally asserted itself when the primitive instinct of sympathy began to have free play, that is to say, not much or often before the 17th century. Moreover, the peculiar curiosity which legitimate biography satisfies is essentially a modern thing; and presupposes our observation of life not unduly clouded by moral passion or prejudice.

Among the ancients, biography was not specifically cultivated until comparatively later times. The lost "Lives" of Critias were probably political pamphlets. We meet first with deliberate biography in Xenophon's memoirs of Socrates, a work of epoch-making value. Towards the close of the 1st century, Plutarch wrote one of the most fascinating books in the world's literature, his *Parallel Lives* of 46 Greeks and Romans. In later Greek, the *Life of Apollonius of Tyana* was written by Philostratus, who also produced a *Lives of the Sophists*. In the 3rd century, Diogenes Laertius compiled a *Lives of the Philosophers*, which is of greater interest than a *Lives of the Sophists* composed a hundred years later by Eunapius. Finally in the 10th century, Suidas added a biographical section to his celebrated *Lexicon*. In Latin literature, the earliest biography we meet with is the fragment of the *Illustrious Men* of Cornelius Nepos. Memoirs began to be largely written at the close of the Augustan age,

but these, like the *Life of Alexander the Great*, by Q. Curtius Rufus, were rather historical than biographical. Tacitus composed a life of his father-in-law, Agricola; this is a work of the most elegant and stately beauty. Suetonius was the author of several biographical compilations, of which the *Lives of the Twelve Caesars* is the best-known; this was produced in the year 120. Marius Maximus, in the 4th century, continued the series of emperors down to Heliogabalus, but his work has not been preserved. The *Augustan History*, finished under Constantine, takes its place, and was concluded and edited by Flavius Vopiscus.

Biography hardly begins to exist in English literature until the close of the reign of Henry VIII. William Roper (1496-1578) wrote a touching life of his father-in-law, Sir Thomas More, and George Cavendish (1500-1561?), a memoir of Cardinal Wolsey which is a masterpiece of liveliness and grace. It is with these two works, both of which remained in manuscript until the 17th century, that biography in England begins. The lives of English writers compiled by John Bale (1495-1563) are much more primitive and slight. John Leland (d. 1552) and John Pits (1560-1616) were antiquaries who affected a species of biography. In the early part of the 17th century, the absence of the habit of memoir writing extremely impoverishes our knowledge of the illustrious authors of the age, of none of whom there are preserved such records as our curiosity would delight in. The absence of any such chronicle was felt, and two writers, Thomas Heywood and Sir Aston Cockayne, proposed to write lives of the poets of their time. Unfortunately they never carried their plans into execution. The pioneer of deliberate English biography was Izaak Walton, who, in 1640, published a *Life of Donne*, followed in 1651 by that of *Sir Henry Wotton*, in 1665 by that of *Richard Hooker*, in 1670 by that of *George Herbert*, and in 1678 by that of *Dr Robert Sanderson*. These five reprinted, under the title of *Walton's Lives*, were not only charming in themselves, but the forerunners of a whole class of English literature. Meanwhile, Fuller was preparing his *History of the Worthies of England*, which appeared after his death, in 1662, and John Aubrey (1626-1697) was compiling his *Minutes of Lives*, which show such a perfect comprehension of the personal element that should underlie biography; these have only in our own days been completely given to the public. Edward, Lord Herbert of Cherbury (1583-1648), wrote a brilliant autobiography, first printed in 1764; that of Anne Harrison, Lady Fanshawe (1625-1680), remained unknown until 1820. A very curious essay in biography is the memoir of Colonel John Hutchinson, written by his widow, Lucy, between 1664 and 1671. Margaret Lucas, duchess of Newcastle (1624?-1674), wrote her own life (1656) and that of her duke (1667). The *Athenas Oxonienses* of Anthony à Wood (1632-1695) was a complicated celebration of the wit, wisdom and learning of Oxford notabilities since the Reformation. In 1668 Thomas Sprat (1635-1713) wrote a *Life of Cowley*, which was very much admired and which exercised for many years a baneful influence on British biography. Sprat considered that all familiar anecdote and picturesque detail should be omitted in the composition of a memoir, and that moral effect and a solemn vagueness should be aimed at. The celebrated funeral orations of Jeremy Taylor were of the same order of eloquence, and the wind of those grandiose compositions destroyed the young shoot of genuine and simple biography which had budded in Walton and Aubrey.

From this time forth, for more than half a century, English biography became a highly artificial and rhetorical thing, lacking all the salient features of honest portraiture. William Oldys (1696-1761) was the first to speak out boldly; in 1747, in the preface to the *Biographia Britannica*, he pointed out "the cruelty, we might even say the impiety, of sacrificing the glory of great characters to trivial circumstances and mere convenience," and attacked the timid and scrupulous superficiality of those who undertook to write lives of eminent men, while omitting everything which gave definition to the portrait. In 1753 the *Lives of the Poets*, which bore the name of Theophilus Cibber (1703-1758), but was mainly written by Robert Shiels

(d. 1753), gave a great deal of valuable information with regard to the personal adventures of our writers. Dr Johnson's *Life of Savage* (1744), though containing some passages of extreme interest, was a work of imperfect form, but Mason's *Life and Letters of Gray* (1774) marks a great advance in the art of biography. This was the earliest memoir in which correspondence of a familiar kind was used to illustrate and to expand the narrative, and Mason's *Gray* is really the pioneer of almost all modern English biography. For the first time it was now admitted that letters to intimate friends, not written with a view to publication, might be used with advantage to illustrate the real character of the writer. Boswell, it is certain, availed himself of Mason's example, while improving upon it, and in 1791 he published his *Life of Dr Samuel Johnson*, which is the most interesting example of biography existing in English, or perhaps in any language.

As soon as the model of Boswell became familiar to biographers, it could no longer be said that any secret in the art was left unknown to them, and the biographies of the 19th century are all more or less founded upon the magnificent type of the *Life of Johnson*. But few have even approached it in courage, picturesqueness or mastery of portraiture. In the next generation Southey's lives of *Nelson* (1813) and *John Wesley* (1820) at once became classics; but the pre-eminent specimen of early 19th-century biography is Lockhart's superb *Life of Sir Walter Scott* (1837-1838). The biographies of the 19th century are far too numerous to be mentioned here in detail; in the various articles dedicated to particular men and women in this Encyclopaedia, the date and authorship of the authoritative life of each person will in most cases be found appended. Towards the close of the century there was unquestionably an excess, and even an abuse, in the habit of biography. It became the custom a few years or even months after the decease of an individual who had occupied a passing place in the eyes of the public, to issue a "Life" of him; in many cases such biography was a labour of utter supererogation. But the custom has become general, and it is very unlikely, notwithstanding the ephemeral interest of readers in the majority of the subjects, that it will ever go out of fashion, for it directly indulges both vanity and sentiment. What is true of Great Britain is true, though in less measure, of all other modern nations, and it is not necessary here to deal with more than the early manifestations of biography in the principal European literatures.

To Switzerland appears due the honour of having given birth to the earliest biographical dictionary ever compiled, the *Bibliotheca Universalis* of Konrad Gesner (1516-1565), published at Zürich in Latin, Greek and Hebrew, from 1545 to 1549. A very rare work, by a writer of the greatest obscurity, the *Prosopographia* of Verdier de Vauprivas, published at Lyons in 1573, professed to deal with the lives of all illustrious persons who had flourished since the beginning of the world.

In medieval and renaissance France there existed numerous memoirs and histories, such as those of Brantôme, into which the lives of great men were inserted, and in which a biographical character was given to studies of virtue and valour, or of the reverse. But the honour of being the earliest deliberate contribution to biography is generally given to the *Acta Sanctorum*, compiled by the Bollandists, the first volume of which appeared in 1653. This was the first biographical dictionary compiled in Europe, and its publication produced a great sensation. It was confined to the lives of saints and martyrs, but in 1674 Louis Moréri, in his *Grand Dictionnaire*, included a biographical section of a general character. But the earliest biographical dictionary which had anything of a modern form was the celebrated *Dictionnaire historique et critique* of Pierre Bayle, in 1696; the lives in this great work, however, are too often used as mere excuses for developing the philosophical and controversial views of the author; they are nevertheless the result of genuine research and have a true biographical view. The *Dictionnaire* was translated into English in 1734, and had a wide influence in creating a legitimate interest in biography in England.

In Italian literature, biography does not take a prominent place until the 15th century. The *Lives of Illustrious Florentines*, in which a valuable memoir of Dante occurs, was written in Latin by Filippo Villani. Vespasiano da Bisticri (1421-1498) compiled a set of biographies of his contemporaries, which are excellent of their kind. The so-called *Life of Castruccio Castracani*, by Machiavelli, is hardly a biography, but a brilliant essay on the ideals of statecraft. Paolo Giovio (1483-1552) wrote the lives of poets and soldiers whom he had known. All these attempts, however, seem insignificant by the side of the autobiography of Benvenuto Cellini (1501-1571), confessedly one of the most entertaining works of the world's literature. A great deal of biography is scattered throughout the historical compilations of the Italian renaissance, and the *Lives of the Artists*, by Giorgio Vasari (1512-1574), is a storehouse of anecdotes admirably told. We find nothing else that requires special mention till we reach the memoir-writers of the 18th century, with the autobiographies of Count Carlo Gozzi and Alfieri; and on the whole, Italy, although adopting in the 19th century the habit of biography, has rarely excelled in it.

In Spanish literature Fernán Pérez de Guzmán (1378-1460), with great originality, enshrined, in his *Generations and Likenesses*, a series of admirable literary portraits; he has been called the Plutarch of Spain. But, in spite of numerous lives of saints, poets and soldiers, Spanish literature has not excelled in biography, nor has it produced a single work of this class which is universally read. In Germany there is little to record before the close of the 18th century.

In the course of the 19th century a new thing in biography was invented, in the shape of dictionaries of national biography. Of these, the first which was carried to a successful conclusion was the Swedish (1835-1857), which occupied 23 volumes. This dictionary was followed by the Dutch (1852-1878), in 24 volumes; the Austrian (1856-1891), in 35 volumes; the Belgian (which was begun in 1866); the German (1875-1900), in 45 volumes; and others, representing nearly all the countries of Europe. England was behind the competitors named above, but when she joined the ranks a work was produced the value of which can hardly be exaggerated. The project was started in 1882 by the publisher George Smith (1824-1901), who consulted Mr (afterwards Sir) Leslie Stephen. The first volume of the *English Dictionary of National Biography* was published on the 1st of January 1885, under Stephen's editorship. A volume was published quarterly, with complete punctuality until Midsummer 1900, when volume 63 closed the work, which was presently extended by the issue of three supplementary volumes. In May 1891 Leslie Stephen resigned the editorship and was succeeded by Mr Sidney Lee, who conducted the work to its prosperous close, bringing it up to the death of Queen Victoria. The *Dictionary of National Biography* contains the lives of more than 30,000 persons, and has proved of inestimable service in elucidating the private annals of the British people. (E. G.)

BIOLOGY (Gr. *bios*, life). The biological sciences are those which deal with the phenomena manifested by living matter; and though it is customary and convenient to group apart such of these phenomena as are termed mental, and such of them as are exhibited by men in society, under the heads of psychology and sociology, yet it must be allowed that no natural boundary separates the subject matter of the latter sciences from that of biology. Psychology is inseparably linked with physiology; and the phases of social life exhibited by animals other than man, which sometimes curiously foreshadow human policy, fall strictly within the province of the biologist.

On the other hand, the biological sciences are sharply marked off from the abiological, or those which treat of the phenomena manifested by not-living matter, in so far as the properties of living matter distinguish it absolutely from all other kinds of things, and as the present state of knowledge furnishes us with no link between the living and the not-living.

These distinctive properties of living matter are—

1. Its *chemical composition*—containing, as it invariably does, one or more forms of a complex compound of carbon, hydrogen, oxygen and nitrogen, the so-called protein or albumin (which has never yet been obtained except as a product of living bodies), united with a large proportion of water, and forming the chief constituent of a substance which, in its primary unmodified state, is known as *protoplasm*.

2. Its *universal disintegration and waste by oxidation; and its concomitant reintegration by the intussusception of new matter*.

A process of waste resulting from the decomposition of the molecules of the protoplasm, in virtue of which they break up into more highly oxidated products, which cease to form any part of the living body, is a constant concomitant of life. There is reason to believe that carbonic acid is always one of these waste products, while the others contain the remainder of the carbon, the nitrogen, the hydrogen and the other elements which may enter into the composition of the protoplasm.

The new matter taken in to make good this constant loss is either a ready-formed protoplasmic material, supplied by some other living being, or it consists of the elements of protoplasm, united together in simpler combinations, which consequently have to be built up into protoplasm by the agency of the living matter itself. In either case, the addition of molecules to which already existed takes place, not at the surface of the living mass, but by interposition between the existing molecules of the latter. If the processes of disintegration and of reconstruction which characterize life balance one another, the size of the mass of living matter remains stationary, while, if the reconstructive process is the more rapid, the living body *grows*. But the increase of size which constitutes growth is the result of a process of molecular intussusception, and therefore differs altogether from the process of growth by accretion, which may be observed in crystals and is effected purely by the external addition of new matter—so that, in the well-known aphorism of Linnaeus, the word "grow" as applied to stones signifies a totally different process from what is called "growth" in plants and animals.

3. Its *tendency to undergo cyclical changes*.

In the ordinary course of nature, all living matter proceeds from pre-existing living matter, a portion of the latter being detached and acquiring an independent existence. The new form takes on the characters of that from which it arose; exhibits the same power of propagating itself by means of an offshoot; and, sooner or later, like its predecessor, ceases to live, and is resolved into more highly oxidated compounds of its elements.

Thus an individual living body is not only constantly changing its substance, but its size and form are undergoing continual modifications, the end of which is the death and decay of that individual; the continuation of the kind being secured by the detachment of portions which tend to run through the same cycle of forms as the parent. No forms of matter which are either not living, or have not been derived from living matter, exhibit these three properties, nor any approach to the remarkable phenomena defined under the second and third heads. But in addition to these distinctive characters, living matter has some other peculiarities, the chief of which are the dependence of all its activities upon moisture and upon heat, within a limited range of temperature, and the fact that it usually possesses a certain structure or organization.

As has been said, a large proportion of water enters into the composition of all living matter; a certain amount of drying arrests vital activity, and the complete abstraction of this water is absolutely incompatible with either actual or potential life. But many of the simpler forms of life may undergo desiccation to such an extent as to arrest their vital manifestations and convert them into the semblance of not-living matter, and yet remain potentially alive. That is to say, on being duly moistened they return to life again. And this revivification may take place after months, or even years, of arrested life.

The properties of living matter are intimately related to temperature. Not only does exposure to heat sufficient to coagulate protein matter destroy life, by demolishing the molecular structure upon which life depends; but all vital activity, all phenomena of nutritive growth, movement and reproduction are possible only between certain limits of temperature. These limits may be set down as from a little above the freezing point of water to a little below the boiling point. It is to be noted, however, that these limits apply to the living matter itself, and many of the apparent exceptions are due to cases in which the living matter is enclosed in protective wrappings capable of resisting heat and cold. In many low organisms, such as the spores of bacteria, the thick, non-conducting wall may preserve the living protoplasm from subjection to external temperatures below freezing point, or above boiling point, but all the evidence goes to show that applications of such cold or heat, if prolonged or arranged so as to penetrate to the living matter, destroy life. In warm-blooded animals, such as birds and mammals, protective mechanisms for the regulation of temperature enable them to endure exposure to extreme heat or cold, but in such cases the actually living cells do not appreciably rise or fall in temperature. A variation of a very few degrees in the blood itself produces death.

Recent investigations point to the conclusion that the immediate cause of the arrest of vitality, in the first place, and of its destruction, in the second, is the coagulation of certain substances in the protoplasm, and that the latter contains various coagulable matters, which solidify at different temperatures. And it remains to be seen, how far the death of any form of living matter, at a given temperature, depends on the destruction of its fundamental substance at that heat, and how far death is brought about by the coagulation of merely accessory compounds.

It may be safely said of all those living things which are large enough to enable us to trust the evidence of microscopes, that they are heterogeneous optically, and that their different parts, and especially the surface layer, as contrasted with the interior, differ physically and chemically; while, in most living things, mere heterogeneity is exchanged for a definite structure, whereby the body is distinguished into visibly different parts, which possess different powers or functions. Living things which present this visible structure are said to be *organized*; and so widely does organization obtain among living beings, that *organized and living* are not unfrequently used as if they were terms of co-extensive applicability. This, however, is not exactly accurate, if it be thereby implied that all living things have a visible organization, as there are numerous forms of living matter of which it cannot properly be said that they possess either a definite structure or permanently specialized organs: though, doubtless, the simplest particle of living matter must possess a highly complex molecular structure, which is far beyond the reach of vision.

The broad distinctions which, as a matter of fact, exist between every known form of living substance and every other component of the material world, justify the separation of the biological sciences from all others. But it must not be supposed that the differences between living and not-living matter are such as to justify the assumption that the forces at work in the one are different from those which are to be met with in the other. Considered apart from the phenomena of consciousness, the phenomena of life are all dependent upon the working of the same physical and chemical forces as those which are active in the rest of the world. It may be convenient to use the terms "vitality" and "vital force" to denote the causes of certain great groups of natural operations, as we employ the names of "electricity" and "electrical force" to denote others; but it ceases to be proper to do so, if such a name implies the absurd assumption that "electricity" and "vitality" are entities playing the part of efficient causes of electrical or vital phenomena. A mass of living protoplasm is simply a molecular machine of great complexity, the total results of the working of which, or its vital phenomena, depend—on the one hand,

Life conditioned by temperature.

Life and organization.

Life conditioned by moisture.

upon its construction, and, on the other, upon the energy supplied to it; and to speak of "vitality" as anything but the name of a series of operations is as if one should talk of the "horology" of a clock.

Living matter, or protoplasm and the products of its metamorphosis, may be regarded under four aspects:—

1. It has a certain external and internal form, the classification of the latter being more usually called structure;

2. It occupies a certain position in space and in time;

3. It is the subject of the operation of certain forces in virtue of which it undergoes internal changes, modifies external objects, and is modified by them; and

4. Its form, place and powers are the effects of certain causes.

In correspondence with these four aspects of its subject, biology is logically divisible into four chief subdivisions—I. MORPHOLOGY; II. DISTRIBUTION; III. PHYSIOLOGY; IV. AETIOLOGY.

Various accidental circumstances, however, have brought it about that the actual distribution of scientific work does not correspond with the logical subdivisions of biology. The difference in technical methods and the historical evolution of teaching posts (for in all civilized countries the progress of biological knowledge has been very closely associated with the existence of institutions for the diffusion of knowledge and for professional education) have been the chief contributory causes to this practical confusion. Details of the morphology of plants will be found in the articles relating to the chief groups of plants, those of animals in the corresponding articles on groups of animals, while the classification of animals adopted in this work will be found in the article ZOOLOGY. Distribution is treated of under ZOOLOGICAL DISTRIBUTION, PLANKTON, PALAEOZOOLOGY and PLANTS: *Distribution*. PHYSIOLOGY and its allied articles deal with the subject generally and in relation to man, while the special physiology of plants is dealt with in a section of the article PLANTS. Aetiology is treated of under the heading EVOLUTION. But practical necessity has given rise to the existence of many other divisions; see CYTOLOGY, for the structure of cells; EMBRYOLOGY, for the development of individual organisms; HEREDITY and REPRODUCTION, for the relations between parents and offspring. (T. H. H.; P. C. M.)

BION, Greek bucolic poet, was born at Phlossa near Smyrna, and flourished about 100 B.C. The account formerly given of him, that he was the contemporary and imitator of Theocritus, the friend and tutor of Moschus, and lived about 280 B.C., is now generally regarded as incorrect. W. Stein (*De Moschi et Bionis aetate*, Tübingen, 1893) puts Bion, chiefly on metrical grounds, in the first half of the 1st century B.C. Nothing is known of him except that he lived in Sicily. The story that he died of poison, administered to him by some jealous rivals, who afterwards suffered the penalty of their crime, is probably only an invention of the author of the *Ἐπιφώνιος Βίωνος* ('*Ἐπιφώνιος Ἀδώντιος*'). It refers to the first day of the festival of Adonis (*Ἀδώντιος*), on which the death of the favourite of Aphrodite was lamented, thus forming an introduction to the *Adoniae* of Theocritus, the subject of which is the second day, when the reunion of Adonis and Aphrodite was celebrated. Fragments of his other pieces are preserved in Stobaeus; the epithalamium of Achilles and Deidamia is not his.

Bion and Moschus have been edited separately by G. Hermann (1849) and C. Ziegler (Tübingen, 1869), the *Epitaphios Adonis* by H. L. Ahrens (1854) and E. Hiller in *Beiträge zur Textgeschichte der griechischen Bukoliker* (1888). Bion's poems are generally included in the editions of Theocritus. There are English translations by J. Banks (1853) in Bohn's *Classical Library*, and by Andrew Lang (1889), with Theocritus and Moschus; there is an edition of the

text by U. Wilamowitz-Möllendorf in the Oxford *Scriptorum Classicorum Bibliotheca* (1905). On the date of Bion see F. Bücheler in *Rheinisches Museum*, xxx. (1875), pp. 33-41; also G. Knaack in Pauly-Wissowa's *Realencyclopädie*, s.v.; and F. Susemihl, *Geschichte der griechischen Literatur in der Alexandrinerzeit*, i. (1891), p. 233.

BION, of Borysthènes (Olbia), in Sarmatia, Greek moralist and philosopher, flourished in the first half of the 3rd century B.C. He was of low origin, his mother being a courtesan and his father a dealer in salt fish, with which he combined the occupation of smuggling. Bion, when a young man, was sold as a slave to a rhetorician, who gave him his freedom and made him his heir. After the death of his patron, Bion went to Athens to study philosophy. Here he attached himself in succession to the Academy, the Cynics, the Cyrenaics and the Peripatetics. One of his teachers was the Cyrenaic Theodorus, called "the atheist," whose influence is clearly shown in Bion's attitude towards the gods. After the manner of the sophists of the period, Bion travelled through Greece and Macedonia, and was admitted to the literary circle at the court of Antigonos Gonatas. He subsequently taught philosophy at Rhodes and died at Chalcis in Euboea. His life was written by Diogenes Laertius. Bion was essentially a popular writer, and in his *Diatribae* he satirized the follies of mankind in a manner calculated to appeal to the sympathies of a low-class audience. While eulogizing poverty and philosophy, he attacked the gods, musicians, geometers, astrologers, and the wealthy, and denied the efficacy of prayer. His influence is distinctly traceable in succeeding writers, e.g. in the satires of Menippus. Horace (*Epistles*, ii. 2. 60) alludes to his satires and caustic wit (*sal nigrum*). An idea of his writings can be gathered from the fragments of Teles, a cynic philosopher who lived towards the end of the 3rd century, and who made great use of them. Specimens of his apophthegms may be found in Diogenes Laertius and the florilegium of Stobaeus, while there are traces of his influence in Seneca.

See Hoogvliet, *De Vita, Doctrina, et Scriptis Bionis* (1821); Rosignol, *Fragments Bionis Borysthenitae* (1830); Heinze, *De Horatio Bionis Imitatore* (1889).

BIOT, JEAN BAPTISTE (1774-1862), French physicist, was born at Paris on the 21st of April 1774. After serving for a short time in the artillery, he was appointed in 1797 professor of mathematics at Beauvais, and in 1800 he became professor of physics at the Collège de France, through the influence of Laplace, from whom he had sought and obtained the favour of reading the proof sheets of the *Mécanique céleste*. Three years later, at an unusually early age, he was elected a member of the Academy of Sciences, and in 1804 he accompanied Gay Lussac on the first balloon ascent undertaken for scientific purposes. In 1806 he was associated with F. J. D. Arago, with whom he had already carried out investigations on the refractive properties of different gases, in the measurement of an arc of the meridian in Spain, and in subsequent years he was engaged in various other geodetic determinations. In 1814 he was made chevalier and in 1849 commander, of the Legion of Honour. He failed in his ambition of becoming perpetual secretary of the Academy of Sciences, but was somewhat consoled by his election as a member of the French Academy in 1856. He died in Paris on the 3rd of February 1862. His researches extended to almost every branch of physical science, but his most important work was of an optical character. He was especially interested in questions relating to the polarization of light, and his observations in this field, which gained him the Rumford medal of the Royal Society in 1840, laid the foundations of the polarimetric analysis of sugar.

Biot was an extremely prolific writer, and besides a great number of scientific memoirs, biographies, &c., his published works include: *Analyse de la mécanique céleste de M. Laplace* (1801); *Traité analytique des courbes et des surfaces du second degré* (1802); *Recherches sur l'intégration des équations différentielles partielles et sur les vibrations des surfaces* (1803); *Traité de physique* (1816); *Recueil d'observations géodésiques, astronomiques et physiques exécutées en Espagne et Écosse*, with Arago (1821); *Mémoire sur la vraie constitution de l'atmosphère terrestre* (1841); *Traité élémentaire d'astronomie physique* (1805); *Recherches sur*

plusieurs points de l'astronomie égyptienne (1823); *Recherches sur l'ancienne astronomie chinoise* (1840); *Études sur l'astronomie indienne et sur l'astronomie chinoise* (1862); *Essai sur l'histoire générale des sciences pendant la Révolution* (1803); *Discours sur Montaigne* (1812); *Lettres sur l'approvisionnement de Paris et sur le commerce des grains* (1835); *Mélanges scientifiques et littéraires* (1858).

His son, EDUARD CONSTANT BIOT (1803–1850), after amassing a competence from railway engineering, turned to the study of Chinese subjects, and published *Causes de l'abolition de l'esclavage ancien en occident* (1840); *Dictionnaire des noms anciens et modernes des villes et des arondissements compris dans l'Empire chinois* (1842); *Essai sur l'histoire de l'instruction publique en Chine et de la corporation des lettres* (1847); *Mémoire sur les colonies militaires et agricoles des chinois* (1850).

BIOTITE, an important rock-forming mineral belonging to the group of micas (*q.v.*). The name was given by J. F. L. Hausmann in 1847 in honour of the French physicist, J. B. Biot, who in 1816 found the magnesia-micas to be optically uniaxial or nearly so. The magnesia-micas are now referred to the species biotite and phlogopite, which differ in that the former contains a considerable but widely varying amount of iron. Biotite is an orthosilicate of aluminium, magnesium, ferrous and ferric iron, potassium and basic hydrogen, with small amounts of calcium, sodium, lithium, fluorine, titanium, &c., and ranges in composition between $(\text{H}, \text{K})_2(\text{Mg}, \text{Fe})_2(\text{Al}, \text{Fe})_2(\text{SiO}_3)_4$ and $(\text{H}, \text{K})_2(\text{Mg}, \text{Fe})_2\text{Al}_2(\text{SiO}_3)_4$.

Like the other micas, it is monoclinic with pseudo-hexagonal symmetry (figs. 1, 2) and possesses a perfect cleavage in one direction (*c*). Biotite is, however, readily distinguished by its darker colour, strong pleochroism, and small optic axial angle.

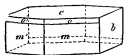

FIG. 1.

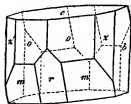

FIG. 2.

The colour is usually dark-green or brown; thick crystals are often deep-black and opaque. The absorption of light-rays vibrating parallel to the cleavage is much greater than of rays vibrating in a direction perpendicular thereto, and in dark-coloured crystals the former are almost completely absorbed. The angle between the optic axes is usually very small, the crystals being often practically uniaxial; an axial angle of 50° has, however, been recorded in a dark-coloured biotite. The specific gravity of biotite is, as a rule, higher than that of other micas, varying from 2.7 to 3.1 according to the amount of iron present. The hardness is 2½ to 3.

Several varieties of biotite are distinguished. By G. Tschermak it is divided into two classes, *merozeine* and *anomite*; in the former the plane of the optic axis coincides with the plane of symmetry, whilst in the latter it is perpendicular thereto. *Merozeine* includes nearly all ordinary biotite, and is the name given by A. Breithaupt in 1841 to the Vesuvian crystals; on the other hand, *anomite* (named from *ἀνομος*, "contrary to law") is of rare occurrence. Haughtonite and siderophyllite are black varieties rich in ferrous iron, and lepidomelane (from *λεπίς*, a scale, and *μῆλας*, black) is a variety rich in ferric iron. In barybiotite and manganophyllite the magnesia is partly replaced by baryta and manganous oxide respectively. Rubellane, hydrobiotite, pseudobiotite, and others are altered forms of biotite, which is a mineral particularly liable to decomposition with the production of chlorites and vermiculites.

Biotite is a common constituent of igneous and crystalline rocks: in granite, gneiss and mica-schist it is often associated with muscovite (white mica), the two kinds having sometimes grown in parallel position. In volcanic rocks, and in nearly all

other kinds of igneous rocks with the exception of granite, biotite occurs to the exclusion of the muscovite. In the dyke-rocks known as mica-traps or mica-lamprophyres biotite is especially abundant. It is also one of the most characteristic products of contact-metamorphism, being developed in sedimentary and other rocks at their contact with granite masses. In the ejected blocks of crystalline limestone of Monte Somma, Vesuvius, the most perfectly developed crystals of biotite (figs. 1, 2), or indeed of any of the micas, are found in abundance, associated with brilliant crystals of augite, olivine, humite, &c.

Although biotite (black mica) is much more common and widely distributed than white mica, yet it is of far less economic importance. The small size of the sheets, their dark colour and want of transparency render the material of little value. Large, cleavable masses yielding fine smoky-black and green sheets, sufficiently elastic for industrial purposes, are, however, found in Renfrew county, Ontario.

(L. J. S.)

BIPARTITE (from the Lat. *bi-*, two, and *partire*, to divide). In a general sense, the word means having two corresponding parts or in duplicate. In geometry, a bipartite curve consists of two distinct branches (see PARABOLA, figs. 3, 5). In botany, the word is applied to leaves divided into two parts near the base. A *bipartient factor* is a number whose square exactly divides another number. In zoology, the *Bipartiti* was a name given by P. A. Latreille to a group of carnivorous *Coleoptera*.

BIPONT EDITIONS, the name of a famous series of editions, in 50 volumes, of Greek and Latin classical authors, so called from Bipontium, the modern Latin name of Zweibrücken or Deux-Ponts in Bavaria, where they were first issued in 1779. Their place of publication was afterwards transferred to Strassburg.

See Butters, *Über die Editiones Bipontinae* (1877).

BICADRATIC (from the Lat. *bi-*, twice, and *quadratus*, squared). In mathematics, the biquadratic power or root of a quantity is its fourth power or root (see ALGEBRA); a biquadratic equation is an equation in which the highest power of the unknown is the fourth (see EQUATION: *Biquadratic*).

BICQUINTILE (from Lat. prefix *bi-*, twice, *quintilis*, fifth), the aspect of two planets which are distant from each other twice the fifth part of a great circle, *i.e.* 144° . It was one of the new aspects introduced by Kepler.

BIRBHUM, a district of British India in the Burdwan division of Bengal, situated in the Gangetic plain and partly on the hills, being bounded on the south by the river Ajai. The administrative headquarters are at Suri, which is the only town in the district. The area comprises 1752 sq. m. The eastern portion of the district is the ordinary alluvial plain of the Gangetic delta; the western part consists of undulating beds of laterite resting on a rock basis, and covered with small scrub jungle. The Ajai, Bakheswar and Mor or Maurakshi, are the principal rivers of the district, but they are merely hill streams and only navigable in the rains. In 1901 the population was 902,280, showing an increase of 13% in the decade. The principal industry is the spinning and weaving of silk, chiefly from tussur or jungle silkworms. There are also several lac factories. The loop-line of the East Indian railway runs through the district, with a junction at Nalhati for Murshidabad.

History.—Birbhum in the early part of the 13th century was a Hindu state, with its capital at Rajnagar or Nagar. In the course of the century it was conquered by the Pathans and formed part of the Pathan kingdom of Bengal. At the beginning of the 18th century it appears as a kind of military fief held under the nabab of Murshidabad by one Asadullah Pathan, whose family had probably been its chieftains since the fall of the Pathan dynasty of Bengal in 1600. It passed into British possession in 1765, but the East India Company did not assume its direct government until 1787, when that course became necessary. In the interval it had been a prey to armed bands from the highlands of Chota Nagpur, with whom the raja was unable to cope, and who practically brought the trade of the Company in the district to a standstill. The two border principalities of Birbhum and Bankura were accordingly united into a district under a British collector, being, however, separated again in 1793. By 1789, after

considerable trouble, the marauders were driven back into their mountains, and since that time (except during the Santal rising of 1855) the district has been one of the most peaceful and prosperous in India.

See *Imperial Gazetteer of India* (Oxford, 1908), vol. viii. s.9.

BIRCH, SAMUEL (1813-1885), English Egyptologist and antiquary, was born on the 3rd of November 1813, being the son of the rector of St Mary Woolnoth, London. From an early age he manifested a tendency to the study of out-of-the-way subjects, and after a brief employment in the Record Office obtained in 1836 an appointment in the antiquities department of the British Museum on account of his knowledge of Chinese. He soon extended his researches to Egyptian, and when the cumbrous department came to be divided he was appointed to the charge of the Egyptian and Assyrian branch. In the latter language he had assistance, but for many years there was only one other person in the institution—in a different department—who knew anything of ancient Egyptian, and the entire arrangement of the department devolved upon Birch. He found time nevertheless for Egyptological work of the highest value, including a hieroglyphical grammar and dictionary, translations of *The Book of the Dead* and the Harris papyrus, and numerous catalogues and guides. He further wrote what was long a standard history of pottery, investigated the Cypriote syllabary, and proved by various publications that he had not lost his old interest in Chinese. Paradoxical in many of his views on things in general, he was sound and cautious as a philologist; while learned and laborious, he possessed much of the instinctive divination of genius. He died on the 27th of December 1885.

BIRCH, THOMAS (1705-1766), English historian, son of Joseph Birch, a coffee-mill maker, was born at Clerkenwell on the 23rd of November 1705. He preferred study to business, but as his parents were Quakers he did not go to the university. Notwithstanding this circumstance, he was ordained deacon in the Church of England in 1730 and priest in 1731. As a strong supporter of the Whigs, he gained the favour of Philip Yorke, afterwards lord chancellor and first earl of Hardwicke, and his subsequent preferments were largely due to this friendship. He held successively a number of benefices in different counties, and finally in London. In 1735 he became a member of the Society of Antiquaries, and was elected a fellow of the Royal Society, of which he was secretary from 1752 to 1765. In 1728 he had married Hannah Cox, who died in the following year. Birch was killed on the 9th of January 1766 by a fall from his horse, and was buried in the church of St Margaret Pattens, London, of which he was then rector. He left his books and manuscripts to the British Museum, and a sum of about £500 to increase the salaries of the three assistant librarians.

Birch had an enormous capacity for work and was engaged in a large number of literary undertakings. In spite of their dulness many of his works are of considerable value, although Horace Walpole questioned his "parts, taste and judgment." He carried on an extensive correspondence with some of the leading men of his time, and many of his letters appear in *Literary Anecdotes of the 18th Century* (London, 1812-1815) and *Illustrations of the Literary History of the 18th Century* (London, 1817-1858) by J. Nichols, in the *Bibliotheca Topographica Britannica*, vol. iiii. (London, 1780-1790), and in Boswell's *Life of Johnson*. Birch wrote most of the English lives in the *General Dictionary, Historical and Critical*, 10 vols. (London, 1734-1741), assisted in the composition of the *Athenian Letters* (London, 1810), edited the *State Papers of John Thurloe* (London, 1742) and the *State Papers of W. Murdin* (London, 1750). He also wrote a *Life of the Right Honourable Robert Boyle* (London, 1744); *Inquiry into the share which King Charles I. had in the transactions of the Earl of Glamorgan for bringing over a body of Irish rebels* (London, 1756); *Historical view of Negotiations between the Courts of England, France and Brussels 1592-1617* (London, 1740); *Life of Archbishop Tillotson* (London, 1753); *Memoirs of the Reign of Queen Elizabeth from 1581* (London, 1754); *History of the Royal Society of London* (London, 1756-1757); *Life of Henry, Prince of Wales* (London, 1760), and many other works. Among the

papers left at his death were some which were published in 1848 as the *Court and Times of James I.* and the *Court and Times of Charles I.*

See W. P. Courtney in the *Dictionary of National Biography*, vol. v. (1886); A. Kippis, *Biographia Britannica* (London, 1778-1793); Horace Walpole, *Letters* (London, 1891).

BIRCH (*Betula*), a genus of plants allied to the alder (*Ainus*), and like it a member of the natural order *Betulales*. The various species of birch are mostly trees of medium size, but several of them are merely shrubs. They are as a rule of a very hardy character, thriving best in northern latitudes—the trees having round, slender branches, and serrate, deciduous leaves, with barren and fertile catkins on the same tree, and winged fruits, the so-called seeds. The bark in most of the trees occurs in fine soft membranous layers, the outer cuticle of which peels off in thin, white, papery sheets.

The common white or silver birch (*B. alba*) (see fig.) grows throughout the greater part of Europe, and also in Asia Minor, Siberia and North America, reaching in the north to the extreme

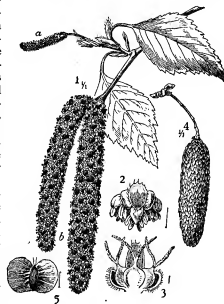

From Strasburger, *Lehrbuch der Botanik*.

Betula alba. 1, Branch with male (a) and female (b) inflorescences; 2, bract with three male flowers; 3, bract with three female flowers; 4, infructescence; 5, fruit. (After Wossido.)

high with a trunk seldom more than 1 ft. in diameter. It flourishes in light soils and is one of the few trees that will grow amongst heather; owing to the large number of "winged seeds" which are readily scattered by the wind, it spreads rapidly, springing up where the soil is dry and covering clearings or waste places.

The birch is one of the most wide-spread and generally useful of forest trees of Russia, occurring in that empire in vast forests, in many instances alone, and in other cases mingled with pines, poplars and other forest trees. The wood is highly valued by carriage-builders, upholsterers and turners, on account of its toughness and tenacity, and in Russia it is prized as firewood and a source of charcoal. A very extensive domestic industry in Russia consists in the manufacture of wooden spoons, which are made to the extent of 30,000,000 annually, mostly of birch. Its pliant and flexible branches are made into brooms; and in ancient Rome the fuses of the lictors, with which they cleared the way for the magistrates, were made up of birch rods. A similar use of birch rods has continued among pedagogues to times so recent that the birch is yet, literally or metaphorically, the instrument of school-room discipline. The bark of the common birch is much more durable, and industrially of greater

value, than the wood. It is impermeable to water, and is therefore used in northern countries for roofing, for domestic utensils, for boxes and jars to contain both solid and liquid substances, and for a kind of bark shoes, of which it is estimated 25 millions of pairs are annually worn by the Russian peasantry. The jars and boxes of birch bark made by Russian peasants are often stamped with very effective patterns. By dry distillation the bark yields an empyreumatic oil, called *diogott* in Russia, used in the preparation of Russia leather; to this oil the peculiar pleasant odour of the leather is due. The bark itself is used in tanning; and by the Samoiedes and Kamchatkans it is ground up and eaten on account of the starchy matter it contains. A sugary sap is drawn from the trunk in the spring before the opening of the leaf-buds, and is fermented into a kind of beer and vinegar. The whole tree, but especially the bark and leaves, has a very pleasant resinous odour, and from the young leaves and buds an essential oil is distilled with water. The leaves are used as fodder in northern latitudes.

The species which belong peculiarly to America (*B. lenta*, *excelsa*, *nigra*, *popyracea*, &c.) are generally similar in appearance and properties to *B. alba*, and have the same range of applications. The largest and most valuable is the black birch (*B. lenta*) found abundantly over an extensive area in British North America, growing 60 to 70 ft. high and 2 to 3 ft. in diameter. It is a wood most extensively used for furniture and for carriage-building, being tough in texture and bearing shocks well, while much of it has a handsome grain and it is susceptible of a fine polish. The bark, which is dark brown or reddish, and very durable, is used by Indians and backwoodsmen in the same way as the bark of *B. alba* is used in northern Europe.

The canoe or paper birch (*B. popyracea*) is found as far north as 70° N. on the American continent, but it becomes rare and stunted in the Arctic circle. Professor Charles Sprague Sargent says: "It is one of the most widely distributed trees of North America. From Labrador it ranges to the southern shores of Hudson's Bay and to those of the Great Bear Lake, and to the valley of the Yukon and the coast of Alaska, forming with the aspen, the larch, the balsam poplar, the banksian pine, the black and white spruces and the balsam fir, the great subarctic transcontinental forest; and southward it ranges through all the forest region of the Dominion of Canada and the northern states." It is a tree of the greatest value to the inhabitants of the Mackenzie river district in British North America. Its bark is used for the construction of canoes, and for drinking-cups, dishes and baskets. From the wood, platters, axe-handles, snow-shoe frames, and dog sledges are made, and it is worked into articles of furniture which are susceptible of a good polish. The sap which flows in the spring is drawn off and boiled down to an agreeable spirit, or fermented with a birch-wine of considerable alcoholic strength. The bark is also used as a substitute for paper. A species (*B. Bhojputtra*) growing on the Himalayan Mountains, as high up as 9000 ft., yields large quantities of fine thin papyery bark, extensively sent down to the plains as a substitute for wrapping paper, for covering the "snakes" of hookahs and for umbrellas. It is also said to be used as writing paper by the mountaineers; and in Kashmir it is in general use for roofing houses.

BIRCH—PFEIFFER, CHARLOTTE (1800–1868), German actress and dramatic writer, was born at Stuttgart on the 23rd of June 1800, the daughter of an estate agent named Pfeiffer. She received her early training at the Munich court theatre, and in 1818 began to play leading tragic rôles at various theatres. In 1825 she married the historian Christian Birch of Copenhagen, but continued to act. From 1837 to 1843 she managed the theatre at Zürich. In 1844 she accepted an engagement at the royal theatre in Berlin, to which she remained attached until her death on the 24th of August 1868. Her intimate knowledge of the technical necessities of the stage fitted her for the successful dramatization of many popular novels, and her plays, adapted and original, make twenty-three volumes, *Gesammelte dramatische Werke* (Leip. 1863–1880). Many still retain the public favour. Her novels and tales, *Gesammelte Novellen und*

Erzählungen, were collected in three volumes (Leip. 1863–1865).

Her daughter, WILHELMINE VON HILLERN (b. 1836), born at Munich, went on the stage, but retired upon her marriage in 1857. After 1880 she lived in Oberammergau and won a reputation as a novelist. Her most popular works are *Ein Arzt der Seele* (1869, 4th ed. 1886); and *Die Geier-Wally* (1883), which was dramatized and translated into English as *The Vulture Maiden* (Leip. 1876).

BIRD, the common English name for feathered vertebrates, members of the class *Aves*. The word in Old Eng. is *brid* and in Mid. Eng. *byrd* or *bryd*, and in early uses meant the young or nestlings only. It is partly due to this early meaning that the derivation from the root of "brood" has been usually accepted; this the *New English Dictionary* regards as "inadmissible." The word does not occur in any other Teutonic language. As a generic name for the feathered vertebrates "bird" has replaced the older "fowl," a common Teutonic word, appearing in German as *Vogel*. "Bird," when it passed from its earlier meaning of "nestlings," seems to have been applied to the smaller, and "fowl" to the larger species, a distinction which was retained by Johnson. In modern usage "fowl," except in "wild-fowl" or "water-fowl," is confined to domestic poultry.

The scope of the anatomical part of the following article is a general account of the structure of birds (*Aves*) in so far as they, as a class, differ from other vertebrates, notably reptiles and mammals, whilst features especially characteristic, peculiar or unique, have been dwelt upon at greater length so far as space permitted. References to original papers indicate further sources of information. For a comprehensive account the reader may be referred to Prof. M. Fürbringer's enormous work *Untersuchungen zur Morphologie und Systematik der Vögel*, 4to., 2 vols. (1888); H. G. Bronn's *Klassen und Ordnungen des Thierreichs*, vol. vi., "Aves," Leipzig, completed 1893 by Gadow; and A. Newton's *Dictionary of Birds*, London, 1896. For the history of the classification of birds see the article ORNITHOLOGY, where also the more important ornithological works are mentioned. EGG, FEATHER (including Moulting), MIGRATION, &c., also form separate articles to which reference should be made. In this article (A) the general anatomy of birds is discussed, (B) fossil birds, (C) the geographical distribution of birds, (D) the latest classification of birds.

A. ANATOMY OF BIRDS

1. Skeleton.

Skull.—When W. K. Parker wrote the account of the skull in the article BIRDS for the 9th edition of the *Encyclopædia Britannica*, he had still to wrestle with the general problem of the composition and evolution of the skull. That chapter of comparative anatomy (together with other anatomical details, for which see the separate articles) is now dealt with in the article SKULL; here only the most avine features are alluded to, and since some of Parker's original illustrations have been retained, the description has been shortened considerably.

One general feature of the adult bird's skull is the almost complete disappearance of the sutures between the bones of the cranium proper, whilst another is the great movability of the whole palatal and other suspensorial apparatus. The occipital condyle (fig. 1) is a single knob, being formed almost wholly by the basi-occipital, while the lateral occipitals (often perversely called occipitals) take but little share in it. Part of the membranous roof between the supra-occipital and parietal bones frequently remains unossified and presents in the macerated skull a pair of fontanelles. The squamosals form the posterior outer margin of the orbits and are frequently continued into two lateral downward processes across the temporal fossa. One of these, the *processus orbitatus posterior*, often combines with an outgrowth of the alisphenoid, and may be, e.g. in cockatoos, continued forwards to the lacrymal bone, so as to form a complete infraorbital bridge. The posterior, so-called *processus Zygomaticus* is very variable; in many Gallii it encloses a foramen by distally joining the orbital process. The ethmoid frequently appears on the dorsal surface between the frontals. There are three epiotic bones (pro-, epi-, orbito-otic). The proptic encloses between it and the lateral occipital the fenestra ovalis, into which fits the columella of the ear. The epiotic is often small, ossifies irregularly,

and fuses with the supra-occipital. The opisthotic lies between the epiotic and the lateral occipital with which it ultimately fuses; in some birds, e.g. in *Larus*, it extends far enough to help to bound the foramen magnum. The basi-sphenoids are ventrally overlaid, and

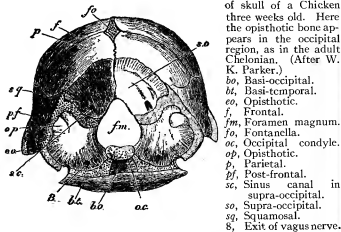

FIG. 1.—End view of skull of a Chicken three weeks old. Here the opisthotic bone appears in the occipital region, as in the adult Chelonia. (After W. K. Parker.)
bo, Basi-occipital.
bt, Basi-temporal.
eo, Opisthotic.
f, Frontal.
fm, Foramen magnum.
fo, Fontanella.
ac, Occipital condyle.
op, Opisthotic.
p, Parietal.
pf, Post-frontal.
sc, Sinus canal in supra-occipital.
sp, Supra-occipital.
sq, Squamosal.
8, Exit of vagus nerve.

later on fused with, a pair of membrane bones, the basi-temporals, homologous in part with the parasphenoid of lower vertebrates. They contribute to the formation of the auditory meatus, and of the right and left carotid canals which accompany the eustachian tubes.

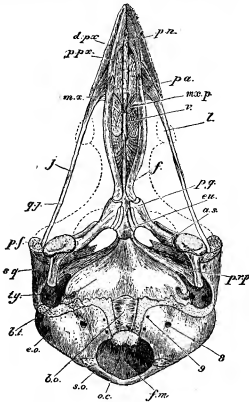
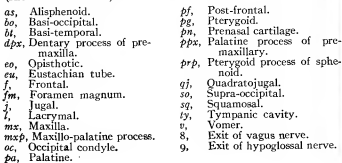

FIG. 2.—Ripe Chick's head, 1½ in. long. (After W. K. Parker.)



In many birds the basi-sphenoids send out a pair of basi-pteriygoid processes by which they articulate with the pterygoids. Dorsolaterally the basi-sphenoid is joined by the alisphenoid, which forms most of the posterior wall of the orbit. The orbito-sphenoids diverge only posteriorly, otherwise they are practically unpaired and form the median interorbital septum, which is very large in correlation with the extraordinary size of the eyeballs.

Prefrontal bones are absent; post-frontals are possibly indicated by a frequently occurring separate centre of ossification in the post-orbital process, to which the frontals always contribute. The lacrymal is always present, and perforated by a glandular duct. Attached to it or the neighbouring frontal is often a supraorbital; infraorbitals occur also, attached to the jugal or downward process of the lacrymal. The nasals were used by A. H. Garrod to distinguish the birds as holorbital (fig. 2) where the anterior margin of the nasal is concave, and schizorbital where this posterior border of the outer nares is continued backwards into a slit which extends beyond the frontal processes of the premaxilla. Many birds possess a more or less well developed cross-joint in front of the frontals and lacrymals, perhaps best developed in *Anseres* and *Psittaci*. Owing to this joint the whole upper beak can be moved up and down with extra facility, according to the shoving forwards or backwards of the palato-ptyergo-quadrate apparatus which moves sledge-like upon the cranial basis. The premaxilla is always unpaired, but each half has three long processes directed backwards; one fuses with the maxillary bone, another helps to form the anterior part of the palate, while the third, together with its fellow, forms the "culmen" and extends backwards to the frontals, or rather to the ethmoid which there crops up on the surface. The maxillaries (fig. 3) have besides others, a maxillo-palatine process directed inwards in a transverse horizontal direction. The palatines are long, always fused anteriorly with the premaxilla, and frequently with the maxillo-palatine processes; posteriorly they slide upon the presphenoidal rostrum, and articulate with the pterygoids; they form the greater part of the palatal roof and border the choanae or inner nares. Between these, resting vertically upon the rostrum, appears the vomer; very variable in shape and size, often reduced to a mere trace, as in the Gall, or even absent, broken up into a pair of tiny splints in Pici.

The taxonomic importance of the configurations of the palate was first pointed out by J. de Cornay. T. H. Huxley, in 1868, divided the carinate birds into Dromaeo-, Schizo-, Desmo-, and Aegithognathae, an arrangement which for many years had a considerable influence upon classification. However, subsequent additions and corrections have detracted much from its value, especially when it became understood that the above sub-orders are by no means natural groups. *Dromaeognathae* have a struthious palate, with a broad vomer meeting in front the broad maxillo-palatine plates, while behind it reaches the pterygoids. The only representatives are the Tinamous. *Schizognathae*, e.g. fowls (fig. 4), pigeons, gulls, plovers, rails and penguins, have the vomer pointed in front while the maxillo-palatines are free, leaving a fissure between the vomer and themselves. The schizognathous formation is doubtless the most primitive, and its representatives form a tolerably natural

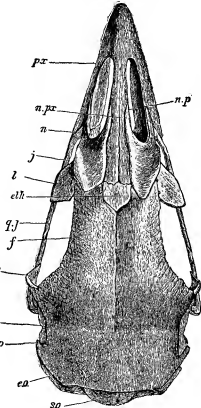

FIG. 3.—Skull of an old Fowl, upper view. (After W. K. Parker.)
eo, Lateral occipital.
npx, Nasal process of premaxillary.
eth, Ethmoid.
f, Frontal.
j, Jugal.
l, Lacrymal.
n, Nostril.
np, Upper process of nasal.
so, Supra-occipital.
sq, Squamosal.

assembly. *Desmognathae* (fig. 5) were supposed to have the maxillo-palatines united across the middle line, either directly or by the inter-

Fig. 4.—Skull of adult Fowl. This skull is unusually *schizognathous*, the vomer (*v*.) being very small, and the maxillo-palatine process (*mxp*) much aborted.

bo, Basi-occipital.
bt, Basi-temporal.
eo, Lateral occipital.
eu, Eustachian tube.
ic, Internal carotid.
j, Jugal.
l, Lacrymal.
mx, Maxilla.
mxp, Maxillo-palatine process.
oc, Occipital condyle.
pa, Palatine.
pf, Post-frontal.
pt, Pterygoid.
prp, Pterygoid process of sphenoid.
px, Premaxilla.
q, Quadrate.
qr, Quadratojugal.
rb, Rostrum of basi-sphenoid.
so, Supra-occipital.
v, Vomer.
8, Exit of vagus nerve.
9, Exit of hypoglossal nerve.
(After W. K. Parker.)

mediation of ossifications in the nasal septum. This is a hopeless assembly. Parker and Fürbringer have demonstrated that desmo-

Fig. 5.—Skull of nestling Sparrowhawk (*Accipiter nisus*), palatal view. The circular space on each side of the basi-temporal (*bt*.) is the opening of the anterior tympanic recess. The basi-ptyergoids (*btpg*) are mere knobs, and the common eustachian opening is seen between them. The maxillo-palatine plates (*mxp*) are dotted to show their spongy character.
bt, Basi-temporal.
btpg, Basi-ptyergoid.
eo, Lateral occipital.
f, Frontal.
fm, Foramen magnum.
j, Jugal.
l, Lacrymal.
m, Mesopterygoid process of W. K. Parker.
mx, Maxillary.
mxp, Maxillo-palatine process.
op, Opisthotic.
pa, Palatine.
pt, Pterygoid.
8, Exit of vagus nerve.
9, Exit of hypoglossal nerve.
(After W. K. Parker.)

px, Premaxilla.
pt, Pterygoid.
q, Quadrate.
qr, Quadratojugal.
sn, Nasal septum.
so, Supra-occipital.
ty, Tympanic cavity.
v, Vomer.
(After W. K. Parker.)

gnathism has been produced in half a dozen ways, implying numerous cases of convergence without any nearer relationship than that they

are all derived from some schizognathous group or other. The *Aegithognathae*, meant to comprise the passerues, woodpeckers and swifts, &c., are really schizognathous but with a vomer which is broadly truncated in front.

The remainder of the appendicular skeleton (fig. 6) of the head requires little description. The maxillaries are connected with the distal anterior corner of the quadrate by the thin, splint-like jugal and quadratojugal. The quadrate is invariably a conspicuous bone and movably articulating with the cranium and by a special process with the pterygoid. The mandible is composed of several bones as in reptiles. The os articulare bears on its inner side the inner mandibular process which serves for the insertion of part of the digastric muscle or opener of the mouth; another portion of this muscle is attached to the os angulare, which frequently forms a

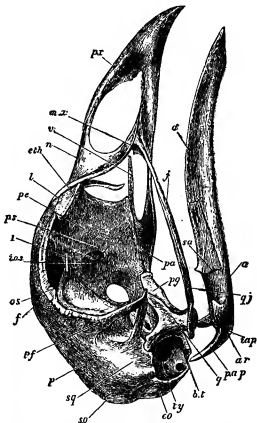

Fig. 6.—Skull of adult Fowl. Here the temporal fossa is bridged over by the junction of the post-frontal and squamosal processes (*pf*, *sq*). The processes of the mandible (*iap*, *pap*) are characteristic of this type, and of the anseres.

a, Angular of mandible.
ar, Articular.
bt, Basi-temporal.
d, Dentary.
eo, Lateral occipital.
eth, Ethmoid.
f, Frontal.
iap, Interangular process of mandible.
ios, Interorbital septum.
j, Jugal.
l, Lacrymal.
mx, Maxillary.
n, Nasal.
os, Orbito-sphenoid.
p, Parietal.
pa, Palatine.
pap, Posterior angular process of mandible.
pe, Ethmoid.
pf, Post-frontal.
pt, Pterygoid.
ps, Pre-sphenoid.
px, Premaxilla.
q, Quadrate.
qr, Quadratojugal.
so, Supra-angular or coronoid.
so, Supra-occipital.
sq, Squamosal.
ty, Tympanic cavity.
v, Vomer.
1, Exit of olfactory nerve.

posterior mandibular process. The greater part of the under-jaw is formed by the right and left dentaries, which in all recent birds are fused together in front. Supra-angular and coronoid splint-bones serve for the insertion of part of the temporal or masseter muscle. Additional splints rest on the inner side of the jaw. Like the crocodyles, birds possess a *siphonium*, i.e. a membranous, or ossified, tube which rises from a pneumatic foramen in the os articulare, on the median side of the articulation, and passes upwards between the quadrate and lateral occipital bone, opening into the cavity of the middle ear.

The *Hyoid apparatus* is, in its detail, subject to many variations in accord with the very diverse uses to which the tongue of birds is

put. It consists of (1) the basihyal variously called copula, or corpus linguae, or unpaired middle portion. (2) The urohyal likewise unpaired, rested ventrally on the larynx. (3) The os entoglossum originally paired, but coalescing into an arrow-headed piece, attached to the anterior end of the basihyal and lodged in the tongue proper. It is homologous with the distal ends of the ceratohyals or ventral elements of the hyoidean or second visceral arch. The dorsal or hyomandibular portion of this same arch is transformed into the auditory chain, ending in the fenestra ovalis. (4) A pair of thyrohyals, homologous with the posterior hyoid horns of mammals, i.e. third visceral or first branchial arch. As the most developed pair in birds they are commonly, although wrongly, called the hyoid horns. They articulate upon facets of the hinder outer corners of the basihyal.

The vertebrae are stereospondylous, the centrum or body and the arch being completely fused into one mass, leaving not even a neuro-central suture. The arch alone sends out processes, viz. the spinous process, the anterior and posterior oblique (commonly called pre- and post-zygapophyses), and the transverse processes. The latter articulate with the tuberculum of the corresponding rib, while the capitulum articulates by a knob on the side of the anterior end of the centrum. In the cervical region the ribs are much reduced, fused with their vertebrae and enclosing the transverse canal or foramen. When the vertebrae are free their centra articulate with each other by complicated joints, exhibiting four types. (1) Amphicoelous; each end of the centrum is concave; this, the lowest condition, is embryonic, but was retained in *Archaeopteryx* and in the thoracic vertebrae of *Icthyornis*. (2) Procoelous, concave in front; only in the atlas, for the reception of the occipital condyle. (3) Opisthocelous, or concave behind, only occasionally found in the thoracic region, e.g. *Spheniscus*. (4) Heterocoelous (fig. 8) or saddle-shaped; the anterior surface is concave in a transverse, but convex in a vertical direction, which on posterior surface shows the conditions reversed. This is the most perfect arrangement attained by the vertebral column, and is typical of, and restricted to, birds. The intervertebral joints are further complicated by the interposition of a cartilaginous or fibrous pad or ring. This pad varies much; it is morphologically the homologue of the pair of basiventral elements which by their lateral extension give origin to the corresponding ribs. Later those pads fuse with the anterior end of the centrum of the vertebra to which they belong; where the vertebral column is rendered inflexible, the disks are ossified with the centra and all trace of them is lost. Sometimes the pad is reduced to a ventral semi-ring or meniscus; it retains its largest almost original shape and size in the second vertebra, the axis or epistropheus, where it forms a separately ossifying piece which connects, and coössifies with, the odontoid process (the centrum of the atlas) and the centrum of the second vertebra. Sometimes the ventral portions of these pads form paired or unpaired little ossifications, then generally described as intercentra; such are not uncommon on the tail. The atlas is composed of three pieces; a pair of lateral elements (the right and left dorsal arch pieces) joining above the spinal cord, and a ventral piece equivalent to the first basiventral elements, i.e. homologous with the intervertebral pads. In the adults the atlas forms a more or less solid ring. In the segment of the *chorda dorsalis* and its sheath persists as the *ligamentum suspensorium* between the central portions of the successive vertebrae.

FIG. 7.—Oshyoides of adult Fowl.

c.h. Ceratohyals (confluent).
b.h. These-called-basihyal, answering to the first basibranchial of a fish.
b.br. Basi-branchial, or urohyal, answering to the first basibranchial series.
c.br. e.br. together form the thyrohyal, answering to the first cervical- and epi-branchials.

and size in the second vertebra, the axis or epistropheus, where it forms a separately ossifying piece which connects, and coössifies with, the odontoid process (the centrum of the atlas) and the centrum of the second vertebra. Sometimes the ventral portions of these pads

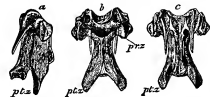

FIG. 8.—A cervical vertebra from the middle of the neck of a Fowl; natural size. a, Side view; b, upper view; c, lower view; prz., pre-zygapophyses; plz., post-zygapophyses.

with the intervertebral pads. In the adults the atlas forms a more or less solid ring. In the segment of the *chorda dorsalis* and its sheath persists as the *ligamentum suspensorium* between the central portions of the successive vertebrae.

In birds we distinguish between the following regions of the axial skeleton. (1) Cervical vertebrae, or those between the skull and the first vertebra which is connected with the sternum by a pair of complete ribs. The last 1 to 5 of these vertebrae have movable ribs which do not reach the sternum, and are called cervico-dorsals. (2) Dorsals, those which begin with the first thoracic rib, and end at the last that is not fused with the ilium. The term "lumbar" vertebrae is inapplicable to birds. (3) Pelvic, all those which are fused with the iliac portion of the pelvis, generally a considerable number. (4) Caudal, those which are not connected with the pelvis.

It is to be noted that often no absolute line of demarcation can be drawn in regard to these regions, their definitions being rather convenient than morphological.

In comparison with all other vertebrates the number of neck-vertebrae of the birds is considerably increased: of lowest number, 14 to 15, is that of most Passeres and many other Coraciiformes; the largest numbers, 20 or 21, are found in the ostrich, 23 in *Cygnus olor* and 25 in the black swan. Dorsal vertebrae frequently have a ventral outgrowth of the centrum; these hypapophyses may be simple vertical blades, L-shaped, or paired knobs; they serve for the attachment of the thoracic origin of the longus collicollis muscle, reaching; their greatest development in *Spheniscus* and *Colymbidae*. In many birds some of the thoracic vertebrae are more or less coössified, in most pigeons for instance the 15th to 17th; in most Gall the last cervical and the next three or four thoracics are coalesced, &c. The pelvic vertebrae include of course the sacrum. There are only two or three vertebrae which are behind to those of the reptiles; these true sacrales are situated at one level just behind the acetabulum; as a rule between these two primary sacral vertebrae issues the last of the spinal nerves which contributes to the composition of the sciadic plexus. These true sacrales alone are connected with the ilium by processes which are really equivalent to modified ribs; but the pelvis of birds extends considerably farther forward and backward, gradually coming into contact with other vertebrae, which in various ways send out connecting transverse processes or buttresses, and thus become pre- and post-sacral vertebrae (fig. 9). The most anterior part of the ilium often overlaps one or more short lumbar ribs and fuses with them, or even a long, complete thoracic rib. Similarly during the growth of the bird the posterior end of the ilium connects itself with the transverse processes of vertebrae which were originally free, thus transforming them from caudals into secondary post-sacrales. Individual, specific and generic variations are frequent.

The last six or seven caudal vertebrae coalesce into the pygostyle, an upright blade which carries the rectrices. Such a pygostyle is absent in *Archaeopteryx*, *Ullsperornis*, *Tinami* and *Ratitae*, but it occurs individually in old specimens of the ostrich and the kiwi. In *Icthyornis* it is very small. In all the *Neornithes* the total number of caudal vertebrae, inclusive of those which coalesce, is reduced to at least 13.

Sternum (figs. 10 and 11).—Characteristic features of the sternum are the following. There is a well-marked *processus lateralis anterior* (the right and left together equivalent to the mammalian manubrium), which is the product of two or three ribs, the dorsal parts of which reduced ribs remain as cervico-dorsal ribs. Then follows the rib-bearing portion, and then the *processus lateralis posterior*; this also is the product of ribs, consequently the right and left processes together are equivalent to the xiphoid process or xiphisternum of the mammals. The lateral process in most birds sends out an outgrowth, directed out and upwards, overlapping some of the ribs, the *processus obliquus*. The median and posterior extension of the body of the sternum is a direct outgrowth of the latter, therefore

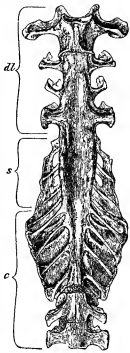

FIG. 9.—The "sacrum" of a young Fowl; natural size, seen from below. d.l., Dorso-lumbar, s, sacral, c, caudal vertebrae.



FIG. 10.—A side view of the Chick's sternum.

called meta-sternum. The anterior margin of the sternum, between the right and left anterior lateral processes receives in sockets the feet of the coracoids. Between them arises a median crest, which varies much in extent and composition, and is of considerable taxonomic value. It is represented either by a *spina interna* or by a

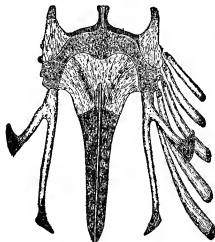

FIG. 11.—Sternum of a Chick (*Gallus domesticus*) three days old, lower view. The cartilage is shaded and dotted, and the bony centers are light and striated.

spina externa, or by both, or they join to form a *spina communis* which is often very large and sometimes ends in a bifurcation. Eventually, when the right and left feet of the coracoids overlap each other, the anterior sternal spine contains a foramen. The keel, or *carina sterni*, is formed as a direct cartilaginous outgrowth of the body of the sternum, ossifying from a special centre.

This keel is much reduced in the New Zealand parrot, *Stringops*, less in various flightless rails, in the dodo and solitaire. It is absent in the Ratitae, which from this feature have received their name, but considerable traces of a cartilaginous keel occur in the embryo of the ostrich, showing undeniably that the absence of a keel in the recent bird is not a primitive, fundamental feature. The keel has been lost, and is being lost, at various epochs and by various groups of birds. The swamphawk, *Hesperornis* (see ODONTORNITHES) was also devoid of such a structure. In many birds the spaces between the metasternum and the posterior processes and again the spaces between this and the oblique process are filled up by proceeding ossification and either remain as notches, or as fenestrae, or they are completely abolished so that the breastbone is turned into one solid more or less oblong plate.

Shoulder Girdle.—Scapula, coracoid and clavicle, meet to form the foreman triosseum, through which passes the tendon of the *supracoracoideus*, or *subclavius* muscle to the *tuberculum superius* of the humerus. The coracoid is one of the most characteristic bones of the bird's skeleton. Its upper end forms the acrocoracoid process, against the inner surface of which leans the proximal portion of the clavicle. From the inner side of the neck of the coracoid arises the precoracoid process, the remnant of the precoracoid. Only in the ostrich this element is almost typically complete, although soon fused at either end with the coracoid. Near the base of the precoracoid process is a small foramen for the passage of the *nervus supracoracoideus*. In most birds the feet of the coracoids do not touch each other; in some groups they meet, in others one overlaps the other, the right lying ventrally upon the left. The scapula is sabre-shaped, and extends backwards over the ribs, lying almost parallel to the vertebral column. This is a peculiar character of all birds. The clavicles, when united, as usual, form the furcula; mostly the distal median portion is drawn out into a hypocleidium of various shape. Often it reaches the keel of the sternum, with subsequent syndesmosis or even synostosis, e.g. in the gannet. In birds of various groups the clavicles are more or less degenerated, the reduction beginning at the distal end. This condition occurs in the Ratitae as well as in the well-flying *Platyrrhinae* amongst parrots.

The fore-limb or wing (fig. 12); highly specialized for flight, which, initiated and made possible mainly by the strong development of quill-feathers, has turned the wing into a unique organ. The humerus with its crests, ridges and processes, presents so many modifications characteristic of the various groups of birds, that its configuration alone is not only of considerable taxonomic value but that almost any genus, excepting, of course, those of Passeres, can be "spotted" by a close examination and comparison of this bone. When the wing is folded the long glenoid surface of the head of the humerus is bordered above by the *tuberculum externum* or *superius*, in the middle and below by the *tuberculum medium* or *inferius* for the insertion of the *coraco-brachialis posterior* muscle. From the outer tuberculum extends the large *crista superior* (insertion of *pectoralis major* and of *deltoideus major* muscles). The ventral portion of the neck is formed by the strong *crista inferior*, on the median side of which is the deep *fossa subtrochanterica* by which air sacs enter the humerus. On the outer side of the humerus between the head and the *crista inferior* is a groove lodging one of the coraco-humeral ligaments. The distal end of the humerus ends in a trochlea, with

a larger knob for the ulna and a smaller oval knob for the radius. Above this knob is often present an ectepicondylar process whence arise the tendons of the ulnar and radial flexors. The radius is the straighter and more slender of the two forearm bones. Its proximal end forms a shallow cup for articulation with the outer condyle of the humerus; the distal end bears a knob which fits into the radial carpal. The ulna is curved and rather stout; it articulates with both carpal bones; the cubital quills often cause rugosities on its dorsal surface. Of wrist-bones only two remain in the adult bird; the original distal carpals coalesce with the proximal end of the metacarpals. These are reduced, in all birds, to three, but traces of the fourth have been observed in embryos. The first metacarpal is short and fuses throughout its length with the second. This and the third are much longer and fuse together at their upper and distal

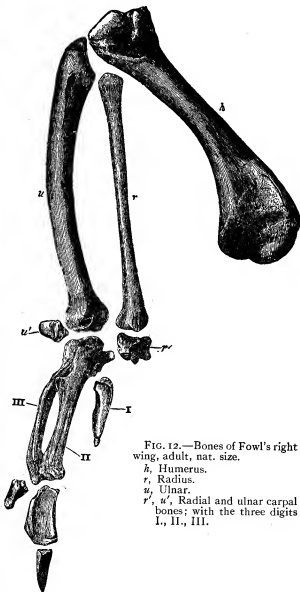

FIG. 12.—Bones of Fowl's right wing, adult, nat. size.

h, Humerus.

r, Radius.

u, Ulnar.

r', Radial and ulnar carpal bones; with the three digits

I, II, III.

ends, leaving as a rule a space between the shafts. The pollex and the third finger are as a rule reduced to one phalanx each, while the index still has two. The first and second fingers frequently carry a little claw. The greatest reduction of the hand-skeleton is met with in *Dromaeus* and in *Apteryx*, which retain only the index finger. It is of importance for our understanding of the position of the Ratitae in the system, that the wing-skeleton of the ostrich and rhea is an exact repetition of that of typical flying birds; the bones are much more slender, and the muscles are considerably reduced in strength also to a lesser extent in numbers, but the total length of the wing of an ostrich or a rhea is actually and comparatively enormous. Starting with the kiwi and cassowary, people have got into the habit of confounding flightless with wingless conditions. It is absolutely certain that the wings of the Ratitae bear the strongest testimony that they are the descendants of typical flying birds.

The *pelvis* (fig. 13), consisting of the sacrum (already described) and the pelvic arch, namely ilium, ischium and pubis, it follows that only birds and mammals possess a pelvis proper, whilst such is entirely absent in the Amphibia and in reptiles with the exception of some of the Dinosaurs. The ventral inner margin of the pre-acetabular portion of the ilium is attached to the pre-sacral vertebrae, whilst the inner and dorsal margin of the postacetabular portion is attached to the primary sacral and the post-sacral vertebrae. In rare cases the right and left preacetabular blades fuse with each other above the spinous processes. In front of the acetabulum a thick process of the ilium descends to meet the pubis, and a similar process behind meets the ischium. The acetabulum is completely surrounded by these three bones, but its cup always retains an open foramen; from its posterior rim arises the strong antitrochanter. The ischium and postacetabular ilium originally enclose the ischiadic notch or *incisura ischiadica*. This primitive condition occurs only in the Odontornithes (*q.v.*), *Ratitae* and *Tinami*; in all others this notch becomes converted into a *foramen ischiadicum*, through which pass the big stems of the ischiadic nerves and most of the blood-vessels of the hind-limb. The pubis consists of a short anterior portion (*spina publica* or pectineal process, homologous with the prepubic process of Dinosaurs) and the long and slender pubis proper (equivalent to the *processus lateralis pubis* of most reptiles). The shaft of the pubis runs parallel with that of the ischium, with which it is connected by a short ligamentous or bony bridge; this cuts off from the long *incisura pubo-ischiadica* a proximal portion, the *foramen obturatum*, for the passage of the obturator nerve. Only in the ostrich the distal ends of the pubes meet, forming a dagger-shaped symphysis, which is curved forwards. The pectineal process

the so-called hypotarsus, which in various ways, characteristic of the different groups of birds (with one or more sulci, grooved or perforated), acts as guiding pulley to the tendons of the flexor muscles of the toes. Normally the four toes have two, three, four and five phalanges respectively, but in *Cypselus* the number is reduced to three in the front toes. Reduction of the number of toes (the fifth shows no traces whatever, not even in *Archaeopteryx*) begins with the hallux, which is completely or partly absent in many birds; the second toe is absent in *Sturnio* only. The short feet of the penguins are quite plantigrade, in adaptation to which habit the metatarsals lie in one plane and are incompletely co-ossified, thus presenting a pseudo-primitive condition.

LITERATURE.—Only a mere fraction of the enormous literature dealing with the skeleton of birds can here be mentioned.

M. E. Alix *Essai sur l'appareil locomoteur des oiseaux* (Paris, 1874); E. Blanchard, "Recherches sur les caractères ostéologiques des oiseaux appliquées à la classification," *Ann. Sci. Nat. Ser. iv.* t. xi.; W. Dames, "Über Brustbein Schuler- und Beckengürtel der Archaeopteryx," *Math. Naturw. Mitth.*, Berlin, vii., 1897, pp. 476-492; T. C. Eytton, *Osteologia avium* (London, 1858-1883), with many plates; C. Gegenbaur, *Untersuch. z. vergl. Anat. d. Wirbelthiere, I. Corpus und Tarsus, II. Schuler- und Beckengürtel* (Leipzig, 1864-1866); P. Harting, *L'Appareil épisternal des oiseaux* (Utrecht, 1864); T. H. Huxley, "On the Classification of Birds and on the Taxonomic Value of the Modifications of certain of the Cranial Bones..." *P.Z.S.*, 1867; G. Jaeger, "Das Wirbelkörpergelenk der Vögel," *Sitzb. K. Ak. Wiss.*, Wien, xxxiii., 1858; A. Johnson, "On the Development of the Pelvic Girdle and Skeleton of the Hind-limb in the Chick," *Q.J.M.S.*, xxii., 1883, pp. 399-411; K. F. Kessler, "Osteologie der Vogelfüße," *Bull. Soc. Imp. Nat. Mosc.*, xiv., 1841; B. Lindsay, "On the Avian Sternum," *P.Z.S.*, 1885; E. Mehnert, "Entwicklung des Oesphelus der Vögel," *Morph. Jahrb.*, xiii., 1877; A. B. Meyer, *Abbildungen von Vogel-Skeletten* (Dresden, 1879); St. G. Mivart, "On the Axial Skeleton of the Ostrich, Sturnithonidae, Pelecanidae," *Trans. Zool. Soc. Lond.*, xiii., 1877; S. Morse, "On the Carpus and Tarsus of Birds," *Ann. Lyc. N.H.*, New York, x., 1874; J. S. Parker, "Observations on the Anatomy and Development of Apteryx," *Phil. Trans.*, 1890, pp. 1-110, 17 pls.; W. K. Parker, numerous papers in *Trans. L.S., R.S. and Z.S.*, e.g., "Osteology of Gallinaceous Birds," *T.Z.S.*, v., 1863; "Rhinochetus," *ibid.*, vi., 1863; "Aegithognathus Birds," *ibid.*, x., 1878; "Skull in the Ostrich Tribe," *Phil. Trans.*, vol. 156, 1866; "Skull of Common Fowl," *ibid.*, vol. 159, 1870; "Skull of Picidae," *T. Linn. Soc.*, 1875; "Monograph on the Structure and Development of the Shoulder-girdle and Sternum," *Ray Soc. London*, 1868; W. P. Pycraft, "On the Morphology and Phylogeny of the Palaeognathae (*Ratitae* and *Crypturi*) and Neognathae," *Trans. Zool. Soc.* xv., 1900, pp. 140-290, pls. 42-45; "Some points in the morphology of the Palate of the Neognathae," *T. Linn. Soc.* 28, pp. 343-357, pls. 31-32; P. Suschkin, "Zur Morphologie des Vogelskeletts," *Schädel von Tinnunculus*," *Mem. Soc., Mosc.*, xvi., 1900, pp. 1-63, pls.

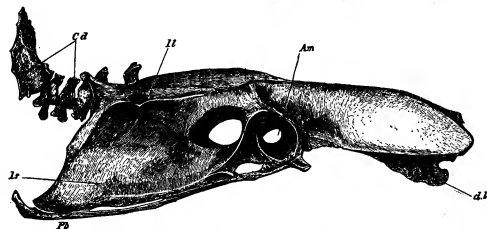

FIG. 13.—Pelvis and caudal vertebrae of adult Fowl, side view, natural size.

Il, Ilium; Is, ischium; Pb, pubis; d, dorso-lumbar vertebrae; Cd, caudal vertebrae; An, acetabulum.

is variable; it may grow entirely from the pubis, or both pubis and ilium partake of its formation, or lastly its pubic portion may be lost and the process is entirely formed by the ilium. It is largest in the Gall and some of the Cuculi, in others it is hardly indicated. It served originally for the origin of the ambiens muscle (see *Muscular System* below); shifting or disappearance of this muscle, of course, influences the process.

The Hind Limb.—The femur often possesses a well visible pneumatic foramen on the median side of the proximal end of its shaft. The inner condyle, the intercondylar sulcus, and a portion only of its outer condyle, articulate with corresponding facets of the tibia. The outer condyle articulates mainly with the fibula. There is a patella, intercalated in the tendon of the *feriori-tibialis* or *extensor cruris* muscle. In *Colymbus* the patella is reduced to a small ossicle, its function being taken by the greatly developed pyramidal *processus tibialis anterior*; in *Podiceps* and *Hesperornis* the patella itself is large and pyramidal. The distal half of the fibula is very slender and normally does not reach the ankle-joint; it is attached to the peroneal ridge of the tibia. On the anterior side of the tibia, is the intercondylar sulcus, which is crossed by an oblique bridge of tendon or bone, acting as a pulley for the tendon of the *extensor digitorum communis* muscle. The condyles of the tibia are in reality not parts of this bone, but are the three proximal tarsalia which fuse together and with the distal end of the tibia. The distal tarsalia likewise fuse together, and then on to the upper ends of the metatarsals; the *tarsus centrale* remain, sometimes as a separate osseous nodule, buried in the inter-articular pad. Consequently the ankle-joint of birds is absolutely cruro-tarsal and tarso-metatarsal, i.e. intertarsal, an arrangement absolutely diagnostic of birds if it did not also occur in some of the Dinosaurs. Of the metatarsals the fifth occurs as an embryonic vestige near the joint; the first is reduced to its distal portion, and is, with the hallux, shoved on to the inner and posterior side of the foot, at least in the majority of birds. The three middle metatarsals become fused together into a cannon bone; the upper part of the third middle metatarsal projects behind and forms

the so-called hypotarsus, which in various ways, characteristic of the different groups of birds (with one or more sulci, grooved or perforated), acts as guiding pulley to the tendons of the flexor muscles of the toes. Normally the four toes have two, three, four and five phalanges respectively, but in *Cypselus* the number is reduced to three in the front toes. Reduction of the number of toes (the fifth shows no traces whatever, not even in *Archaeopteryx*) begins with the hallux, which is completely or partly absent in many birds; the second toe is absent in *Sturnio* only. The short feet of the penguins are quite plantigrade, in adaptation to which habit the metatarsals lie in one plane and are incompletely co-ossified, thus presenting a pseudo-primitive condition.

2. Muscular System.

Of the muscles of the stem or axis, those of the neck and tail are well-developed and specialized, while those of the lower back are more or less reduced, or even completely degenerated owing to the rigidity of this region, brought about by the great antero-posterior extent of the pelvis.

The muscles of the limbs show a great amount of specialization, away from the fundamental reptilian and mammalian conditions. The muscles of the fore limbs are most aberrant, but at the same time more uniformly developed than those of the hinder extremities. The reasons are obvious. The whole wing is a unique modification, deeply affecting the skeletal, muscular and tegumentary structures, but fluttering, skimming, sailing, soaring are motions much more akin to one another than climbing and grasping, running, scratching, paddling and wading. The modifications of the hind-limbs are in fact many times greater (such as extremely long legs, with four, three or only two toes; very short legs, almost incapable of walking, with all four toes directed forwards, or two or one backwards, and two or more connected and therefore bound to act together, in various

ways. Thus it has come to pass that the muscles of the hind limbs are, like their framework, more easily compared with those of reptiles and mammals than are the wings, whilst within the class of birds they show an enormous amount of variation in direct correlation with their manifold requirements. The only really aberrant modifications of the wing-muscles are found in the Ratitae, where they are, however, all easily explained by reduction, and in the penguins, where the wings are greatly specialized into blades for rowing with screw-like motions.

The wing of the bird is folded in a unique way, namely, the radius parallel with the humerus, and the whole wrist and hand with their ulnar side against the ulna; upper and forearm in a state of supination, the hand in that of strong abduction. Dorsal and ventral bending, even in the extended wing, is almost impossible. Consequently only a few of the original extensor muscles have been preserved, but these are much modified into very independent organs, notably the *extensor metacarpi radialis longus*, the *ext. metac. ulnaris*, and the two *radialis*- and *ulnaris-metacarpi* muscles, all of which are inserted upon the metacarpus by means of long tendons. The chief muscular mass, arising from the sternum in the shape of a U, is the *pectoralis* muscle; its fibres converge into a strong tendon, which is inserted upon the greater tubercle and upper crest of the humerus, which it depresses and slightly rotates forwards during the downstroke. This great muscle covers completely the *supracoracoideus*, generally described as the second pectoral, or *subclavius* muscle, in reality homologous with the mammalian *supraspinatus* muscle. This arises mostly from the angle formed by the keel with the body of the sternum, passes by a strong tendon through the *foramen triosseum*, and is inserted upon the upper tubercle of the humeral crest, which it rotates and abducts. The extent of the origin of this muscle from the sternum, on which it leaves converging, parallel or diverging impressions, is of some taxonomic value.

Much labour has been bestowed by A. H. Garrod and Max Fürbringer upon the investigation of the variations of the inserting tendons of the patagial muscles (fig. 14), mainly from a taxonomic

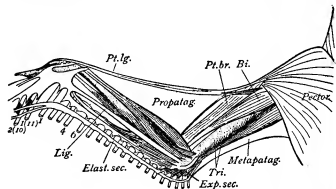

From Newton's Dictionary of Birds, by permission of A. & C. Black.

FIG. 14.—Wing muscles of a Goose. *Bi.*, Biceps; *Elast. sec.*, elastic vinculum and *Exp. sec.*, *expansor secundarius* muscles; *Pt. br.* and *Pt. lig.*, short and long propatagial muscles; *Tri.*, triceps.

point of view. The *propatagialis longus* muscle is composed of slips from the deltoid, pectoral, biceps and *oculalis* muscles. Its strong belly originates near the shoulder joint from clavicle, coracoid and scapula. Its elastic tendon runs directly to the carpus, forming thereby the outer margin of the anterior patagium, or fold of skin between the upper and forearm, which it serves to extend, together with the *propatagialis brevis* muscle. This runs down the anterior and outer side of the upper arm, and is attached to the proximal tendon of the *extensor metacarpi radialis longus*, a little below the outer condyle of the humerus. In most birds the tendon is split into several portions, one of which is often attached to the outer side of the ulna, below the elbow joint, while others are invariable but characteristic ways connected with similar slips of the *propatagialis longus*. The posterior patagium, the fold between trunk and inner surface of the upper arm, is stretched by the *metapatagialis* muscle, which is composed of slips from the *serratus superficialis*, *latissimus dorsi* and the *expansor secundarius* muscles. This, the stretcher of the cubital quills, is a very interesting muscle. Arising as a long tendon from the sterno-scapular ligament, it passes the axilla by means of a fibrous pulley, accompanies the axillary vessels and nerves along the humerus, and is inserted by a few fleshy fibres on the base of the last two or three cubital quills. Here, alone, at the distal portion of the tendon, occur muscular fibres, but these are unstriated, belonging to the category of cutaneous muscles. We have here the interesting fact that a muscle (portion of the *triceps humeri* of the reptiles) has been reduced to a tendon, and in a secondary way has become connected with cutaneous muscles, which, when strongly developed, represent its belly.

The *flexor digitorum sublimis* muscle arises fleshy from the long elastic band which extends from the inner humeral condyle along the ventral surface of the ulna to the ulnar carpal bone, over which the tendon runs to insert itself on the radial anterior side of the first phalanx of the second digit. Owing to the elasticity of the humero-carpal band the wing remains closed without any special muscular exertion, while, when the wing is extended, this band assists in keeping it taut. The arm-muscles have been studied in an absolutely exhaustive manner by Fürbringer, who in his monumental work has tabulated and then scrutinized the chief characters of fourteen selected muscles. The results are as interesting from a morphological point of view (showing the subtle and gradual modifications of these organs in their various adaptations), as they are sparse in taxonomic value, far less satisfactory than are those of the hind-limb. He was, however, the first to show clearly that the Ratitae are the retrograde descendants of flying ancestors, that the various groups of surviving Ratitae are, as such, a polyphyletic group, and he has gone fully into the interesting question of the development and subsequent loss of the power of flight, a loss which has taken place not only in different orders of birds but also at various geological periods, and is still taking place. Very important are also the investigations which show how, for instance in such fundamentally different groups as petrels and gulls, similar bionomic conditions have produced step by step a marvellously close resemblance, not only in general appearance, but even in many details of structure.

Of the muscles of the hind-limbs likewise only a few can be mentioned. The *ambiens* muscle, long and spindle-shaped, lying immediately beneath the skin, extending from the pectineal process or ilio-pubic spine to the knee, is the most median of the muscles of the thigh. When typically developed its long tendon passes the knee-joint, turning towards its outer side, and lastly, without being anywhere attached to the knee, it forms one of the heads of this peculiar muscle (which is similarly developed in crocodiles, but absent, or not differentiated from the ilio-tibial and ilio-femoral mass, in other vertebrates) is that its contraction helps to close the second and third toes. Too much has been made of this feature since Sir R. Owen (*Cyclop. Anat. Phys.*, i. p. 296, 1835), following G. A. Borelli (*De motu animalium*, Rome, 1680), explained that birds are enabled to grasp the twig on which they rest whilst sleeping, without having to make any muscular exertion, because the weight of the body bends the knee and ankle-joints, over both of which pass the tendons of this compound muscle. There are many perching birds, e.g. all the Passeres, which do not possess this muscle at all, whilst many of those which have it fully developed, e.g. Anseres, can hardly be said to "perch".

Garrod went so far as to divide all the birds into *Homologonatae* and *Anomologonatae* according to the presence or absence of the ambiens muscle. This resulted in a failure. To appreciate this, it is sufficient to enumerate the birds without the critical muscle: *Passeriformes* and *Coraciiformes*, without exception; *Ardeae* and *Podicipes*; lastly various genera of storks, pigeons, parrots, petrels and auks. The loss has taken place, and still takes place, independently in widely different groups. It follows, first, that the absence of this muscle does not always indicate relationship; secondly that we can derive birds that are without it from a group which still possess it, but not vice versa. The absence of the ambiens muscle in all owls, which apparently use their feet in the same way as the *Accipitres* (all of which possess it), indicates that owls are not developed from the latter, but from a group which, like the other *Coraciiformes*, had already lost their muscle.

Garrod further attributed much taxonomic value to the *caudilio-femoralis* muscle (fig. 15). This, when fully developed, consists of two parts, but inserted by a single ribbon-like tendon upon the hinder surface of the femur, near the end of its first third; the caudal part, *femoro-caudalis*, expressed by Garrod by the symbol *A*, arises from transverse processes of the tail; the iliac part (*accessorio-femoro-caudal* of Garrod, with the symbol *B*), arises mostly from the outer surface of the postacetabular ilium. Of course this double-headed condition is the more primitive, and as such exists in most nidigulous birds, but in many of these, as well as in many nidicolous birds, either the caudal or the iliac head is absent, and in a very few *Phalcones*, *Dichotyles*, *Sialotarsus* and some *Cathartes* the whole muscle is absent. The *caudilio-flexorius* (*semitendinosus* of most authors) arises from the transverse processes of the tail, and from the distal half of the postacetabular ilium, thence passing as a broad ribbon to the popliteal region, where it splits into two portions. One of these, broad and fleshy, is inserted upon the posterior surface of the distal third of the femur. This portion, morphologically the original, was named the "accessory semitendinosus" with the symbol *Y*; the other portion descends on the hinder aspect of the leg and joins the fascia of the inner femoral head of the *gastrocnemius* muscle. In many birds the insertion is shifted from the femur to the neck of the tibia, in which case the "accessory" is said to be absent, a condition expressed by Garrod by the symbol *X*. By combining the four symbols *A*, *B*, *X*, *Y*, according to their presence or absence, Garrod got a considerable number of formulae, each of which was overruled, so to speak, by the two categories of the presence or absence of the *ambiens* muscle. It needs hardly to be pointed out why such a purely mechanical scheme was doomed to

failure. Its author, with a considerable mathematical and mechanical bias, reckoned entirely with the quantity, not with the quality of its units, and relied almost implicitly upon his formulae. It is, however, fair to state that his system was not built entirely upon these muscular variations, but rather upon a more laborious combination of anatomical characters, which were so selected that they presumably could not stand in direct correlation with each other, notably the oil-gland, caeca, carotids, nasal bones and above all, the muscles of the thigh. He was, indeed, the first to show clearly the relationship of the heron-like birds with the Steganopodidae; of stork-like birds with the American vultures; the great difference between the latter and the other birds of prey; the connexion of the gulls and auks with the plovers, and that of the sand-grouse with the

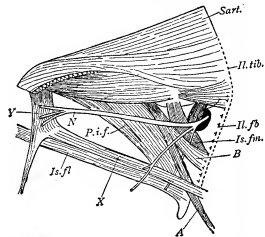

From Newton's Dictionary of Birds.

FIG. 15.—Left thigh-muscles of a Rail. Outer view after removal of the *Il.f.b.*, ilio-fibularis and *Il.tib.*, ilio-tibialis.

- | | |
|--|-----------------------------|
| A, Caudal. | N, Sciatic nerve. |
| B, Iliac portion of caud-ilio-femoralis. | I.f.f., Ilio-femoralis. |
| X, Caud-ilio-flexorius. | I.s.f., Ilio-sci-fibularis. |
| Y, "Accessory" portion of the same. | Sart., Sartorius. |
| P.f., Pubischioc-femoralis. | |

pigeons—discoveries expressed in the new terms of the orders *Ciconiiformes* and *Charadriiformes*. These are instances, now well understood, that almost every organic system, even when studied by itself, may yield valuable indications as to the natural affinities of the various groups of birds. That Garrod has so very much advanced the classification of birds is ultimately due to his comprehensive anatomical knowledge and general insight.

To return to these thigh muscles. The most primitive combination, *A B X Y*, is the most common; next follows that of *A X Y*, meaning the reduction of *B*, i.e. the iliac portion of the *caud-ilio-femoralis*; *A B X* and *B X Y* are less common; *A X* and *X Y* are rare and occur only in smaller groups, as in sub-families or genera; *B X* occurs only in *Podiceps*. But the greatest reduction, with only *A* remaining, is characteristic of such a heterogeneous assembly as *Accipitres*, *Cypselidae*, *Trochilidae*, *Strigidae* and *Fregata*. This fact alone is sufficient proof that these conditions, or rather reductions, have been acquired independently of the various groups. *A B Y*, *A B X*, *B X Y* and *B* do not occur at all, some of them for obvious reasons. Occasionally there is an instructive progressive evolution expressed in these formulae; for instance *Phaethon*, in various other respects the lowest of the *Steganopodidae*, has *A X Y*, *Sula* and *Phalacrocorax* have *A X*, *Fregata*, the most specialized of these birds, has arrived at the reduced formula *A*. Further, the combinations *B X Y* and *A X Y* cannot be derived from each other, but both directly from *A B X Y* in two different directions. Keeping this in mind, we may fairly conclude that the flamingo with *B X Y* points to an ancestral condition *A B X Y*, which is still represented by *Platalea* and *Ibis*, whilst the other storks proper have taken a different line, leading to *A X Y*.

LITERATURE.—Well nigh complete lists of the enormous myological literature are contained in Fürbringer's *Untersuchungen zur Morphologie und Systematik der Vögel*, and in Gadow's *Die Vögel von Bronn's Klassen und Ordnungen des Tierreichs*. Only a few papers and works can be mentioned here, with the remark that few authors have paid attention to the all-important innervation of the muscles. A. Carlsson, *Beiträge zur Kenntniss der Anatomie der Schwimmvögel*; K. Svensk, *Vet. Ak. Handlingar*, J. G. No. 3 (1884); A. A. Alix, *Essai sur l'appareil locomoteur des oiseaux* (Paris, 1874); H. Gadow, *Zur vergl. Anat. der Muskulatur des Beckens und der hinteren Gliedmasse der Rattvögel*, 4^e (Jena, 1880); A. H. Garrod, "On Certain Muscles of the Thigh of Birds and on their value in Classification," *P.Z.S.*, 1873, pp. 624-644; 1874, pp. 11-123. Other papers by Garrod, 1875, pp. 339-348 (deep plantar tendons); 1876, pp. 506-519 (wing-muscles

of Passeres), &c.; J. G. de Man, *Vergelijkende myologische en neurologische Studien over Amphibien en Vogels* (Leiden, 1873); (Corvidae); A. Milne-Edwards, *Recherches anatomiques et paléontologiques pour servir à l'histoire des oiseaux fossiles de la France* (Paris, 1867-1868), tom. i. pls. ix-x. (*Aquila* and *Gallus*); R. Owen, article "Aves," *Todd's Cyclopaedia of Anat. and Phys.* i. (London, 1835); "On the Anatomy of the Southern *Apteryx*," *Trans. Zool. Soc.*, iii., 1849; A. Quennerstedt, "Studien über Anatomie," *Lunds Univers. Årsskr.*, 1872 (hind-limb of swimming birds); G. Rolleston, "On the Homologies of Certain Muscles connected with the Shoulder-joint," *Trans. Linn. Soc.*, xxvi., 1868; R. W. Shufeldt, *The Myology of the Raven* (London, 1891); M. Watson, "Report on the Anatomy of the *Spheniscidae*," *Challenger Reports*, 1883.

3. Nervous System.

Brain.—The more characteristic features of the bird's brain show clearly a further development of the reptilian type, not always terminal features in a direct line, but rather side-departures, sometimes even a secondary sinking to a lower level, and in almost every case in a direction away from those fundamentally reptilian lines which have led to the characters typical of, and peculiar to, the mammals.

The forebrain forms the bulk of the whole brain, but the large size of the hemispheres is due to the greater development of the basal and lateral portions (*pedunculi cerebri* and *corpora striata*), while the pallium (the portion external to the lateral ventricles) is thin, and restricted to the median side of each hemisphere. As a direct result of this undoubtedly secondary reduction of the pallium—due to the excessive preponderance of the basal and lateral parts—the corpus callosum (i.e. the transverse commissure of the right and left pallium) is in birds reduced to a narrow flat bundle of a few white fibres; it is situated immediately above and behind the much stronger anterior commissure, i.e. the connexion between the *corpora striata*, or chief remaining part of the hemispheres. Owing to the small size of the olfactory lobes the anterior arms of the latter commissure are wanting. There is very little grey matter in the cortex of the hemispheres, the surface of which is devoid of convolutions, mostly quite smooth; in others, for instance pigeons, fowls and birds of prey, a very slight furrow might be compared with the Sylvian fissure.

The Thalamencephalon is much reduced. The epiphysis, or pineal body, is quite as degenerate as in mammals, although still forming a long stalk as in reptiles. In birds, this stalk consists entirely of long vessels, and in the adult enclose no terminal vesicle, and fuse with the membranous lining of the skull. The midbrain is represented chiefly by the optic lobes, the cortex of which alone is homologous with the *corpora quadrigemina* of the mammals. Their transverse dorsal connexion is the posterior commissure; otherwise the whole roof portion of the midbrain is reduced to a thin membrane, continuous with that which covers the Sylvian aqueduct, and this ventricle sends a lateral cavity into each optic lobe, as is the case in reptiles. The right and left lobes themselves are rent asunder (so to speak), so that they are freely visible from above, filling the corners formed by the hemispheres and the cerebellum. The latter is, in comparison with mammals, represented by its middle portion only, the *vermis*; in a sagittal section it shows an extremely well developed *arbor vitae*, produced by the transverse, repeated folding of the whole organ. In comparison with reptiles the cerebellum of birds shows high development. Forwards it covers, and has driven asunder, the optic lobes; backwards it hides the much shortened medulla oblongata.

Several futile attempts have been made to draw conclusions as to the intelligence of various birds, from comparison of the weight of the whole brain with that of the body, or the weight of the hemispheres with that of other parts of the central nervous system. The *brachial plexus* is formed by four or five of the lowest cervical nerves; the last nerve of this plexus often marks the boundary of the cervical and thoracic vertebrae. The composition of the plexus varies much, not only in different species, but even individually. The most careful observations are those by Fürbringer. The serial number of these nerves depends chiefly upon the length of the neck, the extremes being represented by *Cypselus* (10th-11th cervical) and *Cygnus* (22nd-24th), the usual numbers of the common fowl being the 13th-17th nerves.

The *Cruial Plexus* is divided into a crural, ischiadic and pubic portion; the first is generally composed of three nerves, the hindmost of which, the *furcula*, is inserted in most birds between the 10th and 11th lumbal-sacral vertebrae, and then divides, one half going to the crural, the other to the sciatic portions. The *obtusatorius* nerve invariably comes from the two main stems of the crural. The ischiadic portion consists generally of five or six nerves, which leave the pelvis as one thick system through the ilio-ischiadic foramen. The last nerve which contributes to the ischiadic plexus leaves the spinal column in most birds either between the two primary sacral vertebrae, or just below the hindmost of them, and sends a branch to the pubic portion which is composed of post-ischiadic nerves, partly imbedded in the kidneys, and innervates the ventral muscles between the tail and pubis, together with those of the cloaca and copulatory organs.

The *Sympathetic System* forms a chain on either side of the vertebral column. In the region of the neck lateral strands pass through the transverse canal of the cervical vertebrae; but from the thoracic region onwards, where the cardiac branch to the heart is given off, each strand is double and the basal ganglia are successively connected with the next by a branch which runs ventrally over the capitulum of the rib, and by another which passes directly through the foramen or space formed between capitulum and tuberculum. In the pelvic region, from about the level of the posterior end of the ischiadic plexus, the strand of each side becomes single again, passing ventrally over the transverse processes. Lastly, towards the caudal region the right and left strands approach and anastomose, eventually coalescing in the mid line.

LITERATURE.—A. Bunn, "Das Grosshirn der Vögel," *Zeitschr. Wiss.*, 308, 1883, pp. 430-466, pls. 2-25; F. Leuret and P. Gratietot, *Anatomie comparée du système nerveux* (Paris, 1839-1857), with atlas; A. Meckel, "Anatomie des Gehirns der Vögel," in *Meckel's Archiv f. Physiol.* vol. ii.; H. F. Osborn, "The Origin of the Corpus Callosum, a contribution upon the Cerebral Commissures of the Vertebrata," *Morphol. Jahrbuch*, 1886, xii, pp. 223-251, pls. 13-14; M. A. Schulgin, "Lobi optici der Vögel," *Zool. Anzeig.* iv, pp. 277 and 303; E. R. A. Serres, *Anatomie comparée du cerveau* (Paris, 1824, 4 pls.); L. Stieda, "Studien über das centrale Nervensystem der Vögel und Säugethiere," *Zeitschr. Wiss.*, Zool. xix., 1869, pp. 1-92, pls.; J. Swan, *Illustrations of the Comparative Anatomy of the Nervous System* (London, 1835, 4to, with plates).

Concerning the spinal nerves and their plexus: H. v. Jhering, *Das Peripherische Nerven-system der Wirbelthiere* (Leipzig, 1871); W. A. Haswell, "Notes on the Anatomy of Birds," *Proc. Ann. Soc. N.S.W.* iii., 1879; M. Fürbringer, "Zur Lehre von den Umbildungen der Nervenplexus," *Morph. Jahrb.* v., 1879, p. 358.

4. Organs of Sense.

The Eye is essentially reptilian, but in sharpness of vision, power and quickness of accommodation it surpasses that of the mammals. The eyeball, instead of being globular, resembles rather the tube of a short and thick opera-glass.

The anterior half of the sclerotic is composed of a ring of some ten to seventeen cartilaginous or bony scales which partly overlap each other. Another cartilage or ossification, the posterior sclerotic ring, occurs within the walls of the posterior portion of the cup, and surrounds, especially in the Pici and in the Passeres, the entrance of the optic nerve. The iris is in most young birds at first brown or dull-coloured, but with maturity attains often very bright tints which add considerably to the charm of the bird; sexual dimorphism is in this respect of common occurrence. The iris contains a sphincter and a dilator muscle; the former, supplied by branches from the *oculomotorius* nerve, is under the control of the will, whilst the dilator fibres belong to the sympathetic system. When fully dilated, the pupil is round in all birds; when contracted it is usually round, rarely oval as in the fowl. From near the entrance of the optic nerve, through the original chorioidal fissure, arises the much-folded pecten, deeply pigmented and very vascular, far into the vitreous humour. The number of its folds varies considerably, from three in *Caprimulgus* to nearly thirty in crow (*Corvus*). *Apteryx*, which since Owen has generally been stated to be devoid of such an organ, likewise possesses a pecten; its base is, however, trumpet-shaped, covers almost the whole of the optic disk, and extends nearly to the lens in the shape of a thick, densely pigmented cone, without any plications, resembling in these respects the pecten of many Lacerilia (see G. L. Johnson, *Bull. Trans.*, 1901, p. 54). In the retina the cones prevail in numbers over the rods in the mammals, and their tips contain, as in other Sauropsida, coloured droplets, but somewhat excentrically placed towards the temporal or outer side, is the *fovea centralis*, a slight depression in the retina, composed almost entirely of cones, the spot of most acute vision. Many birds possess besides this temporal fovea a second fovea nearer the nasal side. It is supposed that the latter serves monocular, the other the binocular vision, most birds being able to converge their eyes upon one spot. Consequently the whole field of vision of these birds possesses three points where vision is most acute. It may here be remembered that of the mammalia man and monkeys alone are capable of convergence, and have a circumscribed macular area.

Of the outer eyelids, the lower alone is movable in most birds, as in reptiles, and it frequently contains a rather large saucer-shaped cartilage, the *tarsus palpebralis*. The margins of the lids are sometimes furnished with eyelashes, e.g. in the ostrich and in the Amazon parrots, which are vestigial feathers without barbs. During the embryonic stage the lids are fused together, and either become separated shortly before the bird is hatched, as is the case with most Nidifugae, or else the blind condition prevails for some time, in the young Nidicolae. All birds have, like most reptiles, a well-developed third lid or "nictitating membrane," which moves from the inner canthus obliquely upwards and backwards over the cornea. The moving mechanism is a further and much higher development of that which prevails in reptiles, there being two muscles completely separate from each other. Both are supplied by the *abducens*

nerve, together with the *rectus externus* muscle. One, the *quadratus* or *bursalis* muscle, arises from the hinder surface of the eyeball, and forms with its narrow margin, which is directed towards the optic nerve, a pulley for the long tendon of the *pyramidalis* muscle. This arises from the nasal surface of the ball, and its tendon passes into the somewhat imperfectly transparent nictitating membrane. The quadrate muscle adjusts the motion, and prevents pressure upon the optic nerve; during the state of relaxation of both muscles the nictitans withdraws through its own elasticity.

See R. Leuckart in Graefe and Saemisch's *Handbuch d. Ophthalmologie* (Leipzig, 1876, vol. i. chap. 7); H. Müller, *Gesammelte Schriften* (Otto Becker, Leipzig, 1872), and *Arch. f. Ophthalmol.* iii. Ch. Rouget, "Recherches anatomiques et physiologiques sur les muscles directs," in "Appareil de l'adaptation de l'œil," *Comp. Rend. (Paris)*, xlii., 1856, p. 937-941; M. Schultze, art. "Retina," in *Stricker's Handbuch der Ophthalmologie*, 1871, vol. ii.; J. S. Ronaker, "Comp. Study of the Area of Acute Vision in Vertebrates," *Journ. Morph.*, 1897.

Ear.—The outer opening of the ear is, with rare exceptions, concealed by feathers, which are often rather stiff, or modified into bristles. There is no other protection, but slight, imperfectly movable folds of skin arise from the outer rim. The largest ear-opening is met with in the owls, with correspondingly larger folds of skin, the function of which is less that of protection than, probably, the catching of sound. In many owls the right and left ears are asymmetrical, and this asymmetry affects the whole of the temporal region, all the bones which surround the outer and middle ear, notably the squamosal and the quadrate, so that the skull becomes lopsided, one ear being turned obliquely down, the other upwards. (For detail see Collett, *Christiania Vidensk. Forhandl.*, 1881, No. 3.)

The middle ear communicates with the mouth by the Eustachian tubes, which pass between the basisphenoid and basioccipital bones, and unite upon the ventral side of the sphenoid, a little behind its articulation with the pterygoids, where they open into the mouth cavity by a short membranous duct. The columellar apparatus, or auditory chain of ossicles (fig. 16), extending between the fenestra ovalis and the tympanic membrane or drum, consists of (1) the long and slender columella, a straight, ossified rod which fits with a disk into the fenestra ovalis; it is homologous with the stapes (*m.st.*), although not stirrup-shaped; (2) the extra-columellar mass. This is chiefly cartilaginous and sends out three processes: the dorsal (*s.st.*) is attached to the upper wall of the drum cavity; the outermost (*e.st.*) is fastened on to the middle of the drum membrane; the third, ventral or infracolumellar process (*i.st.*) is directed downwards and tapers out into a thin, partly cartilaginous, strand, which originally extended to the inner corner of the articular portion of the mandible, but on its long way comes to grief, being squeezed in between the pterygoid and quadrate. This long downward process being homologous with an almost exactly identical arrangement in the crocodile, and with the *processus jolii* of the mammalian malleus, it follows that the whole extra-columellar mass, that between the stapes and drum, is equivalent to incus and malleus of the mammalia. There is, in birds, no *annulus tympanicus*. Birds possess an ear-muscle which at least acts as a *tensor tympani*; it arises near the occipital condyle, passes through a hole into the tympanic cavity, and its tendon is, in various ways, attached to the inside of the membrane and the neighbouring extra-columellar processes.

As regards the inner ear, the endolymphatic duct ends in a closed *sacculus*, imbedded in the dura mater of the cranial cavity. The apex of the cochlea is turned towards, and almost reaches the anterior wall of the occipital condyle; at most it makes but half a twist or turn; it possesses both Reissner's membrane and the organ of a higher level than in most of the reptiles, and remaining far below the mammalia, birds do not only hear extremely well, but they distinguish between and "understand" pitch, notes and melodies.

See G. Breschet, *Recherches anatomiques et physiologiques sur l'organe de l'audition chez les oiseaux* (Paris, 1836), with Atlas; C. Hasse, various papers in *Zeitschr. f. Wiss. Zool.* vol. xvii, and in *Anatomische Studien*, pts. ii. and iv. (Breslau, 1871); I. Ibsen, *Atlas anatomique auris internae* (Copenhagen, 1846); G. Retzius, *Das Gehörorgan der Wirbelthiere* (Stockholm, 1882), ii. pp. 139-198, pls. 15-20.

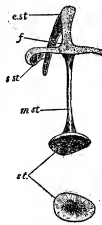

FIG. 16.—Auditory chain" of Chicken. Lateral and basal views. (After W. K. Parker).

Nose.—The olfactory organ is poorly developed, and it is still a question whether birds possess much power of smell; many are certainly devoid of it.

The olfactory perceptive membrane is restricted to the posterior innermost region of the nasal chamber, where it covers a slight bulging-out prominence on the nasal wall. This so-called third, upper or posterior conch is not a true conch, nor is that of the vestibulum; only the middle one forms a scroll, and this corresponds to the only one of reptiles and the lower of the mammals. The nasal cavity communicates with the mouth by the choanae or posterior nares, situated between the palatine process of the maxillary, the palatine and the vomer. The outer nares or nostrils are most variable in size and shape. In the Steganopodes they tend to become much reduced, e.g. in cormorants (*Phalacrocoracidae*), and especially in *Sula*, where the nasal slit becomes completely closed up, and the greater portion of the nasal cavity is also abolished, being restricted to the olfactory region with its unusually wide choanae. The nasal septum is often more or less incomplete, producing *nares periviae*, e.g. in the Cathartae, in the Anseres, gulls, rails and various other aquatic birds. The secretions of the mucous membrane of the nasal cavity, and a pair of naso-lacrimal glands (not to be confused with the Harderian and the lacrimal glands), moisten and clean the chamber. The glands are variable in size and position; when very large, e.g. in plovers, they extend upon the forehead, causing deep impressions on the bones of the skull. Jacobson's organ has been lost by the birds, apparently without a trace in the embryonic fowl, but T. J. Parker has described vestiges of the corresponding cartilages in the *Apteryx* (*Phil. Trans.*, 1890).

See C. Gegenbaur, "Über die Nasenmuscheln der Vögel," *Jena Zeitschr.* vii., 1873, pp. 1-21.

5. Vascular System.

The heart lies in the middle line of the body, its long axis being parallel with that of the trunk. The whole ventral surface of the pericardium is exposed when the sternum is removed. The right and left halves are completely divided by septa, no mixture of the venous and arterial blood being possible, an advance upon reptilian conditions, even the highest.

The atria are comparatively small, the walls being thin, especially that of the right, which possesses numerous muscular ridges projecting into the cavity presenting a honeycombed appearance. The interauricular septum is mostly entirely membranous; in the middle it is thinner, rather transparent, but there is no depression or *fossa ovalis*. The whole sinus venosus has become part of the right atrium. It receives the three great venous trunks of the body, namely the *vena cava superior dextra*, the *vena cava superior sinistra* more dorsally, and the *vena cava inferior* more to the right and below; the opening of the last is guarded by two prominent valves in place of the mammalian *safenua Eustachii*. The right ventricle occupies the ventral portion of the heart. The communication with the atrium is guarded by a *valvula cardiaca dextra*, which only in function represents the mammalian tricuspid; it consists of an oblique reduplication of the muscular fibres together with the endocardiac lining of the right ventricle, while the opposite wall is convex and forms neither a velum nor papillary muscles, nor *chordae tendineae*. The right anterior corner of the right ventricle passes into the short stem, guarded by three semi-lunar valves, which divides into the two pulmonary arteries. There are likewise two pulmonary veins, entering by the left atrium. Two or three membranous flaps, held by numerous *chordae tendineae*, form a true mitral valve, and allow the blood to pass through the left ostium atrioventriculare. The blood leaves the heart past three semi-lunar valves, by the right aorta, this being alone functional, a feature characteristic of, and peculiar to, birds. Remnants of the left aortic arch persist sometimes in the shape of a ligamentous strand. The aortic trunk is very short, sends off the coronary arteries and then the left *aorta brachiocephalica*, while the rest divides into the right brachiocephalic and the *aorta descendens*. Each brachiocephalic soon sends off its subclavian, while in the normal or more usual cases the rest proceeds as the carotid trunk, inclusive of the vertebral artery. But the carotids show several interesting modifications which have been examined chiefly by C. L. Nitzsch and by A. H. Garrod. (1) The right and left carotids converge towards the middle and extend up the neck, imbedded in a furrow along the ventral surface of the cervical vertebrae. This is the usual arrangement. (2) The two carotids are fused into one *carotis conjuncta*, imbedded in a special median osseous semicanal of the vertebrae; e.g. herons, flamingos, and some parrots. (3) There is one *carotis conjuncta*, but the posterior portion of its original right component is obliterated, leaving a so-called *c. primaria sinistra*, an unfortunate name. Such *Aves leuco-carotidinae* of Garrod are common, e.g. all the Passeriformes. (4) The reverse of the third modification, producing a *c. primaria dextra* in the bustard *Eupodotis*. In other likewise very rare cases a left, or a left and right, superficial carotids are developed and take the place of the then vanished deep or primary carotids.

Venous System.—The bird's liver receives nearly all the blood from the stomach, gut, pancreas and spleen, as well as from the left liver itself, into the right hepatic lobe, by a right and left portal vein. The *venae hepaticae magnae* join the *vena cava posterior* and thereby form with it the *vena cava inferior*. The left *hepatica magna* receives also the umbilical vein, which persists on the visceral surface of the abdominal wall, often anastomosing with the epigastric veins. A likewise unpaired *vena coccygo-mesenterica* is usually present. There is no renal portal system, excepting unimportant vestiges of such a system in the head kidneys.

Lymphatic System.—The white blood-corpuscles are produced in the follicles at the base of the intestinal villi. The lymph vessels of the tail and hinder parts of the body enter the hypogastric veins; and at the point of junction, on either side, lies a small lymph heart, which often persists until maturity. The red blood-corpuscles are invariably oval disks, with a central nucleus which causes a slight swelling; hence they are oval and biconvex.

See A. H. Garrod, "On the Carotid Arteries of Birds," *Proc. Zool. Soc.*, 1873, pp. 457-472; E. A. Lauth, "Mémoire sur les vaisseaux lymphatiques des oiseaux," *Ann. Sci. nat.* (iii. 1824), p. 381; J. L. Mackay, "The Development of the Branchial Arterial Arches in Birds, with special reference to the Origin of the Subclavians and Carotids," *Phil. Trans.* 179 B (1888), pp. 111-141; L. A. Neugebauer, "Systema venosum avium," *Nov. Act. Leopold. Carol. xiii.*, 1844, pp. 517-698, 15 pls.; R. Gasch, "Beiträge zur vergl. Anatomie des Herzens der Vögel und Reptilien," *Arch. f. Naturgesch.*, 1888.

6. Respiratory System.

The lungs are small and occupy only the dorsal portion of the thoracic cavity. There is only one right and one left lobe, each traversed through its whole length by a *mesobronchium*, whence arise about ten secondary bronchia; these send off radially arranged *parabronchia*, which end blindly near the surface. The walls of these tertiary tubes send out, in all directions, *canaliculi aerei* which, ending in slight swellings, recall the mammalian *ovarii*.

Highly specialized air-sacs are characteristic of all birds. They are very thin-walled membranes, very poor in blood-vessels, formed by the bulged-out pleural or peritoneal covering of the lungs, through the parabronchial tubes of which they are filled with air. Their function is not quite clear. The usual suggestion, that the warm air contained within them assists the bird in flight, balloon-like, is absurd. They assist in the extremely rapid and vigorous ventilation of the lungs, the latter being capable of but very limited expansion and contraction in birds. Exchange of gas through the walls of the air-sacs, almost devoid of blood-vessels, can at best be much restricted.

There are five pairs of larger sacs belonging to the pulmonary system:—(1) prebronchial or cervical, extending sometimes up to the neck, even into the cranial cavities; the throat-bags of the prairie fowls (*Cupidonia* and *Pediocetes*) are a further development; (2) subbronchial or interclavicular; (3) and 4) anterior and posterior thoracic or intermediate; (5) abdominal sacs. Most of these extend through narrow apertures—*foramina pneumatica*—into the hollow bones, sometimes, e.g. in hornbills and screamers, into every part of the skeleton, or, in the shape of innumerable pneumatic cells, even beneath the skin. There is also a naso-pharyngeal or tympanic system of air-sacs restricted to the head (cf. the *siphonium* described in connexion with the mandible), but filling also such curious organs as the frontal excrescence of *Chasmorhynchus*, the Brazilian hell-bird, the throat-bag of the adjutant stork, and the gular pouch of the bustard.

The trachea or windpipe is strengthened by numerous cartilaginous, often osseous, complete rings, but in the emeu several of these rings are incomplete in the medioventral line, and permit the inner lining of the trachea to bulge out into a large neck-pouch, which is used by both sexes as a resonating bag. In humming-birds and petrels the trachea is partly divided by a vertical longitudinal cartilaginous septum. In some of those birds which have a peculiarly harsh or trumpeting voice, the trachea is lengthened, forming loops which lie subcutaneously (capercally, curassow), or it enters and dilates the symphysis of the furcula (crested guineafowl); or, e.g. in the cranes and in the hooper swan, even the whole crest of the sternum becomes invaded by the much elongated, manifold trachea.

The *syrrinx* or lower larynx is the most interesting and absolutely avine modification, although absent as a voice-producing organ (probably due to retrogression) in most Ratitae, storks, turkey buzzards (*Cathartes*) and Steganopodes. The *syrrinx* is a modification of the lower part of the trachea and of the adjoining bronchi. Essential are vibrating membranes between the cartilaginous framework, and next, special muscles for regulating the tension. The majority of birds possess a pair of internal tympaniform membranes forming the inner or median walls of the bronchi, which are there furnished with semi-rings only. External tympaniform membranes

exist, with great variations, between the specialized one or two last tracheal and some of the first bronchial rings.

According to the position of the chief sound-producing membranes, three types of syrinx are distinguishable:—(1) Tracheo-bronchial, by far the commonest form, of which the two others are to a certain extent modifications. The essential feature is that the proximal end of the inner membranes is attached to the last pair of tracheal rings; outer tympaniform membranes exist generally between the 2nd, 3rd and 4th bronchial semi-rings. This type attains its highest development in the Oscines, but it occurs also in many other orders. (2) Syrinx bronchialis. The outer membranes are spread out between two or more successive bronchial semi-rings, a distance from the trachea which is, in typical cases, devoid of sounding membranes; some Cuculi, Caprimulgus, and some owls. (3) Syrinx trachealis. The lower portion of the trachea consists of thin membranes, about half a dozen of the rings being very thin or deficient. Inner and outer membranes may exist on the bronchi. The Tracheophones among the Passeriformes, the possessors of this specialized although low type of syrinx, form a tolerably well-marked group, entirely neotropical. But indications of such a syrinx occur also in Pittidae, pigeons and gallinaceous birds (Gallidae), the last cases being clearly analogous.

Whilst the type of syrinx affords no help in classification, it is very different from its muscles. These—as indicated by their supply from a branch of the hypoglossal nerve, which descends on either side of the trachea—are, so to speak, a detached, now mostly independent colony of glosso-pharyngeal muscles. Omitting the paired tracheo-clavicular muscles, we restrict ourselves to the syrinxal proper, those which extend between tracheal and bronchial rings. Their numbers vary from the pair of the first and second rings, down upon the middle portion of the bronchial semi-rings (*Mesomyodi*), or upon the ends of these semi-rings where these pass into the inner tympaniform membrane (*Acromyodi*). The former is morphologically the more primitive condition, and is found in the overwhelming majority of birds, including many Passeriformes. The acromyodian type is restricted almost entirely to the Oscines. Further, according to these muscles being inserted only upon the dorsal, or only upon the ventral, or on both ends of the semi-rings, we distinguish between *an-*, *kal-* and *diacromyodi*. But the distinction between such *Acromyodi* and the *Mesomyodi* remains very safe. For instance, the *Pipra* and *Cotingas* are katacromyod; while the allied *Pipra* and *Cotingas* are katacromyod; both these modifications can be shown to have been derived but recently from the weak meso- and oligomyodian condition which prevails in the majority of the so-called *Oligomyodi*. On the other hand, the diacromyodian type can have been developed only from a strong muscular basis which could split into a dorsal and a ventral mass; moreover, no Passeres are known to be intermediate between those that are diacromyodian and those that are not.

Attempts to derive the acromyodian and the katacromyodian from the diacromyodian condition are easy on paper, but quite hopeless when hampered by the knowledge of anatomical facts and how to use them. There remains but one logical way, namely, to distinguish as follows:—(1) *Passeres anisomyodi*, in which the syrinx muscles are unequally inserted, either on the middle or on one end of the semi-rings, either dorsal or ventral. This type comprises the Clamatores. (2) *Passeres diacromyodi*, in which some of the syrinx muscles are attached to the dorsal, and some to the ventral ends, those ends being, so to say, equally treated. This type comprises the Oscines. Both types represent rather two divergent lines than successive stages, although that is the case in the Clamatores, where the lower level, possessing at the utmost three pairs of muscles, whilst there range the Oscines from rarely two or three to five or seven.

This way of using the characters of the syrinx for the classification of the Passeriformes seems simple, but it took a long time to accomplish. J. H. Müller introduced the terms *Polymyodi* and *Tracheophones*, Juchty that of *Oligomyodi*; Müller himself had, moreover, pointed out the more important characters of the mode of insertion, but it was Garrod who invented the corresponding terms of *Acromyodi* and *Mesomyodi* (= *Tracheophones* + *Oligomyodi*). [For further historical detail, see ORNITHOLOGY.] After W. A. Forbes had investigated such important genera as *Phalacrocorax* and *Colinus*, J. A. Newton has hampered by the name of Sharp divide the Passeres respectively into *Oscines*, *Oligomyodae*, *Tracheophonae* and *Pseudoscines* (= *Suboscines*); *Oligomyodae*, *Tracheophonae* and *Acromyodae*; *Oscines*, *Oligomyodae*, *Tracheophonae* and *Altrichidae*. Ignoring the fact that some *Oligomyodae* are meso- and others acromyodian, they tried to combine two irreconcilable principles, namely, mere numbers against quality.

BIBLIOGRAPHY.—M. Baer, "Beitr. z. Kenntniss d. Atemwerkzeuge bei den Vögeln," *Zeitschr. wissenschaftl. Zool.* li. 1896, pp. 420-492; Campana, *Physiologie de la respiration chez les oiseaux. Anatomie de l'appareil pneumatique* . . . (Paris, 1878); A. H. Garrod, "Major Divisions of Passerine Birds," *Proc. Zool. Soc.* 1876, p. 506-510; and "On the Conformation of the Thoracic Extremity of the Trachea in the Class *Aves*," *P.Z.S.*, 1879, pp. 357-380; J. Müller, *Stimmorgane der Passerinen*, Müller's Arch. (1847); and *Abh. Akad. Wiss.* (Berlin, 1845-1847), translation by F. J. Bell, Oxford, 1847; H. Strasser, "Luftsäcke der Vögel," *Morph. Jahrb.* iii., 1877, pp. 179-227; C. Wunderlich, "Untere Kehlkopf der Vögel," *Nov. Act. Leop. Carol.*, 1884; Ph. C. Sappey, *Recherches sur l'appareil*

respiratoire des oiseaux (Paris, 1847); W. A. Forbes, "Contributions to the Anatomy of Passerine Birds (syrinx)," *P.Z.S.*, 1880, pp. 380-386, 387-391; 1881, pp. 435-37; 1882, pp. 544-546, 569-571; W. Yarrell, "Observations on the tracheae of Birds," *Trans. Linn. Soc.*, 1827, pp. 378-391.

7. Digestive System.

For a general account of the digestive organs, see ALIMENTARY CANAL. Here only a few peculiar features may be mentioned.

The young pigeons are fed by both parents with a peculiar stuff, the product of the strongly proliferating epithelial cells of the crop, which cells undergo a cheese-like fatty degeneration, and mixed with mucus, perhaps also with the proventricular juice, make up a milk-like fluid. Should the young die or be removed during this period, the parents are liable to die, suffering severely from the turbid congestion of the hypertrophied walls of the crop.

The male of the hornbill, *Bucconinae*, feeds his mate, which is imprisoned, or walled-up in a hollow tree, during the whole time of incubation, by regorging his food. This bolus is surrounded, as by a bag, by the cast-up lining of the gizzard. Since this process is repeated for many days the habitual reaction of the stomach well-nigh exhausts the male. A graphic account of this is given in Livingstone's travels.

The hoactzin, *Ophiochomus*, feeds to a great extent upon the leaves of the aroid *Montrichardia* or *Caladium arborescens*. The crop is modified into a large and very rugose triturating apparatus, while the gizzard, there being no retention, is reduced to the utmost. The large and heavy crop has caused a unique modification of the sternal apparatus. The keel is pushed back to the distal third of the sternum, whilst the original anterior margin of the keel is correspondingly elongated, and the furcula fused with the rostral portion.

In the ostrich, *Struthio*, the craze of overloading the stomach with pebbles which, when triturated into sand, are not voided, has brought about a dislocation, so that the enormously widened and stretched space between proventriculus and gizzard forms a bag, directed downwards, whilst the gizzard itself with part of the duodenum is rotated round its axis by more than 100°. Similar rotation and dislocation occurs in various other birds, in correlation with the indigestible sepa-bills, &c., which these birds swallow in great quantities. In *Plotus*, the snakebird, the pyloric chamber of the stomach is beset with a mass of hair-like stiff filaments which permit nothing but fluid to pass into the duodenum. The gizzard of various birds which are addicted to eating hairy caterpillars, e.g. *Cuculus canorus* and trogons, is often lined with the broken-off hairs of these caterpillars, which, penetrating the cuticle, assume a regular spiral arrangement, due to the rotatory motion of the muscles of the gizzard.

8. Cloaca and Genital Organs.

The cloaca is divided by transverse circular folds, which project from its inner walls, into three successive chambers. The innermost, the coprodaeum, is an oval dilatation of the end of the rectum, and attains its greatest size in those birds whose faeces are very fluid; it serves entirely as the temporary receptacle of the faeces and the urine. The next chamber, the urodaeum, is small, and receives in its dorso-lateral wall the ureters and the genital ducts; above and below this chamber is closed by circular folds, the lower of which, towards the ventral side, passes into a cone coating of the copulatory organ which such is primarily the uric duct serves only as a passage, the urine being mixed with the faeces in the chamber above. The third or outermost chamber, the proctodaeum, is closed externally by the sphincter ani; the orifice is quite circular. It lodges the copulatory organ, and on its dorsal wall lies the *bursa Fabricii*, an organ peculiar to birds. It is most developed in the young of both sexes, is of unknown function, and becomes more or less obliterated in the adult. Only in the ostrich it remains throughout life, being specialized into a large receptacle for the urine, an absolutely unique arrangement. A true urinary bladder, i.e. a ventral dilatation of the urodaeum, is absent in all birds. It is significant that the whole type of their cloaca much resembles that of the Crocodylia and Chelonina, in opposition to that of the Lacertilia.

The penis, and its much reduced vestige of the female, is developed from the ventral wall of the proctodaeum. It occurs in two different forms. In the Ratitae, except *Rhea*, it consists mainly of a right and left united half (*corpora fibrosa*), with a deep longitudinal furrow on the dorsal side, and much resembles the same organ in crocodylia and tortoises. It is protruded and retracted by special muscles which are partly attached to the ventral, distal end of the ilium. Another type exists in *Rhea* and in the *Anseriformes*, greatly specialized by being spirally twisted and partly reversible, the inner edge of a glove. This is mainly due to the greater development of an unpaired, median portion, analogous to the mammalian *corpus spongiosum*, which is much less prominent in the Ratitae; the muscles of this type are derived solely from the anal sphincter. In other Carinatae, e.g. tinamous and storks, the penis is very much smaller and simpler, with every appearance of a degenerated organ. In the great majority of birds it has disappeared completely and the primitive way of everting the cloaca is resorted to.

Both right and left testes are functional. They become greatly

enlarged in the breeding season; in the sparrow, for instance, from the size of a mustard seed to that of a small cherry. The vas deferens descends with many undulations down the lateral side of the ureter of the same side, and opens upon a small papilla into the urodeum. Extraordinary increase in length during the breeding season causes the vasa deferentia in some of the African weaver-birds to protrude, or to bulge out the cloacal walls beyond the vent. The spermatozoa exhibit many differences in shape, size and proportions, in the various groups of birds. They have been studied minutely by E. Ballowitz.

Only the left ovary becomes functional, with rare individual exceptions. Both present the appearance of diminutive clusters of grapes, at the anterior end of the kidneys, close to the suprarenal bodies, separated from each other by the descending aorta and by the *vena cava* where this is formed by the right and left *vena iliaca communis*. During the breeding season many more eggs are developed than reach maturity, amounting in most birds to several dozens. Those germs which do not ripen during the season undergo a process of resorption, and in the winter the whole ovary dwindles to often a diminutive size. In young birds both oviducts are almost equal in size, but the right soon degenerates into an insignificant strand. During every laying season the left duct increases enormously by new formation of its component fibres. For instance, in the fowl its volume increases about fifty-fold, growing from some 6 in. in length and scarcely one line in width to more than 2 ft. in length and $\frac{1}{2}$ in. in thickness. The upper, wide opening of the duct is attached to the body by elastic, peritoneal lamellae to the hinder margin of the left lung; the middle portion of the duct is glandular and thick-walled, for the deposition of the albumen; it is connected by a short, constricted "isthmus" (where the shell-membrane is formed) with a dilated "uterus" in which the egg receives its calcareous shell and eventual pigmentation.

BIBLIOGRAPHY.—A. v. Brunn, *Rückbildung nicht ausgestossener Eiersstockeiser, Henle Festschrift* (Bonn, 1882); E. Ballowitz, "Die Spermatozoen der Vögel," *Arch. Mikr. Anat.* xxxii., 1888, pls. 14-18; M. Sacchi, "Contribuzione all' istologia del ovidotto dei saurospidi," *Atti. Soc. Ital.*, Milano, vol. xxx., W. A. Forbes, "On the Bursa Fabricii in Birds," *P.Z.S.*, 1877, pp. 304-318; H. Gadow, "Remarks on the Cloaca and on the Copulatory Organs of the Amniota," *Phil. Trans.*, 1887, pp. 5-37, pls. 2-5; Martin Saint Ange, "Étude de l'appareil reproducteur dans les cinq classes d'animaux vertébrés," *Mém. Ac. Soc.*, Paris, xiv., 1856; E. Retterer, "Contribution à l'étude du cloaque et de la bourse de Fabricius," *Robin's Journ. de l'anat. et physiol.*, 1885, pp. 369-454, pls. 17-19.

B. FOSSIL BIRDS

Much had naturally been expected from the study of fossil birds, but, so far as the making of classifications is concerned, they have proved rather a source of perplexities. So long as the characters of new fossils are only of specific and generic value, it is mostly possible to assign the birds to their proper place, but when these characters indicate new families or orders, for instance *Hesperornithes*, *Ichthyornithes*, *Palaeodi*, their owners are put outside the more tersely constructed classifications applicable to modern birds. It is no exaggeration to say that the genus, often even the species, can be determined from almost any recent bone, but in the case of Miocene, and still more, of Eocene fossils, we have often to deal with strange families, which either represent an extinct side branch, or which connect several recent groups with each other. Our artificially-established classifications collapse whilst we gain further insight into the mutual affinities of the existing groups. Of course this must be so if evolution is true. But it also follows that, if every extinct and recent bird were known, neither species, nor genera, nor families, nor orders could be defined. We should be able to construct the pedigree of every group, in other words, the gigantic natural system, but there would be no classification. Much light has also been thrown by fossil birds upon the study of geographical distribution. The key to the distribution of recent groups lies in that of the extinct forms. Not only have many absolutely new families been discovered, but many kinds of modern birds are now known to have existed also in countries which they are now extinct. There were, for instance, trogons, secretary-birds, parrots, and other now Ethiopian forms in Miocene France. Ostriches, undistinguishable from *Struthio*, have been found in Samos and in the Sivalik Hills.

The proper study of fossil birds may be said to have begun with A. Milne-Edwards, whose magnificent *Oiseaux fossiles de la France* was published from 1867 to 1871. This work deals chiefly with mid-Tertiary forms. A new impetus was given by O. C.

Marsh, who, after 1870, discovered a great number of bird remains in the Cretaceous strata of North America. The most important result is the proof that, until the end of the Cretaceous epoch, most, if not all, birds were still possessed of teeth (see *ODONTORNITHES*).

The oldest known bird is the *Archaeopteryx* (*q.v.*), of the upper Oolite in Bavaria. The imprints in the enormously older new red sandstone or Lower Trias of Connecticut, and originally named *Ornithichnites*, belong to Dinosaurian Reptiles.

A wide gap separates *Archaeopteryx* from the next order of fossil birds of the Cretaceous epoch, and, since freshwater deposits of that age are rare, bird remains are uncommon. Many bones formerly referred to birds have since proved to belong to Pterodactyls, e.g. *Cimoliornis* from the English Chalk. But in 1858 were discerned in the Upper Greensand of Cambridgeshire remains which are now known as *Enaliornis*. W. Dames has described bones from the Chalk of southern Sweden under the name of *Scaniornis*, probably allied to *Palaeolodus*. From the Cretaceous rocks of North America a large number of birds have been described by O. C. Marsh. Of these the most interesting are *Ichthyornis* (= *Graculavus*) and *Hesperornis*, from the Cretaceous shales of Kansas. They were placed by Marsh in a distinct subclass of birds, *Odontornithes* (*q.v.*). Probably all birds of Cretaceous age were still possessed of teeth. *Baptornis*, another of Marsh's genera, seems to be allied to *Enaliornis*, *Palaeotringa* and *Talmatornis*, were by him referred to Limicoline and Passerine birds. *Laornis* from the Cretaceous marls of New Jersey was as large as a swan.

The lower Eocene has furnished a greater number of bird bones. Some of the largest are those of *Gastornis*, with three species from France, Belgium and England. Much difference of opinion obtains as to the affinities of these birds, which were far larger than an ostrich; they were undoubtedly incapable of flight and there are indications of teeth in the upper jaw. Provisionally this genus has been grouped with the *Ratitae*, and at any rate as a heterogeneous assembly. Sir R. Owen's *Dasornis*, of the London Clay, known from an imperfect cranium, and E. D. Cope's *Diatryma* of New Mexico, based upon a gigantic

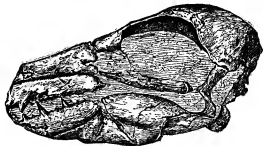

FIG. 17.—Remains of head of *Odontopteryx*, from the original in the British Museum; side view; natural size.

metatarsus, may also belong there. The London Clay of South England has likewise supplied some long upper arm bones, *Argillornis*. The most remarkable specimen is a skull, *Odontopteryx toliapicus* (figs. 17, 18); the edges of the jaws were serrated

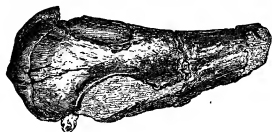

FIG. 18.—Remains of head of *Odontopteryx*, seen from above.

like those of certain tortoises. The character of this skull and the compound rhamphotheca (known by the imprints left upon the jaws) indicate affinities with the *Steganopodes*. Remnants

of a heron-like bird, *Proherodius*, of a gull-like creature, *Halcyornis*, a raptorial *Lithornis*; and a supposed Passerine from Glarus in Switzerland, called *Protornis*=*Osteornis*, complete the list.

The upper Eocene has yielded many birds, most of which are at least close forerunners of recent genera, the differentiation into the leading orders and families being already well marked, e.g. Gallinaceous birds, stork- and crane-like waders, rails, birds of prey, cormorants, &c. Especially numerous bones have been found in the Paris basin, chiefly described by G. Cuvier, F. L. P. Gervais, E. Blanchard, and above all by A. Milne-Edwards, and in the equivalent beds of Hampshire. Others have been discovered in Wyoming; a giant penguin, *Palaeudyptes*, is known from New Zealand, and *Palaeospheniscus* from Patagonia. The Miocene has yielded by far the greatest number of bird-bones, including even eggs and imprints of feathers. For instance, from the lower Miocene beds of Allier and Puy-de-Dôme Milne-Edwards has described about 50 species. Of these *Palaeolodus* was an ancestral flamingo, but with shorter legs; *Limnatornis* is referred to the hoopoes. The existing genera include *Anas*, *Aquila*, *Bubo*, *Columba*, *Cypselus*, *Lanius*, *Picus*, *Phalacrocorax*, *Sula*, &c. Very interesting is the fact that *Serpentarius*, *Psiittacus* and *Trogon* are amongst this list of birds, which are now restricted to the tropics. A similarly mixed avifauna has been found in the mid-Miocene beds of various other parts of France, Germany and Italy. In Colorado and New Mexico Marsh has detected bones of *Meleagris*, *Puffinus*, *Sula* and *Uria*, all existing genera; but the first is especially suggestive, since it is one of the most characteristic forms of the New World.

Here may be interpolated a short account of the very peculiar avifauna found in the Tertiary strata of Santa Cruz in Patagonia. Instead of the age of lower Eocene, as had been stated originally, these beds are not older than mid-Miocene, and not a few of the bones are of a much younger, even latest Tertiary date. Discovered, and partly described, by F. Ameghino, the bones have been sumptuously monographed by F. P. Moreno and A. Mercet, who proposed for them the name of *Stereornithes*, a new order of birds, mostly gigantic in size, and said to combine the characters of Anseres, Herodiones and Accipitres. But the whole mass of bones is in hopeless disorder, apparently without any record of association. At any rate, the "*Stereornithes*," accepted as such in Bronn's *Thierreich*, and in Newton's *Dictionary of Birds*, had to be dissolved as an unnatural, haphazard assembly. Many of these birds, to judge from the enormous size of their hind-limbs, were undoubtedly flightless, e.g. *Bronnornis*, and remind us of the Eocene *Gastornis* of Europe. *Phororhacos*, the most extraordinary of all, belongs to the Gruiformes, perhaps also *Pelecyornis* and *Liornis*. On the other hand, the late Tertiary *Dryornis* is a member of the Cathartae or American vultures, and *Mesembriornis*, likewise of late Tertiary date, is a close forerunner of the recent genus *Rhea*.

Pliocene remains are less numerous than those of the Miocene. From Pikermi in Greece is known a *Gallus*, a *Phasianus* and a large *Grus*. From Samos a large stork, *Amphiplegus*, and a typical *Struthio*; from the Sivalik Hills on the southern flanks of the Himalayas also an ostrich, and another Ratite with three toes, *Hypselornis*, as well as *Leptoptilus*, *Pelecanus* and *Phalacrocorax*. The fossil egg of a struthious bird, *Struthiolithus*, has been found near Cherson, south Russia, and in north China. The Suffolk Crag has yielded the unmistakable bones of an albatross, *Diomedea*.

Most Pleistocene birds are generically, even specifically, identical with recent forms; some, however, have become extinct, or they have become exterminated by man. A great number of birds' bones have been found in caves, and among them some bearing marks of human workmanship. In France we have a large and extinct crane, *Grus primigenia*, but more interesting are the numerous relics of two species, the concomitants even now of the reindeer, which were abundant in that country at the period when this beast flourished there, and have followed it in its northward retreat. These are the snowy owl, *Nyctea*

scandiaca, and the willow-grouse, *Lagopus albus*. A gigantic swan, *Cygnus falconeri*, is known from the Zebug cavern in Malta. From caves of Minas Geraes in Brazil, O. Winge has determined at least 126 species, of which nearly all still survive in the country. Kitchen-middens of England, Ireland and Denmark reveal the existence of the capercally, *Tetrao urogallus*, and of the great auk or gare-fowl, *Alca impennis*; both species long since vanished from those countries. In the fens of East Anglia have been found two humeri, one of them immature, of a true *Pelecanus*, a bird now no longer inhabiting middle Europe.

Until a very recent epoch there flourished in Madagascar huge birds referable to the Ratitae, e.g. *Aepyornis maximus*, which laid enormous eggs, and not unnaturally recalls the mythical "roc" that figures so largely in Arabian tales. New Zealand has also yielded many flightless birds, notably the numerous species and genera of *Diornithidae*, some of which survived into the 19th century (see MOA); *Pseudopteryx* allied to the *Kiwi*; *Cnemidornis*, a big, flightless goose; *Aptornis* and *Notornis*, flightless rails; and *Harpagornis*, a truly gigantic bird of prey with tremendous wings and talons.

It is, of course, quite impossible, in a survey of extinct birds, to include into them those which are *bona fide* fossil, sub-fossil, recently extirpated and partially exterminated. Nor is it possible, except in a few cases, to decide whether they have come to an

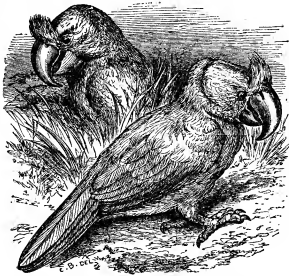

From a tracing by M. A. Milne-Edwards of the original drawing in a MS. Journal kept during Waldemar Harmand's voyage to Mauritius (A.D. 1603-1609), James H. Schlegel (Proc. Zool. Soc. 1875, p. 350). Reduced.

FIG. 19.—Extinct Crested Parrot of Mauritius (*Lophopsittacus mauritianus*).

end through the agency of man or through so-called natural causes. Like other creatures birds have come, some to flourish and stay, others to die out.

Mauritius is famous for the dodo, killed off by man; there was also a curiously crested parrot, *Lophopsittacus* (fig. 19). In the Mare aux Songes have been found the bones of another



FIG. 20.—Mandible of *Aphanapteryx*, side view. (From the original in the Museum of Zoology of the University of Cambridge.)

parrot, of ducks, pigeons, rails, herons, geese and of a dwarf darter, *Plotus nanus*, all sub-fossil, now extinct. Very interesting is *Aphanapteryx* (fig. 20), a long-billed, flightless rail, practically the same as *Erythromachus* of Rodriguez and *Diaphorapteryx* of Chatham Island. Réunion possessed the peculiar starling, *Fregilupus*. Rodriguez was inhabited by *Pezophaps*, the solitaire, *Necropsittacus* and *Palaeornis exsul*, which is now

probably extinct. The Antilles tell a similar tale. The great auk, once common on the British coasts, those of Denmark, the east coast of North America, then restricted to those of Newfoundland, Greenland and Iceland, has been killed by man, and the same fate has overtaken the Labrador duck, the Phillip Island parrot, *Neslor productus*, and the large cormorant of

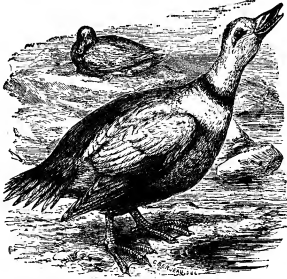

FIG. 21.—Pied Duck (*Somateria labradorica*), male and female. (From specimens in the British Museum. Reduced.)

Bering Island, *Phalacrocorax perspicillatus*; and how long will the flightless cormorant, *Ph. harrisi* of the Galapagos, survive its quite recent discovery?

AUTHORITIES.—A. Milne-Edwards, *Recherches anatomiques et paléontologiques pour servir à l'histoire des oiseaux fossiles de la France* (Paris, 1867-1868); F. P. Moreno and A. Mercerat, *Catálogo de los Pajaros fósiles de la Republica Argentina. Anales Mus. La Plata*, 1891, 21 pls.; O. C. Marsh, *Odontornithes: A monograph of the Extinct Toothed Birds of North America* (New Haven, Conn., 1880); R. Lydekker, article "Fossil Birds," in A. Newton's *Dictionary of Birds* (London, 1893); Cat. Foss. Birds, Brit. Museum, 1891; K. v. Zittel, *Handbuch der Paläontologie*, i. 3 (1887-1890); C. W. Andrews, "On the Extinct Birds of Patagonia," *Tr. Zool. Soc. xv.*, 1899, pp. 55-86, pls. 14-17.

C. GEOGRAPHICAL DISTRIBUTION

The study of the extinct organisms of any country leads to a proper appreciation of its existing flora and fauna; while, on the other hand, a due consideration of the plants and animals which may predominate within its bounds cannot fail to throw more or less light on the changes it has in the course of ages undergone. That is to say, the distribution of forms in time is a subject so much connected with the distribution of forms in space, that the one can hardly be separated from the other. Granting this is a general truth, it must yet be acknowledged as a special fact, that in fossil birds we have as yet but scanty means of arriving at any precise results which will justify bold generalization in the matter of avine distribution. Remains of extinct birds are, compared with those of other classes of vertebrates, exceedingly scarce, and these have been found in very few, widely separated countries. The great problems involved in the study of geographical distribution must therefore be based mainly upon the other classes, both vertebrate and invertebrate, which, moreover, enjoy less great facilities of locomotion than the birds.

Yet it so happens that the great zoogeographical regions of the world, now more or less generally accepted, have been based upon the distribution of birds. The whole subject was properly introduced by Treviranus,¹ who in his large philosophical work devotes considerable space to the "geographical

distribution of animals." Next we have to mention F. Tiedemann,² the Heidelberg anatomist, who has been generally ignored, although he surpassed many a recent zoogeographer by the wide view he took of the problem; in fact he was the first to connect distribution with environmental or biometric factors; e.g. the remark on p. 481 of his work that "the countries of the East Indian flora have no kinds of birds in common with America which are vegetable feeders." L. K. Schmarda³ divided the land into twenty-one realms, characterizing these mainly by their birds. P. L. Sclater⁴ was the first to divide the world into a few great "regions," the Palaearctic, Ethiopian, Indian and Australian forming one group, the "Old World" (*Palaegogaea*); and the Nearctic and Neotropical forming a second, the New World (*Neogogaea*). Birds being of all animals most particularly adapted for extended and rapid locomotion, it became necessary for him to eliminate from his consideration those groups, be they small or large, which are of more or less universal occurrence, and to ground his results on what was at that time commonly known as the order Insectores or Passeres, comprehending the orders now differentiated as Passeriformes, Coraciiformes and Cuculiformes, in other words the mass of arboreal birds. His six main divisions—practically adopted by A. R. Wallace⁵ in his epoch-making work—are excellent, taken separately. They express the main complexes of land with their dependencies in well-chosen terms; for instance the "Neotropical region" stands short for South and Central America with the Antilles.

But these six divisions of Sclater and Wallace are not all equivalent, only some are of primary importance; they require co- and sub-ordination. This most important advance was made by T. H. Huxley.⁶ Some of the "regions" have now to be called subregions, e.g. the Nearctic and the Palaearctic. The reduction of the Oriental to a subregion, with consequent "provincial" rank of its main subdivisions, will probably be objected to, but these are matters of taste and prejudice. Above all it should be borne in mind that nearly all the last subdivisions or provinces are of very little real value and most of them are inapplicable to other classes of animals.

Besides some occasional references in the text, only a few more of the general works dealing with the distribution of birds can be mentioned. Especial attention has to be drawn to the article "Geographical Distribution," in Newton's *Dictionary of Birds*. See also A. Heilprin, *The Geographical and Zoological Distribution of Animals* (New York, 1887); W. Marshall and A. Reichenow, two maps with much detail, although badly arranged, in Berghaus *Physikalischer Atlas*, pt. vi. (*Atlas d. Thierverbreitung*), (Gotha, 1887); A. Reichenow, "Die Begrenzung zoogeographischer Regionen vom ornithologischen Standpunkte," *Zoolog. Jahrb.* iii., 1888, pp. 671-704, pl. xxvi.; E. L. Trouessart, *La Géographie zoologique* (Paris, 1890).

The scheme adopted in the following account stands as follows:—

(A) AUSTRORGAEA or I. Australian Region	{	New Zealand subregion
		Australian "
		Papuan "
		Antillean "
(B) NEOGOGAEA or II. Neotropical Region	{	Columbian "
		Patagonian "
		Neartic "
		Palaearctic "
(C) ARCTOGOGAEA	{	IV. Palaetropical
		Region
		Ethiopian "
		Oriental "

In the following account the characterization of the various regions and subregions has to a very great extent been adopted from Newton's article in his *Dictionary of Birds*, and from the chapter on distribution in the article on "Birds" in the *Encyclopædia Britannica*, 9th edition. This applies especially

¹ F. Tiedemann, *Anatomie und Naturgeschichte der Vögel*, vol. ii. §§ 127-255 (Heidelberg, 1814).

² L. K. Schmarda, *Die geographische Verbreitung der Thiere* (Wien, 1853).

³ P. L. Sclater on the general geographical distribution of the members of the class "Aves," 2. *Linn. Soc.* ii. pp. 130-145, 1858.

⁴ A. R. Wallace, *The Geographical Distribution of Animals, with a study of the Relations of Living and Extinct Faunas as elucidating the Past Changes of the Earth's Surface*, 2 vols. (London, 1876).

⁵ T. H. Huxley, "On the Classification and Distribution of the Alectoromorphae," *P.Z.S.*, 1868, pp. 313-319.

⁶ Treviranus, *Biologie oder Philosophie der lebenden Natur*, vol. ii. cap. 4, § 2 (Göttingen, 1803).

to those instances in which the members of families, genera and species are mentioned. The families are those which are enumerated in Garow's classification. The numbers of genera and species of birds are, of course, a matter of personal inclination. If we take a moderate computation the number of recent species may be taken at 10,000-11,000.¹ Dr R. B. Sharpe increases their number to about 15,000 in the *New Hand-List of Birds*, published by the British Museum. In the first two volumes fossil birds, occasionally based upon a fragmentary bone only, are also included.

(A) AUSTROROGAEA, the Australian region in the wider sense, with the Papuan, Australian and New Zealand subregions, including also Polynesia. We may here quote Newton (*Encyclopædia Britannica*, 9th ed., "Birds," p. 738) on the remarkable differences between this region and the rest of the Old World:—"The prevalent zoological features of any Region are of two kinds—negative and positive. It is therefore just as much the business of the zoogeographer, who wishes to arrive at the truth, to ascertain what groups of animals are wanting in any particular locality (altogether independently of its extent) as to determine those which are forthcoming there. Of course, in the former case it would be absurd to regard as a physical feature of any great value the absence from a district of groups which do not occur except in its immediate neighbourhood; but when we find that certain groups, though abounding in some part of the vicinity, either suddenly cease from appearing or appear only in very reduced numbers, and occasionally in abnormal forms, the fact obviously has an important bearing. Now, mere geographical considerations, taken from the situation and configuration of the islands of the so-called Indian or Malay Archipelago, would indicate that they extended in an unbroken series from the shores of the Strait of Malacca to the southern coast of New Guinea, which confronts that of north Australia in Torres Strait, or even farther to the eastward. Indeed, the very name Australasia, often applied to this part of the world, would induce the belief that all the countless islands, be they large or small—and some of them are among the largest on the globe—were but a southern prolongation of the mainland of Asia. But so far from this being the case a very definite barrier is interposed. A strait, some 15 m. or so in width, and separating the two fertile but otherwise insignificant islands of Bali and Lombok, makes such a frontier as can hardly be shown to exist elsewhere. The former of these two islands belongs to the Indian Region, the latter to the Australian, and between them there is absolutely no true transition—that is, no species are common to both which cannot be easily accounted for by the various accidents and migrations that in a course of time must have tended to mingle the productions of islands so close to one another. The faunas of the two are as absolutely distinct as those of South America and Africa, and it is only because they are separated by a narrow strait instead of the broad Atlantic that they have become so slightly connected by the interchange of a few species and genera.

"Now, first, of the forms of birds which are prevalent throughout the Indian Region, but are entirely wanting in the Australian, we have at once the bulbuls (*IXIDAE*), very characteristic of most parts of Africa and Asia, including the sub-group *Phyllornithinae*, which is peculiar to the Indian Region; the widely-spread families of barbets (*Megalaiminae*) and vultures (*Vulturidae*); and the pheasants (*Phasianidae*), which attain so great a development in various parts of the Asiatic continent and islands that there must their home be regarded as fixed. Some naturalists would add the finches (*Fringillidae*), rightly if we assume that the *Ploceidae* or weavers constitute a separate family. Then, of forms which are but weakly represented, we have the otherwise abundant rufouses (*Turdidae*), and, above all, the woodpeckers (*Picidae*), of which only very few species, out of 400, just cross the boundary and occur in Lombok, Celebes or the Moluccas, but are unknown elsewhere in the region."

But the Australian region is also remarkable for its ornithic singularity. All the existing Ratitæ (with the exception of the ostriches of Africa and South America, belonging to the genera *Struthio* and *Cassio*), and comparing at most but few species) are found in Austrorogaea and nowhere else. Of the Passeræ the honey-suckers (*Meliphagidae*) are most characteristic, and, abounding in

genera and species, extend to almost every part of the region, yet only one species of *Ptilotis* oversteps its limits, crossing the sea from Lombok to Bali. Other peculiar families are much more confined. But the positive characteristics of the region as a whole are not its peculiar forms alone; there are at least four families which, being feebly represented elsewhere, here attain the maximum of development. Such are the thick-headed shrikes (*Pachycephalidae*), the caterpillar-eaters (*Campēphagidae*), the flower-pickers (*Dicaeidae*), and the swallow-flycatchers (*Artamidae*). Besides these, three or perhaps four groups, though widely distributed throughout the world, arrive in the Australian region at their culmination, presenting an abundance of most varied forms. These are the weaver-birds (*Ploceidae*) and the moreorks (*Podargidae*), but especially the kingfishers (*Alcedinidae*) and the pigeons (*Columbidae*), the species belonging to the two last obtaining in this region a degree of prominence and beauty which is elsewhere unequalled.

The boundaries of the subregions are not well defined. The *New Zealand Subregion*, considered by Professors Newton and Huxley and various other zoogeographers as deserving the rank of a region, is, and to all appearance has long been, more isolated than any other portion of the globe. Besides the three larger islands numerous satellites belong to the subregion, as Lord Howe, Norfolk and Kermadec islands, with the Chatham, Auckland and Macquarie groups. The main affinities of the avifauna are, of course, Australian. The most extraordinary feature is unquestionably the former existence of the gigantic *Dinornithes* or moas (*q.v.*) and, another family of Ratitæ, the weird-looking kiwis or Apteryges, which are totally unlike any other existing birds. Of other peculiar genera it



FIG. 22.—Extinct Phillip-Island Parrot (*Nestor productus*). (From specimen in the British Museum. Reduced.)

will suffice to mention only the more remarkable. The *Rallidae* present the very noteworthy woodhens, *Ocydromus*, and the takake, *Notornis*, which is almost extinct. The widely-spread plovers, *Charadriidae*, have two not less singular generic developments, *Thimornis*, and the extraordinary wrybill, *Aramycterus*. There is an owl, type of the genus *Sceloglaux*. Of parrots, *Stringops*, the kakapo or owl-parrot, is certainly peculiar, while *Nestor* constitutes a peculiar subfamily of the brush-tongued parrots or *Trichoglossidae*. *Xenicus* and *Acanthisitta* form a little family of truly mesomyzodæan Passeres Columatores. Of the *Meliphagidae* the genera *Prosthemadera*, *Pogonornis* and *Anthonis* are peculiar. The starlings, *Sturnidae*, are represented by *Callaeas*, *Creadion* and the very abnormal *Heterolocha*. The gallinaceous birds are represented by a quail, *Coturnix novae zelandiae*, now exterminated. A large flightless goose, *Cnemidornis*, allied to the Australian *Cereopsis*, and the gigantic rapacious *Harpagornis*, have died out recently, with the moas. In all, there is a wonderful amount of specialization, though perhaps in a very straight line from generalized forms; but the affinity to Australian or Polynesian types is in many cases clearly traceable, and it cannot be supposed but that these last are of cognate origin with those of New Zealand. A very long period of isolation must have been required to produce the differences so manifestly to be observed, but a few forms seem at rare intervals to have immigrated, and this immigration would appear to be kept up to our own day, as shown by the instance of *Zosterops lateralis*, which is said to have lately made its first appearance, and to have established itself in the country, as well as by the fact of two cuckoos,

¹ The following old-fashioned rough computation may serve as an indication of the relative size of the orders and suborders of recent birds:—

Ratitæ	20	Charadriiformes	650 (incl. Columbæ
Columbiformes	20		350)
Sphenisciformes	15	Cuculiformes	600 (incl. Psittaci
Procellariiformes	90		400)
Ciconiiformes	150	Coraciiformes	1600 (incl. Trochili
Anseriformes	150		and Pici)
Falconiformes	360	Passeres Columatores	2000
Tinamiformes	40	Passeres Oscines	5000
Galliformes	370		
Grulliformes	250		
		Total about	10,300 species

the widely-ranging *Eudynamis taitensis* and *Chrysococcyx lucidus*, which are annual visitors.

Polynesia forms, of course, part of Austrogaëa. Its extent is so vast that it necessarily contains some peculiar, outlying forms, so to say forgotten, which in their long-continued isolation have specialized themselves. For instance, the kagu (*Rhinoceros*) of New Caledonia, a queerly specialized form with Gruline affinities pointing only to South America. The tooth-billed pigeon (*Didunculus*) is restricted to Samoa. Most interesting is the avifauna of the Sandwich islands; entirely devoid of Pittacidae and of Coraciiformes, these islands show an extraordinary development of its peculiar family *Drepanidae*, which are probably of South or Central American descent. *Aerolocercus* is a Meliphagine, and a peculiar genus. There are a raven (*Corvus*), a coot (*Fulica*), the well-known Sandwich island goose (*Bernicla sandvicensis*), now very commonly domesticated in Europe; and some flycatchers and thrushlike birds.

The *Australian Subregion* comprises Australia and Tasmania. In the north it is influenced, of course, by its proximity to Papuasia, where there is a considerable admixture of genera which do not proceed beyond the tropics, and of these *Casuarina* is a striking example. The Cape York peninsula practically belongs to Papuasia. As a whole, Australia is rich in parrots, of which it has several very peculiar forms, but Picaridians in old-fashioned parlance, of all sorts—certain kingfishers excepted—are few in number, and the pigeons are also comparatively scarce, no doubt because of the many arboreal predeceasing marsupials. The continent, however, possesses the two important genera of the *Pseudoscines*, namely the lyre-birds (*Menura*) and the scrub-birds (*Atrichia*). Among the more curious forms of other land-birds may be especially mentioned the *Megapodidae*, *Talaboa* and *Talaboa*, the rail *Tribonyx*, and *Pediornis*, which represents the otherwise palaeotropical *Turnices* in Australia. The presence of bustards (*Eupodotis*) is a curious example of interrupted distribution, since none other of the *Otididae* are found nearer than India. The Ratitae are represented by two species of emu (*Dromaeus*), besides the cassowary of Cape York peninsula, and the extinct *Dromornis* and *Genyornis* with its enormous skull.

The *Papuan Subregion*, chiefly New Guinea with its dependencies, the Timor group of islands, the Moluccas and Celebes. On the whole its avifauna presents some very remarkable features. The most characteristic is the presence of a number of islands, or paradises, which are almost peculiar to it; for, granting that the bower-birds, *Chlamydotera* and others, of Australia, belong to the same family, they are far less highly specialized than the beautiful and extraordinary forms which are found, within very restricted limits, in the various islands of the subregion. Another chief feature is the extraordinary development of the cassowaries, the richness and specialization of the kingfishers, parrots, pigeons, honeyeaters and some remarkable flycatchers. It has several marked deficiencies compared with Australia, among which are the babbler (*Timeliidae*), weaver birds (*Ploceidae*), the *Platyseriidae* among parrots, diurnal birds of prey and the emeus, the whole of the birds of paradise, the remarkable for their brilliance of plumage, or their metallic coloring. The birds of paradise, the racket-tailed kingfishers, *Tanyseriptera*, the largest and smallest of parrots, *Calyptorhynchus* and *Nasiterna*, and the great crowned pigeons, *Goura*, are very characteristic; and so are the various Megapodes.

(B) NEOGAËA, of the Neotropical region.—Excepting towards the north, where, in Mexico, it meets, and insinuates with the Nearctic subregion, the boundaries of the Neotropical region are simple enough to trace, comprehending as it does the whole of South America and all Central America, the whole of the Falkland Islands to the south-east, and the Galapagos under the equator to the west, as well as the Antilles or West India islands up to the Florida channel.

Owing to the comparatively scanty number of harmful mammalian types, the birds play a considerable part in this large region, and some authorities consider its avifauna the richest in the world. The entire number of species amounts to about 3600. Of these 2000, or a good deal more than half, belong to the order Passeriformes. But the characteristic nature of the avifauna is more clearly brought out when we learn that of the 2000 species just mentioned only about a top to bottom of the higher suborder Oscines, that means to say, nearly one-half belong to the lower suborder Clamatores. This is a state of things which exists nowhere else; for except in Australia, where a few indigenous and peculiar low non-Oscines are found, and in the Nearctic country, whither one family of Clamatores, viz. the *Tyrannidae*, has evidently been led by the geographical continuity of its soil with that of the Neotropical region, such forms do not occur elsewhere. Accordingly their disproportionate prevalence in South America points unerringly to the lower rank of the avifauna of the region as a whole, and therefore to the propriety of putting it at the under side of the Australian region, and of the present fauna of which is admitted the lowest in the world. Huxley has urged with his wonted perspicuity the alliance of these two regions as *Notogaëa*, basing his opinion, besides other weighty evidence, in great measure on the evidence afforded by the two main sections of the Galli, viz. the *Peristeropodes* and the *Alectoropodes*, the former composed of the families *Megapodidae*, almost wholly Australian, and the *Cracidae*, entirely Neotropical. (Cf. P.Z.S., 1868. pp. 294-319.)

Leaving, however, this matter as in some degree hypothetical, we have as genera, families, or perhaps even larger groups, a great many very remarkable forms which are characteristic of, or peculiar to, the Neotropical region in part, if not as a whole. Of families we find twenty-three, or maybe more, absolutely restricted thereto, besides at least eight which, being peculiar to the New World, extend their range into the Nearctic region, but are there so feebly developed that their origin may be safely ascribed to the southern portion of America. First in point of importance comes the extraordinarily beautiful family of humming-birds (*Trochilidae*), with nearly 150 genera (of which only three occur in the Nearctic region) and more than 400 species. Then the tyrants (*Tyrannidae*), with more than seventy genera (ten of which range into the northern region), and over 300 species. To these follow the tanagers (*Tanagridae*), with upwards of forty genera (only one of which crosses the border), and about 300 species; the piculines (*Dendrocolaptidae*), with as many genera, and over 200 species; the ant-thrushes, (*Formicariidae*), with more than thirty genera, and nearly 200 species; together with other groups which, if not so large as those just named, are yet just as well defined, and possibly more significant, namely, the tapaculos (*Pteropodidae*), the toucans (*Rhamphitidae*), the jacamars (*Galbidae*), the motmots (*Monotidae*), the todies (*Todidae*), the trumpeters (*Psophiidae*), and the screamers (*Palamedidae*); besides such isolated forms as the seriema (*Cariama*), and the sun-bittern (*Eurypyga*).

The nature of the South American avifauna will perhaps become still more evident if we arrange the characteristic members as follows:—

1. Birds which are restricted to, probably indigenous of the region of *Rhea*; *Palamedea* and *Chauna*, the screamers; *Tinami*; *Phoebastria*, *Dicholophus*, *Eurypyga*, *Heliornis* of the Gruiform assembly; *Trochocorys* and *Attagis*; *Cracidae*; *Opihochomus*; of parrots *Ara* and *Conurus* with their allies; *Monotidae*, incl. *Todus*; *Steatornis*; *Galbuninae* and *Bucconinae*; *Rhamphitidae*; *Formicariidae*, *Pteropodidae*, and of the *Tyrannidae* the *Cotinginae*.

2. Birds which are indigenous, but extend far into North America: *Cathartae*, *Trochilidae*, *Tyrannidae*.

3. Birds which are originally immigrants from North America: *Falcipectidae*, with the flightless *Centropus* on Lake Titicaca; and the only genus of kingfishers in the New World; all the *Oscines*.

More or less cosmopolitan groups like herons, *Falconidae*, *Anseres*, *Columbae*, &c., and circumtropical families like *Paridae*, *Trogonidae*, *Copitidae*, are to be excluded from these lists as indifferent. The differences between the Neotropical avifauna and that of North America are fundamental and prove the independence or superior value of the Neotropical region as one of the principal realms.

It is difficult to subdivide the Neotropical region into subregions; the best suggestion is that of Newton: *Antillean*, with the exception of the islands of Trinidad and Tobago, as well as those which lie on the northern coast of South America; *Patagonian*, including Chile and part of Peru; *Columbian*, comprising the rest of the continent and also Central America.

The *Antillean Subregion* is in many respects one of the most suggestive and interesting, comparatively small though it be. For narrow as are the channels between Cuba and the opposite coast of Central America, between the Bahamas and Florida, and between Grenada and Tobago, the fauna of the Antillean chain, instead of being a mixture of that of the almost contiguous countries, differs much from all, and exhibits in some groups a degree of speciality which may be not unfrequently compared with that of each island. Except such as are of continental formation, the Antilles are hilly, not to say mountainous, their summits rising in places to an elevation of 8000 ft., and nearly all, prior to their occupation by Europeans, were covered with luxuriant forest, which, assisting in the collection and condensation of the clouds brought by the trade winds, ensured its own vitality by precipitating frequent and long-continued rains upon the fertile soil. Under such conditions we might expect to find an extremely plentiful animal population, one as rich as that which inhabits the same latitudes in Central America, not many degrees farther to the west, but no instance perhaps can be cited which shows more strikingly the difference between a continental and an insular fauna, since, making every allowance for the ravages of cultivation by civilized man, the contrary is the case, and possibly no area of land so highly favoured by nature is so poorly furnished with the higher forms of animal life. Here, as over so large a portion of the Australian region, we find birds constituting the supreme class—the scarcity of mammals being accounted for in some measure as a normal effect of insularity.

There is one peculiar subfamily, *Todidae*, represented by only four species of *Todus*. We note the absence of *Ratitae*, *Tinami*, *Cracidae*, *Rhamphitidae*, and any of the other avifaunal genera which are so characteristic of the continent. There is no family of birds common to the Nearctic area and the Antillean subregion without occurring also in other parts of the Neotropical region, a fact which proves its affinity to the latter.

The *Patagonian Subregion*, most extratropical, is naturally devoid of a good many typically tropical birds, or these are but poorly represented, for instance *Caeribidae*, *Mniotiltidae*, *Tanagridae*, *Vireonidae*. On the other hand some of the most characteristic

features of the whole region are here well represented, e.g. *Rhea*, *Tinami*, *Chayna*, *Dicholophus*, *Atagis*, *Pteroplochidae*, and indeed therein we find some of the best evidence of the antiquity of its population, both recent and extinct (cf. the numerous fossils of the Santa Cruz formation), and also the nearest resemblance to the fauna of Australroga.

(C) ARCTOGAEA is Huxley's well-chosen term for all the rest of the world (including the Nearctic, Palearctic, Indian and Ethiopian regions of P. L. Sclater) in opposition to Australroga. Faunistically, although not geographically, the Nearctic and Palearctic areas must form the two subdivisions of one great unit, for which the "Holarctic region" is now the generally accepted term.

The Holarctic region, comprising North America and the extratropical mass of land of the Old World, may from an ornithological point of view be characterized by the Colymbi, *Alcidae*, *Gallidae* or *Alectoropodous* Gallii, and the Oscines, which have here reached their highest development; while Ratiidae, Tinami, Psittaci, and non-Oscine Passeres (with the exception of *Tyrannidae* extending into North America and *Corvus carolinensis*) are absent.

Nearctic Subregion.—The close affinity of North America with the Palearctic avifauna becomes at once apparent if we exclude those groups of birds which we have good reason to believe have their original home in the Neotropical region, notably numerous *Tyrannidae*, humming-birds and the turkey-buzzards.

The following groups may be mentioned as characteristic and typically American, and, since we consider them as comparatively recent immigrants into the Neotropical region, as originally peculiar to the Nearctic area: *Mniotiltidae*, *Vireonidae*, *Icteriidae*, *Melaneris* and various *Troglodytidae*. Restricted to the Nearctic subregion is only the little Oscine family of *Chamaeaedae*, restricted to the coast district of California. "More than one-third of the genera of Nearctic birds are common also to the Palearctic subregion. If we take the number of Nearctic species at 700, which is perhaps an exaggeration, and that of the Palearctic at 850, we find that, exclusive of stragglers, there are about 120 common to the two areas. Nearly 20 more are properly Palearctic, but occasionally occur in America, and about 50 are Nearctic, which from time to time stray to Europe or Asia. This, however, is by no means the only point of resemblance. Many forms so-called are found in the Old World are represented in the Old by forms so like them that often none but an expert can distinguish them, and of such representative species' about 80 might be enumerated" (Newton, *Dict. Birds*, p. 335).

Of the many attempts to subdivide the Nearctic subregion, the same authority favours that of Dr S. F. Baird, who distinguishes between *Canadian*, *Alleghanian*, *Middle* or *Missourian*, *Californian* and *Alaskan* provinces. Dr Hart Merriam takes the broad point of view "that the whole of extratropical North America consists of one primary life region, *Arctic*, in which is circumpolar, and a *Sonoran* or Mexican tableland region which is unique." The first of these supports Newton's contention of the essential unity of the Nearctic and Palearctic areas. In any case the various Nearctic subdivisions completely merge into each other, just as it is to be expected from the physical configuration and other biotic conditions of the North American continent.

The *Palearctic Subregion* is, broadly speaking, Europe and Asia, with the exception of India and China. The propriety of comprehending this enormous tract in one zoological region was first shown by Dr P. L. Sclater, and as regards the distribution of most classes of animals there have been few to doubt that it is an extremely natural one. Not indeed altogether so homogeneous as the Nearctic area, it presents, however, even at its extreme points, no very striking difference between the bulk of its birds. Though Japan is far removed from western Europe, and though a few generic forms and still fewer families inhabit the one without also frequenting the other, yet there is a most astonishing similarity in a large portion of their respective birds. In some cases the closest examination has failed to detect any distinction that may be called specific between the members of their avifauna. Even when the birds are regarded as just sufficient difference to warrant a separation of the subjects. Nevertheless, it is clear that in Japan we have, as it were, a repetition of some of our most familiar species—the redbreast and the hedge-sparrow, for example—slightly modified in plumage or otherwise, so as to furnish instances of the most accurate representation, e.g. *Cyanopica cooki* of Portugal and Spain, and *C. cyana* of Amoorland and Japan.

Like the Nearctic the Palearctic subregion seems to possess but one single peculiar family of land birds, the *Panuridae*, represented by the beautiful species known as the "cardinal bird." The *Panuridae*, *Panurus biarmicus*. The entire number of Palearctic families are, according to Newton, 67, and of the genera 323. Of these 128 are common to the Nearctic subregion. Species of 51 more seem to occur as true natives within the Ethiopian and Indian regions, and besides these 18 appear to be common to the Ethiopian without being found in the Indian, and no fewer than 71 to the Indian without occurring in the Ethiopian. To compare the Palearctic genera with those of the Australian and Neotropical regions would be simply a waste of time, for the points of resemblance are extremely few, and such as they are they lead to nothing. It will therefore be seen from the above that next to the Nearctic area the

Palearctic has a much greater affinity to any other, a fact which might be expected from geographical considerations.

Having shown this much we have next to deal with the peculiarities of the vast Palearctic subregion. At the lowest computation 37 genera seem to be peculiar to it, though it is certain that species of several are regularly wont to wander beyond its limits in winter seeking a southern climate. Of the peculiar genera only a few examples may be mentioned: *Euryornis hynchus*, the spoon-billed sandpiper of Siberia; *Syrhaptes*, the sandgrouse of central Asia; *Muscicapa* of Europe.

We distinguish between a *Siberian*, *Mongolian*, *Mediterranean* and *European province*, none of which can be well defined. The islands of the Canaries, Madeira and the Azores belong to the Mediterranean province, and offer some peculiarities of great interest. The Azores have been monographed by F. D. Godman (*Nat. Hist. of the Azores or Western Islands*, London, 1870). There is a general tendency among these insular birds to vary more or less from their continental representatives, and this is especially shown by the former having always darker plumage and stronger bills and legs. In one instance the variation is so excessive that it fully justifies the establishment of a specific distinction. This is the case of the bullfinch of the more western of these islands (*Pyrrhula murina*), the male of which, instead of the ruddy breast of its well-known congener (*P. vulgaris*), has that part of a sober mouse-colour. A similar sombre hue distinguishes the peculiar chaffinch of the Canary Islands (*Fringilla teydea*), but to these islands as well as the Azores and Madeiras there belongs in common another chaffinch (*F. tristis*) which, though very nearly allied to *F. montana* and *spodogenis*, is peculiar to Madeira, and is not found elsewhere. Madeira has also its perfect golden-crested wren (*Regulus madagascariensis*), and its peculiar pigeon (*Columba troazae*), while two allied forms of the latter (*C. laurivora* and *C. bolivi*) are found only in the Canaries. Further on this subject we must not go; we can only state that Godman has shown good reason for declaring that the avifauna of all these islands is the effect of colonization extending over a long period of years, and going on now.

PALEOTROPICAL REGION.—Much can be said in favour of combining the mostly tropical portion of the great mass of land of the Old World (excluding of course Australroga or the Australian region into one region, for which Oscar Reuter's well-chosen term "palaeotropical" has been adopted (cf. Bronn's *Thierreich, System Part*, p. 296, 1893). This region naturally comprises the African and Indian areas, conformably to be called subregions.

Both subregions possess, besides others, the following characteristic birds: Ratiidae, viz. *Struthio* in Africa and Arabia, fossil also in the Sivalik Hills, and *Aepyornithidae* in Madagascar; *Pittidae*, *Bucconidae* and *Upupidae*, of which *Upupa* itself in India, Madagascar, and Africa; *Cracidae*; *Panoroidae* or bustards; *Trogonidae*, of which the African genera are the most specialized, and which in the Neotropical forms; *Vulturidae*; *Leptoptilidae*, *Anatomus* and *Ciconia* among the storks; *Pterocidae*; *Treroninae* among pigeons. Of other families which, however, extend their range more or less far into the Australian realm, may be mentioned *Otididae*, the bustards; *Meropidae* or bee-eaters; *Muscicapidae* or flycatchers; *Sturnidae* or starlings.

The *Ethiopian Subregion* comprises the whole of Africa and Madagascar, except the Barbary States, but including Arabia; in the north-east the subregion meets into the Palearctic between Palestine and the Persian Gulf. Some authors are inclined to extend its limits still farther to the eastwards, through Beluchistan and even beyond the Indies.

So large a portion of the Ethiopian subregion lies between the tropics that no surprise need be expressed at the richness of its fauna relatively to that of the last two subregions we have considered. Between fifty and sixty so-called families of land birds alone are found within its limits, and of them at least nine are peculiar: the typical genera of which are *Buphaga*, *Euryceros*, *Philepitta*, *Muscopoda*, *Irrisor*, *Leposoma*, *Colius*, *Serpentarius*, *Sirathio*, *Aepyornis*. It is singular that on the first three species belong to the order *Passeriformes*, a proportion which is not maintained in any other tropical region. The number of peculiar genera, besides those just mentioned, is too great for them to be named here; some of the most remarkable on the continent are: *Balaeniceps*, the whale-headed heron; *Balaearca*, the crowned crane; *Podica*, finfoot; *Nimida* and allied genera of guinea fowls.

The natural division of the subregion is that into an African and a Madagascar province. Subdivision of the continental portion is beset with great difficulties, and none of the numerous attempts have proved very successful. The forest-clad banks of the Congo with the coastal districts of the Bay of Guinea, seem to form one domain in opposition to the rest.

The Malagasy province comprises, besides Madagascar, the Mascarene, Comoro and Seychelle islands. It may be safely deemed the most peculiar area of the earth's surface, while from the richness and multifariousness of its animal, and especially of its ornithic population, New Zealand cannot be compared with it. In A. Grandinier's magnificent *Histoire physique, naturelle et politique de Madagascar*, vol. xii. (Paris, 1875-1884), are enumerated 238 species as belonging to the island, of which 22 are peculiar to it, and among those are no fewer than 35 peculiar genera. *Euryceros* of the

Oscines, and *Philepitta* of the Clamatores, are remarkable enough to form the types of Passeriform families, and *Mesites* half-way between Galli and Gruiformes is of prime importance. The Passerine *Falcidia*, with its recently extinguished allies *Fregilupus* and *Necropsar* of the Mascarenes; the Coraciine *Brachypteryx*, *Atelornis* and *Geobiasles*, are very abundant, while *Heliodilus* is an owl belonging to that subfamily which is otherwise represented only by the widely-spread barn owl, *Strix flammea*. Lastly must be noted the extinct tall Ratite species of *Aepyornis* with its several fancy genera. But, as Newton charmingly puts it (*Dict. Birds*, p. 353), the avifauna of Madagascar is not entirely composed of such singularities as these. We have homely genera, even among the true *Passeres*, occurring there—such as *Alauda*, *Acrocephalus*, *Motacilla* and *Pratincola*, while the *Cisticola madagascariensis* is only distinguishable from the well-known fan-tailed warbler, *C. schoeniola* of Europe, Africa and India by its rather darker coloration. But there are also species, though not Passerine, which are absolutely identical with those of Britain, the barn owl, common quail, pigmy rail, and little grebe or dabchick, all of them common and apparently resident in the island. Mauritius had the dodo (*q.v.*), *Lophopsittacus* and *Aphanapteryx*. Rodriguez had the solitaire, *Necropsittacus* and *Necropsar*. Bourbon or Réunion had *Fregilupus*.

Some of the Malagasy avifauna is certainly ancient, aboriginal, and even points to India; other forms indicate clearly their African



FIG. 23.—Extinct Starling of Réunion (*Fregilupus varius*), adapted from figures by Daubenton, Levaillant and others. Reduced.

origin; while, lastly, such strikingly characteristic Indo-African birds as hornbills are unaccountably absent.

The *Oriental Subregion* comprises all the countries and numerous islands between the Palaearctic and Australian areas; it possesses upwards of seventy families, of which, however, only one is peculiar, but this family, the *Eurylaemidae* or broadbills, is of great importance since it represents all the *Subclamatores*. Of the many characteristic birds may be mentioned *Pycnonotidae* or bulbuls, of which the *Dichlorini* are peculiar, *Campophagidae* or cuckoo-shrikes, *Phylloscopidae* or drongos, *Nectariniidae* or sunbirds; pheasants, together with *Pavo* and *Gallus*. Some of the similarities to the Ethiopian and the great differences from the Australian avifauna have already been pointed out. Naturally no line whatever can be drawn between the Oriental and the Palaearctic subregions, and many otherwise essentially Indo-Malayan families extend far into the Australian realm, far across Wallace's line, whilst the reverse takes place to a much more moderate extent. Certainly the Oriental area, in spite of its considerable size, cannot possibly claim the standing of a primary region. It is a continuation of the great *Arctogaea* into the tropics.

Following H. J. Elwes we subdivide the whole subregion into a *Himalo-Chinese*, Indian and Malayan province. These divisions had the approval of W. T. Blanford, who proposed the terms *Cis- and Transgangetic* for the two first. The *Himalo-Chinese* or *Transgangetic* province shows the characteristics of its avifauna also far away to the eastward in Formosa, Hainan and Cochin China, and again in a lesser degree to the southward in the mountains of Malacca and Sumatra. Indo-China is especially rich in *Eurylaemidae*, *China* proper and the Himalayas in pheasants.

The Indian or *Cisgangetic* province is the least rich of the three so far as peculiar genera are concerned.

The Malayan province comprising the Malay islands, besides the Malay peninsula, and the very remarkable Philippines, possess an extraordinary number of peculiar and interesting genera.

The influence of the Australian realm is indicated by a *Megapode* in Celebes, another in Borneo and Labuan, and a third in the Nicobar islands (which, however, like the Andamans and belong to the Indian province), but there are no cockatoos, these keeping strictly to the other side of Wallace's line, whence we started on this survey of the world's avifauna.

D. CLASSIFICATION OF BIRDS

Fürbringer's great work, published in the year 1888 by the *Natura Artis Magistra* Society of Amsterdam, enabled Gadow not only to continue for the next five years the same lines of morphological research, but also further to investigate those questions which were still left in abeyance or seemed to require renewed study. The resulting "classification is based on the examination, mostly autoptic, of a far greater number of characters than any that had preceded it; moreover, they were chosen in a different way, discernment being exercised in sifting and weighing them, so as to determine, so far as possible, the relative value of each, according as that value may vary in different groups, and not to produce a mere mechanical 'key' after the fashion become of late years so common" (Newton's *Dictionary of Birds*, Introduction, p. 103). It is not the quantity but the quality of the anatomical and bionomic characters which determines their taxonomic value, and a few fundamental characters are better indications of the affinities of given groups of birds than a great number of agreements if these can be shown to be cases of isomorphism or heterophyletic, convergent analogy. Nature possesses three great educational or developmental schools—terrestrial, aquatic and aerial life. Each of these affords animal, vegetable or mixed diet. Animal diet implies the greatest variety with regard to locality and the modes of procuring the food. Each of these schools impresses its pupils, in the case of the birds, with its own stamp, but there are many combinations, since in the course of phyletic development many a group of birds has exchanged one school for another. Originally terrestrial groups have taken to an entirely aquatic life, and *vice versa*; others, originally endowed with the power of flight, have become, or are transforming themselves into, absolutely cursorial forms; some members of one group live entirely on seeds, while others have become fierce fishers, and so forth. Only by the most careful inquiry into their history can their relationship or pedigree be unravelled. A statement may now be given of Gadow's classification of birds, in which the extinct forms have been intercalated so far as possible. The few characters assigned to the various groups are sufficiently diagnostic when taken together, although they are not always those upon which the classification has been established:—

CLASS AVES

I. Sub-class **Archaeornithes**.—The three fingers and their metacarpals remain separate, each with a claw. Well-developed remiges. Both jaws with alveolar teeth. Amphiceolous. Caudal vertebrae more than thirteen, without a pygostyle, but with about twelve pairs of rectrices. *Archaeopteryx*, *A. lithographica*, *s. macroura*, two specimens from the upper Oolite of Solenhofen, Bavaria.

II. Sub-class **Neornithes**.—Metacarpals fused. Second finger the longest. Not more than thirteen caudal vertebrae.

I. Division **RATITAE**.—Terrestrial, flightless. Without sternal keel. Quadrate bone with single proximal knob. Without pygostyle. Coracoid and scapula fused. Compound rhamphotheca. Adult without apteria. With copulatory organ. A collective polyphyletic or heterogeneous group, originally cosmopolitan; with certainty existing since the Miocene.

1. Order **Struthionae**.—With pubic symphysis. Two toes only, third and fourth. *Struthio*, ostrich, Pliocene of Samos and of north-west India, now Africa and Arabia.
2. Order **Rheae**.—With long ischiadic symphysis. Three toes. *Mesembriornis*, Miocene or Pliocene of Argentina. *Rhea*, South America.

3. Order **Casuarii**.—Three toes. Aftershaft as long as the other half. *Casuarii* and *Dromæus*, Australian. *Hypselornis*, Pliocene of Sivalik Hills.
4. Order **Apteryges**.—Four toes. Bill long and slender. *Apteryx*, New Zealand.
5. Order **Dinornithes**.—Three or four toes. Bill short. Anterior limb extremely reduced. *Dinornis*, numerous species, recently extinct, New Zealand.
6. Order **Aepyornithes**.—*Aepyornis*, recently extinct, Madagascar.
- To the Ratitae belong possibly also the imperfectly known *Diatryma*, Eocene of New Mexico, *Gastornis* and *Dasornis*, Eocene of Europe, *Genyornis*, Pleistocene of Australia.
- II. Division **ODONTOLCAE**.—Marine, flightless, without sternal keel. Upper and lower jaws with teeth in furrows. Cretaceous epoch. *Enalornis*, England, vertebrae chiefly bicovae; *Hesperornis*, North America, vertebrae heterocoelous.
- III. Division **CARINATAE**.—With keeled sternum.
1. Order **Ichthyornithes**.—Power of flight well developed. Vertebrae still amphicoelous. With small pygostyle. Incisura ischiadica. With alveolar teeth. Cretaceous of Kansas. *Ichthyornis*, *Aptornis*.
2. Order **Colymbiformes**.—Plantigrade, nidifugous, aquatic. All toes webbed, fourth largest; hallux short; metatarsus laterally compressed; tibia with high, pyramidal crest. Bill straight, pointed, with simple sheath.
- Sub-order 1. **COLYMBI**, Divers. Front toes completely webbed. Holarctic. *Colymbus*.
- Sub-order 2. **PODICIPEDES**, Grebes. Toes lobated. Cosmopolitan.
3. Order **Sphenisciformes**.—Nidicolous, marine. Flightless, wings transformed into rowing paddles. **SPHENISCI**, penguins. Antarctic and southern temperate coasts. Since the Eocene.
4. Order **Procellariiformes**.—All flying, pelagic, nidicolous. Hallux absent or vestigial. Rhamphotheca compound. Cosmopolitan. **TUBINARES**, petrels and albatrosses.
5. Order **Ciconiiformes**.—Swimmers or waders. Desmognathous, without basiterygoid processes; with one pair of sternotracheal muscles.
- Sub-order 1. **STEGANOPODES**.—Well flying, aquatic, nidicolous; with all the four toes webbed together. Rhamphotheca compound; cosmopolitan. *Phaethon*, tropic-bird; *Sula*, gannet; *Palaeocorax*, cormorant and *Platys*, snake-bird; *Fregata*, frigate-bird; *Pelecanus*. Here also *Pelagornis*, Miocene of France; *Argillornis* and probably *Odontopteryx* from the London Clay.
- Sub-order 2. **ARDEAE**.—Piscivorous, nidicolous, waders; with complicated hypotarsus and with long cervical apteria. *Ardeidae*, cosmopolitan; including *Cameroa*, Neotropical, *Balaeniceps*, *Scopidae*, Ethiopian. *Proherodius*, Eocene of England.
- Sub-order 3. **CICONIAE**.—Zoophagous, nidicolous, waders; with simple hypotarsus and without cervical apteria. Cosmopolitan. *Ciconiidae*, storks. *Ibidae*, ibises and spoonbills. *Propropalaris*, Oligocene.
- Sub-order 4. **PHOENICOPTERI**.—Flamingos. Nidifugous, waders; with simple hypotarsus and without cervical apteria. Front toes completely webbed; hallux very short or absent; feed chiefly on small aquatic invertebrates. *Phoenicopterus*, cosmopolitan. Oligocene *Elornis* and allied, *Palaeolodus*.
6. Order **Anseriformes**.—Desmognathous, nidifugous; with two pairs of sternotracheal muscles, with complete basiterygoid processes and with a pennis.
- Sub-order 1. **PALAMEDAE**.—Screamers. Ribs without uncinate processes. Hypotarsus simple. Neotropical. *Chauna*, *Palamedea*.
- Sub-order 2. **ANSERES**.—Family *Anatidae*. Hypotarsus complex. *Anser*, *Anas*, *Cygnus*, and since Miocene. *Cnemidornis*, Pleistocene, New Zealand, flightless.
7. Order **Falconiformes**.—Birds of prey. Carnivorous, desmognathous, nidicolous, without functional caeca. Terrestrial, aerial.
- Sub-order 1. **CATHARTAE**.—American vultures. With nares perviae. *Cathartes*, turkey buzzards, *Sarcophagophy gryphus*, condor *Gypagus papa*, king vulture.
- Sub-order 2. **ACCIPITRES**.—With nares imperviae. *Serpentariidae*, secretary-bird, Ethiopian; Miocene, France. *Vulturidae*, Old World vultures, excluding Australia. *Falconidae*, cosmopolitan, since the Eocene. *Harporornis*, Pleistocene, New Zealand; *Lithornis*, Eocene, England. *Pandionidae*, ospreys or fish hawks, cosmopolitan.
8. Order **Tinamiformes**.—Nidifugous, with incisura ischiadica, without pygostyle. Herbivorous, terrestrial, neotropical. *Crypturi*, tinamous.
9. Order **Galliformes**.—Schizognathous, herbivorous, terrestrial. With ten functional remiges. With strong spinae sterna.
- Sub-order 1. **MESITES**.—Without basiterygoid processes, and with large spina interna. *Mesites*, Madagascar.
- Sub-order 2. **TURNICES**.—Hemipodes or button-quails. Nidifugous; vomer large; sternum without processus obliqui. Hallux absent or vestigial. Old World. *Turnix*, *Pedionomus*.
- Sub-order 3. **GALLI**.—With large spina communis, and with large processus obliqui. Hallux functional. *Megapodiidae*, Australian ground. *Cracidae*, curassows and guans, neotropical. *Gallidae*, cosmopolitan.
- Sub-order 4. **OPISTHOCOMI**.—Arboreal, with long spina externa; without basiterygoid processes. *Opisthocomus* hoatzin, Guiana, Venezuela and Amazon countries.
10. Order **Gruiformes**. Legs of the wading type. Without basiterygoid processes. Without spina interna. Nidifugous. Essentially schizognathous. *Rallus*, cosmopolitan, since Oligocene. *Rallus*, *Fulica*, *Ocydromus*, &c., *Gallinula*, nestors, Tristan d'Acunha, flightless, *Notornis*, New Zealand, flightless, nearly extinct. *Aptornis*, New Zealand, flightless, extinct. *Aphapheryx* (Mauritius) = *Erythromachus* (Rodriguez) = *Diphoropteryx* (Chatham Island), flightless and recently extinct. *Gypsornis*, upper Eocene, France. *Gruidae*, cranes, cosmopolitan, allied *Phororhacos*, Tertiary of Argentina. *Dicholophidae*, cariamas, neotropical. *Otididae*, bustards, Old World. *Rhinchochetidae*, kagus, New Caledonia. *Eurypteryxidae*, sun-birds, neotropical. *Helimionidae*, finfoots, tropical.
11. Order **Charadriiformes**.—Schizognathous. With eleven remiges, of which the terminal very short. Aquinto-cubital. Spinae sterna short, separate.
- Sub-order 1. **LIMICOLAE**.—Nidifugous, without spina interna sterna. Hypotarsus complicated. *Charadriidae*, plovers. *Chionidae*, sheath-bill. *Glaucoidae*, wading swallows and coursers. *Thinocorythidae*, seed-snipes. *Oediemididae*, thick-knees. *Prariidae*.
- Sub-order 2. **LABI**.—Aquatic, vomer complete. Without basiterygoid processes. Front toes webbed; hallux small or absent. Large supraorbital gland. Since Miocene. *Laridae*, gulls, cosmopolitan. *Alcidae*, auks, northern half of periarctic region.
- Sub-order 3. **PTEROCLES**.—Sand-grouse. Nidifugous. Vomer vestigial. With large crop and caeca. Hallux vestigial or absent since Oligocene. Africa to India, and Siberia. *Pterocles* and *Syrphates*.
- Sub-order 4. **COLUMBAE**.—Pigeons. Nidicolous. Vomer vestigial. With large crop, vestigial caeca. *Columbidae*, cosmopolitan, since Miocene. *Dididae*, flightless, recently extinct. *Didus*, dodo, Mauritius. *Phephaps*, solitaire, Rodriguez.
12. Order **Cuculiformes**.—Desmognathous, nidicolous; zygodactylous, or with the outer toe reversible.
- Sub-order 1. **CUCULI**.—Cuckoos. Quinto-cubital. *Cuculidae*, cosmopolitan. *Masophaigidae*, plantain-eaters and touraocs, Ethiopian since Miocene.
- Sub-order 2. **PSITTACI**.—PARROTS. Zygodactylous; aquinto-cubital. Cosmopolitan, chiefly tropical. *Trichoglossidae*, lorics, Austro-Malayan. *Nectar*, New Zealand. *Cypsiptacus*, *Eos*, *Lorius*, &c. *Psittacidae*, tongue smooth, incl. *Stringops*.
13. Order **Coraciiformes**.—Nidicolous. Nares imperviae, holohrhinal. Downs restricted to the apteria or absent. Thirteen to fifteen cervical vertebrae. Mostly desmognathous. Deep plantar tendons connected with each other.
- Sub-order 1. **CORACIAE**.—Either (1) with long spina externa sterna, *Coraciidae*, rollers, Old World. *Momotidae*, neotropical, monots and otides. *Alcedinidae*, kingfishers, cosmopolitan or (2) with long spina communis. *Meropidae*, bee-eaters, Old World. *Upupidae*, *Upupidae*, hoopoes: palaeartic and palaeotropical. *Bucerotinae*, hornbills, palaeotropical; *Irrisorinae*, woodhoopoes, Ethiopian.
- Sub-order 2. **STRIGES**.—OWLS. Flexor toe reversible. Schizognathous. Long caeca. Outer tendons normal. Hypotarsus simple. Cosmopolitan.
- Sub-order 3. **CAPRIMULGI**.—Nightjars. Nocturnal. With gaping mouth. Ten remiges and ten retrices. Spinae sterna vestigial. Caeca functional. *Steatorhinidae*, *Steatornis*, oil-bird or guacharo, South America. *Podargidae*, Australasian, *Caprimulgidae*, cosmopolitan.
- Sub-order 4. **CYPSELLI**.—Tenth terminal remex the longest. With short spinae sterna. Without caeca. *Cypselidae*, swifts, cosmopolitan. *Trochilidae*, humming-birds, American.
- Sub-order 5. **COLII**.—Mouse-birds. First and fourth toes reversible. Ethiopian.
- Sub-order 6. **TROGONES**.—TROGONS. Heterodactyle, first and second toes directed forwards, third and fourth backwards. Tropical. *Trogon gallicus*, Miocene of France.

Sub-order 7. **PTCI.**—Zygodactylous. Tendon of the flexor hallucis longus muscle sending a strong vinculum to that of the flexor profundus muscle, the tendon of which goes to the third toe only. *Gulbulidae*, puff-birds and jacamars, neotropical. *Caprimidae*, barbets, tropical. *Rhamphastidae*, toucans, neotropical. *Picidae*, woodpeckers, cosmopolitan, excepting Madagascar and Australian region.

14. Order **Passeriformes.**—Nidicolous. Aegithognathous, without basipterygoid processes. Spina externa sterni large, spina interna absent. Quinto-cubital, toes normal. Apparently since the upper Eocene.

Sub-order 1. **PASSERES ANISOMYODAE.**—Syrinx muscles entirely laterally or attached to the dorsal or ventral corners of the bronchial semi-rings. (1) *Subclamatores*. Deep plantar tendons connected by a vinculum. *Eurylaemidae*, broad-bills, Indian and Indo-Malayan. (2) *Clamatores*. Deep flexor tendons not connected. *Pittidae*, palaeotropical. *Xenicidae*, New Zealand. *Tyrannidae*, American, *Formicariidae*, *Pteroplocheidae*, neotropical.

Sub-order 2. **PASSERES DIACROMYODAE.**—Syrinx muscles of either side attached to the dorsal and ventral corners of the rings. Hallux strong, with a large claw. (1) *Suboscines* with *Menura*, lyre-bird, and *Archidia*, scrub-bird, in Australia. (2) *Oscines*, the true singing-birds, with more than 5000 recent species, are mostly divided into some thirty "families," few of which can be defined.

The fourteen orders of the *Carinatae* are further congregated into four "Legions":—

- I. **COLYMBOMORPHAE** = *Ichthyornithes* + *Colymbiformes* + *Sphenisciformes* + *Procellariiformes*.
- II. **PELAGOMORPHAE** = *Ciconiiformes* + *Anseriformes* + *Falconiformes*.
- III. **ALECTOROMORPHAE** = *Tinamiformes* + *Galliformes* + *Gruiformes* + *Charadriiformes*.
- IV. **CORACIOMORPHAE** = *Cuculiformes* + *Coraciiformes* + *Passeriformes*.

These four legions are again combined into two "Brigades," the first of which comprises the first and second legions, while the second brigade contains the third and fourth legions.

Thus the whole classification becomes a rounded-off phylogenetic system, which, at least in its broad outlines, seems to approach the natural system, the ideal goal of the scientific ornithologist. The main branches of the resultant "tree" may be rendered as follows:—

CORACIOMORPHAE

+

ODONTOLABE. COLYMBO + PELAGO- ALECTOROMORPHAE. RATITAE
MORPHAE PELAGHAE

NEORNITHES

The *Odontolabae* seem to be an early specialized offshoot of the *Colymbo-Pelagomorphous* brigade, while the *Ratitae* represent a number of side branches of early *Alectoromorphae*. The *Ratitae* branched off, probably during the Eocene period, from that still indifferently stock which gave rise to the *Tinami*-*Galli*-*Gruiformes*, when the members of this stock were still in possession of those archaic characters which distinguish *Ratitae* from *Carinatae*. It follows that new groups of *Ratitae* can no longer be developed since there are no *Carinatae* living which still retain so many low characters, e.g. configuration of the palate, precracoid, pelvis, intestinal convolutions, copulatory organ, &c. Loss of the keel is co-ordinated with the power of using the forelimbs for locomotion; although a "Ratitae" character, it is not sufficient to turn a *Notornis*, *Cnemidornis* or *Stringops*, not even a *Phororhacox* into a member of the *Ratitae*.

Another branch of the *Alectoromorphae*, in particular of the *Galliformes*, when these were still scarcely separated from the *Gruiformes*, especially rail-like birds, leads through *Opisthocomi* to the *Cuculiformes*. These are, again in an ascending direction, connected with the *Coraciiformes*, out of which have arisen the *Passeriformes*, and these have blossomed into the *Oscines*, which, as the apotheosis of bird life, have conquered the whole inhabitable world. (H. F. G.)

BIRD-LOUSE, any small flat degenerate wingless neuropterous insect of the group *Mallophaga*, parasitic upon birds and mammals and feeding upon dermal excretions or upon the softer parts of hair and feathers. The term "biting-lice" is sometimes given to these parasites, in allusion to the mandibulate character of their mouth-parts, which serves to distinguish them at once from the true lice of the order *Rhynchota* in which the jaws are haustellate.

BIRD'S-EYE, a name applied to various small bright flowers, especially those which have a small spot or "eye" in the centre. The primula is thus spoken of, on account of its yellow centre,

also the adonis, or "pheasant's eye," and the blue veronica, or germander speedwell. The word is also applied to a sort of tobacco, in which the stalks (of a mottled colour) are cut up together with the leaves. From a similar sense comes the phrase "bird's-eye maple," a speckled variety of maple-wood, or the "bird's-eye handkerchief" mentioned in Thackeray's novels.

BIRD-NESTING, a general term for the pursuit of collecting and preserving birds' eggs, with or without the nests themselves. The nests and eggs of wild birds are now-days protected by local laws almost everywhere in both Great Britain and the United States. By law they may be taken for scientific purposes only, by special licence. In order not to interfere seriously with breeding it is customary to take but one egg from a nest, and, if the nest itself be taken, to wait until the young birds have left it. Every egg, unless "hard-set," should be blown as soon as removed from the nest. This is done by opening a small hole in its side by means of a drill with a conical head, manufactured for the purpose, a minute hole for the insertion of the drill-head having first been made in the shell with a needle, which is then used to stir up the contents, so that they shall flow easily. A blow-pipe with a curved mouth is then inserted, the egg is held hole downwards, and the contents blown out. The old-fashioned method of making two holes in the egg is thus superseded. Should the egg be "hard-set" a somewhat larger hole is made and its edges reinforced with layers of paper pasted round them. Minute forceps are then introduced and the embryo cut into pieces small enough to pass through the hole. The inside of the egg is then rinsed out with clean water, and also before being placed in the cabinet, with a solution of corrosive sublimate, which prevents decay and consequent discoloration of the inner membrane. Finally the egg is placed with the hole downwards upon a sheet of white blotting-paper to dry. The authentication of the eggs is the most important duty of an egg-collector, next to identifying the specimens. According to some the best method is to mark with a fine pen on the egg itself the variety, scientific name, locality of nest, date of taking and the initials of the collector, as well as a reference to his note-book or catalogue. Others advocate keeping the authentication separate with only a numbered reference on the egg itself. Eggs should not be transported in bran or sawdust, but in strong wood-lined boxes. The best cabinets are fitted with drawers, pulled out to inspect the eggs, but at other times closed to preserve them from the light, which is injurious to their delicate colouring. When an entire nest is taken it should be disinfected with hypochlorite of soda or insect-powder.

See *Bird-nesting and Bird-Skinning*, by E. Newman (London, 1888); *The Young Collector's Handbook of British Birds' Nests and Eggs*, by W. H. Bath (London, 1888); *Birds' Nests, Eggs and Egg-Collecting*, by R. Kearton (London, 1890); *British Birds' Eggs and Nests*, by J. C. Atkinson (London, 1898); *Nests and Eggs of North American Birds*, by Ernest Ingersoll (1880-1881).

BIRDS OF PARADISE, a group of passerine birds inhabiting New Guinea and the adjacent islands, so named by the Dutch voyagers in allusion to the brilliancy of their plumage, and to the current belief that, possessing neither wings nor feet, they passed their lives in the air, sustained on their ample plumes, resting only at long intervals suspended from the branches of lofty trees by the wire-like feathers of the tail, and drawing their food "from the dews of heaven and the nectar of flowers." Such stories obtained credence from the fact that so late as the year 1760, when Linnaeus named the principal species *apoda*, or "footless," no perfect specimen had been seen in Europe, the natives who sold the skins to coast traders invariably depriving them of feet and wings. The birds now usually included under this name belong to the family *Paradisidae*, closely allied to the crows. The largest is the great emerald bird (*Paradisaea apoda*), about the size of the common jay. Its head and neck are covered with short thick-set feathers, resembling velvet pile, of a bright straw colour above, and a brilliant emerald green beneath. From under the shoulders on each side springs a dense tuft of golden-orange plumes, about 2 ft. in length, which the bird can raise at pleasure, so as to enclose the greater part of its body. The

two centre tail feathers attain a length of 34 in., and, being destitute of webs, have a thin wire-like appearance. This splendid plumage, however, belongs only to the adult males, the females being exceedingly plain birds of a nearly uniform dusky brown colour, and possessing neither plumes nor lengthened tail feathers. The young males at first resemble the females, and it is only after the fourth moulting, according to A. R. Wallace, who has studied those birds in their native haunts, that they assume the perfect plumage of their sex, which, however, they retain permanently afterwards, and not during the breeding season only as was formerly supposed. At that season the males assemble, in numbers varying from twelve to twenty, on certain trees, and there disport themselves, so as to display their magnificent plumes in presence of the females. Wallace in his *Malay Archipelago*, vol. ii., thus describes the attitude of the male birds at one of those "sacaleli," or dancing parties, as the natives call them; "their wings," he says, "are raised vertically over the back, the head is bent down and stretched out, and the long plumes are raised up and expanded till they form two magnificent golden fans striped with deep red at the base, and fading off into the pale brown tint of the finely-divided and softly-waving points; the whole bird is then overshadowed by them, the crouching body, yellow head, and emerald green

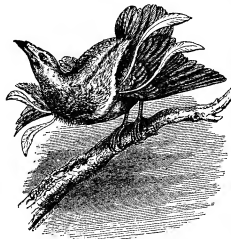

Standard Wing Bird of Paradise
(*Semioptera wallacei*).

throat, forming but the foundation and setting to the golden glory which waves above." It is at this season that those birds are chiefly captured. The bird-catcher having found a tree thus selected for a "dancing party," builds a hut among the lower branches in which to conceal himself. As soon as the male birds have begun their graceful antics, he shoots them,

one after the other, with blunt arrows, for the purpose of stunning and bringing them to the ground without drawing blood, which would injure their plumage; and so eager are those birds in their courtship that almost all the males are thus brought down before the danger is perceived. The natives in preparing the skins remove both feet and wings, so as to give more prominence to the commercially valuable tuft of plumes. They also remove the skull, and the skin is then dried in a smoky hut. The great emerald bird, so far as yet known, is only found in the Aru Islands. The lesser bird of paradise (*Paradisaea minor*), though smaller in size and somewhat less brilliant in plumage, in other respects closely resembles the preceding species. It is also more common, and much more widely distributed, being found throughout New Guinea and the neighbouring islands. Its plumes are those most generally used as ornaments for ladies' head-dresses. Both species are omnivorous, feeding voraciously on fruits and insects. They are strong, active birds, and are believed to be polygamous. The king bird of paradise (*Cicinnurus regius*) is one of the smallest and most brilliant of the group, and is specially distinguished by its two middle tail feathers, the ends of which alone are webbed, and coiled into a beautiful spiral disk of a lovely emerald green. In the red bird of paradise (*Paradisaea rubra*) the same feathers are greatly elongated and destitute of webs, but differ from those in the other species, in being flattened out like ribbons. They are only found in the small island of Waigiu off the coast of New Guinea. Of the long-billed paradise birds the most remarkable is that known

as the "twelve-wired" (*Seleucidés alba*), its delicate yellow plumes, twelve of which are transformed into wire-like bristles nearly a foot long, affording a striking contrast to the dark metallic tints of the rest of its plumage. (A. N.)

BIRDWOOD, SIR GEORGE CHRISTOPHER MOLESWORTH (1832—), Anglo-Indian official and writer, son of General Christopher Birdwood, was born at Belgium, in the Bombay presidency, on the 8th of December 1832. He was educated at Plymouth grammar-school and Edinburgh University, where he took his M.D. degree. Entering the Bombay Medical Service in 1854, he served in the Persian War of 1856-57, and subsequently became professor at the Grant Medical College, registrar of the university, curator of the museum, and sheriff at Bombay, besides acting as secretary of the Asiatic and Horticultural societies. His work on the *Economic Vegetable Products of the Bombay Presidency* reached its twelfth edition in 1868. He interested himself prominently also in the municipal life of the city, where he acquired great influence and popularity. He was obliged by ill-health in 1868 to return to England, where he entered the revenue and statistics department of the India Office (1871-1902). Whilst engaged there he published important volumes on the industrial arts of India, the ancient records of the India Office, and the first letter-book of the East India Company. He devoted much time and energy to the encouragement of Indian art, on various aspects of which he wrote valuable monographs, and his name was identified with the representation of India at all the principal international exhibitions from 1857 to 1901. (See *Journal of Indian Art*, vol. viii. "The Life and Work of Sir George Birdwood.") His researches on the subject of incense (*Trans. Linn. Soc. xxvii.*, 1871; *Ency. Brit.* 9th ed., "Incense," 1881; revised for the present edition by him), a good example of his mastery of detail, have made his historical and botanical account of this subject a classic. Nor can his lifelong association with journalism of the best sort be overlooked. From boyhood he was a diligent contributor of special information to magazines and newspapers; in India he helped to convert the *Standard* into the *Times of India*, and edited the *Bombay Saturday Review*; and after his return to London he wrote for the *Pall Mall*, *Athenaeum*, *Academy*, and *Times*; and with Chenery, the editor of *The Times*, and others he took the initiative (1882) in celebrating the anniversary of Lord Beaconsfield's death as "Primrose Day" (April 19). He kept up his connexion with India by constant contributions to the Indian press; and his long friendships with Indian princes and the leading educated native Indians made his intimate knowledge of the country of peculiar value in the handling of the problems of the Indian empire. In 1887 he was created a K.C.I.E.; and, besides being given his LL.D. degree by Cambridge, he was also made an officer of the Legion of Honour and a laureate of the French Academy.

BIREJIK (Arab. *Bir*; classical, *Apamea-Zeugma*), a town of North-West Mesopotamia, in the Aleppo vilayet, altitude 1170 ft., built on a limestone cliff 400 ft. high on the left bank of the Euphrates. Pop. about 10,000, three-quarters Moslem. It is situated at one of the most important crossings of the Euphrates, where there was, in ancient times, a bridge of boats, and is now a ferry on the road from Aleppo to Urfa, Diarbekr and Mosul. Birejik corresponds actually to Apamea, which lay opposite Zeugma, and commanded the bridge with its strong castle (Kala Beda) now much ruined. The place seems to have had a pre-Seleucid existence as *Birha*, a name which revived under Roman rule (we hear of the emperor Julian resting there on his march into Mesopotamia, A.D. 363), and is preserved to this day. The ferry over an unusually deep and narrow part of the Euphrates has been used from time immemorial in the passage from North Syria to Haran (Charræ), Edessa and North Mesopotamia, and was second in importance only to that at Thapsacus, by which crossed the route to Babylon and South Mesopotamia. Birejik was the scene of an unusually cruel massacre and persecution of Armenians in 1895.

BIREN (or **BÜREN**), **ERNST JOHANN** (1690-1772), duke of Courland, was the grandson of a groom in the service of Duke

Jacob III. of Courland, who bestowed upon him a small estate, which Biren's father inherited and where Biren himself was born. He received what little education he had at the academy of Königsberg, from which he was expelled for riotous conduct. In 1714 he set out to seek his fortune in Russia, and unsuccessfully solicited a place at the shabby court of the princess Sophia Charlotte, the consort of the tsarevich Alexius. Returning to Mittau, he succeeded in gaining a footing at court there through one of his sisters, who was the fancy of the ruling minister, Peter Bestuzhev, whose established mistress was no less a person than the young duchess Anne Ivanovna. During his patron's absence, Biren, a handsome, insinuating fellow, succeeded in supplanting him in the favour of Anne, and procuring the disgrace and banishment of Bestuzhev and his family. From henceforth to the end of her life Biren's influence over the duchess was paramount. On the elevation of Anne to the Russian throne in 1740, Biren, who had in the meantime married a Fräulein von Treiden, came to Moscow, and honours and riches were heaped upon him. At the coronation (19th May) he was made grand-chamberlain, a count of the empire, on which occasion he is said to have adopted the arms of the French ducal house of Biron, and was presented with an estate at Wenden with 50,000 crowns a year. He soon made himself cordially detested by Russians of every class. He was not indeed the monster of iniquity he is popularly supposed to have been. His vices were rather of the sordid than of the satanic order. He had insinuating manners and could make himself very agreeable if he chose; but he was mean, treacherous, rapacious, suspicious and horribly vindictive. During the latter years of Anne's reign, Biren increased enormously in power and riches. His apartments in the palace adjoined those of the empress, and his liveries, furnitures and equipages were scarcely less costly than hers. Half the bribes intended for the Russian court passed through his coffers. He had landed estates everywhere. A special department of state looked after his brood mares and stallions. The magnificence of his plate astonished the French ambassador, and the diamonds of his duchess were the envy of princesses. The climax of this wondrous elevation was reached when, on the extinction of the line of Kettler, the estates of Courland, in June 1737, elected him their reigning duke. He was almost as much loathed in Courland as in Russia; but the will of the empress was the law of the land, and large sums of money, smuggled into Courland in the shape of bills payable in Amsterdam to bearer, speedily convinced the electors. On her death-bed Anne, very unwillingly and only at his urgent entreaty, appointed him regent during the minority of the baby emperor, Ivan VI. Her common-sense told her that the only way she could save the man she loved from the vengeance of his enemies after her death was to facilitate in time his descent from his untenable position. Finally, on the 26th of October 1740, a so-called "positive declaration" signed by 104 dignitaries, in the name of the Russian nation, conferred the regency on Biren.

Biren's regency lasted exactly three weeks. At midnight of the 19th of November 1740 he was seized in his bedroom by his ancient rival, Field Marshal Münnich. The commission appointed to try his case condemned him (11th of April 1741) to death by quartering, but this sentence was commuted by the clemency of the new regent, Anna Leopoldovna, the mother of Ivan VI., to banishment for life at Pellin in Siberia. All Biren's vast property was confiscated, including his diamonds, worth £600,000. For twenty-two years the ex-regent disappeared from the high places of history. He re-emerges for a brief moment in 1762, when the philo-German Peter III. summoned him to court. He was now too old to be in any one's way, and that, no doubt, was the reason why Catherine II. re-established him (1763) in his duchy, which he bequeathed to his son Peter. Misfortune had chastened him, and the last years of his rule were just and even benevolent, if somewhat autocratic. He died at Mittau, his capital, on the 28th of December 1772.

See Robert Nisbet Bain, *The Pupils of Peter the Great* (London, 1897); Christoph Hermann von Manstein, *Memoirs* (Eng. ed.,

London, 1856); Claudius Rondeau, *Diplomatic Dispatches from Russia* (St Petersburg, 1889-1892). (R. N. B.)

BIRETTA (Ital. *berretta*, Med. Lat. *biretum*, *birettum*, dim. of *birrus*, "a hooded cloak"; from the Fr. form *barrette* is derived the Eng. "barret-cap"), a cap worn by the Catholic clergy. It is square and stiff, being made of a framework of cardboard covered with cloth or silk; on the top, along the sutures of the stuff, are three or four raised, board-like, arched ridges, at the junction of which in the centre is a knob or tassel (*fioccus*). Its colour varies with the rank of the wearer, that of the pope being white, of the cardinals red, of bishops purple, and of the lower clergy black. It is not in the strictest sense a liturgical head-dress, its use not being confined to liturgical functions. In these functions, moreover, its use is strictly limited; e.g. it is worn at low masses by the priest only when he goes to and from the altar, at high masses also when the celebrant sits during the singing of the *Kyrie*, *Gloria* and Creed, and at processions when these take place outside the church and are not sacramental, and so on.

Though the form of the biretta, devised in the 17th century, is peculiar to the Roman Church, it is but a variant of the original *biretum*, which developed in various countries into head-coverings of different shapes and significance. At the outset there was little to distinguish the *biretum* from the *pileus* or *pileolus* (skull-cap), a non-liturgical cap worn by dignitaries of the Church under the mitre and even under the biretta. When the word *biretum* first appears in the 13th century, it practically means no more than "cap," and is used as a synonym of *pileus*. As an ecclesiastical vestment the cap can be traced, under the name of *pileus*, to the 12th century; under that of *infula*, to the end of the 10th. It would seem to have been worn by the cantors as a protection against cold. The same utilitarian reason led to its introduction among the clergy generally. Thus in 1243 Pope Innocent IV. granted leave to the Benedictines of St Augustine's at Canterbury, and to those of Winchester, to wear the *pileus* in choir. With the extension of its use, too, the custom grew up (c. 1300) of investing clerks with the *biretum* as the symbol of the transfer of a benefice, a custom which survives, in Roman Catholic countries, in the solemn delivery of the red biretta by the head of the state to newly created cardinals, who afterwards go to Rome to receive the red hat. This red biretta is called the *zuchetto*.

This use of the *biretum* as a symbol of office or dignity was not confined to the clergy. With various modifications of form it was worn by all persons of standing, e.g. barons, judges, and doctors and masters of the universities. The *biretum* was also used in the investiture of laymen with office, e.g. a duke or the prefect of the city of Rome (Du Cange, *Gloss. s.v. birettum*). The "cap of maintenance" or "cap of estate," still borne before the British sovereign on state occasions, is a barret-cap of the type of the 14th and 15th centuries; it is of crimson velvet, turned up with ermine. By the 16th century the barret-cap had become the common head-gear of all people of substance, men and women. It was flat, square or round, sometimes with edges that could be turned up or down according to convenience, and was often elaborately decorated. By the 17th century it had given place in ordinary civil life to the brimmed hat; but in various shapes it still survives as official head-gear in many European countries: the *Barett*, worn in church by the Lutheran clergy, in the courts by German lawyers, and by the deans and rectors of the universities, the *barrette* of French judges and barristers, the "black cap" of the English judge, and the "college cap" familiar in English and American universities, and vulgarly known as the "mortar-board."

Meanwhile the ecclesiastical developments of the *biretum* are not without interest and significance. Originally this had been a round cap, low or moderately high, slightly bulging out at the top, and ornamented with a round knob. By the 16th century, both in England and on the continent, a tendency had begun to emphasize the ridges of the sutures and thus produce a square shape. Henceforth the evolution followed different lines. In England, in the 17th century, the square flat top began to be

enlarged, forming a rim of thick stuff projecting beyond the close-fitting cap. This was the "square cap" so virulently denounced by the Puritans as a symbol of High Church Erastianism. With the triumph of High Church principles at the Restoration it was natural that a loyal clergy should desire to emphasize this squareness, and the consequent exaggeration of the square top of the cap necessitated a further stiffening. In the 18th century, accordingly, the top began to be made of a board of wood or card covered with cloth, the close-fitting cap proper retired farther from the edges, the knob developed into a long tassel, and the evolution of the modern "college cap" was complete (see fig. 1).

On the continent, meanwhile, in the Roman Catholic Church, the *biretum* had also developed into its present characteristic

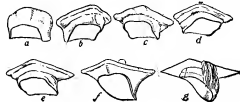

FIG. 1.

- a, *Pileus* of Archbishop Warham (d. 1532).
b, Square cap of Archbishop Cramer (d. 1556).
c, Square cap of Archbishop Parker (d. 1575).
d, Square cap of Archbishop Whitgift (d. 1583).
e, Square cap of Archbishop Laud (d. 1645).

All these are from portraits at Lambeth.
f, Square cap of George Morley, bishop of Winchester (d. 1684).
g, Modern college cap.

form, and by a very similar process. By the end of the 16th century the square shape was everywhere prevalent; at the beginning of the 17th century cardboard

was introduced to stiffen the sides and emphasize the squareness, and the actual form of the biretta, as described above, had become fixed (see fig. 2). Only in Spain has the biretta continued to be worn without the raised ridges.

The use of the Roman biretta has been introduced by a certain number of the clergy into the Anglican Church. It is clear that there is no historical justification for this; for though both college cap and biretta are developed from the same "square cap," the biretta in its actual shape is strictly associated with the post-Reformation Roman Church, and its actual ceremonial use is of late growth. Braun (*Liturgische Gewandung*, p. 513) thinks that the symbolism of the cross may have had some influence

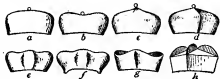

(Redrawn from Braun's *Liturgische Gewandung*.)

FIG. 2.—Illustrations of the *biretum* from monuments in the cathedrals of—

- a, Brandenburg (1281). e, Würzburg (1521).
b, Augsburg (1342). f, Regensburg (1564).
c, Bamberg (1483). g, ib. (1605).
d, Regensburg (1550). h, Bamberg (1626).

in fixing and propagating the square shape, and he quotes a decree of the synod of Aix (1585) ordering the clergy to wear a biretta sewn in the form of a cross (*biretta in modum crucis consutum, ut ecclesiasticos homines decet*). So far as the legality of the use of the biretta in the Church of England is concerned, this was pronounced by Sir R. Phillimore in the Court of Arches (*Elphinstone v. Purchas*, 1870) to be legal "as a protection to the head when needed," but this decision was reversed on appeal by the judicial committee of the privy council (*Hebbel v. Purchas*, 1871). Of late years the old square cap of soft padded cloth or velvet has been revived in the Anglican Church by some dignitaries.

See J. Braun, S. J., *Die liturgische Gewandung* (Freiburg i-B., 1907); *Hierurgia Anglicana*, part ii. (London, 1903); H. Druitt, *Costume on Brass* (London, 1906).

BIRGER (?-1266), Swedish statesman, nephew of Birger Brosa, and the most famous member of the ancient noble family of the Folkungätten, which had so much to say for itself in early Swedish history, was created jarl of Bjälbo by King Erik Eriksson in 1248 and married the king's sister. On Erik's death

(1250) Birger's son Valdemar was elected king while his father acted as regent. During the sixteen years of his sway Sweden advanced greatly in fame and prosperity. In 1249 he led an expedition to Finland, built the fortress of Tavastehus, and thus laid the foundations of Sweden's overseas empire. He also built Stockholm, and enriched it by making it the chief mart for the trade of Lübeck, with which city he concluded a commercial treaty. As a lawgiver also Birger laboured strenuously in the interests of civilization. In his old age he married the daughter of King Abel. There is a fine statue of the great jarl in the Riddarholm church at Stockholm, erected by Fogelberg at the expense of the Stockholm magistracy in 1884. He is also the central figure of Fr. Hedberg's drama *Bröllopet på Ulfåsa* (1865). See *Sveriges Historia*, vol. i. (Stockholm, 1879-1883).

BIRIBI, or CAVAGNOLE, a French game of chance, prohibited by law since 1837. It is played on a board on which the numbers 1 to 70 are marked. The players put their stakes on the numbers they wish to back. The banker is provided with a bag from which he draws a case containing a ticket, the tickets corresponding with the numbers on the board. The banker calls out the number, and the player who has backed it receives sixty-four times his stake; the other stakes go to the banker. In the French army "to be sent to Biribi" is a cant term for being sent to the disciplinary battalion in Algeria.

BIRJEND, the capital of Káin, a sub-province of Khorasan in Persia, in 32° 53' N. 59° 10' E., and at an elevation of 4550 ft. Pop. about 25,000. It is situated 328 m. from Meshed by the direct road, in a fertile valley running east and west, of which the southern boundary is a lofty range of barren hills known as Kuh i Bákeran. Through the valley runs the Khup river, which loses itself in the desert towards the west; it is, however, generally dry. The water-supply of the town and of the 70 or 80 villages under its jurisdiction is very scanty. On the east of the town at the foot of a hill stands a dilapidated fort. Birjend has six good caravanserais, a college and some mosques; post and telegraph offices were established there in 1902.

BIRKBECK, GEORGE (1776-1841), English physician and philanthropist, was born at Settle in Yorkshire on the 10th of January 1776. He early evinced a strong predilection for scientific pursuits; and in 1799, after graduating as doctor of medicine, he was appointed to the chair of natural philosophy at the Andersonian Institution of Glasgow. In the following year he delivered, for the benefit of the working-classes, a gratuitous course of scientific lectures, which were continued during the two following years and proved eminently successful. He removed to London in 1804, and there he endeavoured to prosecute his philanthropic schemes, at first without much encouragement, but ultimately with marked success. In 1823 he contributed to found the Mechanics' Institute, the name of which was afterwards changed to Birkbeck Institution or College, in honour of its founder. He was appointed director of the institute, which he had originally endowed with the sum of £3700, and held the office till his death on the 1st of December 1841. The sphere of usefulness of the institution was gradually enlarged, and an enlargement of the buildings was carried out in 1883-1885. The college now holds day and evening classes in many of the sciences, in literature, languages and art.

BIRKENFELD, a town of Germany, capital of the principality of the same name, on the Zimmerbach, 25 m. S.E. of Trier and on the main line of railway from Bingerbrück to Neunkirchen. Pop. 2500. Close by, on an eminence, lie the ruins of the castle of Birkenfeld, dating from the 14th century, once the residence of the counts palatine of Zweibrücken. The town has an Evangelical and a Roman Catholic church, a grand-ducal high school and a hospital. Besides brewing and tanning, its industries include the manufacture of tobacco and chicory. There is also a considerable trade in cattle.

The PRINCIPALITY OF BIRKENFELD is hilly and well-forested; agriculture prospers on the cleared lands, and fruit is grown in the valley of the Nahe, the principal stream. Ironstone and roofing slates are quarried, and there is some industry in agate-polishing and the manufacture of trinkets. The principality

has an area of 312 sq. m. and a population (1900) of 43,409, chiefly Protestants. It is formed out of the former lordships of Dachstuhl and Oberstein, of part of the ancient countship of Sponheim, and sections of the duchy of Jülich, which were granted to the grand-duke of Oldenburg by the congress of Vienna in 1815. It is entirely an *enclave* in Prussian territory, and though it is represented in the Oldenburg diet, it is governed by a separate *Regierungskollegium*, consisting of a president and two members, who are responsible to the Oldenburg ministry.

BIRKENHEAD, a municipal, county and parliamentary borough, and seaport of Cheshire, England, on the river Mersey, 105 m. N.W. of London. Pop. (1901) 110,915. It lies opposite Liverpool, on the east shore of the peninsula of Wirral, and is served by the Birkenhead (London & North-Western and Great Western joint) and the Wirral railways. It is wholly of modern growth, although the name of Byrkhed is traced to the forest which is believed to have extended between the mouths of the Dee and the Ribble in Lancashire. A Benedictine monastery was founded (c. 1150) by Hamon de Mascy, third baron of Dunham Massey, and dedicated to St Mary and St James. It drew its main revenues from tolls levied at the Mersey ferry; and its prior sat in the parliament of the Earls of Chester, enjoying all the dignities and privileges of a Palatinate baron. A fine crypt, along with remains of the prior's lodging, refectory and chapel, may still be viewed, as the priory was purchased by private subscription and handed over to the municipality in 1896.

The rise of Birkenhead, from a hamlet of some 50 inhabitants in 1818 to its present importance, was due in the first place to the foresight and enterprise of William Laird, who purchased in 1824 a few acres of land on the banks of a marshy stream, known as Wallasey Pool, which flowed into the Mersey about 2 m. west of the village. Among other engineers, Telford and Stephenson favoured the project of converting Wallasey Pool into a great basin for shipping; but, largely owing to the fears of Liverpool lest a formidable rival should thus be created, it was not until 1843 that parliamentary powers were obtained, and the work entrusted to James Rendel, who finished it in less than five years. The docks, which covered an area of 7 acres, were opened in 1847, and after thrice changing hands were made over in 1858 to the Mersey Docks and Harbour Board, a body created by act of 1857, to control the harbourage on both sides of the river.

Meanwhile, the town itself grew rapidly. In 1833 an act was passed for paving, watching, cleansing and improving the streets; as well as for the regulation of police, and the establishment of a market. The Improvement Commissioners constituted by this act included the mayor, bailiffs and four aldermen of Liverpool, under whose care the main streets were laid out on a regular plan, intersecting one another at right angles; and the first iron tramway in England was laid down. Electricity was subsequently applied to the tramway system. Noteworthy public buildings are St Aidan's College, a large brick building in Tudor style, for the use of Anglican students in theology; the market hall (1845); town hall, a free library with branches, borough hospital, built at the cost of Sir John Laird; and many schools both public and private, including the industrial schools built as a memorial to Albert, prince consort, at the cost of Sir W. Jackson, and the school of art, given by Sir John Laird. There are many handsome modern churches, all built since 1821. Roman Catholics are especially numerous, owing to the presence of a large Irish population. The town is well furnished with open spaces. Birkenhead Park was opened in 1847, Mersey Park in 1885; while a tract of moorland 6 m. distant in the township of Thurston, was allotted to the borough of Birkenhead in 1887; and Meols Common, comprising over 50 acres of pastureland on the shores of Liverpool Bay, was made over to the corporation in 1900.

The increase of railway accommodation has been swift. In 1878 the old Monks Ferry station on the Great Western system was superseded by the opening of the Woodside passenger station, and a few years later the Birkenhead town station was

opened. In 1886 the Mersey tunnel, connecting Birkenhead with Liverpool, was opened by the prince of Wales. The system extends from Rock Ferry and Park stations on the Cheshire side to the low-level at Central Station in Liverpool, and has connexions on the Cheshire side with the Great Western, North-Western, Wirral and various local lines. The Wrexham, Mold & Connah's Quay railway, which was taken over by the Great Central company in 1905, helped to bring the mineral wealth of Flint and North Wales generally into the Birkenhead docks.

Woodside Ferry may still be regarded as the principal entrance to Birkenhead and the Wirral from Liverpool. The exclusive right of ferryage was granted to the priory in 1332. In 1842 the Birkenhead Commissioners purchased it, under an act of parliament, from the lord of the manor, Mr F. R. Price. In 1897 the corporation further acquired the rights over the Rock Ferry and the New Ferry at the southern end of the town. Despite competition from the Mersey tunnel, these ferries continue to transport millions of passengers annually, and have a considerable share in the heavy goods traffic.

Though at the outset a mere commercial offshoot of Liverpool, Birkenhead has acquired a large export trade in coal and manufactured articles, importing guano, grain and cattle in return. Iron foundries, breweries, oil-cake and seed mills also exist side by side with such immense engineering and shipbuilding works as the Britannia Works, Canada Works, and, above all, Laird's shipbuilding works, where several early iron vessels were built, and many cruisers and battleships have been launched. Huge warehouses and sheds have been erected along the quays for the storage of freight. In 1847 the Birkenhead Dock Warehousing Company opened its first warehouse, capable of holding 80,000 tons of goods. A line called the Dock Extension railway was carried round the whole, and the company erected, for their workmen, the Dock Cottages. This entire property is now under the authority of the Mersey Docks and Harbour Board. The pile of buildings known as the corn warehouses are traversed by a canal which gives access to its several departments, and are provided with mechanical grain-elevators. There are also extensive lairages for live-stock, and cold storage for dead meat. On the north and north-east, and partly on the east, Birkenhead is bounded by its docks, which extend, for a distance exceeding 2 m., from the landing-stage at Woodside Ferry to the Wallasey Bridge. Of these the principal are the Egerton, Morpeth, Morpeth Branch and Wallasey Docks; while the Alfred Dock, with its three entrances, nineteen pairs of lock-gates, 8 acres of water, and 460 lin. yds. of quay-space, fulfils the part of an entrance-lock to the whole system. The great Float, now occupying the site of Wallasey Pool, separates Birkenhead from Poulton-cum-Seacombe in the parish of Wallasey. It forms an immense dock of 120 acres, with a quay-space of about 5 m.; and communicates on the E. with a low-water basin of about 14 acres and with the Alfred Dock; on the S.E. with the Morpeth, Morpeth Branch and Egerton Docks. The Morpeth Dock (about 11 acres, quay-space 1299 lin. yds.) is in communication with the Morpeth Branch Dock (about 3½ acres, quay-space 600 lin. yds.); both being set apart for the use of steamers. The total water-space of these docks amounts to 165 acres, and the lineal quay-space is about 9½ m. The entrances to the Birkenhead Docks are capable of docking the largest class of steamers afloat. The massive iron bridges across the dock entrances are opened and closed by hydraulic power, which is likewise applied to the cranes, coal-hoists, warehouse-lifts and other machinery about the docks. At the extreme western end of the West Float are three large graving docks, two about 750 ft. in length, and 130 and 80 ft. respectively in width; while the largest measures about 900 ft. in length and 130 ft. in width.

In 1861 Birkenhead was created a parliamentary borough, returning one member. In 1877 it received a municipal charter, the boundaries of the borough including the suburban townships of Tranmere, Claughton, Oxton and part of Higher Bebington. The borough is under a mayor, 14 aldermen and 42 councillors. Area, 3848 acres.

BIRMINGHAM, a city and the county-seat of Jefferson county, Alabama, U.S.A., in the north-central part of the state, 96 m. N.W. of Montgomery, at an altitude of 600 ft. It is served by the Southern, the Louisville & Nashville, the Seaboard Air Line, the Central of Georgia, the Alabama Great Southern (of the Queen & Crescent Route), the Illinois Central, the Atlanta, Birmingham & Atlantic, the Birmingham Southern (for freight only), and the Kansas City, Memphis & Birmingham (Frisco system) railways. Pop. (1890) 26,778; (1900) 38,415, of whom 16,575 were of negro descent, and 1,776 were foreign-born; (1910) 132,685. Birmingham is situated in Jones Valley, between two mountains which lie south-east and north-west of the city. Its streets are wide and well constructed, and there are sixteen public parks, three of which, East Lake, Lakeview and Capitol, are particularly attractive. Among the principal buildings are the First National bank, the immense Union station and the Saint Vincent hospital; besides several fine office and school buildings (including the beautiful manual training high school) and churches. Although the state constitution restricts municipal investments, a Waring or "Separate" sewage system has been established. The most important educational institutions are the Birmingham medical college and college of pharmacy; the Birmingham dental college; a school of art and a conservatory of music. At East Lake station, in the north-east of the city, is Howard College (Baptist; founded at Marion, Perry county, in 1841 as an academy; granted first collegiate degrees in 1848; opened in East Lake in 1887); and 2 m. west of the city is the North Alabama Conference College (Methodist Episcopal South), opened in 1897.

Birmingham, situated in an immensely rich iron, coal and limestone region, is the principal manufacturing centre in the state, and the most important centre for the production and manufacture of iron in the southern states. In the decade 1890-1900 the value of the products of Birmingham's manufactures increased 78.9% from \$7,064,248 to \$12,581,066; in 1900 establishments under the "factory system" produced goods valued at \$8,599,418, in 1905 at \$7,592,958, a decrease of 11.7%.

Immediately outside the city limits in 1905 there were many large manufactories, including the repair shops of the Southern railroad; iron and steel, car wheels and cotton-oil were among the products of the suburban factories. In Jefferson county there were in 1900 more than 300 mining and manufacturing establishments, engaged, chiefly, in the production of iron, coal and coke, and a majority of these are in Birmingham and its suburban towns. A short distance south of the city is Red Mountain, 25 m. long and about 225 ft. high, rich in hematite iron ore; valuable limestone deposits are found some 30 m. distant, and in the vicinity are three great coalfields, the Warrior, the Coosa and the Cahaba. These natural advantages make possible the production of pig iron at an unusually low cost. In 1900 the Birmingham district produced six-sevenths of the total pig iron exported from the United States, and in 1902 nine-tenths of Alabama's coal, coke and pig iron; in 1905 Jefferson county produced 67.5% of the total iron and steel product of the state, and 62.5% of the pig iron produced by the state. The first steel plant in the southern states was established at Birmingham in 1897; in 1902, at Ensley, one of the suburbs, there were 10 furnaces controlled by one company. The city has also a large trade in cotton, the annual receipts averaging about 100,000 bales. Among the manufactures are cotton goods, cotton-seed oil, yarn, furniture and machinery. Birmingham also has important lumber interests.

The city is a product of the industrial transformation in the southern states since the Civil War. In 1870 the site was a cotton field, where two railways, the South & North, and the Alabama & Chattanooga, now part respectively of the Louisville & Nashville and the Southern System, met, 2 m. from Elyton. In 1871 a land company, promoted by railway officials, founded Birmingham. Within four months the population was 1200; by 1873 it was 2500; in 1880 it was 3086; and in 1890 it had reached 26,178.

BIRMINGHAM, a city and a municipal, county, and parliamentary borough, the metropolis of one of the greatest industrial districts in England. Pop. (1901) 522,204. It lies in the north-west of Warwickshire, but its suburbs extend into Staffordshire on the north and west, and into Worcestershire on the south. It is 113 m. north-west from London by the London & North-Western railway, lying on the loop line between Rugby and Stafford; it is also served by the northern line of the Great Western, and by the north and west (Derby-Bristol) line of the Midland railway.

Site.—Birmingham, built upon the New Red Sandstone, is situated in the valleys of the Rea and other small feeders of the river Tame, near their sources, and upon the rising ground between these valleys. The site is, therefore, boldly undulating, varying from 200 to 600 ft. above sea-level, steadily rising towards the north and west, while the well-marked line of the Lickey hills skirts the site on the south-west, extending thence south-eastward. From the high ground to the south-east Birmingham thus presents the appearance of a vast semicircular amphitheatre, the masses of houses broken by innumerable factory-chimneys; the whole scene conveying a remarkable impression of a community of untiring industrial activity. The area of the town is nearly 20 sq. m., the greatest length from north to south 7 m., and the greatest breadth about 4 m. Yet Birmingham is a fraction only of an industrial district, of which it forms the south-eastern extremity, which itself resembles one vast city, and embraces such famous manufacturing towns as Dudley, Wolverhampton, Walsall, Wednesbury and many others. This is the district commonly known as the "Black Country," which forms part of the South Staffordshire industrial district. Birmingham, however, does not lie actually within the "Black Country" properly so-called.

Streets and Buildings.—The plan of the town, as dictated by the site, is irregular; the streets are mostly winding, and often somewhat narrow. In the centre are several fine thoroughfares, containing nearly all the most important buildings. New Street, Corporation Street and Colmore Row are the chief of these. At the western end of New Street is a fine group of buildings, including the council house and art gallery, the town hall and post office. The council house and art gallery, begun in 1874 and completed in 1881, is in Renaissance style, and the material is Darley Dale, Spinkwell and Wrexham stone. The entrance is surmounted with a pediment filled with groups of excellent sculpture. The erection of that part which forms the art gallery was the work of the gas committee, to whom the council granted the site on condition that they would build such a gallery over their own office, the council having no powers at the time to raise the required funds. The art gallery contains a fine collection of modern paintings, including masterpieces of David Cox, Millais, Hunt, Henry Moore, Albert Moore, Briton-Riviere and Burne-Jones. In the industrial hall are rich stores of Oriental metal work, Limoges enamel, English and foreign glass and Japanese ceramics. In the side galleries are various textiles, and Persian, Rhodian, Grès de Flandres and other pottery. There is a remarkable collection of Wedgwood. Notable also is the collection of arms, which is probably the most complete in existence. The purchase of pictures has been made from time to time by means of an art gallery purchase fund of £12,000, privately contributed and placed under the control of the corporation. Many valuable works of art are the gift of individuals. In 1906 plans were obtained for additional municipal offices and another art gallery on a site on the opposite side of Edmund Street from the council house. The town hall, completed in 1850, is severely classic, modelled upon a Greek temple. The lower stage consists of a plinth or basement, 23 ft. high, upon which is reared a façade of peripteral character, with eight Corinthian columns (36 ft. high) at the two principal fronts, and thirteen columns on each side. These columns (imitated from those of the temple of Jupiter Stator at Rome) support a bold and enriched cornice, finished at each end with a lofty pediment and entablature. The exterior of the hall is built of Anglesea marble. The interior consists chiefly of a regularly-built room,

designed specially for meetings and concerts, with an orchestra containing a fine organ. The hall seats upwards of 2000 persons, but when cleared of benches, as is the case at great political meetings, over 5000 may find standing room. The Midland Institute, adjacent to the town hall on the west, has a fine lecture theatre. To the south lie the post office, the inland revenue office and Queen's College. To the north is the Gothic building of Mason College, an institution merged in the university. The Central free library, adjoining the Midland Institute, was rebuilt in 1879, after a fire which destroyed the fine Shakespeare library, the Cervantes collection, and a large series of books on, and antiquities of, Warwickshire, known as the Staunton collection. The Shakespeare series was as far as possible replaced, and the whole forms one of the largest reference and lending libraries in England. Edmund Street and Colmore Row are fine thoroughfares running parallel in a north-easterly direction from either side of the council house; in the first the principal building is the school of art, in the second are several noteworthy private buildings. Both terminate at Snow Hill station, that of the Great Western railway. New Street station, that of the London & North Western and Midland railways, lies close to the street of that name, fronted by the Queen's hotel. The station is nearly a quarter of a mile in length. The roof of the older portion consists of a vast arch of glass and iron, carried on pillars on each side, and measuring 1100 ft. in length, 80 ft. in height, and 212 ft. in width in a single span. The building of the Royal Society of Artists fronts New Street itself with a fine classic portico; here are also the exchange (Gothic) and the grammar school of King Edward VI., a Perpendicular building dating from 1840, designed by Sir Charles Barry. Corporation Street was the outcome of a great "Improvement scheme" initiated in 1875, with the object of clearing away a mass of insanitary property from the centre of the town and of constructing a main thoroughfare from the centre to the north-eastern outlet, starting from New Street, near the railway station to Bull Street, and thence continuing to the Aston Road. The scheme received parliamentary sanction in 1876, and was finished in 1882 at a cost of £1,520,657. This led to an almost total extinction of the residential quarter in the centre of the town. The finest building in this handsome street is the Victoria assize courts. The foundation stone was laid by Queen Victoria in 1887, after Birmingham had been created an assize district; the building was completed in 1891. There is a handsome entrance, and within is a great hall, 80 ft. by 40, with a series of stained-glass windows. The exterior is red, and highly ornamented in the style of the Renaissance.

Among other noteworthy buildings are the county court, education offices and military drill hall. Among a fine series of statues and monuments may be mentioned the statue of Nelson by Richard Westmacott, in the Bull Ring; those of Joseph Sturge, at the Five Ways, and of Thomas Attwood, the founder of the Political Union, in Stephenson Place, both by J. E. Thomas; James Watt, a singularly beautiful work, in Ratcliff Place, by Alexander Munro; Sir Robert Peel, in New Street, by Peter Hollins; Albert, prince consort, in the council house, by J. H. Foley; and Queen Victoria, by Thomas Woolner; Sir Rowland Hill, in the hall of the post office, by Matthew Noble; and Dr Priestley, in New Street, by F. J. Williamson. There is also a fountain behind the town hall, commemorative of the mayoralty of Mr Joseph Chamberlain, and flanked by statues of Sir Josiah Mason, and George Dawson, who took active part in the municipal reform movement previous to Mr Chamberlain's years of office. Sir Francis Chantrey's famous statue of James Watt is in a special chapel at Handsworth church.

Suburbs.—The principal streets radiating from central Birmingham to the suburbs are served by electric tramways worked by the corporation, and also by motor omnibuses. The principal suburbs are as follows. Edgbaston and Harborne lie south-west of the centre of the city, being approached by Broad Street. These form a residential district principally inhabited by the richer classes, and owing to the enforcement

of strict rules by the ground landlord, retain a remarkable semi-rural character, almost every house having a garden. Here, moreover, are Calthorpe Park, the botanical gardens, and the large private grounds attached to Edgbaston Hall, also the Warwickshire county cricket ground. To the south of Edgbaston, however, are the growing manufacturing districts of Selly Oak and Bourneville, and south of these, Northfield and King's Norton, in Worcestershire. The districts to the east of central Birmingham are Balsall Heath, Sparkbrook, Small Heath and Salfley. On the south-east is the residential suburb of Moseley, and on the east that of Yardley. Between Moseley and King's Heath to the south, is Highbury, the seat of Mr Joseph Chamberlain, whose active interest in the affairs of the town, both during his mayoralty (1873-1876) and at other times, was a principal factor in such works as the municipalization of the gas and water supply, the Corporation Street improvement, and the foundation of Birmingham University. On the east side the transition from town to country is clearly marked. This, however, is not the case on the west side, where the borough of Smethwick adjoins Birmingham, and the roads through West Bromwich and towards Oldbury and Dudley have the character of continuous streets. On this side are Soho and Handsworth, which gives name to a parliamentary division of Staffordshire. To the north lies Aston Manor, a municipal borough of itself, with Perry Bar beyond. To the north-east a populous district extends towards the town of Sutton Coldfield. Aston Hall is a fine Jacobean mansion standing in an extensive park. Aston Lower Grounds is an adjacent pleasure-ground. Besides these and the Edgbaston grounds the chief parks are Summersfield Park, towards Smethwick; Soho Park; Victoria Park, Handsworth; Adderley Park, towards Salfley; and Victoria Park, Small Heath. There is a race-course at Castle Bromwich, 3 m. east of the town.

Churches and Religion.—Birmingham is not rich in ecclesiastical architecture. It became a bishopric under the Bishops of Southwark and Birmingham Act 1904, including the archdeaconry of Birmingham and the rural deanery of Handsworth, previously in the diocese of Worcester. Before 1821 it was in the diocese of Lichfield. There were formerly a religious house, the priory of St Thomas the Apostle, and a Guild of the Holy Cross, an association partly religious and partly charitable, having a chantry in the parish church. The possessions of the priory went to the crown at the dissolution, and the building was destroyed before the close of the 16th century. The lands of the Guild of the Holy Cross were granted by Edward VI. to trustees for the support of the free grammar school. Until 1715 there was but one parish church, St Martin's, a rectory, having the tithes of the entire parish of Birmingham. St Martin's was erected about the middle of the 13th century, but in the course of ages was so disfigured, internally and externally, as to present no traces, except in the tower and spire, of its former character. In 1853 the tower was found to be in a dangerous condition, and together with the spire was rebuilt. In 1873 the remaining part of the old church was removed without disturbing the monuments, and a larger edifice was erected in its place. St. Philip's, a stately Italian structure, designed by Archer, a pupil of Wren, was the next church erected. It was consecrated in 1715, enlarged in 1884, and became the pro-cathedral on the foundation of the diocese. It contains a rich series of stained-glass windows by Burne-Jones. Then followed St Bartholomew's in 1749, St Mary's in 1774, St Paul's in 1779, St James's, Ashted, in 1791, and others. St Alban's is a good example of J. L. Pearson's work, and Edgbaston church is a picturesque Perpendicular structure.

Under the Commonwealth Birmingham was a stronghold of Puritanism. Clarendon speaks of it and the neighbourhood as "the most eminently corrupted of any in England." Baxter, on the other hand, commending the garrison of Coventry, says it contained "the most religious men of the parts round about, especially from Birmingham." The traditional reputation for Nonconformity is maintained by the town, all varieties of dissenters being numerous and influential. The Unitarians, the

oldest body established here, have among their chapels a handsome structure in Bristol Road, the Old Meeting, which in 1885 replaced the building in which the congregation was formed on the Presbyterian model by a number of ministers ejected under the Act of Uniformity. Another chapel, the New Meeting, in Moor Street, is memorable as having been the place of Dr Joseph Priestley's ministerial labours from 1780 onwards. In 1862 the Unitarians removed from this place to a new Gothic edifice, called the church of the Messiah, in Broad Street, where they preserve a monument of Priestley, with a medallion portrait in profile, and an inscription written by Priestley's friend, Dr Parr. The first meeting-house of the Society of Friends dates from about 1690. Among Independent chapels, that of Carr's Lane had John Angell James and Robert William Dale as ministers. The Baptists first erected a chapel in Cannon Street in 1738. The Wesleyan Methodists were established in Birmingham by John Wesley himself in 1745, when he was roughly handled while preaching on Gosta Green. In 1903 a very fine central hall, with lofty tower, was opened by this body, in the style of the Renaissance, fronting upon Corporation, Ryder and Dalton streets. The Presbyterians have also places of worship, and the Jews have a synagogue. From the revolution of 1688 until 1789 the Roman Catholics had no place of worship here; but Birmingham is now a Roman Catholic bishopric. The cathedral of St Chad was built from the designs of A. W. Pugin. At Erdington, towards Sutton Coldfield, is a large Benedictine Abbey (1897) of the Beuron congregation, founded as a monastery in 1876; and in the vicinity, at Oscott, is St Mary's College, where the chapel is a fine example of Pugin's work. Cardinal Newman was superior of the Oratory of St Philip Neri from its foundation in 1851.

Administration.—The government of the town resided originally in the high and low bailiffs, both officers chosen at the court of the lord of the manor, and acting as his deputies. The system was a loose one, but by degrees it became somewhat organized, and crown writs were addressed to the bailiffs. In 1832, when the town was enfranchised, they were made the returning officers. About the beginning of the 19th century, however, a more regular system was instituted, by an act creating a body of street commissioners, who acted for the parish of Birmingham, the hamlets outside its boundaries having similar boards of their own. The annoyance and difficulty caused by these bodies, thirteen in number, led to a demand for the incorporation of Birmingham as a borough; and a charter was accordingly granted by the crown in 1838, vesting the general government in a mayor, sixteen aldermen and forty-seven councillors. The powers of this body were, however, unusually restricted, the other local governing bodies remaining in existence. It was not until 1851 that an act of parliament was obtained, abolishing all governing authorities excepting the town council, and transferring all powers to this body. Another local act was obtained in 1862, and in 1883 these various acts were combined into the Birmingham Corporation Consolidation Act. In 1889 Birmingham was created a city, and a grant made of an official coat of arms carrying supporters. The title of lord mayor was conferred on the chief magistrate in 1897. The city council consists of eighteen aldermen and fifty-four councillors, selected from eighteen wards; it is divided into seventeen committees, most of which consist of eight members. The corporation is the largest employer of labour in the borough, and is also a large landowner.

The gas, electric and water supplies are in its hands. The gas supply was taken over in 1875, and the electric in 1900 for £420,000. The local sources of water-supply are the rivers Bourne and Blythe, the Plant Brook and the Perry Stream, and eight deep wells. These works can provide 20 million gallons daily in dry weather. A large area outside the city boundaries is supplied, and in 1891, the demand having risen to nearly 17 millions a day, new sources had to be considered, and it was determined to seek an entirely new supply in Wales. By an act of 1892 power was given to acquire the watershed of the rivers Elan and Claerwen, tributaries of the Wye, lying west of Rhyader in Wales, and to construct the necessary works, the capital

authorized being £6,000,000. About £5,000,000 had been spent when, on the 21st of July 1904, King Edward VII. formally opened the supply. Two reservoirs on the river Elan, formed by masonry dams from 98 to 128 ft. above the river-bed, were then completed, the construction of the three planned on the Claerwen being deferred until necessity should arise. Nearly a mile below the confluence of the rivers the great Caban Coch dam, 122 ft. high, and the same in thickness at the base, and 600 ft. long at the top, holds up the water for over 4 m. in the Elan, and over 2 in the Claerwen, having a capacity of 1500 million gallons. A series of thirty filter beds is included in the original scheme; and the water travels 73.3 m. from the source to Birmingham by gravity alone with a fall of about 170 ft. The area of the gathering ground is 45,562 acres, the mean annual rainfall in the district being 63 in. The complete scheme provided water for fifty years in advance, and a maximum of 75 million gallons a day was taken into account, in addition to 27 million gallons for compensation water to the river. The part of the works opened in 1904 provided about 27 million gallons of supply daily to the city. The corporation is obliged by the act to supply towns within 15 m. of the line of the aqueduct. A village for the accommodation of workmen was established near the Caban Coch dam; and the corporation adopted a modified form of the Gothenburg system in respect of the supply of intoxicating liquors, permitting no publican to open a licensed house.

The administration of the poor-law is vested in a board of guardians of sixty members for the parish of Birmingham. The parish of Edgbaston (wholly within the borough) is in the poor-law union of King's Norton, and that part of the parish of Aston included in the borough is in the Aston Union. There are three workhouses—that for Birmingham parish, situated at Birmingham Heath, is capable of receiving over 2000 inmates. In 1882 a superintendent relieving officer was appointed, and a system of cross-visitation started for the purpose of checking abuses of outdoor relief. Workhouses, infirmaries and cottage homes are managed by the board, on which women first sat in 1880. The administration of justice was performed from 1838 to 1884 by a court of quarter sessions, with a recorder, and a court of petty sessions. In 1884 Birmingham was made an assize district of Warwickshire. In 1905 a special juvenile offenders' court was initiated. The borough gaol is at Winson Green towards Smethwick. The drainage system is managed by the Birmingham, Tame and Rea District drainage board, constituted in 1877, and consisting of members from the city council and from districts outside the municipal area.

Birmingham was enfranchised in 1832, when two representatives were assigned to it, and Thomas Attwood and Joshua Scholefield, leaders of the Political Union, were elected. In 1867 three members were assigned, and in 1885 the number was increased to seven, and a corresponding number of parliamentary divisions created, namely Bordesley, Central, East, Edgbaston, North, South and West. By the Provincial Local Government Board Act of 1891 four local board districts were added to the city of Birmingham for local government—Harborne (Staffordshire), Balsall Heath (Worcestershire), Saltley and the rural hamlet of Little Bromwich (Warwickshire). These districts were by the act declared to be in the county of Warwick, though still remaining in their respective counties for the exercise of freehold votes. By this act the boundaries of the city were made coterminous for parliamentary, municipal and school board purposes. The area is 12,639 acres.

The population of Birmingham in 1700 was about 15,000. In 1801 it was 73,000, and it increased rapidly through the century. In 1891 it was 478,113 and in 1901, 522,204.

Education.—The oldest educational institution is the grammar school of King Edward VI., founded in 1552 out of the lands of the Guild of the Holy Cross, then of the annual value of £21. The endowments now yield upwards of £37,000. The principal school included in the foundation is the boys' high school, held in the building in New Street. It has a classical and a modern side, and educates about 500 boys. Adjoining it, in a new building opened in 1896, is a large high school for girls, with 300

pupils. There are also on the foundation seven middle schools, called grammar schools, four for girls and three for boys, situated in different parts of the city, and containing about 1000 pupils altogether. The schools have numerous scholarships tenable at the schools as well as exhibitions to the universities and other places of higher education. Queen's College, founded in 1828 as a school of medicine, subsequently embraced other subjects, though in 1882 only the medical and theological departments were maintained. In 1882 a large part of the scientific teaching, hitherto done by special professors in Queen's College, was taken over by Mason College, and in 1892 the whole medical department was removed to the same institution under an order from the court of chancery. This change helped to advance the Birmingham medical school to a position of high repute. The theological students (Church of England) of Queen's College are few. The idea of developing Queen's College into a university had long existed. But it was destined to be realized in connexion with Mason College, founded by Sir Josiah Mason in 1870. Subsequent deeds (1874 and 1881) added Greek and Latin to the practical, mechanical and artistic curriculum of the original foundation, and provided that instruction may be given in all such other subjects as the trustees may from time to time judge necessary, while once in every fifteen years the provisions of the deed may be varied to meet changing needs—theology only being definitely excluded. In 1897 a new act was passed at the instance of the trustees, creating a court of 180 members, and removing the theological restriction. A measure of popular

Univer- sity.

control is given through the appointment by the city council of five out of the eleven trustees. In 1898 a public meeting carried a resolution in favour of creating a university. It was estimated that a quarter of a million was needed to endow and equip a university on the scale proposed. Including £50,000 offered by Mr Andrew Carnegie, an equal amount from an anonymous donor, and the rest from local subscribers, in the autumn of 1899, £325,000 had been subscribed, and the privy council was at once petitioned for a charter, which was granted. The draft provided for the incorporation of the university of Birmingham with faculties of science, arts, medicine and commerce, with power to grant degrees, and for its government by a court of governors (of which women may be members), a council and a senate. Mason College was merged in the university. The faculty of commerce constitutes a distinctive feature in the scheme of the university, the object being to bring its teaching into close touch with the industrial life of the city, the district and the kingdom. In 1905 Sir Edward Elgar (who resigned in 1908) became the first occupant of a chair of music, founded owing to the liberality of Mr Richard Peyton. From the same year great strides were made in the development of the scientific departments of the university. A site at Edgbaston was given by Lord Calthorpe, and the erection of a complete and costly set of buildings was undertaken.

The Municipal School of Art was formed by the transference to the corporation in 1885 of the then existing school of art and the society of arts, and by the erection of the building in Margaret Street, the site having already been given and a portion of the cost provided by private donors. There are one central school and two branch schools. Evening classes are also held in some of the provided schools. The Midland Institute, the building of which was founded in 1855, and enlarged subsequently, includes a general literary and an industrial department. A marked development took place in 1885, when, fresh room having been provided by the removal of the school of art hitherto held in the building, the industrial department was greatly enlarged, resulting in the creation of one of the best metallurgical schools in the kingdom. The Municipal Technical School was established in 1893 in the building of the Midland Institute, and in 1895 was housed in a fine building of its own, in Suffolk Street, whither the whole of the scientific teaching of the institute was transferred. It contains metallurgical and engineering workshops and laboratories, lecture theatres for the teaching of chemistry and physics, a women's department, and rooms for the teaching of machine drawing and building con-

struction. Among other educational foundations may be mentioned a number of industrial schools, reformatories and private schools of a good class.

The principal libraries are the Birmingham library, founded in 1708 by Dr Priestley, in a modern building, the Central free library, and other free libraries in different parts of the city, each with a lending department and a reading room.

Charities.—The general hospital, the foundation of Dr Ash, an eminent local physician, was opened in 1779. The old building was replaced in 1897 by a splendid new one in St Mary's Square, costing £206,000. The Queen's hospital, Bath Row, the other large hospital of the town, was founded in 1840 by W. Sands Cox, F.R.S., an eminent local surgeon, who also founded the Queen's College as a medical school. The general dispensary, the officers of which visit patients at their own homes, relieves about 8000 yearly. The children's hospital (free) established in 1864 by Dr Heslop, has two establishments—for out-patients (a handsome Gothic building) in Steelhouse Lane, and an in-patient department in Broad Street. There is also a women's hospital (free) for the special diseases of women; a lying-in charity; special hospitals for diseases of the eye, the ear, bodily deformities, and the teeth; and a homoeopathic hospital. The parish of Birmingham maintains a large infirmary at the workhouse (Birmingham Heath), and a dispensary for out-patients in Paradise Street. The majority of the hospitals and dispensaries are free. Nearly all these medical charities depend upon subscriptions, donations, legacies and income from invested property. There are two public organizations for aiding the charities, both of which were begun in Birmingham. One is a simultaneous collection in October in churches and chapels, on the Sunday called Hospital Sunday, established in 1859; the other is the Saturday Hospital collection, made by the work-people in March, which was established in 1873. A musical festival is held triennially in aid of the general hospital. There is a sanatorium at Blackwell, near the Lickey Hill, 10 m. south of Birmingham, common to all the hospitals. Amongst the non-medical charities the principal are the blind institution and the deaf and dumb asylum, both at Edgbaston; and Sir Josiah Mason's orphanage at Erdington. There are also in the town numerous almshouses for aged persons, the chief of which are Lench's Trust, the James Charities, and the Licensed Victuallers' asylum. Besides, the general benefit societies, such as the Oddfellows', Foresters', &c., which are strongly supported in Birmingham, the work-people have numerous clubs of a charitable kind, and there are several important local provident societies of a general character, with many thousand members.

Commerce.—From an early period Birmingham has been a seat of manufactures in metal. Hutton, the historian of the town, claims for it Saxon or even British antiquity in this respect, but without foundation. The first direct mention of Birmingham trades is to be found in Leland's *Itinerary* (1538). He writes—"I came through a pretty street as ever I entered into Birmingham town. This street, as I remember, is called Dirty [Deritend]. In it dwell smiths and cutlers. There be many smiths in the towne that use to make knives and all manner of cutlery tooles, and many lorimers that make bittes, and a great many naylors, so that a great part of the towne is maintained by smithes, who have their iron and sea-cole out of Staffordshire." The cutlers no longer exist, this trade having gone to Sheffield; but the smiths remain, and the heavier cutting tools are still largely made here. The wide importance of Birmingham as a centre of manufactures began towards the close of the 17th century, one great source of it being the absolute freedom of the town, there being no gilds, companies or restrictions of any kind; besides which the easy access to cheap coal and iron indirectly helped the development. It is remarkable that two important trades, now located elsewhere, were first established here. Steel was made in Birmingham until 1797, but then ceased to be so for about seventy years, when an experiment in steel-making was made by a single firm. Cotton-spinning was begun in Birmingham by John Wyatt, Lewis Paul and Thomas Warren as early as 1730; but the speculation was

abandoned before the end of the century. The great staple of Birmingham is metal-working in all its various forms. The chief variety is the brass-working trade. Iron-working, though largely carried on, is a much less important trade, works of this kind being chiefly established in the Staffordshire district. Jewelry, gold, silver and gilt come next to brass. The remarkable development of this branch of industry is demonstrated by the increase in the amount of gold and silver marked, as recorded by the Assay office—the figures of 48,123 oz. of gold and 84,323 oz. of silver in 1870 had been increased to 363,000 oz. of gold and nearly 3,000,000 oz. of silver by the end of the century. Then follow "small arms" of all kinds. Until 1906 a Royal Small Arms factory was maintained by the government at Sparkbrook, but it was then transferred to the Birmingham Small Arms Company, which had already extensive works in the district. Buttons, hooks and eyes, pins and other articles used for dress, constitute a large class of manufactures. Glass, especially table glass, is a renowned staple of the town. Screws, nails, &c., are made in enormous quantities; indeed, Birmingham has a monopoly of the English screw trade. Steel pens are also a speciality, the name best known in this connexion being that of Sir Josiah Mason. Electro-plating, first established in 1841 by the firm of Elkington, is one of the leading trades. Among other branches of manufacture are wire-drawing, bell founding, metal rolling, railway-carriage building (a large and important industry), the manufacture of cutting implements and tools of all kinds, die-sinking, papier-mâché making and a variety of others. In 1897 there was a sudden development of cycle manufacturing, followed in 1899 by an almost equally sudden collapse, but this industry is maintained and accompanied by the manufacture of motor cars, tyres and accessories, for which Birmingham is one of the principal centres in Great Britain.

Birmingham may claim as her own the perfection of the steam engine, through the genius of James Watt and the courage of Matthew Boulton. The memory of the great Soho factory is one of the most precious heritages of the town, and Watt's own private workshop continues just as he left it, with no single article disturbed, carefully preserved in the garret of his house at Heathfield. The mention of Watt and of Soho recalls the memories of distinguished inventors and others who have been connected with Birmingham. Here John Baskerville, the printer, carried on his work. An institution called the Lunar Society, which met each month about the time of full moon, brought together a brilliant company—Watt, Boulton, Joseph Priestley, Josiah Wedgwood, Erasmus Darwin, Samuel Parr, Dr William Withering, Richard Lovell Edgeworth, Sir Joseph Banks, Sir William Herschel, Dr Solander, John Roebuck, James Keir and many others. William Murdoch, the inventor of gas, was a Soho man, and first used his invention to light the Soho factory at the peace of Amiens in 1802. The series of inventors is continued by the names of Gillott, Elkington, Chance, Mason and others. Thomas Rickman, the reviver and historian of Gothic architecture, practised as an architect in Birmingham. William Hutton, the antiquary and historian, carried on his book-selling business here. Many of the best engravers were Birmingham men, notably James Tibbitts Willmore and John Pye, the special translators of Turner's marvellous creations. Attwood, Joseph Parkes, John Bright and Joseph Chamberlain speak for Birmingham in the region of politics and statesmanship.

One of the most marked features of social life in Birmingham is the fact that contrasts in the distribution of wealth are less strongly marked than in most other great cities. The distance between the poorest and the richest is bridged over by a larger number of intermediate gradations. Colossal fortunes are few; on the other hand there is a numerous class of rich men. These, however, for the greater part are actually engaged in trade or manufactures, and hold their place in local life rather on account of industry pursued than of wealth possessed. The number of the leisured class, enjoying large incomes without participating in any local industry, is relatively small, but is said to be on the increase. There are many manufacturing companies, but great private firms are also numerous. In regard to labour conditions,

the system of small masters holds its own in the manufactures of Birmingham, and shows no signs of extinction. One effect of this condition is that capital and labour are not brought into enmity, and consequently strikes and disputes are infrequent. As regards the condition of the working classes it may be noted that Birmingham was the birthplace of the freehold land and building societies, by which workmen are enabled on easy terms to acquire houses of their own. The risk of an overcrowded population is consequently minimized; the houses, moreover, are generally well situated as regards light and air, and many have small gardens. Among industrial communities where peculiar attention is paid to the housing of workmen and their families, that of Bourneville, occupied by the *employés* of Messrs Cadbury, chocolate manufacturers, is well known.

History.—Owing to its rapid expansion, and the consequent newness of most of the public and other buildings, Birmingham is often supposed to be a modern town. It was, however, in existence as a community in the Saxon period. Proof of this was given in 1309 by William de Bermingham, then lord of the manor, who shewed in a law-suit that his ancestors had a market in the place and levied tolls before the Conquest. Some authors have endeavoured to identify the town with the supposed Roman station called *Bremenium*, but this claim has long been abandoned as fabulous. A Roman road runs north and south across the site of the town, but no remains have been found other than a very few coins. The origin of the name is untraceable; the spelling itself has passed through about 100 different forms. Dugdale, the historian of Warwickshire, adopts *Bromwychem*, and regards it as of Saxon derivation. Hutton, the historian of Birmingham, has the fanciful etymology of *Brom* (broom), *wych* (a descent), and *ham* (a home), making together the home on the hill by the heath.

In *Domesday Book* Birmingham is rated at four miles of land with half a mile of woods, the whole valued at £203. Two hundred years later the family of de Bermingham, the owners of the place, come into sight, one of them, William, being killed at the battle of Evesham, in 1265, fighting with Simon de Montfort and the barons against Henry III. The son of this William afterwards took part in the French war, and was made prisoner; his father's estates, forfeited by treason, were restored to him. Thenceforward the family engaged in various local and other offices, but seemingly abstained from politics. They held the place until 1527, when Edward de Bermingham was deprived of his property by means of John Dudley, duke of Northumberland, who trumped up a pretended charge of riot and robbery against him and procured Birmingham for himself. On the attainder of Dudley the manor passed to the crown, and was granted to Thomas Marrow, of Berkswell, from whom by marriage and descent it went to Christopher Musgrave, and finally, as regards the only valuable part—the market tolls—by purchase to the town itself. In the Wars of the Roses it does not seem that Birmingham took any part; but energy revived in the Civil War under Charles I., when the town sided actively with the Parliamentarians. In 1642, when Charles was marching from Shrewsbury to relieve Banbury, the Birmingham people seized part of his baggage, including much plate, money and wine, which they sent to the Parliamentary garrison at Warwick. Before the battle of Edgehill Charles rested for two nights at Aston Hall, near the town, as the guest of Sir Thomas Holte. The Birmingham people resented this by helping the Parliamentarians to cannonade the Hall and to levy a fine upon Sir Thomas Holte. They also supplied the Parliamentary army with 15,000 sword blades, refusing to make a single blade for the Royalists. These manifestations of hostility were avenged in April 1643 by Prince Rupert, who, with 2000 men and several pieces of artillery, attacked the town, planting his cannon on an eminence near Sparkbrook, still known as *Camp Hill*. The townspeople resisted, but were beaten, many persons being killed or wounded. Amongst the former was Lord Denbigh, one of the Royalist officers. Having captured the place, Prince Rupert allowed his troops to plunder it, to burn about eighty houses and to set their prisoners to ransom. He also levied a fine of £50,000,

equal to at least £100,000 of the present value of money. This bitter lesson kept Birmingham quiet during the rest of the Civil War, though the sympathies of the people with the Parliamentarians were unabated. In 1665 Birmingham suffered heavy losses by the plague, great numbers of dead being buried in the Pest Field, at Ladywood, then a lonely place far outside the town, but long since thickly covered with buildings. In 1688 the Revolution provoked a temporary outbreak of Protestant feeling. James II. had given timber from the royal forest of Needwood, near Burton, to build a Roman Catholic chapel and convent in a place still called Mass-house Lane. This edifice the mob promptly destroyed when James gave quiet to William and Mary. Rather more than a century of quiet prosperity ensued, and then occurred the serious and most lamentable outbreak of popular fury known as the Church and King riots of 1791. For some years there had been much political activity in Birmingham, the dissenters, particularly the Unitarians, being desirous of relief from the political and religious disabilities under which they laboured. The leader in these movements was the famous Dr Priestley, who kept up an active controversy with the local clergy and others, and thus drew upon himself and his co-religionists the hatred of the more violent members of the Church and Tory party. The smouldering fire broke out on the occasion of the French Revolution. On the 14th of July a dinner of Birmingham Liberals was held at the Royal hotel to celebrate the destruction of the Bastille. This was the signal of a popular outbreak. A Church and King mob, encouraged and organized by leaders of better station, who were too cowardly to show themselves, began an attack upon the Unitarians. Priestley was not present at the dinner, but his house at Fair Hill, Sparkbrook, was one of the first to be sacked and burnt—his library and laboratory, with all his manuscripts, and the records of life-long scientific and philosophical inquiries, perishing in the flames. The house and library of Hutton the historian were also destroyed. The Unitarian chapel was burnt, and several houses belonging to members of the sect were sacked and burnt. The riot continued until a strong body of troops was marched into the town, but before their arrival damage to the amount of more than £60,000 had been done. Some of the rioters perished in the burning buildings, in the cellars of which they drank themselves into stupefaction. Others were tried and imprisoned, and four of the prisoners were hanged. The persecuted Unitarians recovered a small part of their losses from the county; but Priestley himself, owing in a great measure to the unworthy prejudice against him, was forced to remove to the United States of America, where he spent the rest of his life. A late atonement was made by the town to his memory in 1873, by the erection of a statue in his honour in front of the town hall and the foundation of a Priestley scholarship at the Midland Institute.

As if ashamed of the excesses of 1791, Birmingham thenceforth became, with one or two exceptions, a peaceful town. In the dismal period from 1817 to 1819, when the manufacturing districts were heavily distressed and were disturbed by riots, Birmingham remained quiet. Even when some of the inhabitants were tried and punished for demanding parliamentary representation, and for electing Sir Charles Wolseley as their delegate, there was no demonstration of violence—the wise counsels of the leaders inducing orderly submission to the law. The same prudent course was observed when in the Reform agitation of 1831–1832 the Political Union was formed, under the leadership of Thomas Attwood, to promote the passing of the Reform Bill. Almost the whole town, and great part of the surrounding district, joined in this agitation; vast meetings were held on Newhall Hill; there was much talk of marching upon London 100,000 strong; but, owing to the firmness and statesmanship of Attwood and his associates, there was no rioting or any sign of violence. Ultimately the Political Union succeeded in its object, and Birmingham helped to secure for the nation the enfranchisement of the middle classes and other political reforms. One exception to the tranquillity of the town has to be recorded—the occurrence of riots in 1839, during the Chartist agitation. Chartism took a strong hold in Birmingham, and, under the

influence of Feargus O'Connor and some of his associates, nightly meetings of a threatening character were held in the Bull Ring. The magistrates resolved to put these down, and having obtained the help of a detachment of the metropolitan police—the town then having no local police force—a meeting was dispersed, and a riot ensued, which resulted in injury to several persons and required military force to suppress it. This happened on the 4th of July. On the 15th of the same month another meeting took place, and the mob, strongly armed and numbering many thousands, set fire to several houses in the Bull Ring, some of which were burned to the ground and others were greatly damaged. The military again interfered, and order was restored, several of the ringleaders being afterwards tried and imprisoned for their share in the disturbance. There was another riot in 1867, caused by the ferocious attacks of a lecturer named Murphy upon the Roman Catholics, which led to the sacking of a street chiefly inhabited by Irishmen; but the incident was comparatively trivial and further disorders were prevented by the prompt action of the authorities.

See W. Hutton, *History of Birmingham* (2nd ed., Birm., 1783); J. A. Langford, *A Century of Birmingham Life, 1741–1841* (Birm., 1868), and *Modern Birmingham and its Institutions, 1841–1871* (Birm., 1873); J. T. Bunce, *History of the Corporation of Birmingham* (Birm., 1885).

BIRNEY, JAMES GILLESPIE (1792–1857), American reformer, leader of the conservative abolitionists in the United States from about 1835 to 1845, was born in Danville, Kentucky, of a family of wealth and influence, on the 4th of February 1792. He graduated at the College of New Jersey (now Princeton University) in 1810. In 1814, after a course of legal study, he began the practice of the law at Danville. He entered immediately, as a Democrat, into Kentucky politics, and political ambition caused his removal in 1818 to northern Alabama, near Huntsville. There was at that time in the south-west much anti-slavery sentiment. Birney's father was among those who advocated a "free state" constitution for Kentucky, and the home environment of the boy had thus fostered a questioning attitude towards slavery, though later he was himself a slave-holder. In the general assembly of Kentucky in 1816, and in that of Alabama in 1819, he opposed inter-state rendition of fugitive slaves and championed liberal slave-laws. His career as a lawyer in Alabama was exceptionally brilliant; but his political career was abruptly wrecked by his opposition in 1819 to Andrew Jackson, whose friends controlled the state. His tariff and anti-slavery views, moreover, carried him more and more away from the Democratic party and toward the Whigs.

About 1826 he began to show an active interest in the American Colonization Society, and in 1832–1833 served as its agent in the south-west. In 1833 he returned to Danville, and devoted himself wholly to the anti-slavery cause. He freed his own slaves in 1834. Convinced that gradual emancipation would merely stimulate the inter-state slave trade, and that the dangers of a mixed labour system were greater than those of emancipation in mass, he formally repudiated colonization in 1834; moreover, gradualism had become for him an unjustifiable compromise in a matter of religion and justice. At this time also he abandoned the Whig party. He delivered anti-slavery addresses in the North, accepted the vice-presidency of the American Anti-Slavery Society and announced his intention to establish an anti-slavery journal at Danville (1835). For this he was ostracized from Kentucky society; his anti-slavery journals were withheld in the mails; he could not secure a public hall or a printer. In these circumstances, he removed to Cincinnati, Ohio, and there, in January 1836, founded the *Philanthropist*, which, in spite of rancorous opposition, became of great influence in the north-west. Birney soon relinquished its active control in order to serve the Anti-Slavery Society as secretary and as a lecturer. He favoured immediatism, but he differed sharply from the Garrisonian abolitionists, who abhorred the federal Constitution and favoured secession. He always wrote, spoke and laboured for the permanent safety of the Union. The assaults of the South in defence of slavery upon free speech, free press, the right of petition and trial by jury, he pronounced

"exorbitant claims . . . on the liberties of the free states"; the contest had become, he said, "one not alone of freedom for the blacks but of freedom for the whites." Twenty-three years before William H. Seward characterized as an "irrepressible conflict" the antagonism between freedom and slavery, Birney proclaimed: "There will be no cessation of conflict until slavery shall be exterminated or liberty destroyed"—"liberty and slavery cannot both live in juxtaposition" (1835). The ends being political, so also, thought Birney, must be the means; as parties in the south were fusing, he laboured to re-align parties in the north, and advocated the formation of an independent anti-slavery party. After the separation of the Garrisonian and the political abolitionists in 1840 the new party was formed, and in 1840, and again in 1844, as the Liberty party (q.v.), it made Birney its candidate for the presidency. In 1840 he received 7069 votes; in 1844, 62,263. A fall from his horse in 1845 made him a hopeless invalid, and completely removed him from public life. He died at Perth Amboy, New Jersey, on the 25th of November 1857.

Two of Birney's sons, William Birney (1819-1907) and David Bell Birney (1825-1864), were prominent as officers on the Federal side during the Civil War in America.

See James G. Birney and His Times (New York, 1890), by his son, William Birney; and his principal writings: *On the Sin of Holding Slaves* (1834), *American Colonization* (1834), *Vindication of Abolitionists* (1835), *Literary Churches the Bulwark of American Slavery* (1840, 3rd ed. 1885); *Speeches in England* (1840); and *Case of Strader et al. v. Graham* (1852).

BIRON, ARMAND DE GONTAUT, BARON DE (1524-1592), a celebrated French soldier of the 16th century. His family, one of the numerous branches of the house of Gontaut, took its title from the territory of Biron in Périgord, where on a hill between the Dropt and the Lide still stands the magnificent castle begun by the lords of Biron in the 11th century. As a page of the queen of Navarre Biron attracted the notice of the marshal de Brissac, with whom he saw active service in Italy. A wound received by him in his early years made him lame for life, but he did not withdraw from the military career, and he held a command in Guise's regiment of light horse in 1557. A little later he became chief of a cavalry regiment, and in the wars of religion he repeatedly distinguished himself.

His great services to the royal cause at Dreux, St Denis, Jarnac and Moncontour were rewarded in 1569 by his appointment as a privy councillor of the king and grand master of artillery. He commanded the royal forces at the siege of La Rochelle in 1572, and four years later was made a marshal of France. From 1576 to 1588 he was almost continuously employed in high command. From 1589 he supported the cause of Henry of Navarre, but was suspected of prolonging the civil wars in his own interest. Biron was killed by a cannon-ball at the siege of Epernay on the 26th of July 1592. He was a man of considerable literary attainments, and used to carry a pocket-book, in which he noted everything that appeared remarkable. Some of his letters are preserved in the Bibliothèque Nationale and in the British Museum; these include a treatise on the art of war.

His son, CHARLES DE GONTAUT, duc de Biron (1562-1602), fought brilliantly for the royal party against the League. He was made admiral of France in 1592, and marshal in 1594; governor of Burgundy in 1595, he took the towns of Beaune, Autun, Auxonne and Dijon, and distinguished himself at the battle of Fontaine-Française. In 1596 he was sent to fight the Spaniards in Flanders, Picardy and Artois. After the peace of Verdun he discharged a mission at Brussels (1598). From that time he was engaged in intrigues with Spain and Savoy, and, notwithstanding, directed the expedition sent against the duke of Savoy (1599-1600). After fulfilling diplomatic missions for Henry IV. in England and Switzerland (1600), he was accused and convicted of high treason and was beheaded in the Bastille on the 31st of July 1602.

His collateral descendant, ARMAND LOUIS DE GONTAUT, duc de Lauzun, afterwards duc de Biron (1747-1793), is known for the part he played in the War of American Independence and the revolutionary wars. Until 1788, when he succeeded to the duchy

of Biron on the death of his uncle,—Louis Antoine de Gontaut, duc de Biron (1700-1788)—he bore the title of duc de Lauzun, which had passed, on the death of Antoine Nompas de Caumont, duc de Lauzun (1633-1723), to his niece, the wife of Charles Armand de Gontaut, duc de Biron (1663-1756). After for a while wasting his fortune in dissipation in various parts of Europe, he attracted attention by an essay on the military defences of Great Britain and her colonies (*Etat de défense d'Angleterre et de toutes ses possessions dans les quatre parties du monde*). This led to his appointment to a command against the English in 1779, in which he gained several successes. In the following year he took a conspicuous part in the War of American Independence, and on his return to France was made *maréchal de camp*. In 1789 he was returned as deputy to the states-general by the noblesse of Quercy, and attached himself to the revolutionary cause. In 1791 he was sent by the Constituent Assembly to receive the oath of the army of Flanders, and subsequently was appointed to its command. In July 1792 he was nominated commander of the army of the Rhine, with the duty of watching the movements of the Austrians. In May 1793 he was transferred to the command of the army of La Rochelle, operating against the insurgents of La Vendée. He gained several successes, among them the capture of Saumur and the victory of Parthenay; but the insubordination of his troops and the intrigues of revolutionary agents made his position intolerable and he sent in his resignation. He was thereupon accused by the notorious Carrier of *incivisme* and undue leniency to the insurgents, deprived of his command (July), imprisoned in the Abbaye and condemned to death by the Revolutionary Tribunal. He was guillotined on the 31st of December 1793. Some *Mémoires*, which come down to 1783, were published under his name in 1822 (new ed. 1858), and in 1865 letters said to have been written by him in 1789 to friends in the country, describing the states-general.

BIRR, or PARSONSTOWN, a market-town of King's county, Ireland, on an acclivity rising above the Birr, and on a branch of the Great Southern & Western railway by which it is 87 m. W.S.W. from Dublin. Pop. of urban district (1901) 4438. Cumberland Square, in which there is a Doric column surmounted by a statue of the duke of Cumberland, to commemorate the battle of Culloden, is the point from which the several principal streets diverge in regular form. The fine castle of Birr, beside its historical interest, has gained celebrity on account of the reflecting telescope erected here (1828-1845) by William, third earl of Rosse. This is 56 ft. in length and weighs 3 tons; and there is another smaller instrument. Among institutions the model and preparatory schools of the Brothers of the Presentation Order are noteworthy. There is a bronze statue by Foley of Lord Rosse (d. 1867). Some trade is carried on in corn and timber, and in brewing and distilling.

An abbey was founded at Birr by St Brendan (d. 573), to whom the present parish church is dedicated. The district formed part of Ely O'Carroll, and was not included in King's county till the time of James I. A great battle is said to have been fought near Birr in the 3rd century between Cormac, son of Cond of the Hundred Battles, and the people of Munster. The castle was the chief seat of the O'Carrolls. In the reign of James I. it and its appendages were assigned to Lawrence Parsons, brother of Sir William Parsons, surveyor-general. From him the alternative name of the town is derived. The castle was more than once besieged in the time of Cromwell, and was taken by Ireton in 1650. It also suffered assault in 1688 and 1690.

BIRRELL, AUGUSTINE (1850-), English author and politician, son of a Nonconformist minister, was born near Liverpool on the 19th of January 1850. He was educated at Amersham Hall school and at Trinity Hall, Cambridge. He went to the bar, and gradually obtained a good practice; in 1893 he became a K.C., and he was professor of law at University College from 1896 to 1899. But it was as a literary critic of unusually clever style and an original vein of wit, that he first became known to the public, with his volume of essays entitled *Obiter Dicta* (1884). In 1889 he was returned to parliament for West Fife shire as a Liberal. In the House of Commons his light

but pointed humour gradually led to the coining of a new word, "birrell-ing," and his literary and oratorical reputation grew apace. Whether he was writing miscellaneous essays or law-books, his characteristic style prevailed, and his books on copyright and on trusts were novelties indeed among legal textbooks, no less sparkling than his literary *Obiter Dicta*. A second series of the latter appeared in 1887. *Res Judicatae* in 1892 and various other volumes followed, for he was in request among publishers and editors, and his easy charm of style and acute grasp of interesting detail gave him a front place among contemporary men of letters. Mr Birrell was first married in 1878, but his wife died next year, and in 1888 he married Mrs Lionel Tennyson, daughter of the poet Frederick Locker (Locker-Lampson). At the general election of 1900 he preferred to contest the N.E. division of Manchester rather than retain his seat in Fifehire, but was defeated. He did valuable service, however, to his party by presiding over the Liberal Publication Department, and at the general election of 1906 he was returned for a division of Bristol. He had been included in Sir Henry Campbell-Bannerman's cabinet, and as minister for education he was responsible for the education bill which was the chief government measure in their first session. But the prolonged controversy over the bill, and its withdrawal in the autumn owing to the refusal of the government to accept modifications made by the House of Lords in the denominational interest, made his retention of that office impossible, and he was transferred (January 1907) to the post of chief secretary for Ireland, which he subsequently retained when Mr Asquith became prime minister in 1908. In the session of 1907 he introduced an Irish Councils bill, a sort of half-way house to Home Rule; but it was unexpectedly repudiated by a Nationalist convention in Dublin and the bill was promptly withdrawn. His prestige as a minister, already injured by these two blows, suffered further during the autumn and winter from the cattle-driving agitation in Ireland, which he at first feebly criticized and finally strongly denounced, but which his refusal to utilize the Crimes Act made him powerless to stop by the processes of the "ordinary law"; and the scandal arising out of the theft of the Dublin crown jewels in the autumn of 1907 was a further blot on the Irish administration. On the other hand his scheme for a reconstituted Irish Roman Catholic university was very favourably received, and its acceptance in 1908 did much to restore his reputation for statesmanship.

BIRTH (a word common in various forms to Teutonic languages from the root of the verb "to bear"), the act of bringing forth a child, or the fact of its being born; so also a synonym for descent or lineage. In law, a child not actually born, but *en ventre sa mère*, is supposed for many purposes to be actually born, and may take any benefit to which it would have been entitled if actually born, *i.e.* it may take as legatee or devisee, or even as next-of-kin or heir, but none of these conditions will take effect, unless the child is born alive (see **MEDICAL JURISPRUDENCE**). The given year of age of a child is gained at the first instant of the day preceding the birthday, and no account is taken of parts of a day, *e.g.* a child born at 11.59 on the night of the 2nd-3rd of May 1900, would be of age the first moment after midnight of the 1st-2nd of May 1901. In English law, by the Offences against the Person Act of 1861, it is a misdemeanour punishable by a maximum of two years' imprisonment with hard labour, to endeavour to conceal the birth of a child by any secret disposition of its dead body, whether the child died before, after or at its birth.

Registration of Births.—The registration of baptisms is said to have been first introduced by Thomas Cromwell when vicar-general in 1538, but it is only in comparatively modern times that registration has been fully carried out. The law relating to the registration of births was consolidated for England by the Births and Deaths Registration Act 1874, and for Ireland by the Births and Deaths Registration Act (Ireland) 1880. In Scotland it depends upon the Registration of Births, Deaths and Marriages (Scotland) Act 1854, as amended by later acts. Previously to the passing of the Births and Deaths Registration Act 1836, the records of the births were compiled from parish registers, which were formerly a part of the ecclesiastical organization, and con-

tinued to be attached, more or less, to the church till the passing of the act of 1836. That act provided a far more complete machinery than that before existing for the exact record of all births. The new system relieved the clergy from all functions previously thrown upon them, and finally, after improvement by subsequent acts, was made compulsory in 1874. The act of 1836 established a general register office in London, presided over by an officer called the registrar-general, with general superintendence over everything relating to registration. The registrar-general is appointed under the Great Seal. Every poor-law union or parish is divided into districts, each of which is called by a distinct name, and is in charge of a registrar, who is a local officer appointed by the guardians of the union. Over each union is a superintendent registrar, who has supervision over the registrars within his district. The office of superintendent registrar is usually filled by the clerk to the guardians of the union. He receives quarterly from every registrar within his district certified copies of the births registered by him and having verified their correctness, transmits them to the registrar-general. He takes charge of the register-books within the district, when filled. Every registrar is required to inform himself carefully of every birth which happens within his sub-district and register the same, with the various particulars required, according to the forms laid down for the purpose. It is the duty of the father or mother of any child born alive, or in their default, then of the occupier of the house (if he knows of the birth) or of any person present at the birth or having charge of the child, to give to the registrars, within forty-two days after the day of the birth, information of the particulars required to be registered concerning the birth, and in the presence of the registrar to sign the register. Every person required to give information concerning any birth who wilfully refuses to answer questions put to him by the registrar concerning the particulars required to be registered, or who refuses or fails without reasonable excuse to give information of any birth, becomes liable to a penalty of forty shillings. After three months a birth can only be registered in the presence of the superintendent registrar, and after the expiration of twelve months a birth can only be registered with the written authority of the registrar-general. In the case of an illegitimate child, no person as the father of such child is required to give information, nor is the name of any one entered in the register as the father of such a child, unless at the joint request of the mother and the person who acknowledges himself to be the father. An additional duty is placed upon the father by the Notification of Births Act 1907. By that act it is the duty of the father of a child if he is actually residing in the house where the birth takes place at the time of its occurrence to give notice in writing of the birth to the medical officer of health of the district in which the child is born within thirty-six hours of the birth. The same duty is also imposed upon any person in attendance (*i.e.* medical practitioner or midwife) upon the mother at the time of or within six hours after the birth. The medical officer of health is then in a position to take such steps, by advice or otherwise, as may, in his opinion lead to the prevention of infant mortality. Notice under the act is given by posting a prepaid letter or poster to the medical officer of health giving the necessary information. Failure to give notice entails on summary conviction a penalty not exceeding twenty shillings. The act is optional to local authorities, but may be enforced within any area by the Local Government Board. By the Births and Deaths Registration Act 1874 and the Merchant Shipping Act 1894, commanding officers of ships trading to or from British ports must, under a penalty, transmit returns of all births occurring on board their ships to the registrar-general of shipping, who furnishes certified copies of such returns to the registrars-general for England, Scotland and Ireland. These returns of births (and deaths) constitute the "Marine Register Book."

Registration is very efficiently carried out in practically every European country, with the exceptions of Turkey and Russia. In the United States laws requiring registration vary in the different states.

Tax on Birth.—In 1694 an act was passed in England for "granting to His Majesty certain rates and duties upon marriages, births and burials, upon bachelors and widowers for the term of five years, for carrying on the war against France with vigour." The taxes were graduated, rising from four shillings on the burial of the humblest person to £50 in the case of a duke or duchess. The duty on births varied according to the rank of the parents. A duke paid £30 on the birth of an eldest son, and £25 for every other child; a baronet or knight, £5 for an eldest son, and £1 each for other children. An archbishop or bishop, or a doctor of divinity, law or physic paid £1 for every child; a gentleman having a personal estate of £600 or a real estate worth £50 per annum, paid ten shillings on the birth of each child. Every other person not receiving alms paid a tax of two shillings on the birth of each child. This measure, however, was only temporary, and passed for revenue purposes solely.

See also articles **ILLEGITIMACY**; **INFANTICIDE**; **LEGITIMACY AND LEGITIMATION**; **POPULATION**; **SUCCESSION**; **OBSTETRICS**, &c.

BIRŪNĪ (ABD-R-RĀHĀN MUḤAMMAD AL-BĪRŪNĪ) (973-1048), Arabian scholar, was born of Persian parentage in Khwārizm (Khiva), and was a Shi'ite in religion. He devoted his youth to the study of history, chronology, mathematics, astronomy, philosophy and medicine. He corresponded with Ibn Sīnā (see **AVICENNA**), and the answers of the latter are still preserved in the British Museum. For some years he lived in Jurjān, and then went to India, where he remained some years teaching Greek philosophy and learning Indian. In 1017 he was taken by Maḥmūd of Ghazni to Afghanistan, where he remained until his death in 1048. His *Athār ul-Bākiya* (Vestiges of the Past) was published by C. E. Sachau (Leipzig, 1878), and a translation into English under the title *The Chronology of Ancient Nations* (London, 1879). His *History of India* was published by C. E. Sachau (London, 1887), and an English translation (2 vols., London, 1888). Other works of his, chiefly on mathematics and astronomy, are still in manuscript only.

See C. Brockelmann, *Geschichte der arabischen Literatur* (Weimar, 1898), vol. i. pp. 475-476. (G. W. T.)

BISALTAĒ, a Thracian people on the lower Strymon (Struma; Karasu, "black water"), in the district between Amphipolis and Heraclea Sintica on the east and Crestonice on the west. They also made their way into the peninsula of Acte and Pallene in the south, beyond the river Nestus in the east, and are even said to have raided Cardia. Under a separate king at the time of the Persian wars, they were annexed by Alexander I. (498-454 B.C.) to the kingdom of Macedonia. At the division of Macedonia into four districts by the Romans after the battle of Pydna (168) the Bisaltæ were included in Macedonia Prima (Livy xiv. 20).

Their country was rich in figs, vines and olive trees; the silver mines in the mountain range of Dysorum brought in a talent a day to their conqueror Alexander. The Bisaltæ are referred to by Virgil (*Georgics*, iii. 461) in connexion with the treatment of the diseases of sheep. The fact that their eponymus is said to have been the son of Heios and Ge points to a very early settlement in the district.

See Smith's *Dict. of Greek and Roman Geography*; M. Ihm in Pauly-Wissowa's *Realencyclopædie*, iii. part i. (1897); W. Tomaschek, *Die älteren Thraker* (Vienna, 1893); and for the coins of the Bisaltic kings, B. V. Head, *Historia Numorum*, p. 178.

BISCAY (*Viscaya*), a maritime province of northern Spain; bounded on the N. by the Bay of Biscay, E. by Guipúzcoa, S. by Álava and W. by Burgos and Santander. Pop. (1900) 311,361; area, 836 sq. m. A small strip of isolated territory within the borders of Biscay, on the west, is officially included in the province of Santander. Biscay is one of the Basque Provinces, and its name is occasionally employed as geographically equivalent to Basque, in that case including the three provinces of Biscay proper, Guipúzcoa and Álava. The coast-line, which extends from Ondarroa to a short distance east of Castro Urdiales, is bold and rugged, and in some places is deeply indented. The surface of the country is for the most part very mountainous, being traversed towards the south by the great Cantabrian chain; but at the same time it is diversified with numerous narrow valleys and small plains. Some of the mountains are almost entirely

composed of naked calcareous rock, but most of them were formerly covered to their summits with forests of oaks, chestnuts or pine trees, now destroyed to provide fuel. Holly and arbutus are common, and furze and heath abound in the poorer parts. The only river of any size is the Nervion, Ansa or Ibaizabal, on which Bilbao is situated; the others, which are numerous, are merely large mountain streams. The climate is rather inclement and variable; but the thermometer seldom drops below freezing-point, nor does snow fall frequently in winter except on the highest summits. The rainfall is on an average greater than in any province except those of the extreme north-west. The soil, though not very fertile, except in some of the valleys and sheltered hillsides, produces wheat, maize, barley, rye, flax, grapes, peaches, apples and other fruits. The mountainous slopes of Biscay are studded with the traditional Basque *caserio*, or farmhouse, in which the peasantry live on the *mélayer* system, dividing the profits of the soil with absentee landlords. The farms are generally small, and are for the most part tilled by manual labour. The fisheries are actively prosecuted along the coast by a hardy race of fishers, who were the first of their craft in Europe to pursue the whale, formerly abundant in the Bay of Biscay. Cod, bream, tunny and anchovy are the principal fish taken. The fishing fleet consists of several hundred boats, manned by nearly 5000 men and boys. Biscay is very rich in minerals. Iron of the finest quality is found in almost every part, and forms a main article of export. At the beginning of the 20th century an average of about 5,000,000 tons was produced every year, and many large foundries were at work. Lead and zinc are mined in much smaller quantities, alum and sulphur are also present, and marble, lime and sandstone are abundant. Another very important industry is the manufacture of dynamite and other explosives at Baracaldo, closely connected with the mining interests. There are also potteries, paper, soap and shoe factories, flour mills and breweries, and the many mineral springs and spas are frequented by people from all parts of Spain. The mining and industrial interests of Biscay were very materially assisted by the quick and important development of means of communication of every kind. The provincial and parish roads, kept up by the local government, are excellent. No province in Spain had at the beginning of the 20th century such a complete network of railways, all built since 1870.

Bilbao (pop. 83,306), the capital and principal port, and Baracaldo (15,013), an important industrial town, are described in separate articles. Sestao (10,833) is the only other town of more than 10,000 inhabitants; the port of Bermeo (9061) is the chief fishing station; Durango (4319), on the river of the same name, was founded by the early kings of Navarre in the 10th century, obtained the rank of a county in 1153, and contains one of the oldest churches in the Basque Provinces, San Pedro de Tavira; Guernica (3250), a picturesque village on the river Mondaca, was until 1876 the meeting-place of the provincial parliament. The deputies assembled under an oak tree, celebrated by the Basque poet, José Maria Iparraguirre, in a song which is regarded by the Spanish Basques almost as a national anthem. For the history of the Basques, see **BASQUE PROVINCES**; for their origin, language and customs, see **BASQUES**. The inhabitants of Biscay are intelligent, enterprising and well-educated; and, owing to the uniformly high birth-rate, low death-rate, and very slight loss by emigration, their numbers increased rapidly during the latter part of the 19th century, until in 1900 the density of population (372.4 per sq. m.) was greater than in any other Spanish province.

BISCAY, BAY OF (Fr. *Golfe de Gascogne*; Sp. *Golfo de Vizcaya*), an inlet of the Atlantic Ocean; bounded on the E. and N.E. by France, as far as the island of Ushant, and on the S. by Spain as far as Cape Ortegal. The Bay of Biscay is the *Sinus Aquitanicus*, *Sinus Cantabricus* or *Cantaber Oceanus* of the Romans; hence it is sometimes known as the Cantabrian Sea. Its modern English name is a corrupt form of the Spanish *Vizcaya*. The bay forms a fairly regular curve, broken on the French seaboard only by the estuaries of the Loire, Gironne, Adour and other rivers. The rugged Spanish coast is indented by many

fjord-like inlets, especially in the west, where navigation is sometimes difficult and dangerous; but its rivers are comparatively unimportant. The exposed position of the bay, and the diversity of its currents, have rendered it notorious for its storms.

BISCEGLIE (perhaps anc. *Natiolum*), a seaport and episcopal see of Apulia, Italy, on the E.S.E. coast, in the province of Bari, from which it is distant 21½ m. by rail. Pop. (1901) 30,885. Two towers, one some 90 ft. high, of a once strong Norman castle still remain; the cathedral belongs to the same period. The church of S. Margherita, founded in 1197, has fine canopied Gothic tombs of the Falcone family.

BISCHOPSWERDA, a town of Germany, in the kingdom of Saxony, on the Wesenitz, and at the junction of the Dresden-Görlitz and Bischofswerda-Zittau railways in the governmental district of Bautzen. Pop. (1905) 7465. There are cloth, artificial flower, and cigar factories, glass-works, potteries, and in the neighbourhood large granite quarries. It is famous as the scene of a battle, on the 12th of May 1813, between the French and the Allies after Napoleon's retreat from Moscow. It was the residence of Benno, bishop of Meissen, in the 11th century, and the "Bishop's Road" still runs from here to Meissen.

BISCHWEILER, a town of Germany, in the imperial territory of Alsace-Lorraine, district of Lower Alsace, 23 m. by rail N. by E. from Strassburg. Pop. (1900) 7897. It has manufactures of jute and machinery, brewing and iron-founding.

BISCUIT (pronounced according to the old spelling "bisket," a Fr. form from *lat. bis*, twice, and *coctum*, cooked, in reference to the original method of preparation; cf. Ital. *biscotto*, Sp. *biscocho*, &c.), a form of unvesiculated bread (*q.v.*), which is made in thin cakes of various shapes and baked in such a way as to be crisp and short. In the United States of America biscuits of this kind are usually called crackers, but the word biscuit is used there, as also in the north of England, for vesiculated bread baked in little flat loaves or cakes. Earthenware, porcelain, &c., which has undergone its first baking and is ready to be glazed is also known as biscuit or biske.

The raw material chiefly used in biscuit manufacture is flour, but many other substances, such as butter, sugar, salt, various flavouring essences, &c., are also employed. The flour used by the biscuit-maker differs somewhat from that preferred by the bread-baker. In the main the bread-baker wants flour of some strength, that is to say, flour capable of absorbing a considerable proportion of water and of making a loaf of more or less volume. For biscuits flour strength is not such a desideratum, and as a matter of fact such moisture as is used to make the dough is largely evaporated by the oven; but, except for the commoner kind of biscuits, colour is most essential, as well as sweetness of flavour. In a large biscuit factory several hundred different kinds of biscuits are made, ranging from plain water biscuits to the daintiest fancy biscuits glistening in sugar and piping. The storage required for such an establishment is extensive, but lifts serve to handle both raw material and finished products with a minimum of labour. The flour used by a firm which has a reputation to maintain is sifted as a precaution against the presence of bits of string or other foreign bodies which will make their way into flour sacked by the most careful of millers, and like the butter, sugar and other raw materials, is carefully inspected and tested before being accepted. After blending it is run through a shoot or sleeve to the mixers, which may be of any type used in bakehouses (see BREAD). From the mixers or kneaders the dough is delivered on a flat table, or it may go direct to a pair of rolls. These consist of iron rollers with a reversing motion, between which the dough is rolled backwards and forwards into sheets of uniform thickness. The next stage

is the feeding of portions of this slab of dough to a cutting and panning machine. In details this apparatus differs as supplied by different makers, but the broad principle is the same in every case. The dough, after first passing through a pair of gauging rollers, which still further thin out the sheet and are capable of regulating its thickness with the utmost nicety, is received by an endless conveyor-band of webbing or similar material. By this band it is carried forward by intermittent motion to a set of punches or stamps which descend on it in quick succession, and serve to mould the surface and cut the edges to the required pattern. This operation completed, the moulded dough passes forward on the same endless band. The dough has now been cut into two distinct divisions, the moulded biscuits and the unworked portion which forms a continuous sheet of a sort of scrap. The latter is separated from the moulded dough, and is carried upwards by another band, which delivers it on a tray or box whence it is returned to the rollers to be reworked. The moulded dough intended for the oven is carried along by the first band and is gently deposited on trays of sheet iron or woven wire. These trays are taken from the machine by boys and placed on the travelling-chains at the oven, or the trays may be automatically moved forward by a travelling-band and placed on the oven. The oven used for biscuit-baking is quite unlike any bread oven. It is much longer and is provided with sets of endless chains moving in parallel lines, and travelling over sprocket-wheel terminals and intermediate supports. The chains have special attachments on which the trays of biscuits are rested, and thus pass them through the oven, and discharge them at the opposite end. Some ovens are provided with a sort of endless belt of iron plates on which the biscuits are placed. These travelling bands are used chiefly for ship and also for dog biscuits, but the most usual type is the oven in which trays are moved on the travelling chains already described. The exact rate of travel, or the time during which the biscuits are in the oven, can be easily adjusted by means of countershafts and leather belts running on cone pulleys fitted at the discharging end. The heat of the oven as well as the rate of travel is varied according to the kind of biscuit, some varieties requiring a gentle heat and a comparatively long sojourn in the oven, while others must be exposed to a fierce heat, but only for a few minutes. The ovens, fired by coke, may be 38 to 50 ft. in length. Their temperature is not generally raised above 500 degrees, but the speed of travel of the trays ranges between 3½ and 25 minutes. The whole process of biscuit-making is thus rapid and continuous. The dough is kneaded in the mixers in a few minutes, and when discharged on the dough table is rapidly moulded into the required form by the cutter and panner. By means of endless bands the material is kept moving forwards, whether on the cutter or in the oven. For certain fancy biscuits special processes are used. Piping and sugar decoration is still necessarily done by hand, and the glaze on some fancy biscuits is imparted by spraying the moulded biscuit with very fine jets of fresh milk. Cracknels are made from a very stiff dough, and when cut out are thrown into coppers of boiling water. They speedily float to the top, remaining apart and not forming into groups. From these coppers they are taken out in trays pierced so as to drain off the water. Then they go into vats of cold water, from which they are again removed, and after being strained of their moisture are panned and baked in a fierce oven. (G. F. Z.)

BISECTRIX (fem. of *Lat. bisector*, from *bi-*, two, *secare*, to cut), in geometry, the same as bisector, *i.e.* a point which divides a line, or a line which divides an angle, into two equal parts; in crystallography it denotes the bisector of the angle between the optic axes.