

Meditations  
on  
The Cube of Space



Kevin Townley

# Meditations on The Cube of Space



Kevin Townley



Archer Books

Meditations on The Cube of Space © 2003 by Kevin Townley  
All rights reserved under International and Pan-American  
Copyright Conventions

No part of this book may be reproduced, stored in a data base or other  
retrieval system, or transmitted in any form, by any means, including  
mechanical, electronic, photocopy, recording or otherwise, without the prior  
written permission of the publisher.

Published in 2003 in the United States  
Archer Books  
P. O. Box 1254  
Santa Maria, CA 93456  
www.archer-books.com  
info@archer-books.com

Distributed in the United States by  
Midpoint Trade Books  
New York, NY  
www.midpointtradebooks.com

Printed in the United States

Cover and title page image © by David Mapes  
Author photo © by Valerie Meadows, Meadows Photography

First Edition

ISBN: 1-931122-09-1 Trade Paper  
ISBN: 1931122-10-5 Hardcover

Library of Congress Cataloging-in-Publication Data

Townley, Kevin

Meditations on the cube of space / Kevin Townley.—1st ed.

p. cm.

Includes bibliographical references (p. ).

ISBN 1-931122-10-5

ISBN 1-931122-09-1 (pbk.)

1. Occultism. 2. Tarot. 3. Cabala. I. Title.

BF1621.T68 2003

133.3—dc21

2002027996

This book is respectfully dedicated to all the ministers of Love and Good Will around the world; to my mother, Dolores, who was my first teacher and example of how to love, and to the Coming One whose nature is Love.















# Acknowledgments

Thanks to all those who have assisted in this effort. I offer my humble appreciation to the members of AUM and FLO who have over the years expressed their support in this humble extension of the Western Mysteries.



# Table of Contents

Introduction	xi
Chapter I: Limitation, The Power of Creation	15
Chapter II: Sealing and Binding the Cube of Space	31
Chapter III: Self-Conscious and Subconscious Aspects of the Cardinal Points	49
Chapter IV: The Law of Polarity	61
Chapter V: Zodiacal Polarity The Above and The Below	71
Chapter VI: Polarity and the Zodiacal Year	81
Chapter VII: The Four Diagonals	103
Chapter VIII: Meditations on 	121
Chapter IX: The Planetary Orders and the Attributions to the Minor Trumps	129
Chapter X: Meditations on the Minor Arcana	137
Chapter XI: The Three Decanates of 	151
Chapter XII: The Decanates of 	163
Chapter XIII: The Decanates of 	175
Chapter XIV: The Decanates of 	187
Chapter XV: The Decanates of 	201
Chapter XVI: The Decanates of 	213
Chapter XVII: The Decanates of 	225
Chapter XVIII: The Decanates of 	237
Chapter XIX: The Decanates of 	249
Chapter XX: The Decanates of 	261
Chapter XXI: The Decanates of 	273
Footnotes	287
Glossary of Symbols	289
Glossary of Hebrew Terms	291
Bibliography	295
About the Author	299





# Introduction

In *The Cube of Space* there was a lot of information presented about the Cube, labeling its parts and understanding how the form is generated geometrically. *The Cube of Space* is a good introduction to understanding the Cube. It accomplishes what it set out to do; namely it offers the student a handbook on the structure of the cube and its relationship to the connected hermetic sciences. The first book however does not offer much in the way of practical work. The following work is designed to go back into the Cube and share a series of meditations utilizing the information that was offered in volume one.

Like the first work on the cube, this is not intended to be the great American novel that is read from cover to cover in one or two sittings. The study and practice of the Cube and the Tarot is a process of transformation. There is a tremendous cosmology presented through the vehicle of the Tarot. Any student who takes up a serious study of this cosmology will be amply rewarded. With faithful study, you will understand to some degree, the words of Eliphas Levi who said, "Knowledge of the Tarot, and how to use it properly will allow the student to speak eloquently on all subjects."

Perhaps the most popular, and perhaps the least important application of the Tarot is reading Tarot cards. Divination is a wonderful and sometimes powerful tool to assist students in getting a birds-eye view of the present conditions of their life, with some possible solutions to their problems. Divination should not be underestimated. If divination is your only goal concerning the Tarot, this work is not for you. There are hundreds of great books on the subject on reading Tarot cards and this is not one of them. This is a book on the occult application of the Tarot in conjunction with the Cube of Space. At the close on each meditation on a Minor Key there is a key word given concerning its divinatory meaning. These are the key words given by Paul Foster Case. This is as far as the book goes concerning divination. Keep in mind however that if you go through the process offered in this work, you would gain an understanding of the Tarot

not given in any book. The main intention of this work is to make practical application of the cosmological wealth that exists within the cube and expressed by the Tarot. Accessing that wealth will ultimately lead each student into the full and uncompromising Grip of the Soul.

In order to accelerate our process in making conscious connection with the “Greater Life” within whom we live, we must reach for it. This connection is available to all those who aspire to make it. This system of meditations is designed to create a series of spiritual crises in the lives of those who take on this work. Comfort is not the goal although the reader should be mindful not to overdo it. So at certain times you may choose to take it more slowly.

This work is divided into several chapters. In order to gain the deepest understanding of the Cube of Space it is recommended that you go through the chapters in sequential order. This work presents the cube from the inside out. If you want to go from the outside in, start with the last chapter and work forward.

The approach is relatively simple. We follow the creative process as set forth in the Sepher Yetzirah. From the central point, to the emergence of the six directions in space, to the containment of these directions, we follow the intention of יהוה. (יהוה) JAH

There is a study of the modes of consciousness, the points of tension created by polarity, the revelation of the mysteries by the diagonals, and the movement of the personality around the exterior lines of the cube. All of these meditations are relatively simple in themselves, yet the effect is profound.

In Dr. Case’s early lessons on the Tarot, we were told that persistent study with the Tarot would yield such benefits as conversation with your Holy Guardian Angel, or perhaps making contact with the Inner School. I believe that *The Cube of Space* is a testimony that to some degree both levels of contact have been made even though these contacts be a distinctive preliminary knock at a portal to which all true disciples must eventually make their approach.

Although the *Cube of Space* is not a how to book, it is the first necessary step in progressing with the working with this glyph. After its parts are named and terms defined, then the practices with the Tarot and their relationship with each Key can begin, and begin we must if we desire to enter into the deeper mysteries of our Inner Life.

A side goal of this book is to bombard your consciousness with

symbols, Tarot, alchemical, as well as astrological. Whenever possible the symbol is used instead of the word. If you don't know the planetary and zodiacal symbols now, you will if you take the time to finish this book.

In the process of writing this current work, it became obvious that it was necessary to broaden the scope of the Ageless Wisdom. There have been many influences that contributed to this work. These influences have come from the writings of Paul Foster Case, Ann Davies, Masonry, under the Grand Lodge of Ancient Universal Mysteries, the *Fraternitas Lux Occulta*, and the massive works of the Tibetan Master D.K. through that great contemporary of Dr. Case, Alice Bailey.

These meditations come from experience and not just theory. Each meditation here has been worked out and practiced. The Cube of Space will teach you things you never wanted to learn, in ways you never wanted to learn them. Well that is not exactly a good selling point! The stuff works. If you want to have a spiritual crisis every month or so and exchange your present container for a larger one, go for it. If you are content with your present condition and wish to remain the same than don't bother reading any further. In short these meditations are like a crucible within the alchemical Athanor.

I trust that those who take on this work will be pleased with the outcome and perhaps they too will join the ranks of the disciples who become consumed by the will to love and serve humanity with fearlessness, harmlessness, and selflessness. That service must become heightened within all our hearts, even if it means being uncomfortable or unpopular.

Best wishes on you journey through the Cube of Space

Kevin Townley



# Chapter I

## Limitation, The Power of Creation

Before beginning with the meditations on the Cube of Space, We must ask, what is the function of the Cube in the first place? The Cube serves as a container! From the standpoint of the Cube, a container is a set of boundaries imposed upon a portion of, and within the great sea of chaotic potential. In Qabalistic nomenclature we call this sea of chaotic potential, (Ayin) אִין, the No-Thing. These boundaries create an environment for something specific to take place in the World of Name and Form. That **some-thing** can take any shape and serve any purpose the creator and filler of the container chooses. In order for something specific to happen, that something must be stripped of all other possibilities. Thus if the creator is going to create a red oak tree, anything that is *not* a red oak tree is necessarily eliminated from the realm of possibilities.

In working with the Cube there are three major points to consider:

- Limitation or the form aspect,
- The indwelling consciousness of the form,
- The life or spirit aspect.

Containment and limitation are very similar in nature, and on the Tree of Life, containment emerges from limitation, and the Life Force enters into the form aspect.

In the Hebrew Aleph-Beth the letter Cheth ח, represents the principle behind containment. Its meaning is “field” or “fence”. ח establishes the boundaries which separate that which is within the container from that which is outside the container. Apparent separation is the logical result of the process of containment. ח is attributed to the alchemical process of **Separation**. It is through the process of separation that limitation comes into focus, limitation being the function of ח. (SATURN).

In order to demonstrate the necessity for containment let us use a very simple example: Jell-O. “There is always room for Jell-O.” I remember as a child watching my mother filling the various containers

that were decorated in different ways. When the Jell-O congealed it took the shape of the container. Some of the containers had ripples on them, while others were in the shape of Bozo the Clown or Mickey Mouse. The point is that we were working with a substance that would take on the form and limitations of the container. The big difference between Jell-O and creation is that the container for the Jell-O is already something you can put your hands on, something you can touch. With cosmic Jell-O, the great sea of chaotic potential, the container is something that is formed within the mind of the creator. From the objective point of view this container, created in the mind, is unseen upon the ontological plane of name and form; it is seen with the mind's eye. This is the function of a creative image—setting the boundaries of what we desire to create.

(Setu) Imagine trying to make Jell-O without a container or perhaps trying to carry a gallon of water without something to carry it in. You would quickly realize the importance and function of the letter  $\Pi$ . If you tried to gather a gallon of water from a lake with no means to separate that gallon from the rest of the lake, you would understand the power of limitation, ( $\hbar$ ). Without a container or the power of limitation, we not only would end up with Jell-O all over the place, but also with a non-expression of Jell-O. Chet

Dr. Paul Foster Case uses a powerful meditation from *The Book of Tokens* to describe this idea of containment. When we truly understand the qualities of the letter  $\Pi$  and the message given in this meditation, we will gain a vast understanding of the need for limitation, order, and containment. The meditation is given in its entirety because of its richness of symbolic ideas.

The first verse of this meditation identifies the “hedge of protection,” as that Being within whom we live. If we live within a hedge of protection, then what are we being protected from? The meditation

### Meditation on $\Pi$ Chet

I am the hedge of protection,  
 Enclosing the field of existence.  
 In this field thou dwellest,  
 And I am thy defense  
 Against the darkness which is with-  
 out.

Yet is this hedge of safety  
 Also a wall of limitation,  
 And the darkness against which it  
 defendeth thee  
 Is the radiant Darkness of the Lim-  
 itless Light,

Too brilliant for thine eyes.  
 For within the wall of limitation  
 Is the field of mine activity  
 In the world of manifestation.  
 This, also is that which the wise call  
 The path of the House of Influence,  
 For into it descendeth the influx of  
 my power.  
 Because it seemeth to be set apart,  
 It is also the field of sin and pun-  
 ishment,  
 Because limitation is the root of fail-  
 ure,  
 And sin is but the missing of the tar-  
 get of perfection.  
 Yet as the archer gaineth skill  
 By reason of aiming again and again  
 at his mark,  
 Though in the beginning he miss it  
 a thousand times,  
 So doth the fruit of sin,  
 Which men call punishment,  
 Perfect the skill of my chosen ones.  
 Behold, sin and punishment are one,  
 And the fire of punishment  
 Is the fire that refineth my works.  
 Even in the sinner I am the Actor  
 And I, too, am the Sufferer  
 In the experience of punishment.  
 Thy pain is my pain.  
 Thy suffering my suffering  
 Thy sorrows pierce my heart,  
 Thine anguish is mine anguish.  
 I stand not aloof, unmoved,  
 Watching my handiwork,  
 As a potter watcheth the clay upon  
 his wheel.  
 Nay, not so,  
 For I am the clay,  
 And the wheel,  
 And the potter, too.  
 I am the work, and the worker,  
 And the means of working.  
 Take heed lest ye mistake these  
 words.

Be not deluded by false reasoning.  
 They err who say,  
 "The Lord is the doer of All,  
 Therefore may we do what pleaseth  
 us,  
 For we can do naught of ourselves."  
 Know that the error of their thought  
 Is the folly that any man do what  
 pleaseth him.  
 This false reasoning  
 Is rooted in the delusion of separate-  
 ness.  
 The appearance of separateness  
 Cometh of necessity from my self-  
 manifestation;  
 And because nothing can prevail  
 against me,  
 Even the worst of sinners shall come  
 In their appointed time, to libera-  
 tion.  
 If thou canst grasp it,  
 That liberation consisteth in the  
 breaking down  
 And the utter destruction of the  
 hedge of protection  
 Which encircleth thee, and guardeth  
 thee  
 From the terror of the Darkness  
 which is without.  
 For when the work is finished in the  
 field of CHETH  
 When the Abode of Influence hath  
 served its purpose,  
 Then shalt thou know, O Israel,  
 That thou hast naught to fear,  
 Naught to be guarded against.  
 Then shall the dreadful Darkness  
 Be revealed to thy perfected vision  
 As the flashing radiance of Light  
 Limitless,  
 And from the Field of sin and pun-  
 ishment  
 Thou shalt pass,  
 Into the boundless freedom  
 Of my divine perfection.<sup>1</sup>



continues to explain that we are protected from the darkness which is without. This radiant darkness is the sea of chaotic potential.

On the Tree of Life there are the ten lights of Divine Emanation. These ten lights continually step down the Life Power's intensity until it reaches the world of name and form. This stepping down of the Life Power prevents the destruction of the weaker containers. In the occult sense, containers serve multiple purposes. In the first place, containers limit the infinite potential of the sea of chaotic potential. Second, they keep this limited quality safe from being re-absorbed back into the undifferentiated sea of chaotic potential, "the radiant darkness".

If the container is a means of protection for its contents, from that which is its source, then that which is within the container is limited in its expression of its source. With the experience of separation from the source come all the difficulties that face humanity. Each individual must deal with the illusion of separation, for unless the illusion is reconciled within, that individual will express Divine consciousness in very limited and distorted ways. So in one instance the container protects and defines that which is within and at the same time, limits the awareness of the contents.

Our teachings in the Qabalah tell us that there is a boundless, limitless light, which is referred to as "the radiant darkness". This radiant darkness holds all the potential of the universe. It is the boundaries of a container that divide the manifested object from the unlimited potential, which itself remains unmanifested. Without this container there would be no differentiation between mere possibilities and a specific center of expression. Hence, nothing could be made manifest. So the letter  $\aleph$  sets up the field of operation for the limiting qualities of the Sphere of  $\aleph$ , where **און**, No-thing, becomes something. (Cheth) (Saturn) (Aiyis, פ.א.י.ס)

On the Tree of Life, we have learned that the Sphere of **בינה**,  $\aleph$  is the first of the spheres to hold a planetary signature. The 18<sup>th</sup> path of  $\aleph$  descends from the Sphere of  $\aleph$  and connects **בינה**, to the Sphere of **גבורה**,  $\sigma$ . This creates a powerful expression between two planetary intelligences. The Sphere of  $\aleph$  is the limiting power, while the Sphere of  $\sigma$  is the power of force and **Will**.  $\sigma$  is also associated with the power that builds a form, as well as the power that destroys the form. What is form? Form is the container. So the force of  $\sigma$  lies behind the building and the destruction of the limiting power of  $\aleph$ .

MARS  
Gestwah  
Cheth  
Saturn  
Aiyis  
פ.א.י.ס  
מ.מ.מ.  
Saturn

*Cheth*

within the container  $\Pi$ . When a form is outworn it goes through the process of dissolution, and the energy within it released, thereby freeing it to create other forms. When a form is destroyed, another more fitting vessel takes its place. This is the way of creation: involution, evolution; the way of life and the way of death. When we consciously work in the forming of a creative image, or consciously participate in the destruction of a form that no longer serves, we are engaged in the practice of the Magic of Light.

The following diagram shows the connection between the Sphere of  $\text{Ḥ}$ , the path of  $\Pi$ , and the Sphere of  $\text{Ḥ}$ .

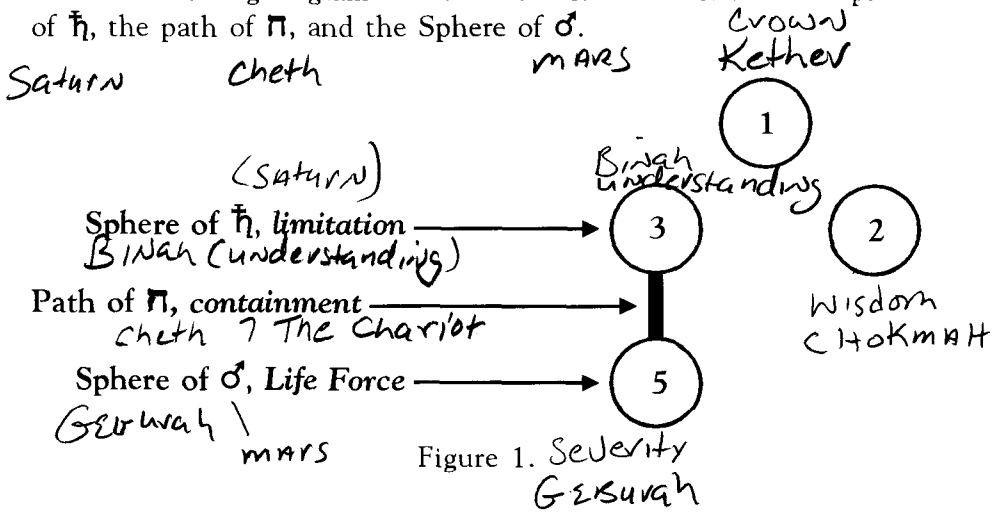

There is a Buddhist chant, which speaks to the need of continually expanding the consciousness of the center of expression within the container. Due to the implications that there is an eternal growth process, the Heart Sutra is one of the most debated teachings of the Buddha.

*Gate Gate Para Gate, Parason Gate, Bodi Svaha.*

This chant speaks to the need to go beyond the present condition of consciousness. After a spiritual crisis, a new frame of reference is established, and our awareness is expanded. After this expansion of consciousness, we work at its integration. After a period of integration, which may be lifetimes or perhaps it may occur several times in a life, we begin to go beyond that container. This process of expansion continues until we reach the state called Buddhahood. This state of consciousness is not the end, but a line of demarcation establishing

yet another container of consciousness. Spiritual crisis after spiritual crisis creates the necessary conditions for the expansion of our container.

The center of Buddhist thought is about transcending the field of sorrow. If we refer back to the meditation on  $\Pi$ , we read, <sup>Cheth</sup>

“Because it seemeth to be set apart,  
It is also the field of sin and punishment,  
Because limitation is the root of failure,  
And sin is but the missing of the target of perfection.”

It is only through continued spiritual practice that we are able to transcend the field of sorrow, or the “field of sin and punishment.”

We live our lives under the illusion of separation. We are told over and over again by the various occult traditions, that there is no real separation. We are told that we are all interconnected, interdependent and live within a corporate being. Our existence within this greater being is much like the cells and organs of our physical bodies. We know the cells and organs are there but they operate under the auspices of subconscious powers. We spend little time, if any, with a conscious awareness of the cells of our body yet they are united and form a complete whole. In like manner, the greater life has little conscious awareness of each of us as individual cells but experiences the wholeness of the form. We, like the cells of our body, are amenable to suggestion to the greater life within which we live. We are also told that this cooperate being is the true actor within each of us, limited by the individual quality of each center. Our work then is to acknowledge our limited awareness, our feelings of separation, and move toward conscious awareness that we are vessels of expression for a greater being. Unless we are able to expand our containers and let in more and more of the infinite beingness of the ONE BEING, we stop the growing process and feel more separated and fearful.

As we read further in the Meditation on the letter  $\Pi$ , we see, <sup>Cheth</sup>

“That liberation consisteth in the breaking down  
And utter destruction of the hedge of protection,  
Which encircleth thee and guardeth thee  
From the terror of Darkness which is without.”

Our continual expansion of our individual containers ultimately

results in the very destruction of the form that has been our womb. As in all birthing processes, the womb acts as a temporary container, which will eventually expel the child who has lived therein.

Whether we are working with the creative forces in manifesting our heart's desire, or we are refining our own containers so that they may become more receptive to higher levels of consciousness, we are working at balancing destruction and creation, limitation and expansion.

Some Tools for Meditation

(JAH) (IHU)      ) YOD, VIRGO ♍  
 7 HEV, ARIES ♈  
 7 VAV, TAURUS ♉

Let us now bring our focus back to the form of the Cube of Space. We begin by placing our attention on the three letters that were used to seal the six directions in space, יהו.<sup>2</sup> We already know from our studies that the letters יהו are three of the twelve simple letters associated with three of the signs of the zodiac. The letter ך, is associated with the sign of ♍, the letter ה, is attributed to ♈, and ו, is attributed to the sign of ♉. We also know that each of these letters has many other attributions of which a musical note and a color are two.<sup>3</sup>

Our work with sound and color is of vital importance. Sound is that preeminent vehicle through which creation takes place. Color is a vibratory expression of sound somewhere around the fortieth octave. In the occult sense sound is the vibratory motion which exists within the cosmic mind. Rhythmic sound patterns create order out of chaos. The Sanskrit word Akasha is attributed to sound, and is given the quality of space. The sealing of the six directions of space was accomplished by יהו uttering the sound of his name, establishing the boundaries of space. Thus we find that through the use of the rhythmic sound patterns the Cube of Space was created.

There are several references to sound as the creative impulse through the various world scriptures. Some of these references are:

- "through sound, the world stands" — Hindu
- "Shabda Brahma" — Hindu
- "And God said, let there be" — Hebrew
- "In the beginning was the word" — Christian
- "Man does not live by bread alone, but all that comes out of the mouth of the Lord." — Christian/Hebrew

(JAH) (IHU)

Below is a list of sound and color attributions used in our vibratory work. They are particularly attributed to the Qabalistic World of Creative Imagination. The reason for using the creative or Briatic level of colors is to transform the crystallized patterns that keep our vehicles from continually growing in awareness and being the finest centers of expression for the **ONE LIFE**.

The following chart shows the attributions of the 22 major Tarot keys and their correspondence to the Hebrew letters, sound, and color.

### Sound and Color Attributions to The Tarot

Tarot Key	Letter	Sound	Color	Name
Key 0	א	E	Light Yellow	The Fool
Key 1	ב	E	Yellow	The Magician
Key 2	ג	G <sup>#</sup>	Blue	High Priestess
Key 3	ד	F <sup>#</sup>	Green	The Empress
Key 4	ה	C	Red	The Emperor
Key 5	ו	C <sup>#</sup>	Red-Orange	The Hierophant
Key 6	ז	D	Orange	The Lovers
Key 7	ח	D <sup>#</sup>	Yellow-Orange	The Chariot
Key 8	ט	E	Yellow	Strength
Key 9	י	F	Yellow-Green	The Hermit
Key 10	כ	A <sup>#</sup>	Purple	Wheel of Fortune
Key 11	ל	F <sup>#</sup>	Green	Justice
Key 12	מ	G <sup>#</sup>	Light Blue	Hanged Man
Key 13	נ	G	Blue-Green	Death
Key 14	ס	G <sup>#</sup>	Blue	Temperance
Key 15	ע	A	Indigo	The Devil
Key 16	פ	C	Red	The Tower
Key 17	צ	A <sup>#</sup>	Violet	The Star
Key 18	ק	B	Red-Violet	The Moon
Key 19	ר	D	Orange	The Sun
Key 20	ש	C	Light-Red	Judgement
Key 21	ת	A	Indigo	The World <sup>4</sup>

### “From the Center Where the Will of God is Known”

The place where we will begin our meditations on the Cube of Space is from the center. The center of the Cube is attributed to the letter **ת, Tav**, among many attributions, is represented by Key 21 of The Tarot. Other meanings of **ת** are rest, inertia, the Sabbath, and

the seventh of the sacred planets known to the ancients,  $\bar{\eta}$ . As discussed at great length in *The Cube of Space*, the planet  $\bar{\eta}$  and its Magic Square is the matrix for this particular model of Cube of Space. When we expand our magic square to a cube, we find twenty-seven cubic units that make up the Magic Cube of  $\bar{\eta}$ . Twenty-six of these cubes can be seen from the outside, however the twenty-seventh cube is not visible. It is the twenty-seventh central cubic unit to which we are placing our attention. This is consistent with nature, when we think of how a plant is generated from the seed which it was planted. Even though the finished product looks little like the seed as it is placed into the ground, the intelligence of that seed is manifested on the surface and away from the point from which it has originated. This is analogous to the original intention, which begins at the center of the Cube and terminates at the exterior faces.

There are many ways in which we can approach the center of the Cube, for there are several symbols which speak to the quality of  $\bar{\eta}$ . The letter  $\bar{\eta}$  itself is a point of focus. When we use The Tarot we can see the cosmic dancer poised at the center of the Cube with the letter  $\bar{\eta}$  in the lower right hand corner. Another symbol that is very powerful and is also attributed to  $\bar{\eta}$  and the letter  $\bar{\eta}$  is the Tattwa "Akasha-Akasha". The symbol for Akasha is a vesica.<sup>5</sup> The vesica is formed when two circles of equal diameter pass through the center of each other. Figure 2 shows the forming of the vesica.

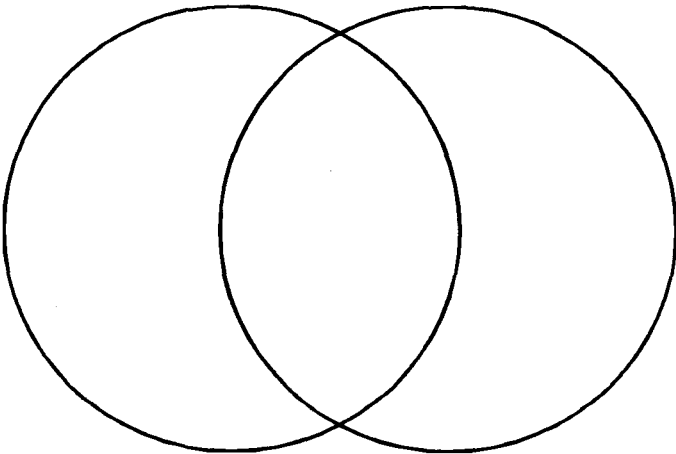

Figure 2.<sup>6</sup>

The Tattvic symbol for  $\text{ḥ}$  is Akasha–Akasha, and therefore is represented by two concentric vesicae. Remember that Akasha is attributed to both sound and space. On the sensory level it is attributed to hearing. Thus we find the eastern symbol of Akasha right on point for our work with the Cube of Space. The symbol of Akasha is made of complimentary colors with the vesicae colored indigo and the field of each vesica colored yellow orange. The sound attributions for this symbol are the same as those attributed to Key 21. This can be seen on the sound and color chart.

Figure 3 shows the symbol of Akasha–Akasha.

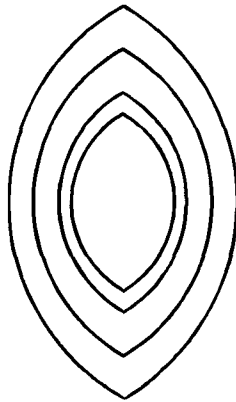

Figure 3.

We now have two powerful symbols that represent the intelligence at the center of the Cube of Space, Key 21 (The World), and Akasha–Akasha. The center of the Cube of Space is where all forms have their beginning, and to where all forms return. Manifestation begins with the limiting power of  $\text{ḥ}$ . (SATURN)

Since we wish to become receptive to the very highest levels we possibly can, all our meditations must begin with the intention of making ourselves receptive to that higher level. This begins, as Basil Valentine has said, “**with a certain Heavenly Intention.**” It is always helpful to work in a protected environment where you won’t be disturbed. This is probably unnecessary to say to most readers, yet here is a gentle reminder just in case you’ve forgotten. The time of day one does his/her meditations will vary from individual to individual. You will need to set up your schedule according to your own needs.

The point is to establish a time when you can be consistent in your spiritual discipline. Inconsistent spiritual work is like going on a diet for a couple of days and then ordering two triple cheeseburgers fries and a diet coke. The diet coke is a great symbol but the cheeseburgers do not support the chosen goal.

Practice these meditations sitting in a comfortable position. Begin with quiet rhythmic breathing that fills the lungs, including those nooks and crannies that seldom receive the **Life Breath** and exhaling completely. After a few moments of quieting yourself, you will be ready to start.

### Meditation #1

Begin all your daily meditations with the intonation of these four Divine Names:

Eheyah	אהיה	E-C-F-C
Jehovah	יהוה	F-C-C <sup>#</sup> -C
Elohim	אלהים	E-F <sup>#</sup> -C-F-G <sup>#</sup>
Adonai	אדני	E-F <sup>#</sup> -G-F

These names as most of you already know represent certain archetypes of the Atziluthic world, the world associated with abstract ideas. The names are not personalities but vibratory formulae, which invoke particular complex combinations of planetary and zodiacal energies and forces. These forces are centers of expression for the twenty-two letters.

We begin by chanting these names in order to attune ourselves to the highest levels of consciousness we are presently capable of attaining.

Following these intonations place your attention on the center of the Cube and the symbols associated with ת. If you have any other symbols that contribute to this idea they could serve as well; however, it is vital that you use the proper symbols that truly evoke the consciousness of the intelligence desired. Tau

Place your attention on Key 21 and envision yourself in the center of the Cube of Space. As you do this, image the color blue-violet emanating from the center of your being, forming a small cube.

This is the small cube, which is in the center of the larger cube. This cube is the 27<sup>th</sup> central cubic unit of the macrocosmic cube presented in Chapter Five, page 133 in *The Cube of Space*. Repeat the mantra “ah-oo-um” three times while intoning the note A natural.<sup>7</sup>



After you have completed this portion, bring your attention to the symbol Akasha–Akasha and focus on the concentric vesicae. After about a minute of focus, chant “ah–oo–um” three times with the note A. After the intonation, close your eyes and wait for the afterimage to dissipate. Then image yourself in the center of the two vesicae. See yourself emerge from the center radiating a blue violet light. What is taking place is the formation of a center of expression that will radiate its intelligence to the six directions in space.

### Hear Oh Israel

The letter ם resides at the still point at the center of the Cube and from that point radiates the six directions in space. This is accomplished through the agency of the three Mother letters א, ב, and ש. These extend from the center to the six faces.

In the **Book of Formation**, these three letters were used as vehicles to take the power of the One Life and bring its Holy Influence into limitation. Through the movement from the center outward these mother letters carried the six permutations of the Holy Name, יהוה, to the six directions in space, and created six of the seven pairs of opposites. In our journey toward the ONE, we must learn to listen to the instruction that comes from the center of our being. This center is synonymous with the center of the Cube of Space. The three mother letters א, ב, and ש tell us what we must do, and that is to listen and **hear** the message that originates in the center. When we place the order of the mother letters as אבש, we have a reversal of the order in which the six directions in space were sealed and find ourselves traveling back toward the center from which creation began. This reversal also gives us the word Shemiah (שמ׳א), “listen” or “hear”, minus the letter ׳.

This second meditation therefore is focused on the idea of listening to the stable and perfect intelligence, which dwells at the center of all creation. The symbols used in this meditation are Tarot Keys 0 (The Fool), 12 (Hanged Man), and 20 (Judgement). These keys are symbolic of the letters א, ב, and ש respectively. The three corresponding Tattwas are Akasha–Vayu, Akasha–Apas, and Akasha–Tejas. Notice that each of these Tattwas have Akasha as their primary form, and a secondary Tattwa which represents an element. With Akasha as the primary form we find that these three Tattwas are the principles behind the elements and not the elements themselves. This is

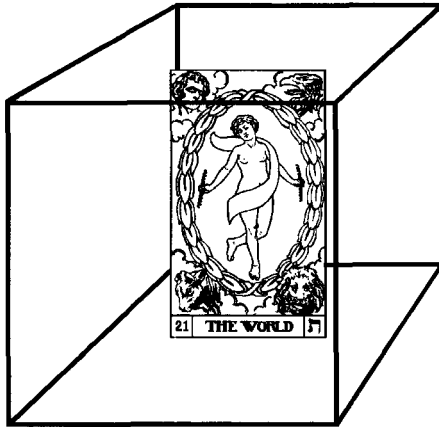

Figure 4.

consistent with the three mother letters, for they are the principles, which create the environment for the manifestation of the elements.

Notice that the secondary Tattwas are elemental, with Vayu symbolic of  $\Delta$ , Tejas symbolic of  $\Delta$ , and Apas symbolic of  $\nabla$ . The following is a chart showing the correlations between principle, Tarot key, Tattwa, and element:

Mother Letter	Principle	Tarot Key	Tattwa	Element
א	♀	Key 0	Akasha Vayu	$\Delta$
ש	♁	Key 20	Akasha Tejas	$\Delta$
מ	⊖	Key 12	Akasha Apas	$\nabla$

With our focus on listening to the sound that comes from the center, we find ourselves back to the quote from the Vedas saying, “out of Akasha all things come and to Akasha all things return.” Akasha is called the mixing-bowl of the elements. Akasha is also attributed to the subtle principle of **Hearing**.<sup>8</sup>

Drawing all of this together we can see that the three mother letters are the mothers of Air  $\Delta$ , Water  $\nabla$ , and Fire  $\Delta$ . It is through the agency of Akasha, the invisible *Alchemical Earth*, (that which is “תהו ובהו,” “formless and void”), that these elements come forth into manifestation, and create the boundaries of time and space. Through the mixing bowl of the elements, Akasha, the subtle principle of hearing, beckons all aspirants to come to their source and consciously connect with the undistorted beauty of the **ONE SELF**.

Meditation # 2

Begin by gathering together the six symbols to be meditated upon. Key 0 (The Fool), and Akasha–Vayu, Key 12 (Hanged Man), and Akasha–Apas, and Key 20 (Judgement), and Akasha–Tejas. The following diagram shows the three Tarot keys and their corresponding Tattwas.

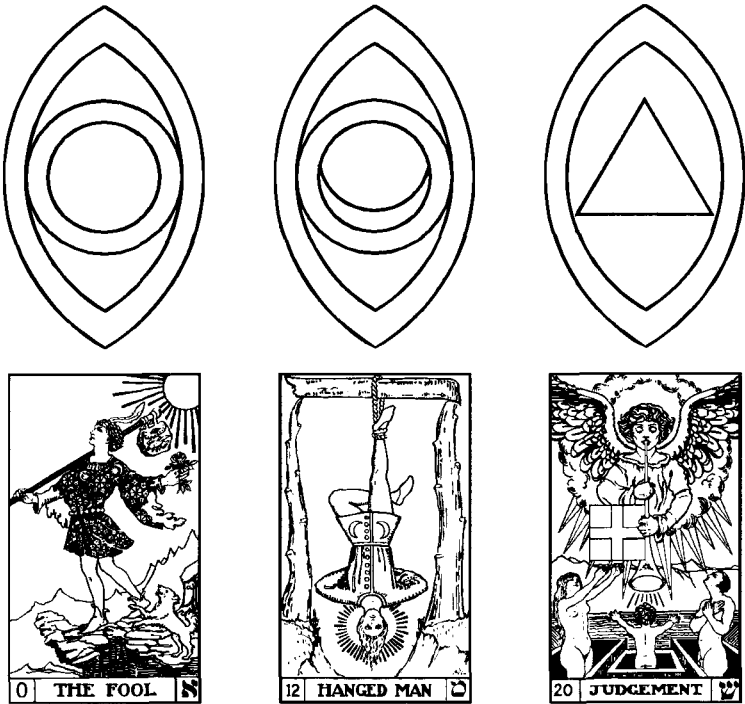

Figure 5.

Take the three Tarot keys and begin by focusing on Keys 20, 12, and 0, moving from right to left intoning “She–Ma–Ah”.

♁
♂
♃  
 E      G#      C

Repeat the intonations three times and image three axes coming from your center. These axes are the axis of ♁, which ascends from the center to the above and descends from the center to the below;

the axis of **᳚**, which travels from the center to the east and from the center to the west, and the axis of **᳛**, which travels from the center to the south and from the center to the north.

After holding this image for a few minutes place your attention on the three Tattwa symbols, beginning with Akasha–Tejas, Akasha–Apas, and Akasha–Vayu. These symbols are in the reverse order of the sealing of the six directions in space. It is our intention to travel back to the center, and hear the voice of silence.

With the Akasha–Tejas Tattwa, we are accessing the power that lies behind the element of  $\Delta$  and the axis that radiates from the center to the south and from the center to the north. This is the axis of light and darkness. The intonations for this Tattwa are A and C.

The next symbol is Akasha–Apas. Intoning this symbol assists us in resonating with the power behind the element of  $\nabla$  and the axis from the center to the east and from the center to the west. This is like the planting of the seed in the east and the harvesting of the fruit in the west. The intonations for this symbol are A and A<sup>#</sup>.

Finally place your attention on the Akasha–Vayu. You are attuning with the element of  $\triangle$  and the above and below axis of the Cube of Space. This as you know connects self-consciousness and sub-consciousness. The intonations for this symbol are A and G<sup>#</sup>.

After completing this meditation, continue to hold the image of the three axes projecting their intelligences into the six directions of space. As you do this remember that these three letters **᳜᳚᳛** are direct lines to the center from which we receive all our support and sustenance.

You may choose to pay attention to the quality of sound when intoning the various combinations of notes. Some of them ring with beautiful harmony and other combinations are in strident discord. See how you respond to these various note combinations. You will know by true knowledge that consistent practice in this type of meditation will yield a powerful transformational result, whether comfortable or uncomfortable.

We have now completed two of the primary meditations. We have established the central point of the Cube through the letter **᳚**. From this point the process of creation emerges. We also have focused our attention on the three primary rays of energy that created all forms.

In Chapter II, we will focus on the sealing of the six directions in space, and the defining of the twelve boundary lines of the Cube.



## Chapter II

### Sealing and Binding the Cube of Space

Chapter II deals with two major aspects of creation: limitation and containment. In the Sepher Yetzirah we read that the six directions in space were sealed by יהו. The sealing is accomplished through an act of intention by a divine being who is attributed to the Sphere of אצילות in חכמה. This is the World of archetypes and abstract ideas and Lack of Definition. In order for creation to take place, this being had to choose to impose limits upon himself. The choice toward limitation precipitated the sealing of the six directions in space. The sealing of the six directions began the process of limitation, but did not complete it. A line travels infinitely in either direction. Because of the infinite extension of a line, it became necessary to impose further limits by containing the projective force that emanated from the center and was expressed as three axes or lines. The necessary steps were taken by extending the Divine Name, from three letters to four. The name of four letters, like the name of three letters, went through a series of permutations which created the twelve boundary lines of the Cube of Space. These twelve boundary lines contained and limited the six projected lines in space. The sounds that were employed for these two distinct acts were derived from the three simple letters of יהו. In this chapter we will explore the symbolic images of The Tarot in relation to this act of creation. From our present state of consciousness, we can only predicate what such an act involves. Meditation on the Chaldean/Hebrew letters and the symbols of Tarot will assist us in transcending our limited conceptions.

The formation of these two Divine Names is not an arbitrary act. The letters themselves are living expressions of the force employed in the act of creation.

First we have the paternal ׀. From this letter all letters have their source. The letter ׀ is a cosmic  $\Delta$  which ignites all letters. By simply observing each Chaldean/Hebrew letter you can see that there is always a tongue of flame somewhere within the body of any letter. The

letter ם has a value of 10. In order for creation to take place, there is a process of reflection and separation. This is accomplished numerically by taking the number 10 and dividing it in half. From this exercise we get the number 5, which is the value of ה.

Second we have the letter ה, which represents specificity. Within the letter ה, the cosmic Δ of ם is placed. Thus do we find the name הם the first of three names assigned to the Sphere of חכמה. This name does not quite represent the full potential of the universe, so when the name הם is formed there is a birth that takes place—a divine offspring; the son, ם. The value of 10 + 5 gives us 15, which reduces to 6, the value of ם. With the addition of the letter ם, we now have the second of three names attributed to חכמה, יהו. As this divine being further defines itself by sealing the six directions in space, there is generated a fourth letter, a second ה which forms the third of the three names attributed to the Sphere of חכמה, יהוה.

ם exists by and of itself; ה defines the point. With the emergence of ם, we have the lines of direction and with the second ה, the lines are contained and the full container of space is formed.

Within these four steps of forming the Divine Name יהוה we have the tetractus. The following shows the generation of this name.

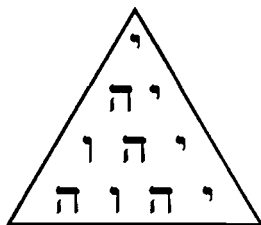

Figure 6. Generation of the Tetractus

The next meditation will deal with the three simple letters, which make up the name יהו. There are several different versions of the Sepher Yetzirah. The permutations of the name יהו in this text will be taken from the Sort and Saddia versions.<sup>9</sup> The orders in which the permutations unfold are:

Above	יהו
Below	היו
East	הוי
West	הוי

South      יה  
 North     והי

This meditation offers an opportunity for inner knowledge concerning the Cube of Space, especially if it is performed before retiring. During sleep the letters seem to continually rearrange themselves within the mind. It is this meditation that seemed to open the doors to the information which came forth in the book, *The Cube of Space*.

The name יהו is represented by three major Tarot keys. These keys are the symbolic medium we use in order to plant the proper suggestions within the subconscious mind. The Tarot keys used in this meditation are Keys 9, 4, and 5. We begin our meditation with the following arrangement:

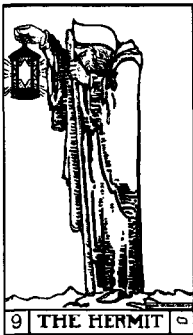

As you go through this meditation you will change the order of the keys according to the particular permutation of the letters.

### Sealing the Six Directions

We begin with a focus on the central point established in the first meditation. It is an added asset if you happen to have a small portable keyboard to play the notes of the chants. The notes for this chant are, ו = F, ה = C, ו = C#.

As you begin this meditation, see yourself as the center of the Cube where all axes emanate. There are six steps to this meditation. First begin by visualizing the central point of the three axes of the mother letters. Remember that each line we work with extends infinitely in either direction. In this meditation on the six permutations of יהו allow the lines to be lost within the colored vortices we will be visualizing.



The following is a model of the three axes that extend in the six directions in space:

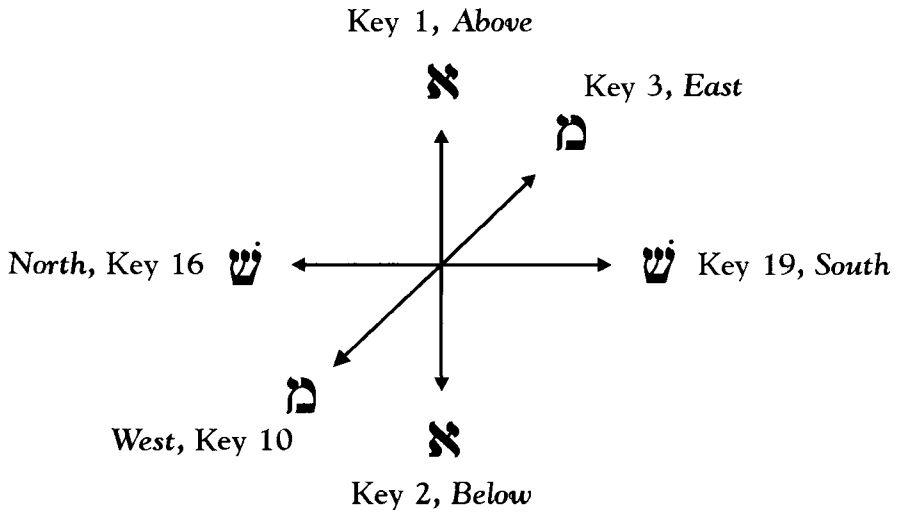

Figure 7.

From the central point, follow the axis of a from the center to the above. While visualizing the flowing of consciousness towards the above, chant the name vhy three times. While chanting this name, visualize the color yellow in a whirling vortex from the center sealing the above face of the Cube. Use Key 1 (The Magician), as a focal point for the above face. This key will assist the student in gaining a deeper connection with the first permutation of יהו.



יהו

First he sealed the above with יהו

The next part of this meditation is to re-arrange the letters to ייה, and focus your attention on Key 2, High Priestess. Chant the name as you visualize the below face of the Cube being sealed through the axis of **⚡** moving from the center to the below. The color of this vortex is blue. The Magician and the High Priestess are the vessels that receive the impulse from the axis of **⚡**.



ייה

Second he sealed the below with יהו

Bring your attention back to the center of the Cube of Space and rearrange the letters to יהיו. This arrangement is associated with the axis of **⚡** and the eastern face of the Cube. As you chant this name visualize the color emerald green in the form of a vortex sealing the eastern face of the Cube.



היו

Third he sealed the east with היו

We now return to the center, and follow the axis of ה to the west. The letters are rearranged to היו to reflect the movement from east to west whereby the western face of the Cube was sealed. As we chant this name, visualize a violet vortex traveling from the center sealing the western face of the Cube. Key 10 (Wheel of Fortune), is associated with the west.

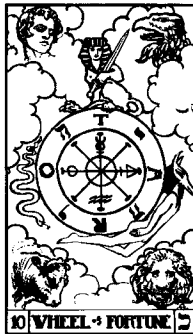

הוי

Fourth he sealed the west with הוי

The final axis is the mother letter ה. As we bring our attention back to the center of the Cube we chant the name הוי, and send this vibration to seal the southern face of the Cube. Visualize a bright orange vortex moving from the center to the south. Use Tarot Key 19 (The Sun), as your symbol of focus.

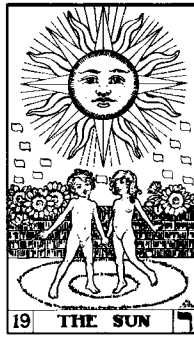

ויה

Fifth he sealed the south with ויה

The final permutation is ויהי. Once again bring your attention back to the center and send this vibration to the northern face through the axis of ש. Visualize a bright red vortex moving from the center to the north thus sealing the northern face of the Cube. Key 16 (The Tower), is the Tarot key attributed to the North.



ויהי

Sixth he sealed the North with יהו

In this meditation, the six directions of space have been sealed with the six permutations of the name יהו through the three axes of א, מ, and ש. We know that the six directions are also associated with six of the seven planets, with the seventh located at the center. Therefore, from the name יהו, we have seen the generation of six of the seven planetary intelligences.

This meditation assists us in contacting and integrating these intelligences within the cellular consciousness of our physical vehicle. When practiced over a period of weeks this meditation should have profound effects on your capacity for insight into the flow of creative thought. This meditation is helpful when working at establishing boundaries during a particular cycle of creative manifestation.

So far we have worked with the three mother letters, their corresponding Tattwas, and the six permutations of the Divine Name **יהו**. All three of these meditations deal with the emergence of the **Will** to create limits for the sake of manifestation.

In the process of the six permutations of the name **יהו** we have established the location of six of the seven planets. They are:

### The Location of Planets

☿	<b>יהו</b>	above
♃	<b>יה</b>	below
♀	<b>היו</b>	east
♁	<b>הוי</b>	west
☼	<b>ויה</b>	south
♂	<b>והי</b>	north

### From Potential to Form

As the Divine Being **יהו** created the necessary boundaries for self-expression there occurred a change in the quality of this Being. This change is one from potential to specific manifestation. We can see a similarity between the name **יהו**, and the name **אהיה**. This similarity is that of number, the values of which are 21. When we reduce 21, ( $2 + 1 = 3$ ), we have the number associated to the sphere **בינה** the Sphere of the Divine Mother. The Sphere of Understanding is the Sphere of Limitation and Form. With the six faces defined, we now have a cube, which changes the Divine being **יהו** to **יהוה**. The six faces, eight corners, and twelve boundary lines of the Cube demonstrate this transformation:  $6 + 8 + 12 = 26$ , yielding the value of the Divine Name, **יהוה**. There are six permutations of **יהו**. There are twenty-four permutations of the name **יהוה**. The interesting thing to note about the twenty-four permutations of **יהוה** is that twelve of the permutations are not distinguishable from the other twelve. This is because of the double appearance of the letter **ה**. The first appearance of **ה** is attributed to the element of  $\nabla$ , while the second is attributed

to the element of  $\nabla$ . Unless there is a distinctive marking made between one letter and the other there is no detectable difference between יהוה and יהוה. If we did something like this: יהוה, we would be able to see the twenty-four permutations of this Divine Name. Other distinctive marks that could be used are the elemental attributions. If we were to place the four triangles attributed to the four elements, we could see the difference in the twenty-four arrangements of this name:  $\nabla \triangle \nabla \triangle$ .

So far in my personal studies I have not run into an explanation regarding the meaning of the other 12 permutations, but I have some insights. This is best left for the time when knowledge is the teacher and not speculation.

We will presently deal with the twelve permutations of יהוה which give rise to the twelve signs of the zodiac.

The Twelve Permutations of יהוה

הוהי	וההי	ההוי	יהוה	היוה	ויהה
♈	♉	♊	♋	♌	♍
ה	ו	ז	ח	ט	י
יההו	ההוי	היהו	והיה	הויה	הוהה
♎	♏	♐	♑	♒	♓
ל	נ	ס	ע	צ	ק <sup>10</sup>

The Eastern Face

With the six directions of space defined, we are now ready to expand the points in space into defined squares or faces of the Cube of Space. This is accomplished through the twelve permutations of the Divine Name יהוה listed above. We begin our meditation with a focus on the eastern face of the Cube. We do this to align ourselves with the zodiacal year, which begins in the sign of Aries.

The first four signs of the zodiacal year are the signs which bind the eastern face of the Cube. The signs are: ♈, ♉, ♊, and ♋. The center of the eastern face is governed by the planetary intelligence of ♀. In relationship to the Tree of Life it is the Sphere of נצח.

Using the same system of sound and color correspondences we take the four corresponding permutations of יהוה and envision the color

emerald green and Key 3 (The Empress) as a focal point. We then chant the notes of the permutations in zodiacal order. As you do this, be sure to have Tarot Keys 3, 4, 5, 6, and 7 before you.

Look at each of the keys for a few minutes before chanting the four permutations of the eastern face. The arrangement of the keys should be as follows:



Figure 8. The Eastern Face

The zodiacal order for these names are:

♈	הוהי	CC#CF
♉	וההי	C#CCF
♊	ההוי	CCC#F
♋	יהוה	FCC#C

Notice the difference between the sealing and the binding of the six directions. In sealing the six directions a line was extended from the center to the six directions in space. In the binding of the six directions with the twelve permutations of יהוה we impose a limitation on the points, until such time that their boundaries should be expanded to encompass greater awareness.

As you chant these names, visualize the currents flowing around the eastern face. Notice that the current descends through the sign of ♈, travels along the below face from north to south through the sign of ♋, and ascends from the below to the above through the sign of ♉. The current then traverses the above eastern line from south to north in the sign of ♊. This is one of the two faces which an individual can continuously navigate over and over again without changing directions.

### The Northern Face

The next part of this meditation involves the next three signs in the zodiacal year. They are ♌, ♍, and ♎. We have already sealed the northeast corner with the sign of ♌, however we will include it in this portion of the meditation so we may see the four binding lines. Visualize the color red at the center of the northern face. Red is attributed to the North, Key 16 (The Tower), and to the planet ♄. The zodiacal order of names is:

♌	היוה	CFC#C
♍	ויהה	C#FCC
♎	יההו	FCCC#
♏	הוהי	CC#CF

This meditation brings us to the Autumnal Equinox. While chanting the permutations of the northern face keep in mind the flow of current. It is unlike the eastern face because it does not go in a continuous direction. You will understand the ramifications of the flow



of current from the northern face later. Right now we are working with the binding of the six faces through the vehicle of the twelve zodiacal signs. While meditating on the northern face, keep in mind that the perspective is viewed from the south looking at the north. Place Tarot Keys 8, 9, 11, 4 and 16 thus:

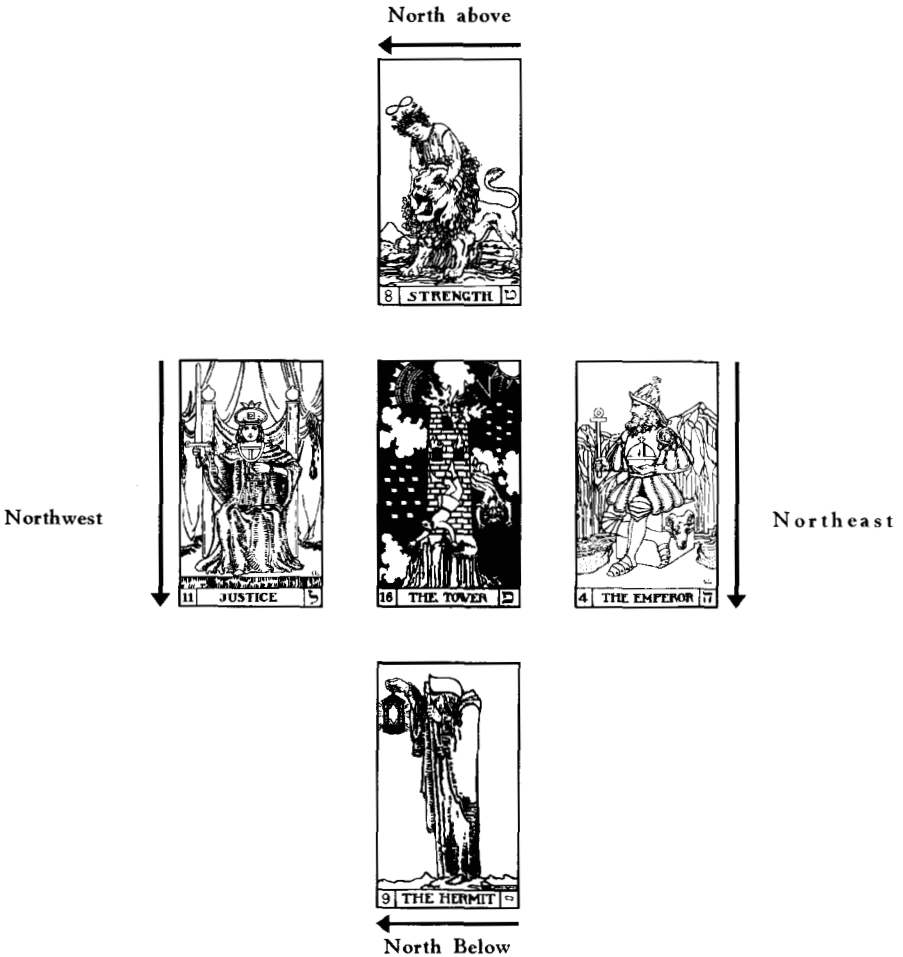

Figure 9. The Northern Face

### The Western Face

The next part of this meditation will concern the western face which binds the intelligence of the planet ♃ by the signs of ♎, ♏, ♐, and ♑. The sign of ♎ has also been used in the binding of the

northern face. The zodiacal order of names is:

♈	ההוי	CCC#F
♉	היהו	CFCC#
♊	והיה	C#CFC
♋	יההו	FCCC#

The major Tarot key at the center of the western face is the Wheel of Fortune, and the color violet. Focus on Key 10 and the color violet as you chant the vibratory formulae listed above. Make sure you take the time to use the major Tarot keys in the manner placed below. The perspective of the viewer is from the west outside the cube.

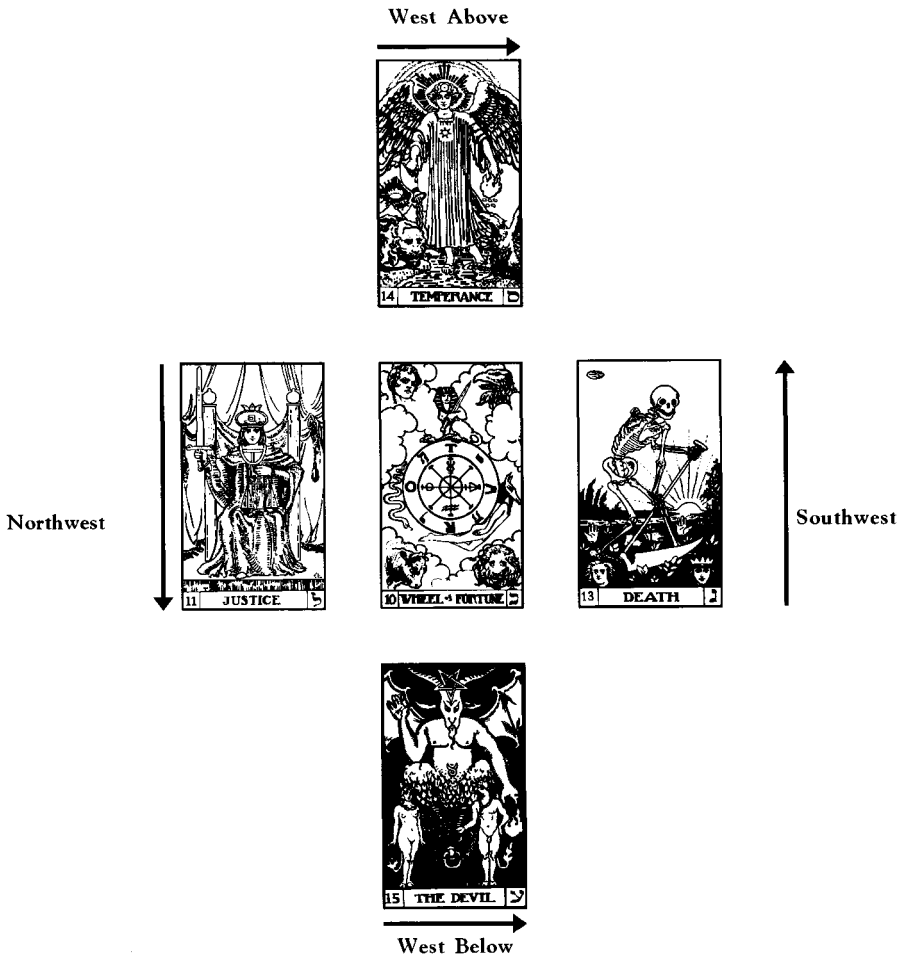

Figure 10. The Western Face

Once again pay close attention to the flow of the currents on the western face.

### The Southern Face

This meditation brings us to the close of the zodiacal year. The southern face is completed with the signs of ♁ and ♋. The southeast and southwest lines have already been bound by the signs of ♃ and ♎. Orange is the color attributed to the southern face, and Key 19 (The Sun). The Tarot keys used in this meditation are 19, 17, 13, 5, and 18. They are placed in the following pattern.

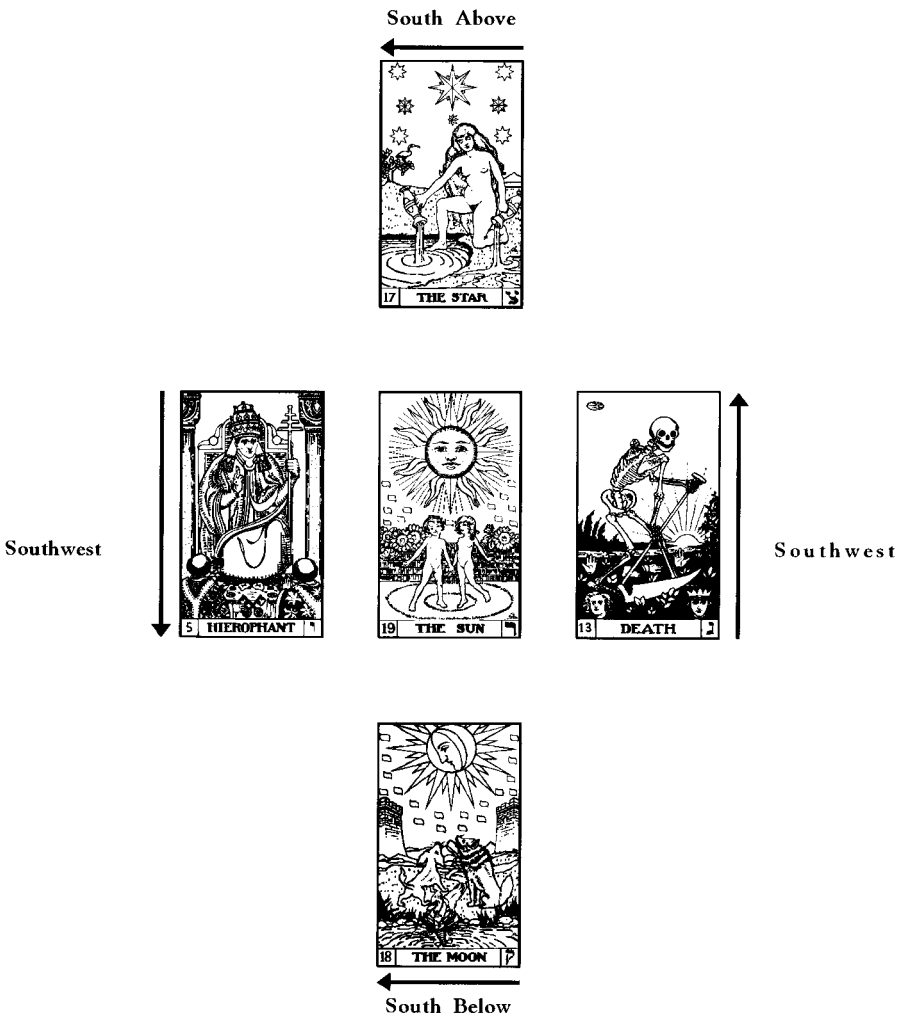

Figure 11. The Southern Face

The perspective of the viewer in relation to the currents is from the north, looking south. The following are the chants for the southern face:

☰	הויה	CC#FC
☷	יוהה	FC#CC
☱	ההוי	CCC#F
☲	וההי	C#CCF

This completes the meditation on the twelve permutations of יהוה, and the binding of the six faces of the Cube of Space.

With the four cardinal faces of the Cube bound, we will find that the other two faces, namely the above and below have also been bound without attention being placed upon them directly. We can, if we chose, perform similar meditations on the above and below faces. They are identical as far as the format is concerned. One difference is that we are not following the flow of the zodiacal year. We are also dealing directly with either self-conscious or sub-conscious forces. The following are the meditations for the above and below faces.

### The Above Face

The above face deals with Tarot Keys 1, 6, 8, 14, and 17. The above face of the Cube is the second of the two faces that have a continual flow of current in the same direction. Theoretically you could travel the above face and never deal with that which is below. The following are the permutations for the above face.

☰	ההוי	CCC#F
☱	היוה	CFC#C
☲	היהו	CFCC#
☷	הויה	CC#FC

The perspective of the viewer is from above the surface of the above face of the Cube. After binding the above face, it would look like this:

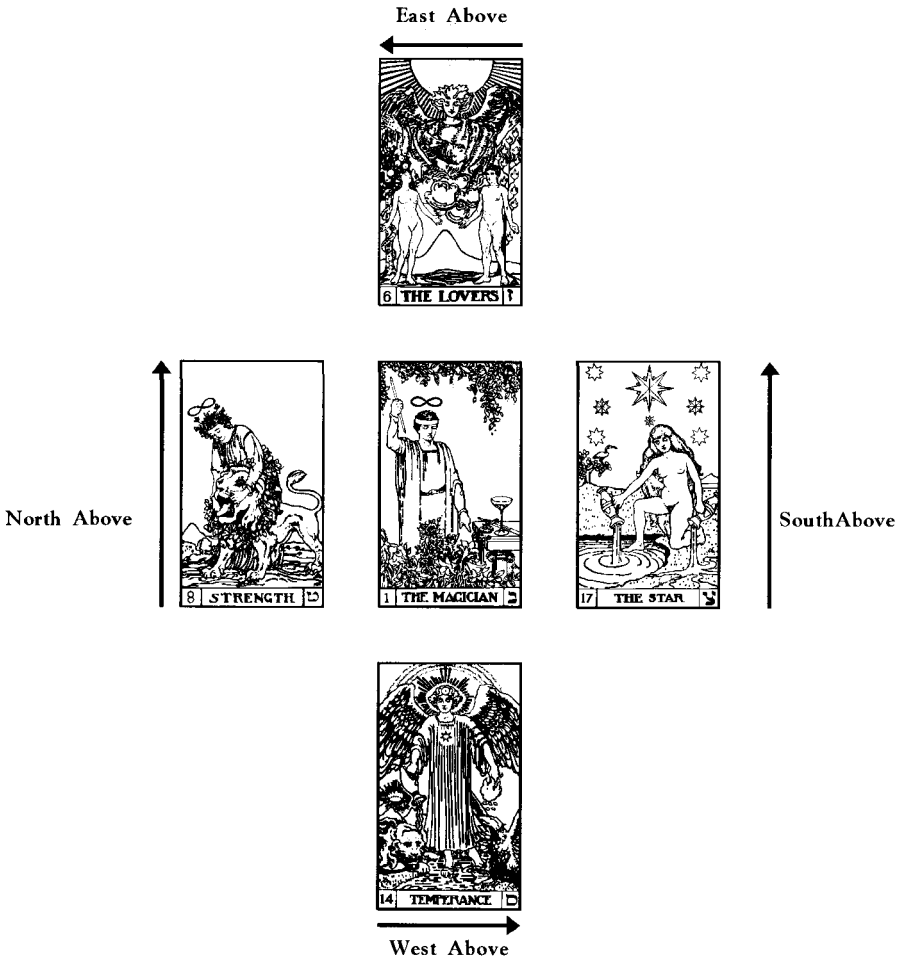

Figure 12. The Above Face

### The Below Face

The below face is concerned with unseen forces, which are the building agents for all manifestation. How the subconscious works is unknown. The fact that it does work has caused natural science to explore the hows and whys for centuries. We know the subconscious mind responds to the suggestions that originate at the self-conscious level. Learning how to give conscious suggestions to the subconscious mind is perhaps the single most important task we are faced with at this particular point in our training.

In this meditation, place Tarot Keys 2, 7, 9, 15, and 18 in the pattern as they would be on the below face of the Cube.

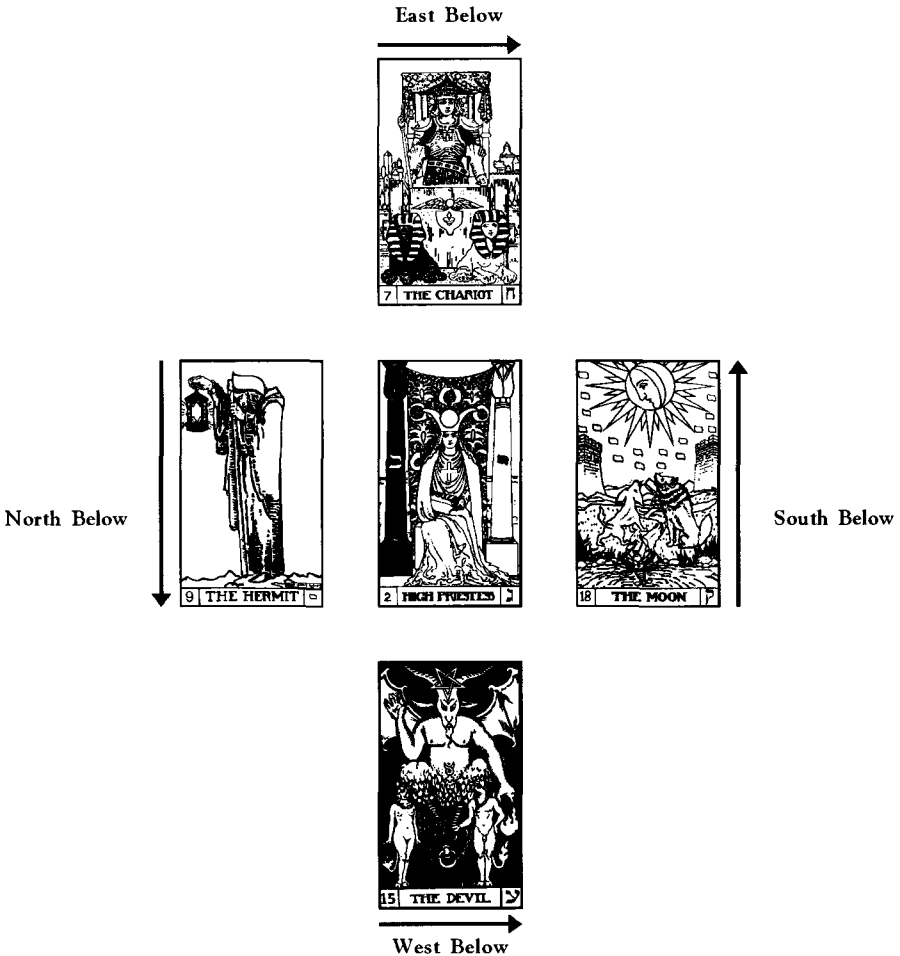

Figure 13. The Below Face

As you can see the currents do not follow the same pattern as the above or eastern faces. The currents of the below face create an imminent collision and finally force the traveler back to the surface at the southeast ascending corner of  $\text{♄}$ . This brings up a very important point concerning the four cardinal directions and their relationship to self-conscious awareness and the subconscious state of being. This will be dealt with later in another series of meditations.



# Chapter III

## Self-Conscious and Subconscious Aspects of the Cardinal Points

This chapter will enter into a study and a series of meditations concerning the self-conscious and subconscious levels of awareness. In the planetary scheme of things, there is only one planet that represents a purely self-conscious level of awareness. The planet is ♀, represented by Key 1 The Magician. Likewise there is only one planet which represents the sub-conscious state. This is the ♂, Key 2, High Priestess. Within the system of Tarot these two keys are distinct symbols for these two modes of conscious expression.

There are four planetary Tarot keys that operate on both levels, and act as links between self-consciousness and subconsciousness. These keys are:

- Key 3 (The Empress), the planet ♀;
- Key 16 (The Tower), the planet ♂;
- Key 10 (Wheel of Fortune), the planet ♃; and
- Key 19 (The Sun), ☉.

Each of these keys participates at the self-conscious and sub-conscious levels. In order to gain a deeper understanding of the two-fold qualities of each of these four keys, we can meditate on their relationships to both states of consciousness. Each of these four keys has one zodiacal sign that links it to the above face, and one sign that links it to the below face. In each of these meditations we will consider the relationship between the linking zodiacal sign, the cardinal planet, and the particular face, above or below, to which it is united.

Before we begin, let us consider that there are four vertical lines on the Cube of Space. Two of them descend from self-consciousness into sub-consciousness. These are represented by Key 4 (The Emperor), ♁, and Key 11 (Justice), ⚖. These two keys represent the currents that connect the above with the below.



There are two vertical lines that ascend from sub-consciousness into self-conscious. These lines are Key 5 (The Hierophant), ☿ and Key 13 (Death), ♁.

For the sake of definition, we will call these four keys Transition Keys for they are the vehicles used to bring us from one state of consciousness to another.

It is interesting to note that the two signs that are descending occur at the equinoxes. In the descending lines of ♃ and ♎, we find one expressing ♂ and the other ♀. ♂ rules the sign of ♃ descending in the northeast, and ♀ rules the sign of ♎ descending in the northwest. It is also interesting that these descending lines occur in the North, the place of greatest darkness. The High Priestess who is representative of several goddesses is the ruler of the underworld and the shades. The underworld is the recipient of the self-conscious forces that descend from the above to the below through the signs of ♃ and ♎.

The two ascending lines of ☿ and ♁ have a similar relationship as do the signs ♃ and ♎. The sign of ☿ is ruled by ♀ and the sign of ♁ is ruled by ♂. ♃ is opposite ♎ in the zodiacal year, as ☿ is opposite ♁. ♂ is also the opposite or complement of ♀. The final polarity is that the ascending lines take place in the southeast and southwest. The south is the place of greatest light. Symbolically the sub-conscious level is the place of darkness while self-consciousness is the place of light.

Before getting into the next series of meditations it would be helpful to look at the keys related to self-consciousness and sub-consciousness. There are five keys that deal specifically with the self-conscious level. These keys are:

- Key 1 (The Magician), ♀ - Above Face
- Key 6 (The Lovers), ♀ - East Above
- Key 8 (Strength), ♂ - North Above
- Key 14 (Temperance), ♂ - West Above
- Key 17 (The Star), ♁ - South Above

Of these five keys only Key 1 holds a planetary signature. The other four are expressing zodiacal intelligences. As we can see from the meditation in Chapter II, concerning the binding of the above face, ♀ is bound by ♀, ♂, ♂, and ♁.

Likewise there are five keys that deal specifically with sub-consciousness. These are:

- Key 2 (High Priestess),  $\text{D}$  – Below
- Key 7 (The Chariot),  $\text{E}$  – East Below
- Key 9 (The Hermit),  $\text{M}$  – North Below
- Key 15 (The Devil),  $\text{S}$  – West Below
- Key 18 (The Moon),  $\text{K}$  – South Below

These are the keys used in the meditation concerning the binding of the below face. Of these five keys, only Key 2 carries a planetary signature, that of the  $\text{D}$ .  $\text{E}$ ,  $\text{M}$ ,  $\text{S}$ , and  $\text{K}$  are the zodiacal intelligences that bind the below face.

What we seek to accomplish through the next series of meditations is to understand as much as possible, the relationships between the four cardinal keys and how they express at the self-conscious and subconscious levels. The below zodiacal signs are the links between the cardinal keys and the subconscious state. The above zodiacal signs are the links between the self-conscious state and the same cardinal keys. We will therefore investigate through the process of meditation, the links that will assist us in harmonizing our relationship between that which is above and that which is below. We will begin our next series of meditations in the east.

### The Empress – Below

As we take a deeper look at Key 3 (The Empress), we can see she is located in the East. This key and the letter  $\text{T}$  are connected to the below face, ruled by the  $\text{D}$  through the agency of The Chariot, Key 7, and the letter  $\text{N}$  the sign of  $\text{E}$ . The eastern face is not the only place that  $\text{F}$  has her influence. To the southeast we can see the sign of  $\text{V}$  rising from the below to the above. In the south below we find  $\text{K}$  flowing into the east from the west.  $\text{F}$  rules the sign of  $\text{V}$  and is exalted in the sign of  $\text{K}$ . At this southeastern below corner there is a convergence of the intelligence of  $\text{F}$ . The major force here is the multiplication of the suggestion that originated on the above face,  $\text{Q}$ . That suggestion descended in the northeast through  $\text{Y}$  and traversed the east below line through the sign of  $\text{E}$ . It is here that the suggestion, which originated in the above, is formed. At the below southeast corner, the

currents of ☽ and ♃ collide. From here the current finds its only path through the ascending line of ♃. It is at this point that the current is forced back into self-consciousness.

There are a couple of ways to approach this meditation. To begin, you could go back to the binding of the eastern face and arrange the keys accordingly. This will assist in contacting the power behind the suggestion originating at the self-conscious level that descends into sub-consciousness. This, however, gives both aspects of The Empress. The link between ♁ and ♄ or the ♃ and the planet ♀ is Key 7 (The Chariot), and the sign of ☽. Our intention here is to meditate upon this link. To begin, place the three keys mentioned in the following order:

- Key 3 (The Empress), ♀;
- Key 7 (The Chariot), ☽; and
- Key 2 (High Priestess), the ♃.



Look at the keys for a few minutes each and then collectively. After a few minutes of observation, intone their notes in the order shown. (F<sup>#</sup>), (D<sup>#</sup>) and (G<sup>#</sup>).

One of the fundamental meanings of Key 3 (The Empress) is organization. The Empress represents the organizing principle and the multiplication of the seed, planted by The Magician. This organization and multiplication occurs on the level represented by the High Priestess. The Empress' organizational function deals with things invisible or interior. After the organizational process, the suggestion that originated in self-consciousness is reflected back to self-consciousness for further elaboration and adaptation.

The Chariot is the vehicle that receives and carries the suggestion.

The suggestion enters into the path of The Chariot from The Emperor. It is developed at the subconscious level, and is delivered to the ascending path of The Hierophant, where it will surface at the self-conscious level.

### The Empress – Above

As Key 7 (The Chariot), was the agency that connected The Empress to the sub-conscious level, so The Lovers (Key 6), the sign of  $\text{II}$  connects The Empress,  $\text{♀}$ , to the self-conscious level  $\text{♃}$  at the above.  $\text{II}$  and  $\text{☽}$  each share a similar relationship to their respective levels in that the  $\text{♃}$  rules the sign of  $\text{☽}$ , and  $\text{♃}$  rules the sign of  $\text{II}$ .

As with the meditation connecting The Empress to the below, we will line up the appropriate keys and meditate on their connections. The keys used here are:

- Key 3 (The Empress),  $\text{♀}$ ;
- Key 6 (The Lovers),  $\text{II}$ ; and
- Key 1 (The Magician),  $\text{♃}$ .

The intonations for the keys and letters in this meditation are: F# (Key 3), D (Key 7), and E (Key 1).



There is an important point to make about the inner connections of these keys. We are concerned with more than the simple connection between a cardinal point and the above and below. There is a circulation of energy that moves throughout the Cube. These currents flow and direct energy toward or away from a particular point on the

Cube. With the meditations on the east above and the east below, we must ultimately include the entire face with the ascending and descending lines, for this is how the intelligences are transferred from the above to the below. The currents are illustrated in Chapter II.

### Wheel of Fortune – Below

The Wheel of Fortune is attributed to the west. It, like The Empress, has a particular relationship to the above and the below. As in the east, the west has one descending line in the sign of ♎ and one ascending line in the sign of ♍.

On the west below we see Key 15 (The Devil), the sign of ♄. This is the line that connects the Wheel of Fortune to the High Priestess. At the subconscious level ♄ becomes identified with the ♃. Thus we find that upon the physical plane, ♄ governs many of the automatic functions of the body. ♄ receives the multiplied seed and brings it to its completion. This completed image may be altered or adapted at a later time according to the discrimination of The Magician. The keys used in this meditation are:

- Key 10 (Wheel of Fortune), ♄;
- Key 15 (The Devil), ♄; and
- Key 2 (High Priestess), the ♃.

The notes for this mediation are: A<sup>#</sup> (Key 10), A (Key 15), and G<sup>#</sup> (Key 2).

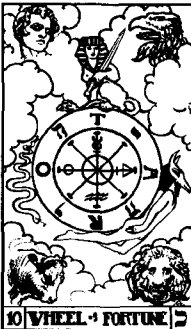

On the Tree of Life you will find a special relationship between

the Sphere of the  $\mathfrak{D}$  and the Sphere of  $\mathfrak{L}$ . Their usual color attributions are reversed so that  $\mathfrak{L}$  receives the color blue and the  $\mathfrak{D}$  receives the color violet.

In the human body at the  $\mathfrak{L}$  center we find the solar plexus in charge of many of the sub-conscious functions of the body, just as the lunar center is in charge of the automatic responses. We also find that the Sphere of  $\mathfrak{K}$ , attributed to  $\mathfrak{L}$  is also related to Divine Memory. Memory is a function attributed to the  $\mathfrak{D}$ .

### Wheel of Fortune – Above

As  $\mathfrak{L}$  is the connecting link between  $\mathfrak{L}$  and the  $\mathfrak{D}$ , so the sign of  $\mathfrak{L}$  is the link between  $\mathfrak{L}$  and  $\mathfrak{K}$ . The main differences between the east and the west are that of the beginning and that of completion. It is interesting to note that  $\mathfrak{L}$  and  $\mathfrak{L}$  are the polar opposites of the eastern signs of  $\mathfrak{D}$  and  $\mathfrak{K}$ .

The following meditation deals with the connection between  $\mathfrak{L}$  and  $\mathfrak{K}$  will use the keys:

- Key 10 (Wheel of Fortune),  $\mathfrak{L}$ ;
- Key 14 (Temperance),  $\mathfrak{L}$ ; and
- Key 1 (The Magician),  $\mathfrak{K}$ .

The notes used in this meditation are: A<sup>#</sup> (Key 10), G<sup>#</sup> (Key 14), and E (Key 1).

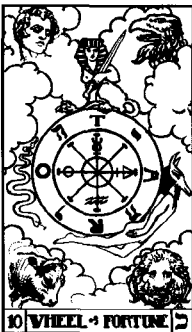

It is important to keep in mind what it is these meditations are accomplishing. First of all, the meditation in the east, which we call

the past, assists us in the process of generating clear creative images which will externally manifest in our lives. In the west, which we call the present, we have the opportunity to evaluate present conditions which are the direct result of past images. From that evaluation we can make the necessary changes to create a more desirable condition in the next cycle of past to present.

The east, as a direction on the cube, is symbolic and relative. There is no place on earth one can stand and not be able to go further east. If you traverse the earth thousands of times you can still travel east. As you watch the sun set in the west, at the same moment another individual, from a different vantage-point, can experience the sun rising in the east.

### The Tower – Below

Key 16 (The Tower), is perhaps one of the most ominous of Tarot keys. I can recall several friends of mine who are students of The Tarot say, "I'm having a Tower experience." All one need do is look at Key 16 and you can understand what they mean by such an expression.

We tend to look at The Tower in terms of chaos and destruction. It is indeed the force that creates such conditions, but the converse of destruction is the force that builds and creates.

There is always due season for each mode of activity. It is our job, as disciples on the Path of Return, to see to it that things happen in our lives in due season. It is neither in our best interest nor in the interest of the development of the world to feel out of control and lost in chaos.

The meditations on the relationships between Key 16 ♂, and the above and below faces of the Cube will assist us in receiving guidance on how to work with the changing seasons in our lives.

The relationship between ♂ and the ♃ is an invisible one. The Life Force which Qabalists call ה"ה is at work in all phases in the One Life's activity. We can always find the results of this invisible work of ♂, but to witness it as it occurs is not possible for the average disciple.

Key 16 is connected to the High Priestess through the agency of Key 9 (The Hermit). The sign of ♃ is attributed to Key 9 and it rules the sub-conscious activity of assimilation. The ♃ region of the body

is the place where the Life Force, which exists in true foods and living water, is extracted and directed into the blood stream for the building and regeneration of the human organism.

The Tarot keys used in this meditation are:

- Key 16 (The Tower), ♂;
- Key 9 (The Hermit), ♄; and
- Key 2 (High Priestess), the ♃.

The notes used are C (Key 16), F (Key 9), and G<sup>#</sup> (Key 2).

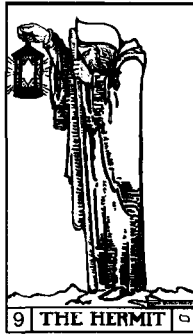

### The Tower — Above

Key 8 (Strength) is the Tarot key that connects Key 16 to Key 1. There are some common symbols in each of these three keys that give hints to the self-conscious aspect of Key 16.

The color attributed to ♂ and Key 16 is red. If we bring our attention to Key 8 we can see a chain of red roses and the Red Lion. In Key 1 we can see the Magician's red robe. The robe is indicative of action and will.

A second symbol that shows up in each of the three keys is the figure 8, or lemniscate. Above the head of The Magician and the woman in Key 8 we see this symbol of infinity. It also represents the prima materia, which travels in vortices and enters into the Sphere of Human Consciousness through the crown center. In Key 16 we can see the arrangement of twelve tongues of flame. This arrangement is in the form of a lemniscate.

To assist in understanding the proper application of these intelligences, place them in the following manner:



- Key 16 (The Tower), ♂;
- Key 8 (Strength), ♀; and
- Key 1 (The Magician), ♀.

The notes for these keys are C (Key 16), E (Key 8), and E (Key 1).



### The Sun – Below

Key 19 (The Sun), is attributed to the south and to the ☉. It is a representation of the completion of the Great Work. The Great Work is performed by the work of the ☉ and ☽ with the aid of ♀. This statement initially lays out the relationship between the self-conscious and sub-conscious process in the south.

Key 18 (The Moon) joins the south to the below. It is attributed to the sign of ♋. ♋ is the sign which deals with the subconscious process of the multiplication of the new idea into cellular consciousness. As this process unfolds there is literally created a New Being. This transformation of the individual is the direct result of self-conscious attention.

Key 18 (The Moon) is on the south below line. This line is a vehicle for the subconscious process attributed to the ☉. In both Keys 18 and 19 we can see the universal “stuff” falling to earth in the form of Yods (⋄). This stuff must become differentiated as it enters into form and thus builds the new creature.

Place Tarot keys:

- Key 19 (The Sun), ☉;
- Key 18 (The Moon), ♋; and
- Key 2 (High Priestess), the ☽.

The notes for this meditation are D, (Key 19), B (Key 18), and G<sup>#</sup> (Key 2).

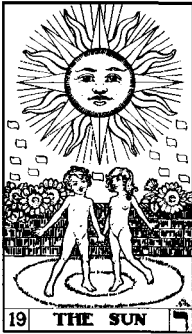

### The Sun – Above

Key 18 is an example of the subconscious process. It governs the functions of the body that are below the level of conscious awareness. As we move our attention to the above southern face of the Cube we find Key 17 (The Star), which is a self-conscious operation. It is the mode of intelligence that governs the process of meditation. This is perhaps the governing Tarot key for the entire work, *Meditations on the Cube of Space*. These meditations have to do with the specific intent to gain knowledge of our relationship to the greater being in which we live.

The letter **ז**, which means fishhook, is attributed to Key 17. A fishhook is a tool used to capture or ensnare certain types of fish. In this case it is trying to ensnare certain types of information that will reveal the path of liberation.

In the south above we are specifically intending to understand the relationship between Key 19 and Key 1. Key 17 is the south above line that connects Key 19 to Key 1. To go into this meditation, place the following keys before you:

- Key 19 (The Sun), ☉;
- Key 17 (The Star), ⚆; and
- Key 1 (The Magician), ♃.

The notes for this meditation are D (Key 19), A<sup>#</sup> (Key 17), and E (Key 1).

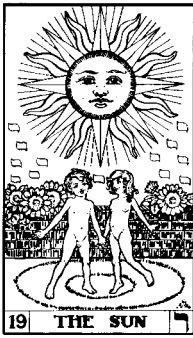

This meditation completes the series connected with the four cardinal directions and the keys and planets that share in both self-conscious and subconscious modes of activity.

In this series, 18 of the 22 Major Arcana were used. These 18 keys make up the external or skeletal structure of the Cube of Space. These are the keys that deal with specific aspects of personality, which are the focus of the Great Work and the process of transmutation. These are the aspects of personality that need to come under the conscious direction of the Central Ego. The other four keys that complete the major trumps are The World, the Hanged Man, Judgement, and The Fool. These keys were discussed in the meditations in Chapter I.

# Chapter IV

## The Law of Polarity

The next few chapters will present a series of meditations that will focus on the law of polarity. The Cube of Space is an exceptional model by which we may explore, and come to a deeper understanding of the law of polarity. The six faces show us three basic polar opposites. These polar opposites go on to develop further subdivisions. The law of polarity applies to everything in the manifested universe. As soon as the process of creation begins, there also by its very nature will be polarity.

The law of polarity is stated thus:

“Everything is dual; everything has poles; everything has its pair of opposites; like and unlike are the same; opposites are identical in nature, but different in degree; extremes meet; all truths are but half-truths; all paradoxes may be reconciled.”

— The Kybalion.

### Planetary Polarity

The first expression of this law can be found in the three mother letters. In **⌘** we have an axis that sets apart that which is above from that which is below. In **⌚** we have the axis which expresses the sunrise or beginning of the day in the east, and the sunset or end of day in the west. The axis of **⌚** is also related to the past and the present. With the letter **⌚** we have the axis of the north and the south which expresses such extremes as heat and cold. Each of these axes was sealed with a particular permutation of **⌚**, and a letter of the Aleph-Beth. Each of the letters occupying a face of the Cube has within its own nature a set of polarities. Thus each of the letters attributed to a face on the cube is designated as a double letter. Each mother letter finds itself to be the reconciling force between the polarities. These letters are:

א

Above    ב = Life and Death  
 Below    ג = Peace and Strife

ב

East     ד = Wisdom and Folly  
 West    כ = Wealth and Poverty

ש

South    ר = Fertility and Sterility  
 North    פ = Grace and Sin

Each of the three mother letters begins at the center in unity. As they are projected into space, a point of tension and thus polarity is created. This is the natural course of events as creation unfolds.

The Emerald Tablet begins with this statement:

“True without falsehood, certain and most true,  
 that which is above is as that which is below and  
 that which is below is as that which is above, for  
 the performance of the miracles of the ONE  
 THING.”

The first set of polarities set up in this little treatise is, that which is above and that which is below. We find a similar occurrence in the first chapter of Genesis where it says,

“ברשית ברא אלהים את השמים ואת הארץ.”

“In the beginning the creative powers of the Life  
 Breath separated the Heavens from the Earth.”

The heavens are that which is above and the earth is that which is below. On the Cube of Space we are specifically dealing with the letter א as it emanates from the center and creates the above and below. This is where ב (♋), and, ג (♌), are located.

The polarity is further compounded by the nature of the double letters, which contain within themselves a polarity. In the above we have Life and Death attributed to ב, and in the below we have Peace and Strife attributed to ג. Let us compare the life and death of the

above to the peace and strife of the below:

<b>Above</b>	<b>Below</b>
Life	Peace
Death	Strife

These comparisons are not brought forth to boggle the mind or try to perform an exercise in futility. If we are to truly understand the power of the reconciliation of opposites, we must look closely at those things that keep us in darkness and misery. The reconciler of the above and below is **⌘**. **⌘** is also attributed to the alchemical principle of **♀**.

The law of polarity continues to show itself in the four cardinal directions in the same vein as did the above and the below. The east and west are polarized in the idea of beginning and ending, planting and harvesting, sunrise and sunset. The planetary genus and letter intelligences are **⌘** (**♀**) in the east and **⌚** (**♄**) in the west. Their polar expressions are:

<b>East</b>	<b>West</b>
Wisdom	Wealth
Folly	Poverty

The reconciler between these two extremes is the mother letter **⌚**. From this letter the two extremes emerge out of unity and through it they are brought into balance. Alchemically **⌚** is attributed to the principle of **⊖**.

The third set of polarities is the south and the north. This is a representation of heat and cold, the known and the unknown. The planetary genus and letter intelligences are, **⌚** (**♂**), in the North and **⌘** (**☉**) in the south. The double attributions for these letters are:

<b>North</b>	<b>South</b>
Grace	Fertility
Sin	Sterility

The reconciling force for these two cardinal directions is the letter **⌚**. Alchemically, **⌚** is attributed to the principle of **♁**. In all three cases, the axes of symmetry originate in unity and expand into diversity and thus into polarity. Each of the mother letters holds the balance

between the extremes. Remember that they are called axes of symmetry.

There is one final set of polarities, and it is one which exists unto itself. This polarity resides at the center of the Cube under the intelligence of  $\aleph$  and the planetary genus of  $\text{♃}$ . The double meaning is Dominion and Slavery. The key to this reconciliation lies within the center itself. When we operate under the guidance of the center, we live from the place of Dominion. When we live on the outside without the guidance of the center, we live in the World of Delusion and Slavery.

### **Meditation on the Above and Below**

Place before you the two Tarot keys assigned to the above and below. These are Keys 1 The Magician, and Key 2 High Priestess. In the occult teaching these two keys represent self-conscious awareness and sub-consciousness. The Magician and the High Priestess operate on different levels yet they cooperate with each other. Self-conscious plants the seeds into the fertile soil of the sub-conscious and from that union manifestation takes place. This manifestation may cause Peace or Strife and Life or Death depending on the level of conscious awareness during the planting of the seed.

Look at the two Tarot keys and see the beauty of each of their functions. One cannot be fruitful without the other. As you place your attention on The Magician intone the note E and visualize the color yellow. Then bring your attention to the High Priestess and intone the note G<sup>#</sup> and visualize the color blue. If you have a small keyboard, allow the notes to blend.



After having looked at Keys 1 and 2, place the key of reconciliation, Key 0, between Keys 1 and 2.



This time as you intone the notes include ☵, and when chanting the E for ☵, make it an octave higher than the E for ☱.



## Meditation

### East and West

After working with the Cube for a while you can begin to figure out what meditations will be next. You will find a system with vast possibilities as we move from place to place around the Cube.

In our meditation on the east and west we will be dealing with The Empress and Wheel of Fortune. These keys express the intelligences of the letters **7** and **2**. Remember that in dealing with the meditation on the east and west you are working with the polarity of sunrise and sunset, beginning and end, past and present. The Empress represents the conditions or events that created the environment for the present reality. Key 10 represents the present reality.

Place Keys 3 and 10 before you.

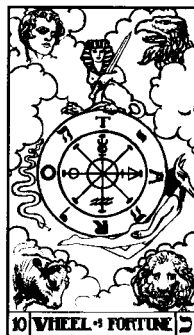

As you enter into this meditation, ask yourself, “what particular images have I held in the past that have brought forth the experiences I am having today? Does my present situation reflect a past that is based on carefully formed thoughts, or does it reflect a condition that is in reaction to the carelessly formed thought?” Meditating on these keys will assist the student in remembering the thought forms of the past, whether positive or negative. When we know what the causes of our present conditions are, we will be in a good position to make the necessary adjustments.

Intone the notes  $F^\#$  and  $A^\#$ . Also visualize the color emerald green for The Empress and violet for the Wheel of Fortune.

To reconcile this polarity take Key 12 (Hanged Man), and place it between Keys 3 and 10.

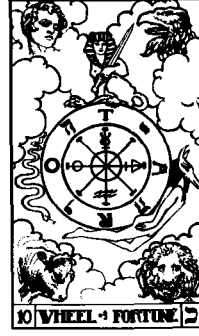
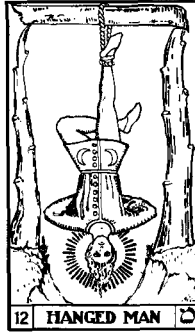

♃, as you know, is the axis that extends from the center to the east and from the center to the west. This is the common unifying thread between ♀ and ♃. The planetary attribution of ♃ is given to ♃. In the sign of ♋, ♃ is a co-ruler and ♀ is the exalted planet. This connection between ♋, ♃, ♃, and ♀, gives us a further hint concerning the deeper meaning anent the polarity between the east and west.

In this phase of the meditation, intone the notes F<sup>#</sup>, G<sup>#</sup>, and A<sup>#</sup>. This will assist you in attuning you to the frequency of these three intelligences.

## Meditation

### North and South

The last of the cardinal polar meditations is the North and the south. This brings our attention to Key 19 (The Sun) and Key 16 (The Tower). As with the previous meditation, place these two keys before you.

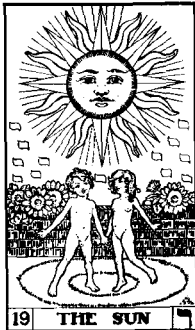

In this polar relationship we have heat and cold, the known and the

unknown, generation and degeneration, construction and destruction. As you meditate on this set of opposites, keep in mind the occult knowledge that you seek that is presently hidden from view. Think of those things in your life which must be built up and those that must be released or destroyed.

Intone the notes D and C. As you chant the note D, see yourself immersed in the color orange. See this color changing from orange to red as you chant the note C. There is a fiery life force or vital principle which exists in all things. It is called **חיה (Chaiah)** in Hebrew, and in alchemy it is called  $\text{♁}$ . It is the animating element we call  $\Delta$ . As we look upon these two planetary intelligences, keep in mind the fact that  $\text{♂}$  is considered to be the expression of **חיה**. The  $\text{☉}$  is that radiant life within which we live and without which we would cease to exist. The reconciler of these two great expressions of the Life Force is  $\text{♃}$ , under the planetary intelligence of  $\text{♀}$ .

In the next phase of this meditation place Key 20 (Judgement) between Keys 19 and 16.

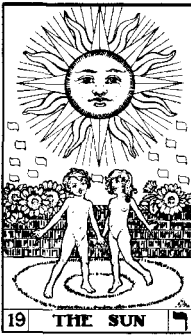

This time as you go to chant the notes of the keys include the note C for Key 20. When including the note for Key 20, use the higher octave of the C that was used for  $\text{♃}$ .

### Dominion and Slavery

At the very center of the Cube of Space rests the letter  $\text{Ⓝ}$ . This is the one letter which has a double meaning but has no polar opposite in terms of direction. We can, however, look to the actual qualities of  $\text{Ⓝ}$  and gain an understanding concerning its polarities. From our understanding of  $\text{Ⓝ}$ , we can find the planet and Tarot key which best express its

polar opposite. In one sense this should be no great mystery for  $\aleph$  is the final letter of the Aleph-Beth. If we look at that which is first we will find the answer.  $\aleph$  represents the 32<sup>nd</sup> path on the Tree of Life. This path is the final stage before the tenth sphere, Malkuth. It represents rest, constriction, limitation and form. Expansion, limitlessness and pure potential express the opposite qualities of  $\aleph$ . These are the qualities of the first letter,  $\aleph$ .

To experience the total freedom that Key 21 represents, which is attributed to  $\aleph$  and the letter  $\aleph$ , we must find the balance from all sense of limitation and the limitlessness of the No Thing. As we join the letter  $\aleph$  with  $\aleph$ , we find that the necessary ingredients for such a balance are present. The point should be made here that  $\aleph$  and  $\aleph$  co-rule the sign of  $\aleph$ . Within this sign and age the balance between form and formlessness must be achieved.

Begin the meditation by focusing your attention on Key 21. See the cosmic dancer moving freely and effortlessly within the Ring Pass Not in which she dances. Visualize the color blue-violet emanating from the core of your being. After a couple of minutes take out Key 0 and place it in front of you. We see The Fool ready for the next adventure in the World of Name and Form. There is a sense of total freedom and possibility. As you place your attention on Key 0, visualize the color yellow entering your body through the breath.



After a couple of minutes take Key 17 (The Star), and place it in front of you. Key 17 is attributed to the sign of  $\aleph$ . In this sign  $\aleph$ , and  $\aleph$ , are co-ruling planets. We can see Key 17 as the reconciler between Keys 0 and 21. Intone the note A<sup>#</sup> and visualize the color violet. After a few minutes place all three keys together and intone

each of the keys (A, E, and A<sup>#</sup>). Feel the sense of the merging of the restrictive power of  $\text{h}$  and the infinite potential of  $\text{h}^\#$ .



This meditation closes the section on polarity concerning the center and six directions in space, which are the above, below; east, west; and north and south.

# Chapter V

## Zodiacal Polarity The Above and The Below

From a zodiacal perspective, there are various combinations of polarity upon the Cube. One such combination can be addressed from above and below. The sign  $\text{II}$  is the above eastern line while  $\text{☉}$  is the below eastern line. These are the signs that connect the East ( $\text{♁}$  –  $\text{♀}$ ) to the self-conscious face ruled by  $\text{♀}$  and the subconscious face ruled by the  $\text{♃}$ . In the west we find the signs of  $\text{♁}$  on the above line and  $\text{♃}$  on the below line.  $\text{♁}$  connects  $\text{♃}$  to the above  $\text{♀}$  and  $\text{♃}$  connects  $\text{♃}$  to the below and the  $\text{♃}$ . In the south we find the signs of  $\text{☉}$  on the above line connecting the  $\text{☉}$  to  $\text{♀}$  and  $\text{♁}$  connecting the  $\text{☉}$  to the  $\text{♃}$ .

Finally we have the north face where  $\text{♁}$  is on the above line, connecting  $\text{♁}$  to  $\text{♀}$  and the sign of  $\text{♃}$  connecting  $\text{♁}$  to the  $\text{♃}$ .

These will be the next series of meditations that we work with. We shall now go back into these combinations and use our knowledge of sound and color in our meditations to gain a deeper understanding of these more complex intelligences.

Let us begin with a meditation that aids in recognizing the first basic polarity, **השמים הארץ** the heavens and the earth or the above and the below.

### Above and Below of the East and West

We begin our work in the east, symbolic of new beginnings. The first signs that express the relationship of above and below are  $\text{II}$  and  $\text{☉}$ . Astrologically these two signs are not polar. They express a type of polarity from the perspective of the above and below. This series of meditations follows a simple format. Because the symbolism of the Tarot is so potent, we can evoke from the subconscious state the necessary knowledge concerning the relationships between these signs.

We begin by focusing our attention on each of the zodiacal keys

and the ruling planet of each sign. Let us begin with the sign of  $\text{II}$ . Place Keys 6 and 1 before you and focus your attention on each key separately for a few minutes. After observing them, chant the notes attributed to the keys. They are D and E. The colors are orange and yellow.  $\text{II}$  is representative of the above eastern intelligence and the element of  $\Delta$ .



The next phase of this meditation deals with the below eastern line of  $\text{☿}$ . Place Key 7 and Key 2 before you.



The notes for these keys are D $\sharp$  and G $\sharp$ . Key 7 is attributed to the element of  $\nabla$ . If we refer to Genesis 1:2 we read,

“ורוח אלהים מרחפת על פני המים”

“and the spirit of God hovered above the waters.”

On the eastern face of the Cube of Space, we have a symbolic representation of this creative act in the  $\Delta$  of  $\Pi$  hovering above the  $\nabla$  of  $\text{Shema}$ .

From the perspective of the Tree of Life, Keys 1, 2, 6, and 7 are deeply connected. Both Keys 1 and 2 flow from a single source: the Sphere of **כתר**. Key 1 flows into the Sphere of  $\text{ה}$ , while Key 2 flows into the Sphere of the  $\odot$ . Both Keys 6 and 7 flow from the Sphere of  $\text{ה}$ ; but they flow out of it into the respective spheres of the  $\odot$  and of  $\text{♂}$ . The following diagram demonstrates this.

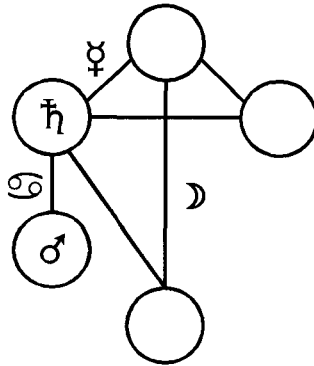

Figure 14.

We can see a deep meaning between the symbols of the Cube, the creation of Genesis, and the flow of the creative forces as they descend the Tree of Life.

For the next phase of this meditation, place before you Keys 6 and 1, above 7 and 2. After focusing on each of these keys, chant the blended notes. Also place close attention to the flow of mezzalah on the Tree of Life.





### Above and Below in the North

The next meditation is with the above and below of the North. This involves the signs of  $\text{♈}$ , ruled by the  $\text{♁}$  and  $\text{♍}$ , ruled by  $\text{♃}$ . The format of the meditation is the same. We begin with our attention on Keys 8 and 19.

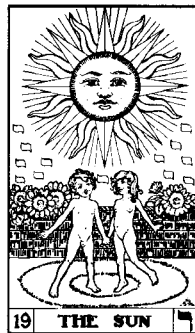

The notes for these keys are the same as those in the meditation on the above east line of  $\text{II}$ . In this meditation they are in reversed order. The notes are E and D.  $\delta\Omega$  is a fixed  $\Delta$ , and symbolizes the Divine Ego as it is expressed through the personality. As this above line flows with the currents of the above face, that which has been revealed from the below becomes integrated in the personality.

On the below face of the Cube we have the sign of  $\text{M}$ , which is a mutable  $\nabla$ . It is in this sign that the subtle forces represented by the yods falling in Key 19 become integrated within the physical structure of the human body. Place Keys 9 and 1 before you.

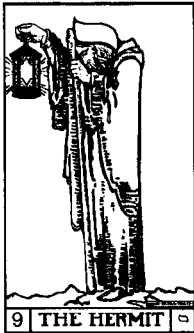

The notes for this phase of the meditation are F and E. There are scores of references to the oneness of  $\text{♀}$  and the  $\odot$  in many esoteric systems. In this meditation we are working at synthesizing these two closely related aspects of consciousness. In this phase of the meditation place the keys over each other as shown.

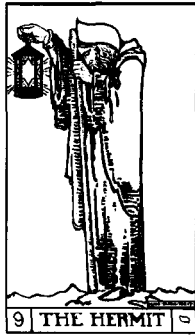
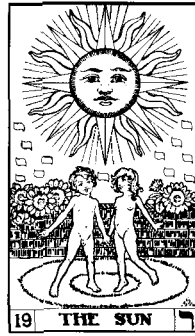

After a few minutes of focus, sound the appropriate notes as before.

### Above and Below in the West

The next meditation will focus on the western lines of the above and below. This involves the signs of  $\text{♄}$  and  $\text{♆}$ . Key 14, symbolic of  $\text{♄}$ , is on the west above line where  $\text{♄}$  is the ruler. On the below line we have Key 15, symbolic of the sign of  $\text{♆}$ , where  $\text{♄}$  is the ruler. In this meditation we are dealing with the power of restriction and limitation, blended with the power to expand. As we have mentioned before,  $\text{♄}$  creates the limiting form and  $\text{♄}$  fills it. Also keep in mind that we have a representation of the Dweller at the Threshold on the below, and the Solar Angel at the above.

Place Keys 14 and 10 before you. Focus your attention on each key. After a few minutes sound the notes which are  $G^\#$  and  $A^\#$ .

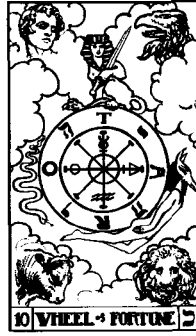

For the next phase of this meditation bring your attention to Keys 15 and 21.

After focusing your attention on each key sound the note A for each of the two keys.



The major point of union between these above and below keys is the recognition that all that we fear—all that we resist are the gifts and blessings of the Solar Angel who first presents himself as the Dweller. As in the east, north, west, and as we will see, the south, each pair of signs that are above and below follow each other in the zodiacal year. ♄ follows ♀, ♃ follows ♁, ♀ follows ♁, and ♃ follows ♄. Each of the below signs follows that which is above. This symbolically represents a fundamental law of occultism: that the subconscious mind is amenable to suggestion. In this particular meditation

we find that both  $\text{♁}$  and  $\text{♂}$  join each other at the darkest hour of the year. This is a reminder that as we face the Dweller, who is really our Solar Angel, our time of spiritual crisis is the advent of the dawning of the light.

To reinforce this suggestion, place both pairs of keys before you. Follow the pattern of focusing on each key, followed by the chanting of the notes. The Dweller and the Solar Angel are One.

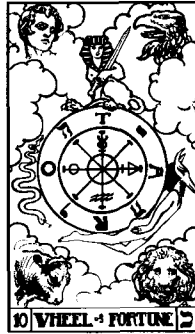

### Above and Below in the South

The final meditation on the above and below zodiacal polarities is in the south. This involves the south above line of  $\text{♋}$  and the south below line of  $\text{♏}$ .  $\text{♋}$  is co-ruled by  $\text{♃}$  and  $\text{♅}$ .  $\text{♏}$  is co-ruled by  $\text{♄}$  and  $\text{♆}$ . We begin this meditation by placing Keys 17, 21, and 0 before you. Following the usual format, focus on each key for a few minutes, followed by the chanting of the notes. The notes in this phase are A<sup>#</sup>, A, and E.



The second phase of this meditation involves the south below line of  $\aleph$ . Place Keys 18, 10, and 12 before you. After the regular few minutes of focusing on each key, chant the notes B, A $\sharp$ , and G $\sharp$ .

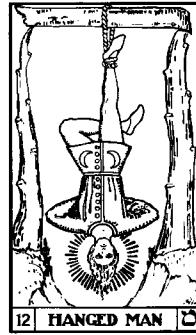
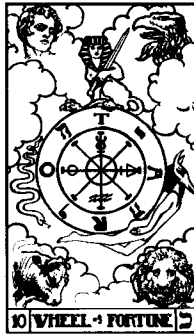
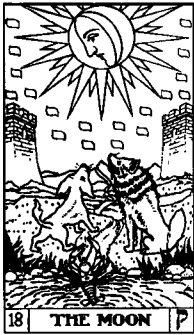



# Chapter VI

## Polarity and the Zodiacal Year

There are six obvious sets of polarity within the twelve signs of the zodiac. These polarities are based on their placement throughout the zodiacal year, and can be quickly recognized through the cardinal fixed and mutable crosses. Anyone familiar with astrology will know these combinations. I will include them here for a quick reference.

♈	—	♏
♉	—	♍
♊	—	♎
♋	—	♌
♌	—	♍
♍	—	♎

One of the doctrines of the law of polarity is that when you work with a particular energy you will always evoke its complement. This is a natural phenomenon. You can verify this by working with colors. If you look at a red object and place your attention on it for a minute or so and then close your eyes you will see the color green. This will correlate back to the idea that each of the zodiacal signs has a color and sound attribution. Red and green are the colors attributed to ♈ and ♏.

There is another series of zodiacal relationships that are not polar, but are worthy of meditation. These relationships deal with signs that are ruled by the same inner planet. In alchemical literature this has been called the alchemical sky. The following is a list of these signs and planets.



### The Alchemical Sky

(☉) + ♈	—	♁ + (♃)
(☽) + ♎	—	♂ + (♀)
(♀) + ♍	—	♉ + (♊)
(♂) + ♌	—	♊ + (♈)
(♃) + ♁	—	♈ + (♃)
(♊) + ♌	—	♌ + (♊)

We can show the relationships of these signs and planets placed around a globe. Although we will not go into the meditations concerning the alchemical sky, they are given here for your further exploration. Meditation upon these signs offers an opportunity to gain understanding concerning various astrological aspects. They are:

☉	♈	Semi Sextel	♁	♃
☽	♎	Square	♂	♀
♀	♍	Inconjunct	♉	♊
♂	♌	Inconjunct	♊	♈
♃	♁	Square	♈	♃
♊	♌	Semi Sextel	♌	♊

This model of the alchemical sky can be seen in the following manner.

## The Alchemical Sky

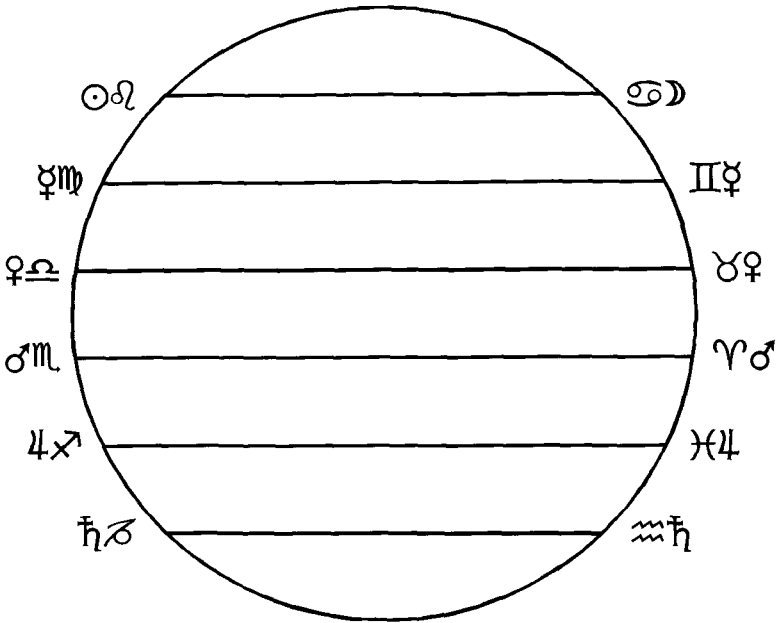

Figure 15.

The only planets that do not operate in two signs are the ☉ and the ☾. However in this model they sit in opposition to each other, even though the signs ♌ and ♏ are successive in the zodiacal year.

## Meditations on Zodiacal Polarity

As mentioned earlier, there are six pairs of opposites in the zodiacal system. The Cube shows these pairs of opposites by the placement of the signs on boundary lines that are opposite to each other on the Cube. The first of these pairs of opposites are ♃ and ♎. These signs are placed on the northeast and northwest vertical lines. Before we enter into the meditation on the polarity of ♃ and ♎ let us consider the implications of what we are working with.

First of all ♃ and ♎ occur during the Vernal (Spring) and Autumnal Equinoxes. ♃ occurs at the Spring Equinox. This is the point of the year where the ☉ is directed toward the greatest light. The manifestation of this greatest light occurs during the Summer Solstice as the sun enters the sign of ♋. ♎, at the Autumnal equinox, directs the ☉ from equal day and night to the point of greatest darkness. The point of greatest darkness occurs during the Winter Solstice as the ☉ enters the sign of ♏.

Because both ♃ and ♎ are cardinal signs, it is important to see these signs as initiating energies. The specific polarity manifested between these two signs is the movement toward the light or movement toward the darkness. These signs set up a directional flow which can be viewed as centrifugal or centripetal. In the Spring we tend to become expansive and outgoing, where in the Fall we tend to move inward and back toward the center.

Another set of polarities within these two signs is that of beginning and end. ♃ is located in the east. The east represents the beginning, such as the beginning of the planting of a garden. ♎ is in the west and represents the harvesting of that which was planted in the sign of ♃. We have investigated similar sets of polarity with the planets in Chapter IV.

Another consideration from the point of polarity is in the ruling and exalted planets of these two signs. The sign of ♃ is ruled by ♂. The sign of ♎ is ruled by ♀. Both of these rulers have the same musical note and color that their sign has. ♂ is red as is ♃, and ♀ is green as is ♎. As we meditate on these two Keys, The Emperor and Justice, let us keep in mind the balancing of forces which is taking place within these two signs.

The exalted planets in these two signs are the ☉ and ☿. Alchemically they are represented by gold and lead. The exaltation of the ☉ can be seen as the directing of the ☉ towards the greatest light. The

exaltation of  $\hbar$  can be seen as directing the  $\odot$  towards the greatest darkness.  $\hbar$  rules the sign of  $\mathcal{B}$  where the moment of greatest darkness occurs. Notice that  $\sigma$  rules  $\Upsilon$  and is also exalted in the sign of  $\mathcal{B}$ —the time of greatest darkness.

### Meditation on $\Upsilon$ and $\mathcal{B}$

First look Key 4, then Key 11 separately. Then take Key 4 (The Emperor), Key 16 (The Tower), and Key 19 (The Sun), and place them before you. Intone the notes C, C, and D.



After a couple of minutes set these keys aside and place Key 11 (Justice), Key 3 (The Empress), and Key 21 (The World), before you.



Intone the notes  $F^\sharp$ ,  $F^\sharp$ , and A. After a few minutes take the first set of keys and place them above the second set being sure to place The Emperor over Justice, The Tower over The Empress, and The Sun over The World.

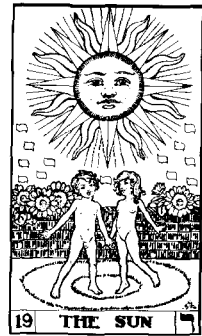

Place your attention on the fact that each of the keys over or under one another is the complement or polar expression in this particular case.  $\mathcal{V}$  is opposite  $\underline{\Omega}$ ,  $\sigma$  opposite  $\mathcal{F}$ , and the  $\odot$  opposite  $\ddot{\eta}$ .

This time as you chant the notes combine the chants. For example as you chant  $\eta$  and  $\mathcal{L}$  chant C for  $\eta$  on Ah and F# for  $\mathcal{L}$  on Oo-Um. After chanting this three times move on to  $\mathcal{D}$  and  $\mathcal{T}$  and follow the same procedure. After completing this section do the same for  $\mathcal{T}$  and  $\mathcal{N}$ . Notice the difference in quality with these two notes as they are sounded together.

### The Signs of $\mathcal{Y}$ and $\mathcal{M}$

The signs of  $\mathcal{Y}$  and  $\mathcal{M}$  are located in the south as opposed to the North. They have a similar relationship as do  $\mathcal{V}$  and  $\underline{\Omega}$ . This has to do with the fact that  $\mathcal{Y}$  is in the east and  $\mathcal{M}$  is in the west. This immediately tells us that  $\mathcal{Y}$  represents the beginning of something in relationship to  $\mathcal{M}$ , and  $\mathcal{M}$  represents the completion of

something in relationship to  $\text{♃}$ . Instead of dealing with the equinoxes, we shall be examining the cross quarters. The cross quarters are very interesting times of the year. They represent the midpoints between balance and polarity—that is between the equinoxes and the solstices. In the sign of  $\text{♃}$  we have the feast of Beltane, and in the sign of  $\text{♁}$  we have the feast of Samhain. These are the midpoints between balance and greatest light and balance and greatest darkness.

Like the signs of  $\text{♋}$  and  $\text{♌}$  here we have a ♀ and ♂ polarity. ♀ rules the sign of  $\text{♃}$  and ♂ rules the sign of  $\text{♁}$ . These two cross quarters also represent a form of polarity because Beltane represents fertility and impregnation and Samhain represents death. In the Celtic tradition we have May Day, The Feast of the Bright Mother and in the Fall we have the Feast of All Souls Day.

In the sign of  $\text{♃}$ , ♀ is ruler and the  $\text{♃}$  is exalted. In  $\text{♁}$  we have the rulership of ♂, with ♀ the co-ruler. In addition to the rulers of  $\text{♁}$ , we also have the exaltation of  $\text{♁}$  in  $\text{♁}$ .

### Meditation on $\text{♃}$ and $\text{♁}$

We begin like the last meditation by taking the first set of symbols and chanting their musical notes. The first, then, are Key 5 (The Hierophant), Key 3 (The Empress), and Key 2 (High Priestess).



The letter  $\text{Ⓜ}$  is given to the sign of  $\text{♃}$ ,  $\text{♄}$  to ♀, and  $\text{♃}$  to the  $\text{♁}$ . The notes respectively are  $\text{C}^\sharp$ ,  $\text{F}^\sharp$ , and  $\text{G}^\sharp$ . After focusing on the keys for a few minutes, replace them with the other set: Key 13 for  $\text{♁}$ , Key 16 for ♂, and Key 20 for ♀.

The notes for these keys are G , C, C and E.



After a few minutes place the first set of keys over the second set in the same way as in the first meditation.



Like the first meditation we will begin the chant by chanting “Ah” with the first key above (Key 5), and completing with “Oo Um” with the key below (Key 13). Repeat the same process with Keys 3, 16, and 20. Close with Keys 2 and 0. As with the first meditation, each set of keys will be chanted three times.

### The Signs of $\Pi$ and $\bowtie$

On the Cube of Space the sign of  $\Pi$  is located on the east above line traveling from south to north and the sign of  $\bowtie$  is on the west

above line traveling from north to south. This zodiacal axis is the only one that has no exalted rulers. In  $\text{II}$ ,  $\text{♀}$  is the ruler. In  $\text{♄}$  we have the rulership of  $\text{♄}$ . In Tarot we find Key 6 symbolizing the sign of  $\text{II}$  and Key 14 symbolizing the sign of  $\text{♄}$ . Keys 6 and 14 each bear angels as their central figure. They are the Angles  $\text{רפאל}$ , Raphael, and  $\text{מיכאל}$ , Michael. The influence from a third angel is added from a stream of consciousness that runs beneath the surface between the north and south. This stream of consciousness is the axis of  $\text{ש}$ , and is represented by Key 20 (Judgement) and the Angel  $\text{גבריאל}$ , Gabriel. So we find in this directional flow three of the four cardinal archangels represented. We also find that the line of  $\text{II}$  travels towards the north and the line of  $\text{♄}$  travels from the north. The north is the cardinal placement of the Angel  $\text{אוריאל}$ , Auriel.

These archangelic forces bring us to the unknown, which is located in the North. Through the agency of the Holy Guardian Angel we may enter the North, receive that which we seek, and under the guidance of the Holy Guardian Angel, that which is unknown may be revealed to self-consciousness.

### Meditation on $\text{II}$ and $\text{♄}$

Take the first pair of Tarot keys, which will be Keys 6 and 1, and place them before you. As you focus your attention on these two keys chant D for Key 6 and E for Key 1.



After spending a couple of minutes with these two keys focus your attention on their polar opposites. These are Keys 14 Temperance, and Key 10 (Wheel of Fortune). The notes for these keys are  $G^\#$  for Key 14 and  $A^\#$  for Key 10.



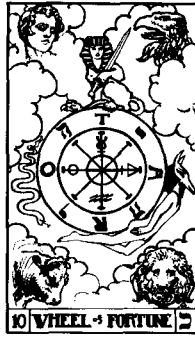

After chanting the notes for the above west and spending a few moments with these keys, place Keys 6 and 1 above Keys 14 and 10. Follow the same procedure as before. Focus on the keys and chant their notes.

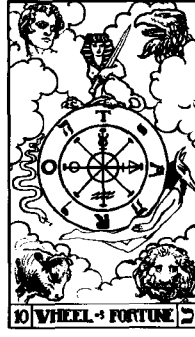

The Signs of ♄ and ♃

In the first meditation on ♋ and ♎ our focus was on the points of balance, namely the equinoxes. The meditation on the polarity between ♍ and ♊ has to do with the extremes of greatest light and greatest darkness. When the ☉ moves into the sign of ♍ it reaches its highest level of expression for the year. It is interesting to note that the ruling planet for ♍ is the ♃. We might assume that the ☉ would rule the sign in which it reaches its most intense expression. When the ♃ is full in the sign of ♍ we truly have the greatest greatest expression of light in the darkness.

In the sign of ♊ we have the opposite effect. The extreme is that of greatest darkness. There is one common theme between these two signs. This has to do with the idea of slowness. When the pendulum is at the furthest point of its swing it actually comes to a halt. This is like throwing a ball into the air. As the ball reaches its maximum height, it stops and then begins its descent towards the earth. So it is with the solstices.

This point of apparent slowness and even stopping explains one of the mysteries concerning the Winter Solstice and Christmas. Individuals have often wondered why Christmas does not fall on the solstice. It endures for a period of three days in which the sun appears to stand still before moving northwards. After the so-called “descent into hell” the sun begins its journey into the light.

The movement from darkness to light is a movement from extreme to mean, and again to extreme. Before this swing can reach the opposite pole it will pass through the point of perfect balance which we call the equinoxes. This is not a point of rest, but the time of greatest acceleration. It is at the equinoxes where the apparent speed of the ☉ is the greatest. It must be this way, for if we were to sustain the point of equilibrium the manifested world would cease to exist.

### Meditation in ☉ and ♂

Begin the meditation by placing the keys for the sign of ☉ before you. These are Key 7 (The Chariot), Key 2 (High Priestess), and Key 10 (Wheel of Fortune). These represent ☉, the ♃, and ♄ respectively.

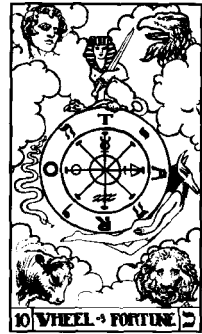

The notes for these keys are D<sup>#</sup> for ☉, G<sup>#</sup> for ♃ and A<sup>#</sup> for ♄. After a few minutes of observing these keys, intone the notes. Look at these three keys and visualize the great power of the ☉ during the time of the sign of ☉. Feel the brilliance of the full ♃, as well as the long duration of the days. This is the moment of the ☉'s greatest power.

For the next part of this meditation place Keys 15, 21, and 16 in front of you. This is the time of greatest darkness. This is the hour of ♄.



After a few minutes of looking at the keys, intone their notes which are A for ♂ and ♄, and C for ♂. In this particular part of the meditation we are getting in touch with the time of the year of greatest darkness. This is the time when we tend to go inward and become

more “reflective”. During the cold dark months we tend to take stock of ourselves and inwardly face the Lord of Karma. This is a much different approach to life than during the Summer Solstice, which tends to be more outwardly focused.

After a couple of minutes of focusing on these keys, bring the six keys together in combination.

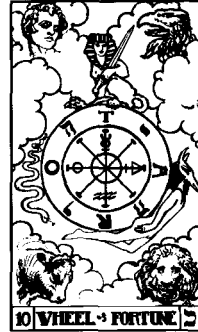

Pay particular attention to this meditation, for it assists us in understanding the mystery of light and darkness within the cycles of the year.

### The Signs of ♋ and ♍

These two signs have a similar function as those of ♈ and ♎. That is, they are signs governing the cross quarters. In the case of ♋ and ♍, they are the cross quarters of Winter and Summer. Notice that the four fixed signs of the zodiac occur during these times of the year. The cardinal signs deal specifically with equilibrium and extreme, while the fixed signs occur during the cross quarters.

In this particular meditation we are dealing with a familiar set of rulers. As we discussed earlier in the  $\Upsilon$  and  $\underline{\Omega}$  polarity,  $\Upsilon$  leads the  $\odot$  towards its full expression and  $\underline{\Omega}$  leads the  $\odot$  towards greatest concealment. This is accomplished through the exaltation of the  $\odot$  in  $\Upsilon$  and the exaltation of  $\text{ḥ}$  in the sign of  $\underline{\Omega}$ .

In the case of  $\delta\lambda$  and  $\text{𐌆}$  we find that the  $\odot$  is the ruler of  $\delta\lambda$  and  $\text{ḥ}$  is the ruler of  $\text{𐌆}$ . You will also notice that the  $\odot$  is the ruler and exalted planet in the time of growth, renewal, and greatest light, and that  $\text{ḥ}$  is the exalted planet and ruler during the time of degeneration, death, and greatest darkness. This phenomenon is perhaps one of the greatest keys in understanding the books on alchemy or the conflict between the forces of light and darkness as portrayed by the Christ and Satan. It is interesting to see that the birth of the Christ is during the time of greatest darkness. Alchemically this deals with the transmutation of lead,  $\text{ḥ}$ , into gold,  $\odot$ .

There is a very strong  $\text{Ḥ}$  connection in this meditation. We find it in relationship to Key 8 and Key 19. Even though Key 8 represents the sign of  $\delta\lambda$ , the note and color for Key 8 is the same as that of Key 1 (The Magician). This tells us that on a vibratory level, Keys 1 and 8 are closely related. We see similar correspondences to this sameness on the Tree of Life where the color attributions are switched from **תפארת** to **הוד**. Since the colors given to the spheres are switched, orange given to the Sphere of  $\text{Ḥ}$  and yellow given to the Sphere of the  $\odot$ , we can see a subtle teaching given about their closeness in operation. This closeness has to do with consciousness. In Key 8 we are dealing with the process of changing the predominant force of the animal nature into a useful tool directed by self-conscious awareness. From this point of direction, we become, in ever-greater capacity, able to express the super-conscious impulse. The suggestion originates at the self-conscious level, is carried out at the sub-conscious level, and is reflected back to the self-conscious level.

The exaltation of  $\text{Ḥ}$  in the sign of  $\delta\lambda$  speaks to the surfacing of intuition, or Buddhi. This state is the true revealer of the great mysteries. These mysteries are revealed to our awakened state for the active manifestation of superconsciousness in the world of every day. These mysteries are available for conscious **DIGESTION** to those who are willing to take on this work of transformation. Digestion is the alchemical process attributed to  $\delta\lambda$ .

On the other pole of this axis we see the exaltation of  $\text{Ḥ}$  in the

sign of  $\text{☉}$ . This is a further expression of the working of consciousness in relationship to the manifestation of the light. As we saw in the sign of  $\text{♁}$ , we have the color yellow and the note E.

There are two prominent alchemical symbols in the sign of  $\text{☉}$ . The first being  $\text{☉}$  itself, the second being that of  $\text{♀}$ .  $\text{☉}$  is attributed to the alchemical operation of dissolution. The symbol for  $\text{♀}$ , on the other hand, is both an alchemical principle and one of the seven metals. We must be careful not to confuse one with the other.

If we place our attention on Key 10 (Wheel of Fortune), we find these two symbols on the vertical axis at the center of the key.  $\text{♀}$  is on the above and  $\text{☉}$  is on the below portion of the same axis. This shows us the exaltation of  $\text{♀}$  in the sign of  $\text{☉}$  as well as the need for self-conscious direction in the meditative process, to which the symbol  $\text{☉}$  represents.

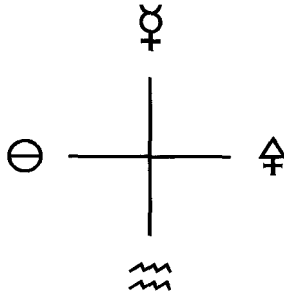

Figure 16.

It is  $\text{♀}$  which baits the hook ( $\text{♁}$ ), which pulls the fish ( $\text{♃}$ ), from the depths of the sub-conscious  $\text{▽}$ . Through the process of meditation, we can experience the power of super-consciousness ( $\text{♁}$ ). This power is reflected to conscious awareness through the agency of sub-consciousness. This is verified through the exaltation of  $\text{♁}$  in the sign of  $\text{♁}$  and the co-rulership of  $\text{♁}$  with  $\text{♁}$  in the sign of  $\text{☉}$ . On the Cube of Space we can see this process unfold in the southwest corner as the three modes of consciousness: sub- ( $\text{♁}$ ), self- ( $\text{♀}$ ), and super- ( $\text{♁}$ ), are united as the super-conscious intelligence rises from the below face. As super-consciousness rises it receives the influence of  $\text{♁}$  in  $\text{♁}$ . This intelligence rises and flows through the sign of  $\text{♁}$ . The following diagram demonstrates this.

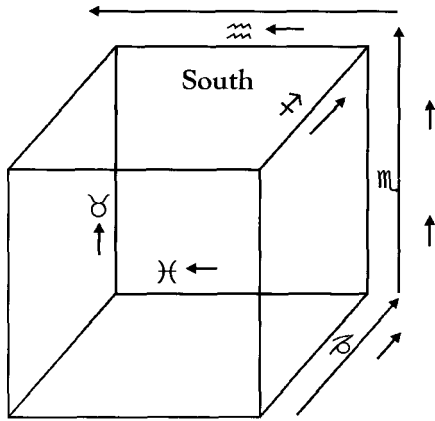
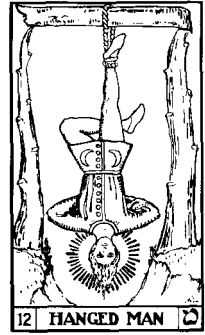

Figure 17.

Meditation on ♃ and ♁

This meditation begins as the others. Place Key 8 (Strength), Key 19 (The Sun), and Key 12 (Hanged Man), before you.



After a few minutes chant the notes associated with the three keys: E for Key 8, D for Key 19 and G# for Key 12.

For the next part of this meditation, place Keys 17, Key 21, Key 0, and Key 1 before you. After a few minutes of focusing on these keys chant the notes attributed to them.



The notes for these keys are A<sup>#</sup> for Key 17, A for Key 21, E for Key 0, and E for Key 1. One revelation concerning the workings of super-consciousness is the presence of Key 0 in this darker time of the year. There is a sense of a boost of explosive power to bring things into the greater light:

“A light that shines in the darkness, but the darkness comprehended it not.” — John 1:5

We now combine the axes of ♈ and ♎ by placing the keys over each other.

In this particular meditation we find that ♎ (♁) connects both of these zodiacal signs on the above face of cube.





ה̄ and ו̄ are the co-rulers of ♁ and ♃ is the exalted planet in ♈. Together א, מ, and ת spell the word אמת, meaning stability and truth. If arranged differently, we have the word, מאת, the feather of truth, against which all hearts must be weighed. Each of these three letters is located at the center of the Cube.

The letter כ, which is given to Key 19, holds the color of the sphere of ♀ and is frequently attributed to the Sphere of הוה. All of this boils down to a tremendous influence of the ♀ intelligence whether dealing with the personality of ♈ or the collective community of ♁.

### The Signs of ♍ and ♋

The signs of ♍ and ♋ are the last pair of opposites in this series on zodiacal polarity. These signs border the below face in the north and the south. They are therefore in the domain of the sub-conscious mind. The mutable signs of ♈, ♍, ♎, and ♋ do not govern any of the major critical points of the year as do the cardinal or fixed signs. The cardinal signs rule the equinoxes and solstices, and the fixed signs govern the cross quarters. The mutable signs represent the waiting period before each of the equinoxes and solstices. The sign of ♍ leads up to the Fall Equinox and the sign of ♋ leads up to the Spring Equinox. As these astrological signs occur in the year, the movement of the ☉ is accelerated. The timing of the mutable signs gives us a sense of the mutable quality itself. Mutability is moldable, pliable and relatively undetermined.

The sign of ♍ is interesting from the perspective of the old astrology because it is the only sign that is both ruled and exalted over by the same planet. That planet is ♀. There is a very strong presence of self-consciousness in the sign of ♍, yet the sign itself functions on the sub-conscious level. The ♍ presence in the north below blends the qualities of ♂ and the ♃. On the Cube of Space the sign of ♍ also receives two lines of intelligence: one in the east through the sign of ♃, and the other in the west through the sign of ♁. We find the sign of ♍ being influenced by the movement of the ☉ towards the light where the ☉ is exalted in ♃. We also find the ☉ moving towards the darkness where ה̄ is exalted in the sign of ♁.

We can see that the mutability of the sign of ♍ is influenced by each of the two cardinal points, ♃ and ♁. These signs direct the ☉ towards its extremes of expression.

The sign of  $\mathfrak{H}$  is located on the opposite side of the Cube in the south below. Like the sign of  $\mathfrak{M}$ ,  $\mathfrak{H}$  partakes of the influence of the  $\mathfrak{D}$  because of its placement in the below. Instead of  $\mathfrak{S}$ , however  $\mathfrak{H}$  partakes of the intelligence of the  $\mathfrak{O}$ .  $\mathfrak{M}$  receives the influence of  $\mathfrak{V}$  and  $\mathfrak{U}$ , while  $\mathfrak{H}$  does not receive any direct impact from the signs originating in the above face. Of the four signs binding the below face of the Cube of Space,  $\mathfrak{H}$  is the most difficult to access.

The sign of  $\mathfrak{E}$  can be accessed by the sign of  $\mathfrak{V}$  as can the sign of  $\mathfrak{M}$ .  $\mathfrak{S}$  can be accessed directly by the sign of  $\mathfrak{U}$ . The only direct access to the south below line of  $\mathfrak{H}$  is through the sign of  $\mathfrak{S}$ . Traveling through the sign of  $\mathfrak{S}$  does not guarantee entrance into the sign of  $\mathfrak{H}$ . There is an escape hatch in the sign of  $\mathfrak{M}$  which rises at the termination of the line of  $\mathfrak{S}$ . One must experience and confront the "Dweller on the Threshold" before entering into the final stage of the Great Work.

In the sign of  $\mathfrak{H}$  we have the planets of  $\mathfrak{L}$  and  $\mathfrak{P}$  co-ruling, and  $\mathfrak{F}$  exalted. These three ruling and exalted planets represent the entire axis of the east and west.  $\mathfrak{P}$  is the line that travels from the center to the east, and from the center to the west. The eastern face is governed by  $\mathfrak{F}$  and the western face is governed by  $\mathfrak{L}$ . This configuration unlocks the secrets of past, present, and future.

Since the sign of  $\mathfrak{H}$  is attributed to the letter  $\mathfrak{P}$ , we find that the south below is involved with the building and refinement of the physical body in which dwells the central ego. Creating the environment within the physical body where conscious contact with the central ego may be made is the work of  $\mathfrak{H}$ . The revelation of what occurs on the subconscious level through the sign of  $\mathfrak{H}$  is brought into consciousness through the sign of  $\mathfrak{O}$  at the southeast ascending vertical line. Here we find the exaltation of  $\mathfrak{F}$  in  $\mathfrak{H}$  moving into rulership in the sign of  $\mathfrak{O}$ . This is not all. The current flowing from the north to the south through the sign of  $\mathfrak{E}$  brings the rulership of the  $\mathfrak{D}$  and the exaltation of  $\mathfrak{L}$  to mingle with the currents of  $\mathfrak{H}$ . At this point the exaltation of  $\mathfrak{L}$  in  $\mathfrak{E}$  shifts into rulership in  $\mathfrak{H}$ , and the exaltation of the  $\mathfrak{D}$  in  $\mathfrak{E}$  moves into exaltation in the sign of  $\mathfrak{O}$ . All of this complex mingling of intelligence rises through the Triumphant and Eternal Intelligence of  $\mathfrak{O}$ , from sub-consciousness into self-consciousness awareness.

### Meditation on ♄ and ♃

As in the other meditations, place the appropriate keys before you. Begin with Keys 9 and 1. These keys are attributed to the sign of ♄ and the planet ♃.



After a few minutes chant the notes attributed to these two keys. Key 9 is F and Key 1 is E. Keep in mind the fact that you are evoking the storehouse of sub-conscious wisdom into self-conscious awareness.

After spending a few minutes more, replace these keys with the keys connected to the sign of ♃, Key 18. These are Keys 18, 10, 12, and 3.

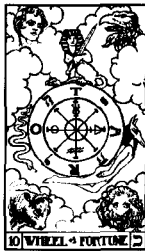

After a few minutes chant the notes of the keys. Key 18 is B, Key 10 is A<sup>#</sup>, Key 12 is G<sup>#</sup>, and Key 3 is F<sup>#</sup>

After completing this portion of the meditation, place the entire set of keys together as in the past meditations.

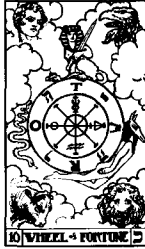

The purpose of working with these keys is to understand how each of the signs operates separately and how they function together as polarities. Continued practice with these keys builds a capacity to fix the volatile aspects of super-consciousness within the container of self-conscious awareness. This completes this section on zodiacal polarity.



# Chapter VII

## The Four Diagonals

The four diagonals symbolically represent the capacity of the initiate to access the center of the Cube and thereby move to any place upon the Cube at will. Without going into great detail at this time, we can look at the diagonals in a similar light as the sixteen invisible paths of the Tree of Life. The invisible paths give access to various states of being. The aspirant and disciple must first integrate the tree path by path and sphere by sphere. Once the primary paths are integrated, then the invisible paths lie open before the initiate.

Similarly, in order for the disciple to gain access to the center of the Cube, he must first traverse and integrate each of the twelve outer lines of the Cube. The four diagonals are then open to the initiate and allow for the accelerated journey to any point in space. This may well be a model for instant location anywhere in the universe, but for the time being we will leave the study of space travel to the physicists.

There are five letters that take on a special form in the Hebrew/Chaldean Aleph-Beth when appearing at the end of a word. These letters are called finals. The five finals are:

Regular Form	Final Form
ט	ך
צ	ם
ח	ן
מ	נ
א	ע

These five finals have a special and very interesting role within the Cube of Space. The cube, as you know, has six sides, eight corners, and twelve connecting lines.

Four of the five finals begin their flow of intelligence at one of the four below corners. The first final is ך. This final carries the accumulated intelligences from the below southeast corner to the above northwest corner. This below corner is the convergence of the east

below represented by ☉, and the south below represented by ♁.

The second final is ♁, and it ascends from the below northeast corner to the above southwest above corner. This takes the current of the below northeast corner of ☉ and carries it to the above southwest corner.

♁ runs from the below southwest corner to the above northeast line. This carries the current of ☉ to self-consciousness at the terminating point of the line of ♁.

The fourth of the final diagonals that travels from the below is ♁. It travels from the below northwest to the above southeast corner.

It is important to note that each of these final diagonals travels from the below corner of origin and moves through the icenter surfacing at the diametrically opposite above corner. The activity of these lines distributes the intelligence of the sub-conscious and super-conscious states to the self-conscious level of awareness. The diagonals also bring the converging currents of their respective corners from the below face to the above. These converging currents are reservoirs of intelligence that need to be expressed consciously.

As these diagonals flow through the center of the Cube, they receive the intelligence of the center and circulate it within the exterior currents of the Cube. This creates an addition to the already existing currents that normally flow on the exterior. Without the influence of the finals through the diagonals, certain combinations of intelligences would not be joined together. The movement of the finals creates the environment where the soul or the central intelligence can make its will be known to the personality or self-conscious level of existence.

The following diagram shows the placement of the four finals which originate at the below corners.

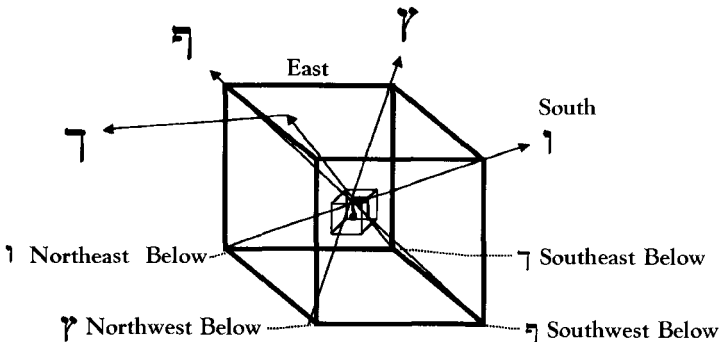

Figure 18.

⌈ is the first of the diagonals. It carries the currents from the southeast below corner. In the southeast we have the union of the ☉ in the south and ♀ in the east. In the meditations on the finals we begin at the point where the subconscious aspects of the cardinal points have their influence. At the actual point of the southeast below corner we have a strong convergence of the intelligences of ♃, ♀, and ♄. On the below eastern line, flowing from the north to the south we have the sign of ☽. Note that ♃ is exalted in ☽. Flowing from the west to the east we once again have the intelligence of ♃, which co-rules the sign of ♂ with ♄. ♄ is attributed to final ☐. ☐ resides at the center. As the diagonal of ⌈ surfaces on the above northwest corner, we can experience the strong influence of ♄. The co-rulership of ♄ in the sign of ♂ moves into exaltation in the sign of ♁. The intelligence of ♁ flows into the above western line of ♂ where ♃ is once again the ruling planet.

As ⌈ passes through the center of the Cube it defines the below southeast and above northwest corners of the 27<sup>th</sup> central cubic unit. The 27<sup>th</sup> central cubic unit is discussed in great length in Chapter Five of *The Cube of Space*. The Ace of Pentacles and the Ace of Swords are located at these corners of the central cubic unit. The Ace of Swords rules the signs ♁, ♃, and ♂. The Ace of Pentacles rules the signs of ♁, ♃, and ♂. We already know that ♃ rules the signs of ♂ and ♂.

The aces themselves represent the central self יחידה as it is manifested in the four worlds. As ⌈ passes through the center of the Cube, it carries the intention of יחידה through the vehicles of the Aces of Swords and Pentacles into self-conscious awareness. ⌈ is also the connecting link between the מלכות (Malkuth) of the one tree to the דעת (Daath) of the diametrically opposite tree (see Chapter 3, Fig. 13, page 79 of *The Cube of Space*). This informs us that there is an intelligence that acts as the linkage between one world and another. This linkage allows for the various stages of creation, as well as the stages of the unfolding of consciousness.

The intelligences of ☽, ♂, ♂, and ♃ are brought into union with each other through the diagonal of ⌈. Notice that these are the signs in which ♃ is either ruler or exalted. Furthermore the intelligences of ♀, the ♃, and ♄ are also carried to the opposite diagonal through the path of ⌈.



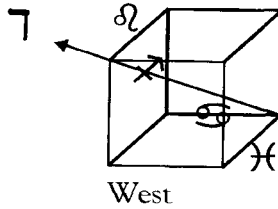

Figure 19.

### Meditation on 7

As we participate in these meditations, we will be using Key 10 (Wheel of Fortune) as the designated Tarot key for 7. As we begin the meditation on the diagonal of 7, place Tarot Keys 10, 7, 14, 18, 2, 3, and 12. These are the keys that represent the complex combinations of intelligences that travel through the diagonal of 7.



After a few minutes chant the notes attributed to the planetary intelligences and followed by the zodiacal intelligences. The notes are A#, G#, F# G#, D#, G# and B. Take your time with each note.

After completing this portion of the meditation place the Ace of Pentacles and the Ace of Swords before you and focus on their symbols.

They represent the perfect intention of **יחידה** expressed through the vehicles of the angelic kingdom (**היות הקדש**) represented by the Ace of Swords, and **ראשית הגלגלים**, the beginning of the whirlings, represented by the Ace of Pentacles. The letter **ך** is the vehicle that brings these qualities into our conscious grasp.

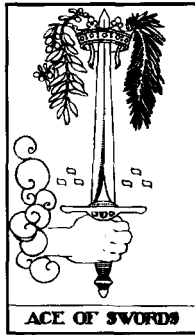

The aces are a complex shorthand symbol system designed to give expression to several Tarot keys. The Ace of Pentacles is not only the expression of the final quarter of the year which encompasses the signs of  $\text{♋}$ ,  $\text{♌}$  and  $\text{♍}$ , but it also includes the ruling and exalted planets for these signs. The planets are  $\text{♃}$ ,  $\text{♄}$ ,  $\text{♅}$ , and  $\text{♆}$  as rulers and  $\text{♂}$ ,  $\text{♀}$ , and  $\text{♁}$  as the exalted planets. Translating the astrological into Tarot keys, we would find that the Ace of Pentacles represents Keys 0, 1, 3, 10, 15, 16, 17, 18, and 21. We could lay these nine major trumps, or we could simply use the Ace of Pentacles.

The same is true for the Ace of Swords. It represents the third quarter of the year which includes the signs of  $\text{♎}$ ,  $\text{♏}$ , and  $\text{♐}$  and the planets  $\text{♀}$ ,  $\text{♂}$ ,  $\text{♀}$ , and  $\text{♅}$  as rulers, and  $\text{♃}$  and  $\text{♄}$  as the exalted planets. Between these two aces we have a representation of fourteen Tarot keys. This is a lot to focus on in these meditations. You can see that it is much easier to use the minor Tarot keys (which are not so minor when you think about it) for this type of practice.

As the current of **ך** flows to the surface it blends into the terminating point of  $\text{♋}$  and also merges with the line of  $\text{♁}$  at the above west line.

The possibilities for meditations with the final letters are many. The final letters do not necessarily need to surface at the diametrically opposite corner. As a final letter reaches the center it has the capacity to travel to any of the six faces of the Cube. The following

set of meditations is set up to show how the intelligences which originate at the below corners can access the six faces as well as the center. There will not be a lengthy discourse for each of the meditations. The key combinations will be shown for those who wish to explore the various possibilities.

**The Center and the East**



**The Center and the West**



Figure 20.

If you go back to the meditation on planetary polarity you will see some similarities. In this meditation you will be dealing with the flow of influence, which has been picked up by the path of final ⌒, and how it is distributed to the eastern face of the Cube.

Because of the duplication of Key 10, you may find it confusing to use it twice. Perhaps using the letters only will make it clearer. What is taking place is a transformation in the actual quality of ⌒. After ⌒ has passed through the center, it has the capacity to bring the bounty of the center to all the faces of the Cube, including the western face of ⌒.

The Center and the South

∩  
D



∩  
A#

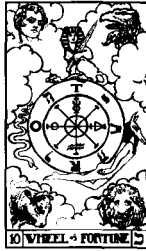

The Center and the North

☱  
C



∩  
A#



The Center and the Above

☱  
E



∩  
A#

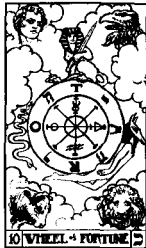

The Center and the Below

♯  
G#



∩  
A#

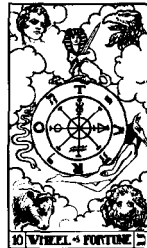
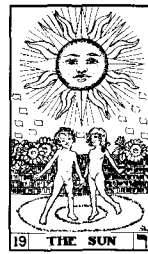

Figure 21.

Final ∩

∩ carries the currents of the below northeastern corner. The source of the current is from the northeastern corner of √. There are no other influences that flow into this corner. The north below line of ♀ flows away from the northeast below corner into the west. The current of the east below line of ☽ flows from the northeast below to the south. Therefore these two lines of ☽ and ♀ receive the flow from the northeast but do not contribute to it. We will find that the two zodiacal signs in which ♂ is the ruler blend their intelligences through the diagonal attributed to final ∩. Inherent in these signs are the rulers and exalted planets. In the sign of √, we have ♂ and the ☉. In the sign of ♍, we have ♂, ♀, and ☿.

The meditation on ∩ begins with Key 13 as ∩, along with Keys 4, 16, 19, 13, 16, 20, and 0.



After a few minutes with each key, chant the appropriate tones. The notes are G, C, C, D, then G, C, C, and E.

The northeast below corner is the starting point for  $\uparrow$ . As  $\uparrow$  travels through the center, it defines the northeast below and the southwest above corners of the 27<sup>th</sup> central cubic unit mentioned in the meditation on  $\uparrow$ . These are bound by the Ace of Wands and the Ace of Cups.

The Ace of Wands rules the first quarter of the year and thus represents The Emperor (the sign of  $\Upsilon$ ), The Hierophant (the sign of  $\text{♁}$ ), and The Lovers (the sign of  $\text{♌}$ ). The ruling planets are  $\text{♁}$ ,  $\text{♀}$ , and  $\text{♃}$ . The exalted planets are the  $\text{☉}$  and the  $\text{♃}$ .

With the Ace of Cups we have the second quarter of the year where the signs of  $\text{♋}$ ,  $\text{♌}$ , and  $\text{♍}$  are employed. The ruling planets are the  $\text{♃}$ , the  $\text{♄}$ , and  $\text{♅}$ . The exalted planets are  $\text{♁}$ ,  $\text{♂}$ , and  $\text{♆}$ . There are a total of thirteen keys used in this interaction; thus we simplify things by using the Ace of Wands and the Ace of Cups.

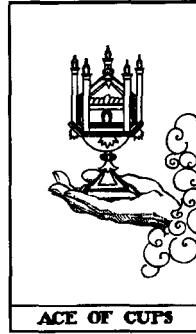
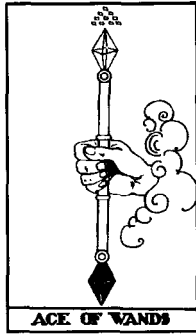

After meditating on  $\text{⌋}$  and the center you have the same possibilities that existed with  $\text{⌋}$ . This is the capacity to travel to any of the faces of the Cube. The following are the combinations of  $\text{⌋}$  and the six faces.

The Center to the East



The Center to the West



The Center to the South

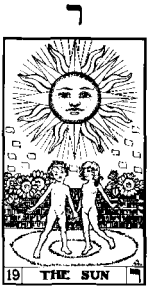

The Center to the North



The Center to the Above



The Center to the Below



Figure 22.

## Final 𐌆

𐌆 travels from the below southwest corner to the above northeast corner. 𐌆 carries with it the intelligence of 𐌚 and the sign of 𐌛. 𐌛 is the recipient of the influence of 𐌚 and 𐌙. 𐌚 descends from the above, and 𐌙 flows from the east to the west by way of the north. All of this influence is brought to bear on the southwest below corner, which is the originating point for 𐌆. This intelligence is carried from this below corner to the above northeast corner, where it makes contact with the terminating point of the path of 𐌒. The first meditation on 𐌆 will be at the southwest below corner, where 𐌆 is the recipient of the intelligences of Key 15, 11, and 9. Place these keys before you with Key 16 representing 𐌆.



The notes for these keys are C, F, F<sup>#</sup>, and A. After looking at the keys for a couple of minutes, sound their notes and feel their vibration move within your entire body.

What is available to the student who enters into this work is far greater than any commentary can describe. Since this work on the Cube of Space is in its early stages, you may find yourself adding considerably to the knowledge which has up to this point remained in occultation.

## 𐌆 and the Center

As 𐌆 ascends from the below southwest corner and encounters the center of the Cube it passes through and defines the southwest below corner and the above northeast corner of the 27<sup>th</sup> central cubic unit. The Ace of Cups and the Ace of Wands represent these corners. You will notice that these are the same aces that were defined by 𐌙. The difference is the order in which the aces were contacted. 𐌙 passed



through the below corner of the Ace of Wands and the above corner of the Ace of Cups. ♯ passed through the below corner of the Ace of Cups and the above corner of the Ace of Wands. Thus we can see a reference to the idea that ♃ is the day throne and ♆ is the night throne of ♂. Place the Ace of Wands and the Ace of Cups together with Key 16. We have already delineated the complex symbolism of these two aces in the meditation on ♯.

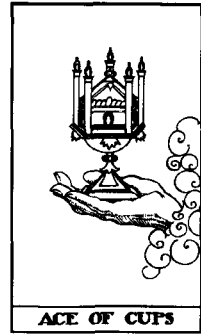
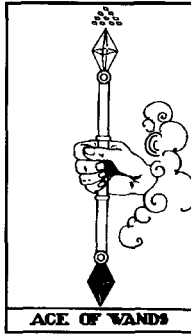

The following arrangement of Tarot keys represents the movement of ♯ to each of the six faces of the Cube.

From the Center to the East



From the Center to the West



From the Center to the South



From the Center to the North



From the Center to the Above



From the Center to the Below



Figure 23.

### Final $\gamma$

$\gamma$  is the last of the diagonals that ascend from one of the below corners to its diametrically opposed above corner. It carries the intelligences of the north below line of  $\mathfrak{M}$  and the descending current of the northwest line of  $\underline{\Omega}$ .  $\gamma$  carries this combination of intelligences to the southwest above corner where it joins forces with the ascending line of  $\mathfrak{V}$  and the south above line of  $\mathfrak{M}$ . As the currents of the northwest below are channeled through  $\gamma$ , we see a convergence of the influences of  $\mathfrak{H}$ ,  $\mathfrak{F}$ , and  $\mathfrak{V}$ .  $\gamma$  carries the exalted qualities of  $\mathfrak{H}$  from  $\underline{\Omega}$  to meet  $\mathfrak{H}$  as ruler of  $\mathfrak{M}$ .  $\gamma$  is the letter attributed to  $\mathfrak{M}$ . We also see the ruling power of  $\mathfrak{F}$  in the sign of  $\underline{\Omega}$  running into the line of  $\mathfrak{V}$  where  $\mathfrak{F}$  is also ruler. The southeast line of  $\mathfrak{V}$  also carries the exalted qualities of  $\mathfrak{F}$  from the sign of  $\mathfrak{H}$  into the above where it meets up with  $\gamma$ .

The influence of  $\mathfrak{M}$  brings both the ruling power as well as the exalted influence of  $\mathfrak{V}$  into the currents of  $\gamma$ . This intelligence is carried to the terminating points of the lines of  $\mathfrak{V}$  and  $\mathfrak{M}$  where the line of  $\mathfrak{H}$  begins and  $\mathfrak{V}$  moves into rulership.

As  $\gamma$  passes through the center it defines the below northwest line and the above southeast line of the 27<sup>th</sup> central cubic unit. The northwest below corner is attributed to the Ace of Swords and the above southeast line is given to the Ace of Pentacles. The manifold symbols of these two aces were given in the meditation on  $\mathfrak{J}$ .

The Tarot keys used to begin this meditation will be Keys 11, 9, and 17 for the zodiacal intelligences and Keys 1, 3, and 21 for the planetary intelligences.

### Meditation on $\gamma$

Begin by placing Keys 11, 9, 17, 1, 3, and 21 before you. These are the keys which enter into the line of  $\gamma$  at the below corner.



After looking at the keys for a few minutes, chant the notes assigned to each of the keys beginning with  $\gamma$ : Key 17 ( $A^\sharp$ ), Key 11 ( $F^\sharp$ ), Key 9 (F), and Key 21 (A).

After a few minutes replace the lower keys with the Aces of Swords and Pentacles.

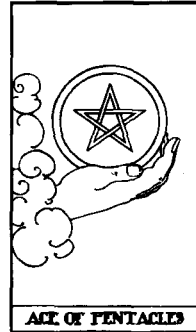
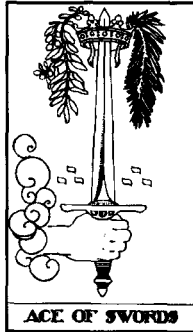

Because of the complexity of the two aces it appears difficult to assign a particular note to them. Because of the system of attribution of the elemental qualities of the aces, it seems appropriate to give the note of the vertical corner which is used to give them their suit. The Ace of Swords then is given  $F^\sharp$  because it is related to Air through the sign of  $\underline{\Omega}$ . The Ace of Pentacles receives its attribution of Earth and the note  $C^\sharp$  from the singing of  $\gamma$ .  $\gamma$  of course receives the note  $A^\sharp$ .

After focusing on the three symbols for a few minutes chant the notes and feel the sound vibrate through your body. Try to experience the sense of unity which is expressed in the center of the Cube.

The final point of this meditation is at the southeast above corner where the currents of  $\approx$  and  $\gamma$  merge with  $\gamma$ . This is where the intelligences of  $\bar{\eta}$  and  $\bar{\rho}$  converge. This is the limiting of a creative power of  $\bar{\rho}$  by the power of  $\bar{\eta}$ .

Place Keys 17, 21, 5, and 3 before you.



Focus your attention on each key then chant the notes that go with each: Key 17 (A<sup>#</sup>), Key 21 (A), Key 5 (C<sup>#</sup>), and Key 3 (F<sup>#</sup>). The important part of this meditation is the fixing of the wisdom that is carried by  $\Psi$  from the below to the center and from the center to the above.

The remainder of meditations for  $\Psi$  would be the actual traveling from the center to the various faces. The following are the combinations that can be explored by the attentive student.

From the Center to the East

7



7



From the Center to the West

3



7



From the Center to the South

7



7



From the Center to the North

3



7



From the Center to the Above

3



7



From the Center to the Below

3



7



Figure 24.

7 is the last of the four diagonals that travel from one of the bottom corners to the surface. There is yet another final letter that does not participate as a diagonal. We will have a special section dedicated to the final letter 3. Although 3 is among the five finals, both its place of origin and its function are quite different.



# Chapter VIII

## Meditations on ׀

Of the five final letters, ׀ holds a unique place. As we have seen in Chapter VII, each of the four finals begin their journey to the center from their respective below corner and emerges in the diametrically opposite above corner. As a final, ׀ does not originate at a below corner; instead it dwells at the center of the Cube. Before we begin the meditations on ׀ let us consider some of the unique qualities of this letter.

- ׀ is:
- A mother letter
  - A final letter
  - At the center of the Cube

׀ is not unique in that it is a mother letter, a final letter, or at the center of the Cube. What makes ׀ unique is that it is the only letter that participates in all three of these exalted positions.

As a mother letter, ׀ is related to ׀ and to ׀. These we have dealt with in Chapter I. As a Final Letter, ׀ is related to ׀, ׀, ׀, and to ׀. As a letter at the center of the Cube, ׀ is once again related to the other two mother letters that originate at the center, and create the three axes of symmetry. ׀ also resides at the center with the letter ׀. Together with the letter ׀, we have the Stable and the Administrative Intelligences. As a word, ׀ and ׀ spell the word ׀ת, which means wholeness, perfection, and completeness. The combination of Keys 12 and 21 symbolically represent the letters ׀ת. Each is a reflection of the other; that is, 12 is the reflection or reversal of 21. Notice that 12 and 21 each reduce to 3, and 3 is the number of the Sphere of בינה.

The combination of ׀ and ׀ has a numerical value of 440. ׀׀׀׀, also has a value of 440 and it expresses the initial quality of ׀ת׀ which is the central point of creation. ׀׀׀׀ means wheelings or circling. Within the meaning of wheelings is the possibility of



movement either toward or away from the center. This connects the center with the vortical motion of **כתר**. The reflection of **כתר** is **תפארת**. **תפארת** is the sixth sphere on the Tree of Life, which is attributed to the  $\odot$ . Now the letter **ר** is called the Collective Intelligence, and is attributed to the  $\odot$ . **שכל כללי** (The Collective Intelligence) has a value of 440. If we take the number 6 given to **תפארת**, extend and reduce its value:  $1 + 2 + 3 + 4 + 5 + 6 = 21$ ;  $1 + 2 = 3$ , we find that it connects the Sphere of the  $\odot$  to the Sphere of **ה**, **בניה**, and Key 21 which is also given to **ה**. These numerical associations offer us a connection between the central ego of **תפארת** and the spheres of **כתר** and **בניה**, which are expressed through the letters at the center of the Cube, **תם**.

**ם** is an expression of the Buddhic plane to which the higher mind or manus has access. **ת** allows for the containment and expression of the higher mind through the vehicle of the physical brain. As **ם** and **ת** are synthesized they become the Stable Administrative Intelligence expressing Buddhi in the World of Name and Form. The center of the Cube represents the fundamental point of origin. From the center the act of intention moves toward actual manifestation, and therefore away from the center. The movement away from the center is the act of the One Life manifesting itself in diversity.

All the diagonals, as expressed by the four finals, pass through this center of the Cube, and partake of the qualities of **תם**. These qualities are whole, complete, and perfect.

We find therefore that **ם** is the agency by which we first come in contact with the central self through its reflection the  $\odot$ . The awareness of this higher state can only take place through the faculty of intuition, which is a phenomenon of Buddhi.

### Meditation on **ם**

Begin this meditation with Tarot Keys 12 and 21. This is a representation of the central intelligence of not only the Cube but also the 27<sup>th</sup> central cubic unit, the Holy of Holies. The combination of these two letters represents the completion of the Great Work.

Place Keys 12 and 21 before you, and imagine yourself seated at the central point of the Cube with full visibility of the entire world around you. It is a fact that when you are looking at the Cube from the outside you can only see three sides or half a cube. When you are at the center your perspective is far greater.

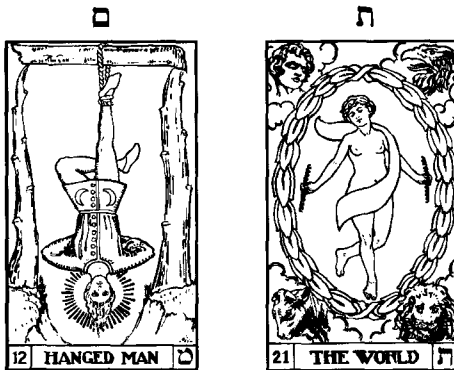

After looking at the keys for a few minutes and visualizing yourself at the center of the Cube, chant the notes which are given to these two keys. The notes are G<sup>#</sup> for Key 12 and A for Key 21. As you chant these notes feel the three axes of symmetry extend from your center to the six directions in space. After a minute or two feel the four diagonals passing through your center receiving the guidance of the One Self and sending it to the surface of the Cube, bringing the necessary guidance to all who seek that connection to the ONE. As you finish, chant the word “Toom”. The notes are A and G<sup>#</sup>. These notes are in a reversed order from the first chant.

▣, like the other final letters, has access to all other faces of the Cube, yet ▣ is unlike the other four finals for it does not originate on one of the four below corners. We can therefore use ▣ to connect the exterior faces of the Cube with the center, keeping in mind that each face has its origin at the center.

We began our meditation in this series with the central point of ▣▢. Here we will take the Stable Intelligence to the six exterior faces of the Cube. We will use the same technique used with the other four finals. Unlike the other diagonals, ▣ is also one of the three mother letters. ▣ is also the originating point for the east—west axis. This gives ▣ a special relationship with ♀, ♂, and ♃. ▣ as ♃ is a co-ruler of the sign of ♂ with ♃. It is also the sign of ♂ where ♀ is exalted. ♀ and ♃ are the eastern and western faces of the Cube of which ▣ is the origin.

Begin by placing Keys 3 and 12 together. This gives us the union of the eastern face and the central axis of ▣. Key 12 is perhaps the most important key in the entire deck of seventy-eight cards. It represents the state of unbroken connection to the universal mind. ▣ also

represents the *prima materia* of the alchemists. As a combination of Keys 3 and 12 we have the impression of the creative image upon the universal substance.

With the placement of Keys 10 and 12 we have the response of the one who creates the impression upon the universal substance to the manifested reality in the present. It is here that the student may adapt the conditions into a new or more elaborate form if the original image was not clear enough.

From the Center to the East



From the Center to the West

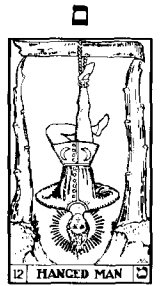

Figure 25.

From the Center to the North and South

Because □ like the other finals has access to each face of the Cube via the center, we will meditate upon the way in which □ relates to the other faces of the Cube. After having placed our attention on the east and west, we will now focus on the north and south.

Before doing this we must become aware of the combined influences that occur when □ moves from the center to the north and south. As we place our attention on Keys 16 and 19, we will see that there is a combination of the influences of □ and ♃.

♃ is the axis which connects the north to the south and therefore is invoked as □ moves from the center to the north and south via the axis of ♃.

The North is the place of darkness and mystery, and is ruled by ♂. The axis of ♃, which leads from the center to the north, is a channel for the influence of □. This allows us to access the mystery of the North through the stable intelligence.

♃ repeats the same process of channeling □ from the center to

the south. The South is the place of greatest light. The southern face is ruled by the ☉. This assists us in accessing higher mind and the Sphere of the One Ego seated in the hearts of all mankind.

Therefore before we place our attention on the two polarized planets, the ☉ and ♂, let us look at the combined influence of ♀ and ♃. These are the mothers of fire and water. In this meditation play particular attention to the union of these two principles. This is the combination of the fiery life force within the form.

### The Mothers of Fire and Water

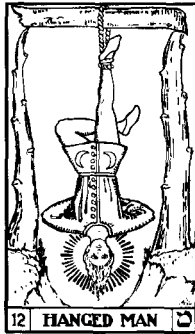

After spending about five minutes with these two elemental mothers, place your attention one at a time on the north and south, combining the Hanged Man with each of them.

## The Center to the North



## The Center to the West



Figure 26.

☐ represents “Waters of Consciousness”, and our ability to enter into the Stable Intelligence. ☐ allows for unbroken flow and connection to that higher state we call Samaddhi. This is the potential and inevitable connection in which we will all participate at one point in our spiritual unfoldment. Each and every aspect of the Divine, which is represented by the 22 letters and keys, is accessible through this medium of Samadhi. Once one has reached the center of the Cube, and participates in the consciousness of ☐, one can travel to any surface of the Cube.

The next meditation we will address is the movement from the center to the above and the center to the below. This is accomplished through the axis of א, and brings us into the combined influences of ☐ and ב, and ☐ and ג. From a planetary perspective we have the influences of ט, פ, צ and the ד.

The numerical value of אפ is 41. This gives the numerical value of the words איל strength, מא mother, לובנ to set bounds, boundary.

It is consciousness itself that creates the forms and impresses its will upon the *prima materia*. The combination of מא places us in touch with the creative factor of consciousness and the power that lies behind it.

Let us begin then with the meditation upon Keys 0 and 12 in order to give the proper suggestion to the mind stuff on how we must go about building the necessary forms within our bodies and the world in which we live.

## The Mothers of Air and Water

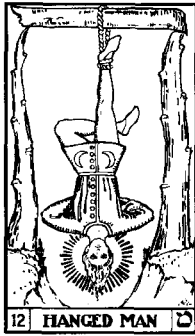

The mother letter **⚎** is the vehicle that channels the state of Samadhi represented by the letter **⚑** to the self-conscious state. Self-consciousness is represented by the letter **⚒** and Key 1 (The Magician). The subconscious level is represented by the letter **⚓** and Key 2 (High Priestess).

There is an interesting relationship between **⚑** and **⚎**, and **⚓** and **⚒**. This is visible through letters, numbers, and planetary correspondences. Key 1 and Key 2 represent the self-conscious and sub-conscious aspects of humanity. Their numbers via Hebrew letters add up to 5. The numbers of the keys add to 3.

With Keys 0 and 12 we have the numerical value of 41, which reduces to 5, and by the number of the keys we have 12, which reduces to 3.

**⚓** is considered to be the higher octave of **⚔**, while **⚕** is the higher octave of the **⚔**. So as we place our attention on these two sets of keys, keep in mind that that which is above and that which is below is interchangeable with that which is within and that which is without. This is the relationship between Keys 1 and 2, and the center **⚎** and **⚑**.

Let us now place our attention on the combination of keys related to **⚑** as it travels to the above and the below.

Center to Above



Center to Below



Figure 27.

The effects of what is symbolized as being possible by these two key combinations are quite astounding when one takes into account what each of the keys represents by itself, and what they represent together. Key 1 is of course self-consciousness. Self-consciousness is usually the cause of all our problems. Inadequate observation and poor measuring of one's situation as well as poorly formed images create the conditions of misery and death. When we align our self-conscious intelligence with the unbroken flow of superconsciousness we create the conditions for life and every kind of good.

This completes the section on the final letters.

## Chapter IX

### The Planetary Orders and the Attributions to the Minor Trumps

In the book *The Cube of Space*, we found for the first time the placement of the minor keys around the faces and perimeter of the Cube of Space. The placement of these keys offers us yet another means by which we can unlock the mysteries of the Cube. The grid of the Magic Square of  $\text{Ḥ}$  determines the placement of the minor keys. This grid gives us the location of the decanates of the twelve signs of the zodiac as well as the position of the aces and court cards, which are located on the six faces. In this portion of our work we will again begin to focus on the location of the minor keys. There are several approaches we can take in order to address the many revelations that await the students who commit themselves to treading this uncharted territory.

The key to unlocking the Minor Arcana is in the attributions given to the minor keys. I am not referring to the “buzz words” by which one determines the meaning of a Tarot spread, but to the astrological attributions given in relationship to sign and planet.

In the first work on the Cube of Space there is an offering of two methods by which we could articulate each minor key. In this work, I will offer a few more that may be used for future and perhaps more intense meditation. For the sake of expedience as we move around the Cube of Space, we will focus attention on one only.

To articulate a minor key one simply lays out the major keys which are the sum total of intelligences that are represented in the particular minor key chosen. Let us take for example the Eight of Swords. To articulate this minor key, we would place the major keys attributed to the planet and sign side by side. The Eight of Swords represents ♃ in  $\text{II}$ . Therefore we would take the two major keys that represent the sign and planet and place our attention upon them.



## The Eight of Swords

♃ in ♀

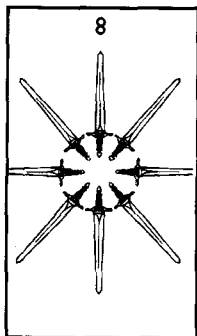

We can see that the minor Arcana is a rather compacted symbol system, which holds within a single card anywhere from 2 to 9 major trumps. Of all the minor keys, the aces contain the greatest volume of symbols. Each Ace contains the three signs of the zodiac which the individual Ace rules and the ruling planets of the decanates.

When giving the planetary attributions to the Tarot, Dr. Case uses what is termed the elemental triplicities. These are the conventional planetary rulers of the decanates. I do not want to delve into the science of this here, as there are several charts and graphs anent this topic in the first work of *The Cube of Space*. Dr. Robert Wang has also dealt with this subject in his *Qabalistic Tarot*. Those who have studied *The Oracle of Tarot* by Case, or *Esoteric Astrology*, co-authored by Paul Case and Anne Davies, will already be familiar with the elemental order.

The reason for speaking of these other systems, or planetary orders, is to alert the student that there are different situations which may govern the life of the student. These other orders can assist the student in making a stronger contact with his or her inner life.

This is also an opportunity to address the entire reason for doing this work in the first place, as well as looking beyond what alchemists call the "Completion of the Great Work."

Dr. Case has carefully taken the time to lay the foundations for a most powerful system of transformation. Those who have gone

through the work as laid out in this system know that it works. This knowledge is by no means the end of the work, but it will take the student through the first necessary steps in order to express the life of the Central Ego.

The other planetary orders that are given here address the life of the Soul, as well as the life of the Monad. The Soul is represented by the ☉ and by the Sphere of תפארת. The Monad is the Spiritual Sun behind The Sun, or the Sphere of כתר.

By using the law of correspondence, we can apply the proper planetary rulers as they shift from one sign to another.

For the sake of clarity we will begin with the order we shall employ throughout these meditations.

### The Elemental Triplicities

♈	♉	♊	♋	♌	♍	♎	♏	♐	♑	♒	♓
♂	♀	♀	♃	☉	♀	♀	♂	♃	♁	♁	♃
☉	♀	♀	♂	♃	♁	♁	♃	♂	♀	♀	♃
♃	♁	♁	♃	♂	♀	♀	♃	☉	♀	♀	♂

Each of the three planets under each of the zodiacal signs represents a 10 degree arc, or one of the 36 decanates of the zodiacal wheel. These are the common attributions given to the Tarot by Dr. Case. In her writings on astrology, Alice Bailey uses the same series of attributions under the title of "Orthodox Astrological Relationships." These will be the attributions used as we articulate the Minor Arcana in our meditations. As far as the other planetary orders are concerned you are well equipped to make the necessary insertions should you wish to engage in a different and perhaps more intense adventure.

In the first work on the Cube of Space, the Chaldean attributions were used, which are slightly different than the elemental attributions, though they do share similarities. The Chaldean order speaks more directly to the descent of the intelligence of the spheres on the Tree of Life, while the elemental triplicities speak

to the quality of the elements expressed through the zodiacal signs.

I would also like to address the planetary attributions used in the fixed and cardinal wheel presented in *Esoteric Astrology* by the Master D. K. These correspondences represent the planetary attributions for disciples, and the hierarchy. It is recommended that you use the elemental order of triplicities for now.

### Esoteric Rulers

♈	♉	♊	♋	♌	♍	♎	♏	♐	♑	♒	♓
♀	♁	♀	♆	☉	☾	♄	♂	♁	♃	♁	♀
☉	☾	♄	♂	♁	♃	♁	♀	♂	♀	♀	♆
♁	♃	♁	♀	♀	♀	♀	♆	♀	☾	♆	♂

Once again each of the signs has three ruling planets: one for each of the three decanates. In this case for example, instead of having ♂ in ♈ for the Two of Wands, we would have ♀ in ♈. These attributions would be inserted when the student wishes to apply the esoteric rulers of the signs. This may seem a little hard to accept for those students who have been using the traditional system, or are not aware of any other system whatsoever. Don't take my word for it, check it out for yourself. I would like to mention here that the author takes no responsibility for any spiritual crises that may arise for those who apply any of these techniques.

### Hierarchy Rulers

♈	♉	♊	♋	♌	♍	♎	♏	♐	♑	♒	♓
♄	♁	♁	♆	☉	♁	♃	♀	♂	♀	☾	♀
☉	♁	♃	♀	♂	♀	☾	♀	♄	♁	♁	♆
♂	♀	☾	♀	♄	♁	♁	♆	☉	♁	♃	♀

The Chaldean order is not presented here for it has been dealt with at length in the first work. The Chaldean Order has a totally different application than the three orders presented here.

The **V** in the chart of Esoteric and Hierarchy rulers represents Vulcan. On page 199 of *The Tarot*, by Dr. Paul Foster Case, he refers to Key 20 as representing both ♀ and Vulcan.

The following tabulations show the comparison between the various orders. Each set of attributions is intended to take the student through a particular process. The conclusion which I draw here is based on 20 years of study of the Tarot as presented by The Master R, through Dr. Case, as well as other 19<sup>th</sup>/20<sup>th</sup> century Hermetic Occultists. Also included is the Trans-Himalayan teaching as presented by the Master D. K. through Alice Bailey. The various planetary orders assist us in accessing the keys to:

- 1) The Mutable Cross via the elemental triplicities. The goal of working with this planetary order is the fusing of the three aspects of personality, mental, emotional, and physical/etheric. It brings the student to the threshold of initiation. This system is intended for **ASPIRANTS** those early on the path, a term used frequently for students of the B.O.T.A.
- 2) The Fixed Cross via the esoteric rulers. The goal here is to work towards total Soul infusion. This planetary order is intended to be employed by **DISCIPLES**, who have to a larger degree knowledge of the Life of the Soul than do aspirants, and have undergone the first or second initiation (Masonically speaking).
- 3) The Cardinal Cross via the Hierarchy rulers. The goal of this series is to assist the **INITIATE** in expressing Monadic Life. There is not enough experience on the part of the author to say any more concerning this. Give it a try!
- 4) The Chaldean Order represents the descent and return of consciousness and creation. It gives the student an experience of the mechanism of creation, from the first act of the intention of **WILL**, to the manifestation of that intention in the world of name and form.

I invite the reader to experiment with these attributions, for only through experimentation will we come to **KNOW** the fact behind this assertion. The following is a quick reference to the four orders under consideration.

♋	Two of Wands	Three of Wands	Four of Wands
Orthodox	♂	⊙	♋
Esoteric	♀	⊙	⊕
Hierarchy	♁	⊙	♂
Chaldean	♂	⊙	♀
♌	Five of Pentacles	Six of Pentacles	Seven of Pentacles
Orthodox	♀	♀	♏
Esoteric	V	♃	♏
Hierarchy	V	♋	♀
Chaldean	♀	♃	♏
♍	Eight of Swords	Nine of Swords	Ten of Swords
Orthodox	♀	♀	♏
Esoteric	♀	♁	♋
Hierarchy	V	♏	♃
Chaldean	♋	♂	⊙
♎	Two of Cups	Three of Cups	Four of Cups
Orthodox	♃	♂	♋ ♁
Esoteric	♀	♂	♀
Hierarchy	♀	♀	♀
Chaldean	♀	♀	♃
♏	Five of Wands	Six of Wands	Seven of Wands
Orthodox	⊙	♋	♂
Esoteric	⊙	⊕	♀
Hierarchy	⊙	♂	♁
Chaldean	♀	♃	♏
♐	Eight of Pentacles	Nine of Pentacles	Ten of Pentacles
Orthodox	♀	♏	♀
Esoteric	♃	♏	⊕
Hierarchy	♋	♀	V
Chaldean	⊙	♀	♀

♊	Two of Swords	Three of Swords	Four of Swords
Orthodox	♀	♃	♆
Esoteric	♃	♃	∇
Hierarchy	♃	♀	⊕
Chaldean	♃	♃	♃
♋	Five of Cups	Six of Cups	Seven of Cups
Orthodox	♂	♃ ♆	♃
Esoteric	♂	♀	♆
Hierarchy	♆	♀	♆
Chaldean	♂	⊙	♀
♌	Eight of Swords	Nine of Swords	Ten of Swords
Orthodox	♃	♂	⊙
Esoteric	⊕	♆	⊙
Hierarchy	♂	♃	⊙
Chaldean	♆	♃	♃
♍	Two of Pentacles	Three of Pentacles	Four of Pentacles
Orthodox	♃	♀	♆
Esoteric	♃	∇	♃
Hierarchy	♀	∇	♃
Chaldean	♃	♂	⊙

☿	Five of Swords	Six of Swords	Seven of Swords
Orthodox	♠ ♠	♠ ♠	♠ ♠
Esoteric	♠	♠	♠
Hierarchy	♠	♠	♠
Chaldean	♠	♠	♠
♋	Eight of Cups	Nine of Cups	Ten of Cups
Orthodox	♠ ♠	♠	♠
Esoteric	♠	♠	♠
Hierarchy	♠	♠	♠
Chaldean	♠	♠	♠

This is a considerable amount to take in and it would probably have served to simply place the elemental triplicities here. I have personally found that the different planetary orders have quite an impact, especially if one works just before bedtime or first thing in the morning.

With this preliminary introduction concerning the planetary orders out of the way, we are now prepared to bring our attention to the work of meditation. Once again the planetary order used in these meditations will be the elementary triplicities.

There is no need to rush through these meditations. Begin with the meditations presented and set a steady pace. I would recommend that you allow a few days for each of these meditations so they have a chance to give a strong suggestion to the subconscious mind. Happy journey!

# Chapter X

## Meditations on the Minor Arcana

Working with the Minor Arcana is like finding the beginning of a circle. You can enter anywhere on the circumference you choose and begin your work. Since the minor keys represent times of the year, you can begin immediately and within one year complete the circle. One experiences a feeling of order when beginning the series at the Vernal Equinox, which marks the new zodiacal year, however this is not a requirement.

Working within the context of the zodiacal year causes us to move from suit to suit as we travel around the Cube of Space. Revelation concerning the process of creation, and the impact on sub-conscious patterns from use of the minor keys is quite profound. I could share my own experiences but in the final analysis it would be meaningless, for each individual has his or her own treasure house to be revealed.

There is one particular point that needs to be remembered when dealing with the Minor Arcana. The Minor Arcana is a system in which there is an orderly flow. Within that flow we can witness the interconnectedness of the signs, planets and keys.

This system of attributions to the minor keys is determined by:

- The sphere on the Tree of Life in which each minor key is placed
- The sign which rules the particular key
- The ruling and co-ruling planets of that sign and
- The sign and planetary ruler of the sign ruling the particular decanate.

With all of these considerations in view we can begin to see the elaborate and complex symbol system that the minor keys represent. Since the aces represent the quarters of the year, they do not fit into the wheel of decanates. Thus we begin our study of the Spring Equinox with the Two of Wands.



## The Decanates of Aries

In whatsoever object thou perceivest,  
 Know me as the Essence,  
 As the Idea,  
 And as the Interior Nature.  
 Because of this the wise come easily to me  
 By many paths,  
 Yet in truth these different roads  
 Are but a single Way.<sup>11</sup>



We will begin our study and meditations on the Minor Arcana with the sign of ♈, where the zodiacal year begins. We will work with the three decanates as they follow the currents of the Cube. There are three minor keys attributed to each sign. In the sign of ♈ we have the Two, Three, and Four of Wands.

♈, being a cardinal sign, initiates the beginning of the life cycle or the introduction of new enterprises. Nature gives testimony to this birth process year after year as the new cycle of growth begins. As in all cardinal signs, we find in ♈ the expression of the first aspect of Divinity, that of the **WILL**. The Will aspect originates in **כתר** and becomes diversified in the Supernal Triad, which contains the second and third aspects of Divinity, that of **LOVE/WISDOM**, seated in **חכמה**, and **ABSTRACT MIND** seated in **בינה**. The  $\Delta$  of ♈ then crosses the abyss into the Sphere of **חסד**, where the Supernal Triad is further diversified in the six subdivisions of **רוח**.

The location of the three decanates of the sign of ♈ is on the northeast descending corner. These decanates begin in the above northeast, and finish just before the intersection of the northeast below

point. The following diagram shows the location of these three decanates.

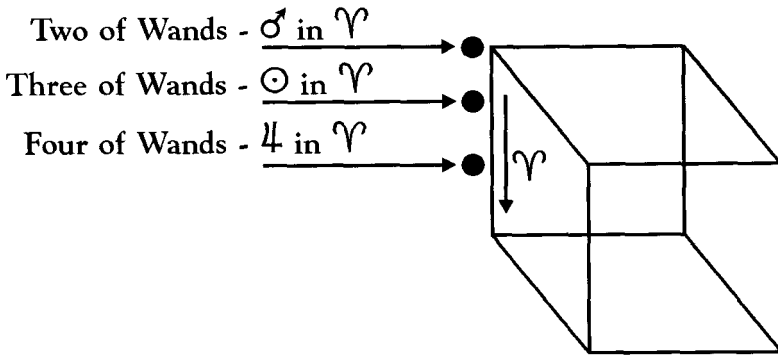

Figure 27.

As with all pip cards, the world of manifestation expressed by a minor key is indicated by the suit.

Suit	World	Element
Wands	אצילות	△
Cups	בריאה	▽
Swords	יצירה	△
Pentacles	עשיה	▽

Each of the minor keys is located on a sphere on the Tree of Life. The number of the minor key indicates the sphere. The placement of a minor key on the zodiacal wheel tells us the particular sign that is attributed to the minor key. Knowing the sign, we then insert the planetary rulers of the decanates to which the particular minor key is assigned. When we take into consideration the various attributions of a minor key, we can articulate that minor key into major keys. When we then place the constituent major keys together that are represented by a particular minor key, we can gain a deeper understanding of the symbolism represented by the original minor key. This allows us to employ our knowledge of sound and color as we meditate upon each minor key.

## The Two of Wands

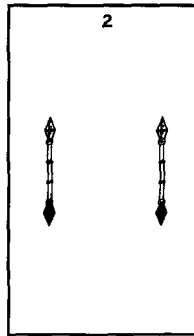

Given the above information concerning the attributions for minor keys, we can set ourselves to work concerning our meditations. Since we are working with the suit of Wands, we are dealing with the World of **אצילות**. Since the number of this key is 2, we know that it is representative of the second sphere, **חכמה**.

We therefore know that with the Two of Wands, we are dealing with:

- Key 20 (Judgement), representing the Sphere of **חכמה**,
- Key 4 (The Emperor), attributed to the sign of  $\Upsilon$ , and
- Key 16 (The Tower), attributed to the planet  $\♁$ .

Since  $\Upsilon$  is its own ruler in its first decanate, there is no sub-ruling sign or planet in the elemental order of triplicities. Since the principle of the Life Force,  $\♁$ , is attributed to **חכמה**, we have assigned Key 20 and the letter **ש**. This will assist us in attuning to the second sphere on the Tree of Life in the World of **אצילות**.

Of the 78 cards in the Tarot deck, the Two of Wands is the most expressive of the element of  $\Delta$ . The  $\Delta$  attributions for the Two of Wands are:

- The  $\Delta$  of  $\♀$ , Key 20 (Judgement), representative of the Sphere of **חכמה**;
- The  $\Delta$  of  $\Upsilon$ , represented by Key 4 (The Emperor); and
- The  $\Delta$  of  $\♁$ , Key 16 (The Tower), ruler of the sign of  $\Upsilon$ .

The Two of Wands represents the cardinal or initiating sign of

ו', which is ruled by ♂ and is seated in the Sphere of חכמה, in the fiery World of אצילות. The Two of Wands receives the influence of the principle of the Life Force, ♋ or ש. With all these Δ attributions we find we have the very essence of fire represented in this potent symbol.

Together these articulated keys create the necessary tension and force to initiate the process of creation. It is the ultimate intention of the Divine Mind to express this cosmic Δ through its refined and receptive forms.

The line and point on the Cube of Space where the Two of Wands is located is on the northeast line. It originates at the above northeast corner, which begins the process of descent toward the below face of the Cube of Space.

This particular key assists us in making contact with the Fiery Life Force as it emerges and descends from חכמה to the spheres below. The Two of Wands is חכמה in the World of אצילות, and is therefore the most abstract expression of the second sphere. On the Cube of Space, it is the initial descent into the subconscious aspect of our being, or the impregnation of בינה by חכמה.

Since חכמה is the reflection of כתר unto itself, it is representative of the awareness that the Central Self has of Itself. This awareness reveals the inherent infinite possibilities and wisdom that exist at the center of the Central Self. For humanity, the Two of Wands reveals our inner potencies and is the distributor of the highest aspect of wisdom. This wisdom is attainable through the higher aspect of Manus, and reveals that sublime triad of Atma/Buddhi/Manas, or The Crown/Wisdom/Understanding. The key principle that is demonstrated by this minor trump is true gnosis of the Wisdom and power of Pure Will.

The Two of Wands is the first demonstration of the Principle of Gender. This particular Hermetic Principle is perhaps the most misunderstood of the seven principles. The Principle of Gender states:

*Gender is in everything; everything has its masculine and feminine principle; Gender manifest on all planes.<sup>12</sup>*

The Two of Wands, representative of the Sphere of חכמה, is traditionally understood as a masculine sphere. The World of אצילות is also considered to be represented by the masculine primordial א. In spite of these masculine attributions, the second sphere expresses its feminine aspect as a receptive vessel for the first sphere כתר. Thus

the Two of Wands is a fiery expression of Sancta Sophia, the Holy Wisdom. There is little more that can be said concerning this and in reality there is no room for argument. One either experiences this Great Truth, has faith that it is truth, or the fact remains illusive leaving the student in ignorance.

### Meditation on the Two of Wands

פה – ♂ in ♀

To begin this meditation we take the Two of Wands along with the articulated major keys, Keys 20, 4, and 16.

Keys 4 and 16 represent both the vision that is seen with the mind's eye, through Key 4, and the voice of the creative word, as expressed through Key 16. Thus it is written in the *Book of Tokens*,

“For the Letter Heh concealeth the Word,  
And the Word is as truly a vision as it is a voice  
With me there is no difference between speech and sight.  
In very truth, I utter myself by seeing.”<sup>13</sup>

Together Keys 4 and 16 add up to a total of 85, which is the numerical value of (Peh) פה, the mouth as an organ of speech.

“Man does not live by bread alone but all that  
comes from the mouth (פה) of יהוה.”<sup>14</sup>

In these meditations we will be placing the particular Tarot key representative of the indicated sphere first, then the sign and planet. Since we are working with the Sphere of חכמה in the World of אצילות, we open our meditation with the appropriate Divine Name. This is of course done after the initial attunement mentioned in Chapter I. There are three names attributed to this sphere, יה, יהו, and יהוה. The traditional instruction is to chant the name יהוה.

As you place your attention on these keys, envision the color red and intone the note C. Notice that each of these keys are colored RED, and have the note C as their musical correspondent. This is another indication of the intense Δ aspect of the Two of Wands. As with all the other meditations, chant the sacred word A-O-M three times.

According to Dr. Case, the Two of Wands indicates a show of force,

enterprise, boldness, resolution, as well as combativeness. There are always the negative aspects or ill-dignified meanings. Remember that the primary meaning of this minor trump is the  $\Delta$  of Will whether positively or negatively expressed. It is our intention in this meditation to express the positive side of Will.

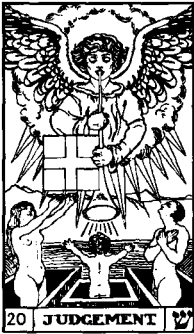
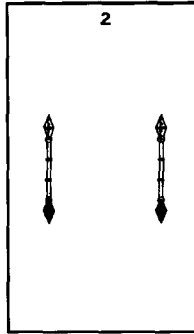

For the sake of understanding the timing for each minor Tarot key, we add the points of the year in which it rules. This can be useful in attuning to a particular season or time of year, or help within the framework of a given meditation. This can also be helpful if one employs a spread in an attempt to gain deeper wisdom concerning the particular conditions of one's life. The Two of Wands represents the time of the Spring Equinox, from 21 March to 30 March. The primary word to describe the Two of Wands is **DOMINION**.

## The Three of Wands

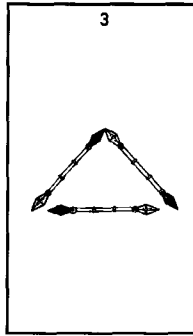

The Three of Wands represents the Sphere of **בינה** in the World of **אצילות**. This is the  $\nabla$  of  $\eta$  in the  $\Delta$  of  $\iota$ . The Sphere of **בינה** is representative of alchemical  $\Theta$ . **בינה** in **אצילות** gives us knowledge of the principle behind and the essence of the World of Form. An experience of the principle behind limitation develops the power of discrimination. The principle of  $\Theta$  allows for the containment of the principle of  $\ddot{\alpha}$ , the Life Force. The principle of  $\ddot{\gamma}$  is the principle of consciousness that pervades them both. **בינה** is also the movement from unity into diversity.

As it is with all minor keys in the suit of Wands, we are dealing specifically with the principles, or abstract idea behind the manifested form. Thus in the meditations on the keys bearing the suit of Wands, we can gain some experience, through the power of attention, of the eternal principle behind the physical plane of existence.

The  $\odot$  rules the second decanate of  $\Upsilon$ , and is also exalted in that sign. The Three of Wands therefore represents the highest expressions of the  $\odot$ . Remember that the  $\odot$  is yet another symbol for the soul, and for the Sphere of **תפארת**. As we work with the Tarot, we must ever keep in mind that it represents the story of the soul itself.

As we begin our meditation on the Three of Wands, we follow the same method of articulation used with the Two of Wands. This method will carry through the remainder of this work.

The articulated keys for the Three of Wands are:

- Key 21 (The World),  $\eta$ , Planetary signature of **בינה**;
- Key 4 (The Emperor), the sign of  $\Upsilon$ ;
- Key 16 (The Tower),  $\sigma$ , ruler of  $\Upsilon$ ;

- Key 8 (Strength),  $\mathcal{Q}$ , ruler of the second decanate of  $\mathcal{V}$ ;  
and
- Key 19 (The Sun),  $\odot$ , ruler of  $\mathcal{Q}$ .

The Three of Wands is located on the northeast line of the Cube of Space just below the Two of Wands as pictured in the previous diagram of the Cube of Space.

We are now fully engaged in the process of descent. The self-conscious mind is moving from the ontological plane of objective conscious awareness to an ontological plane of subjective reality. This subjective realm belongs to subconsciousness. In this process of descent one works on creating the potent suggestion to be placed in the subconscious mind, as well as bringing oneself in contact with a true **Understanding** of the inner nature of the self which awaits all seekers who enter this domain.

The goal of this meditation is to gain access to the highest aspect of discrimination, which is the very principle behind form and separation. The Three of Wands represents the principle behind the  $\Delta$  of creation, separation, and the descent of Spirit into matter.

Thus do we find that the symbol for the Three of Wands is an upward pointing equilateral triangle. This triangle is made of three wands, with an octahedron at the ends of each wand.

Both the tetrahedron and the octahedron are the constituent parts of a cube. The star tetrahedron forms the exterior portion of the Cube of Space while the octahedron exists at the center of the Cube. These are symbols of the Fiery Life Force, which finds itself contained within the form.

We begin this meditation by placing the necessary keys in front of us.



### Meditation on the Three of Wands

הר - ☉ in  $\Upsilon$

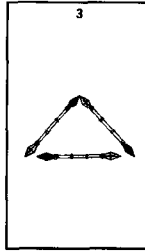

Begin by chanting the Divine Name attributed to the Sphere of **בינה**, which is **אלהים**. The notes are A, F<sup>#</sup>, C, F, and G<sup>#</sup>. This vibratory formula is representative of the creative idea contained within due boundaries.

Next, place your attention on Key 21, which is the sephirothic container for the Three of Wands. Move from key to key, focusing your attention on each for about one minute. As you begin with Key 21, sound the note A. As you move to Key 4 and 16, repeat the note C. Key 8 is E, and Key 19 is D. Notice that the color is moving from red, predominant in the Two of Wands, to orange and yellow. This is an indication of a cooling process in which the heat of the Two of Wands is congealing into a more specific idea.

**בינה**, the seat of the Three of Wands, has a value of 67. **זין** also has a value of 67. **זין** is the path that leads from **בינה** to the Sphere of **תפארת**, which is the Sphere of the ☉. Thus the ☉ in  $\Upsilon$ , the Three of Wands, is an expression of the movement of the Supernal Triad as it gives birth to the Divine Ego.

As an attunement for this meditation, consider the Mother of All Forms, organizing and constituting the fiery life force under the power

of love, which gives birth to the Soul, and to the Son of the Most High. The Soul or Sun is the direct expression of the Divine Soul seated in the Sphere of **בינה**. It is the Divine Soul **נשמה**, which is the mother of all Souls of which **תפארת**, the Son, is a manifestation.

The time frame for the Three of Wands is from 31 March to 1 April. The key divinatory meaning for the Three of Wands is **ESTABLISHED STRENGTH**.

### The Four of Wands

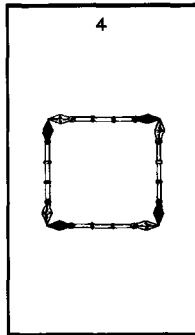

The Four of Wands continues the process of descent along the northeast line. We now enter into the Sphere of **חסד**, expressed in the World of **אצילות**. **חסד** is assigned to memory, both personal and cosmic. The Sphere of **חסד** is the first of the six subdivisions of **רוח**, which makes up the constitution of the microcosmic man.

Memory itself is the basis on which we make the necessary adjustments in order to make the desired results manifest in the future. In the World of **אצולת**, this memory is the memory of all that ever was, is, or will be.

The principle of memory and the beneficent qualities associated with **חסד** are the direct reflection of the power of **חכמה** after it has come into direct contact with **בינה**. Thus we see that there is a marked difference between the descent of the path of **ה** and **ו**. **ה** represents the essence of **חכמה**, while the descent of **ו** into the Sphere of **חסד** is the fruit of this connection between **חכמה** and **בינה** through the path of **ד**.

The Four of Wands is the final decanate in the sign of ♋. The articulation of the Four of Wands involves:

- Key 10 (Wheel of Fortune), representing the Sphere of חסד;
- Key 4 (The Emperor), the sign of ♋;
- Key 16 (The Tower), ♂ ruler of ♋;
- Key 14 (Temperance), ♂ sub-ruler of the third decanate of ♋; and
- Key 10 (Wheel of Fortune), ♋, ruler of ♋.

The location of the Four of Wands is just above the bottom point of the northeast corner of the Cube of Space. This has been shown in the earlier figure of the Cube.

### Meditation on the Four of Wands

#### הב - 4 in ♋

Since the Four of Wands is the first expression of the qualities of חסד on the Tree of Life, it is important to note that in the World of אצילות it is in its perfected state. The necessary balance exists between the fiery aspect of the Fifth Sphere of גבורה and חסד. חסד, being the reflection of חכמה, has a value of 72; this is also the value of יהוה spelled in full, יהוה יהי ויוהי. This is the full expression of the name given to the second sphere.

It is the goal and attunement of this meditation to develop the outward expression of loving compassion motivated by the Fiery Will to Good. This indicates a balanced expression of compassion and not a weak platitude that creates the environment for evil.

The same procedure unfolds with this as well as future meditations. Place the Four of Wands before you with the articulated major keys below it.

Begin by chanting the Divine Name for חסד which is אל. Besides being the shortest spelling of any of the Divine Names in Hebrew, אל is also the same name for God in Islam, Al Lah. Perhaps the most important idea in this meditation is that the Divine Name אל indicates the movement towards the center of the self, for אל is also a preposition indicating movement towards something.

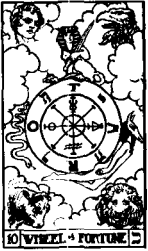
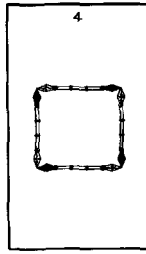

Focus your attention on the Four of Wands, the compact symbol representing the articulated keys below. After a couple of minutes, chant the note A<sup>#</sup>, which identifies the Sphere of **קסד** and Key 10 (Wheel of Fortune). After this, follow as before with the corresponding notes and keys. C for Keys 4 and 16, G<sup>#</sup> for Key 14, and again A<sup>#</sup> for Key 10. The time period for the Four of Wands is from 10 April to 19 April. The key word for the Four of Wands is **PERFECTED WORK**.



# Chapter XI

## The Three Decanates of ♄

The Creator is myself,  
And I am the Nail, which joineth thee to me.  
In thee am I ever present,  
And thou hast only to turn within to find me.<sup>13</sup>



As we begin our meditations on the three decanates of ♄, let us reflect on the vehicle of ♄ which expresses the elemental triplicity ♁.

♄ is the fixed earthy sign which expresses the descent of מזלה, after the union of the spheres of חכמה, and בינה. As discussed in the meditations concerning the decanates of ♃, we know that ♃ expresses חכמה in its masculine aspect, while ♄ expresses חכמה through its feminine aspect. Notice that ♂ and the ☉ are the ruling and exalted planets in ♃, while ♀ and the ☽ are the ruling and exalted planets of ♄.

Key 5 relates to the function of hearing and the letter ו. ו is the principle of cohesion, that which holds forms together. **Congelation** is the alchemical operation attributed to ו. There are different levels of linkage that are necessary to understand as we move through graded levels of the constitution of man, the worlds of the Tree of Life and the currents of the Cube of Space.

Consider the ontological plane of personality and sense experience. The letter **י** is concerned with the development of each of the three aspects: mental, astral, and physical/etheric. Upon completion of the establishment of strong centers, all three become linked and fused and function as a single unit.

On the ontological plane of the soul, the letter **י** links the soul to the organized and synthesized personality, where the four—the three aspects of personality and the soul—become one.

On the ontological plane of spirit or monadic life, the soul gives way to the principle of spirit, and thus, The One expresses itself through form.

In all suits, the cardinal signs represent the second, third, and fourth spheres on the Tree of Life. The fixed signs represent the fifth, sixth, and seventh spheres. Because **♃** is within the triplcity of **♋**, we know that spheres 5, 6, and 7 are being expressed in the World of **עשיה**, the world of physical manifestation. As we work with these three decanates, we must think in terms of the higher Egoic Triad, which brings its influence to the personality.

The locations of the decanates of **♃** are on the ascending south-east line. The decanates begin at the terminating point of **♄**, and ascend just below the above southeast corner, where the currents flow into the sign of **♈**. The following diagram shows their locations.

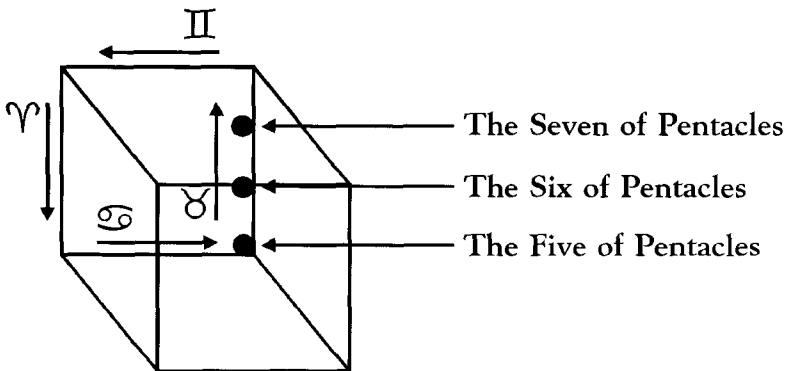
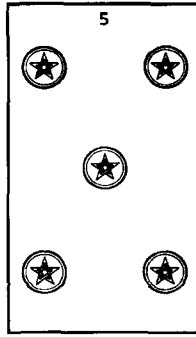

Figure 28.

## The Five of Pentacles



The Five of Pentacles represents the Sphere of **גבורה**, in the World of **עשיה**. It is represented by ♀ in ⚄. The Five of Pentacles expresses the aspect of personality called volition. It is the second of the six subdivisions of **רוח**. Thus in order to use the power of cohesion and linkage, to which the letter **ו** is attributed, we must develop a true understanding of volition. Volition is the power of Will expressed through human personality. Those born under the sign of ⚄ have often been called willful. Meditation on the Five of Pentacles helps us develop the positive aspects of will.

Volition is concerned with activity. Whenever this aspect of human personality is immature, the result tends to be selfishness and cruelty. For one to become a master of compassion, he must first become a master of volition.

The major keys that articulate the Five of Pentacles are:

- Key 16 (The Tower), ♂, the planetary signature of **גבורה**;
- Key 5 (The Hierophant), and the sign of ⚄; and
- Key 3 (The Empress), ♀, the ruler of ⚄.

The Five of Pentacles is located on the southeast ascending line and performs the opposite function, as did the northeastern line given to ♀. Therefore, ⚄ is in an ascending mode, moving from the level of the subconscious state, while ♀ is in a descending mode moving from self-conscious awareness to the subconscious mind.

There is some fundamental esoteric information concerning the ascent of ⚄ on the southwest corner anent creation. This has to do with the implementation of **WILL** in the four aspects of the creative



process. These are:

- TO KNOW
- TO WILL
- TO DARE
- TO KEEP SILENT

These four aspects of creation involve the implementation of the intention to create. TO KNOW is using the fiery will of the mind to formulate the initial act of intention. TO WILL is creating the necessary point of tension through use of the fiery power of creative imaging. TO DARE is moving into the activity of creation through very specific action intended to bring about the desired result. TO KEEP SILENT is exercising the will by holding a point of tension until the form is brought forth.

The fundamental quality of volition is change. Volition involves the desire to create a different set of circumstances than presently exist. In Arthur Waite's version of the Five of Pentacles, he shows two individuals in apparently dire straits. The influence necessary to change their condition requires an act of volition. This particular representation is a far cry from the soul level of expression that is given by the two major keys of The Hierophant and The Empress. These two major keys indicate Strength, Wisdom and Beauty. We are always in the process of adjusting the conditions in our lives in order to become more comfortable in the world we live. The work, until completed, will require each of us to develop our WILL.

### **Meditation on the Five of Pentacles**

♁ – ♀ in ☿

Begin by placing the Five of Pentacles before you, followed by the articulated major keys associated with the Five of Pentacles. These are Keys 5, 6, and 16.

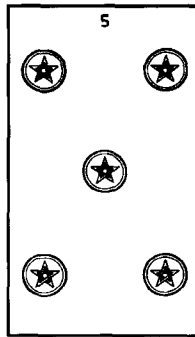

Because we are dealing with the World of עשיה, we use the name of the planetary logos of גבורה, which in this case is מַאֲדִים, מַאֲדִים. The notes for this name are G<sup>#</sup>, E, F<sup>#</sup>, F, and G<sup>#</sup>. The name מַאֲדִים means “Powers of Vehement Strength.” In the book of Daniel we are told the story of Daniel in the Lions’ Den. Daniel, דְּנִיָּאל, which has the same numerical value as מַאֲדִים, which is 95, instructs us concerning the power of the fiery life force as it manifests through the animal kingdom. When the vital soul is approached with love and fearlessness, it cannot harm us. When fear rules it will present itself as an inimical force. Therefore fear is failure.

After placing your attention on the Five of Pentacles for a few minutes, sound the notes associated with the keys as you move from one to the other. Key 16 is C, Key 5 is C<sup>#</sup>, and Key 3 is F<sup>#</sup>. Feel the inner strength which causes us to move through life with courage, and the spirit of fearlessness.

The time attributed to the Five of Pentacles is from 20 to 29 April.

The key divinatory meaning for this minor trump is Uncertainty, or Material Trouble.

### The Six of Pentacles

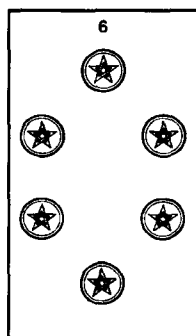

Because the Six of Pentacles is the second decanate of  $\Upsilon$ , it is sub-ruled by the planet  $\text{♀}$  and the sign  $\text{♍}$ . The Six of Pentacles represents the Sphere of **תפארת** in the World of **עשיה**. Because this is the World of **עשיה**, we know that the Six of Pentacles represents:

- The synthesis of the threefold personality, physical/etheric, emotional, and mental;
- The infusion of solar consciousness in the human personality; and
- The expression of the Divine Ego, through personality, in the world of every day.

This is the testimony of those who have attained to this consciousness. It is not an idle fancy or dreamy platitude, but becomes a living waking physical reality.

The major keys that articulate the Six of Pentacles are:

- Key 19 (The Sun),  $\odot$ , planetary signature of **תפארת**;
- Key 5 (The Hierophant), the sign of  $\Upsilon$ ;
- Key 3 (The Empress),  $\text{♀}$ , the ruler of  $\Upsilon$ ;
- Key 9 (The Hermit),  $\text{♁}$ , ruler of the second decanate of  $\Upsilon$ ;
- and
- Key 1 (The Magician),  $\text{♃}$ , ruler of the sign of  $\text{♍}$ .

The Six of Pentacles represents the manifested body of the ☉, that is, the luminary we witness during the day. Through our meditations we can begin to understand the implications anent the attributions of the letter ו to ז, and to the Sphere of תפארת. There are frequent cross attributions between the ☉ and ז, ו, ר, and ב. We find that on the Tree of Life, the Sphere of תפארת receives the color attribution of הוד, while the Sphere of הוד receives the color attribution of תפארת. This is also true of the planetary and archangelic rulers. The Tibetan Master D. K. points out in *Esoteric Astrology* that, “The Sun and Mercury are One.”

Note that the Six of Pentacles is sub-ruled by ז. The Six of Pentacles also points to the relationship between the congealing and organizing factors of ו anent the personality and the soul. Since the letter ו is attributed to:

- ז;
- תפארת;
- The central Ego;
- The Triumphant and Eternal Intelligence;
- The distribution of מזלה from חכמה to חסד; and
- The alchemical operation of **congelation**.

we can begin to understand the implications involved in invoking such a potent symbol as the Six of Pentacles. Remember that the hexagram is a symbol of the macrocosm, manifesting itself in the microcosm. This alludes to the reason behind the cross attributions. For as the personality is itself a logos of a lower nature, so it correlates with the soul. As the soul becomes the predominant controlling force within the field of personality, there is an amalgam created. ז, the ☉, and the ד are joined together as one substance, or one functioning unit of expression.

The location of the Six of Pentacles on the Cube of Space is just above the Five of Pentacles, on the southeast ascending line, as indicated in the earlier diagram.

### Meditation on the Six of Pentacles

כז – הָ in ח

Begin by placing the Six of Pentacles before you followed by the articulated major Keys 19, 5, 3, 9, and 1.

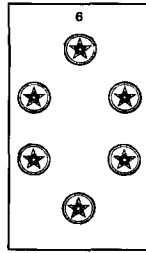

After the usual series of Divine Names, intone the planetary name for The Sun, שמש. The notes are C, G#, and C. Then bring your focus to the Six of Pentacles. After focusing for a couple of minutes, bring your attention to the articulated keys and intone each of the notes that correspond to the major keys. These are D, C#, F#, F, and E. We are seeking to deepen the conscious contact with that aspect we call the soul, so that it becomes the major mode of expression through the personality, thus returning the מלך to his throne.

The time frame for the Six of Pentacles is from 30 April to 10 May. The key word is PROSPERITY.

## The Seven of Pentacles

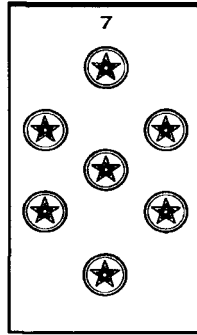

As the fives are seated in **גבורה** and the sixes in **תפארה**, so the sevens are located in **נצה**. Thus the Seven of Pentacles is the manifestation of the Sphere of ♀ in the World of **עשיה**, the World of Name and Form. The Sphere of **נצה**, is a line of demarcation between the lower Egoic Triad and the higher Egoic Triad. In the Rosicrucian Grades of Initiation, **נצה** in its early stages is the advanced expression of the lower triad, and in its later stage bridges the lower with the higher. It is the place where the initiate dies to the little self and is born to the Divine Ego. Therefore the Seven of Pentacles represents this twofold step in the World of **עשיה**.

As we bring our attention to the first aspect of Divinity, that of Will, we can see the descent of WILL into the lower spheres. First there is the Crown of Primal Will, **כתר**. From our perspective, this is the origin of Will. The Will then descends and expresses through **גבורה**, the seat of volition, which, in the constitution of man, is one of the six subdivisions of **רוח**. Finally this Will is expressed through the desire nature through the Sphere of **נצה**. As we learn to align our will to the One Will, our desires are purified, disciplined, and come to reflect the renewing aspect represented by the sub-ruler of the third decanate of ♀, ♂.

The articulation of the Seven of Pentacles is through the following major keys:

- Key 3 (The Empress), representing the planetary signature of **נצה**;
- Key 5 (The Hierophant), ♂;
- Key 3 (The Empress), ♀, the ruler of ♂;

- Key 15 (The Devil),  $\mathcal{A}$ , the sub-ruler of the third decanate of  $\mathcal{Y}$ ; and
- Key 21 (The World),  $\mathfrak{h}$ , the ruler of  $\mathcal{A}$ .

The Seven of Pentacles is located just above the Six of Pentacles on the southeast ascending line on the Cube of Space. Refer to the earlier diagram in this chapter for a visual location.

Because  $\mathcal{Y}$  is ruled by  $\mathfrak{f}$ , and the third decanate of  $\mathcal{Y}$  is located in the Sphere of **נצח**, which is the Sphere of  $\mathfrak{f}$ , we have a very strong influence from the intelligence of  $\mathfrak{f}$ .

The Sphere of  $\mathfrak{f}$  is called the seat of desire. The term desire creates a tremendous conflict and lack of understanding with our eastern brethren, who teach us to kill desire. The paradox or difficulty stems from our understanding of the aspect of Will. What is the difference between killing desire, and surrendering our desire nature to the One Ego? **DESIRE IS WILL**, manifested in the lower Egoic Triad, and there is no difference between killing desire in the eastern sense, and the surrendering of our Will/Desire nature to the One Ego. You will notice that the path connecting **נצח** to **תפארת** is Key 13 (Death).

$\mathfrak{h}$  rules the third decanate of  $\mathcal{Y}$ . The power of  $\mathfrak{h}$  is the power to limit. Because Key 21 represents both  $\mathfrak{h}$  and  $\nabla$ , we can see that the Seven of Pentacles is representative of crystallization ( $\mathfrak{h}$ ) of our creative images ( $\mathfrak{f}$ ) into tangible physical forms ( $\nabla$ ).

The Hidden or Occult Intelligence is attributed to the Sphere of **נצח**. Because the Seven of Pentacles is ascending from the below or subconscious level of awareness to the above self-conscious level, it symbolizes the manifestation of the invisible  $\nabla$  into the visible manifested  $\nabla$ . This power to manifest is a hidden power and is the power of Will cloaked by Desire.

The planetary name for  $\mathfrak{f}$  is **נונה**, whose value is the same as **דין**, the highest name for **גבורה**, the Sphere of Volition.

### Meditation on the Seven of Pentacles

**ות** –  $\mathfrak{h}$  in  $\mathcal{Y}$

The key intention behind this meditation is the right development of Will/Desire, and the successful manifestation of the creative image into form. In order for this process to take place, it is imperative that we take our creative process in hand, invite the Inner Teacher,  $\mathcal{Y}$ ,

The Hierophant, and take the posture of the two mendicants pictured in Key 5. To be aware that we are continually using the power of the creative image will cause us to use caution with our thoughts, words, and deeds.

Because of our limited sensory awareness, ♀ cannot create the perfected images we seek to manifest. It requires the power of intuition, which comes to us from the Inner Teacher.

The combination of the articulated major keys symbolized by the Seven of Pentacles assists in revealing the power of Desire/Will to Love. This power can change the subconscious thought process into a new harmonious state ever more aligned with the Central Ego of the One Life.

To begin the meditation on the Seven of Pentacles place the minor key before you along with the articulated major keys. Then begin with the usual attunement.

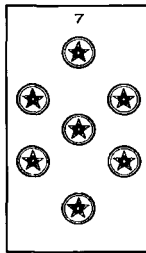

After the usual attunement, chant the planetary name for נצח, Sphere of ♀, which is נונה. The notes are G, C<sup>#</sup>, G<sup>#</sup>, C. Then follow with the appropriate notes for the articulated keys. F<sup>#</sup>, C<sup>#</sup>, F<sup>#</sup>, A, A.

The time frame for the Seven of Pentacles is from 11 May, to 20 May. The key meaning is LOSS.

This completes the meditations on the three decanates of ♃.





# Chapter XII

## The Decanates of II

I am the sword,  
The sword which is understanding,  
Dividing between the darkness and the light  
At creations dawn.<sup>14</sup>



In our first two signs of the zodiac we find the flow of consciousness either ascending or descending. With the sign of II, we find the flow of consciousness circulating on the east above line. The direction of the current of II is from south to north by way of the east.

Alchemically the sign of II represents the stage of **fixation**. The stage of fixation is the establishment of boundaries or the creating of a container for the three alchemical principles of ♀, ♂, and ⊖. On the Tree of Life these principles are **כתר**, **חכמה**, and **בינה**. It is path of 7 through the sign of II which carries the three principles and places them within the container of the Divine Ego, the Sphere of **תפארת**.

We can see the descent of **נשמה**, the Divine Soul, from the Sphere of **בינה** to the Sphere of **תפארת**. This influence descends through the 17<sup>th</sup> path of 7, which is represented by Key 6 (The Lovers).

As with all signs associated with the element of Δ, II represents the electromagnetic fields that create the patterns that are established

in the World of **יצירה**. Because **II** is a mutable sign, it represents the final stages of descent within the World of **יצירה**. The Eight, Nine, and Ten of Swords symbolize this descent.

The World of **יצירה** is the world of patterns. These patterns can create the environment for all life's problems when they are made in an unconscious manner. These patterns may likewise create the environment for abundance, joy, health, and all manner of good things when one uses conscious awareness to form these patterns.

The training that all disciples must go through concerns this very fact. Are the patterns in our life supporting liberation or bondage? Do these patterns reflect the negative connotations that usually accompany the pictures representing the suit of Swords? Has there been a transformation within the life that reflects the very pictures that the articulated keys portray?

Most of the various Tarot decks that are out in the world bear pictures of struggle and woe anent the Suite of Swords. Pay particular attention to the articulated keys, for they will reveal the life of the soul functioning through the perfected personality, instead of the struggling separated personality.

The key to the three decanates of **II** lies in the fixation of the three principles within the earthly human, thus forming a vessel that will appropriately express the Buddhist nature.

To this end we can see that on the east above face, **II** takes the revelations from the ascending line of **♃** and begins the circulation process within self-consciousness, which develops the powers of discrimination at the self-conscious level.

As that which has been revealed becomes integrated within the life of every day, a new level of awareness shines forth and we become transformed, ready to make yet another descent into the lower face of the Cube.

The following diagram shows the placement of the three decanates of **II**, represented by the Eight, Nine, and Ten of Swords.

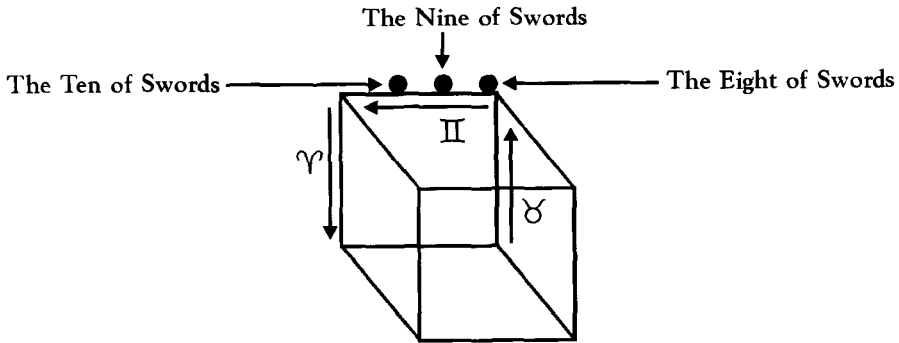
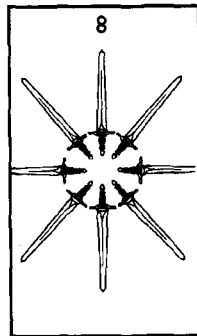

Figure 29.

### The Eight of Swords



The Eight of Swords is located in the Sphere of **הוור**, in the World of **יצירה**. The Eight of Swords expresses a strong mercurial influence. This is due to the fact that **II** is an airy mercurial sign, ruled by ♿ and the Sphere of **הוור**, which is expressed by the Eight of Swords, is the Sphere of ♿.

The major keys that articulate the Eight of Swords are:

- Key 1 (The Magician), ♿, representing the planetary signature of **הוור**, the Sphere of ♿;
- Key 6 (The Lovers), the sign of **II**; and
- Key 1 (The Magician), ♿, the ruler of **II**.

The Eight of Swords teaches us the power behind attention and observation. The Magician places his attention on his environment and makes accurate measurements concerning the present conditions. These accurate observations gives The Magician quick access to the storehouse of recorded events, held in custody by the High Priestess.

The right use of mind and placing the proper suggestions into the subconscious level verifies that the human personality is an instrument through which the One Life works. When we come to the conscious awareness that we can determine the patterns that shape our environment, we will be well on our way through the process of transmutation.

The Eight of Swords assists us in evaluating our present stage of development. We come to understand that our present situation is in direct response to conditions that have been set in the past.

### Meditation on the Eight of Swords

זב – ♄ in II

Begin this meditation by placing the Eight of Swords before you, followed by the articulated major keys that represent the Eight of Swords. These are Keys 1, 6, and 1.

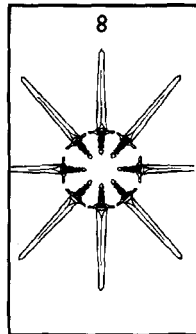



After beginning in the usual manner chant the name **בני אלהים**, which is the name of the Choir of Angels given to the Sphere of **הור** in the World of **יצירה**. These are the lesser builders that make up the substance forming the patterns in the World of **יצירה**. It is the destiny of humanity to work in conscious co-operation with this Devic, or Angelic Kingdom. After chanting this name focus your attention on the two keys and chant their designated notes. The notes are E, D, and E.

Seek to have your powers of observation and discrimination become sharpened by the sword of **ז**.

The Eight of Swords represents the time of year from 21 May to 31 May. The key word is **MEDIOCRITY**.

### The Nine of Swords

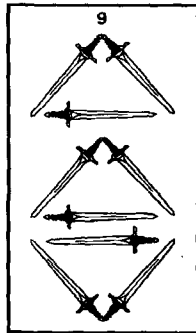

The Nine of Swords represents the ninth Sphere of **יסוד**, Sphere of the **ד**, in the World of **יצירה**. Astrologically the Nine of Swords represents the second decanate of **♏**, and is sub-ruled by ♀ in **♁**.

The major keys that articulate the Nine of Swords are:

- Key 2 (High Priestess), ♀, the planetary signature of the Sphere of יסוד;
- Key 6 (The Lovers), the sign of ♀;
- Key 1 (The Magician), ♃, the ruler of ♀;
- Key 11 (Justice), the ruler of the second decanate of ♀; and
- Key 3 (The Empress), the ruler of ♀.

If we look at the Nine of Swords, as presented by Dr. Waite, we see an individual sitting up in bed with hands covering his or her face. The key message behind this picture is the bondage that lies in our lives as long as we accept the precipitated illusion of the lunar lords. These illusions are created by humanity and must be transformed by humanity. These illusions are generated by:

- Our sense of personal, race, religious, national, and ethnic identities: separatism;
- The illusion of materialism; and
- The illusion of mortality.

We must endeavor to transform that which is imperfect in ourselves. We must also work toward the transformation of the collective lives within which we live.

יסוד is the sphere which holds the electromagnetic patterns which precipitate in the physical world. It is therefore necessary that we recognize the erroneous patterns (Eight of Swords), and bring those patterns into order so they no longer create the nightmare of separateness (Nine of Swords.) This requires a mental activity which always directs us to the *cause* of the patterns we seek to transform. Through our Qabalistic studies we can see that the erroneous patterns that exist in יסוד can be affected from the spheres of תפארת, נצח, and הוד. This is accomplished through the 25<sup>th</sup>, 28<sup>th</sup>, and 30<sup>th</sup> paths of ס, צ, and ר.

On the Cube of Space, these influences are three energies that flow into the southwest above corner. ו, which is the letter assigned to the World of יצירה and the Sphere of תפארת, flows from below to the above southeastern above corner. צ flows to the east from the west through the south above line. ר is the planetary center which rules the southern face of the Cube. The 25<sup>th</sup> path on the Tree of Life

and the west above line of **ס** flows into the south above line of **צ** and continue into the line of **ז**.

The following diagram demonstrates this flow of activity.

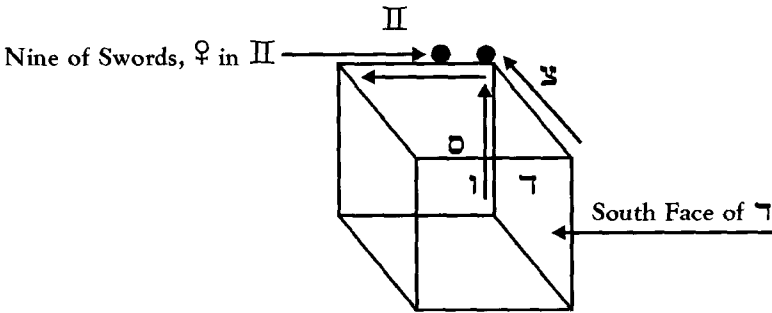

Figure 30.

The flow of these levels of consciousness is what eventually creates a receptive center to the conscious level of Buddhi. This is the true state of intuition, which flows from the Divine Soul **נשמה**, through the Central Ego of **תפארת**, into the vessel of human personality. To start this process of reception, begin with what is symbolically presented by the images of the articulated Nine of Swords.

Notice that the pattern of the swords in this minor key suggest reflection, contemplation, and meditation. Each triangle of Swords is a reflection of that which is above it.

**רוח**, the Life Breath, is one of the key points of focus. **רוח** is the soul as it descends from **בינה** to **תפארת**, to **יסוד**. These spheres represent the Divine Soul, the Egoic Soul, and the Vital Soul.

From a divinatory point of view the Nine of Swords rules from June 1 to June 10, and its traditional interpretation is that of Worry. Think in terms of mastery over the electromagnetic patterns of **יצירה**. This will ultimately cause any images of worry to fall away and reveal the shining soul, which is our one true nature.

### Meditation on the Nine of Swords

זז - ♀II

Place the articulated keys for the Nine of Swords before you as shown.



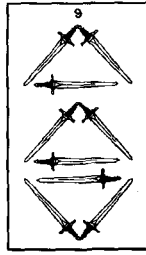

After intoning the Divine names, include the Divine name of Shaddai El Chai, שְׁדַי אֵל חַי, the Divine Name for יְסוּד. The notes for this Divine name are C, D<sup>#</sup>, F, E, F<sup>#</sup>, C<sup>#</sup> and F. After intoning the Divine Name, chant the angelic name כְּרַבִּיִּם, Kerabim. The notes for this name are A, D, E, F, and G<sup>#</sup>. This is the name for the lesser builders associated with the Sphere of the מ, לְבָנָה.

Open yourself to the flow of the Divine Soul, which showers intuitive realizations to all properly prepared vessels.

The time frame for the Nine of Swords is from 1 June to 10 June. The key word is **WORRY**.

### The Ten of Swords

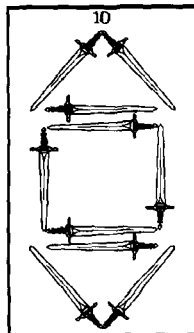

The Ten of Swords is the Sphere of מלכות in the World of יצירה. The Ten of Swords is symbolic of the completion of the electromagnetic patterns that will begin to precipitate into a physical form in the World of עשיה. Thus we find the electric and explosive planet of union, ט, joining forces with the planet of restriction, ח. These two planets are expressed in the third decanate of II, sub-ruled by ♁.

The major keys that articulate the Ten of Swords are:

- Key 21 (The World), representative of the planetary signature of ♃, and מלכות;
- Key 6 (The Lovers), the sign of II;
- Key 1 (The Magician), ♃, ruler of II;
- Key 17 (The Star), ♁, the ruler of the third decanate of II;
- Key 21, ח, co-ruler of ♁; and
- Key 0 (The Fool), ט, co-ruler of ♁.

The location of the Ten of Swords is towards the north end of the east above line. This line flows into the northeast corner where the two Δ signs of ♃ and ♁ begin their respective lines on the Cube. Thus we find that the terminating point of II can either continue to flow on the above face of the Cube, or begin its descent into the below face through the sign of ♃. The following diagram demonstrates this.

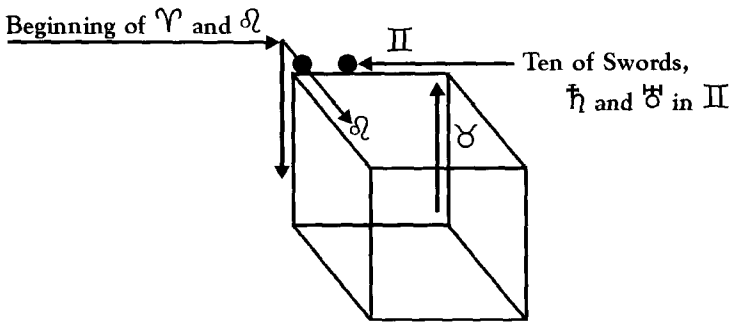

Figure 31.

The Ten of Swords represents the completion of the electromagnetic field, which creates the aura of the ring pass, which contains



the form to be manifested. It is now complete and the form may manifest within the Ring-Pass-Not. The energy behind the form is for the most part invisible to average humanity.

If we take this in the opposite direction, tracing the form aspect to the energy field and proceed back towards the cause of the form, we may begin to understand the principle behind the soul, and the phenomenon of death itself.

The idea that we can reverse the process of precipitation from effect to cause, or understand the cause behind the effect is demonstrated in two words in the Chaldean Aleph-Beth. The first is **מתנוצץ**, Mathanutzatz, meaning “resplendent”. This is the name given to the intelligence of **מלכות**. The second word is **גלגלים**, Galgalim, meaning whirlings. This is one of the titles given to **כתר**, the root of the Tree of Life. Thus the root and the fruit are one in the same, but in different stages of manifestation.

**נוף** is the constitutional attribution to man within the Sphere of **מלכות**. Within the World of **יצירה**, **נוף**, or the energetic field remains invisible, or veiled.

If we look at the grizzly image presented to us by the Waite version of the Ten of Swords, we see an individual lying face down with ten swords in his back. This is a rather grim picture and presents a different reality than that which lies behind the meaning of the Ten of Swords as it is articulated through the Major Arcana. The fact of the matter is the picture given to us by Dr. Waite is an accurate representation of the personality response mechanism when confronted with the unknown. The purpose of this key is to confront our fears around failure and death. The articulation of this key represents the perspective of the soul, one based on a sure knowledge of the reality that lies behind the form.

The rulership of  in the third decanate of **II** tells us much concerning the powers that are within man’s grasp. Alchemically  represents the process of **Dissolution**. This process of dissolution is that of bringing our problems, questions, or erroneous patterns and interpretations of our life’s experience into the arena of meditation. Once focused upon and dissolved into their principles they can be recombined into a deeper understanding of truth. As a result of this dissolution, we may learn to establish more positive patterns, which will lead to wisdom, understanding, and much joy in our lives.

## Meditation on the Ten of Swords

זת - הII

Begin by placing the articulated keys before you:

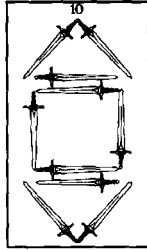

After intoning the Divine Names, include the name **השא אשים** **מע**, the name of the lesser builders of **מלכות** in the World of **יצירה**. After a couple of minutes of focused attention on the keys, intone the corresponding notes. They are A, D, E, A#, A, and E.

The intention behind this meditation is to develop a deeper awareness of the power which lies behind the form. Look at Key 21 and realize that the cosmic dancer lives and moves within the Ring-Pass-Not created by the powers symbolized by the Ten of Swords. The dancer is perfectly free from the limitations we traditionally associate with our physical world.

Key 6 reminds us of the continual guidance that is available for us so

long as we listen. Key 17 teaches us about the stability of the cosmic mind and how it reveals the truths that lie behind the form.

The time frame for the Ten of Swords is from 11 June to 21 June. The key word is **DESTRUCTION**.

# Chapter XIII

## The Decanates of ☽

I am the hedge of protection,  
Enclosing the field of existence.  
In this field thou dwellest,  
And I am thy defense  
Against the darkness which is without.



The sign of ☽ is the second of the cardinal signs. ☽ completes the first cycle of elements through the element of ♁. The idea of containment is the key to the decanates of this sign. On the Tree of Life, we see the sign of ☽ and the letter ך descending from the Sphere of ה. This descent creates the necessary limitations that allow for the expression of Will in גבורה. This Will, however, does not originate in the Sphere of גבורה, but in the Sphere of כתר.

The sign of ☽ completes or begins certain cycles:

- The cycle of elements;
- The cycle of quality (cardinal, fixed and mutable);
- The cycle of Tetragrammaton, יהוה;
- The end of the first and beginning of the second quarters of the year; and

- The sealing of the eastern face of the Cube.

The sign of  $\Upsilon$  is the first sign of the year beginning with the quality of cardinality.  $\omin�$  is the next of the cardinal signs and brings us to the element of  $\nabla$ . The cardinal signs govern the four quarters of the year and thus we find  $\omin�$  closing the Spring and beginning the Summer through the Summer Solstice.

We began our sealing of the eastern face of the Cube in the northeast through the sign of  $\Upsilon$ . In the sign of  $\omin�$  we find ourselves completing the eastern face. This can be seen in the following diagram.

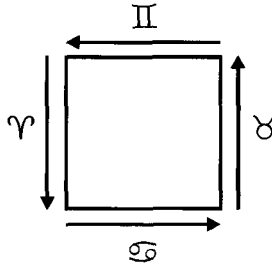

Figure 32.

The decanates of  $\omin�$  ride along the east below line traveling from the north to the south by way of the east. This is demonstrated in the following diagram.

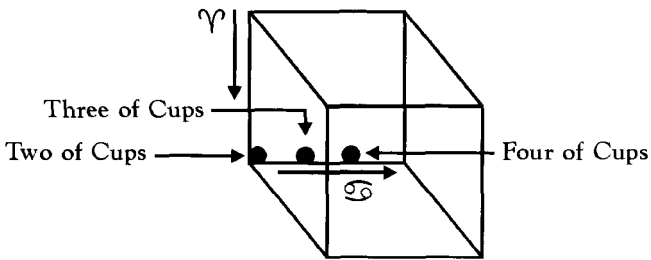
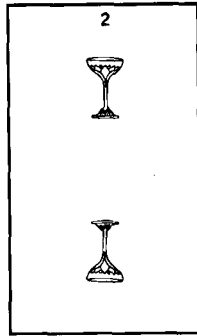

Figure 33.

## The Two of Cups



The Two of Cups is located in the Sphere of **חכמה**, in the World of Briah. This is the  $\nabla$  expression of **חכמה**. Since Briah is the Creative World, we find special meaning in the word “creative” anent the Two of Cups, for the verb “to create” literally means to separate, or to cut apart. This is the essence of the letter **ח**, as a container. The major keys that articulate the Two of Cups are:

- Key 20 (Judgement), symbolic of  $\text{♋}$  and the Fiery Life Force of **חכמה**;
- Key 7 (The Chariot), the sign of  $\text{♁}$ ; and
- Key 2 (High Priestess), the  $\text{♁}$ , ruler of the sign of  $\text{♁}$ .

We find that the Two of Cups is the  $\nabla$  to which the alchemists refer to as their *fiery water*. Thus we are told to “burn with water.” The Two of Cups is the emanation of the  $\Delta$  of **חכמה**, the  $\Delta$  of the Will of **כתר**, and the  $\Delta$  within the form of **פינה**. What we are dealing with is the  $\nabla$  of Life that the Master Jesus spoke of, as well as the  $\nabla$  in the vessel that the Aquarian Water Bearer carries.

The Two of Cups is located on the northeast end of the below line of  $\text{♁}$  as shown in the previous diagram.

Perhaps the main point of the Two of Cups, as well as any minor key bearing the number 2 is the idea of reflection. In this minor key we see two cups, one standing upright and the other reversed. This is the relationship between **כתר** and **חכמה**. The Two of Cups is a symbol of that which fills and that which is filled, that which radiates and that which reflects.



## Meditation on the Two of Cups

הג - דס

The meditation for this minor key begins with placing the Two of Cups along with the articulated major keys before you.

After chanting the Divine Names, chant the archangelic name **רציאל**. The notes for this name are, D, A<sup>#</sup>, F, E, and F<sup>#</sup>. This great angel is the chief of the mysteries and corresponds by number to 331, which is the value of the tribe of Epharim. Epharim is associated to the sign of ♄, the letter ך, and the revealer of the mysteries.

Focus your attention on the Two of Cups, and then on each of the major keys. After a few minutes intone the notes associated with each key. They are D<sup>#</sup>, G<sup>#</sup>, and C.

As you place your attention on these keys remember that this is the fiery water that takes the  $\Delta$  of Life and causes it to be placed within limits for specific expression. This meditation can assist us in gaining a deeper understanding of the unique way the  $\Delta$  of Life finds expression through us. These keys also assist us in the creative journey of impressing the proper images upon the *prima materia*, which causes all things to be made manifest.

Traditionally this minor key is associated with romantic love. The deeper aspect of love, to which this key alludes, is the passion for the soul. It is the soul that cries for expression through the personality, thus releasing the secret fiery  $\nabla$ .

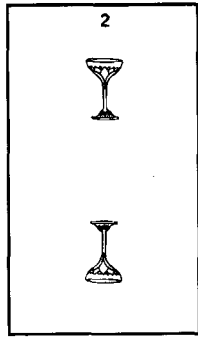

The time frame for the Two of Cups is from 22 June to 1 July. The key words are **RESPONSE TO ENVIRONMENT**.

### The Three of Cups

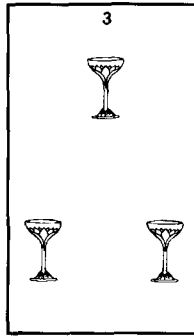

The Three of Cups is the expression of **בינה** in the World of Briah. This is the  $\nabla$  of  $\nabla$ . **בינה** is referred to as the root of  $\nabla$ , and the “Great Sea.” **בינה** is therefore associated with all aspects of the Mother Archetype, whether that archetype be manifested as the nurturing mother as personified by Venus, or the dark mother as manifested by Durga, or Kali.

The Three of Cups is a direct response to the Two of Cups. As the Two of Cups is the  $\Delta$  of  $\nabla$ , the Three of Cups contains that  $\Delta$  and causes the cosmic  $\Delta$  to become manifested within a particular form. Since **בינה** is the Sphere of  $\text{ה}$ , it represents the finitizing power of the  $\Delta$  aspect in the World of Name and Form. **בינה** itself condenses the spirit aspect in whatever world it is expressing. In **בריה** that condensing power is the element of  $\nabla$ . We can see that **בינה** represents the synthesis of the Supernal Triad. Thus the Three of Cups shows this synthesis in the World of **בריאה** by the triangle formed by the three cups as they appear on the Tree of Life.



Figure 34.

Since  $\text{מ}$  rules the second decanate of  $\text{ס}$  and  $\text{ז}$  rules the sign of  $\text{מ}$ ,

we find the Three of Cups being representative of ♂ in ☉. The major keys that articulate the Three of Cups are:

- Key 21 (The World), symbolic of the Sphere of **בינה**;
- Key 7 (The Chariot), ☉;
- Key 2 (High Priestess), the ♃, ruler of ☉;
- Key 16 (The Tower), ♂, ruler of ♁; and
- Key 13 (Death), ♁, the ruler of the second decanate of ☉.

The location of the Three of Cups is just to the south of the Two of Cups along the east below line of ☉, as indicated in the earlier diagram. Notice that the line of ☉ receives the influence of ♃ as ♃ flows from the above to the below into the east below line.

Because of the strong ♃ influence in the Three of Cups, we can understand that the limiting power of ♃ brings definition and boundaries to hazy ideas and restricts the continual flow of creative images. Thus the possibilities symbolized by the Two of Cups become clear images and are brought into manifestation through the Three of Cups.

Because the Minor Arcana is a fluid representation of the cosmic forces as they precipitate from possibility to physical form, we can say that the Three of Cups is a more definite expression of solidity than the Three of Wands. Suit by suit, world by world, the Life power brings its expression into ever denser forms, which are directed by images originating at the self-conscious level.

In **אצילות בינה**, **בריאה בינה** defines the archetype into a creative image; in **יצירה** there is a formation of the matrices of force which create the patterns that will eventually manifest in the World of Name and Form, the World of **אשה**.

The archangel attributed to the Sphere of **בינה** is **צפקיאל**. This name means the “contemplation of God,” which is the power behind the limitation of the creative image.

### Meditation on the Three of Cups

♁ - ☉

The meditation on the Three of Cups begins with laying out the Three of Cups along with the articulated keys.

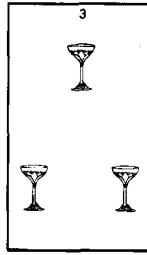

After the usual attunement, focus on the Three of Cups and chant the archangelic name **צפקיאל**. The notes for this name are A<sup>#</sup>, C, B, F, E, and F<sup>#</sup>. After a few minutes bring your attention to the articulated major keys. Then, after bathing your consciousness with these potent symbols, chant the appropriate notes: D<sup>#</sup>, G<sup>#</sup>, C, G, and A. Remember that this minor key represents the concretizing power which brings potential images into clear images, thus setting up the environment for the precipitation of Spirit, or the One Thing being turned into earth.

The time frame for the Three of Cups is from 2 July to 12 July. The key word is **ENJOYMENT**.

## The Four of Cups

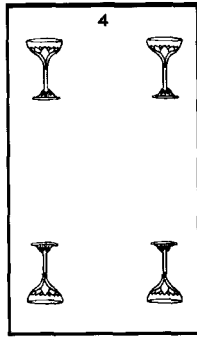

The Four of Cups brings us into the Sphere of  $\mathbb{L}$ . This expresses the quality of Beneficent Compassion and eternal supply. The Four of Cups is **חסד** in the  $\nabla$  of **בריאה**. The articulated major keys represented by the Four of Cups are:

- Key 10 (Wheel of Fortune), representing the Sphere of **חסד**;
- Key 7 (The Chariot), the sign of  $\mathfrak{C}$ ;
- Key 2 (High Priestess), the  $\mathfrak{D}$ , the ruler of  $\mathfrak{C}$ ;
- Key 18 (The Moon),  $\mathfrak{K}$ , the ruler of the third decanate of  $\mathfrak{C}$ ;
- Keys 10 (Wheel of Fortune),  $\mathbb{L}$ , and 12 (Hanged Man),  $\mathfrak{P}$ , co-rulers of  $\mathfrak{K}$ .

The Four of Cups is a powerful symbol for it initiates within our personal subconscious the very seeds of abundance, compassion, and good will. This creates two very important environments concerning transformation. The first is of a personal nature, and the second works on the collective level.

Because of the tremendous build up of memories and patterns both personal and collective, we find ourselves stuck in our journey maintaining our belief in lack, sickness, and fear. The Four of Cups gives the counter-suggestion of liberation and good of every kind. As we work with the Four of Cups we begin to change our very nature and align ourselves with the omnipresent conscious substance of the universe.

The main power at work here is creative imagination, but as the fourth

Sphere of the Tree of Life intimates through its name, Gedulah, גְּדוּלָה, our imaging requires an ardent zeal which propels our creative images with a firm impression upon the sub-conscious substance. As with the Two and Three of Cups we find the Four of Cups gliding along the below eastern line of the Cube, where it terminates at the below southeastern corner. Here the great magic of the subconscious process breaks through the lower boundary and forces itself upward through the fixed  $\nabla$  of  $\text{♃}$ . This movement results in some very powerful manifestations, namely:

- The manifestation of the creative image into a crystallized pattern;
- The revelation of a mystery by the voice of silence; and
- True Intuition.

Refer to the earlier diagram for the placement of the Four of Cups. We find on the Tree of Life that the Sphere of **חסד** receives its influence from above by the 16<sup>th</sup> path of  $\text{ו}$ , which on the Cube of Space is associated to the southeast line of the sign of  $\text{♃}$ . We also find that the 18<sup>th</sup> path of  $\text{ד}$  is parallel with the 16<sup>th</sup> path of  $\text{ו}$ , which hints at the intimate connection between the sign of  $\text{♃}$  and the sign of  $\text{♄}$ . The  $\text{ד}$  rules  $\text{♄}$ , yet finds exaltation in the sign of  $\text{♃}$ . From potential into manifestation, the universal substance clothes itself with infinite variety of form.

Thus we can understand that this particular minor key holds the proper impressions that will allow for many levels of awakening.

### Meditation on the Four of Cups

חמב – 44♄

We begin our meditation by placing the Four of Cups and the articulated major keys before you. Proceed with the usual attunement, and then chant the archangelic name associated with the Sphere of **חסד**. This name is **צדקיאל**. This name is representative of the power of recollection. The One Life always has perfect memory of itself. The notes for this name are A<sup>#</sup>, F<sup>#</sup>, B, F, E, and F<sup>#</sup>. After focusing on each key for a few minutes, chant the notes attributed to each one. The notes are, A<sup>#</sup>, D<sup>#</sup>, G<sup>#</sup>, B, A<sup>#</sup>, and G<sup>#</sup>.

The main idea behind this meditation is to work at establishing, within the personality complex and the collective personality of humanity, new patterns of abundance, compassion, and good will towards all sentient beings.

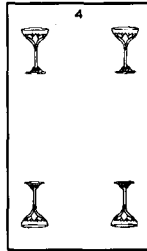

The time frame for the Four of Cups is from 13 July to 22 July. The key word is **OVERINDULGENCE**. Keep in mind that the key words are specifically attuned to the level of personality, and not to the life of the soul.





## Chapter XIV

### The Decanates of $\mathcal{Q}$

My secret wisdom is hid in number,  
And in the sign of the Tally  
Is concealed the building of the whole of creation.



This particular key and sign point to a major point of transformation within the personality complex. We have thus far considered the first four signs which bind the eastern face of the Cube. The sign of  $\mathcal{Q}$  and Key 8 move from the completed eastern face to the western face via the north above line. The intimations of this fact are many. Consider that the  $\odot$  is symbolic of both alchemical gold and the soul. In the sign of  $\mathcal{Q}$ , the  $\odot$  is the ruling planet. If we refer to *Esoteric Astrology* by Alice Bailey, we find that  $\mathcal{Q}$  is the only sign in which the same planet rules all three levels:

- Orthodox,
- Esoteric, and
- Hierarchical.

There are other considerations as well.  $\Psi$ , which is a co-ruler

in the sign of  $\aleph$ , is exalted in the sign of  $\delta\Omega$ .  $\Psi$  is located at the center of the Cube and finds its highest expression in the sign of personality when that personality is consciously directed by the soul. Early on we are faced with the delusions of glamour and life's various miasmatic presentations. These delusions are ruled by  $\Psi$ . As we learn to penetrate the veil and see things as they are, we shift to the higher mind, which is also ruled by  $\Psi$ .

We are told that gold is found in the North, but so is fools' gold, which is an iron sulfide. It is interesting to note that gold is often found in the company of these iron sulfide ores.  $\sigma$ , or iron, rules the North, and thus the very source of gold is found where the personality, through the sign of  $\delta\Omega$ , traverses the north above line.

The Intelligence of the Secret of all Spiritual Activities is attributed to  $\beth$  and Key 8. Thus we find that the transformation we seek takes place within the personality which has heretofore been dominated by the animal nature. Key 8 symbolically demonstrates the result of the influence of the Soul over the personality and the animal nature.

Key 8, the 19<sup>th</sup> path, connects the Sphere of  $\text{חֶסֶד}$  to  $\text{גְּבוּרָה}$ . This is the establishing of balance between severity and compassion, strength and love. The 19<sup>th</sup> path is one of the three paths that connect the pillars of Mercy and Severity.

The following minor keys give potent suggestions to the subconscious level. This creates the environment for the expressing of this higher aspect of our being, which is the Soul governing the lower nature.

The location of the three decanates of  $\delta\Omega$  are on the north above line, beginning in the northeast and terminating in the northwest. At the terminal point of  $\delta\Omega$ , the disciple can choose whether to descend the northwest line of  $\underline{\omega}$ , or continue traveling the above face through the west above line of  $\aleph$ . The following diagram shows the location of these keys.

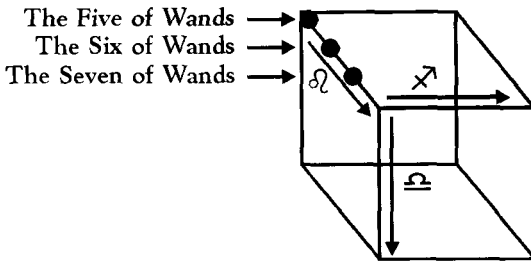
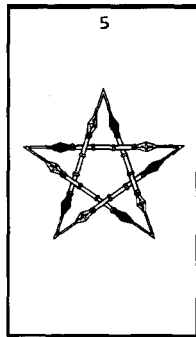

Figure 35.

### The Five of Wands



The Five of Wands is **גבורה** in **אצילות**. The wands represent the first aspect of Divinity, Will. The Soul itself is representative of the second aspect of Divinity, Love/Wisdom. Thus we have the Will aspect working through the Soul, which in turn works through the personality of  $\Omega$ . This idea brings us back to the notion that the 19<sup>th</sup> path is the balance of Mercy and Severity.

If we refer back to the decanates of  $\Upsilon$ , we will see that the Sphere of **חסד** is represented by the Four of Wands, **4** in  $\Upsilon$ . Thus the sign of  $\Omega$  continues the process of expressing Divine Will through the second of the six subdivisions of **רוח**. This is the experience of volition as being personal.

The articulated keys within the Five of Wands are:

- Key 16,  $\sigma$ , representative of the fifth Sphere of **גבורה**;

- Key 8, representative of the sign of  $\delta$ ;
- Key 19, representative of the  $\odot$ , ruler of  $\delta$ .

As we saw in Chapter 4 in the diagram of the alchemical sky,  $\delta$  is the only sign ruled by the  $\odot$ , and  $\text{♁}$  the only sign to be ruled by the  $\text{♃}$ . All other inner planets rule two signs. Thus we find that in the completion of the binding of the eastern face of the Cube by the sign of  $\text{♁}$ , the lunar aspect, we move to the west via the personality represented by  $\delta$ . There the disciple is to be tested and tried in the west by the Solar Angel of  $\text{♃}$ .

The location of the Five of Wands is at the northeast above corner, the same location as the Two of Wands. This is of immense import, for on the Tree of Life the Sphere of **גבורה** is diametrically opposed to the Sphere of **הכמה**. Thus this northeast above point demonstrates the unity of what we understand as Will, and what we sense as volition. Volition is Will as it is expressed through the personality. It is also important to note that the invisible path on the tree that connects these two spheres is the same length as the 13<sup>th</sup> path of **ג**, which connects **כתר** to **תפארת**.

The distinguishing difference between the Two of Wands and the Four of Wands is that the Two of Wands initiates and descends into the below face of the Cube, establishing Divine Will through the first four signs of the zodiac. The Four of Wands takes the established will and continues the development of that will through the signs of  $\delta$ ,  $\text{♁}$ ,  $\text{♂}$ , and  $\text{♃}$ . On the Tree of Life, the signs of  $\text{♁}$  and  $\text{♂}$ , the 20<sup>th</sup> and 22<sup>nd</sup> paths, descend into the Sphere of **תפארת** as a direct result of the influence of the 19<sup>th</sup> path of **ט** upon **חסד** and **גבורה**. From the Sphere of **תפארת**, the 24<sup>th</sup> path of **נ** descends into the Sphere of **נצח**. From this we can see that the higher aspects of Will descend into the personality complex and express that Will through the subdivisions of **רוח**.

On the Cube of Space we see the north above line of **ט** connecting the north with the west, or  $\text{♄}$  with  $\text{♃}$ , terminating its influence at the northwest above corner. Here the current is picked up by the sign of  $\text{♃}$ , the final sign of  $\Delta$ .

The Five of Wands also represents the power of Will, executed through volition. The five wands are placed in the form of a pentagram, and symbolize the power of Will and volition as expressed through humanity:

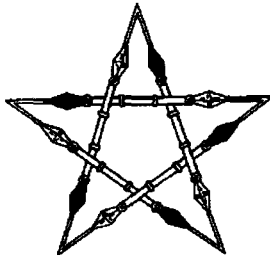

This symbol of Will connects humanity with its true heritage, that of being a son of mind, the divine Manasaputra.<sup>15</sup>

### Meditation on the Five of Wands

⌘ - ⦿

The meditation on the Five of Wands begins by placing the articulated keys before you along with the Five of Wands.

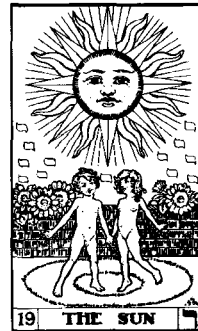

After the usual attunement, chant the Divine Name attributed to the Sphere of גבורה. This is אלהים גבור. The notes for this name are E, F#, C, F, G#, G#, E, C#, and C. This name describes the creative powers of strength. Key 8 derives its name from this sphere.

As you place your attention on these keys, remember that you are attuning your subconscious patterns to that of a Greater Adept, one who clearly expresses Divine Will through his thoughts, words, and deeds.

After a few minutes of looking at the keys, intone the notes associated with the keys. The notes are C, E, and D. Continued practice with this combination of keys begins to attune the student with the higher mind and the higher expression of volition.

The time frame for the Five of Wands is from 23 July to 1 August. The key word is **COMPETITON**.

### The Northeast Corner

Because the Two of Wands and the Five of Wands occupy the same point upon the northeast corner, it would be helpful to meditate upon these minor keys together. You can choose whether you want to articulate the minor keys into the major keys, or simply look upon the short hand symbols, as presented here. These two minor keys are already articulated in this chapter and in Chapter 11. These two keys occupy the same point, but flow in different directions. The Two of Wands travels to the below face, while the Five of Wands traverses the above face. The Five of Wands, if one chooses, can join the Two of Wands at the below northwest corner by descending the northwest line of  $\underline{\omega}$ , or the Two of Wands can join the Four of Wands by ascending the southwest line of  $\underline{\mu}$ .

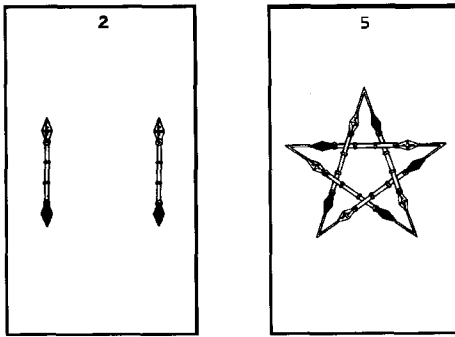

### The Six of Wands

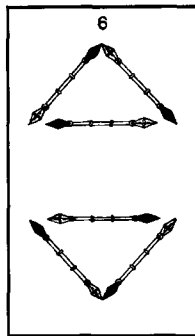

The Six of Wands is **תפארת** in **אצילות**: the principle of the Divine Ego in the World of  $\Delta$ . It is also the principle behind the image-making faculty, which allows for the clarification of abstract ideas into clear specific images. These images, as they precipitate through the spheres, condense into crystallized forms.

The articulation of the Six of Wands is as follows:

- Key 19 (The Sun), representing the Sphere of **תפארת**;
- Key 8 (Strength), the sign of  $\delta$ ;
- Key 19 (The Sun), the  $\odot$ , ruler of  $\delta$ ;
- Key 14 (Temperance), the sign of  $\aleph$ , ruler of the second decanate of  $\delta$ ; and
- Key 10 (Wheel of Fortune),  $\mathcal{U}$ , ruler of the sign of  $\aleph$ .

The teaching of occult psychology indicates that **תפארת** comes



into activity before the spheres of **חסד** and **גבורה**. There are a couple of points which indicate this.

First, if we observe the sequence of major keys descending from **כתר**, we will see Key 0 energizing **חכמה**, Key 1 energizing **בינה**, and Key 2 energizing **תפארת**. Thus numerically we can see that the Divine Ego, which is a reflection of the central self, is manifest even before the union of the Mother and Father. The union of the Mother and Father occurs through the path of **ד**, represented by Key 3 (The Empress). Key 3 follows Key 2 in the sequence. Here we can see the principle behind the virgin birth, for the Son/Sun is born before the union of the Mother and Father.<sup>16</sup>

Secondly, if we use the method of theosophical extension we will see that **תפארת**, the Divine Ego, must come before the secondary attributes of Memory and Volition. The number 1 stands alone, while the number 2 is a direct result of the One observing itself. This gives rise to  $1 + 1 = 2$ . Following this we can see that **בינה** is the direct result of the full extension of the reflection of **חכמה**, thus  $1 + 2 = 3$ . To carry this to the next step we can take the full extension of **בינה** as the number 3:

$$1 + 2 + 3 = 6.$$

The number six is the number of the Divine Ego seated in **תפארת**.

The Six of Wands is a focal point and a demonstration of the full power and balance of all that is the very source of power. Thus we see the two opposite equilateral triangles indicating the descent and return of the One Force, the alchemical  $\Delta$  and  $\nabla$ . The descent of the alchemical  $\nabla$  is further indicated by the occult teaching concerning the 13<sup>th</sup> path on the Tree of Life. The Uniting Intelligence is the only path which descends from **כתר** and returns to **כתר**.

The two triangles can be seen as two distinct activities of the one force, or they can be seen as the balance, maintaining creation at a point of tension as seen in the following figure.

## The Two Activities of the One Force



## Two Activities held at A Point of Tension



Figure 36.

If we refer to the Tree of Life, we will also see that the Sphere of **תפארת** plays a vital role in the formation of the hexagrams as the ▽ descends the tree. **תפארת** is the vertex of the ▽ triangle when **חכמה** and **בינה** are the base. **תפארת** is the center of the hexagram with the invisible Sphere of **דעת** is at apex of the △ triangle.

The location of the Six of Wands is on the north above line, following the Five of Wands as seen in the earlier diagram.

## Meditation on the Six of Wands

טב - 48

Begin this meditation with the usual attunement. After completing the attunement, chant the Divine Name attributed to the Sphere of **תפארת**. This name is **יהוה אלוה ו דעת**. The notes for this name are F, C, C<sup>#</sup>, C, E, F<sup>#</sup>, C<sup>#</sup>, C, C<sup>#</sup>, F<sup>#</sup>, A, and A. As before, place the articulated keys before you:

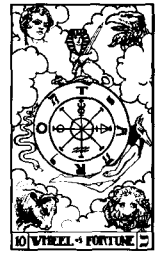
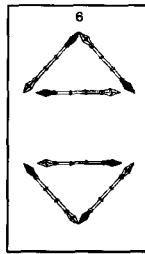

The tones associated with these keys are D, E, D, G<sup>#</sup>, and A<sup>#</sup>. This meditation will assist the student in gaining a deeper connection to the principle behind the very sense of ego. This identification is most difficult, for we are usually too immersed in the concept of separateness to truly understand the meaning and purpose of the vehicle of the Soul. Once we have attained to some level of this understanding we will no longer see things from the perspective of the separated personality.

As we progress we will discover that the sixes of the minor keys will be dealing with the concept of the Divine Ego. The expression of the Divine Ego, which is also called the Soul, has been, and will continue to be the major focus for humanity. This will continue until we come to fully live the life of the Soul.

The time frame for the Six of Pentacles is from 2 August to 12 August. The key word is **VICTORY**.

## The Seven of Wands

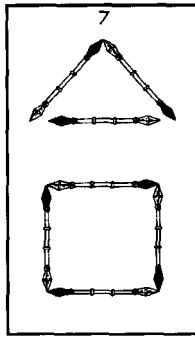

The Seven of Wands completes the decanates of  $\delta$ . This minor key is **נצה** in the World of **אצילות**. Thus we have within this symbol the representation of the principle behind all desire. We have already looked at the Sphere of **נצה** through the Seven of Pentacles in the sign of  $\zeta$ . Refer to Chapter Ten and read that which concerns Desire and Will. The conflict that exists between those who subscribe to fulfilling desire and those who assert the necessity for killing out desire is of tremendous importance, and deserves our careful attention.

The major keys that express the articulation of the Seven of Wands are as follows:

- Key 3 (The Empress), ♀, representing the Sphere of **נצה**;
- Key 8 (Strength), representing the sign of  $\delta$ ;
- Key 19 (The Sun), the  $\odot$ , ruler of  $\delta$ ;
- Key 4 (The Emperor), representing  $\gamma$ , the ruler of the third decanate of  $\delta$ ; and
- Key 16 (The Tower), representing the planet of  $\sigma$ , ruler of  $\gamma$ .

$\Delta$  is an active element. With the three decanates of  $\delta$  we can see that the  $\Delta$  of **אצילות** is represented by three geometric symbols. Each of these symbols refers to a specific work in the field of personality.

The Five of Wands shows us the active element of  $\Delta$  forming the pentagram, the symbol of humanity, the developing Manasapu-

tra. The pentagram intimates that humanity has dominion, and must exercise that dominion over the elemental nature. This elemental nature is the very substance of our physical bodies and the universe alike.

The Six of Wands, through the symbol of the hexagram, shows us the need for maintaining the proper point of tension in order to bring our images into physical manifestation.

The Seven of Wands shows us the irrational form which defies circumscription within a circle. To hold one's apparent personal desires and internal energies in due boundaries is the mark of a true initiate. It is only through conscious trial and error, experimentation, and meditational practices that give the disciple the necessary control of the hidden forces within. When these forces are under the control of the soul, the points of the heptagram are brought into right proportion.

The placement of the Seven of Wands is at the western portion of the north above line. Notice that this line flows into the northwest corner where the disciple can meet the test and trials of the Solar Angel in the sign of  $\text{♁}$ , or move into the sub-conscious level through the sign of  $\text{♁}$ . Notice that in Key 14, the Solar Angel has a heptagram located upon his breast, just beneath the name יהוה. יהוה is the first part of the Divine Name attributed to the Sphere of **נצה צבאות**.

### Mediation on the Seven of Wands

טפ - סד

After the usual attunement, chant the Divine Name attributed to the Sphere of **נצה**. The name is **יהוה צבאות**, Lord of Armies. The notes for this name are F, C, C<sup>#</sup>, C, A<sup>#</sup>, E, E, C<sup>#</sup>, and A. Place the Seven of Wands and the articulated keys before you.

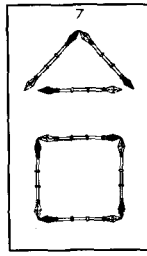

After focusing for a few minutes on each of the keys, intone the note for each of the articulated keys. The notes are, F<sup>#</sup>, E, D, C, and C. Remember that the elimination of desire is not the true goal, but rather the conscious direction of the desire nature in full alignment with the Divine Will. This is the true death of desire. This Divine Will is the very source of all desire.

The time frame for the Seven of Wands is from 13 August to 22 August. The key word is **VALOR**.



# Chapter XV

## The Decanates of ♁

I am the creative Hand,  
Which fashioneth the worlds  
And establisheth the spheres,  
While yet the primal FIRE  
Circleth untrammelled in the womb of space.<sup>17</sup>

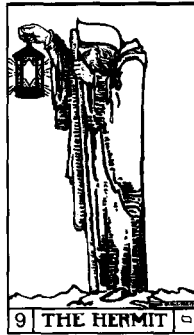

The sign of ♁ takes us back into the World of עשיה, where we must work with the three lower spheres on the Tree of Life. The work of the lower spheres is concerned with fashioning the human personality into an undistorted channel for the expression of the Divine Ego. The alchemists refer to this stage as the “Gross Work.” The decanates of ♁ specifically deal with the lower mental body, the animal soul, and the physical body. The Hermit, symbolic of ♁, is a very esoteric and complex symbol. The above quotation indicates that Key 9 is representative of the highest and the lowest simultaneously.

There is much that can be learned about the present condition of humanity, when we take into account the deeper meanings of the mutable signs. On one level they represent the beginning stages of spiritual unfoldment. On another level the mutable signs represent the pliability and receptivity of the physical world to the power of MIND.



The mutable signs are subject to and are expression of a higher order of being. As a result of this we see within Key 9 (The Hermit), is a symbol of completion. It is a journey completed, either to the mountaintop or to the deepest center. Key 9 represents the establishment of the soul aspect as the predominant and undistorted influence within the World of Form.

The letter **י** is the foundation of the entire Aleph-Beth, and is representative of **חיה**, the life force within all forms. The decanates of **מ** bring us to the completion of the precipitation of form upon the Tree of Life. This process began with the Ace of Wands in the World of **אצילות**, and is completed with the Ten of Pentacles in the World of **עשיה**.

On the Cube of Space the sign of **מ** performs a parallel and simultaneous function with the sign of **ז**. In the last chapter we placed our attention on the north above line, which flowed from east to west. With the sign of **מ**, we are concerned with the north below line, which also flows from east to west. The sign of **מ**, like the sign of **ז**, receives its influence from the east, after that face has been bound. The sign of **מ** takes the influence of the east and through the powers of subconscious makes the necessary adaptations for the creation of the New Human.

The minor keys, which make up the three decanates of **מ**, express this process as we go through the repetitions of “*Solve et Coagulae.*” The fruit of this process can be seen in the southeast above corner where these two alchemical steps, *Solve* (**⚡**) and *Coagulae* (**⚗**), merge.

The locations of the three decanates of **מ** are located on the north below line heading from east to west by way of the north. The following diagram shows this.

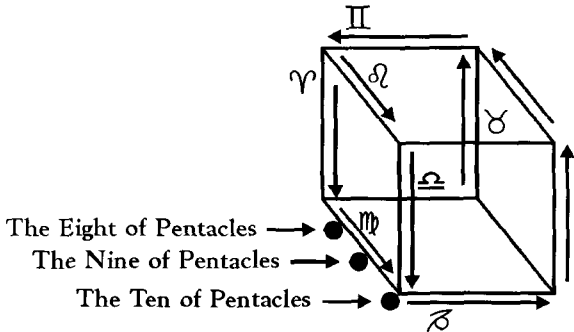
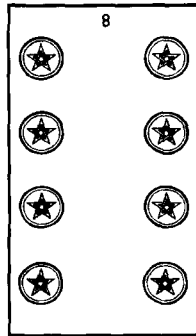

Figure 37.

## The Eight of Pentacles



The Eight of Pentacles is **הוֹר** in **עֲשִׂיָּה**. **הוֹר** is the Sphere of the Lower Mind on the Physical Plane. This portion of our journey is where we run into difficulty concerning the concept of the brain and mind. Natural science, for the most part, still contends that the mind is a by-product of form, while according to occult psychology the opposite is true. We must ever remember that all form is an expression of a higher order of being.

If we are to accept the first of the seven Hermetic Principles, “The All is Mind, the Universe is Mental,” then it follows that the form side of nature is in fact a creation of the Mind of the All. The lower mind, which is represented by the Eight of Pentacles, expresses the All in an incomplete way. The lower mind does have access to the Higher Mind, and through meditation and other types of spiritual practice the Higher Mind can be clearly expressed through the lower.

The articulation of the Eight of Pentacles reveals a strong mental component. We find the same sphere and planetary ruler in the Eight of Pentacles as is found in the Eight of Swords. The difference is that the Eight of Swords expresses the  $\Delta$  of  $\text{II}$ , while the Eight of Pentacles expresses the  $\nabla$  of  $\text{♁}$ . Both are mutable signs forming a square. The major keys that articulate the Eight of Pentacles are:

- Key 1 (The Magician), representative of the Sphere of **הוֹר**;
- Key 9 (The Hermit), the sign of  $\text{♁}$ ; and
- Key 1 (The Magician),  $\text{♁}$ , the ruler and exalted planet of  $\text{♁}$ .

The location of the Eight of Pentacles is just inside the north-east below corner.

Perhaps the key point to remember concerning this series of symbols is their relative application and interpretation. We know that Key 1 (The Magician) represents the self-conscious state of awareness. Yet in the Eight of Pentacles it is the ruling and exalted planet of a subconscious process. The intimations of this are quite profound if we observe how these keys precipitate down the Tree of Life. The Magician on the Tree of Life represents the self-conscious awareness of **יחידה**, the central self. **יחידה** is a far cry from the self-conscious awareness of the individual Egoic unit known as humanity. Just as a cellular unit of the body human is governed by the subconscious mind, so we as cells living within a greater life are governed by the greater subconscious level of **יחידה**. This is indicated by the 13<sup>th</sup> path on the Tree of Life, which joins **יחידה** to the Divine Ego of **תפארת**.

As we place our focus on the Eight of Pentacles, as it flows on the north below line, we can observe our place within the subconscious process of the Greater Life within which we live. All of our spiritual work is designed to bring us into an awareness of this greater reality. The Tree of Life demonstrates the relationship between the lesser lives and the greater life through the relationships of the diametrically opposed spheres of **חסד** and **הוד**, and **גבורה** and **נצה**.

The distance between the diametrically opposed spheres is measured by the path of the Uniting Intelligence. This path is symbolized by the High Priestess. The High Priestess is the key that rules the below face on the Cube of Space. It is the subconscious level of awareness of humanity, as well as the subconscious level for the One Life. The difference is that our self-conscious level is the subconscious level of the Greater Life.

Because Pentacles represent the World of **עשיה**, we are dealing with the planetary spheres as they physically exist. The planetary name for the Eight of Pentacles is **כוכב**.

### Meditation on the Eight of Pentacles

יב – זמ

After the usual attunement, chant the planetary name attributed to **הוד** in **עשיה**. The notes for **כוכב** are A<sup>#</sup>, C<sup>#</sup>, A<sup>#</sup>, and E. Follow the

chant by placing the Eight of Pentacles and articulated major keys before you. They are as follows:

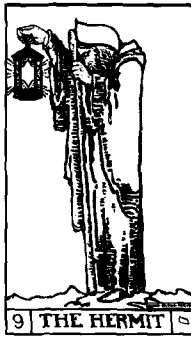
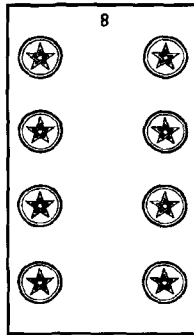

After the usual few minutes spent on each key, chant the appropriate notes. The notes are E, F, and E.

There are several potentialities with this meditation. The first should be the development of a strong objective awareness of the details of everyday life. The keen awakened state is the key to creating easily accessible memory. It is also the key to seeding the proper suggestions within the subconscious mind.

The second goal is to access the higher aspect of mind. This is the work of all disciples whether they know it or not, want to or not, or are actively engaged in it or not. *No one* may escape this ultimate work.

Thirdly we seek to gain some understanding of our part within the greater organism in which we live.

After observing the keys for a few minutes, intone the appropriate notes. The notes are E, F, and E.

The Eight of Pentacles rules the time from 23 August to 2 September. The key word attributed to this minor key is **PRUDENCE**.

### The Nine of Pentacles

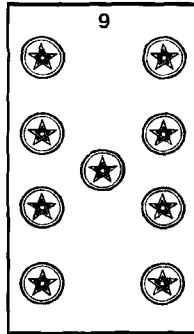

The Nine of Pentacles is **יסוד** in the World of **עשיה**. One of the main attributions given to the ninth sphere is the seat of the Vital Soul. This is the collective subconscious of all humanity. This is what gives each Egoic center of humanity omnipresence throughout the world.

The ninth sphere is also referred to as the astral plane. This is the dimension of life after the physical body is dropped. We are taught in occult psychology that this dimension is not in some other world, but is a rate of vibration which we can access while remaining anchored within our physical bodies.

Because the Nine of Pentacles is in the World of **עשיה**, it is a symbol of the immediate phase of activity before the final manifestation of a particular form. The Ten of Pentacles represents the final stage of the process of manifestation. Thus on the Tree of Life, **יסוד** is called The Foundation. The Nine of Pentacles informs us that all forms that exist upon the ontological plane of sensory awareness are made from the astral substance of the Sphere of the **ד**.

The major keys that articulate the Nine of Pentacles are:

- Key 2 (High Priestess), representing **יסוד**, the Sphere of the **ד**;
- Key 9 (The Hermit), the sign of **♁**;
- Key 1 (The Magician), **♃**, the ruler of **♁**;
- Key 15 (The Devil), **♄**, the ruler of the second decanate

- of ♁; and
- Key 21 (The World), הָ, the ruler of אָ.

The location of the Nine of Pentacles is west of the Eight of Pentacles. This is on the north below line of ♁ as pictured in the earlier diagram.

The Nine of Pentacles is sub-ruled by אָ and the planet הָ. Thus the symbol of the Nine of Pentacles represents the power of limitation. This limitation can be expressed in several ways. This includes limitation of:

- the power that creates new form;
- the power to alter old forms;
- focus upon an existing form in order to gain a deeper understanding of the form;
- the Vital Soul to direct thought telepathically; and
- focus in order to perceive the astral plane from the perspective of incarnate life.

There are many other positive expressions of the power of limitation. The above examples serve only to direct us towards the deeper meaning of the Nine of Pentacles.

The combination of הָ in the sign of ♁ is represented by the letters י and ת. Their combined value of 410 has the same value of קדוש, meaning sanctified, holy, sacred, consecrated. Another important word with the same value is משכן, meaning tabernacle. Together, they imply the sacredness of the tabernacle, for it is the dwelling place of the holy presence.

### Meditation on the Nine of Pentacles

ת י – הָ♁

After the usual attunement, chant the angelic name for יסוד in עשיה. The Choir of Angels for this key is כרובים. These are the subtle angelic beings that are the very astral substance that respond to our conscious thought and form the patterns into physical matter. The notes for this name are A<sup>#</sup>, D, C<sup>#</sup>, E, F, and G<sup>#</sup>. The meditation on the Nine of Pentacles begins by placing the appropriate keys before you.

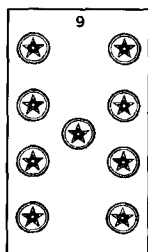

After a few moments with each key, chant the appropriate notes for each key. These are, G<sup>#</sup>, F, E, A, and A.

The element of ♄, as expressed by the suit of Pentacles in the World of עשיה, brings the entire creative process to completion. This completion is the very dwelling of the Most High within the form aspect. As you spend time with this meditation become aware of the presence of the Soul seeking conscious expression within your body.

The Nine of Pentacles rules the time from 3 September to 12 September. The key word associated with this minor key is **HARVEST**.

## The Ten of Pentacles

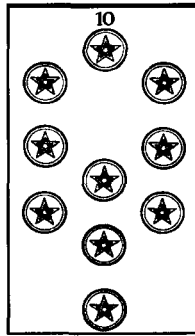

The Ten of Pentacles is the fruit of the entire Tarot series. All Tarot keys, both major and minor, lead to the formation of this particular key. The Ten of Pentacles therefore is of tremendous importance.

This particular version of the Ten of Pentacles is presented in the form of the Tree of Life. This is the Tree of **עשיה**. Thus the Ten of Pentacles is **מלכות** in **עשיה**, the Sphere of **גוף**, the physical body.

There is so much that lies beyond our sensory awareness. This is what makes the Ten of Pentacles such a prominent symbol in our meditations. Natural science gathers all of its data from **מלכות** in **עשיה**. The remaining thirty-nine pip cards, which represent the relative causal levels and higher ontological planes, are out of bounds in terms of being able to present hard data. To penetrate the depths of the Ten of Pentacles is to be able to experience other worlds which take us beyond the ontological plane of sensory awareness.

On this ontological plane we deal specifically with the physical expression of the elements. The Ten of Pentacles therefore represents the Sphere of Elements as experienced in the World of Name and Form. These elements are understood by science as:

- Radiant Energy ( $\Delta$ );
- Liquids ( $\nabla$ );
- Gases ( $\triangle$ ); and
- Solids ( $\nabla$ ).

These four elements are attributed to the Divine Name **יהוה**, the projector of the universe. The elements are placed around the four



lower arms of the pentagram. The Quintessence, or the fifth element, symbolized by \* and the letter ש, rests above the other four elements. This is to intimate to us that the causal power which is called spirit has dominion over all things. It is only our lack of training and ability to see into the nature of things that leads us to believe that we are victims and that the elemental world controls the proceedings of nature. The insertion of the letter ש gives us a new Divine Name, יהשׁוה, the name of liberation. The following diagram demonstrates this.

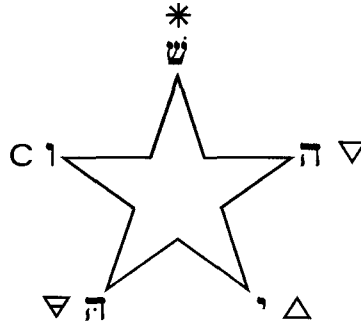

Figure 38.

The following are the articulated major keys for the Ten of Pentacles:

- Key 21 (The World), representative of מלכות;
- Key 9 (The Hermit), representative of the sign of ♄;
- Key 1 (The Magician), ♃, ruler of ♄;
- Key 5 (The Hierophant), ♁, ruler of the third decanate of ♄; and
- Key 3 (The Empress), ♀, ruler of the sign of ♁.

The location of the Ten of Pentacles is just west of the Nine of Pentacles. The Ten of Pentacles is the terminating point of the north-west below line of ♄ and flows into the descending current of ♁ and to the west below line of ♃. The earlier diagram shows the location of the Ten of Pentacles.

This point on the Cube receives all the influence that has come before:

- The subconscious experience of the sealing of the east, via the north below line of  $\mathfrak{M}$ ;
- The self-conscious experience of the sealing of the east via the north above line of  $\mathfrak{Q}$ ; and
- The blending of the two through the north descending line of  $\mathfrak{O}$ .

The blending of the two experiences through the sign of  $\mathfrak{O}$  brings balance between these two aspects of consciousness. When we achieve a place of balance, we are then ready to traverse the west below line of  $\mathfrak{R}$  where we face our darkest hour. It is on this line that we are confronted with the darkest aspects of ourselves as represented by the Dweller on the Threshold. The west below line also brings the exalted powers of  $\mathfrak{H}$  in the sign of  $\mathfrak{O}$  to the rulership of  $\mathfrak{H}$  in the sign of  $\mathfrak{R}$ . The path is illumined by Key 9 (The Hermit) and  $\mathfrak{F}$ . At this point there is a strong influence of the intelligence of  $\mathfrak{F}$ . These points of influence are:

- The Ten of Pentacles is sub-ruled by  $\mathfrak{Y}$  where  $\mathfrak{F}$  is ruler;
- The sign of  $\mathfrak{O}$  is ruled by  $\mathfrak{F}$ ; and
- $\mathfrak{F}$  is the Hierarchical ruler of the sign of  $\mathfrak{R}$ .

These points alone are worthy of focus and meditation. Therefore experiment with Keys 3, 5, 11, and 15 on your own. There are many meditations possible as one traverses the faces of the Cube.

### Meditation on the Ten of Pentacles

$\mathfrak{Y}$  –  $\mathfrak{F}$

After the usual attunement, chant the angelic name attributed to  $\mathfrak{M}$  in  $\mathfrak{E}$ . This name is  $\mathfrak{A}$ . The notes are E, C, F, and G $\sharp$ . After the chanting, place the keys before you. After the usual minutes of focus on each key, chant the notes attributed to the keys. The notes are: A, F, E, F $\sharp$ , and C $\sharp$ .

We are seeking to unlock the door that allows us to penetrate the deeper mysteries of the reality that lies behind the form. This tableau informs us that:

- Self-conscious observation brings us to a greater understanding

of our environment; and

- Creative imagination is the power that creates and transforms our world.

Self-consciously-imposed limits upon our image-making process bring these images into manifestation.

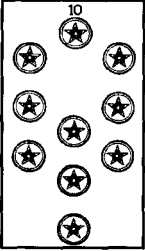

The time period for the Ten of Pentacles is 13 September to 22 September. This brings us to the point of the Autumnal Equinox. The traditional meaning of this key is **WEALTH**.

# Chapter XVI

## The Decanates of ♎

By action are all things determined,  
And every action proceedeth from my grasp  
No man accomplisheth anything of himself.  
They are deluded who think otherwise.



We now move into the second half of the year. The sign of ♎ is the first sign to express a zodiacal polarity. Thus the sign of ♎ begins at the Autumnal Equinox, a time of equilibration. The sign of ♎ is the second of the descending lines on the Cube of Space. Both ♋ and ♎ take the disciple into the depths of the subconscious level.

Like ♋, ♎ is a cardinal sign and expresses an active element. While ♋ expresses Δ, ♎ expresses Δ. We can see that it is the active elements that bring us into the below face and the passive elements that bring us back to the above face.

Both ♋ and ♎ descend from the spheres of Δ. ♋ descends from חכמה, and ♎ descends from גבורה, both energizing the Sphere of תפארת, seat of the Divine Ego.

♎, through the Ace of Swords, takes us from the World of בריה to the World of יצירה. The World of יצירה is specifically associated

with the letter ו and humanity. It is through the vehicle of humanity that the World of **ברייה** and the World of **יצירה** are united. It is in the World of **יצירה** where the subtle substance within the bloodstream is sublimated and is projected into the outer World of Name and Form. This is accomplished by establishing new patterns formulated within the creative human mind.

The sign of **ז** is also associated with karma and the ultimate victory over the phenomenon of cause and effect. **ד**, which is attributed to ♀, ruler of **ז**, demonstrates through the full spelling of that letter, the work of **ז**. **דלת** is the full spelling of **ד**. **ד** is the creative process necessary for the formation of the necessary patterns, **ל** is the goad of activity necessary to create the proper environment for the form, and **ת** is the limitation imposed so that the form is specific and placed in due bounds.

There are several applications of the Law of Correspondence to **ו** and **ז**, in relationship to **ז** and **ז**. Both **ו** and **ז** descend into the lower face. Each in turn flows into the cardinal sign, culminating in the extreme expression of the solar journey. The Spring Equinox flows into the east below line, culminating in the Summer Solstice, while the Fall Equinox flows into the sign of **ז**, culminating in the Winter Solstice. Their paths mirror each other. **ו** ascends in the south through **ז**, and **ז** ascends in the south through **מ**. **ז** and **מ** are themselves complementary signs.

The decanates of **ז** descend through the northwest descending line of the cube, and flow into the terminating point of **מ** and the beginning point of the sign of **ז**. The following diagram shows their location.

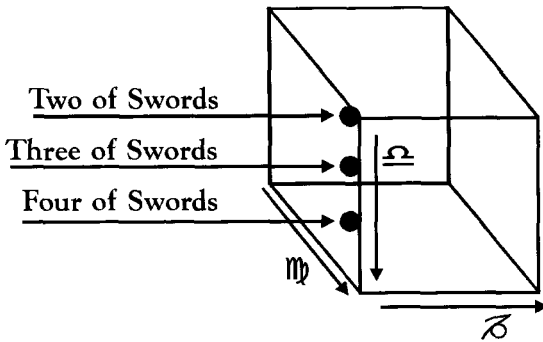
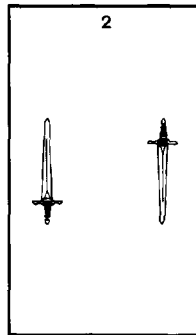

Figure 39.

### The Two of Swords



The Two of Swords is representative of **חכמה** in **יצירה**. There is much that is parallel between minor keys bearing the same number, for they express the same sphere in different worlds. Many of the basic attributions are the same. The significant difference between the Two of Wands and the Two of Swords is the shift from the abstract principles in the World of **אצילות**, to a specific pattern in the World of **יצירה**, which holds the patterns behind the form. The Sphere of **חכמה** has broad cosmic implications, such as the Sphere of the Zodiac. Because we are dealing specifically with the World of **יצירה**, we will be exploring the Sphere of **חכמה** as it expresses itself through humanity.

**חכמה** is said to be "above every head". **חכמה** is the direct reflection of **כתר** unto itself. Therefore we can say that the Two

of Swords is a point where the continuous precipitation of the infinite possibility of **בְּתָר** is crystallized into a specific pattern resulting in what we have come to understand as the Sphere of the Zodiac. It is not the twelve signs of the zodiac alone, but all the stellar forces from every luminous body in the universe converging upon a single point.

Because **1** and the World of **יְצִירָה** are representative of humanity, the convergence of all the luminous points of light originating through the Sphere of **הַכְּמָה** are focused upon humanity itself, both individual and collective. Thus does humanity become the synthesis of these forces.

The major keys that articulate the Two of Swords are:

- Key 20 (Judgement), representing the Sphere of **הַכְּמָה**;
- Key 11 (Justice), the sign of **♋**; and
- Key 3 (The Empress), the planet **♀**.

The World of **יְצִירָה** is involved with the functioning of the human brain as a receiving station for the mental images created within the Central Ego. The symbol of the Two of Swords assists the disciple in refining the instrument of the brain into a clearer vessel for expressing **Manus**, the root for the word man. The human kingdom is the only kingdom that can mediate between the worlds and bring that which is above to that which is below. It is for this reason that humanity is associated to the World of **יְצִירָה**.

The location of the Two of Swords is on the above northwest corner. It is here that the second path of descent flows into the realm of the subconscious mind. This can be seen in the above diagram.

### Meditation on the Two of Swords

דל – ♀♋

Begin by placing the appropriate keys before you.

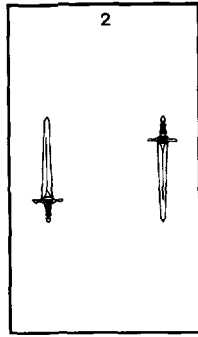

After the usual attunement, chant the name for the Choir of Angels associated with **חכמה** in **יצירה**. The name is **אופינם**. These angels are the celestial forces that bring **חיה**, the Life Force of **חכמה**, into the patterns of human thought. The notes for this choir are E, C<sup>#</sup>, C, F, G, and G<sup>#</sup>. After attuning yourself to this sphere, place your attention on the three keys starting with the Two of Swords. After a few minutes look at the two major keys and intone their notes which are F<sup>#</sup>, and F<sup>#</sup>.

The time of year for the Two of Swords is from 23 September to 2 October. The key word for the Two of Swords is **INDECISION**.



## The Three of Swords

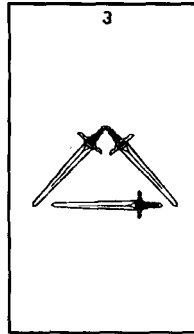

The Three of Swords is **בינה** in **יצירה**. This is expressed through **ה̄** in **⚊⚊⚊**. Since **⚊⚊⚊** is the sub-ruler of the second decanate of **♁**, we also find the planet **♃** co-ruling with **ה̄**. This particular minor key expresses the mystery of infinite possibility within the finite form.

The one single disease and the cause of all difficulties is that of separation; ignorance concerning the principle of limitation. This key is a symbol that instruct us in the greater reality and purpose of humanity.

The major keys that articulate the Three of Swords are:

- Key 21 (The World), symbolic of the Sphere of **בינה**;
- Key 11 (Justice), the sign of **♁**;
- Key 3 (The Empress), **♀**, the ruler of **♁**;
- Key 17 (The Star), **⚊⚊⚊**, the ruler of the second decanate of **♁**;
- Key 21 (The World), **ה̄**, ruler of **⚊⚊⚊**; and
- Key 0 (The Fool), **♃**, co-ruler of **⚊⚊⚊**.

As we know **ה̄**, is the Lord of Karma and the planet of restriction. **♃** is the explosive planet of change and infinite potential. Together they govern the second decanate of **♁**, which creates the conditions for the balance between restriction and expansion. It is the infinite potential of **♃** that is expressed through the limitations of the various centers. This is the ultimate expression of the Three of Swords, **בינה** in **יצירה**.

The location of the Three of Swords is just below the Two of Swords on the northwest descending line of  $\Omega$ . The earlier diagram shows this location.

This particular minor trump deals with the painful paradox of unity in separation. We are continually faced with the sense of separation in the world of appearance, yet we are told over and over again that there is no separation. In the Waite Deck we see a heart pierced by three swords, yet the articulated keys show a cosmic dancer wielding the spirals of involution and evolution in perfect balance. Until we truly know the beauty behind the individualized form and the infinite potential that lies within that form, we will continually suffer the pain which Waite's version symbolizes.

This apparent paradox can be reconciled by our understanding of the  $\approx$  axis on the zodiacal wheel.  $\delta$ , as we have seen, represents the personal ego. This is the individualization of the human unit. The sign of  $\approx$ , however, brings this individual unit in relationship to other individual units. Thus  $\approx$  is understood to be synonymous with community, or the greater life within which we live and participate.

### Meditation on the Three of Swords

אתל - ה'ע'  $\Omega$

We begin this meditation with our usual attunement. Following the attunement, chant the name for the Choir of Angels given to **בינה** in **יצירה**. The name is **אראלים**, meaning "thrones". The notes for this name are E, D, E, F#, F, and G#. The Choir of Angels specifically refers to the World of **יצירה**. They are the very substances that form the patterns of existence.

After looking at the keys for a few minutes chant each of the notes attributed to each key. These notes are A, F#, F#, A#, A, and E. In this meditation we are seeking to make contact with the true meaning of limitation, so we may join in with our elder brothers and sisters in the process of creation.

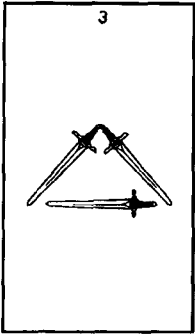

The time period for the Three of Swords is from 3 October to 12 October, and the key word is **SORROW**.

## The Four of Swords

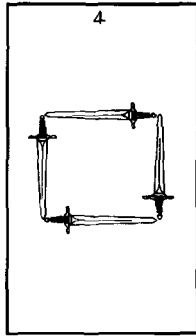

The Four of Swords is **חסד** in **יצירה**. The prominent symbol in this key is the square. If we look at this square as a symbol of the above face of the Cube, and identify the points of the swords as the directional flow of energy, we find an identical movement of the currents as along the above face. The number four itself represents the form side of nature, and the right angles of the square bring up the idea of measurement which ties the Four of Swords to the Sphere of **חסד**. The Measuring Intelligence as it is expressed in the World of **יצירה** teaches us to pay particular attention to the mental life, instructing us to “Tile our Minds” from the distractions of our lower nature. Proper measurement of our thought forms allows for their positive expression in the World of Name and Form. When properly attended to, these thought forms bring joy and good of every kind into the world.

As a sphere, **חסד** is attributed to memory. We can learn from the Four of Swords that it is memory that teaches the power of adaptation. Accurate memory of the cause behind a particular phenomenon in the present will allow the student to change the present set of circumstances. This brings about a new pattern from which a new future will emerge.

♃ in II is the ruler of the third decanate of ♁. This further ties the Four of Swords with the above face of the Cube. It is the self-conscious state that acts as the measuring agent. It is through focused attention upon some aspect of the environment which reveals the inner nature of the area focused upon to the student. This revelation is the accessing of the personal as well as collective memory.

The articulated keys for the Four of Swords are:

- Key 10 (Wheel of Fortune), ♃, symbolic of the Sphere of חסד;
- Key 11 (Justice), the sign of ♎;
- Key 3 (The Empress), ♀, the ruler of ♎;
- Key 6 (The Lovers), ♋, ruler of the third decanate of ♎; and
- Key 1 (The Magician), ♃, ruler of ♋.

The location of the Four of Swords is at the lower end of the northwest descending corner as shown in the earlier diagram.

As we approach the meditation on the Four of Swords we must remember that we are accessing memory, both personal and collective, through the powers of self-conscious awareness.

### Meditation on the Four of Swords

לֵב - חָסֵד

Begin by laying out the appropriate keys. After the usual attunement, chant the name for the Choir of Angels associated with חסד in יצירה, which is חשמלם. The notes for this name are D<sup>#</sup>, C, G<sup>#</sup>, F<sup>#</sup>, and G<sup>#</sup>. The inner meaning of this name is associated with the function of memory itself, and all the attributions of the Sphere of חסד. The process of memory is imprinted upon the substance of the angelic kingdom, and upon this substance we may access that privileged state whereby we may direct the creative forces of nature.

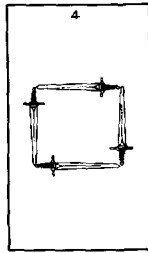

After focusing on each key for a few minutes, chant the proper notes for each key. These are A<sup>#</sup>, F<sup>#</sup>, F<sup>#</sup>, D, and E. The Four of Swords is that aspect of consciousness that allows the student to access a portion of the mind of the All.

The time period for this key is from 13 October to 23 October. The key word attributed to the Four of Swords is **REST**.



# Chapter XVII

## The Decanates of ♄

That what men call life and death  
Are as beads of white and black strung upon a thread:  
And this thread of perpetual change  
Is my own changeless Life.  
Which bindeth together the unending series  
Of little lives and deaths.<sup>18</sup>



We now approach the sign of ♄, which perhaps holds one of the greatest mysteries for mankind, that of Life and Death. Key 13 symbolizes the continual cycle of life and death, and all polarities that suggest this cycle, such as:

- Life – Death;
- Increase – Decrease;
- Light – Dark;
- Growth – Decay; and
- Countless other expressions that herald the coming of either birth or death.

We must keep in mind as we continue with this work, that our



general perspective is from the point of view of the personality. What we seek is the perspective of the Soul. All the fears concerning death are, as our occult teachings present, illusions. Death itself is the necessary part of the cycle in order for the form aspect to refine itself so it may better express the greater life within which we live.

The line of ♁ is located on the southwest ascending corner of the Cube of Space. This line of the Cube offers the weary pilgrim the opportunity to surface on the self-conscious level of awareness after having met the Dweller on the Threshold. This surfacing allows the integration of that which has been experienced on the lower face to come into our life of every day. At the above southwest corner, ♁ ends. It is on this line where we find the final confrontation of our fears. We have met the Dweller, we have faced our fears of death, and we experienced the test and trials of the Solar Angel.

It is the decanates of ♍, along with the minor keys symbolizing this process, that assist us in bringing to conscious awareness that greater level of knowing we call Super-consciousness. We are once again working within a fixed sign, which deals with the higher aspects of the personality. These are expressed through the Fifth, Sixth, and Seventh spheres on the Tree of Life.

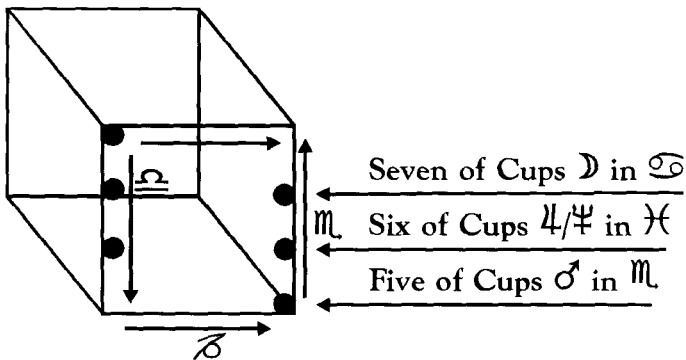
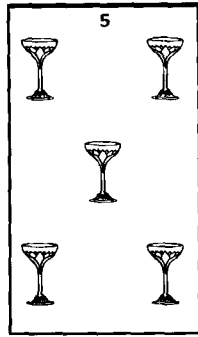

Figure 40.

### The Five of Cups



The Five of Cups is **גבורא** of **בריה**. This is the Sphere of Volition operating from the World of Intuition or Buddhi. Volition as personally identified takes on a whole different quality in **בריה** than the expression of the Sphere of **גבורא** in the lower World of **עשיה**.

Because the first decanate of  $\mathfrak{M}$  is ruled by  $\sigma$ , the Five of Cups has a very strong  $\sigma$  influence.  $\sigma$  is the vital life force in living forms. This vital life force is demonstrated in the decanates associated with  $\Upsilon$ . In the decanates of  $\mathfrak{M}$ , we can observe this same force involved with the destruction of form. It is helpful to remember that the sign of  $\mathfrak{M}$  and the letter  $\mathfrak{N}$  are associated with the alchemical process of **putrefaction**: the process of the decomposition of matter into its separated elemental lives. The alchemical authors of the Great Work also tell us that,

“putrefaction is the secret of the great Work.”

Thus we read in *The Book of Tokens* concerning the life building and life destroying force,

**“I tear down only to build anew.  
Verily destruction is the foundation of existence  
The tearing – down thou seest  
Is but the assembling of materials  
For a grander structure.”**

There are many ways to interpret such an admonition. If we are to keep our focus on the Cube of Space and the Tree of Life, it becomes clear what must die, or decompose. It is the path of  $\mathfrak{N}$  that connects

the Sphere of **נצה** to **תפארת**. This is the Sphere of Desire flowing into the Sphere of the Divine Ego. Until we let go of the fear of losing our identification with personal ego and subordinate ourselves to the Light of the Soul, we cannot traverse the path of **נ** into the Sphere of the Divine Ego.

The major keys that articulate the Five of Cups are:

- Key 16 (The Tower), ♂, symbolic of the Sphere of **גבורה**;
- Key 13 (Death), the sign of ♄;
- Key 16 (The Tower), ♂, ruler of ♄; and
- Key 20 (Judgement), ♀, co-ruler with ♂ in the sign of ♄.

The location of the Five of Cups is on the below southwestern corner. This point begins the ascent from the below to the above.

### The Placement of the Five of Cups

The southwest below point is of major importance. It is a distribution point for several influences. It receives the descending influence from the sign of ♁, it receives the influence that flows from the east to the west from the sign of ♀, and it receives the influence from ♂, which flows from the north to the south.

From this point there are three possible lines of direction that can be taken. The Five of Cups can continue around through the sign of ♁, traveling from the west to the east, where it must surface in the sign of ♀. It can travel through the diagonal of ♃, from the southwest below corner to the northeast above corner, or it can travel from the below to the above where it surfaces at the terminating point of ♂.

I will leave you to work out the first two meditations and move on to the decanates of ♄.

Because we are in the World of **בריה** we are in the World of Archangelic Names. The angel associated with the sign of **גבורה** is **כמאל**. This angel, as this sphere indicates, is a severe angel, and is named the Severity of God. By attuning with this name we can be assisted to **KNOW** that the volition we experience has its source outside the personality complex. Since we are working with the principle of life and death, we must keep in mind that the whole point of this work is transformation! If we are to create a fitting vessel for the

higher expressions of the One in whom we live, we must assist that One in our transformations by becoming impressed with his suggestion. This requires much change and discomfort on our part. We cannot enter into the greater sphere of awareness and remain as we are.

### Meditation on the Five of Cups

פנ ♂ in מ

Begin this meditation by chanting the Archangelic name, כמאל. The notes are A#, G#, E, and F#. Place the Five of Cups and the articulated major keys before you.

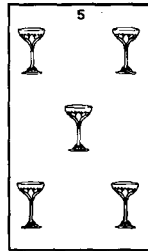

After focusing your attention on each of the keys for a couple of minutes, chant the notes attributed to each key. The notes are C, G, C, and C.

This particular meditation can assist us in recognizing and welcoming the One Force that plays the roles of both creator and destroyer. The time frame for the Five of Cups is from October 22 to October 31. The key word for this minor key is **DEFEATED DESIRE**.

## The Six of Cups

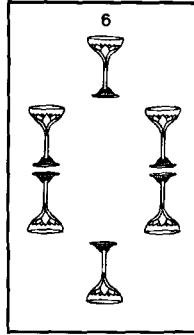

The Six of Cups is **תפארת** in **בריה**. **בריה** is the World of Creative Imagination and of Intuition. The Sphere of **תפארת** is the seat of the image-making faculty within mankind. If we are to identify what it is we seek to become, then the process becomes easy. We must therefore become receptive to the images that already exist in the world of creative ideas and ground them within our own personalities.

The Six of Cups is ♃, co-ruled with ♀ in ♁, which rules the second decanate of ♋.

The major keys that articulate the Six of Cups are:

- Key 19 (The Sun), symbolic of **תפארת**;
- Key 13 (Death), the sign of ♋;
- Key 16 (The Tower), ♂, ruler of ♋;
- Key 20 (Judgement), ♀, co-ruler of ♋;
- Key 18 (The Moon), ♁, ruler of the second decanate of ♋;
- Key 10 (Wheel of Fortune), ♃, ruler of ♁; and
- Key 12 (Hanged Man), ♀, co-ruler of ♁.

Since we are working in the World of **בריה** and the element of  $\nabla$ , we must gain an understanding of what is meant by the term *alchemical water*, in relationship to the decanates of ♋. ♋ is a water of  $\Delta$ , for it is ruled by ♂ and ♀. We are told by the alchemists in their writings that we must learn to burn with  $\nabla$ . What then is this water that burns? Dr. Case describes this alchemical water in a course that he wrote called “The Great Work” in which he says,

“Alchemical water, then, is the cosmic fire, specialized in the nerve currents and chemistry of the blood stream. The purification of this water must be the first work of the alchemist. He must choose true foods, and regulate his habits of eating. He must control his sex-life, and see to it that his kidney elimination is what it should be. He must learn, little by little, to rebuild his body, sacrificing everything which clouds or obscures its transparency to the light of the Life-power. And, finally he must impose a pattern of New Image on its cells through the agency of his subconsciousness.”<sup>19</sup>

When we take ourselves in hand we truly create the environment where the King of **תפארת** is returned to his throne. Thus we find that the word **מלך** (king) has a value of 90, the same value of **מים** (water). Furthermore, when the southwest ascending line of **♁** reaches the surface, it comes in contact with the line of **♃**, whose number is 90 as well.

The Solar Angel is one of the great mysteries humanity has yet to understand. Key 14 (Temperance), represents this angelic force, which pours forth its influence as the line of **♁** surfaces at the above southwest corner. Thus we find the Archangel for the Six of Cups: **מיכאל**, the great Solar Angel.

### Meditation on the Six of Cups

**נמכ - 44 in ♁**

Begin by placing the Six of Cups and the articulated major keys before you. Before focusing your attention on the keys, chant the Archangelic Name **מיכאל**. The notes are G<sup>#</sup>, F, A<sup>#</sup>, E, and F<sup>#</sup>.

After placing your attention on the keys for a few minutes, chant the notes that are attributed to each key. These are: D, G, C, C, B, A<sup>#</sup>, and G<sup>#</sup>.

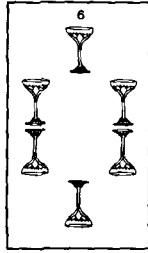

The time period for the Six of Cups is from November 1 to November 10. The key word is **BETTERMENT**. We must maintain the idea that betterment is a relative term. Is it the betterment of the personality, or the better and deeper connection with the Soul?

### The Seven of Cups

## The Seven of Cups

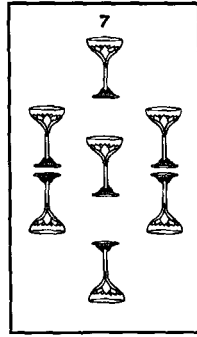

The Seven of Cups corresponds to **נצה** in the creative World of **בריה**. The Seven of Cups is symbolic of the combination of the desire nature and the Creative world. It is the desire nature that adds a fire to the creative process.

The Seven of Cups is representative of the astrological influences of the **♃** in **♍**. This minor key brings in a tremendous symbol concerning humanity's relationship to the greater Being in which we live. **♃** rules the third decanate of **♍** and further supports this idea of the influence we receive from our greater Ring-Pass-Not. Key 7 (The Chariot) is the Intelligence of the House of Influence. It is through this Intelligence of the House of Influence that the collective subconscious level, of which humanity is a part, receives the suggestions that precipitate the expressions and personal experiences we call the six subdivisions of **רוח**. These subdivisions are:

- Memory;
- Volition;
- Ego;
- Desire;
- Intellect; and
- Automatic Response.

It is the aspect of desire to which the Seven of Cups speaks specifically. In the case of the Sphere of **נצה**, this influence brings the aspirant to the gate of transformation; from that of being an accepted disciple to that of being an initiate.



The major keys that articulate the Seven of Cups are:

- Key 3 (The Empress), ♀, נצה;
- Key 13 (Death), the sign of ♁;
- Key 16 (The Tower), ♂, the ruler of ♁;
- Key 7 (The Chariot), ☞, ruler of the third decanate of ♁;  
and
- Key 2 (High Priestess), The ♃, ruler of ☞.

The World of **בריה** is perhaps most influential within this particular sphere. The Sphere of Desire is perhaps the most active within the mechanism of man. The difficulty lies in the fact that most of the creative imagery is made unconsciously, and therefore produces much pain and many difficult lessons. The influence of the ♃ demonstrates the fact that humanity and the personality complex exist within the collective subconscious of a greater being. The path of the Uniting Intelligence, to which the ♃ is attributed, is the actual diameter of the sphere which defines the creative world.

The location of the Seven of Cups is just below the southwest above corner. It is just about to emerge into self-consciousness.

As you can see, the Seven of Cups does not quite break the surface of the above face. There is something that must take place within the disciple before the actual integration of this step can take place. This has to do with meditation and the bringing of the fish, ג, into consciousness by means of the fishhook, ז.

The Eastern initiate calls the building of the Antakarana the Rainbow Bridge, which links the lower personality triad with the higher aspects of the Soul.

The High Priestess represents the Universal First Matter, and it is through her substance that this bridge is made, thus unifying the lower to the higher, giving full expression of the greater being through the personality.

**אוריאל** is the Angel of נצה. This is the angel of mystery and of occultism. Note that the intelligence for נצה is called the Hidden or Occult Intelligence. There are many faces to this angel. The Hermit, The Devil and the Angel of Death are all aspects to this great angelic being.

## Meditation on the Seven of Cups

גג - ד in מ

Begin by chanting the Archangelic name אוריאל. Now place the Seven of Cups, and the articulated major keys before you. Spend a few minutes soaking in each of the Tarot keys. It is focused attention on each of the keys that allows for the greater impact that creates the environment for transformation. After focusing on each key, chant the appropriate notes. These are F<sup>#</sup>, G, C, C, G<sup>#</sup>, and D<sup>#</sup>.

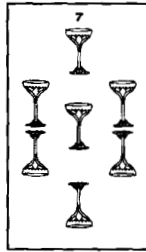

In this meditation we want to visualize the emergence of consciousness from the below face to the above face through the power of

meditation. Visualize the building of the rainbow bridge. This is symbolically shown in Key 14 (Temperance). These two keys merge at the southwest above corner.

The time frame for the Seven of Cups is November 11 to November 20, and the key word is **ILLUSION**. This is what we must rise above.

# Chapter XVIII

## The Decanates of ⚡

Thus am I as one, who testeth gold in a furnace,  
And this aspect of my being  
Presenteth to the unrighteous  
A face of wrath.  
Yet by the purgation of fire  
Do I uphold and sustain thee  
In every moment of thy life.<sup>20</sup>



As with the other mutable signs, we will be dealing with the lower spheres on the Tree of Life, and thus the lower aspects of personality. In the case of ⚡, we are dealing with the principles of these aspects, for we are in the World of **אצילות**, or  $\Delta$ .

In the last chapter, we spoke briefly about the Antakarana, the Rainbow Bridge that connects the threefold personality to the Divine Ego, or Soul. In a very deep manner this involves the symbolism of Key 14.

Before one can fully live the life of the Soul, there must be a total destruction of the causal body. This makes one a true master of the wisdom. Alchemically, the sign of ⚡ is given to the operation of **Incineration**. In his course on the Great Work, Dr. Case speaks on

the subject of incineration, in which he says,

“Incineration burns to ashes the dross and refuse of the old ways of thinking. It consumes all the residue of our erroneous interpretations of experience.”<sup>21</sup>

With the alchemical process of putrefaction, matter is broken down, yet the gross matter remains. Thus we see the rising of  $\aleph$  into the  $\Delta$  and line and of  $\aleph$ , where the final purification takes place. This final purification is incineration.

Notice that the Seven of Cups does not break into the above surface. This is an indication that we cannot purge the final dross ourselves, but instead must rely on the work of the Solar Angel. The final work is performed, “by the grace of God.” There is much mystery concerning the Solar Angel. According to the Trans-Himalayan teaching, The Solar Angel is released upon the destruction of the causal body.

With the three decanates of  $\aleph$ , we will meditate upon the principles behind the very nature of our work: the mental, emotional, and physical bodies. These are the Eight, Nine, and Ten of Wands.

### The Eight of Wands

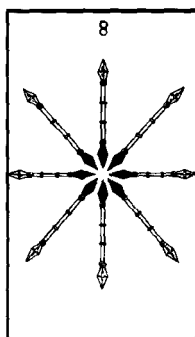

The Eight of Wands is **הור** in the World of **אצילות**. This is the Sphere of Intellect, the fifth subdivision of **רוח** in the World of  $\Delta$ . The Eight of Wands is the principle behind the intellect, and therefore transcends anything we can imagine concerning its nature. Thought and intellect are functions of the mind, and are expressed in

the two lower worlds of **עשיה** and **יצירה**. What the Eight of Wands represents is expressed through the equipment, i.e., the mind and brain in the two lower worlds, but the equipment is not the source of what is being expressed.

Thus we once again come to the point at which nothing that is expressed within the personality has its origin in the personality. Eastern students call this concept Atma. It is pervasive throughout creation and transcends any container that may express it. Thus we find that any initiate who expresses the Eight of Wands in its totality, that is **הוד** in the World of **אצילות**, must be a true Master of Wisdom. Atma is the true  $\Delta$  behind **הוד**, and can only be expressed after the initiate has been through the fires of incineration. What is required of the disciple in order to enter into the spirit of these decanates is astounding. Few in any generation would choose to walk such a path as the path of  $\Delta$ .

Because of the symbolic nature of the Tarot we can approach this work slowly, and let the powerful symbolism do its work. There is much preparatory work to do before one enters into this world.

The major keys that articulate the Eight of Wands are:

- Key 1 (The Magician), ♀, symbolic of the Sphere of **הוד**;
- Key 14 (Temperance), the sign of ⚡; and
- Key 10 (Wheel of Fortune), ♃, ruler of ⚡.

To the best of my knowledge, there is no clear differentiation in the intelligence of a path as it is expressed in the different worlds. The title (Intelligence) and hence the attributions remain the same from world to world. The Eight of Wands is truly the “Perfect Intelligence” in every way. However, the expression of **הוד** as the Perfect Intelligence in the lower worlds is prone to distortion with perhaps the exception of **בריה**.

The *Thirty-two Paths of Wisdom* says of the Perfect Intelligence,

“It is called this because it is the Original Arrangement. There is no root, through which it can be pondered, except through the chambers of Greatness, which emanate from the essence of its permanence.”<sup>22</sup>

This is not a quality we find expressed in the lower aspects of human intellect.

The location of the Eight of Wands is on the west above line that traverses the Cube form north to south. The northwest corner is occupied by the first decanate of ♃.

### The Location of the Eight of Wands

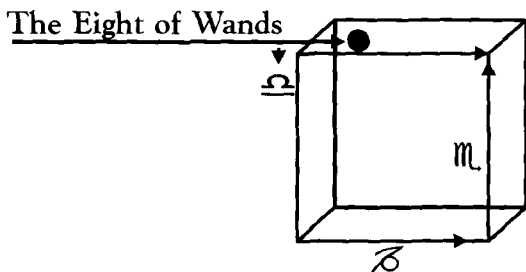

Figure 41.

The design of the Eight of Wands shows a wheel of eight spokes. This is the same design that is on the Wheel of Fortune, The Fool's garment, the eight straight rays in Key 19, and the eight divisions in the star of Key 17. The eight spokes are an intimation that the Eight of Wands is an expression of the quintessence, the highest aspect of Mind, expressed through the intellect.

### Meditation on the Eight of Wands

סב 4 in ♂

Begin by chanting the Divine Name associated with the Sphere of הוד in אצילות. The Name attributed to the Eight of Wands is אלהים צבאות, meaning the God of Armies. The notes are E, F<sup>#</sup>, C, F, G<sup>#</sup>, A<sup>#</sup>, E, E, C<sup>#</sup>, and A. Place the Eight of Wands and the articulated major keys before you. Give each of the keys a few minutes of focus. After this time, chant the appropriate notes. The notes are E, G<sup>#</sup>, and A<sup>#</sup>.

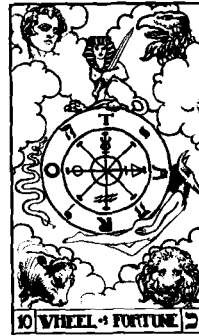
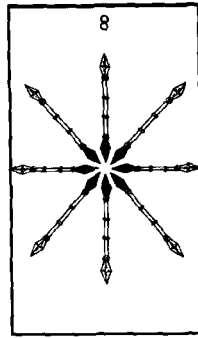

There is a very strong message given by this combination of Tarot keys. We have the symbol of intellect given by Key 1 (The Magician) and the symbol of memory, expansion, and beneficence brought forth by Key 10 (Wheel of Fortune). We can expect our level of self-conscious awareness to expand slowly as we meditate upon these keys. If we really want to accelerate change, we must incinerate those aggregates which find their way within our consciousness to insure that our expansion of consciousness is based on the gold that is tested and tried in the furnace of the Solar Angel.

The time frame for the Eight of Wands is November 22 to December 1. The key word is **SWIFTNESS**.



## The Nine of Wands

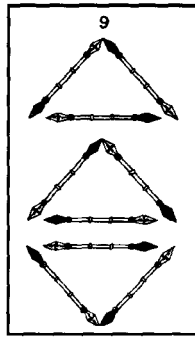

The Nine of Wands takes us to the second decanate of  $\text{♁}$ , and one step further across the threshold of the west as we move from north to south. We are dealing with the highest aspect of the Sphere of **יִסוּד** expressed in the World of **אֲצִילוֹת**. Astrologically we are dealing with the planet  $\text{♁}$  in the sign of  $\text{♁}$ . This minor key is the principle behind form, or that which is the foundation of form. The numerical value of **יִסוּד** and the letter attributed to  $\text{♁}$ , **פ**, is 80. This informs us that the power of reproduction, which is ruled by  $\text{♁}$ , is the same power employed in the reproduction of patterns within the Sphere of **יִסוּד**.

The major keys that articulate the Nine of Wands are:

- Key 2 (High Priestess), symbolic of the Sphere of **יִסוּד**;
- Key 14 (Temperance), the sign of  $\text{♁}$ ;
- Key 10 (Wheel of Fortune),  $\text{♁}$ , ruler of  $\text{♁}$ ;
- Key 4 (The Emperor),  $\text{♁}$ , ruler of the second decanate of  $\text{♁}$ ; and
- Key 16 (The Tower),  $\text{♁}$ , ruler of the sign of  $\text{♁}$ .

The location of the Nine of Wands is just south of the Eight of Wands, as indicated below.

## The Location of the Nine of Wands

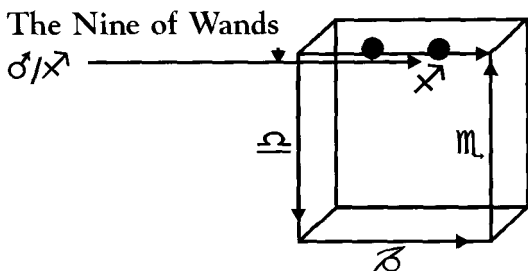

Figure 42.

The very symbolism of the Nine of Wands indicates reproduction. The triangles, of which there are three, are reproductions of each other. The Supernal Triad forms a triangle with the first three spheres, the Egoic spheres form a triangle with spheres 6, 7, and 8, and the lower personality triangle is formed as a direct reflection of the Egoic. These are spheres 7, 8, and 9. In the later case the triangle is reversed. It is the reflective process that creates so much trouble in our lives. As we create the environment for clear, accurate reflection, we begin to express the Divine Ego.

The Vital Soul, of which **יִסִּיד** is the seat, holds the subtle substance that allows for the transformation of chemistry of the physical body. These transformations take place through the reproduction of the subtle images originating at the self-conscious mind of the disciple.

These transformations are precisely what are addressed in the symbolism of the Nine of Wands.

## Meditation on the Nine of Wands

**ספ ט in X**

After the usual attunement, chant the Divine Name attributed to the Sphere of **יִסוּד**. The name is **שְׂרֵי אֵל חַי**, Almighty God of Life. Place the Nine of Wands before you along with the articulated major keys.

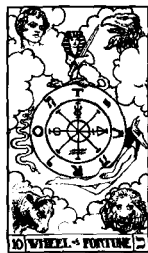
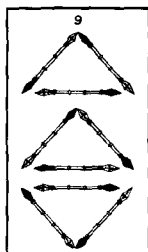

After you have observed the keys for a few minutes, chant the notes attributed to each key, which are G#, G#, A#, C, and C.

The time frame for the Nine of Wands is from December 2 to December 11, and the key word is **PREPAREDNESS**.

### The Ten of Wands

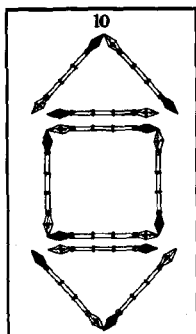

The Ten of Wands completes the Tree of Life in the World of **אצילות**. This minor key represents the Sphere of **מלכות** in the World of  $\Delta$ . **מלכות** in the World of **אצילות** is the perfected pattern for humanity set forth by the creator. This is what Masons refer to when they say,

“There is a pattern laid down in the heavens to which humanity must conform. Let that which is below be as that which is above.”

The perfect pattern already exists. The perfect image that our minds must grasp is, in the World of **אצילות**, a reality. The creative act of intention that flows through the spheres is fulfilled in **מלכות**. **מלכות** in **אצילות** is complete in its own world; however **מלכות** of  $\Delta$  seeks to express itself in **מלכות** of the denser worlds.

The Ten of Wands from our perspective is the earth that is “formless and void”. It is the *magical earth* to which the alchemists refer. To know it is to know the first matter of the stone of the wise. It is this first matter that is the organizing principle for the creation of form. Thomas Vaughn writes in his *Magica Adamica* concerning the first matter,

“I know the common man will stare at this, and judge me not very sober which I affirm the earth, which of all things is most gross and palpable, to be invisible. But, on my Soul, it is so, and which is more, the eye of man never saw the earth, nor can it be seen without art. To make this element visible is the greatest secret in Magic, for it is a miraculous Nature, and of all others the most holy, according to that computation of Trismegistus —‘the Heaven, the Aether, the Air, and the most sacred earth.’ As for this feculent, gross body upon which we walk, it is a compost and no earth, but it hath earth in it, and even that also is not our Magical Earth. In a word, all the elements are visible but one, namely the earth, and when thou hast attained to so much perfection as to know why God hath placed the earth in abscondito, thou hast an excellent figure to know God himself, and how he is visible, and how invisible.”

The major keys that articulate the Ten of Wands are:

- Key 21 (The World), symbolic of the Sphere of **מלכות**;
- Key 14 (Temperance), the sign of  $\text{♁}$ ;

- Key 10 (Wheel of Fortune), ♃, the ruler of ♁;
- Key 8 (Strength), ♂, the ruler of the third decanate of ♁;  
and
- Key 19 (The Sun), ☉, ruler of the sign of ♂.

The location of the Ten of Wands is south of the Nine of Wands and brings the line of ♁ to completion at the southwest corner, where it receives the influence of ♃.

### The Location of the Ten of Wands

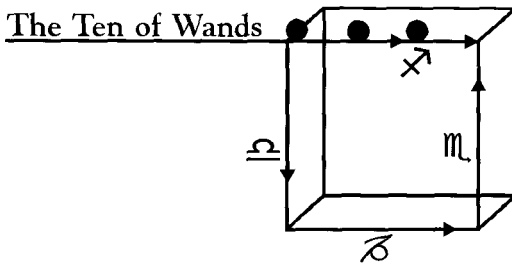
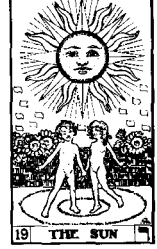
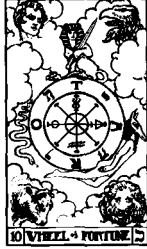
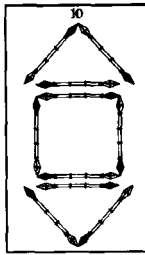

Figure 43.

### Meditation on the Ten of Wands

סר ☉ in ♁

Place the Ten of Wands and the articulated major keys before you. After the usual attunement, chant the Divine Name for מלכות, which is אדני הארץ. The notes are E, F, G, F, C, E, D, F, and A#. After focusing for a few minutes on each key, chant the notes attributed to each key. These notes are A, G#, A#, E, and D.



The time frame for the Ten of Wands is from 12 December to 21 December. The key word is **FULLNESS OF POWER**.



# Chapter XIX

## The Decanates of ⚡

Ayin is that EYE,  
And it is in every place in very truth,  
Because place there is not, save in the manifested  
And wherever place is  
There also are light and darkness, side by side.  
From the mixture of light and darkness  
Do all things proceed,  
And I am Prince of Darkness,  
As well as King of Light.  
Shall there be anything

Wherein I, the Lord of all, have no dominion?<sup>23</sup>

*also all of PSALMS 139*

*PSALMS 139:8.*

*If I ascend up into heaven  
thou art there: if I make  
my bed in hell, behold, thou  
art there.*



The decanates of ⚡ hold a great mystery for humanity. There are several points that when understood, can reveal much about that which causes fear in the heart of man. As we observe the specifics of Key 15, our attention is drawn to the hand posture of the central figure. The right hand of the Devil offers a symbol indicating that what we experience upon the ontological plane of sensory awareness is all that there is. Throughout the ages, experience has taught the disciple the painful lesson that the truth is otherwise.



As we begin to use the power of discrimination, we can know that the subjective reality, which natural science attempts to know objectively, is the foundation of all that is objective. Using the law of correspondence, we can demonstrate the fact that the unknowable is the foundation for the knowable physical existence.

Irrational numbers are not finitely defined. Numbers such as  $\pi$  (3.1414...), giving us the approximate measurements of a circle,  $\phi$  (0.618...), giving the approximate mean and extreme proportion, and the  $\sqrt{2}$ , defining the angle of 90 degrees, are all irrational numbers; yet they define the World of Name and Form.

**Fermentation** is the alchemical process attributed to  $\mathcal{Z}$ . This is a subtle operation that is most effective in transforming matter, and even in bringing forth substances that do not normally exist within the object of our work.

Anyone who has made bread or wine knows that when a living organism such as yeast is introduced within a nurturing environment, rapid growth will occur. Juice from grapes produces a substance that does not exist in the juice itself. So, only the process of fermentation can make bread and wine and release the spirit of the plant kingdom for a higher expression: that of food for humanity.

Alcohol, which is called "spirits" or  $\mathcal{Z}$  of the plant kingdom, can only be produced through fermentation. The process of fermentation will cause the death of the organism being fermented. In the mineral kingdom, a similar process can be achieved, and the products of this action produce the solvents we call acids. In order for grapes to become wine or wheat to become bread, they must die. Using the law of correspondence we may gain some profound insights into what is in store for the initiate as he enters the gate of the Fifth Kingdom. Since the decanates of  $\mathcal{Z}$  represent spheres 2, 3, and 4, we can look at them as a leaven, which prepares the lower spheres for the feast of that greater being within whom we live.

The location of the decanates of  $\mathcal{Z}$  are on the below west line moving parallel to the above line of  $\mathcal{X}$ . The influence of this line flows into the ascending line of  $\mathcal{M}$ , where it contacts the above line of  $\mathcal{X}$ . The following diagram shows their location.

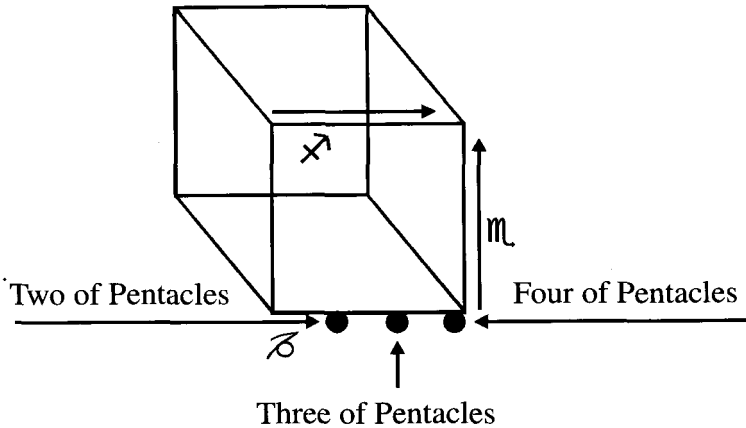

Figure 44.

It is important to note that on the Cube, the three lines of  $\aleph$ ,  $\beth$ , and  $\zeta$  are the three paths on the Tree of Life that take the aspirant from the lower spheres of the personality to the Sphere of the Divine Ego seated in **תפארת**. Each of these paths involves an alchemical operation that induces the total break down of the form, releasing the spirit aspect. It is also crucial to point out that each of these signs has a deep relationship to the  $\sigma$  force. These operations are:

- **Putrefaction** through the path of  $\beth$ ,  $\aleph$ , where  $\sigma$  is ruler;
- **Incineration** through the path of  $\zeta$ ,  $\beth$ , where  $\sigma$  is the hierarchical ruler; and
- **Fermentation** through the path of  $\aleph$ ,  $\zeta$ , where  $\sigma$  is the exalted planet.

As the disciple completes the traversing of these paths, there is nothing left to reveal but the life of the Soul.

## The Two of Pentacles

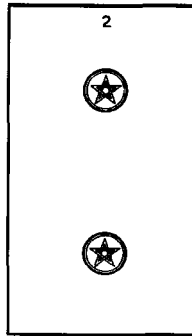

The Two of Pentacles brings us to the final approach of the creative forces into the World of Name and Form. This minor key begins this final approach and symbolizes **הכמה** in the World of **עשיה**. Astrologically this is  $\text{ħ}$  in  $\text{♄}$ . Satan and Saturn are two very similar words and esoterically they represent the limitation and confinement of the spirit aspect within matter.

The older versions of the Tarot call The Devil “Diabolos,” meaning slanderer. Anyone or anything that creates illusion for the aspirant is in fact doing the work of the Devil. The Tibetan Master Djwhal Khul says this about the Devil:

“The aspirant who builds his Dweller and permits its steady and increasing control becomes a deluder of souls. He is a true Anti-Christ, and through false teaching and the working of so-called miracles, through hypnotism and mass suggestion he draws a veil over the world and forces men to walk in the great illusion. It is interesting to note that the work of the Devil, the prisoner of souls is beginning to lose its power, for the race is on the verge of understanding true death is immersion in form, and matter is but a part of the divine whole.”<sup>24</sup>

If we are to take a positive look at what the Two of Pentacles represents, we must keep in mind the necessity for limitation. We

addressed this point at great length in Chapter I.

On the form side of things, we are dealing with the Sphere of **חכמה** in the World of **עשיה**. This is the manifestation of the Sphere of the Zodiac. This manifestation creates the skeletal structure for the Cube of Space, for the boundaries of the Cube are in fact the signs of the zodiac, within which our planetary life unfolds. These boundaries are what are referred to as the highways of the stars, or **מזלות**.

Since we are working with the suit of Pentacles we are also dealing with a highway of stars that is present within each and every human personality complex. This power is contained and limited within a form, and we must learn how to consciously direct it.

The major keys that articulate the Two of Pentacles are:

- Key 20 (Judgement), symbolic of the Sphere of **חכמה**;
- Key 15 (The Devil), the sign of  $\text{♄}$ ; and
- Key 21 (The World),  $\text{♁}$ , ruler of the sign of  $\text{♄}$ .

The location of the Two of Pentacles is on the west below line, running parallel to and below the line of  $\text{♁}$ . The earlier diagram demonstrates this.

One of the key points to remember concerning the Two of Pentacles is that it is symbolic of all that is inherent within the Sphere of **חכמה**. **חכמה** is the Sphere of the Zodiac, and in the World of **עשיה** it is manifested as the stars in the heavens and as radiant energy. In Qabalistic terms this radiant energy is **חיה** and it is the Life Force that animates all so-called living things. This force also exists in latency within the kingdoms that appear to be non-living. This is why the alchemists say that all things manifested are living things.

Key 21 and the letter **ת** are called the Administrative Intelligence, and as students of occultism, we must learn to be administrators of the sacred radiant Life Force that courses through our bodies.

## Meditation on the Two of Pentacles

**ת**  $\text{♁}$  in  $\text{♄}$

After the usual attunement, chant the sacred word attributed to **חכמה** in the World of **עשיה**. This is **מסלות**, the highway of the stars. The notes are G<sup>#</sup>, G<sup>#</sup>, F<sup>#</sup>, C<sup>#</sup>, and A. After chanting this word,

place the Two of Pentacles before you along with the articulated major keys.

After focusing your attention on the keys for a few minutes each, chant the notes attributed to each key. They are C, A, and A.

Remember that the Two of Pentacles is the earthly manifestation of a power that transcends the physical, but seeks to express itself in the physical.

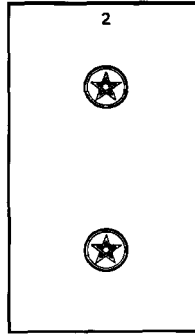

The time frame for the Two of Pentacles is December 22 to December 31. The key word is **FLUCTUATION**.

## The Three of Pentacles

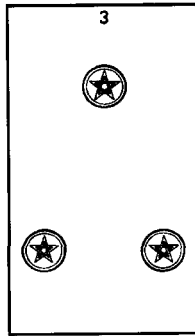

The Three of Pentacles is the second decanate of  $\mathcal{A}$ , and represents the Sphere of **בינה** in the World of **עשיה**. **בינה** is the form-giving sphere, and its body of manifestation within this solar system is the planet  $\text{ḥ}$ . Astrologically the Three of Pentacles is subruled by the sign of  $\text{♄}$  and the planet  $\text{♀}$ . This suggests a deep connection to the process of creation, and the fixation of the volatile. The sign of  $\text{♄}$  is alchemically concerned with the **congelation** of the waters of consciousness into a physical form. Thus we find that the Sphere of **בינה** in connection with  $\text{♀}$  in  $\text{♄}$  creates the environment for the precipitation of form.  $\text{ḥ}$  and  $\text{♀}$  have many similarities. On the Tree of Life, we find the Sphere of **בינה** connected to the Sphere of **חכמה** through the path of  $\text{ד}$ , or  $\text{♀}$ . This path takes the power of limitation back to the undifferentiated Sphere of **חכמה**. This path further sets up the conditions for the emanation of the 17<sup>th</sup> path of  $\text{ו}$ , attributed to the sign of  $\text{♄}$ . On the Cube of Space, we find the sign of  $\text{♄}$  with the ruling power of  $\text{♀}$  surfacing on the southeast above corner. It is on this ascending line that the volatile mind stuff is congealed into objective form.

The major keys that articulate the Three of Pentacles are:

- Key 21 (The World), symbolic of the Sphere of **בינה**;
- Key 15 (The Devil), the sign of  $\mathcal{A}$ ;
- Key 21 (The World),  $\text{ḥ}$ , ruler of the sign of  $\mathcal{A}$ ;
- Key 5 (The Hierophant), the sign of  $\text{♄}$ , ruler of the second decanate of  $\mathcal{A}$ ; and
- Key 3 (The Empress),  $\text{♀}$ , ruler of the sign of  $\text{♄}$ .

If we bring the sign of  $\text{ז}$ , as ruled by  $\text{ז}$ , in synthesis with the Sphere of  $\text{ה}$ , we can discover the central theme common to each of these influences. That common theme is intuition. **נשמה**, the Divine Soul, seated in the Sphere of **בינה**, is the source of intuition. It is not until the path of  $\text{ד}$  returns back to the Sphere of **חכמה** that the path of  $\text{ו}$  can descend into the six aspects of the human personality. Through the path of  $\text{ו}$  we have the intuition of **בינה** at our disposal. On the Cube of Space we find the sign of  $\text{ז}$  bringing that intuition from the below—the abode of the High Priestess, Sophia, to the above—the abode of self-consciousness.

From the human perspective, we must avail ourselves to the intuition that is continually present and ready to bring us closer to the mind and heart of the greater being in whom we live. As mentioned in Chapter XVII, on the decanates of  $\text{מ}$ , we must receive the impressions from that which is above. These suggestions, using the law of correspondence, **originate at the self-conscious level of a greater being**. Our understanding of these suggestions is what we call intuition. The voice of The Hierophant is a call to harmonious alignment with the one within whom we live.

As we progress in our ability to hear the Voice of Silence, our mental images become more defined ( $\text{ז}$  in  $\text{ז}$ ), and our entire experience in the world shifts from chaos to ordered harmony.

The location of the Three of Pentacles on the Cube is just south of the Two of Pentacles on the west below line, traveling from north to south by way of the west. This has been shown in the earlier diagram.

### Meditation on the Three of Pentacles

**ער**  $\text{ז}$  in  $\text{ז}$

After the usual attunement, chant the planetary name attributed to the Sphere of **בינה**. The name is **שבתאי**. This is the planetary name for  $\text{ה}$ . After chanting this name, focus your attention on each of the keys.

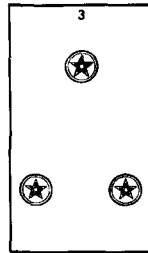

After you have finished observing the keys, chant the notes attributed to each key. They are A, A, A, F<sup>#</sup>, and C<sup>#</sup>.

The time period for the Three of Pentacles is from January 1 to January 9, and the key word is **CONSTRUCTIVENESS**.

### The Four of Pentacles

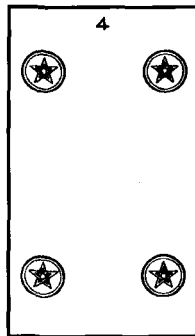

The Four of Pentacles is **חסד** in **עשיה**. **חסד** is the Sphere of 4, and thus the Four of Pentacles symbolically expresses all that is intrinsic within that sphere. The quality of Mercy and Magnificence are given to this sphere, as well as the first subdivision of **רוח**, memory. Since the Four of Pentacles expresses the World of **עשיה** we have



before us a symbol of that which can be objectively experienced in the world of every day.

The most objective phenomenon regarding this particular minor trump is that it represents the present moment. ♄ is located on the western face of the Cube. The eastern face, ♀, represents the cause of those events that we experience in the present moment. Thus ♄ is the receptacle of the influences which originate in the east and manifest in the west. It would be well worth the effort to review the meditation in Chapter IV on polarity between ♀ and ♄.

Astrologically, the Four of Pentacles is expressed as ♀ in ♃. This brings us to one of the core teachings of occultism, of which Dr. Case has written much. This concerns the influence of self-consciousness, ♀, on the area of the body known as the ♃ region. Key 15 (The Devil), alludes to this with a symbol of ♀ just below the navel of the central figure, where the small intestine is located. This teaching is concerned with the relationship between ♀ and ♃, as it applies to the transformations necessary within the human body in order to make the transformation into the Fifth Kingdom. ♃ subrules the third decanate of ♃.

The sign of ♃ is attributed to the alchemical operation of **distillation**. In the context of the Four of Pentacles we are specifically dealing with the separation of the volatile ☉ which exists in the food we eat, the water we drink, and the air we breathe. In the sign of ♃ we are interested in the volatile ☉ that exists in the food we eat and the absorption of this essence of the ☉ into the mechanism of the body. When we discover the reality that is the direct result of the success of this operation of distillation, we will have discovered the "First Matter" of the alchemists.

It is noteworthy to point out that the path of ♃, the letter attributed to the sign of ♃, is the connecting path between the Sphere of **חסד** and the Sphere of **תפארת**. If we were to continue in the path of descent, from **תפארת** to **הוד**, we would find the path of **ע**, The Devil, connecting these two spheres. Notice that Key 9 and Key 15 are in direct line with each other, with the Sphere of **תפארת** between them. This may give us some insight into the meaning of the phrase, "the Devil is God as seen by the wicked."

The laws of occultism have taught us that the subconscious mind is amenable to suggestion. Our usual understanding of this is represented by the relationship between Key 1 (The Magician) and Key 2

(High Priestess). We must also remember that the four keys that occupy the boundaries of the below face of the Cube are also part of this subconscious process. These are Keys 7 (The Chariot), Key 9 (The Hermit), Key 15 (The Devil), and Key 18 (The Moon). The Magician, ♃, enters into activity by implanting its suggestions, that originate at the self-conscious level into each of these astrological signs. Thus we find that the two descending lines of ♋ and ♌ create the channels for the descent of self-consciousness into the subconscious level. Two of the below lines, ♍ and ♎, are passive cardinal signs. The other two signs, ♏ and ♐, are passive mutable signs. Thus the passive elements of ♋ and ♌ are being influenced by the self-conscious suggestions channeled through the active elements of ♍ and ♎.

The major Tarot keys that articulate the Four of Pentacles are:

- Key 10 (Wheel of Fortune), symbolic of **חסד**;
- Key 15 (The Devil), the sign of ♎;
- Key 21 (The World), ♁, ruler of ♎;
- Key 9 (The Hermit), ♄, ruler of the third decanate of ♎;  
and
- Key 1 (The Magician), ♃, ruler of the sign of ♏.

The location of the Four of Pentacles is at the terminating point of ♎ at the southwest corner. This can be viewed in the diagram on page 241.

Perhaps one of the greatest difficulties that the disciple is faced with is that of knowing the correct image to hold when visualizing the transformation of the body. What does the perfected body of an adept look like? We can only hypothesize what this may be; however we do have access to subtle symbols that assist us in placing the proper suggestions within the subconscious mind stuff. In our visualizations, therefore, let us take special care that we take the time to seed our visualization process with the symbols that have been given us.

The planetary name given to the Sphere of **חסד** in **עשיה** is **צדק**. This name itself means “righteous” and is attributed to the planetary logos who protects and gives many generous gifts to those who seek the path of **צדק**.

## Meditation on the Four of Pentacles

עב ץ in א

After the usual attunement, place the Four of Pentacles before you along with the articulated major keys. Chant the name attributed to חסד in עשיה, which is צדק. The notes for this name are A<sup>#</sup>, F<sup>#</sup>, and B. As in the past, focus your attention on each of the keys for a few minutes each, and then chant the appropriate notes. The notes are A<sup>#</sup>, A, A, E, and F.

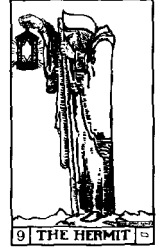
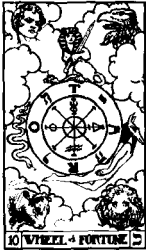
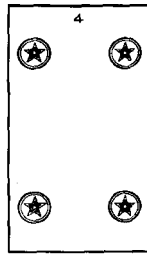

As you approach this meditation, be mindful of the conditions of your life that you are presently experiencing, and see what adjustments need to be made. This meditation is very useful as an evening review of the day's events.

The time frame for the Four of Pentacles is January 10 to January 19. The key word is **MANAGEMENT**.

## Chapter XX

### The Decanates of ♁

Men think they seek me,  
But it is I who seek them.  
No other seeker is there that myself,  
And I when I find mine own,  
The pain of questing is at end.  
The fish graspeth the hook,  
Thinking to find food,  
But the fisherman is the enjoyer of the meal.<sup>25</sup>



We are now involved with the sealing of the final face on the Cube of Space. ♁ is located on the south above line moving from the west to the east. The decanates of ♁ receive the direct influence from the west above line of ♄ and the southwest ascending line of ♃. Together these two signs flood into the line of ♁ and flow toward the east.

The alchemical operation attributed to the sign of ♁ and the letter **⚹** is **dissolution**. Using the symbolic language of alchemy, we find that the symbol for dissolution and the sign of ♁ are the same.

What ♁ must sort out through the process of meditation and dissolution, has to do with the confrontation of the three Dwellers.

Keys 13, 14, and 15 symbolically represent these three Dwellers. You will notice that each of the Dwellers guards the portal to the Sphere of תפארת. No one can become an adept if she or he has not confronted The Devil as well as The Angel of Death, and has been tested by The Solar Angel.

There is one other line of influence that must be mastered before one can move into the southern face. This is the descending line of ♎, where the Lord of Karma, ♃, is exalted in the sign of balance. Thus we see that the entire western face deals with the severity of karma through the influence of ♃ and ♂. These are expressed in the signs of ♎, ♋, and ♌. ♃ is exalted in ♎, and rules the sign of ♋. ♂ is exalted in the sign of ♋, and is ruler in the sign of ♌. The power of the Lord of Death and transformation, ☿, is then drawn up through occult meditation into the sign of ♎. It is at this point where the forces of Death shift from exaltation in the sign of ♌, to being a co-ruler with the Lord of Karma in the sign of ♎. This creates the necessary balance between ♃ and ☿.

Metaphorically, we are dealing with the fishhook, ♄, and the fish, ♐. Through the sign of ♎ and the process of meditation, the fishhook draws the fish of ♌ from the waters of subconsciousness into the light of The Star, Key 17.

The location of the decanates of ♎ are on the south above line. The following diagram shows this.

The Placement of the Decanates of ♎

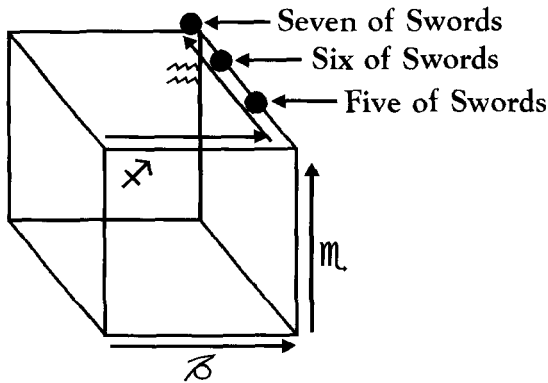

Figure 45.

## The Five of Swords



The Five of Swords is symbolic of **יצירה** in **גבורה**. Once again we are working with perhaps the most potent symbol in our occult studies: the pentagram. The five swords are placed in this geometric form to indicate the position of humanity within the scheme of the divine plan. This position of man is as the intermediary between the Divine, or what we call God, and the kingdom of nature.

We can see some interesting relationships between **♂** and **♁** both on the Tree of Life and on the Cube of Space. A close look at these relationships will assist us in gaining a deeper understanding of what lies behind the symbolism of the Five of Swords. These relationships concern what was mentioned earlier about the western face of the Cube.

First of all, the Sphere of **♁** is the direct source of the Sphere of **♂**. As we look at the Tree of Life we can see that the Sphere of **גבורה** receives its impulse from the Sphere of **בינה** through the path of **ה**. We can therefore see a deep relationship between the field of expression between these two planetary intelligences. The following diagram shows the connection between these two spheres.

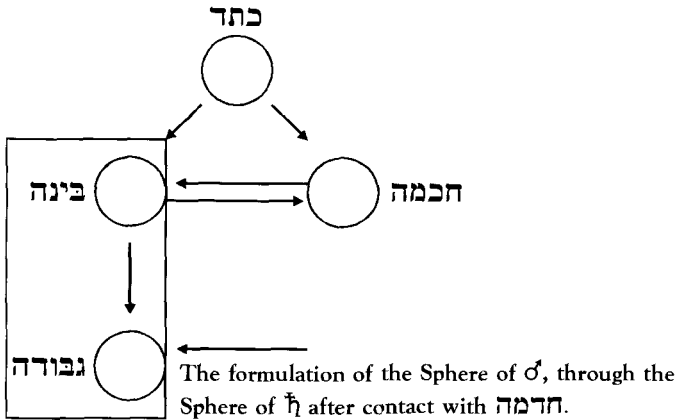

Figure 46.

On the Cube of Space we find similar connections between ♂ and ♀. The key to these connections lies within the signs of ♃, ♁, ♀, and ♄. This has to do with the movement of ♀ through ♁ into ♃, and the movement of ♂ from ♃ into ♄.

In traditional mundane astrology, ♀ and ♂ are said to be the worst of bedfellows, yet the deeper occult teaching tells us otherwise. The great difficulty, which gives testimony to the mundane astrologers, is in bringing them into balance. Thus the Five of Swords presents us with this challenge: ♀\♂ in ♁ in the Sphere of ♂. Perhaps one of the biggest lessons concerning this minor key is in the way we create our mental patterns. Whatever limitations we create, (♀), and the life force we place within it (♂), manifest either joys or sorrows. We must deal with these in the present moment, symbolized by the west. The symbolism of the Five of Swords brings our attention to the fact that we must either create consciously, or deal with the difficult situations that are the inevitable results.

The major keys that articulate the Five of Swords are:

- Key 16 (The Tower), symbolic of the Sphere of גבורה;
- Key 17 (The Star), the sign of ♁;
- Key 21 (The World), ♀, co-ruler of ♁; and
- Key 0 (The Fool), ♂, co-ruler of ♁.

The location of the Five of Swords is on the south above line. This is where the forces of ה, ♂, and ט are integrated in order to prepare the individual for the full life of the soul. This can be seen in the earlier diagram.

Since we are working in the World of יצירה, we will be invoking the intelligence of the *prima materia* as it manifests in גבורה in יצירה. The group of angelic forces associated here is called the ים - שרפ, and are the expression of the substance of Δ. This is the reproductive energy used in the manifestation or the regeneration of form.

### Meditation on the Five of Swords

ה\ט in כשא

Begin by laying the Five of Swords and the articulated major keys before you. After the usual vibratory alignment, chant the name of the Choir of Angels associated with גבורה in יצירה, which is ים - שרפ. The notes for this name are: C, D, C, F, and G#. After observing the keys for a few minutes each, chant the appropriate notes for each key. These are C, E, A, and A#.





We are attempting to balance the power between limitation and expansion. We are also working the proper application of the ♂ force within the container of manifestation. Consistent effort with this key will bring you to confront the fears that are holding you from progress, and cause you to pay greater attention to how it is that you create the particular circumstances in which you presently live.

The time frame for the Five of Swords is from January 20 to January 29. The key word is **DEFEAT**. In this meditation keep two things in mind. First think of what is being defeated, and second, remember that the key word “defeat” applies to the personality level. On the soul level it simply means the destruction of all impediments that keep us from greater soul expression.

### The Six of Swords

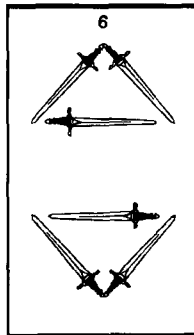

The Six of Swords is **יצירה** in **תפארת**. This is the central ego working in the world of formation. This key symbolizes the pattern we must build in order for humanity, either collectively or individually, to express its destiny. This trestleboard is for the building of the *Sanctum Sanctorum*, or Holy of Holies in the Temple of the Lord.

One of the main qualities of the Six of Swords is that of linkage. The aspect of linkage is intimated in a couple of ways. First, we are working in the World of **יצירה** which is given the attribution of the letter **ו**. Second, **תפארת**, the sixth sphere, is also given the attribution of the letter **ו**. In this context, **תפארת** is the recipient of all the influences which are above it, and it distributes those influences to that which is below it. We thus have two expressions of **ו**. The greater expression of **ו** in **יצירה** is that of being the link between the

world above it, **בריה**, and the world below it, **עשיה**. The Sphere of **תפארת** performs its work of linkage within the World of **ו**, or **יצירה**.

A second point concerning linkage is concerned with man himself. The World of **יצירה** is attributed to mankind. This brings us to the symbols of the microcosm and macrocosm, or the pentagram and hexagram. Man is the linking principle through the aspect of his constitution called *Manus*. This connects the Atmic and Buddhic levels with the kingdoms below man. This is expressed through the symbolism of the Six of Swords. ♀ in **II** rules the second decanate of ♁. ♀ is the messenger of the gods and it is self-consciousness that ♀ represents. ♀ acts as the intermediary between the higher and lower kingdoms.

The major keys that articulate the Six of Swords are:

- Key 19 (The Sun), symbolic of the Sphere of **תפארת**;
- Key 17 (The Star), the sign of ♁;
- Key 6 (The Lovers), **II**, ruler of the second decanate of ♁;  
and
- Key 1 (The Magician), ♀, ruler of the sign of **II**.

The location of the Six of Swords is on the south above line just east of the Five of Swords. This can be seen in the earlier diagram.

A very important point to keep in mind regarding the Six of Swords and its representation of **תפארת** in **יצירה** is its location on the construction circles of the Tree of Life. **תפארת** is located at the center of the construction circle of the formative world, which is **יצירה**. **תפארת** is also located on the bottom point of the construction of **בריה**. **תפארת** is also located on the top portion of the construction circle of **עשיה**. This further lends to the idea of **תפארת** being the linkage between that which is above and that which is below.

The order of angels associated with the Six of Swords is **מלכים**, meaning Kings. Angels are not always the winged creatures we have come to associate with the term angels. The word in this context can also indicate individuals who have become advanced brothers and sisters of the race who lift and aid their fellows.

## Meditation on the Six of Swords

צב ♀ in ≍

Place the Six of Swords and the articulated major keys before you. After the usual attunement, chant the name **מלכים**. The notes for this name are G<sup>#</sup>, F<sup>#</sup>, A<sup>#</sup>, F, and G<sup>#</sup>. After observing the keys for a few minutes each, chant the appropriate notes. These notes are D, A<sup>#</sup>, A, D, and E.

We are working toward the reception of the higher aspects of our being. We seek to receive the impressions from the super-conscious levels we call the Atmic and Buddhic planes. Proper reception of these impulses will help produce the necessary images that will take root at the subconscious level of our minds. Thus we may bring to fruition the dormant seed which holds the key to our true nature.

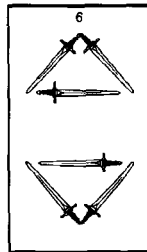

We are ♯ the nail, the hook, the mediators, and the links between that which is above and that which is below.

The time frame for the Six of Swords is from January 30 to February 8. The key word is **PATIENCE**.

## The Seven of Swords

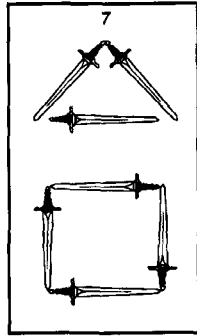

The Seven of Swords is **נצה** in **יצירה**. This is where the Will aspect is expressed as desire. Our desire, if strong and consistent, creates impressions on the formative substance and causes specific patterns to manifest in the World of Name and Form. The major work for all disciples is to use this desire nature consciously and without selfish intentions.

The “White Rose” in the symbolism of the Tarot represents purified desire. Traditionally the red rose represents the raw unrefined desire nature. In Keys 0 and 13 we find the symbol of the White Rose. Notice that Key 0 (The Fool) is attributed to **♁**, which is exalted in the sign of **♈**, and co-ruler in the sign of **♊**. In Key 0 we have the super-conscious self carrying the White Rose without difficulty even though it bears thorns on its stem. In Key 13, the Lord of Death approaches the White Rose with the intention of harvesting it.

Desire as it manifests in the unripe human personality is usually unstable, which gives rise to the volatile negative attributions of Key 0 and **♁**. Our unstable desires are generally the cause of all the ills we face in our lives, and if left unchecked result in death. The World of **יצירה** is also composed of ever shifting forces. The combination of the desire nature and the World of **יצירה** creates difficulties in our lives unless we learn to control this volatile aspect of our nature. Think of all the troubles that we have caused ourselves due to our unripe desire nature.

Because of our lack of training, ignorance, and unchecked desire nature, we often operate, even though unconsciously, as black magicians. Madam Blavatsky was quoted in saying, “anyone below the fourth initiation works as a black magician.” This problem of being a black

magician is not necessarily a conscious one. The negative acts are due more to an uncoordinated personality, where mental images and the desire nature are out of control. We frequently project images precipitated by anger or by a desire to perpetuate our own idea of justice. These feelings create images of harmfulness that may, because of the intensity of the individual, result in great harm to another and eventually the individual who creates the image.

The Tibetan Master D. K. makes this comment about the general thought forms of humanity:

“It will here be noted that this work is either conscious or unconscious. In the unconscious building of thought-forms, such as in the case with the average human being, many never produce the desired physical plane effects, and fail in their intended purpose. As long however, as man is animated by selfishness and by hatred, this is a beneficent thing. Fortunately for the human race, few people as yet work in mental matter. Most of them work with astral or desire matter and these forms are fluidic and changeable, and are powerful only through the faculty of persistence. There is an occult basis for the statement that if one desires a thing for a sufficiently long period of time one will possess it.”<sup>26</sup>

Astrologically the Seven of Swords is ♀ in ♁. The major keys that articulate the Seven of Swords are:

- Key 3 (The Empress), symbolic of the Sphere of **קצנ**;
- Key 17 (The Star), the sign of ♁;
- Key 21 (The World), **ה**, co-ruler of ♁;
- Key 0 (The Fool), **ה**, co-ruler of ♁;
- Key 11 (Justice), the sign of ♋, ruler of the third decanate of ♋; and
- Key 3 (The Empress), ♀, ruler of the sign of ♋.

The location of the Seven of Swords is just to the east of the Six of Swords, on the south above line. The line of ♁ flows into the line

of southeast above corner where it receives the influence of the ascending southeast line of  $\text{♄}$ , and together they flow into the line of  $\text{♁}$ , where the process of integration is completed and a new one begins.

The angelic name for the Seven of Swords is **אלהים**. This name is used often in Biblical text, and does not always mean the same thing. In the creation story of Genesis, we find the word **אלהים** meaning God. In the Book of Job, we find the term **בני אלהים**, meaning Sons of God. As we have already seen, **בני אלהים** is also used for **הוד** of **יצירה**, or the Eight of Swords. In relation to the Seven of Swords these are the creative forces in nature and are not a reference to the creative deity spoken of in Genesis.

### Meditation on the Seven of Swords

**צד ♀ in ☿**

Place the Seven of Swords before you along with the articulated major keys. After your usual attunement, chant the name **אלהים**, remembering that you are dealing with the creative forces of nature. The notes are E, F<sup>#</sup>, C, F, G<sup>#</sup>.

After you have observed the symbols of the individual keys, chant the appropriate notes. These are F<sup>#</sup>, A<sup>#</sup>, A, E, F<sup>#</sup>, and F<sup>#</sup>. The major point of this meditation is to bring the desire nature under control. The western occultist tends to misunderstand the phrase "killing out desire". It is not really killing desire, but bringing it under the control of the Soul.

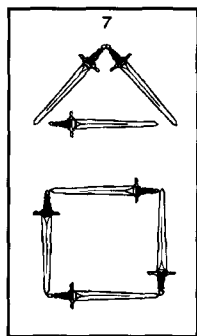

The time frame for the Seven of Swords is from 9 February to 18 February. The key word is **INSTABILITY**.

# Chapter XXI

## The Decanates of ♃

Verily, thy consciousness of body  
Is my self-knowledge of form,  
And by that knowledge working in thee  
Do I maintain thine existence  
In all states of conditions.  
Behold, I dwell with thee, O Israel,  
And thou dwellest with me.  
Take heed  
That thou despise not thy Lord in human form.<sup>27</sup>

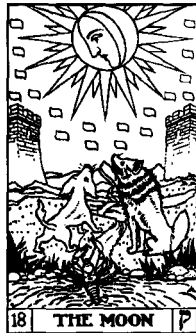

We now enter into the south below line. This is the final boundary line on the Cube of Space. As one traverses the twelve lines of the Cube, it will become evident that the order in which the lines are traveled may not be in the astrological order in which they have been presented in this work. The twelfth sign of the zodiac is, however, the final line to be traversed. This is for one important reason. There is no access to the south below line until the other lines have been traveled. Let us examine the diagram of the Cube so we can understand this point.



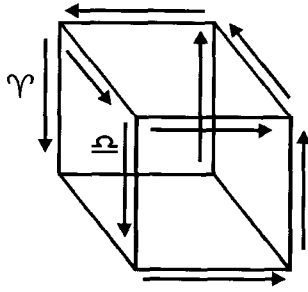

Figure 47.

As we look at the above face we can see that there are only two entry points to the below face. These points are either in the northeast or northwest above corners of  $\mathcal{V}$  and  $\underline{\Omega}$ . The above face goes around and around until there is a conscious choice to enter into the below face through one of these two points.

If one chooses to enter into  $\mathcal{V}$ , she or he can travel to the south by way of  $\mathfrak{N}$  and  $\mathfrak{S}$ . You must surface at the southeast corner of  $\mathfrak{I}$  and  $\mathfrak{O}$ . If you travel west by way of  $\mathfrak{A}$  and  $\mathfrak{M}$ , you must traverse the north and west boundary lines before you can access the south below line.

Although it appears that you can go directly from  $\mathfrak{S}$  to  $\mathfrak{K}$ , there are some intimations that suggest that you must first surface through the line of  $\mathfrak{M}$ , and integrate the experiences that have unfolded up to that point.

The major supporting idea around this theory is that alchemically the sign of  $\mathfrak{K}$  is attributed to the operation of **Multiplication**. This makes sense when we remember that the path of  $\mathfrak{P}$  on the Tree of Life is called the Corporeal Intelligence.

Multiplication is the final stage of the great work. It is the process whereby the alchemist affects the whole body with the stone. Thus the Corporeal Intelligence concerns the establishing of the perfected pattern through the entire body, much like leaven multiplies in the making of bread.

Traveling the entire cube is essential before the pattern can be known, imaged, and registered. This is why the traveler cannot enter into the south below line until all other lines have been faced.

The astrological rulers of the sign of  $\mathfrak{K}$  also give us intimation concerning the movement to a higher order of being.  $\mathfrak{L}$  and  $\mathfrak{P}$  co-rule  $\mathfrak{K}$ , and  $\mathfrak{Q}$  is exalted.  $\mathfrak{L}$  represents memory, both personal and cosmic.

Therefore the Corporeal Intelligence is the mechanism by which the memory of who we really are and where we came from is finally multiplied throughout the entire organism.

♁ is both the lower and higher mind. In the lower aspect, it registers confusion, glamour, distraction, and all manner of disorienting challenges. On the higher level it represents the Buddhic plane where true intuition and right action emerge, thus guiding the disciple in every thought, world, and deed.

The exaltation of ♀ in the sign of ♋ concerns the multiplication of the proper image within the entire organism. This has always been the crux of the Great Work. What is the correct image? How must this image be held in the mind's eye? To know this is to have the first matter. "♀ comes to her wooers in foul garments." Would we recognize her if we saw her?

Finally, ♁ is the axis that extends from the center to the east and to the west. It connects the past to the present, ♀ to ♋. ♁ brings to the disciple knowledge of the eternal now. One who has integrated the entire cube in all worlds is consciously one with his source.

The location of the decanates of ♋ extends from the below southwest to the below southeast corner, where it merges with the currents of ♋ and ♌. The following diagram shows their location.

### The Location of the Decanates of ♋

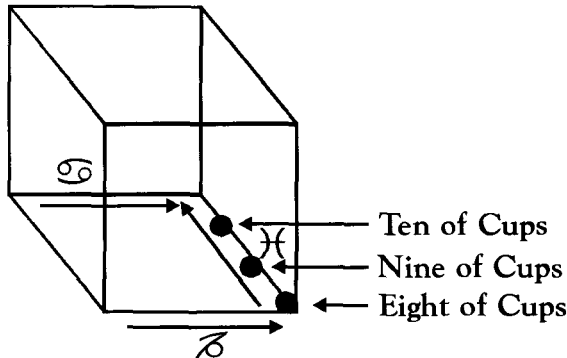
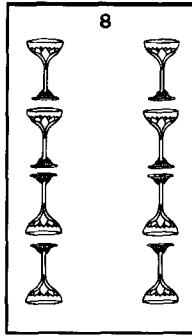

Figure 48.

## The Eight of Cups



The Eight of Cups is **הוֹד** in the World of **בְּרִיָּה**. This is the expression of the Sphere of Intellect, which is a Sphere of  $\nabla$  in the World of  $\nabla$ . This is often a paradox, for the intellect has often been associated with  $\Delta$ . A look at this descending influence form **גְּבוּרָה** to **הוֹד** should address the question well. The path of **נ**, the mother of  $\nabla$ , fills this lower Sphere of Intellect. Thus we can see that the path of **נ** is connected to the higher as well as the lower mind.

On a personal level, then, **הוֹד** in **בְּרִיָּה** is the activity of the intellect working on the plane of creative thought. This is the same as operating on the Buddhic plane.

Since **נ** is the direct connection from the personal to the Buddhic, we must learn to rely on the source of our image-making faculty.

*The Thirty-Two Paths of Wisdom* says this about the path of **נ**:

“The twenty-third path is called the stable intelligence. It is so called because it is the source of consistency among all the Sephiroth.”<sup>28</sup>

One of the greatest illusions we must overcome is that of personal separateness. The symbolism of the Eight of Cups will assist the student with his or her connection with the Stable Intelligence. Eventually the perfected image, which already exists on the plane of **בְּרִיָּה**, will be revealed to the disciple. This image, once focused upon, becomes multiplied throughout the physical body until it is the predominant force in our lives. We will then have a direct perception concerning the nature of our being.

The major keys that articulate the Eight of Cups are:

- Key 1 (The Magician), symbolic of the Sphere of **הוור**;
- Key 18 (The Moon), The sign of **⋈**;
- Key 10 (Wheel of Fortune), **♁**, co-ruler of **⋈**; and
- Key 12 (Hanged Man), **♄**, co-ruler of the sign of **⋈**.

The location of the Eight of Cups is on the south below line originating at the same point as the sign of **♍**. The difference between these two points is that the line of **♍** ascends to the above face, while the line of **⋈** travels from west to east by way of the south.

The arrangement of the eight cups on this minor key is symbolic of the reflection of Higher Consciousness into the creative waters that give the appearance of lower consciousness. Thus the arrangement is square with four cups upright, and their reflection: four cups appearing reversed.

The idea of reflection brings up the key word for Key 12 (Hanged Man): **REVERSAL**. In order to truly experience their source, disciples, who live within the reflection, must reverse their way of seeing things. Here are two quotes that speak to this idea of reflection and reversal:

“For when the surface of the waters  
Is disturbed by no slightest ripple of thought,  
Then shall the glory of my Self,  
Which is thy true Self,  
Be mirrored unto thee.”<sup>29</sup>

“Ripple on still waters  
When there is no pebble tossed  
Or wind to blow”<sup>30</sup>

The Eastern philosophies tell us that we must still the lake of *chitta*, or mind stuff. The means for accomplishing this is through practice in meditation. As we become successful in creating a still mind, we create the environment for *Bodhi Chitta*. This is the quality of mind that comes directly out of the Buddhist plane, or the World of **בריה**.

Since we are in the World of **בריה**, we are invoking the powers of the Archangel **רפאל**. The name means, “God the Healer”. True healing takes place for the individual when he or she lives as a conscious agent for the image-making faculty of the Divine Ego upon the Buddhist plane.

## Meditation on the Eight of Cups

קמך 4/4 in ♋

Place the Eight of Cups and the articulated major keys before you. After your regular attunement, chant the name רפאל, “God the Healer”. The notes are D, C, E, and F#.

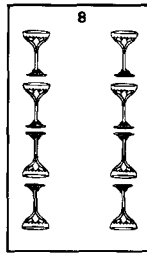

After looking at the keys for a few minutes each, chant the notes attributed to each key. The notes are E, B, A#, and G#. We want to focus our attention on bringing the Buddhic level of awareness to our personal consciousness. This is the work at hand for all disciples. Few have ever really had the true intuition to which this type of consciousness refers.

The time frame for the Eight of Cups is from 19 February to 28 February. The key word for this minor trump is **INSTABILITY**. The instability, remember, is the problem of the personality, not of the Soul. There is no instability for one who lives the life of reversal and relies on the Stable Intelligence.

## The Nine of Cups

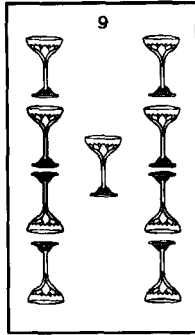

The Nine of Cups is **יסוד** in **בריה**. This is the Sphere of the  $\mathfrak{D}$ , and automatic consciousness. We are now in the second decanate of  $\mathfrak{H}$  where  $\mathfrak{E}$  and the  $\mathfrak{D}$  are rulers. Because the  $\mathfrak{D}$  rules the second decanate of  $\mathfrak{H}$ , in the Sphere of **יסוד** we find ourselves with a strong lunar influence.

The fact that the  $\mathfrak{D}$  has such a strong influence in this minor key has its positive and negative ramifications. In the short term this can cause what appears to be negative effects. This is because subconscious will deliver all our faulty suggestions right to our front door. This is accomplished with no attachment to the pain we may cause ourselves. On the positive side, we can turn the powers of subconsciousness over to the Solar Angel. This vast being is the distributor of the super-conscious level of awareness to the personality through the vessel of subconsciousness. If we surrender to the higher level of consciousness, we will find our entire world transformed.

**יסוד** in **בריה** is the basis for all our communications with the elder brothers and sisters who have traveled further ahead of us on the path. Because their knowledge, compared to ours, is super-conscious, they can transmit to us information concerning that which we are eager to know. We must however desire to know and to develop our abilities in meditation. Meditation is the means whereby we may become refined receiving stations for the broadcasts of those who know.

The major keys that articulate this minor key are:

- Key 2 (High Priestess), symbolic of the sphere יסוד;
- Key 18 (The Moon), the sign of ♀;
- Key 10 (Wheel of Fortune), ♃, co-ruler of ♀;
- Key 12 (Hanged Man), ♄, co-ruler of ♀;
- Key 7 (The Chariot), ☾, ruler of the second decanate of ♀; and
- Key 2 (High Priestess), the ♃, ruler of ☾.

The location of the Nine of Cups is just south of the Eight of Cups. This can be seen in the previous diagram.

The Archangel governing the Sphere of יסוד is גבריאל, meaning the “Strength of God”. This great angelic being was the one who announced to Mary that she was to become the mother of the Christ. So as the Sphere of יסוד is a reflection of תפארת, so also is יסוד the means of announcing or foretelling the birth of the anointed one within the head and heart of every disciple.

### Meditation on the Nine of Cups

קג – אד

The main idea behind this meditation is to visualize the automatic conscious mechanism as it truly is: a clear channel for super-conscious revelation. The intelligence for יסוד is called The Purified Intelligence. *The Thirty-two Paths of Wisdom* says,

“It is called this because it purifies the Sefirot. It tests the decree of their structure and the inner essence of their unity, making it glow. They are then unified without any cut-off or separation.”<sup>31</sup>

Place the Nine of Cups and the articulated major keys before you. After your usual attunement, chant the name גבריאל. The notes are, G<sup>#</sup>, E, D, F, E, and F<sup>#</sup>.

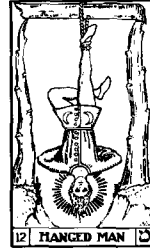
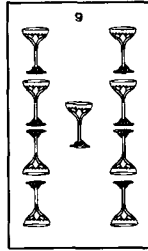

After focusing a few minutes on each key, chant the notes attributed to the keys. The notes are G<sup>#</sup>, B, A<sup>#</sup>, G<sup>#</sup>, G<sup>#</sup>, and D<sup>#</sup>.

The time frame for the Nine of Cups is 1 March to 10 March. The key word is **DESIRE FULFILLED**.



## The Ten of Cups

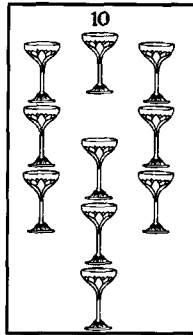

The Ten of Cups is **מלכות** in **בריה**. This is the relative crystallization of the powers of the above sephiroth into a creative image within the fruit of the Tree of **בריה**. We could easily say that each creative image we receive has gone through the process of descent. It is from **מלכות** in **בריה** that the creative images advance into **כתר** of **יצירה**. The formative world is where the electromagnetic patterns are established and later become physical realities. Within **בריה** they are already completed realities.

Perhaps our greatest difficulty along the path of return is our perception that the physical Sphere of **מלכות** is the one substantial reality. As we study the Minor Arcana, and in this case the Ten of Cups, we can come to understand the source of:

- Electromagnetic fields and
- The physical manifestation of any phenomenon.

We must also keep in mind that **מלכות** in **בריה** is not the ultimate cause, but a level of conscious awareness which we must attain before we can even begin to predicate what lies behind it. We already know that the World of **אצילות** is yet one world removed from **בריה**. At this point in human evolution we do not possess the equipment to register any real direct perception of its nature.

Much of the lower psychism that is prevalent in the New Age community can be understood through the symbolism of the Ten of Cups. Astrologically the Ten of Cups is ruled by  $\sigma$  in  $\mathfrak{M}$ . This creates a powerful level of receptivity when brought into alliance with  $\mathfrak{L}$  and  $\mathfrak{P}$ . With the expansive qualities of  $\mathfrak{L}$  and the miasmatic fog that is pro-

duced through faulty observations (♄), we find humanity constantly assailed with glamour and misinterpretation concerning its experience of day to day. If we orient ourselves toward the higher plane of mind, Buddhi or **בריה**, we cannot help but achieve a grater level of understanding of the nature of reality.

The major keys that articulate the Ten of Cups are:

- Key 21 (The World), ♃, symbolic of **מלכות**;
- Key 18 (The Moon), the sign of ♌;
- Key 10 (Wheel of Fortune), ♃, co-ruler of ♌;
- Key 12 (Hanged Man), ♄, co-ruler of ♌;
- Key 13 (Death), ♀, The ruler of the second decanate of ♌;
- Key 16 (The Tower), ♂, co-ruler of ♀; and
- Key 20 (Judgement), ♀, co-ruler of ♀.

The location of the Ten of Cups is east of the Nine of Cups on the south below line. This can be seen in the earlier diagram.

As the line of ♌ continues to flow to the east it joins up with the current of ♄. As these two lines converge, there is a collision of creative force. At this point there is nowhere to go but up through the line of ♃. Here we have the exchange of the exaltation of ♀ in ♌, and the rulership of the ♃ in ♄, being transformed into the ruling of ♀ and the exaltation of the ♃ in the sign of ♃. The images of **בריה** are brought to the surface where they are revealed to self-consciousness. They are later circulated on the above face where they begin to have practical meaning in the world of every day.

In the model of the Cube of Space we can see symbolically the revelation of the mysteries by The Hierophant. This is the revelation of Buddhi or the World of **בריה** to the conscious mind via the subconscious level.

The Archangel attributed to **מלכות** is **סנדלפון**. This great Being represents the receptive feminine aspect of God. It is the receptive aspect that is the basis for manifestation. In this particular context it is the manifestation of a clear specific creative image.

## Meditation on the Ten of Cups

קשפ ♂♀ in ✕

Place the Ten of Cups before you along with the articulated major keys. After the usual attunement, chant the name of the Archangel of מלכות, which is סנרלפון. The notes for this name are G<sup>#</sup>, G, F<sup>#</sup>, F<sup>#</sup>, C, C<sup>#</sup>, and G.

After spending a few moments with each key, chant the notes of attribution. These notes are A, B, A<sup>#</sup>, G<sup>#</sup>, G, C, and C.

Liberation and enlightenment are only possible if we consistently work at them. We have all made progress to some degree. The degree of progress that marks the end of our days will be great or small according to our efforts. No one can do it for us.

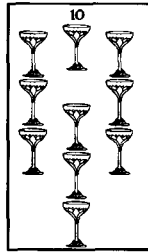

The time frame for the Ten of Cups is from 11 March to 20 March. The key word is **EXCESS**. This excess can be measured by overindulgence of the personality in the distractions of the material plane, or the lack of limitation in our creative process. On a soul level it can represent the full grip of the Soul upon the personality.

This completes the section of the movement of the Minor Arcana around the boundaries of the Cube. There are many more meditations we could examine here. See what you can come up with through your own meditations.

### Conclusion for Now

Once again it is time to invoke the powers of limitation and bring this portion of our work to a close. We have gone over many of the different areas of the Cube of Space and its relationship to the Tree of Life. We have examined the Cube from its inception in the mind of איהי. We have seen how the different cardinal points create points of tension between the above and below and their opposite point. We have explored the polarity that exists between the zodiacal signs and the flow of the final letters as they carry the intelligence from the center to the above. Finally, we have explored the movement of the currents through the decanates of the zodiacal wheel.

As I ponder the possibilities of the Cube, I become overwhelmed. There are many other ways in which one can approach the Cube and gain a deeper understanding of our inner nature, the nature of our solar system, and the greater Being in whom we all live.

There is much that has not been dealt with, such as the court cards and the aces. There are also the twenty-seven cubic units which when addressed will open even more possibilities for growth. Some time in the future there will be another work dealing with these and other topics. Dr. Case has said that there is no exhausting the study of the Tarot. He was so right.

I hope you have found these meditations as useful as I have. I look forward to any feedback that may come my way from the many disciples who tread the Path of Return.

In L.V.X.

Kevin Townley



## Footnotes

- 1 *The Book of Tokens*, Paul Foster Case.
- 2 *Treatise on Cosmic Fire*, Alice Bailey p. 198
- 3 *Tree of Life*, Paul Foster Case.
- 4 Meditation on Yod: *The Book of Tokens*, Paul Foster Case
- 5 *The Book of Tokens*, Paul Foster Case
- 6 *The Great Work*, Lesson 45, Dr. Paul foster Case
- 7 *Sepher Yetzirah*, *The Book of Creation*, In theory and Practice, Aryeh Kaplan
- 8 *The Book of Tokens*, Dr. Paul Foster Case.
- 9 *Treatise On White Magic*, Alice Bailey
- 10 *Treatise on White Magic*, Alice Bailey
- 11 *The Sepher Yetzirah*, *The Book of Creation*. In Theory and Practice, Aryeh Kaplan
- 12 *The Book of Tokens*, Paul Foster Case.
- 13 Ripple, Gerri Garcia, the Grateful Dead
- 14 *Sepher Yetzirah*, In Theory and Practice, Aryeh Kaplan.
- 15 *The Book of Tokens* Dr. Paul Foster Case
- 16 *Sepher Yetzirah*, 1:13. Translated Aryeh Kaplan
- 17 *Highlights of Tarot*, Dr. Paul Foster Case
- 18 The idea of this chart has been taken from several sources. They include, *Highlights of Tarot*, by Dr. Paul Foster Case, *A Practical Guide to Qabalistic Symbolism*, by Gareth Knight, *The Mystical Qabalah* by Dione Fortune, and *The Qabalistic Tarot*, by Robert Wang.
- 19 *The Great Work*, Dr. Paul Foster Case.
- 20 SC, Dr. Paul Foster Case.
- 21 *Sacred Geometry*, Robert Lawlor
- 22 The format for this meditations was inspired Dr. Ann Davies.
- 23 SC, Dr. Paul Foster Case.
- 24 The seven versions considered can be found in *The Sepher Yetzirah*, *In Theory and Practice*, by Aryeh Kaplen
- 25 *The Philosophers of Nature*, on Qabalah
- 26 *The Book of Tokens*, Paul Foster Case
- 27 *The Book of Tokens*, Paul Foster Case.

28. Case, Paul Foster. *The Book of Tokens*, (*The Book of Tokens*, Los Angeles Builders of the Adytum, 1978, p. 123.
29. Ripple, *The Grateful Dead*.
30. ????
31. Kaplan, Aryeh. *The Sepher Yetzirah*, York Beach, ME: Weiser, 1991, p. 297.

# Glossary of Symbols

Zodiacal	Alchemical	Tarot	Hebrew Letter
♈ Aries	Calcination	The Emperor	ה
♉ Taurus	Congelation	The Hierophant	ו
♊ Gemini	Fixation	The Lovers	ז
♋ Cancer	Separation	The Chariot	ח
♌ Leo	Digestion	Strength	ט
♍ Virgo	Distillation	The Hermit	י
♎ Libra	Sublimation	Justice	ל
♏ Scorpio	Putrefaction	Death	ן - נ
♐ Sagittarius	Incineration	Temperance	ס
♑ Capricorn	Fermentation	The Devil	ע
♒ Aquarius	Dissolution	The Star	ץ - צ
♓ Pisces	Multiplication	The Moon	ק

Planetary	Alchemical	Tarot	Hebrew Letter
☉ Sun	Gold	The Sun	ך
☾ Moon	Silver	High Priestess	ג
☿ Mercury	Mercury	The Magician	ד
♀ Venus	Copper	The Empress	ד
♂ Mars	Iron	The Tower	ף - ת
♃ Jupiter	Tin	Wheel of Fortune	ך - נ
♄ Saturn	Led	The World	ת
♅ Uranus	Air-Uranium	The Fool	א
♆ Neptune	Water	Hanged Man	ם - מ
♇ Pluto	Fire-Plutonium	Judgement	ש

Elemental	Element	World	Tetragrammaton
△	Fire	Atziluth - אצילות	י
▽	Water	Briah - בריה	ה
△	Air	Yetzirah - יצירה	ו
▽	Earth	Assiah - עשיה	ה



Mother Letter	Principle	Tarot Key	Tattwa	Element
א	♀	Key 0	Akasha Vayu	△
ב	♁	Key 20	Akasha Tejas	△
ג	♁	Key 12	Akasha Apas	▽

### Glossary of Hebrew

א	Aleph	‘	Ox	1
ב	Beth	b (v)	House	2
ג	Gimel	g (g)	Camel	3
ד	Daleth	d (dh)	Door	4
ה	Heh	h	Window	5
ו	Vau	w	Nail or Hook	6
ז	Zain	z	Sword	7
ח	Cheth	h	Fence	8
ט	Teth	t	Serpent	9
י	Yod	y	Hand (open)	10
כ	Kaph	k (kh)	Hand (closed)	20
ל	Lamed	l	Ox Goad	30
מ	Mem	m	Water	40
נ	Nun	n	Fish	50
ס	Samekh	s	Prop	60
ע	Ayin	‘	Eye	70
פ	Peh	p (ph)	Mouth	80
צ	Tzaddi	s	Fishhook	90
ק	Qoph	q	Back of Head	100
ר	Resh	r	Head	200
ש	Shin	sh	Tooth	300
ת	Tau	t (th)	Mark (Tau)	400

# Glossary of Hebrew Terms

## Four Worlds

אצילות	Atziluth - World of fire, abstract ideas and archetypes - Atmic
בריאה	Briah – World of water, creative ideas - Buddhic
יצירה	Yetzirah – World of air, Mind and electromagnetic fields - Mannasic
עשיה	Assiah – World of earth and material manifestation - form

## Spheres on the Tree of Life

אין	Nothing, first negative veil on the tree of Life.
כתר	Crown, first sphere on the Tree
חכמה	Wisdom, second sphere
בינה	Understanding third sphere
חסד	Mercy, fourth sphere
גבורה	Severity, fifth sphere
תפארת	Beauty, sixth sphere
נסח	Victory, seventh sphere
הוד	Splendor, eighth sphere
יסוד	Foundation, ninth sphere
מלכות	Kingdom, tenth sphere

## Divine Names

אהיה	Ey-heh-yeh-heh, name attributed to the Crown
יהוה	Yod-heh-vav-heh, Divine name attributed to Wisdom
אלהים	Eloheim, Divine name attributed to Understanding
אל	El, Divine name attributed to Mercy
אלהים גבור	Elohim Gebor, Divine name attributed to Severity
יהוה אלוה ודעת	Yod-heh-vav-heh-va-daath, Divine name attributed to Beauty
יהוה צבות	Yo-heh-vav-heh Tabaoath
אלהפם צבות	Elohim Tzabaoath, Divine name attributed to Splendor
שרי אלחי	Shaddi El Chai, Divine name for the Foundation.
אדני ה ארץ	Adonai Ha Eretz

### Archangelic Names

מטטרון	Metatron
רזיאל	Raziel
צפקיאל	Tzaphqiel
צדקיאל	Tzadqiel
כמאל	Kamael
מיכאל	Michael
אוריאל	Auriel
רפאל	Raphael
גבריאל	Gabriel
סנדלפון	Sandalphon

### Choir of Angles

חיות הפרש	Chayoth ha Qadesh	Crown	Kether
אופני	Auphanim	Wisdom	Chockmah
אראלים	Aralim	Understanding	Binah
השמלים	Chashmalim	Mercy	Chessed
שרפים	Seraphim	Severity	Geburah
מלכים	Melekim	Beauty	Tiphareth
אלהים	Elohim	Victory	Netzach
בני אלהים	Beni Elohim	Splendor	Hod
כרובים	Kerubim	Foundation	Yesod
אשים	Ashhim	Kingdom	Malkuth

### Planetary Names

ראשית הגלגלים	Beginning of the Whirlings
מסלות	Sphere of the Zodiac
שבתאי	Saturn
צפך	Jupiter
מאפים	Mars
שמש	Sun
נוגה	Venus
כוכב	Mercury
לבנה	Moon
גוף	Earth of Body

## Other Words

לובן	To set boundaries
יחידה	Central Self
נשמה	Divine Soul
דניאל	Daniel
תהו ובהו	Formless and void
חת	Field or fence.
מזלה	Holy Influence
יהוה	Jesus, Joseph, Joshua
מלך	King
רוח	Life Breath
חיה	Life Force
דין	Justice
אם	Mother
תם	Perfection wholeness Completion
מאדאם	Powers of vehement Strength
מתנוצץ	Resplendent
קדוש	Sanctified
מים	Water, Seas, Days
איל	Strength
זין	Seventeenth path on the Tree of Life



# Bibliography

- Achad, Frater, *The Anatomy of the Body of God*, New York: Weiser, 1969.
- Achad, Frater, Q.B.L. *The Bride's Reception*, New York: Samuel Weiser, 1969.
- Achad, Frater, *The Egyptian Revival*, New York: Samuel Weiser, 1973.
- Albertus, Frater, *The Alchemist's Handbook*, York Beach, Maine: Samuel Weiser, 1981.
- Anonymous, *Meditations on the Tarot*, New York: Amity House, 1985.
- Anonymous, *Praxis Spagyrica Pholosophica*, Salt Lake City: Paracelsus Research Society, 1966.
- Baily, Alice, *Esoteric Astrology*, New York: Lucis Publishing Co., 1951.
- Baily, Alice, *Discipleship in The New Age*, New York: Lucis Publishing Co. 1954.
- Baily, Alice, *Initiation Human and Solar*, New York: Lucis Publishing Co., 1922.
- Baily, Alice, *Esoteric Psychology Vol. I*, New York: Lucis Publishing Co., 1936.
- Baily, Alice, *Esoteric Psychology Vol. II*, New York: Lucis Publishing Co., 1942.
- Baily, Alice, *A Treatise on Cosmic Fire*, New York: Lucis Publishing Co., 1951.
- Blavatsky, H.P., *The Secret Doctrine*, Pasadena, California: Theosophical University Press, 1977.
- Beamen, Jacob, *The Three Principles of Divine Essence*, Chicago, Ill, Yogi Publication Society, 1909.
- Case, Paul Foster, *The Book of Tokens*, Los Angeles, Ca.: Builders of the Adytum, 1934.
- Case, Paul Foster, *The Tarot*, Richmond, Va.: Macoy Publishing Co. 1947.
- Case, Paul Foster, *The True and Invisible Rosicrucian Order*, New York, New York: Samuel Weiser, 1985.
- Cirlot, J.E., *A Dictionary of Symbols*. New York: Philosophical Library, 1974.
- Crowley, Aleister, *777*, York Beach: Samuel Weiser, 1973.
- Crowley, Aleister, *The Book of Thoth*, York Beach, Maine: Samuel Weiser, 1969.
- Fourtune, Dion, *The Mystical Qabalah*, London: The Society of Inner Light, 1957.
- Godwin, David, *Godwins Cabalistic Encyclopedia*, York Beach, Maine: Samuel Weiser. 1979
- Gray, William, *The Ladder of Lights*, Maine: Samuel Weiser, 1968.
- Gray, William, *Western Inner Workings*, Maine: Samuel Weiser, 1983.
- Green, Liz, *Saturn*, York Beach, Maine: Samuel Weiser, 1976.
- Hall, Manly Palmer, *Masonic Orders of Fraternity*, Los Angeles Ca.: Philosophical Research Soociety, In., 1950.
- Hall, Manley Palmer, *The Secret Teachings Of All Ages*, Los Angeles, Ca.: The Philosophical Reaearch Society, In., 1972
- Hillman, James, *Archtypal Psychology*, Dallas: Spring Publications, 1983.
- Hoeller, Stephan, A. *The Royal Road*, Wheaton, Ill.: The Theosophical Publishing House, 1975.

- Junius, Manfred M., *Prataical Handbook of Plant Alchaemy*, New York: Inner Traditions, 1979.
- Jung, Carl, *Archetypes and The Collective Unconscious*, Princeton: Princeton University Press, 1968.
- Kaplan Aryeh, *Meditation and The Bible*, New York: Samuel Weiser, 1978.
- Kaplan, Aryeh, *Meditation and The Kabbalah*, New York: Samuel Weiser, 1982.
- Kaplan, Stuart, R. *The Tarot, Vol. 1 and 2*, New York: U.S. Games Inc. 1978-1988.
- Knight, Gareth, *The Pratical Guide to Qabalistic Symbolism*, York Beach, Maine: Samuel Weisner, 1983.
- Lawlor, Robert, *Sacred Geometry*, New York: Crossroad, 1982.
- Leadbeater, C.W., *The Hidden Life In Freemasonry*, India: The Theosophical Publishing House, 1926.
- Levi, Eliphas, *The Book of Splendors*, New York: Samuel Weiser, 1973.
- Levi, Eliphas, *The Great Secret*, Wellingborough, Northamptonshire: The Aquarian Press, 1975.
- Levi, Eliphas, *The History of Magic*, New York, New York: Samuel Weisner, 1969.
- Levi, Eliphas, *Transcendental Magic*, London: Rider, 1984.
- Mackey, Albert G., *Encyclopaedia of Freemasonry*, New York: The Masonic History Company, 1925.
- Magnus, Alabertus, *The Book of Secrets*, London: Oxford University Press, 1973.
- Mathews, John and Caitlin, *The Western Way*, vol 1, and 2, London: 1986.
- The Nag Hammadi Library*, New York: Harper and Row, 1977.
- Nichols, Sallie, *Jung and The Tarot*, York Beach, Maine: Samuel Weisner, 1980.
- Oken, Alan, *Soul-Centered Astrology*, New York: Bantam, 1990.
- Pagels, Elaine, *The Gnostic Gospels*, New York: Random House, 1979.
- Ponce, Charles, *Kabalah*, London: Quest Books, 1973.
- Ragoczy, Comte De St. Germain, *La Tres Sainte Trinopophie*, Los Angeles, Ca: Philosophical Research Society, 1983.
- Regardie, Israel, *The Goldern Dawn*, St. Paul, Minnesota: 1982.
- Regardie, Israel, *The Tree of Life*, New York: Samuel Weiser, 1971.
- Robbins, Michael D. *Tapetry of The Gods*, Vol. 1 and 2, Jersey City Heights, New Jersey: The University of the Seven Rays Publishing House, 1990.
- Rudolph, Kurt, *Gnosis*, San Francisco: Harper and Roe, 1977.
- Rudhyar, Dane, *The Astrological Houses*, Garden City New York: Doubleday, 1972.
- Saraydarian, Torkom, *Symphony of the Zodiac*, Sedona, Arizona: Aquarian Educational Group, 1988.
- Soares, Carlos, *The CIPHER of Genesis*, Boulder: Shambhala, 1978.
- Three Initiates, *The Kybalion*, Chicago, Ill.: Yogi Publishing Co., 1940
- Scholem, Gershom, *Kabalah*, New Your: New American Library, 1974.
- The Sepher Yetzirah*, Translated by Kaplan, Aryeh, York Beach, Maine: Samuel Weiser, 1990.
- The Sepher Yetzirah*, Translated by, Soares, Carlos, Boulder, Co.: Shambala, 1976.

- The Sepher Yetzirah*, Translated by Westcott, W. Wynn, New York: Samuel Weiser, 1980.
- Waite, Arthur, Edward, *The Brotherhood of the Rosy Cross*, New York: University Press.
- Waite, Arthur Edward, *The Hermetic Museum*, New York: Samuel Weiser, 1973.
- Waite, Arthur, Edward, *A New Encycopaedia of Freemasonry, Vol. 1, and 2*. New York: Weathervane Books, 1960.
- Waite, Athur Edward, *The Illustrated Key to the Tarot*, Chicago, Ill.: de Laurence Company, 1918.
- Waite, Arthur Edward, *The Turba Pholosophorum*, New York: Samuel Weiser, 1973.
- Wang, Robert, *The Qabalistic Tarot*, York Beach, Maine: Samuel Weiser, 1983.
- The Zohar*, New York: Rebecca Bennet Publications.





## About the Author

Kevin Townley was born in Middletown, NY in 1952. He entered the Carmelite Seminary in his early teens to study for the Catholic priesthood. After leaving the seminary he began a lifelong study of the ancient Universal Wisdom as taught by the various world traditions which include astrology, alchemy, magic, Tarot and a host of other subjects.

After completing the study course with the Builders of the Adytum (BOTA), he began his study in Masonry, which has remained the primary focus in his life.

Kevin has studied and lectured in Europe, Asia and all over the United States. He presently lives in Boulder, Colorado where he continues his studies and teaching of the Ageless Universal Wisdom.

### About the Type

This book was typeset in Gilde, a popular version of Goudy Old Style, designed in 1915 by Frederic W. Goudy, his twenty-fifth typeface, and his first for American Type Founders. Its recognizable features include the diamond-shaped dots on i, j, and on punctuation marks; the upturned ear of the g; and the base of E and L. Flexible enough for both text and display, it's one of the most popular typefaces ever produced.

Book design and typesetting by JTC Imagineering, Santa Maria, CA.